



HAL
open science

Definition and specification of "CANlike" protocols in the context of wireless networks

Guy Juanole, Gérard Mouney

► **To cite this version:**

Guy Juanole, Gérard Mouney. Definition and specification of "CANlike" protocols in the context of wireless networks . [Research Report] LAAS/CNRS. 2015. hal-01174850

HAL Id: hal-01174850

<https://hal.science/hal-01174850>

Submitted on 10 Jul 2015

HAL is a multi-disciplinary open access archive for the deposit and dissemination of scientific research documents, whether they are published or not. The documents may come from teaching and research institutions in France or abroad, or from public or private research centers.

L'archive ouverte pluridisciplinaire **HAL**, est destinée au dépôt et à la diffusion de documents scientifiques de niveau recherche, publiés ou non, émanant des établissements d'enseignement et de recherche français ou étrangers, des laboratoires publics ou privés.

Definition and specification of « CANlike » protocols in the context of wireless networks

Guy Juanole^{1,2}, Gérard Mouney^{1,2}

¹CNRS, LAAS, 7 avenue du Colonel Roche, F-31400, Toulouse, France

²Univ de Toulouse, UPS, INSA, INP, ISAE, LAAS, F-31400 Toulouse, France
juanole@laas.fr, mouney@laas.fr

Abstract

The implementation of distributed real-time applications on wireless networks constitute today a new important challenge and, in this context, the MAC protocols, which implement the frame exchange scheduling, have an essential role. This paper is precisely concerned by the specification of such MAC protocols. We specify MAC protocols called CANlike protocols because they are inspired by the MAC protocol of the network CAN which is a wired network. The presentation made in this paper, after a reminder of basic knowledges (wireless network physical layer, different topologies, CAN wired network, MAC protocol characteristics) shows how to integrate these basic knowledges in order to specify the CANlike protocols for several topologies (mono-hop topology and three different multi-hop topologies(chains)). In the conclusion too, we prove (by considering a mono-hop topology) the interest of the CANlike protocols for implementing applications in networked control systems (by comparison with the WiFi-DCF protocol).

1 Introduction

Wireless networks and more particularly Wireless Local Area Networks (WLANs) are more and more used today in the industrial area where we have real-time distributed applications which require Quality of Service (QoS) guarantees for their communications. In this context, the MAC protocols, which implement the frame scheduling, have an essential role. WLANs can be either mono-channel or multi-channel. Here we consider the mono-channel case.

In the context of the wireless networks, the protocols of the CSMA (Carrier Sense Multiple Access) type and, particularly, with the attribute CA (Collision Avoidance) [1] are very often considered and used. The attribute CA is based on a Backoff procedure which allows, in comparison to the strict CSMA type, to reduce the collision occurrence but not to eliminate this occurrence and then we cannot give QoS guarantees for the frame transfer.

Mastering the collisions and giving QoS guarantees is possible by associating priorities to the frames of the flows (the role of the priorities is to allow to implement a Collision Resolution (CR) mechanism *i.e.* to transform what would be a “collision situation” with a CSMA type protocol into a “winner-looser(s) situation” which results from a tournament based on the priorities comparison; the winner is the frame which has the highest priority). The first approach is to use the BlackBurst technique [2]. The idea is to let the contending nodes send first jamming signals (called BlackBurst (BB) messages) of length according to the priority. The node which has the longest jamming signal (*i.e.* the highest priority) wins the competition and then sends its frame. The drawback of this technique is that, if we have a great priority number, the jamming signals will be very long and give important delays [3]. The second approach is to adapt the MAC protocol of the wired CAN bus (the priority of the frame is expressed by the ID field which

precedes the data field) to the wireless context. It is this second approach that we consider in this paper (concept of CANlike protocol).

This paper includes three parts:

- the first part presents basic knowledges,
- the second part concerns mainly the specification of the main parameters of the CANlike protocols for different wireless network topologies; it presents also solutions for a problem which occurs in a chain topology and which is called the intraflow problem (concurrent frame transfer in a frame flow going from a source node to a destination node).
- the third part is a conclusion.

2 Preliminaries: Basic knowledges

Three types of basic knowledges are necessary. The type 1 concerns the characteristics of the wireless networks physical layer and some important consequences for the MAC layer with a protocol of the CSMA type (pure CSMA or CSMA-CA). The type 2 concerns different node interconnection structures (*i.e* different topologies) in a wireless context. The type 3 concerns the principles that underlie the CAN-like protocols for the different topologies which have been considered.

2.1 Type 1 of the basic knowledges

2.1.1 The wireless transceiver

In a wireless context (contrarily to the wired context), a transceiver cannot simultaneously send and receive on a channel and has three states: transmitter, receiver, sleeper. Here we do not consider the state “sleeper” which is used for considerations of energy economy.

Two time attributes characterize the transceiver behavior: the channel Sensing Time τ_{ST} and the Turnaround Time τ_{TT} . τ_{ST} allows the transceiver (in the receiver state) to test the channel state (busy or idle) depending on whether the detected Energy on τ_{ST} is higher or lower than a prefixed threshold (noted $Ethr$). τ_{TT} is the time to go from the receiver (transmitter) state to the transmitter (receiver) state.

If the channel is detected idle, the transceiver can go (after a τ_{TT}) in the transmitter state which allows the MAC entity to send a frame. After a frame transmission, the receiver can (after τ_{TT}) come back to the receiver state.

Relatively to a frame transmission (by considering frames where all the bits uses the same code, and then have, from the power point of view, identical transmission constraints), the channel is defined by means of two parameters (bandwidth, signal reducing) and then the transmission of a node is characterized, in term of the signal reducing (with respect to the power of the signal of the emitted frame) by two ranges: Carrier Sense Range (R_{CS}) and Transmission Range (R_T).

2.1.2 Carrier Sense Range (R_{CS})

The R_{CS} , which is associated to a node i (noted $R_{CS}(i)$), is represented by a circle of center i and of radius noted $r_{CS}(i)$. The radius $r_{CS}(i)$ is the maximal range in which the sending of a frame by the node i induces for all node j being in the circle, the detection of a signal, the Power of which is higher than or equal to a threshold noted $P(R_{CS}(i))thr$ (the product of $P(R_{CS}(i))thr$ by τ_{ST} gives the threshold $Ethr$, *i.e* the limit of the detection of a busy channel state after a frame transmission by the node i). Note that, the fact that a node j , in the circle $R_{CS}(i)$, detects a signal resulting from the sending of a frame by the node i , does not mean necessarily that the

node j is able to decode this frame (that depends on the distance d_{ij}). This remark justifies the necessity to introduce the concept of Transmission Range (R_T).

The definition of the $R_{CS}(i)$ requires still to precise the following points:

1. the node i is called “exposed node” to all the nodes j which are in the $R_{CS}(i)$ (because the transmission of a frame by the node i induces the busy channel state which prevents all the nodes j to use the channel during this transmission duration),
2. the nodes j are the nodes which, in the framework of the $R_{CS}(i)$, are in competition with the node i for the sending of a frame. More precisely:
 - if one node j starts a transmission just before an attempt of the node i , this induces, for the node i , the situation “busy channel” which delays its possibility of transmission,
 - if one node j and the node i transmits simultaneously, this induces a situation “emission collision”.

We have to note that these two situations are normal situations by definition of the strict context CSMA. We describe, relatively to the node i , these two situations as “endogenous interferences” because they result from actions of the nodes j which are in the $R_{CS}(i)$.

3. nodes can be outside the $R_{CS}(i)$. Among these nodes, some of them can have their R_{CS} which have an intersection with $R_{CS}(i)$. Call k such a node and $R_{CS}(k)$ its Carrier Sense Range, and rename jj' the nodes j which are at the intersection of $R_{CS}(i)$ and $R_{CS}(k)$. The nodes jj' can hear the attempts of the transmission of the nodes i and k which can then create, in these nodes jj' , interference situations that we call “exogenous interferences” (because resulting of actions of the nodes i and k , which are not in the same Carrier Sense Range). This characteristic will help us to present the hidden node problem.

2.1.3 Transmission Range (R_T)

Consider again a node i and its associated $R_{CS}(i)$. The R_T , which is also associated to the node i (noted $R_T(i)$), is represented by a circle of centre i and of radius r_T , noted $r_T(i)$. The radius $r_T(i)$ is the maximal range in which the sending of a frame by the node i sets, for all nodes j being in the circle, the detection of a signal, the power of which is higher than or equal to the power necessary to decode the frame sent by the node i *i.e.* a power higher than or equal to a threshold noted $P(R_T(i)thr)$. Obviously $P(R_T(i)thr) > P(R_{CS}(i)thr)$.

Remark: In practice, generally, we have $r_{CS}(i) > r_T(i)$ which can still be expressed $R_{CS}(i) > R_T(i)$. However, we can also consider a particular case which can be expressed $P(R_T(i)thr) = P(R_{CS}(i)thr)$ and then $R_{CS}(i) = R_T(i)$ (*i.e.* any node in the Carrier Sense Range of the node i can decode the signal of the frame sent by the node i). In short, we can say $R_{CS}(i) \geq R_T(i)$.

2.1.4 Transmission hop

A transmission hop is the basic element of a communication path between computers *i.e.* it represents, in the framework of an implementation, the distance (noted d) between a node, transmitter of a frame, and the next node, in the path, which receives directly and decode this frame. We have : $d \leq r_T < 2d$ *i.e.* we can have a path of one hop in R_T and obviously more in R_{CS} when $r_{CS} \geq 2d$.

2.1.5 Hidden node

a) Consider again the presentation in the subsection 2.1.2 and consider the case of a transmission of a frame in one hop from the node i to a node jj' (then this frame will be well received and

well decoded in the node jj' if there is no kind of interference). A node hidden to the node i is a node k [4], [5], because the node k is a node exposed to the node jj' (*i.e.* the node jj' is in the $R_{CS}(k)$), which can lead, relatively to an attempt of a frame transfer by the node i , to two “exogenous interference situations” in the reception activity of the node jj' :

- situation 1: a situation called “busy channel” resulting from the sending of a frame by the node k before the sending attempt by the node i (but this one cannot see the state of the channel as the node k is not in its R_{CS}); the result will be the non consideration, by the node jj' , of the frame coming from the node i (then its loss),
- situation 2: a situation called “collision in reception” which results from a simultaneous sending of a frame by the nodes i and k , which can lead, on the frame sent by the node i , to the decoding impossibility by the node jj' .

The occurrence of the situation 2 depends, at the node jj' , on the ratio Signal Power of the frame coming from the node i (call P_i this power) on Signal Power of the frame coming from the node k (call P_k this power). By calling d the length of the hop i, jj' and l the distance k, jj' we have: $\frac{P_i}{P_k} = (\frac{l}{d})^4$. The condition for a correct decoding of the frame sent by the node i is $\frac{P_i}{P_k} \geq 10$ [6], which defines the limit value of l called “Interference Range” et noted R_I . We have $R_I = 1.78d$.

b) We can now give the quantitative conditions [6] which express the behaviour of a node k hidden to the node i . As it is a node outside the $R_{CS}(i)$, we have $d + l > r_{CS}(i)$.

- If $l \leq 1.78d$, we can have the situations 1 and 2,
- If $l > 1.78d$, we can only have the situation 1. The situation 1 can always happen because the node jj' is in the $R_{CS}(k)$.

2.2 Type 2 of the basic knowledges

We consider topologies where always the frames, exchanged between all the nodes, use for all their bits the same code (*i.e.* all the bits have, from the power point of view, identical transmission constraints) and then the transmission of all the nodes are characterized by the values R_{CS} , R_T and d . This situation is the case of the protocols of the CSMA type (pure CSMA or CSMA-CA). We can have either topologies, called mono-hop topologies, or topologies called multi-hop topologies (important examples are the chains that we only consider here).

2.2.1 Mono-hop topologies

Mono-hop topologies are topologies where each node can communicate directly (one hop) with all the other nodes. In such a topology, all the nodes are in the intersection of their range R_T (and obviously too of their range R_{CS} as $R_{CS} \geq R_T$; here we take $R_{CS} = R_T$). So we have not the hidden node problem. This defines full-meshed topologies. On the figure 1 we represent an example of such a topology which is made up of 4 nodes 1, 2, 3, 4 where each node is the center of a circle of radius equal to r_T .

In this topology, we can only have “endogenous interferences”.

2.2.2 Chains (Multi-hop topologies)

Note that, for drawing size reasons, we only represent the R_{CS} ranges and, furthermore, their circles are represented by ellipses.

We consider nodes where the radius of the range R_{CS} can include at the most h hops ($h \geq 1$). We define three types of chains. The first one with $h > 1$ (noted chain-1) is a chain where

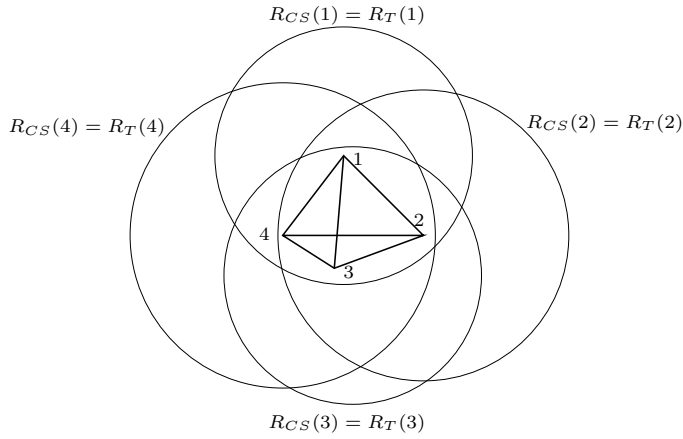

Figure 1: Mono-hop topology (full meshed topology)

all the nodes are in the intersection of their range R_{CS} and then we have not still the hidden node problem (because none node is outside the ranges R_{CS} of the other nodes). We only have “endogenous interferences”. On the figure 2, we represent an example of such a topology (chain of 3 hops) which is made up of 4 nodes 1, 2, 3, 4 where the radius of the ranges R_{CS} of the nodes include at the maximum 3 hops ($h = 3$). Obviously $R_T(i) < R_{CS}(i)$.

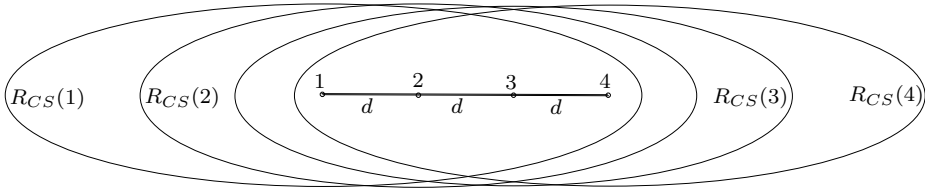

Figure 2: chain-1 (4 nodes, 3 hops)

The two other types (noted chain-2 and chain-3) have the hidden node problem because nodes are outside the range R_{CS} of other nodes. We distinguish two cases according to the value of h : $h = 1$ characterizes a chain noted chain-2 where we consider $R_T = R_{CS}$; $h > 1$ characterizes a chain noted chain-3 where obviously $R_T < R_{CS}$.

We represent, on the figures 3 and 4, respectively an example of the chain-2 and an example of the chain-3 with $h = 2$ (the two chains have 7 nodes numbered from 1 to 7). We did not draw the R_{CS} of all the nodes for reasons of figure clarity.

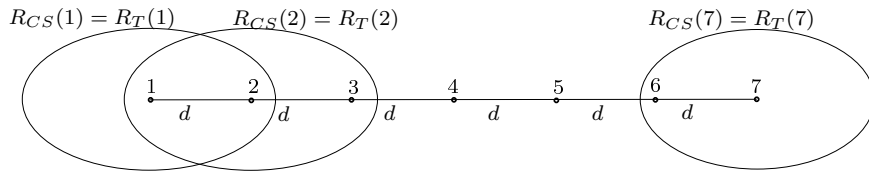

Figure 3: chain-2

We can easily see

- on the figure 3, the nodes $(i + 2)$ are the hidden nodes of the nodes i ($i \in [1, 5]$) and the nodes $(i - 2)$ are also the hidden nodes of the nodes i ($i \in [3, 7]$),
- on the figure 4, the nodes $(i + 3)$ are the hidden nodes of the nodes i ($i \in [1, 4]$) and the nodes $(i - 3)$ are also the hidden nodes of the nodes i ($i \in [4, 7]$).

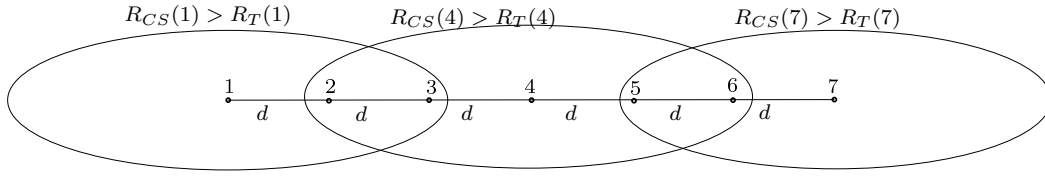

Figure 4: chain-3

It is important to note the difference in the role of the hidden node depending on whether we have a chain-2 or a chain-3 (see 2.1.5)

- chain-2 : as the hidden node $i + 2$ (or $i - 2$) of a node i is at the distance d (*i.e.* $< 1.78d$) of the node $i + 1$ (or $i - 1$), we can have the two situations 1 and 2 of the exogenous interferences,
- chain-3 : as the hidden node $i + 3$ (or $i - 3$) of a node i is at the distance $2d$ (*i.e.* $> 1.78d$) of the node $i + 1$ (or $i - 1$), we only have the situation 1 of the exogenous interferences.

We can now extrapolate from this observation the general case where we consider a radius of R_{CS} including h hops: the nodes $(i + (h + 1))$ and $(i - (h + 1))$ are the hidden nodes for the nodes i (an hidden node to a node i is the first node outside the R_{CS} associated to the node i).

2.2.3 Concept of topology classes

By looking at the consequences of the transmission of a frame by a node i , we can distinguish two topologies classes:

- the class 1 (mono-hop and chain-1), which represents one broadcast domain, *i.e.* the transmission of a frame generates a signal which is “heard” by all the other nodes (because all the nodes are in the intersection of their R_{CS} ranges),
- the class 2 (chain-2 and chain-3), which represents multiple broadcast domains, *i.e.* the transmission of a frame generates a signal which is only “heard” by the other nodes which are in the range $R_{CS}(i)$; all the nodes, which are outside $R_{CS}(i)$, do not hear any signal.

About the word “heard”, we can distinguish two semantics (which will allow to underline similarities between topologies of the two classes): the strong semantic which is “the signal which is received by a node, can be decoded by this node”; the weak semantic which is “the signal, which is received by a node, induces only a busy channel state”.

The topologies mono-hop (class 1) and chain-2 (class 2) are only characterized by the strong semantic (as $R_{CS} = R_T$). The topologies chain-1 (class 1) and chain-3 (class 2) are characterized by the two semantics (as $R_{CS} > R_T$): the strong semantic for the nodes $(i - 1)$ and $(i + 1)$ *i.e.* the nodes which are the neighbours of the node i (they are one hop distant of the node i); the weak semantic for the nodes distant of the node i from 2 hops till h hops.

2.3 Type 3 of the basic knowledges

These basic knowledges concern the main principles of the CANlike protocols. As these protocols are inspired by the CAN network MAC protocol, we first make a reminder of the principles of this MAC protocol. Then, we show how we can adapt these principles to the different topologies.

2.3.1 Reminder: the principles of the CAN MAC protocol

The CAN network is a bus (*i.e.* one broadcast domain) where a frame consists of a SOF (Start of Frame) bit followed by an ID (IDentifier) field, which represents the frame priority, and then others fields that we globally call “data part”. All the bits of the frame are coded with the NRZ code (a bit 1 is a positive voltage V ; a bit 0 is the zero voltage) and the duration of a bit is higher than twice the maximum time on the bus (we give the reason later).

When a MAC entity has a frame to send (resulting of a request from the upper layer), it has to implement three successive phases: the first phase concerns the obtaining of the authorization to access the medium (the authorization is got after the listening of the idle medium state throughout a defined duration); the second phase consists in a synchronization phase (role of the SOF bit) the objective of which is to inform the other MAC entities of the beginning of a frame sending); the third phase, which concerns the attribute CR (Collision Resolution), consists in the implementation, in the MAC entity of a tournament based on the comparison bit by bit of its ID field (starting from the Most Significant Bit (MSB)), with the logical AND of the bits of the same rank of the ID fields of the frames that the other MAC entities are sending. The possibility of this comparison between of the ID bits of the same rank results from the choice of the duration of a bit. Concerning the logical AND, it results from a bus property (if a bit 1 is sent by one MAC entity and simultaneously a bit 0 is sent by another MAC entity, the bus gives a bit 0, hence the concept of Dominant bit 0-Recessive bit 1).

The tournament winner (the MAC entity which has the smallest ID, then the strongest priority) can then send its data part. Note that a MAC entity, which has no frame to send, is always listening to the medium.

Remark: In the CAN network, the collision resolution mechanism works at the ID bit level which imposes the ID bit duration. As all the bits of a frame (SOF, ID bits, data field) use the code NRZ with the duration imposed by an ID bit, the data part throughput depends then on the maximum distance between two nodes on the bus (longer is the bus, smaller is the permitted data throughput). Such an implementation obviously penalizes the data part throughput.

2.3.2 The general principles of the CANlike protocols

These protocols retain, at first, the following characteristics of the CAN MAC *i.e.*:

1. a frame structure which consists in a synchronization bit, an ID field (which represents the frame priority) and the “data part” field (which includes the node address and the user data),
2. a functioning which is based on three phases: the authorization phase for the channel access, the synchronization phase for the planning of a coherent tournament starting, the tournament phase (also based, on the one hand, on the comparison bit by bit of the ID fields of all the frames candidate for the transfer and, on the other hand on the concept Dominant bit 0-Recessive bit 1) which determines the winner which will send the “data part” of its frame on one hop.

However these protocols are not in line with the protocol CAN MAC which uses, for all the bits of a frame, the same code (NRZ) and the same duration. These protocols consider differently the “data part” bits and the other bits (synchronization bit, ID bit)in the objective of to not penalize the “data part” throughput. Obviously, we can, if we want, use like in CAN the same code and the same duration for all the bits.

Furthermore, concerning the concept Dominant bit 0-Recessive bit 1, it cannot be implemented as it is in CAN because, in a wireless context, the physical layer of a MAC entity cannot send and receive in the same time.

2.3.3 Codes and Ranges for the different bits (ID, synchronization, data)

ID bit and synchronization bit codes

We first consider the ID bit code. It is the constraint of the concept Dominant bit 0-Recessive bit 1 which fixes the ID bit code. We adopt the solution defined in the Widom protocol [7]. We present it now.

A dominant bit (bit 0) consists in the sending of a carrier wave; a recessive bit (bit 1) consists in the channel listening. The transition between a bit 0 and a bit 1 (and conversely) requires the time τ_{TT} . Consequently, in the MAC entity of a node, we get the same results for the tournament as the CAN network:

- the MAC entity has a dominant bit: it wins, by definition, and it continues the tournament;
- the MAC entity has a recessive bit: if, during the channel listening, it detects a carrier wave (bit dominant), it loses the competition on this bit and then abandons the participation to the tournament (but it observes its progress, it can be the data frame recipient); if, during the channel listening it detects nothing (that means that there is no dominant bit which is emitted), it continues the tournament.

Concerning the synchronization bit code, it will be like a dominant bit 0 (a carrier wave). The problem of the duration of a synchronization bit and an ID bit will be tackled when we will present the synchronization phase and the tournament phase.

Data bit code and Data bit range

The data bit code can be any classical modulation technique (Amplitude Shift Keying, Frequency Shift Keying, Phase Shift Keying) [8] with a bit duration fixed by the user data throughput needs. Considering the different topologies that we have presented, a data bit must have a power which is compatible with the ranges R_T and R_{CS} of these topologies. From now, by considering a node i , the ranges will be noted $R_T(i, da)$ and $R_{CS}(i, da)$.

ID bit and synchronization bit ranges

Consider a node i candidate for sending a frame and which has the authorization for the channel access. It has first to implement the synchronization phase and the tournament phase *i.e.* it is in competition with all the nodes which are in the range $R_{CS}(i, da)$. Then the transmission range of the **synchronization** bit and the **ID** bit of the node i (noted $R_T(i; (sy, ID))$) must be equal to $R_{CS}(i, da)$. Concerning the carrier sense range of the synchronization bit and the ID bits of a node i that we note $R_{CS}(i; (sy, ID))$, we take it equal to $R_T(i; (sy, ID))$ in order to not perturb the nodes which can be outside this area.

Now we can give the links, in term of the ranges and in the different topologies between, on the one hand, the synchronization bit and the ID bits and, on the other hand, the data part bits:

- mono-hop topology and chain-2:
 $R_{CS}(i; (sy, ID)) = R_T(i; (sy, ID)) = R_{CS}(i, da) = R_T(i, da)$
- chain-1 and chain-3: $R_{CS}(i; (sy, ID)) = R_T(i; (sy, ID)) = R_{CS}(i, da) > R_T(i, da)$

2.3.4 Authorization phase

The authorization phase will be different depending on whether we have a topology class 1 or a topology class 2. Concerning the topology class 1, as it represents one broadcast domain *i.e.* any node can hear any other node when it is transmitting, we can use the CAN access authorization method. Then a node decides to access the channel after the listening of the idle channel state continuously during a time τ_{ST} (it is the CSMA technique). Concerning the topology class 2, as it represents multiple broadcast domains, *i.e.* any node cannot hear the nodes which are outside its Carrier Sense Range, we cannot use the CAN access authorization method *i.e.* to consider

the medium listening strategy of a CSMA technique. We propose to have a global clock which gives periodically the same authorization instant to access the medium to the MAC entities of all the nodes (obviously, we will have also to specify the periodicity of these authorizations). This global clock could be a GPS system as proposed by [9] and [10]. Then, with the topology class 2, the authorization phase is based on a centralized technique.

2.3.5 Synchronization phase

We base the presentation of the synchronization phase on the concepts of competitor and no-competitor nodes which allows to specify the conditions for a clean starting of a tournament phase.

A- Concepts of competitor and no-competitor nodes

A competitor node i is a node where the MAC entity, after the reception of a request from the upper layer, gets the authorization for the medium access. At the instant of this authorization, it broadcasts in the range $R_{CS}(i, da)$ a synchronization signal (energy pulse, *i.e.* carrier wave which must have a duration $ls \geq \tau_{ST}$; here we consider $ls = \tau_{ST}$) in order to announce to all the nodes, which are in $R_{CS}(i, da)$ that it is going to undertake a tournament. In the topology class 1, the synchronization signal reaches all the other nodes of the topology (because, by definition, all the nodes are in the intersection of their $R_{CS}(da)$ ranges). In the topology class 2, the synchronization signal reaches only the nodes which are in $R_{CS}(i, da)$.

Note furthermore that, if we have others competitors with the node i (any others nodes of the whole topology for the topology class 1; only any others nodes of $R_{CS}(i, da)$ for the topology class 2), we have the crossing of the synchronization signal of the node i with the synchronization signals of the other competitor nodes (by the crossing phenomenon, we mean that, in the MAC entity of each competitor node, the end of the synchronization signal, which is sent, is overtaken by the ends of the arrival of the synchronization signals coming from the MAC entities of the other competitor nodes).

Then accounting for these remarks on the competition between several competitor nodes, we can see that, in the topology class 1, a tournament will be at the level of the whole topology (concept of global tournament) whereas, in the topology class 2, a tournament will be at the level of a range R_{CS} and we can obviously have also parallel tournaments (in ranges R_{CS} which have no intersection).

Concerning the no-competitor nodes, their definition depends on whether we have a topology class 1 and a topology class 2:

- class 1: a no-competitor node is a node where the MAC entity, either has not a frame to send or has received, from the upper layer, a request to send but the channel became busy because of a synchronization signal sent by a competitor node before of the end of the time τ_{ST} .
- class 2: a no-competitor node is a node where the MAC entity has not received, from the upper layer, a request to send before the arrival of the global clock top.

A no-competitor node, like in CAN, is always listening to the channel. Note furthermore above a synchronization signal sent by a competitor node i : in the topology class 1, the synchronization signal is received by all the no-competitor nodes of the whole topology; in the topology class 2, it is only received by the no-competitor nodes of the range $R_{CS}(i, da)$ then we can have no-competitor nodes which do not receive synchronization signals (for example: nodes which are between parallel tournaments *i.e.* tournaments separated by several nodes). The no-competitor nodes, which receives a synchronization signal, are then aware of the next starting of a tournament phase.

B- Conditions for a clean starting of a tournament phase

The goal of a synchronization phase is to allow, on the one hand, the competitor nodes, which will be in competition, to start cleanly the tournament and, on the other hand, the no-competitor nodes, which are in the domain of the tournament *i.e.* which have received a synchronization signal, to follow cleanly the tournament (a no-competitor node can, in particular, be interested in the reception of the frame sent by the tournament winner). These conditions of cleanness require, of the nodes, to control the consequences of the synchronization signal crossing phenomenon:

- a competitor node must have a clean channel when it starts the tournament (“clean” means that nothing of the synchronization phase remains on the channel); then a competitor node must consider, after the sending of its synchronization signal, a guard time t_g *i.e.* a duration equal to the maximum residual time of the synchronization signal exchanges (during t_g the MAC entity of the node is blind; after $(l_s + t_g)$, it can start the tournament (sending of the ID bits)),
- a no-competitor node must know precisely the tournament beginning: after the reception of the first synchronization signal l_s , it waits for the end of the duration t_g and then it is ready to receive ID bits.

Concerning t_g , it is the biggest time difference, that we can have in the MAC entity of a competitor node i between the end of the sending of its synchronization signal and the end of the arrival of a synchronization signal coming from the more distant competitor node j in the range $R_{CS}(i, da)$. The t_g evaluation depends on the way of the medium access authorization and then it is different depending on whether we have a topology class 1 or class 2:

- topology class 1: t_g is given by the total of the maximum time shift D_{max} , between the dates of the synchronization signal sending in the nodes i and j , and the propagation time between these nodes.
- topology class 2: accounting for the concept of global clock for the medium access authorization mechanism, t_g is here only given by the propagation time between the nodes i and j (here there is no more the notion of D_{max} as all the competitors nodes send the synchronization signals at the same time (global clock top)).

C- Important consequence of the synchronization phase for the topology class 2

The exogenous interference situation 1, which can, for the protocol without synchronization phase (strict CSMA and CSMA-CA) (see paragraph 2.1.5), affect the frame transfer of a node i to a node $i + 1$, due to the influence of the node $(i + h + 1)$ hidden to the node i (creation, in the node $(i + 1)$ of the condition “busy channel” before the arrival of the frame coming from the node i) does not exist thanks to the synchronization phase. Then, for the chain-3 (see paragraph 2.2.2) we have no more the hidden node problem. Concerning the chain-2, the hidden node problem still exists (by the exogenous interference situation 2).

2.3.6 Tournament phase

1/ Preliminaries

The implementation of a tournament is based on priorities associated to the nodes and then the priority set cardinal must be specified:

- in the topology class 1, as a tournament can include all the nodes, the cardinal is given by the number of the nodes in the network;
- in the topology class 2, the cardinal depends on the conditions of the maximal parallelism possibility (minimal distance that we can have between two consecutive winners nodes *i.e.*

nodes which are not in competition for a data frame transfer and then which can have the same priority):

- with the chain-2 (R_{CS} of radius $h = 1$) if a node i is a winner (that means winner of the nodes $(i+1)$, $(i-1)$ in its range $R_{CS}(i)$ and also of the hidden nodes $(i+2)$, $(i-2)$), the closest other winner can be the node $(i+3)$ (or $(i-3)$); the minimal distance is then 3 hops (*i.e.* $(h+2)$) which fixes the priorities 0, 1, 2 with the periodicity 3.
- with the chain-3, as the hidden node problem does not more exist (consequence of the synchronization phase), then, if a node i is a winner (that means winner in its range $R_{CS}(i)$), the closest winner can be the node $(i+(h+1))$ (or $(i-(h+1))$) and then the minimal distance between two winners is $(h+1)$ hops which fixes the priorities 0, 1, 2 ... h , with the periodicity $(h+1)$.

2/ Main ideas for the tournament implementation

We have to distinguish, on the one hand, the case where we have not the hidden node problem (the topology class 1, *i.e.* the mono-hop and the chain-1 topologies, and also the topology class 2 chain-3) and the case where we have the hidden node problem (class 2 chain-2).

1. no hidden node problem

The tournament is implemented like in CAN, directly by means of the comparison bit by bit of the ID fields of the competitor nodes. The tournament duration is fixed by the product of the number of ID bits by the duration of an ID bit.

The evaluation of the ID bit duration is based on the analysis of the necessary listening time, for a MAC entity i which has a recessive bit, in order to be able to read the carrier wave which is sent by a MAC entity j which has a dominant bit. This analysis is based on the consideration of the two extreme cases of the carrier wave sending by the MAC entity j (*i.e.* the case of the maximal advance and the case of the maximal delay). These two extreme cases depend on the topology classes:

- class 1: they depend on the value of D_{max} and the value of the propagation time between the MAC entities i and j ,
- class 2: they only depend on the value of the propagation time between the MAC entities i and j .

2. hidden node problem

The tournament duration depends obviously always on the number of the ID bits but now, taking into account for the hidden node problem, two phases are associated to an ID bit [7]: the phase 1 is called transmission phase, the phase 2 is called retransmission phase (its role is to eliminate the hidden node problem by making to know the priority of a node to a node at a distance of two hops).

The behaviour of a competitor node is the following:

- phase 1: a node, which has a dominant bit, sends a carrier wave and is, by definition, winner on this ID bit; a node, which has a recessive bit, listens to the channel: either a carrier wave is received or nothing is received;
- phase 2: a node which has a dominant bit in the phase 1, is not concerned with this phase (it does nothing). Concerning a node which has a recessive bit in the phase 1:
 - if it receives, in the phase 1, a carrier wave, it loses the competition (because a neighbour N , at one hop distance, has a highest priority) and then it retransmits, in the phase 2, the carrier wave (then, making to know the higher priority to a node M (at a two hops distance of N));

- if it receives nothing in the phase 1, we have two cases: it receives a carrier wave in the phase 2, it loses the competition (because a neighbour, at a distance two hops, has a higher priority); if it receives nothing in the phase 2, it continues with the tournament.

Note furthermore that, with this topology class 2 chain-2, the no-competitor nodes as the competitor nodes which come to lose the tournament, have a role in the tournament progress (that results from the retransmission constraint). Their behaviour, for each ID bit, is the following: in the phase 1, they are listening to the channel; in the phase 2, if they heard a carrier wave in the phase 1, they retransmit the carrier wave (in the contrary they do nothing).

The ID bit duration in each phase (transmission phase, retransmission phase) is evaluated as the ID bit duration in the case of the topology class 1 and class 2 chain-3. The tournament duration, accounting for the two phases (transmission, retransmission), is then fixed by the number of the ID bits multiplied by the duration of the two phases of an ID bit.

2.3.7 Concept of transactional entity

We call transactional entity the sequence of the three phases (authorization, synchronization, tournament) plus the frame data part transfer resulting from the tournament.

The concept of transactional entity is very helpful, at the same time, in the case of the topology class 1, where the nodes, at the transactional entity end, can decide to become competitors for a new tournament and in the case of the topology class 2 where its duration allows to evaluate the minimal period of the global clock.

2.3.8 Particularities of the topology class 1

This topology class asks questions because we can have time shifts between the synchronization phase starts in the competitor nodes (which is not the case in the topology class 2 as all the synchronization phase starts in the competitor nodes are synchronous). Considering the possibility of these time shifts, we must precise particular points which concern the transition between the tournament end and the consequent frame data part exchange.

A first point is that we must guarantee that the frame data part, which is sent by the tournament winner node, does not arrive in the node, one node apart, before the tournament end view by this node (we remember that we consider that the data bit code is different of the ID bit code *i.e.* we use a classical modulation technique (ASK, FSK, PSK) which is not linked to the time shifts like the bits ID). This guarantee is got by introducing, in the winner competitor node, a time gap (noted W) between its view of the tournament end and the start of the frame data part sending. The evaluation of the W value must be done by considering the more pessimistic case *i.e.* the winner competitor node is the more possible in advance, in the synchronization phase with regard to the node one hop apart, when this node is a loser competitor node.

The use of this W value by a tournament winner competitor node can obviously induces, if we are not in the more pessimistic case (for example: the winner is the node the more in delay, in the synchronization phase; the node one hop apart is a no-competitor node), delays, in the node one hop apart, between its view of the tournament end and the frame data part arrival (during these delays, the channel is free: so, if we use the technique ASK for the data bits, we must necessarily do to precede the data part by a bit 1 meaning “data start”; if the technique is FSK or PSK, a “data start bit” is not strictly necessary but, if we use one, it can be either a bit 0 or a bit 1).

Another important point concerns the competitor node, the more in advance in the synchronization phase, in the case where the competitor node the more in delay in the synchronization phase is the winner: what is the delay, for the competitor node the more in advance, between the end of the tournament and the beginning of its view of the busy channel? These different delays and more precisely their maximum values might be evaluated (in order to give bounds on the duration of the state free channel between the tournament end and the data part transfer beginning).

3 Specification of the CANlike protocols

3.1 Topology class 1: determination of the maximum amount of time shift D_{max}

The important parameters are the parameters of a transceiver (τ_{ST} , τ_{TT}), the propagation time on one hop (τ_{PT}) and the number h of hops in a carrier sense range. The figure (5) represents the extreme case of the synchronization time shift (consideration of the two more remote competitor nodes i and j in the intersection of their R_{CS} ranges *i.e.* node j in the $R_{CS}(i)$ and node i in the $R_{CS}(j)$). We call τ the propagation time between the node i and the node j , *i.e.* $\tau = h\tau_{PT}$ with $h = 1$ for the mono-hop topology, and $h > 1$ for the chain-1. The values of D_{max} are presented in the table (1).

Mono-hop	$\tau_{PT} + \tau_{TT}$
chain-1	$h\tau_{PT} + \tau_{TT}$

Table 1: D_{max} values

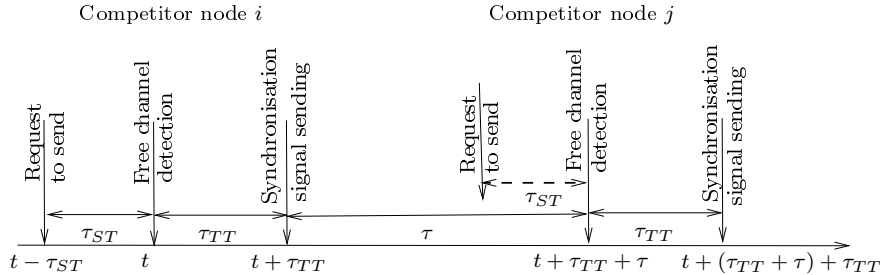

Figure 5: $D_{max} = \tau + \tau_{TT}$

The explanation is given in the figure (5). In the node i , we have at the time $(t - \tau_{ST})$ a request to send (a data frame) and we suppose that the channel stays free during τ_{ST} . Then the channel is detected free at the time t and the MAC entity of the node i decides to send a synchronization signal at this time t . After the turnaround time, τ_{TT} the synchronization signal is sent, *i.e.* at the time $(t + \tau_{TT})$, and the beginning of this signal arrives at the remote node j just at the time $(t + \tau_{TT} + \tau)$.

If the node j is just finishing to test the channel at the time $(t + \tau_{TT} + \tau)$ (after a request to send a data frame at the time $(t + \tau_{TT} + \tau - \tau_{ST})$), as the node saw the channel free during τ_{ST} , it decides to send a synchronization signal at the time $(t + \tau_{TT} + \tau)$ and then will send it, after the turnaround time τ_{TT} , *i.e.* at the time $(t + \tau_{TT} + \tau + \tau_{TT})$.

The duration $\tau + \tau_{TT}$ (difference between the sending times of the two synchronization signals) represents the value D_{max} .

If the node j had a request to send later than the time $(t + \tau_{TT} + \tau - \tau_{ST})$, for example at $(t + \tau_{TT} + \tau - \tau_{ST} + \Delta t)$, with $\Delta t < \tau_{ST}$, it would not have found the channel free at the time $(t + \tau_{TT} + \tau)$ (the synchronization signal from the node i was arriving) and then it could not send a synchronization signal.

In the mono-hop topology we have $\tau = \tau_{PT}$ and then $D_{max} = \tau_{PT} + \tau_{TT}$. In the multihop topology chain-1 ($h > 1$) we have $\tau = h\tau_{PT}$ and then $D_{max} = h\tau_{PT} + \tau_{TT}$.

3.2 Guard time t_g associated to the synchronization signal

About the topology class 1, we remember the figure 5 and we consider the sending by the node i MAC entity, of the synchronization signal ls at the time $t + \tau_{TT}$. The end of the sending at the time $t + \tau_{TT} + ls(\tau_{ST})$ is passed by the end of arrival of the synchronization signal coming from the node j MAC entity (this end occurs at the time $(t + \tau_{TT} + D_{max} + \tau + ls(\tau_{ST}))$). The necessary guard time t_g is then : $D_{max} + \tau$.

As we have τ_{TT} in the guard time t_g , we can use this time in two ways: if the first ID bit is a recessive bit (then different of the synchronization bit), we make the turnaround during the t_g of the synchronization bit; if the first ID bit is a dominant bit (like the synchronization bit) we let to elapse the duration τ_{TT} . Then, immediately after the t_g of the synchronization bit, we can send the first ID bit.

About the topology class 2, we have no more D_{max} *i.e.* t_g is only given by the propagation time τ between the nodes i and j . As we have not τ_{TT} in the guard time t_g , we cannot after the t_g of the synchronization, send immediately the first ID bit (if it is a recessive bit) without doing the turnaround τ_{TT} . So we propose to include it in the t_g and to use this time as in the topology class 1.

The value of t_g for the different topologies is given in the table (2).

class 1		class 2	
Mono-hop	chain-1	chain-2	chain-3
$2\tau_{PT} + \tau_{TT}$	$2h\tau_{PT} + \tau_{TT}$	$\tau_{PT} + \tau_{TT}$	$h\tau_{PT} + \tau_{TT}$

Table 2: t_g values

3.3 ID bit characteristics(l_b, t_g)

Consider again separately the topology class 1 and class 2.

- Topology class 1

Consider two MAC entities i and j such that they are characterized by the maximum amount of time shift D_{max} in the synchronization phase and suppose that the MAC entity i has a recessive bit (then listening to the channel) and the MAC entity j has a dominant bit (then sending a carrier wave). In order to evaluate the durations of l_b and t_g , we must consider the following scenarios:

- the MAC entity i starts the channel listening at the time t and ends at the time $t + l_b$;
- the MAC entity j starts the carrier wave sending: either (case 1, figure (6)) at the time $(t - D_{max})$, *i.e.* with a maximal advance, or (case 2, figure (6)) at the time $(t + D_{max})$, *i.e.* with a maximal delay.

The case 1 makes to appear that the carrier wave arrives at $t - D_{max} + \tau = t - \tau_{TT}$ (*i.e.* before the listening start, but this has none consequence as it occurs for the first ID bit during

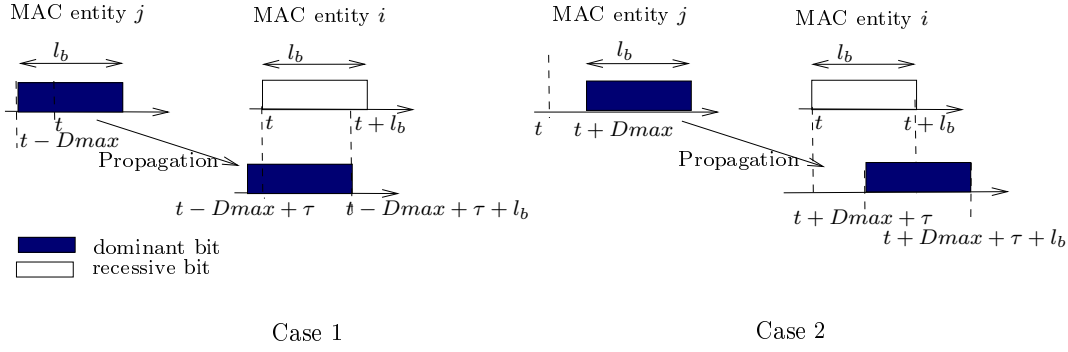

Figure 6: Time diagram for the bit ID evaluation

the guard time of the synchronization signal and for any other ID bit during the guard time of the previous ID bit as we will see that we need too a guard time associated to each ID bit) and lasts till $t - \tau_{TT} + l_b$ (in order to have a listening duration re-covering we need $l_b > \tau_{TT}$).

The case 2 makes to appear that the carrier wave arrives after the listening beginning and goes beyond the end of the listening duration.

In order to have some re-covering of the listening duration we need the following constraints: $l_b > D_{max} + \tau$. At least the value of l_b must be the value of τ_{ST} higher than the expressed constraint. Furthermore, as the end of the listening duration, we need a guard time $t_g = D_{max} + \tau$.

The values of l_b and t_g for the two topologies of the class 1 are given on the table 3.

	Mono-hop	chain-1
t_g	$2\tau_{PT} + \tau_{TT}$	$2h\tau_{PT} + \tau_{TT}$
l_b	$2\tau_{PT} + \tau_{TT} + \tau_{ST}$	$2h\tau_{PT} + \tau_{TT} + \tau_{ST}$

Table 3: Topologies class 1: t_g and l_b durations values

As we have τ_{TT} in the time t_g , we use this time in the same way as we do in the synchronization bit: we make a physical turnaround if the next ID bit is different; if the next ID bit is identical, we let to elapse the duration τ_{TT} (time passing).

- Topology class 2

Consider again the MAC entities i and j of two computers nodes which are characterized by the maximal distance (then the maximal propagation time τ determined by the range R_{CS} of a node) and suppose that the MAC entity i has a recessive bit (then listening to the channel) and the MAC entity j has a dominant bit (then sending a carrier wave). The evaluation of the durations l_b and t_g is obtained by considering the scenario represented on the figure 7 (the two entities start the action inherent to the ID bit at the same time t).

For some recovering of the listening duration we need $l_b > \tau$ and, at least, the value of l_b must be higher of the value of τ_{ST} than the expressed constraint. The value obtained for t_g is τ . However, as we have not the time τ_{TT} in t_g , we add, like for the synchronization bit the time τ_{TT} in the t_g and this time τ_{TT} is used like in the class 1. The values for l_b and t_g for the two topologies of the class 2 are given on the table 4.

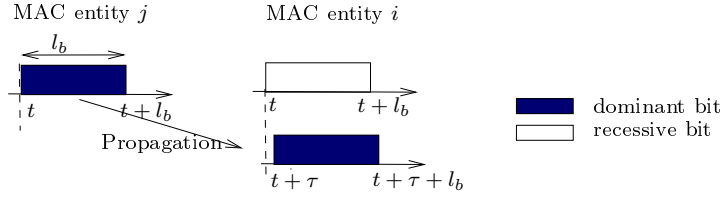

Figure 7: Time diagram for the bit ID length evaluation

	chain-2	chain-3
t_g	$\tau_{PT} + \tau_{TT}$	$h\tau_{PT} + \tau_{TT}$
l_b	$\tau_{PT} + \tau_{ST}$	$h\tau_{PT} + \tau_{ST}$

Table 4: Topologies class 2: t_g and l_b durations values

3.4 Particular points

3.4.1 Topology class 1

Evaluation of the time gap W

We consider two competitor nodes (nodes i and node $(i + 1)$) which are one hop apart in any topology (monohop; chain-1). The node i is supposed to be the more possible in advance, in the synchronization phase with regard to the node $(i + 1)$ (advance $(\tau_{PT} + \tau_{TT})$), and also the tournament winner. Call tl_i the instant of the sending end of the last ID bit of the node i . The end of the last ID bit by the node $(i + 1)$ is $tl_i + \tau_{PT} + \tau_{TT}$. By remembering that each ID bit is followed by t_g , the beginning of the data part which is sent by the node i , must arrive in the node $(i + 1)$ just at the end of the t_g relative to its last ID bit.

Then we must have the following relationship: $tl_i + t_g + W + \tau_{PT} = tl_i + (\tau_{PT} + \tau_{TT}) + t_g$ which gives $W = \tau_{TT}$.

On the competition, at the end of a transactional entity, for a new transactional entity

All the nodes have the view of the progress of a transactional entity whatever the node may be (competitor, no-competitor) and in particular its end:

- mono-hop and chain-1: the frame sending end in the winner node,
- mono-hop: the frame reception end by all the other nodes,
- chain-1: the frame reception end by the node(s) one hop apart from the winner node and the view of the busy channel end by the others nodes.

From this view, we have to evaluate the earliest instants where each node could send a synchronization signal for a new transactional entity. If we call t_f the end of the frame sending by the winner node in the present transactional entity, we can evaluate these earliest instants (call them t_{wc} and $t_{nc,lc}$, respectively for the winner competitor node and a no-competitor node or a loser competitor node):

- $t_{wc} = t_f + \tau_{TT} + \tau_{ST} + \tau_{TT}$ (mono-hop and chain-1),
- $t_{nc,lc} = t_f + x\tau_{PT} + \tau_{ST} + \tau_{TT}$ ($x = 1$ with the mono-hop or the chain-1 for the node one hop apart from the winner node; $1 < x \leq h$ with the chain-1 and for the nodes more than one hop apart from the winner).

Note concerning these instants that the winner node, as it was in a sending state, it has, at first, to make a turnaround (τ_{TT}) in order to be in the listening state. Then after the free channel sensing (τ_{ST}), it makes a new turnaround (τ_{TT}) in order to send a synchronization signal. The other nodes, as they were in the listening state, they have not to make the first turnaround τ_{TT} .

Taking into account these equations and considering the case of a chain-1 with h hops (nodes $i, (i+1), \dots (i+h)$), we can now use these equations to evaluate if a node, which finishes the free channel observation test and decides to send a synchronization signal, cannot prevent the other nodes to be also competitor (*i.e.* to have finished the free channel observation and then decided also to send a synchronization signal) and conversely.

Suppose that, in the present transactional entity, the node i is the winner and the other nodes are nodes nc, lc . We consider the extremes nodes of the chain 1 *i.e.* the nodes i and $i+h$. We have to make the following analysis:

1. does the “competitor” behaviour by the node i prevent the node $i+h$ to have also the “competitor” behavior.

The node i starts the synchronization signal sending at the time $(t_f + \tau_{TT} + \tau_{ST} + \tau_{TT})$ which arrives in the node $(i+h)$ at the time $(t_f + \tau_{TT} + \tau_{ST} + \tau_{TT} + h\tau_{PT})$.

The free channel observation test, by the node $(i+h)$ is at the time $(t_f + h\tau_{PT} + \tau_{ST})$, then before the arrival of the synchronization signal coming from the node i (difference of $2\tau_{TT}$).

2. does the “competitor” behaviour by the node $i+h$ prevent the node i to have also the “competitor” behavior.

The node $(i+h)$ starts the synchronization signal sending at the time $(t_f + h\tau_{TT} + \tau_{ST} + \tau_{TT})$ which arrives in the node i at the time $(t_f + h\tau_{TT} + \tau_{ST} + \tau_{TT} + h\tau_{PT})$.

The free channel observation test, by the node i is at the time $(t_f + \tau_{TT} + \tau_{ST})$, then before the arrival of the synchronization signal coming from the node $(i+h)$ (difference of $(2h\tau_{PT})$).

In conclusion, as we can do the same analysis by considering the cases of any two node couples in the chain-1 and also the mono-hop, we can conclude that any node can become competitor in the new transactional entity.

Bounds of the free channel duration between the tournament end and the data part transfer beginning

We consider the case where the data part bit code and the ID bit code are different. We only give here the bounds without demonstration:

- delay, between the tournament end and the data part arrival, in a no-competitor node one node apart the winner competitor node which is the more in delay in the synchronization phase:
 - mono-hop: $2\tau_{TT} + \tau_{PT}$,
 - chain-1: $2(\tau_{TT} + \tau_{PT})$,
- delay, between the tournament end and the view of the busy channel, in the competitor node which is, at the same time, the more in advance in the synchronization phase and a tournament loser
 - mono-hop: $2(\tau_{TT} + \tau_{PT})$,
 - chain-1: $2(\tau_{TT} + h\tau_{PT})$,

3.4.2 Topology class 2: minimal period of the global clock

It is important to have in mind that the duration of the transactional entity associated to any competitor node i is independent of the number of the nodes which can be in competition with it (because the t_g , which is associated to the synchronization signal and to an ID bit, includes the distance between the node i and the remote node in $R_{CS}(i)$; and furthermore, the duration l_b of an ID bit includes too this distance). This duration of a transactional entity includes the turnaround time τ_{TT} (effectuated at the arrival of the global clock top in order to be able to send the synchronization signal), the duration of the synchronization signal and its guard time ($l_s + t_g$), the duration \mathcal{T} of the tournament (which depends on the fact that we have a chain-2 (hidden node problem and then two phases: transmission, retransmission) or a chain-3 (no hidden node problem)), the duration \mathcal{D} of the data part of the frame which is sent by the winner node (we must have, in this topology class 2, data parts which have always the same duration) and finally a duration representing the come back of the global system to the listening state (*i.e.* when the winner, on the one hand, has made a turnaround and, on the other hand, the transmission of the frame and its consequences (busy channel) are finished).

The duration \mathcal{T} of the tournament (by considering that the ID field has n bits) is : $\mathcal{T} = 2n(l_b + t_g)$ in the chain-2 and $\mathcal{T} = n(l_b + t_g)$ in the chain-3.

Then we can express the duration \mathcal{P} of the minimal period:

- chain-2: $\mathcal{P} = \tau_{TT} + (l_s + t_g) + 2n(l_b + t_g) + \mathcal{D} + \max(\tau_{TT}, \tau_{PT})$,
- chain-3: $\mathcal{P} = \tau_{TT} + (l_s + t_g) + n(l_b + t_g) + \mathcal{D} + \max(\tau_{TT}, h\tau_{PT})$.

The \max component expresses the come back to the listening state.

Remarks:

- 1- Here, contrarily to the class1, as all the synchronization signals are sent at the same instant, we have neither a time gap W in a winner competitor node nor a delay, in a node one hop apart the winner, between the tournament end and the data part arrival.
- 2- If we consider the case where the data part of the frames have not the same duration, we have to do the computation by considering the longest duration.

3.5 Intraflow problem

We want here, by considering the chain topologies which use the CANlike protocols defined in the subsections 3.2, 3.3 and 3.4.2, to focus on the particular problem of a frame flow transfer and, more specially, on the priority scheme which is required for the frames.

Consider a frame flow transfer from the first node (source node) to the last node (destination node). We number the nodes in the increasing order (*i.e.* from 1 (source node) to d (destination node)), the value of d depending of the chain length.

We want to analyse what we call the worst case of the frame flow transfer *i.e.* the source node wants to send a new frame immediately after the previous frame sending and also any other intermediate node, between the source node and the destination node, wants to send a frame immediately after its reception.

With a CSMA type scheduling protocol (pure CSMA or CSMA-CA), collisions will occur along the flow path (the source node induce obviously collisions but also the intermediate nodes) which gives a chaotic progress in the frame flow transfer and which requires several buffers in the intermediate nodes in order to avoid buffer crushing (an intermediate node, for example, can receive several successive frames before being able to send the first received frame).

With a CSMA-CR type protocol, we have the possibility to determine, in a collision situation, the winner and then to allow a regular process of the frame flow transfer with only one buffer in each intermediate node. In order to do that, we have, at first to specify for each chain the

constraints which must be considered for the behaviour of the nodes (and, first, on the source node) and then to determine the necessary priority scheme.

A general constraint on the source node (node 1) is: after the sending of a frame, the source node can send a new frame only when the previous frame has left its competition area *i.e.*:

- in the chain-1, the previous frame has reached the destination node; then the priority scheme must be: the node 1 has the priority 1, the nodes 2, 3, ..., $1 + h - 1$ have the priority 0; the node d ($d = 1 + h$) does not need priority as it does not send frames.
- in the chain 2 ($h = 1$), the previous frame has reached the node, which is one hop after the hidden node (node 3), *i.e.* the node 4 (node $1 + h + 2$); then the priority scheme must be: the node 1 has the priority 1, the nodes 2 and 3 have the priority 0; the node 4 can take the priority 1; we have parallelism between the node 1 (sending a new frame) and the node 4 (propagating the first frame); the nodes 5 and 6 have the priority 0 and so on. The priority of the node 4 could be also 0 because the nodes 1 and 4 are distant of $h + 2$ hops and two nodes distant of $h + 2$ hops can win (whatever their priority may be) if the nodes 2 and 3 (and 5 and 6) are no-competitor, as it is the case here;
- in the chain-3 ($h > 1$), the previous frame has reached the node which is one node after the node $1 + h$ (last node of the $R_{CS}(1)$) *i.e.* the node $(1 + (h + 1))$; then the priority scheme must be : the node 1 has the priority 1, the nodes 2, 3, ..., $1 + h$ have the priority 0; the node $1 + (h + 1)$ can take the priority 1; we have then parallelism between the node 1 (sending a new frame) and the node $(1 + (h + 1))$ propagation of the first frame. Note also that the priority of the node $(1 + (h + 1))$ could be also 0 because the node 1 and the node $(1 + (h + 1))$ are distant of $(h + 1)$ hops and these nodes can win whatever their priority may be) if the nodes 2, 3, ..., $(1 + h)$ (and the nodes $1 + h + 2, 1 + h + 3, \dots, 1 + 2h$) are no-competitors, as it is the case here.

This scheme of parallelism in the chain-2 and the chain-3 is reproduced along the chain till the destination node *i.e.* we have parallelism between the frames sent by the source node and the propagation of these frames in the intermediate nodes (or between intermediates nodes). We express the general conditions of the parallelism:

- chain-2: with $i \in [1..h + 2]$, the nodes $i, \dots, i + (h + 2)q$ ($q = 1, 2, 3, \dots$) such that $1 + (h + 2)q < d$, can transmit in parallel,
- chain-3: with $i \in [1..(h + 1)]$, the nodes $i, \dots, i + (h + 1)q$ ($q = 1, 2, 3, \dots$) such that $1 + (h + 1)q < d$, can transmit in parallel.

4 Conclusion

We have tried, as much as can be, to do a pedagogical work based on a hierarchy of three basic knowledge levels which are necessary in order to make a rigorous specification of the CANlike protocols.

The first level concerns fundamental characteristics of the physical layer in wireless networks: the parameters of a transceiver (sensing time, turnaround time); the different ranges (transmission range; carrier sense range); the hidden node problem.

The second level concerns the main basic topologies (mono-hop, multi-hop, and its different types) and also a classification of these topologies into two classes (the class 1 consisting in one broadcast domain *i.e.* where every node is "heard" by all the nodes, and the class 2, consisting in multiple broadcast domain *i.e.* where a node is only "heard" by a subset of the nodes; note also that we define two semantics of "heard": strong and weak).

The third level concerns the great principles which underlie the CANlike protocols *i.e.* which, by keeping the frame pattern used in the CAN network (synchronization, Identifier (ID) bits, data part bits) and also the three phases preceding the data part transfer (authorization phase for accessing the channel, synchronization phase for starting a tournament, tournament phase) presents the adaptation to the wireless network context and to the different topologies.

The CANlike protocols are different in the two topologies classes: in the class 1, we can use “the test of the free channel” for the authorization phase for accessing the channel; in the class 2, we have to use a global clock *i.e.* we have a centralized technique; in the two classes, we do not consider (like in the CAN protocol) the same code for the ID bits and the data bits (because this strategy gives a data throughput which depends on the bus length) but we consider different codes (the data bits can be coded with the classical modulation techniques: ASK, FSK, PSK) which, in the class 1, as we can have time shifts in the synchronization (which is not the case in the class 2 because of the global clock), gives free channel durations between the tournament end and the data part sending (the bounds of these durations are given). Furthermore, concerning the class 1, we have shown that, at the end of the frame data part transfer by the tournament winner node, all the nodes can become competitors for a new transaction, and, concerning the class 2, we have evaluated the period, which is necessary for the global clock, in order to all the nodes can also become competitor, for a new transaction, at each global clock top.

The presentation, which we have done, concerns a specification in prose of CANlike protocols. We think that it would be important to do a formal specification allowing to verify these protocols with regard to expected properties. It would be an interesting research subject with in particular, the comparison, in the different topologies in terms of throughput performances, of the cases where we use or we do not use the same code for the ID bit and the data bit.

Finally, we would like to emphasize the interest of such protocols for the implementation of real-time applications (like control command applications with a control loop (figure 8) in a wireless network context [11], [12].

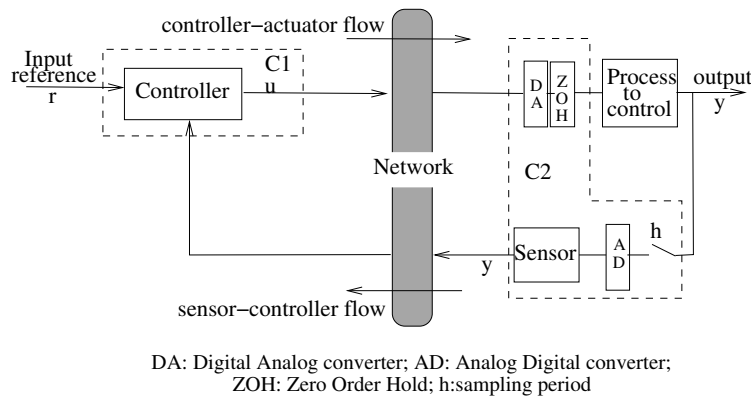

Figure 8: Implementation of a process control application through a network

We have made a simulation, based on the tool TrueTime [13], of an example consisting of 4 identical applications (noted P_1, P_2, P_3, P_4) which are implemented in a mono-hop topology (for each application the controller is implemented in one node; the sensor and the actuator are implemented in a node distant of one hop). We consider that the priorities of the flows are $P_1\text{priority} > P_2\text{priority} > P_3\text{priority} > P_4\text{priority}$. We have considered a cost function ITSE (Integral of Time Weighted Square Error) noted J (it is noted J_0 when the application is implemented without the network). We have evaluated the performance criterion $\frac{J-J_0}{J_0}\% = \frac{\Delta J}{J_0}\%$ and we show figure 9 the interest of the CANlike protocol with regard to the implementation with DCF-WiFi (a deterministic behaviour with respect to a random behaviour; higher are the

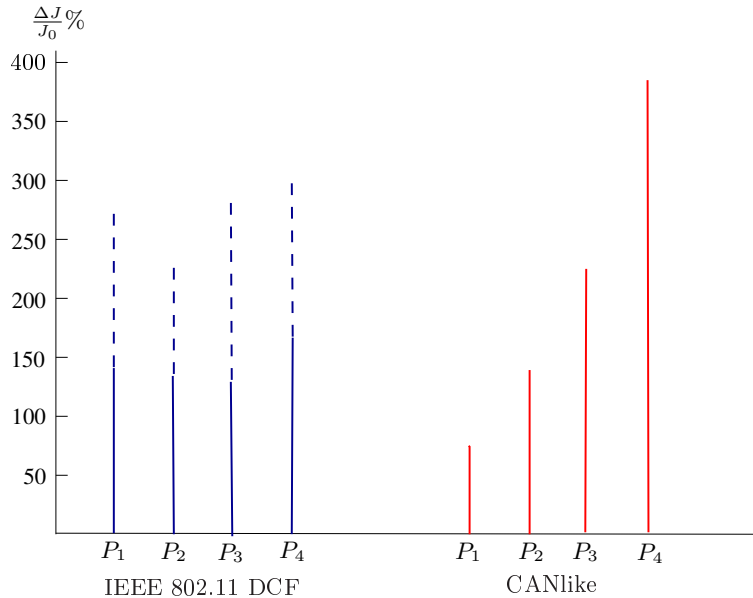

Figure 9: Graphic representation of the performance criterion $\frac{\Delta J}{J_0} \%$

flow priorities of an application better are the application performances).

References

- [1] IEEE802.11-2012. *IEEE standard for information technology – Telecommunications and information exchange between systems local and metropolitan area networks– Specification requirements Part 11: Wireless LAN Medium Access Control (MAC) and physical layer (PHY) specifications*, 2012.
- [2] J.L. Sobrinho and A.S. Krishnakumar. Quality-of-service in ad hoc carrier sense multiple access wireless networks. *IEEE Journal on Selected Areas in Communications*, 17(8):1353–1368, Aug 1999.
- [3] Xuan Hung Nguyen, Guy Juanole, Gérard Mouney, and Christophe Calmettes. Wireless communication networks and process control applications: studying the influence of mac protocols. In *Proceedings of IEEE Globecom 2010, Workshop SaCoNAS, Miami, Florida, USA*, Dec 2010.
- [4] Ping Chung Ng and Soung Chang Liew. Offered load control in ieeee 802.11 multi-hop ad-hoc networks. In *Proceedings of the 1st IEEE International Conference on Mobile Ad-hoc and Sensor System*, MASS’04, Oct. 2004.
- [5] Yan Gao, Dah-Ming Chiu, and John C. S. Lui. The fundamental role of hop distance in ieeee802.11 multi-hop ad hoc networks. In *Proceedings of the 13TH IEEE International Conference on Network Protocols*, pages 75–84, Washington, DC, USA, 2005. IEEE Computer Society.
- [6] Kaixin Xu, M. Gerla, and Sang Bae. How effective is the IEEE 802.11 RTS/CTS handshake in ad hoc networks. In *Global Telecommunications Conference, 2002. GLOBECOM ’02. IEEE*, volume 1, pages 72–76, Nov. 2002.
- [7] N. Pereira, B. Andersson, and E. Tovar. Widom: A dominance protocol for wireless medium access. *Industrial Informatics, IEEE Transactions on*, 3(2):120–130, May 2007.

- [8] Andrew S. Tanenbaum. *Computer Networks, 3rd Edition*. Prentice Hall, 1996.
- [9] Tiantong You, Chi-Hsiang Yeh, and Hossam Hassanein. Csmatic: A new class of collision-free mac protocols for ad hoc wireless networks. *Computers and Communications, IEEE Symposium on*, 0:843–848, 2003.
- [10] Hongyi Wu, Anant Utgikar, and Nian-Feng Tzeng. Syn-mac: a distributed medium access control protocol for synchronized wireless networks. *Mob. Netw. Appl.*, 10(5):627–637, 2005.
- [11] Xuan Hung Nguyen, Guy Juanole, and Gérard Mouney. On interplay between the quality of service and the quality of control for a co-design approach of a wireless networked control system (wncs). In *International workshop, IEEE Electronics, Control, Measurement, Signals and their application to Mechatronics (ECMSM), Toulouse, France*, June 2013.
- [12] Guy Juanole. Taking up the challenges of a co-design approach for networked control systems in a wireless context. In *Invited speaker, International workshop on Real Time Networks (RTN), Paris, France*, July 2013.
- [13] Martin Ohlin, Dan Henriksson, and Anton Cervin. *TrueTime 1.5 – Reference Manual*. Lund Institute of Technology, Sweden, January 2007.