



**HAL**  
open science

# Modeling and Simulation: The Spectral CANON for CONLON Nancarrow by James Tenney

Charles de Paiva Santana, Jean Bresson, Moreno Andreatta

► **To cite this version:**

Charles de Paiva Santana, Jean Bresson, Moreno Andreatta. Modeling and Simulation: The Spectral CANON for CONLON Nancarrow by James Tenney. Sound and Music Computing, 2013, Stockholm, Sweden. hal-01170066

**HAL Id: hal-01170066**

**<https://hal.science/hal-01170066>**

Submitted on 2 Jul 2015

**HAL** is a multi-disciplinary open access archive for the deposit and dissemination of scientific research documents, whether they are published or not. The documents may come from teaching and research institutions in France or abroad, or from public or private research centers.

L'archive ouverte pluridisciplinaire **HAL**, est destinée au dépôt et à la diffusion de documents scientifiques de niveau recherche, publiés ou non, émanant des établissements d'enseignement et de recherche français ou étrangers, des laboratoires publics ou privés.



Distributed under a Creative Commons Attribution 4.0 International License

# MODELING AND SIMULATION: THE SPECTRAL CANON FOR CONLON NANCARROW BY JAMES TENNEY

Charles de Paiva Santana, Jean Bresson, Moreno Andreatta

UMR STMS, IRCAM-CNRS-UPMC

1, place I.Stravinsky 75004 Paris, France

{charles.de.paiva, jean.bresson, moreno.andreatta}@ircam.fr

## ABSTRACT

This paper presents an approach for the analysis of musical pieces, based on the notion of computer modeling. The thorough analysis of musical works allows to reproduce compositional processes and implement them in computer models, opening new perspectives for their exploration through the simulation and generation of variations derived from the original model.

## 1. INTRODUCTION

During the analysis of a musical work, musicologists wonder how different decisions in the elaboration of a composition would have affected the final score. For instance: how would certain serial piece be affected if the composer had followed the base series or tone-rows without any deviations, or how a different starting parameter would affect a process-based composition, and so on. In order to face these situations and investigate the corresponding hypotheses, the more or less conscious, accurate and comprehensive simulation of the pieces' generative processes is often essential. The modeling of a musical work requires the explicit formulation of the underlying relations existing between different aspects of its compositional process. Computer tools and environments can be of a precious help here, and the implementation of carefully designed models may allow to simulate, explore and compare the potential results of different possible compositional "choices" or alternatives for a work. We call such alternatives the different *instances* of the piece, and will use this concept as a base for our computer-aided analysis approach. We believe that the study and analysis of musical works through computational modeling and the generation of alternative instances may bring to light new interesting knowledge about the compositional processes and attitudes at their origins.

The pioneering works by Riotte and Mesnage [10] thoroughly explored the idea of modeling compositional processes with the computer. The Morphoscope software they developed permitted the implementation of computer processes considering scores jointly with the analytical and

compositional models. However their results laid upon formalisation and validation of constructed models, while the study of compositional decisions and the simulation of alternatives was not a major concern.

Closer to our working perspective, previous works have also been carried out for the computer-assisted modeling and analysis of Xenakis' music in Patchwork [8] and OpenMusic [1], or for the analytical "re-composition" of Boulez' *Structures Ia* [2] in the OpenMusic and Rubato software environments. The approach we propose inherits from these previous works and develops the concept of model to produce alternative instances of the pieces.

We consider this idea of modeling and simulating pieces for the generation of alternative instances, and discuss its consequences on the musicological approach. We choose as a starting point the piece *Spectral CANON For CONLON Nancarrow* by James Tenney (1974) and develop a methodology to question some of Tenney's compositional choices and envisage expansions and his use of the "spectral" techniques.

This paper is organized as follows. In Section 2 we present the model and give preliminary elements for the analysis of James Tenney's piece. Section 3 describes the implementation of our model in the OpenMusic environment, which is then studied and extended in Section 4 in order to generate alternative instances of the piece. We conclude with some perspectives on this musicological approach and its possible use in future musicological projects.

## 2. THE MODEL OF JAMES TENNEY'S SPECTRAL CANON FOR CONLON NANCARROW

This piece *Spectral CANON For CONLON Nancarrow* by James Tenney (1932-2006) [11] for player piano is based on the idea of a correspondence between rhythmic and pitch interval ratios which recalls us of Henry Cowell's homologous ideas described in his book *New Musical Resources* [5].

Several versions of the piece are known to date. The original one by James Tenney dates back from 1974. It has been rewritten and extended by composer Clarence Barlow in 1990.<sup>1</sup> Previous analyses of the piece include for instance Polanski's (1983) [9] and Wannamaker (2012) [12].

Copyright: ©2013 Charles de Paiva Santana et al. This is an open-access article distributed under the terms of the [Creative Commons Attribution 3.0 Unported License](http://creativecommons.org/licenses/by/3.0/), which permits unrestricted use, distribution, and reproduction in any medium, provided the original author and source are credited.

<sup>1</sup> See <http://conlonnancarrow.org/symposium/ClarenceBarlow.html>. More recently, the Irish composer Ciarán Maher created some other variations based on Tenney instructions. See [http://rhizomecowboy.com/spectral\\_variations/](http://rhizomecowboy.com/spectral_variations/)

$$Duration(n) = k \cdot \log_2\left(\frac{8+n}{7+n}\right)$$

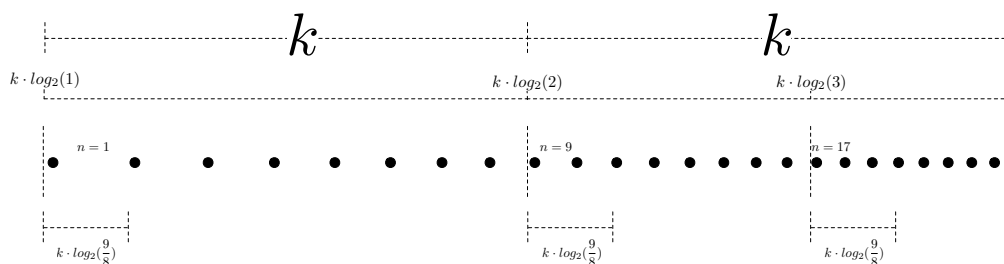

**Figure 1.** Representation of the series of durations (seen as the intervals between points). Its proportions are exactly the same of an harmonic series starting with the eighth overtone (9:8 ratio).  $k$  is an arbitrary duration value equivalent with the first octave. Subsequent octaves are equivalent of  $k \cdot \log_2(2)$ ,  $k \cdot \log_2(3)$  and so forth.

### 2.1 General Structure of the Piece

The piece consists of a 24 voices canon, where all voices share a same series of decreasing durations (*accelerando*), and superimpose to one another following a precisely determined pattern. When a voice reaches the end of the series, it begins playing its own retrograde.

### 2.2 Series of Durations

The series of durations is obtained by calculating the intervals between successive partials of the harmonic series, starting with the eighth one (9:8, corresponding to a major second). The general formula to obtain these intervals in the pitch domain multiplies the value of one octave in cents (1200) by the binary logarithm of each interval. To calculate series of durations, we replace the octave in cents by an arbitrary value in seconds, which we call the constant  $k$ :

$$duration(n) = k \cdot \log_2\left(\frac{8+n}{7+n}\right)$$

Tenney chose the precise value of  $k$  aiming the first interval to last four seconds:

$$k \cdot \log_2\left(\frac{9}{8}\right) = 4, \quad k = 4 \log_2\left(\frac{9}{8}\right), \quad k = 23.539797$$

As the original series begins with the eighth interval in the harmonic series, it takes 8 durations to sum the value of  $k$  (or one octave). Figure 1 resumes the previous properties of durations and intervals. The total number of durations in the series is related to the number of voices (see next section).

### 2.3 Voice entries

The 24 voices enter at the successive “octaves” in the initial series of durations (hence, every eight elements in the series). The second voice enters when the first voice is twice faster, the third voice enters when the first voice is thrice faster and so forth. Figure 2 shows a reduced scheme of the voice entries. After 184 durations ( $8 \times 23$ ), the 24th voice enters and the first voice stops its ‘forward’ motion.

Entry of the voices - Superposition of the same series

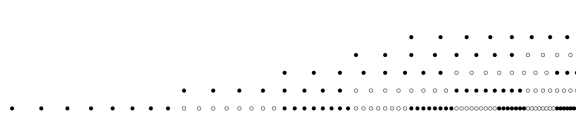

**Figure 2.** Reduced representation of the voices entries. Each group represents a cycle of eight durations (the space of one ‘durational octave’)

### 2.4 Retrograde voices

The series retrograde is systematically appended to every voice in the canon. In the original version, the piece ends when the first voice completes its retrograde, and when the 24th voice ends its regular series, which is a point when all voices share the same attack.

Barlow’s extended version of the canon continues until the last voice also finishes a complete retrograde. Since each voice starts its retrogradation and consequently decelerates at different moments, new unexpected textures emerge, forming melodic patterns, harmonic *glissandi* and chords due to occasional points of synchronism.

### 2.5 Pitches

Each voice plays repeatedly one single tone corresponding to its position in the canon (and in the harmonic series): the second voice plays twice the frequency of the first voice (octave), the third voice plays thrice the frequency of the first voice (fifth), and so forth. In this way, this piece is also a melodic canon (even if a very elementary one) where each voice plays a transposition of the first one at a precise interval, starting with the traditional ones (transposition at the octave, fifth) and going up to the most unusual intervals, smaller than one semitone.

## 3. IMPLEMENTATION OF THE MODEL

Our present work mostly takes place in the OpenMusic computer-aided composition environment [3, 4]. Open-

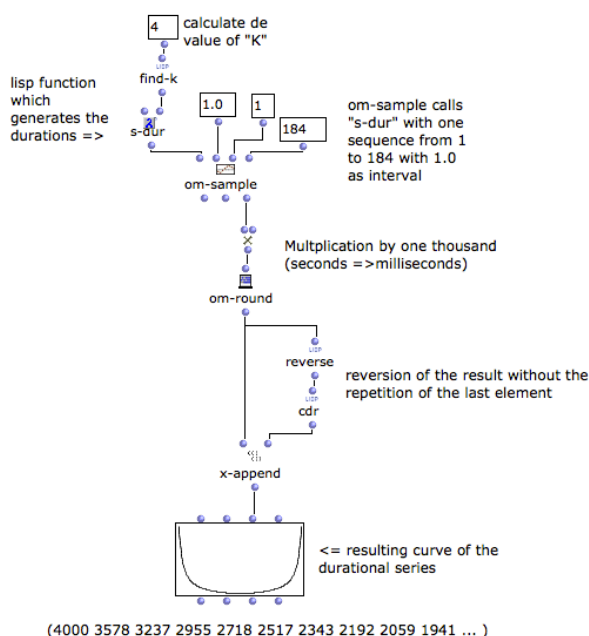
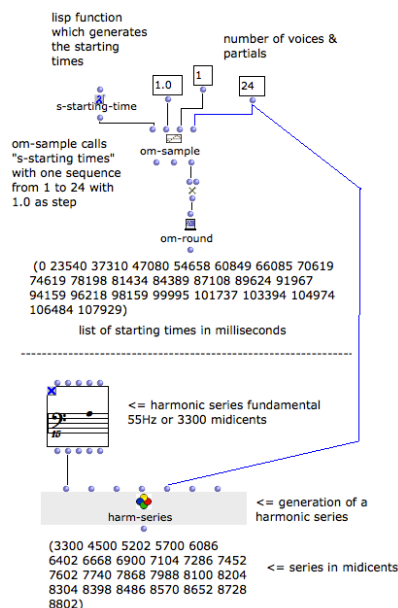

**Figure 3.** Generating the series of durations for *Spectral CANON for CONLON Nancarrow* in OpenMusic. The *s-dur* and *find-k* modules at the top of the figure refer to the functions implementing respectively the formulas for the series and first duration given in section 2.2.

Music is a visual programming language allowing to define and connect together functions and data structures in graphical programs, and to evaluate these programs to produce and transform musical data.

From the specifications given above we can easily implement functions in OpenMusic to generate the durations for one voice of the canon and to determine *k* for any chosen value for the first duration. The process of retrogradation is also implemented by simply appending the resulting series of durations with its reversion. This whole process is illustrated in Figure 3. Figure 4 shows the computation of the voices' entry times and of the pitches via the implementation of the specification given in section 2.3, and using an harmonic series generator for the pitches.

Starting from this implementation of the canon's generative process, we build a global model allowing to generate the piece, and highlighting a number of parameters identified in the previous sections: first duration of the series, pitch fundamental, number of voices, number of elements in the series, application (or not) of the retrograde, etc. (see Figure 5). These parameters (and others to be described in the next sections) will allow us to control and generate the score instances. With Tenney's original parameters, we obtain the score in Figure 6.



**Figure 4.** Computation of the voice entries and pitches for *Spectral CANON for CONLON Nancarrow* in OpenMusic. The *s-starting-time* module at the left refers to the function calculating the voice entries as specified in section 2.3. The *harm-series* module calculates the *n* (here, 24) first partials or harmonics of a fundamental pitch.

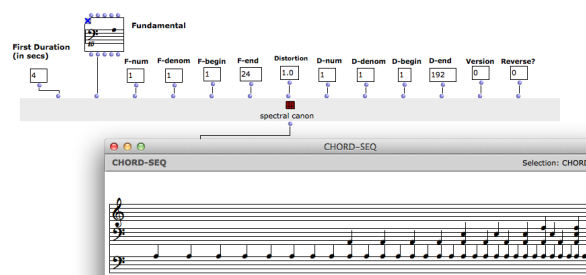

**Figure 5.** The model of *Spectral CANON for CONLON Nancarrow* in OpenMusic. The *spectral canon* box is an abstraction containing the previous implemented aspects of the canon.

## 4. EXPLORING THE MODEL

### 4.1 Compositional Choices and Parameters of the Models

Through the parametrization of the model we can explore the implication of the decisions and choices made by the composer at creating the piece.

We can for instance examine the compromise of an initial duration of 4 seconds, and the number of elements in the series of durations (184) related to the number of voices. Thanks to the modeling process, every simulation produces musical data structures (scores) which can be stored, visualized and listened in the computer environment. Quantitative elements of analysis could be for instance the total duration of the resulting score and the minimal (last) duration in a given parametrized sequence.

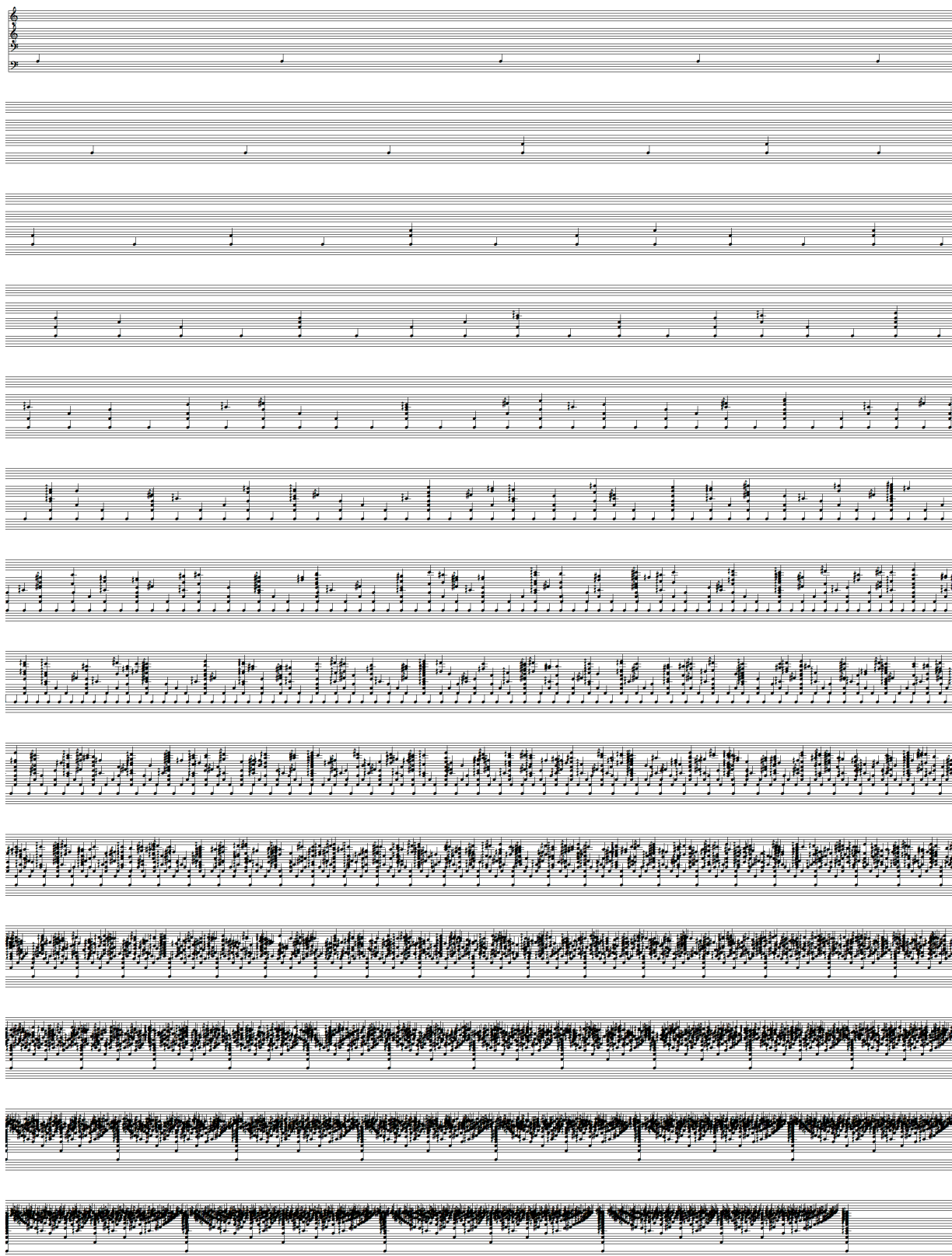

**Figure 6.** Complete score of the original version of *Spectral Canon For Conlon Nancarrow* generated from the implementation of the model, without any score edition. Interested readers can compare with the published score [11].

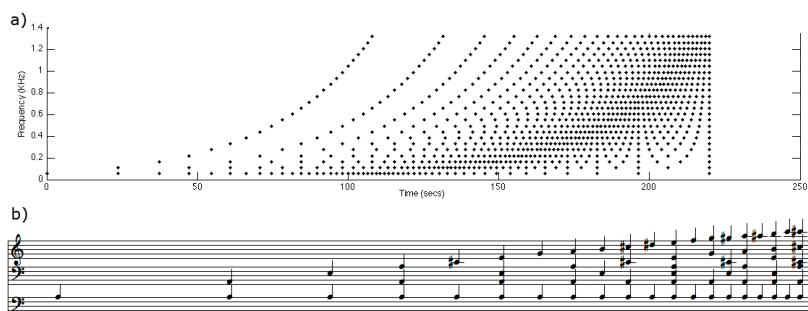

**Figure 7.** An instance of the canon with initial ratio of 2:1. a) Schematic 2D visualization of the pitches and onsets. b) Beginning of the score.

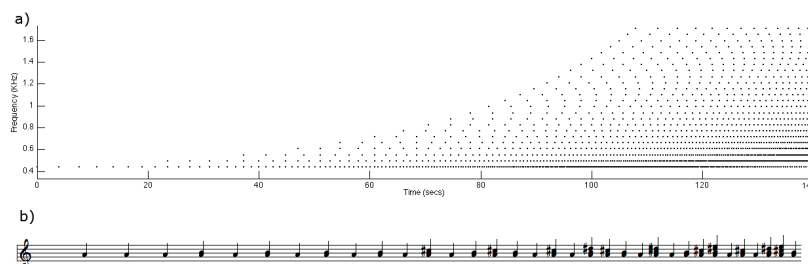

**Figure 8.** An instance of the canon beginning the harmonic series with the interval 9:8. a) Schematic 2D visualization of the pitches and onsets (0''-140''). b) Excerpt of the score from (appx. 44'' to 60'').

With Tenney’s values, we obtain at total duration around 216 seconds, and a minimal duration for the last element in the series of about 176 ms. This minimal value is still long enough for a sensible perceptual appreciation, and generally speaking the acceleration and subsequent *ritardando* have an adequate variation rate to keep the attention from the listener. This would not be the case, for instance, with an initial duration of more than 6 or less than 3 seconds. (see [7] for a deeper discussion about the perception of continuous accelerations). Experiments in varying these parameters (while maintaining the others) actually show very few interesting score results: we therefore suppose that Tenney’s choices for these values correspond to some kind of an ideal state for the model.

A more flexible parameter to explore through the model is the initial superparticular number at the origin of the series of durations’ formula. As we have seen, Tenney begins the series of durations with the eighth interval of the harmonic series (corresponding to the ratio 9:8), when he could have chosen any of them, including the first one (2:1, the octave). By tuning this initial value as a parameter in our implementation, we can experiment with possible variations. Figure 7 shows an instance of the piece generated with an initial ratio of 2:1. This ratio equals the initial one used for the series of frequencies and voice entries.<sup>2</sup>

We see that while the piece is equally well structured, its texture in the “forward segment” is more of a “choral” (i.e., mostly constituted of chords and/or synchronized attacks) than the polyrhythmic texture that Tenney was probably

<sup>2</sup> This configuration gives us a more compact version of the piece. For a better visualisation, we will use this 2:1 ratio in the other examples given later on in this paper.

looking for in his homage to Nancarrow.

In Figure 8 at the contrary, we keep the initial 9:8 ratio for the series of durations, but we apply it for the pitches as well, so that the first pitch of the first voice is not the fundamental but the the eighth partial in the harmonic series. In this case, however, we see that pitch ambitus becomes too narrow and the canon loses most of its timbre richness and perceptual features (although this can be of an aesthetic interest, or compensated with the manipulation of other parameters).

## 4.2 Generalizing the model

A second step in our modeling and simulation approach, enabled by the computer implementation, is to explore and modify the functional definitions in its generative processes. In particular for Tenney’s canon, we can integrate additional “spectral” processes such as filtering and distortion, and expand the realm of the possible instances produced by this model, yet still driven by the same compositional concepts. These two examples are envisaged below.

### 4.2.1 Spectral distortion.

The interest in spectral distortion comes from the well-know fact that the overtone series we calculate is actually an ideal model, which is rarely found as such in natural phenomena. In the sounds of acoustic instruments, partials usually deviate more or less from the exact multiples of the perceived pitch or fundamental (this distortion is easy to hear in the low notes of the piano). To model the spectral distortion we use the formula:

$$partial = fundamental \cdot rank^{dist}$$

A distortion index  $dist < 1$  causes a compression of the harmonic series, and at the contrary  $dist > 1$  causes a dilatation of the series. (see also [6], p. 93).

In our model of Tenney's *Spectral Canon*, and following the principle of correspondence between pitches and durations, we use this formula to compute the harmonic and duration series, as well as the voice offsets (in order to stay in the "default" configuration, we simply set  $dist = 1$ ). This extension of the model enables slight deviations in the voices entries, sweetening the mechanical character of the polyrhythms in the *accelerando* and changing our perception of the harmonic intervals. More radical deviations from the default configuration lead to surprising, unexpected versions of the piece. Figures 9 and 10 are examples of the possible results of these distortions.

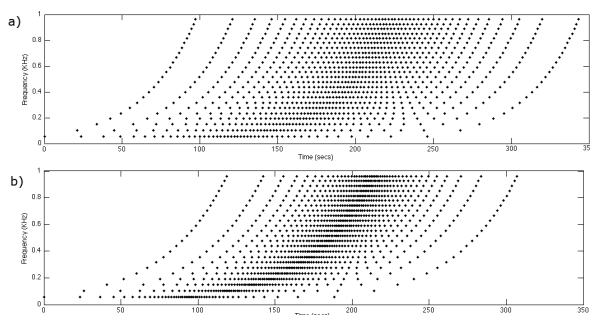

**Figure 9.** Slight distortions of the canon. a)  $dist = 0.9$ ; b)  $dist = 1.1$ . Both examples have 24 voices and begin the series of durations with the ratio 2:1.

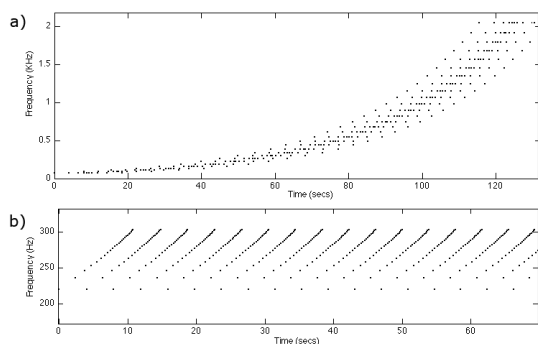
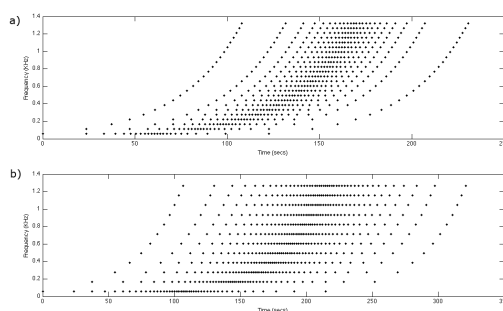

**Figure 10.** Extreme distortions of the canon. a)  $dist = 2.5$ ; b)  $dist = 0.1$ . In this case the canon is perceived as a sequence of repeating patterns.

While maintaining the relative integrity of the model, the distortion either moves the voices entries and durations nearer to the beginning of the piece, or away from it. It is therefore likely compensate some undesirable effects produced by other previous choices in the model parametrization (e.g. the duration of the first note in the series).

#### 4.2.2 Filtering.

Another possibility for expanding the model is the filtering of the series. This procedure, commonly used in the the



**Figure 11.** Illustration of the filtering process. a) Durations (filter = 1/2), and b) pitches (harmonic series) (filter = 1/2). (a) has 24 voices, and (b) has 12 voices. In both instances the initial ratio of the series of durations is 2:1.

harmonic domain, can also apply to the duration series in the canon.

The filtering of harmonic series is present as an option in the OpenMusic function *harm-series*<sup>3</sup> which we used to compute the pitches in our model (see Figure 4). In this function partials can be selected according to a pair of attributes given in the form of a fractional expression (for instance, 1/1 selects all partials; 1/2 selects every other partial; 2/5 selects the first two partials of each group of five, etc.) We therefore added this feature and corresponding parameters in our model (see Figure 5). In the default configuration the two filtering parameters are both equal to 1, hence selecting all the partials and all the elements in the duration series. Figure 11 shows two instances of the canon, generated respectively with the duration and frequency filtering processes.

## 5. CONCLUSION

We showed with the example of James Tenney's *Spectral Canon* that the modeling and simulation of a work could bring new light on its internal processes, and reveals that the potentialities of a piece are not necessarily limited to the composer's version of the score. In our approach, the model is a fundamental means toward the more comprehensive understanding of the musical work: At each step we give towards the complete implementation, we can inquire compositional choices with the advantage of easily simulating the results. Our work distinguishes itself from the conventional approaches in musicology where analysis and composition are two different disciplines. It leads us to permanently rethink the model, its parameters and their relative configurations, which enables creativity and dynamism in the musicological process.

*Spectral CANON For CONLON Nancarrow* is a relatively simple composition illustrating important aspects in our approach, which we believe constitutes a relevant basis

<sup>3</sup> *Harm-series* is a tool from the *Esquisse* library, developed by composers involved in the spectral school, such as Tristan Murail and Jean-Baptiste Barrière.

for the study of more complex works. Despite its apparent complexity, it can be generated entirely with relatively few simple functions, so that compositional decisions have a straightforward relations to the results. However, we showed how the concrete instances obtained from modifications of the functional processes and parameters could produce radically diverging aspects, forms and perceptive feelings.

An interesting aspect in computer modeling is the possibility to implement systematic approaches in the exploration of the different variations enabled by the model. By producing and observing exhaustive sets of instances produced by different parametrizations, we can test and evaluate until which point the characteristics of the piece, or of the composer's style or intention, is preserved. This question leads us to aesthetic considerations, whether or not the instances of a model are to be considered as part of the composer's work and which are their artistic and creative potentialities. The means and methodologies to explore this complexity in the compositional process, and its relation to the results' aesthetic and perceptive characteristics are some of the main challenges we plan to address in future works.

## 6. REFERENCES

- [1] Agon, C., Andreatta, M., Assayag, G., Schaub, S.: Formal Aspects of Iannis Xenakis "Symbolic Music": A Computer-Aided Exploration of Compositional Processes. *Journal of New Music Research*, 33(2) (2004)
- [2] Ahn Y.-K., Agon, C., Andreatta, M.: Structures Ia pour deux pianos by Boulez: towards creative analysis using OpenMusic and Rubato. *Proc. Mathematics and Computation in Music*, Berlin, Germany (2007)
- [3] Assayag, G., Rueda, C., Laurson, M., Agon, C., Delerue, O.: Computer assisted composition at IRCAM: From PatchWork to OpenMusic. *Computer Music Journal*, Vol. 23(3) (1999)
- [4] Bresson, J., Agon, C., Assayag, G.: OpenMusic. Visual Programming Environment for Music Composition, Analysis and Research. *Proc. ACM MultiMedia: OpenSource Software Competition*, Scottsdale, USA (2011)
- [5] Cowell H.: *New Musical Resources*. Cambridge University Press, (1996) (original edition: 1930)
- [6] Fineberg, J.: *Guide to the Basic Concepts and Techniques of Spectral Music*. *Contemporary Music Review*, Vol. 19(2). London: Routledge (2000)
- [7] Grisey, G.: Tempus ex Machina: A composer's reflections on musical time. *Contemporary Music Review*, Vol. 2(1) (1987)
- [8] Keller, D., Ferneyhough, B.: Analysis by Modeling: Xenakis ST/10-1 080262. *Journal of New Music Research*, Vol. 33(2) (2004)
- [9] Polansky, L.: The Early Works of James Tenney. In Garland, P. (ed.) *Soundings 13: The Music of James Tenney* (1983)
- [10] Riotte, A., Mesnage, M.: *Formalismes et modles musicaux* (2 volumes). Editions Delatour France (2006)
- [11] Tenney, J.: Spectral CANON for CONLON Nancarrow. In Byron, M. (Ed.) *Pieces: An anthology*, Vancouver : Aesthetic Research Centre (1976)
- [12] Wannamaker, R. A.: The spectral music of James Tenney. *Contemporary Music Review*, Vol. 27(1) (2008)