



HAL
open science

Actor Model of Computation for Scalable Robust Information Systems

Carl Hewitt

► **To cite this version:**

Carl Hewitt. Actor Model of Computation for Scalable Robust Information Systems: One computer is no computer in IoT. Carl Hewitt, John Woods. Inconsistency Robustness, 52, College Publications, 2015, Studies in logic, 978-1-84890-159-9. hal-01163534v5

HAL Id: hal-01163534

<https://hal.science/hal-01163534v5>

Submitted on 16 May 2016 (v5), last revised 11 Aug 2017 (v7)

HAL is a multi-disciplinary open access archive for the deposit and dissemination of scientific research documents, whether they are published or not. The documents may come from teaching and research institutions in France or abroad, or from public or private research centers.

L'archive ouverte pluridisciplinaire **HAL**, est destinée au dépôt et à la diffusion de documents scientifiques de niveau recherche, publiés ou non, émanant des établissements d'enseignement et de recherche français ou étrangers, des laboratoires publics ou privés.

Actor Model of Computation for Scalable Robust Information Systems

One computer is no computer in IoT

Carl Hewitt

This article is dedicated to Alonzo Church and Dana Scott.

Introduction

The Actor Model is a mathematical theory that treats “Actors” as the universal conceptual primitives of digital computation.

Hypothesis:ⁱ **All physically possible digital computation can be directly modeled using Actors.**

The model has been used both as a framework for a theoretical understanding of concurrency, and as the theoretical basis for several practical implementations of concurrent systems. Actors are direct and efficient:

- Digital computation can be efficiently implemented without loss of processing, communication, or storage efficiency
- Digital computation can be directly modeled without requiring extraneous elements, e.g., channels or registers.

The advent of massive concurrency through client-cloud computing and many-core computer architectures has galvanized interest in the Actor Model.

Message passing using types is the foundation of system communication:

- Messages are the unit of communication
- A message can be sent to an address, which has a Typeⁱⁱ

ⁱ This hypothesis is an update to [Church 1936] that all physically computable functions can be implemented using the lambda calculus. It is a consequence of the Actor Model that there are some computations that *cannot* be implemented in the lambda calculus.

ⁱⁱ Each type is an Actor. However, it may be the case that a type will work some places and not others. For example, to be used in message passing, the type of an address may require access to particular hardware. Also, types can provide security, *e.g.*, by using encryption.

When an Actor receives a message, it can concurrently:¹

- send messages to (unforgeable) addresses of Actors that it has;
- create new Actors;¹
- designate how to handle the next message it receives.

The Actor Model can be used as a framework for modeling, understanding, and reasoning about, a wide range of concurrent systems. For example:

- Electronic mail (e-mail) can be modeled as an Actor system. Mail accounts are modeled as Actors and email addresses as Actor addresses.
- Web Services can be modeled with endpoints modeled as Actor addresses.
- Objects with locks (e.g. as in Java and C#) can be modeled as Actors.
- Functional and Logic programs can be implemented using Actors.

Actor technology will see significant application for coordinating all kinds of digital information for individuals, groups, and organizations so their information usefully links together.

Information coordination needs to make use of the following information system principles:

- **Persistence.** *Information is collected and indexed.*
- **Concurrency:** *Work proceeds interactively and concurrently, overlapping in time.*
- **Quasi-commutativity:** *Information can be used regardless of whether it initiates new work or become relevant to ongoing work.*
- **Sponsorship:** *Sponsors provide resources for computation, i.e., processing, storage, and communications.*
- **Pluralism:** *Information is heterogeneous, overlapping and often inconsistent. There is no central arbiter of truth.*
- **Provenance:** *The provenance of information is carefully tracked and recorded.*

The Actor Model is intended to provide a foundation for inconsistency robust information coordination. Inconsistencyⁱⁱ robustness is information system performance² in the face of continual pervasive inconsistencies.ⁱⁱⁱ Inconsistency robustness is both an observed phenomenon and a desired feature.

ⁱ with new addresses

ⁱⁱ An inference system is *inconsistent* when it is possible to derive both a proposition and its negation.

A *contradiction* is manifest when both a proposition and its negation are asserted even if by different parties, e.g., New York Times said “*Snowden is a whistleblower.*”, but NSA said “*Snowden is not a whistleblower.*”

ⁱⁱⁱ a shift from the previously dominant paradigms of inconsistency denial and inconsistency elimination, i.e., to sweep inconsistencies under the rug.

The Actor Model is a mathematical theory of computation that treats “Actors” as the universal conceptual primitives of concurrent digital computation [Hewitt, Bishop, and Steiger 1973; Hewitt 1977]. The model has been used both as a framework for a theoretical understanding of concurrency, and as the theoretical basis for several practical implementations of concurrent systems.

Unlike previous models of computation, the Actor Model was inspired by physical laws. It was also influenced by programming languages such as, the lambda calculusⁱ, Lisp [McCarthy *et. al.* 1962], Simula-67 [Dahl and Nygaard 1967] and Smalltalk-72 [Kay 1975], as well as ideas for Petri Nets [Petri 1962], capabilities systems [Dennis and van Horn 1966] and packet switching [Baran 1964]. The advent of massive concurrency through client-cloud computing and many-core computer architectures has galvanized interest in the Actor Model [Hewitt 2009b].

It is important to distinguish the following:

- modeling arbitrary computational systems using Actors.ⁱⁱ It is difficult to find physical computational systems (regardless of how idiosyncratic) that cannot be modeled using Actors.
- securely implementing practical computational applications using Actors remains an active area of research and development.

Decoupling the sender from the communications it sends was a fundamental advance of the Actor Model enabling asynchronous communication and control structures as patterns of passing messages [Hewitt 1977].

An Actor can only communicate with another Actor to which it has an address. Addresses can be implemented in a variety of ways:

- direct physical attachment
- memory or disk addresses
- network addresses
- email addresses

The Actor Model is characterized by inherent concurrency of computation within and among Actors, dynamic creation of Actors, inclusion of Actor addresses in messages, and interaction only through direct asynchronous message passing with no restriction on message reception order.

ⁱ In general Actor systems can be exponentially faster than the parallel lambda calculus.

ⁱⁱ An Actor can be implemented directly in hardware.

The Actor Model differs from its predecessors and most current models of computation in that the Actor Model assumes the following:

- Concurrent execution in processing a message.
- The following are *not* required by an Actor: a thread, a mailbox, a message queue, its own operating system process, *etc.*ⁱ
- Message passing has the same overhead as looping and procedure calling.
- Primitive Actors can be implemented in hardware.ⁱⁱ

The Actor Model can be used as a framework for modeling, understanding, and reasoning about, a wide range of concurrent systems.

For example:

- Electronic mail (e-mail) can be modeled as an Actor system. Mail accounts are modeled as Actors and email addresses as Actor addresses.
- Web Services can be modeled with SOAP endpoints modeled as Actor addresses.
- Objects with locks (*e.g.* as in Java and C#) can be modeled as Actors.

Direct communication and asynchrony

The Actor Model is based on one-way asynchronous communication. Once a message has been sent, it is the responsibility of the receiver.³

Messages in the Actor Model are decoupled from the sender and are delivered by the system on a best efforts basis.⁴ This was a sharp break with previous approaches to models of concurrent computation in which message sending is tightly coupled with the sender and sending a message synchronously transfers it someplace, *e.g.*, to a buffer, queue, mailbox, channel, broker, server, *etc.* or to the “*ether*” or “*environment*” where it temporarily resides. The lack of synchronicity caused a great deal of misunderstanding at the time of the development of the Actor Model and is still a controversial issue.

Because message passing is taken as fundamental in the Actor Model, there cannot be any required overhead, *e.g.*, any requirement to use buffers, pipes, queues, classes, channels, *etc.* Prior to the Actor Model, concurrency was defined in low level machine terms.

ⁱ For example, if an Actor were required to have a mailbox then, the mailbox would be an Actor that is required to have its own mailbox...

ⁱⁱ In some cases, this involves (clocked) one-way messages so message guarantees and exception processing can be different from typical application Actors.

It certainly is the case that implementations of the Actor Model typically make use of these hardware capabilities. However, there is no reason that the model could not be implemented directly in hardware without exposing any hardware threads, locks, queues, cores, channels, tasks, *etc.* Also, there is no necessary relationship between the number of Actors and the number threads, cores, locks, tasks, queues, *etc.* that might be in use. Implementations of the Actor Model are free to make use of threads, locks, tasks, queues, coherent memory, transactional memory, cores, *etc.* in any way that is compatible with the laws for Actors [Baker and Hewitt 1977].

As opposed to the previous approach based on composing sequential processes, the Actor Model was developed as an inherently concurrent model. In the Actor Model sequential ordering is a special case that derived from concurrent computation. Also, the Actor Model is based on communication rather than a global state space as in Turing Machines, CSP [Hoare 1978], Java [Sun 1995, 2004], C++11 [ISO 2011], X86 [AMD 2011], *etc.* The Actor Model does *not* take classical sequential processes as primitive and is *not* built on communicating sequential processes.

A natural development of the Actor Model was to allow Actor addresses in messages. A computation might need to send a message to a recipient from which it would later receive a response. The way to do this is to send a communication which has the message along with the address of another Actor called the *customer* along with the message. The recipient could then cause a response message to be sent to the customer.

Indeterminacy and Quasi-commutativity

The Actor Model supports indeterminacy because the reception order of messages can affect future behavior.

Operations are said to be quasi-commutative to the extent that it doesn't matter in which order they occur. To the extent possible, quasi-commutativity is used to reduce indeterminacy.

Locality and Security

Locality and security are important characteristics of the Actor Model [Baker and Hewitt 1977].⁵

Locality and security mean that in processing a message: an Actor can send messages only to addresses for which it has information by the following means:

1. that it receives in the message
2. that it already had before it received the message
3. that it creates while processing the message.

In the Actor Model, there is no hypothesis of simultaneous change in multiple locations. In this way it differs from some other models of concurrency, *e.g.*, the Petri net model in which tokens are simultaneously removed from multiple locations and placed in other locations.

That there be no single point of failure can be an important aspect of security.

The security of Actor systems can be protected in the following ways:

Strong personal authentication, *e.g.*, using (3D) continuous interactive bio-authentication instead of passwords

Strong, ubiquitous public key authentication so that it can be verified to whom a public key corresponds. Often this authentication can be performed by local bank offices, *etc.* that publish online multi-national directories of public keys in a network of mistrust. Individual citizens can have their own directories of public keys that are used to automatically and invisibly securely communicate with others.

Many citizens will have more than one authenticated public key, which can be authenticated with various levels of security.

Public keys for IoT ownership so that an IoT device has both:

- a public key of its owner, which is installed when ownership is transferred
- its own unique public/private key pair, which is created internally when acquired by the first owner.

An owner can communicate securely with a device by encrypting information using the device's public key. (For efficiency reasons, most communication will actually be performed using symmetric keys encrypted/signed by public keys.) A device takes instructions only from its owner and is allowed to communicate with the external world only through the information coordination system of its owner. The nonprofit Standard IoT Foundation is working to develop standards based on the Actor Model of computation that provide for interoperation among existing and emerging consortium and proprietary corporate IoT standards.

Hardware architecture security

To help cope with the complexity of software systems that can never be made highly secure without hardware assistance including the following:

- *RAM-processor package encryption* (*i.e.* all traffic between a processor package and RAM is encrypted using a uniquely generated key when a package is powered up and which is invisible to all software) to protect an app (*i.e.* a user application, which is technically a process) from the following:
 - operating systems and hypervisors
 - other apps
 - other equipment, e.g., baseband processors, disk controllers, and USB controllers.
- *Hardware Actors* that communicate only using message passing to protect security registers
- *Every-word-tagged architecture* to protect an Actor in an app from other Actors by using a tag on each word of memory that controls how the memory can be used. Each Actor is protected from reading and/or writing by other Actors in its process. Actors can interact only by sending a message to the unforgeable address of another Actor. Existing software (e.g., operating systems, browsers, mail systems) will need to be upgraded to use tags.

A delicate point in the Actor Model is the ability to synthesize the address of an Actor. In some cases security can be used to prevent the synthesis of addresses in practice using the following:

- every-word-tagged memory
- signing and encryption of messages

Islets™

Sensitive citizen information is nonpublic information revelation of which can potentially harm a citizen, such as medical (including psychiatric), legal, financial, sexual, political, and religious. For example, the FBI tapped into conversations between Robert Oppenheimer and his lawyer during the hearing designed to humiliate him by having his security clearance removed in order to punish him for some of his political views. Also, the FBI COINTELPRO program persecuted thousands, such as gay people, almost all groups protesting the Vietnam War, and organizations and individuals associated with the women's rights movement. Furthermore, the FBI recorded conversations between Martin Luther King and his mistresses and then used the information to blackmail him suggesting that he commit suicide in order to avoid exposure. Likewise, maintaining files on millions of East Germans, the Stasi secretly ruined the lives of tens of thousands.[Funder 2011]

Islets is a system in which a citizen's sensitive information is stored locally in their own equipment (without backdoors). Information (encrypted with citizen keys) in an Islet can be shared among devices. Islets must be robust against the failure of devices at any time. Also, Islet information can be backed up elsewhere automatically encrypted using the citizen's public keys including using commercial datacenters and distributed on other citizens' equipment. Furthermore, a citizen can share Islet information that they select with others (automatically encrypted with the public keys of other parties so that it be read only by the intended recipient).

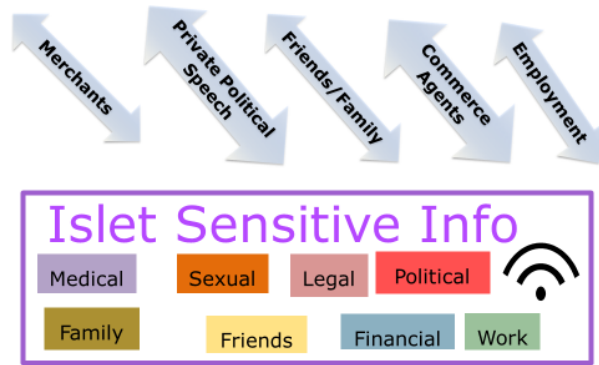

Islet™ Information Coordination and Interaction

An Islet can provide additional capabilities that are not currently available for coordinating and interacting with citizens' IoT including *commerce* (home, retail, food, travel, auto, etc.), *wellness* (recreation, biometrics, nutrition, exercise, spirituality, medical, learning, etc.), *Finance* (banking, investments, taxes, etc.), *IoT* (food management, security, energy management, infotainment, transportation, communication, etc.), *Social* (schedule, friends, family, etc.), and *Work* (contacts, schedule, colleagues, etc.).

An Islet can run on multiple citizen devices such as cell phones, refrigerators, insulin pumps, bedroom TVs, brain implants, and home routers. These devices are connected only intermittently and some of them may fail permanently. Consequently an Islet must deal with asynchronously-arriving information from various devices and from the outside Internet. Fortunately, Actors provide a suitable foundation for modeling and implementing Islets.

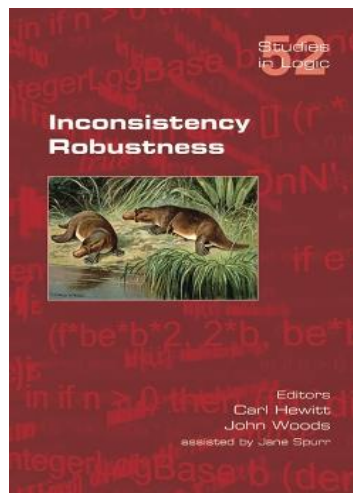

Classical logic (a foundation for relational databases) and probability theory do *not* provide a suitable foundation for IoT information coordination because a single (hidden) inconsistency can cause

incorrect reasoning. Fortunately, recent advances in the development of inconsistency-robust information systems technology can be used to more safely reason about pervasively inconsistent information (even without knowing which pieces of information might be inconsistent).

Islets offer lower communications cost because it is not necessary to always communicate with datacenters. It can also provide faster response and more robustness because local operations can be faster and more reliable than always interacting with potentially overloaded datacenters. Better protection of a citizen's sensitive information is possible because it is not always available in datacenters accessible by security agencies. Attempting to provide coordination and interaction services for a citizen by patching together datacenter services from fierce competitors⁶ is much more difficult than using an Islet. Further cyberlocalism can provide improved coordination between customers and merchants with more relevant and less intrusive advertising as well as better coordination between a customer and competing merchants

Islets might never come to fruition unless it is supported by a business model that is more efficient and effective than the currently popular system of Datacenterism based on the consumer surveillance and influence business model. Consequently, the Standard IoT™ international, nonprofit standards organization has proposed Islets™ information coordination systems as the foundational basis for information coordination and interaction services for a citizen's sensitive IoT information. Each Islet can be hosted on a citizen's own equipment, such as routers, body-sensor computer networks, refrigerators, car, cell phones, TVs, autos, and PC.

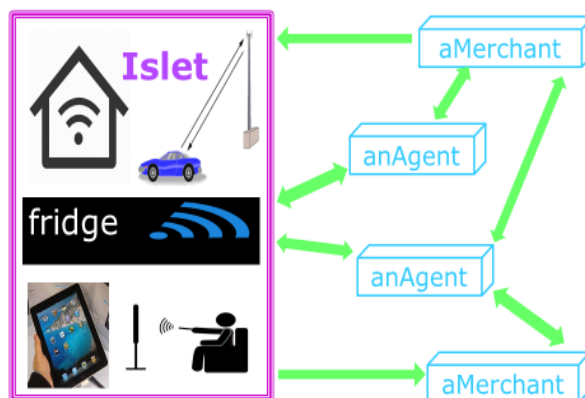

**Islet Coordinating with Agents and Merchants
Business Model**

Recent advances in the development of inconsistency-robust information systems technology can be used to facilitate new business implementations that are more *effective*, *pervasive*, and *profitable* by improving interactions among consumers and merchants because consumers would no longer be continually hassled by intrusive unwanted advertisements. Instead, an Islet

running on a consumer's equipment can provide the ability to seek and help evaluate appropriate offers from commerce agents for their purchases. Commerce agents can earn commissions and fees from merchants when a citizen uses the referrals. Also, merchants would no longer be burdened by having to pay for *grossly inefficient* advertising that annoys potential customers. Instead, businesses can provide their information to commerce agents that aggregate and package it for a citizen's' Islet to be used in evaluating offers. Again, commerce agents can earn commissions and fees from merchants from referrals. Of course, all of the convenience that is currently available must also be available so that an Islet can access the Internet to provide scalable search, retrieval, and collaboration using commercial datacenters in cooperation with other citizens' equipment.

Robustness in Runtime Failures

Runtime failures are always a possibility in Actor systems and are dealt with by runtime infrastructures. Message acknowledgement, reception, and responseⁱ cannot be guaranteed although best efforts are made. Consequences are cleaned up on a best-effort basis.

Robustness is based on the following principle:⁷

If an Actor is sent a request, then the continuation *must* be one of the following two mutually exclusive possibilities:

1. to process the responseⁱⁱ resulting from the recipient receiving the request
2. to throw a **Messaging**ⁱⁱⁱ exception^{iv}

Just sitting there forever after a request has been sent is a silent failure, which is unacceptable. So, in due course, the infrastructure must throw a **Messaging** exception as governed by the policies in place^v if a response (return value or exception) to the request has not been received.

Ideally, if the continuation of sending a request is to throw a **Messaging** exception, then the sender of a response to the request also receives a **Messaging** exception saying that the response could not be processed.

ⁱ a response is either a returned value or a thrown exception

ⁱⁱ conceptually processed by a customer Actor sent in the request

ⁱⁱⁱ A **Messaging** exception can have information concerning the lack of response

^{iv} even though the recipient may have received the request and sent a response that has not yet been received by the customer of the request. Requestors need to be able to interact with infrastructures concerning policies to be applied concerning when to generate **Messaging** exceptions.

^v For example, several standard deviations have passed in the expected time to receive a response.

If desired, things can be arranged so that **Messaging** exceptions are very special and can be distinguished from all other exceptions.

Scalability and Modularity

ActorScript™ is a general purpose programming language for implementing iAdaptive™ concurrency that manages resources and demand. It is differentiated from previous languages by the following:

- **Universality**
 - Ability to directly specify what Actors can do
 - Specify interface between hardware and software
 - Everything in the language is accomplished using message passing including the very definition of ActorScript itself.
 - Functional, Imperative, Logic, and Concurrent programming are integrated. Concurrency can be dynamically adapted to resources available and current load.
 - Programs do not expose low-level implementation mechanisms such as threads, tasks, channels, coherent memory, location transparency, throttling, load balancing, locks, cores, *etc.* Messages can be directly communicated without requiring indirection through brokers, channels, class hierarchies, mailboxes, pipes, ports, queues *etc.* Variable races are eliminated.
 - Binary XML and JSON are data types.
 - Application binary interfaces are afforded so that no program symbol need be looked up at runtime.
- **Safety and security**
 - Programs are extension invariant, i.e., extending a program does not change its meaning.
 - Applications cannot directly harm each other.
- **Performance**
 - Impose no overhead on implementation of Actor systems
 - Message passing has essentially same overhead as procedure calling and looping.
 - Execution dynamically adjusted for system load and capacity (*e.g.* cores)
 - Locality because execution is not bound by a sequential global memory model
 - Inherent concurrency because execution is not bound by communicating sequential processes
 - Minimize latency along critical paths

ActorScript attempts to achieve the highest level of performance, scalability, and expressibility with a minimum of conceptual primitives.

Scalable information Coordination

Technology now at hand can coordinate all kinds of digital information for individuals, groups, and organizations so their information usefully links together. This coordination can include calendars and to-do lists, communications (including email, SMS, Twitter, Facebook), presence information (including who else is in the neighborhood), physical (including GPS recordings), psychological (including facial expression, heart rate, voice stress) and social (including family, friends, team mates, and colleagues), maps (including firms, points of interest, traffic, parking, and weather), events (including alerts and status), documents (including presentations, spreadsheets, proposals, job applications, health records, photos, videos, gift lists, memos, purchasing, contracts, articles), contacts (including social graphs and reputation), purchasing information (including store purchases, web purchases, GPS and phone records, and buying and travel habits), government information (including licenses, taxes, and rulings), and search results (including rankings and ratings).

Connections

Information coordination works by making connections including examples like the following:

- A statistical connection between “being in a traffic jam” and “driving in downtown Trenton between 5PM and 6PM on a weekday.”
- A terminological connection between “MSR” and “Microsoft Research.”
- A causal connection between “joining a group” and “being a member of the group.”
- A syntactic connection between “a pin dropped” and “a dropped pin.”
- A biological connection between “a dolphin” and “a mammal”.
- A demographic connection between “undocumented residents of California” and “7% of the population of California.”
- A geographical connection between “Leeds” and “England.”
- A temporal connection between “turning on a computer” and “joining an on-line discussion.”

By making these connections iInfo™ information coordination offers tremendous value for individuals, families, groups, and organizations in making more effective use of information technology.

Information Coordination and Action Principles

In practice, coordinated information is invariably inconsistent.⁸ Therefore iInfo must be able to make connections even in the face of inconsistency.⁹ The business of iInfo is not to make difficult decisions like deciding the ultimate truth or probability of propositions. Instead it provides means for processing information and carefully recording its provenance including arguments (including arguments about arguments) for and against propositions.

Information coordination needs to make use of the following principles:

- **Persistence.** *Information is collected and indexed and no original information is lost.*
- **Concurrency:** *Work proceeds interactively and concurrently, overlapping in time.*
- **Quasi-commutativity:** *Information can be used regardless of whether it initiates new work or become relevant to ongoing work.*
- **Sponsorship:** *Sponsors provide resources for computation, i.e., processing, storage, and communications.*
- **Pluralism:** *Information is heterogeneous, overlapping and often inconsistent. There is no central arbiter of truth*
- **Provenance:** *The provenance of information is carefully tracked and recorded*

Interaction creates Reality¹⁰

*a philosophical shift in which knowledge is no longer treated primarily as referential, as a set of statements **about** reality, but as a practice that interferes with other practices. It therefore participates **in** reality.*

Annemarie Mol [2002]

Relational physics takes the following view [Laudisa and Rovelli 2008]:ⁱ

- Relational physics discards the notions of absolute state of a system and absolute properties and values of its physical quantities.
- State and physical quantities refer always to the interaction, or the relation, among multiple systems.
- Nevertheless, relational physics is a complete description of reality.

According to this view, **Interaction creates reality.** Information systems participate in this reality and thus are both consequence and cause.

Actor systems can be organized in higher level structures to facilitate operations.

Organizational Programming using iOrgs

The Actor Model supports Organizational Programming that is based on authority and accountability in iOrgs [Hewitt 2008a] with the goal of becoming an effective readily understood approach for addressing scalability issues in Software Engineering. The paradigm takes its inspiration from human

ⁱ According to [Rovelli 1996]: *Quantum mechanics is a theory about the physical description of physical systems relative to other systems, and this is a complete description of the world.*

[Feynman 1965] offered the following advice: *Do not keep saying to yourself, if you can possibly avoid it, "But how can it be like that?" because you will go "down the drain," into a blind alley from which nobody has yet escaped.*

organizations. iOrgs provide a framework for addressing issues of hierarchy, authority, accountability, scalability, and robustness using methods that are analogous to human organizations. Because humans are very familiar with the principles, methods, and practices of human organizations, they can transfer this knowledge and experience to iOrgs. iOrgs achieve scalability using methods and principles similar to those used in human organizations. For example an iOrg can have sub-organizations specialized by areas such as sales, production, and so forth. Authority is delegated down the organizational structure and when necessary issues are escalated upward. Authority requires accountability for its use including record keeping and periodic reports. Management is in large part the art of reconciling authority and accountability.

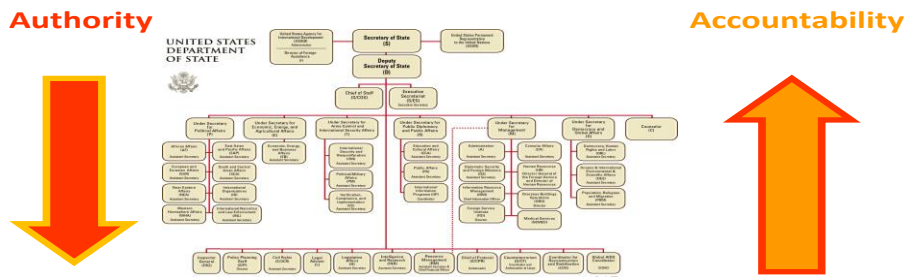

Collaboration

Organizational Programming for iOrgs

iOrgs are structured around *organizational commitment* defined as information pledged constituting an alliance to go forward. For example, iOrgs can use contracts to formalize their mutual commitments to fulfill specified obligations to each other.

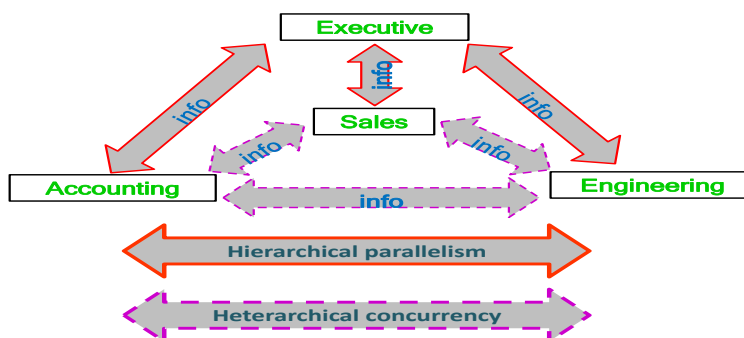

Scalability of iOrgs

Yet, manifestations of information pledged will often be inconsistent. Any given agreement might be internally inconsistent, or two agreements in force at one time could contradict each other.



Inconsistency by Design for iOrgs

Issues that arise from such inconsistencies can be negotiated among iOrgs. For example the Sales department might have a different view than the Accounting department as to when a transaction should be booked.

A fundamental goal of Inconsistency Robustness is to effectively reason about large amounts of information at high degrees of abstraction:

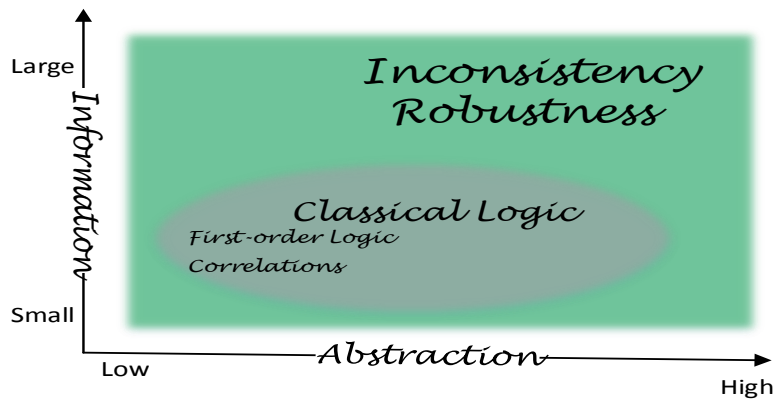

Classical logic is safe only for theories for which there is strong evidence of consistency.

Actor Addresses and Implementations

Actor addresses have types. For example the type **Account** has the following interface description:

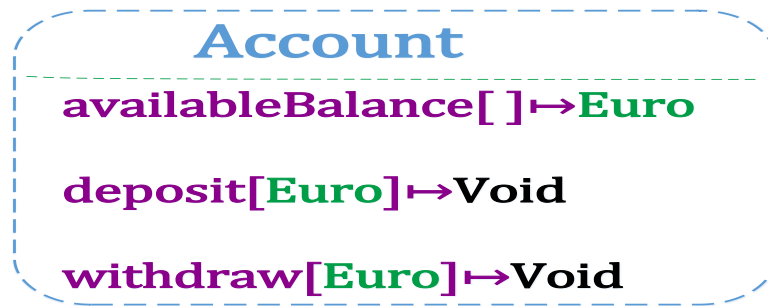

Message Passing

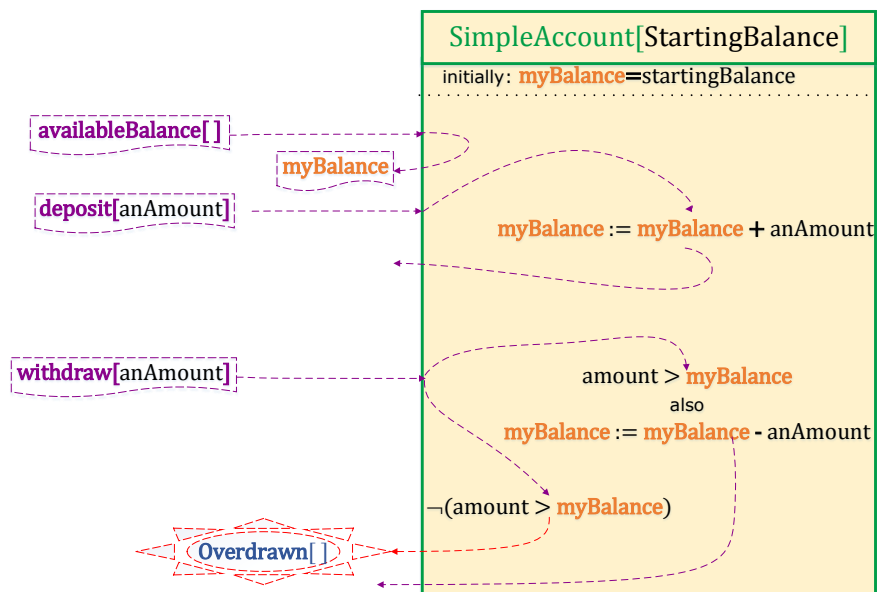

Computational Representation Theorem

The *Computational Representation Theorem* [Clinger 1981; Hewitt 2006]ⁱ¹ characterizes computation for systems which are closed in the sense that they do not receive communications from outside:

The denotation Denote_S of a closed system S represents all the possible behaviors of S as

$$\text{Denote}_S = \lim_{i \rightarrow \infty} \text{Progressions}_S^i$$

where Progressions_S takes a set of partial behaviors to their next stage, i.e., $\text{Progressions}_S^i \rightarrow^i \text{Progressions}_S^{i+1}$

In this way, S can be mathematically characterized in terms of all its possible behaviors (including those involving unbounded nondeterminism).ⁱⁱ

The denotations form the basis of constructively checking programs against all their possible executions,ⁱⁱⁱ

A consequence of the Computational Representation Theorem is that there are uncountably many different Actors.

For example, $\text{Real}_\bullet[\]$ can output any real number between 0 and 1 where

$$\text{Real}_\bullet[\] \equiv [(0 \text{ either } 1), \forall \text{Postpone } \text{Real}_\bullet[\]]$$

such that

- $(0 \text{ either } 1)$ is the nondeterministic choice of 0 or 1
- $[\text{first}, \forall \text{rest}]$ is the list that begins with `first` and whose remainder is `rest`
- **Postpone** expression delays execution of expression until the value is needed.

The upshot is that *concurrent systems can be axiomatized using mathematical logic^{iv} but in general cannot be implemented*. Thus, the following practical problem arose:

How can practical programming languages be rigorously defined since the proposal [Scott and Strachey 1971, Milne and Strachey 1976] to define them in terms lambda calculus failed because the lambda calculus cannot implement concurrency?¹²

A proposed answer to this question is the semantics of ActorScript [Hewitt 2010].

ⁱ read as “can evolve to”

ⁱⁱ There are no messages in transit in Denote_S

ⁱⁱⁱ a restricted form of Model Checking in which the properties checked are limited to those that can be expressed in Linear-time Temporal Logic has been studied [Clarke, Emerson, Sifakis, *etc.* ACM 2007 Turing Award]

^{iv} including the lambda calculus

Using Implementations versus Interface Extension

Programming languages like ActorScript [Hewitt 2010] take the approach of extending behavior in contrast to the approach of specializing behavior:

- Using implementations: An implement type can make use of other implementations. However, an implementation cannot be subtyped because it is branded to guarantee its behavior that might be violated by subtypes. Consequently, Actors automatically vacuously have the substitution property [Liskov 1987, Liskov and Wing 2001] for implementations.
- Interface extension: A type interface can be extended to have additional message signatures from the type interface that it extends. In general, a system cannot guarantee properties of implementations of an interface type. Consequently, the substitution property may not hold even for Actors that implement the *same* interface.

Language constructs versus Library APIs

Library Application Programming Interfaces (APIs) are an alternative way to introduce concurrency.

For example,

- A limited version of futures [Baker and Hewitt 1977] have been introduced in C++11 [ISO 2011].
- Message Passing Interface (MPI) [Gropp et. al. 1998] provides some ability to pass messages.
- Grand Central Dispatch provides for queuing tasks.

There are a number of library APIs for Actor-like systems.

In general, appropriately defined language constructs provide greater power, flexibility, and performance than library APIs.¹³

Reasoning about Actor Systems

The principle of Actor induction is:

1. Suppose that an Actor x has property P when it is created
2. Further suppose that if x has property P when it receives a message, then it has property P when it receives the next message.
3. Then x always has the property P .

In his doctoral dissertation, Aki Yonezawa developed further techniques for proving properties of Actor systems including those that make use of migration. Russ Atkinson developed techniques for proving properties of Actors that are guardians of shared resources. Gerry Barber's 1981 doctoral dissertation concerned reasoning about change in knowledgeable office systems.

Other models of concurrency

The Actor Model does not have the following restrictions of other models of concurrency:¹⁴

- *Single threadedness*: There are no restrictions on the use of threads in implementations.
- *Message delivery order*: There no restrictions on message delivery order.
- *Independence of sender*: The semantics of a message in the Actor Model is independent of the sender.
- *Lack of garbage collection (automated storage reclamation)*: The Actor Model can be used in the following systems:
 - CLR and extensions (Microsoft and Xamarin)
 - JVM (Oracle and IBM)
 - LLVM (Apple)
 - Dalvik (Google)

In due course, we will need to extend the above systems with a tagged extension of the X86 and ARM architectures. Many-core architecture has made a tagged extension necessary in order to provide the following:

- concurrent, nonstop, no-pause automated storage reclamation (garbage collection) and relocation to improve performance,
- prevention of memory corruption that otherwise results from programming languages like C and C++ using thousands of threads in a process,
- nonstop migration of Actors (while they are in operation) within a computer and between distributed computers.

Swiss Cheese

Swiss cheese [Hewitt and Atkinson 1977, 1979; Atkinson 1980]¹⁵ is a programming language construct for scheduling concurrent access to shared resources with the following goals:

- *Generality*: Ability to conveniently program any scheduling policy
- *Performance*: Support maximum performance in implementation, *e.g.*, the ability to avoid repeatedly recalculating conditions for proceeding.
- *Understandability*: Invariants of an Actor should hold at all observable execution points.

Concurrency control for readers and writers in a shared resource is a classic problem that illustrates limitations of Fog Cutter Actors. The fundamental constraint is that multiple writers are not allowed to operate concurrently and a writer is not allowed operate concurrently with a reader.

Cheese diagram for **ReadersWriter** implementations:ⁱ

ⁱ The interface for the readers/writer guardian is the same as the interface for the shared resource: **Interface ReadersWriter with read[Query]→ QueryAnswer, write[Update]→ Void.**

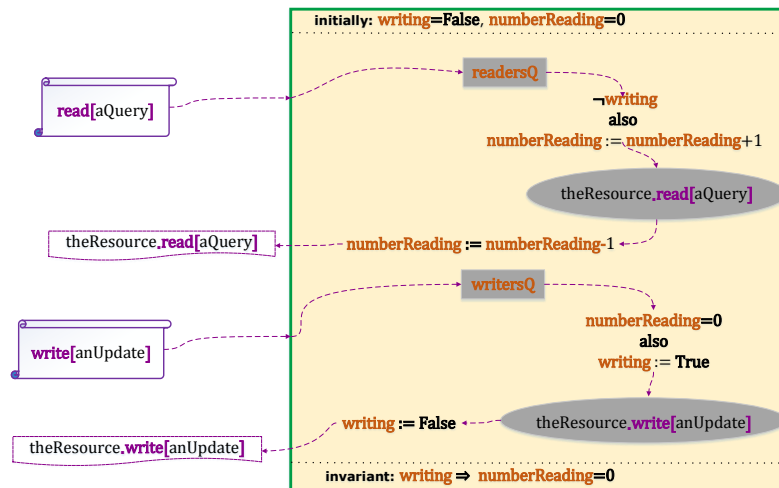

Note:

1. At most one activity is allowed to execute in the cheese.ⁱ
2. The cheese has holes.ⁱⁱ
3. A variable can change only when in a continuous section of cheese.ⁱⁱⁱ

Invariants hold at cheese boundaries, *i.e.*, an invariant must hold when the cheese is entered. Consequently, it doesn't matter what actions other Actors may be concurrently performing.

Futures

Futures [Baker and Hewitt 1977] are Actors that provide parallel execution by providing a proxy Actor for an expression while it is being computed.

The procedure below can compute the size of a list concurrently with creating the list making use of **FutureList**, which is a list that is either the empty list or whose list of elements after the first is a future.

```

Size.[aFutureList:FutureList<String>]:Integer ≡
  @aFutureList ↻ // resolve the beginning of aFutureList
  [] ≡ 0
  [first, Vrest] ≡
    // first is a string and rest is a future of the remainder
    first.length[] + Size.[rest]
  
```

ⁱ Cheese is yellow in the diagram

ⁱⁱ A hole is grey in the diagram

ⁱⁱⁱ Of course, other external Actors can change.

Future work

As was the case with the lambda calculus and functional programming,ⁱ it has taken decades since they were invented [Hewitt, Bishop, and Steiger 1973] to understand the scientific and engineering of Actor Systems and it is still very much a work in progress.

Actors are becoming the default model of computation. C#, Java, JavaScript, Objective C, and SystemVerilog are all headed in the direction of the Actor Model and ActorScript is a natural extension of these languages. Since it is very close to practice, many programmers just naturally assume the Actor Model.

The following major developments in computer technology are pushing the Actor Model forward because Actor Systems are highly scalable:

- Many-core computer architectures
- Client-cloud computing

In fact, the Actor Model and ActorScript can be seen as codifying what are becoming some best programming practices for many-core and client-cloud computing.

Conclusion

The Actor Model is a mathematical theory that treats “*Actors*” as the universal conceptual primitives of concurrent digital computation. The model has been used both as a framework for a theoretical understanding of concurrency, and as the theoretical basis for several practical implementations of concurrent systems. Unlike previous models of computation, the Actor Model was inspired by physical laws. It was also influenced by the programming languages Lisp, Simula 67 and Smalltalk-72, as well as ideas for Petri Nets, capabilities systems and packet switching. The advent of massive concurrency through client-cloud computing and many-core computer architectures has galvanized interest in the Actor Model.

When an Actor receives a message, it can concurrently:

- Send messages to (unforgeable) addresses of Actors that it has.
- Create new Actors.ⁱⁱ
- Designate how to handle the next message received.

There is no assumed order to the above actions and they could be carried out concurrently. In addition two messages sent concurrently can be received in either order. Decoupling the sender from communication it sends was a

ⁱ For example, it took over four decades to develop the **eval** message-passing model of the lambda calculus [Hewitt, Bishop, and Steiger 1973, Hewitt 2011] building on the Lisp procedural model.

ⁱⁱ with new addresses

fundamental advance of the Actor Model enabling asynchronous communication and control structures as patterns of passing messages.

Preferred methods for characterizing the Actor Model are as follows:

- *Axiomatically* stating laws that apply to all Actor *systems* [Baker and Hewitt 1977]
- *Denotationally* using the Computational Representation Theorem to characterize Actor computations [Clinger 1981; Hewitt 2006].
- *Operationally* using a suitable Actor programming language, *e.g.*, ActorScript [Hewitt 2012] that specifies how Actors can be implemented.

The Actor Model can be used as a framework for modeling, understanding, and reasoning about, a wide range of concurrent systems.

For example:

- Electronic mail (e-mail) can be modeled as an Actor system. Accounts are modeled as Actors and email addresses as Actor addresses.
- Web Services can be modeled with endpoints modeled as Actor addresses.
- Objects with locks (*e.g.* as in Java and C#) can be modeled as Actors.
- The Actor Model can be a computational foundation for Inconsistency Robustness

The Actor Model supports Organizational Programming that is based on authority and accountability in iOrgs [Hewitt 2008a] with the goal of becoming an effective readily understood approach for addressing scalability issues in Software Engineering. The paradigm takes its inspiration from human organizations. iOrgs provide a framework for addressing issues of hierarchy, authority, accountability, scalability, and robustness using methods that are analogous to human organizations. Because humans are very familiar with the principles, methods, and practices of human organizations, they can transfer this knowledge and experience to iOrgs. iOrgs achieve scalability by mirroring human organizational structure. For example an iOrg can have sub-organizations specialized by areas such as sales, production, and so forth. Authority is delegated down the organizational structure and when necessary issues are escalated upward. Authority requires accountability for its use including record keeping and periodic reports. Management is in large part the art of reconciling authority and accountability.

Actor technology will see significant application for coordinating all kinds of digital information for individuals, groups, and organizations so their information usefully links together.

Information coordination needs to make use of the following information system principles:

- **Persistence.** *Information is collected and indexed.*
- **Concurrency:** *Work proceeds interactively and concurrently, overlapping in time.*
- **Quasi-commutativity:** *Information can be used regardless of whether it initiates new work or become relevant to ongoing work.*
- **Sponsorship:** *Sponsors provide resources for computation, i.e., processing, storage, and communications.*
- **Pluralism:** *Information is heterogeneous, overlapping and often inconsistent.*
- **Provenance:** *The provenance of information is carefully tracked and recorded*

The Actor Model is intended to provide a foundation for inconsistency robust information coordination.

Acknowledgements

Important contributions to the semantics of Actors have been made by: Gul Agha, Beppe Attardi, Henry Baker, Will Clinger, Irene Greif, Carl Manning, Ian Mason, Ugo Montanari, Maria Simi, Scott Smith, Carolyn Talcott, Prasanna Thati, and Aki Yonezawa.

Important contributions to the implementation of Actors have been made by: Gul Agha, Bill Athas, Russ Atkinson, Beppe Attardi, Henry Baker, Gerry Barber, Peter Bishop, Nanette Boden, Jean-Pierre Briot, Bill Dally, Blaine Garst, Peter de Jong, Jessie Dedecker, Ken Kahn, Rajesh Karmani, Henry Lieberman, Carl Manning, Mark S. Miller, Tom Reinhardt, Chuck Seitz, Amin Shali, Richard Steiger, Dan Theriault, Mario Tokoro, Darrell Woelk, and Carlos Varela.

Research on the Actor Model has been carried out at Caltech Computer Science, Kyoto University Tokoro Laboratory, MCC, MIT Artificial Intelligence Laboratory, SRI, Stanford University, University of Illinois at Urbana-Champaign Open Systems Laboratory, Pierre and Marie Curie University (University of Paris 6), University of Pisa, University of Tokyo Yonezawa Laboratory and elsewhere.

Conversations over the years with Dennis Allison, Bruce Anderson, Arvind, Bob Balzer, Bruce Baumgart, Gordon Bell, Dan Bobrow, Rod Burstall, Luca Cardelli, Vint Cerf, Keith Clark, Douglas Crockford, Jack Dennis, Peter Deutsch, Edsger Dijkstra, Scott Fahlman, Dan Friedman, Ole-Johan Dahl, Julian Davies, Patrick Dussud, Doug Englebart, Bob Filman, Kazuhiro Fuchi, Cordell Green, Jim Gray, Pat Hayes, Anders Hejlsberg, Pat Helland, John Hennessy, Tony Hoare, Mike Huhns, Dan Ingalls, Anita Jones, Bob Kahn, Gilles Kahn, Alan Karp, Alan Kay, Bob Kowalski, Monica Lam, Butler Lampson, Leslie Lamport, Peter Landin, Vic Lesser, Jerry Lettvin, Lick

Licklider, Barbara Liskov, John McCarthy, Drew McDermott, Dave McQueen, Erik Meijer, Robin Milner, Marvin Minsky, Fanya S. Montalvo, Ike Nassi, Alan Newell, Kristen Nygaard, Seymour Papert, David Patterson, Carl Petri, Gordon Plotkin, Vaughan Pratt, John Reynolds, Jeff Rulifson, Earl Sacerdoti, Vijay Saraswat, Munindar Singh, Dana Scott, Ehud Shapiro, Burton Smith, Guy Steele, Gerry Sussman, Chuck Thacker, Kazunori Ueda, Dave Unger, Richard Waldinger, Peter Wegner, Richard Weyhrauch, Jeannette Wing, Terry Winograd, Glynn Winskel, David Wise, Bill Wulf, *etc.* greatly contributed to the development of the ideas in this article.

The members of the Silicon Valley Friday AM group made valuable suggestions for improving this paper. Blaine Garst found numerous bugs and made valuable comments including information on the historical development of interfaces. Patrick Beard found bugs and suggested improvements in presentation. Discussions with Dennis Allison, Eugene Miya, Vaughan Pratt and others were helpful in improving this article. As reviewers for Inconsistency Robustness 2011, Blaine Garst, Mike Huhns and Patrick Suppes made valuable suggestions for improvement. Discussions with Dale Schumacher helped clarify issues with Fog Cutter Actors and also helped debug the axiomatization of runtime failures in the Actor Model. Phil Bernstein, Sergey Bykov, and Gabi Kliot provide valuable comments on the section on Orleans Actors. Terry Hayes, Chris Hibbert, Daira Hopwood, Ken Kahn, Alan Karp, William Leslie, and Mark S. Miller and made helpful suggestions for the sections on capability, Orleans, and JavaScript Actors. Dan Ingalls made helpful suggestions on the sections on Smalltalk and elsewhere.

The Actor Model is intended to provide a foundation for scalable inconsistency-robust information coordination in privacy-friendly client-cloud computing [Hewitt 2009b].

Bibliography

- Hal Abelson and Gerry Sussman *Structure and Interpretation of Computer Programs* 1984.
- Gul Agha. *Actors: A Model of Concurrent Computation in Distributed Systems* Doctoral Dissertation. 1986.
- Gul Agha, Ian Mason, Scott Smith, and Carolyn Talcott. “A foundation for Actor computation.” *Journal of Functional Programming*. 1997.
- Mikael Amborn. *Facet-Oriented Program Design*. LiTH-IDA-EX-04/047-SE Linköpings Universitet. 2004.
- AMD *AMD64 Architecture Programmer's Manual* October 12, 3011
- Joe Armstrong *History of Erlang* HOPL III. 2007.
- Joe Armstrong. *Erlang*. CACM. September 2010.
- William Athas and Charles Seitz *Multicomputers: message-passing concurrent computers* IEEE Computer August 1988.

- William Athas and Nanette Boden *Cantor: An Actor Programming System for Scientific Computing* in Proceedings of the NSF Workshop on Object-Based Concurrent Programming. 1988. Special Issue of SIGPLAN Notices.
- Russ Atkinson. *Automatic Verification of Serializers* MIT Doctoral Dissertation. June, 1980.
- Henry Baker. *Actor Systems for Real-Time Computation* MIT EECS Doctoral Dissertation. January 1978.
- Henry Baker and Carl Hewitt *The Incremental Garbage Collection of Processes* Proceeding of the Symposium on Artificial Intelligence Programming Languages. SIGPLAN Notices 12, August 1977.
- Paul Baran. *On Distributed Communications Networks* IEEE Transactions on Communications Systems. March 1964.
- Gerry Barber. *Reasoning about Change in Knowledgeable Office Systems* MIT EECS Doctoral Dissertation. August 1981.
- John Barton. *Language Features* November 12, 2014.
<https://github.com/google/traceur-compiler/wiki/LanguageFeatures>
- Robert Bemer *How to consider a computer* Data Control Section, Automatic Control Magazine. March 1957.
- Robert Bemer. *The status of automatic programming for scientific computation* Proc. 4th Annual Computer Applications Symposium. Armour Research Foundation. October 1957. (Panel discussion, pp. 118-126).
- Philip A. Bernstein, Sergey Bykov, Alan Geller, Gabriel Kliot, and Jorgen Thelin, *Orleans: Distributed Virtual Actors for Programmability and Scalability* Microsoft MSR-TR-2014-41. March 24, 2014.
- Harold Boley. *A Tight, Practical Integration of Relations and Functions* Springer. 1999.
- Sergey Bykov, Alan Geller, Gabriel Kliot, James Larus, Ravi Pandya, and Jorgen Thelin. *Orleans: A Framework for Cloud Computing* Microsoft MSR-TR-2010-159. November 30, 2010
- Sergey Bykov. *Building Real-Time Services for Halo* Microsoft Research. June 26, 2013.
- Peter Bishop *Very Large Address Space Modularly Extensible Computer Systems* MIT EECS Doctoral Dissertation. June 1977.
- Andreas Blass, Yuri Gurevich, Dean Rosenzweig, and Benjamin Rossman (2007a) *Interactive small-step algorithms I: Axiomatization* Logical Methods in Computer Science. 2007.
- Andreas Blass, Yuri Gurevich, Dean Rosenzweig, and Benjamin Rossman (2007b) *Interactive small-step algorithms II: Abstract state machines and the characterization theorem*. Logical Methods in Computer Science. 2007.
- W. Earl Boebert. *On the inability of an unmodified capability machine to enforce the *-property*. 7th DOD/NBS Computer Security Conference. September 24-26, 1984.
- Per Brinch Hansen *Monitors and Concurrent Pascal: A Personal History* CACM 1996.

- Stephen Brookes, Tony Hoare, and Bill Roscoe. *A theory of communicating sequential processes* JACM. July 1984.
- Don Box, David Ehnebuske, Gopal Kakivaya, Andrew Layman, Noah Mendelsohn, Henrik Nielsen, Satish Thatte, Dave Winer. *Simple Object Access Protocol (SOAP) 1.1* World Wide Web Consortium Note. May 2000.
- Jean-Pierre Briot. *Acttalk: A framework for object-oriented concurrent programming-design and experience* 2nd France-Japan workshop. 1999.
- Jean-Pierre Briot. *From objects to Actors: Study of a limited symbiosis in Smalltalk-80* Rapport de Recherche 88-58, RXF-LITP. Paris, France. September 1988.
- Luca Cardelli, James Donahue, Lucille Glassman, Mick Jordan, Bill Kalsow, Greg Nelson. *Modula-3 report (revised)* DEC Systems Research Center Research Report 52. November 1989.
- Luca Cardelli and Andrew Gordon *Mobile Ambients* FoSSaCS'98.
- Arnaud Carayol, Daniel Hirschhoff, and Davide Sangiorgi. *On the representation of McCarthy's amb in the π -calculus* "Theoretical Computer Science" February 2005.
- Ajay Chander, Drew Dean, John Mitchell. *A State-Transition Model of Trust Management and Access Control. Proceedings of the Fourteenth IEEE Computer Security Foundations Workshop, Cape Breton, Nova Scotia, June 2001.*
- Bernadette Charron-Bost, Friedemann Mattern, and Gerard Tel. *Synchronous, Asynchronous, and Causally Ordered Communication* Distributed Computing. 1995.
- Alonzo Church "A Set of postulates for the foundation of logic (1&2)" *Annals of Mathematics*. Vol. 33, 1932. Vol. 34, 1933.
- Alonzo Church. *An unsolvable problem of elementary number theory* *American Journal of Mathematics*. 58. 1936.
- Alonzo Church *The Calculi of Lambda-Conversion* Princeton University Press. 1941.
- Will Clinger. *Foundations of Actor Semantics* MIT Mathematics Doctoral Dissertation. June 1981.
- Tyler Close. *Web-key: Mashing with Permission* WWW'08.
- Melvin Conway. *Design of a separable transition-diagram compiler* CACM. 1963.
- Eric Crahen. *Facet: A pattern for dynamic interfaces*. CSE Dept. SUNY at Buffalo. July 22, 2002.
- Ole-Johan Dahl and Kristen Nygaard. "Class and subclass declarations" *IFIP TC2 Conference on Simulation Programming Languages*. May 1967.
- Ole-Johan Dahl and Tony Hoare. *Hierarchical Program Structures in "Structured Programming"* Prentice Hall. 1972.
- William Dally and Wills, D. *Universal mechanisms for concurrency* PARLE '89.
- William Dally, et al. *The Message-Driven Processor: A Multicomputer Processing Node with Efficient Mechanisms* IEEE Micro. April 1992.

- Jack Dennis and Earl Van Horn. *Programming Semantics for Multiprogrammed Computations* CACM. March 1966.
- ECMA. *C# Language Specification* June 2006.
- ECMA *ECMAScript Language Specification 6th Edition Draft* December 6, 2014.
- Jed Donnelly. *A Distributed Capability Computing System* Proceedings of the Third International Conference on Computer Communication. August, 1976.
- Lars Ekeröth and Per-Martin Hedström. *General Packet Radio Service (GPRS) Support Notes* Ericsson Review No. 3. 2000.
- Arthur Fine *The Shaky Game: Einstein Realism and the Quantum Theory* University of Chicago Press, Chicago, 1986.
- Nissim Francez, Tony Hoare, Daniel Lehmann, and Willem-Paul de Roever. *Semantics of nondeterminism, concurrency, and communication* Journal of Computer and System Sciences. December 1979.
- Christopher Fuchs *Quantum mechanics as quantum information (and only a little more)* in A. Khrenikov (ed.) *Quantum Theory: Reconstruction of Foundations* (Växjö: Växjö University Press, 2002).
- Anna Funder. *Stasiland: Stories from Behind the Berlin Wall*. Harper. 2011.
- Blaine Garst. *Origin of Interfaces* Email to Carl Hewitt on October 2, 2009.
- Elihu M. Gerson. *Prematurity and Social Worlds* in *Prematurity in Scientific Discovery*. University of California Press. 2002.
- Andreas Glausch and Wolfgang Reisig. *Distributed Abstract State Machines and Their Expressive Power* Informatik Berichete 196. Humboldt University of Berlin. January 2006.
- Adele Goldberg and Alan Kay (ed.) *Smalltalk-72 Instruction Manual* SSL 76-6. Xerox PARC. March 1976.
- Dina Goldin and Peter Wegner. *The Interactive Nature of Computing: Refuting the Strong Church-Turing Thesis* Minds and Machines March 2008.
- Irene Greif and Carl Hewitt. *Actor Semantics of PLANNER-73* Conference Record of ACM Symposium on Principles of Programming Languages. January 1975.
- Irene Greif. *Semantics of Communicating Parallel Processes* MIT EECS Doctoral Dissertation. August 1975.
- Werner Heisenberg. *Physics and Beyond: Encounters and Conversations* translated by A. J. Pomerans (Harper & Row, New York, 1971), pp. 63– 64.
- Carl Hewitt, Peter Bishop and Richard Steiger. *A Universal Modular Actor Formalism for Artificial Intelligence* IJCAI'73.
- Carl Hewitt, et al. *Actor Induction and Meta-evaluation* Conference Record of ACM Symposium on Principles of Programming Languages, January 1974.
- Carl Hewitt, *The Apiary Network Architecture for Knowledgeable Systems* Proceedings of Lisp Conference. 1980.
- Carl Hewitt and Henry Lieberman. *Design Issues in Parallel Architecture for Artificial Intelligence* MIT AI memo 750. Nov. 1983.

- Carl Hewitt, Tom Reinhardt, Gul Agha, and Giuseppe Attardi *Linguistic Support of Receptionists for Shared Resources* MIT AI Memo 781. Sept. 1984.
- Carl Hewitt, *et al.* *Behavioral Semantics of Nonrecursive Control Structure* Proceedings of *Colloque sur la Programmation*, April 1974.
- Carl Hewitt. *How to Use What You Know* IJCAI. September, 1975.
- Carl Hewitt. *Viewing Control Structures as Patterns of Passing Messages* AI Memo 410. December 1976. *Journal of Artificial Intelligence*. June 1977.
- Carl Hewitt and Henry Baker *Laws for Communicating Parallel Processes* IFIP-77, August 1977.
- Carl Hewitt and Russ Atkinson. *Specification and Proof Techniques for Serializers* IEEE Journal on Software Engineering. January 1979.
- Carl Hewitt, Beppe Attardi, and Henry Lieberman. *Delegation in Message Passing* Proceedings of First International Conference on Distributed Systems Huntsville, AL. October 1979.
- Carl Hewitt and Gul Agha. *Guarded Horn clause languages: are they deductive and Logical?* in *Artificial Intelligence at MIT*, Vol. 2. MIT Press 1991.
- Carl Hewitt and Jeff Inman. *DAI Betwixt and Between: From "Intelligent Agents" to Open Systems Science* IEEE Transactions on Systems, Man, and Cybernetics. Nov./Dec. 1991.
- Carl Hewitt and Peter de Jong. *Analyzing the Roles of Descriptions and Actions in Open Systems* Proceedings of the National Conference on Artificial Intelligence. August 1983.
- Carl Hewitt. (2006). "What is Commitment? Physical, Organizational, and Social" *COIN@AAMAS'06*. (Revised in Springer Verlag Lecture Notes in Artificial Intelligence. Edited by Javier Vázquez-Salceda and Pablo Noriega. 2007) April 2006.
- Carl Hewitt (2007a). "Organizational Computing Requires Unstratified Paraconsistency and Reflection" *COIN@AAMAS*. 2007.
- Carl Hewitt (2008a) [Norms and Commitment for iOrgs™ Information Systems: Direct Logic™ and Participatory Argument Checking](#) ArXiv 0906.2756.
- Carl Hewitt (2008b) "Large-scale Organizational Computing requires Unstratified Reflection and Strong Paraconsistency" *Coordination, Organizations, Institutions, and Norms in Agent Systems III* Jaime Sichman, Pablo Noriega, Julian Padget and Sascha Ossowski (ed.). Springer-Verlag. <http://organizational.carlhewitt.info/>
- Carl Hewitt (2008c) [Middle History of Logic Programming: Resolution, Planner, Edinburgh Logic for Computable Functions, Prolog and the Japanese Fifth Generation Project](#) ArXiv 0904.3036.
- Carl Hewitt (2008e). *ORGs for Scalable, Robust, Privacy-Friendly Client Cloud Computing* IEEE Internet Computing September/October 2008.
- Carl Hewitt (2008f) [Formalizing common sense for scalable inconsistency-robust information integration using Direct Logic™ and the Actor Model](#) Inconsistency Robust 2011.

- Carl Hewitt (2009a) *Perfect Disruption: The Paradigm Shift from Mental Agents to ORGs* IEEE Internet Computing. Jan/Feb 2009.
- Carl Hewitt (2009b) [A historical perspective on developing foundations for client-cloud computing: iConsult™ & iEntertain™ Apps using iInfo™ Information Integration for iOrgs™ Information Systems](#) (Revised version of “Development of Logic Programming: What went wrong, What was done about it, and What it might mean for the future” AAAI Workshop on What Went Wrong. AAAI-08.) ArXiv 0901.4934.
- Carl Hewitt (2009c) [Middle History of Logic Programming: Resolution, Planner, Prolog and the Japanese Fifth Generation Project](#) ArXiv 0904.3036
- Carl Hewitt (2010a) *ActorScript™ extension of C#®, Java® and Objective C®; iAdaptive™ concurrency for antiCloud™-privacy and security in Inconsistency Robustness*. College Publications. 2015.
- Carl Hewitt, Erik Meijer, and Clemens Szyperski [“The Actor Model \(everything you wanted to know, but were afraid to ask\)”](#) <http://channel9.msdn.com/Shows/Going+Deep/Hewitt-Meijer-and-Szyperski-The-Actor-Model-everything-you-wanted-to-know-but-were-afraid-to-ask> Microsoft Channel 9. April 9, 2012.
- Carl Hewitt. [“Health Information Systems Technologies”](#) <http://ee380.stanford.edu/cgi-bin/videologger.php?target=120606-ee380-300.aspx> Slides for this video: <http://HIST.carlhewitt.info> Stanford CS Colloquium. June 6, 2012.
- Carl Hewitt. *What is computation? Actor Model versus Turing's Model* in “A Computable Universe: Understanding Computation & Exploring Nature as Computation”. edited by Hector Zenil. World Scientific Publishing Company. 2012 . PDF at <http://what-is-computation.carlhewitt.info>
- Carl Hewitt. *Security without IoT Mandatory Backdoors: Using Distributed Encrypted Public Recording to Catch & Prosecute Suspects*. HAL Archives. 2015/2016. <https://hal.archives-ouvertes.fr/hal-01152495>
- Carl Hewitt. *All Writs is a Trojan Horse*. Letter to editor. CACM. May 2016.
- Tony Hoare *Quick sort*. Computer Journal 5 (1) 1962.
- Tony Hoare *Monitors: An Operating System Structuring Concept* CACM. October 1974.
- Tony Hoare. *Communicating sequential processes* CACM. August 1978.
- Tony Hoare. *Communicating Sequential Processes* Prentice Hall. 1985.
- Waldemer Horwat, Andrew Chien, and William Dally. *Experience with CST: Programming and Implementation* PLDI. 1989.
- Daniel Ingalls. *Design Principles Behind Smalltalk*. Byte. August 1981.
- Daniel Ingalls, Ted Kaehler, John Maloney, Scott Wallace, and Alan Kay. *Back to the Future: the story of Squeak, a practical Smalltalk written in itself* ACM Digital Library. 1997.
- Peter Ingerman, *Thunks: A Way of Compiling Procedure Statements with Some Comments on Procedure Declarations*. CACM 4 (1). 1961.
- Intel. *Intel Memory Protection Extensions (Intel MPX) support in the GCC compiler* GCC Wiki. November 24, 2014.

- ISO. *ISO/IEC 14882:2011(E) Programming Languages -- C++, Third Edition* August, 2011.
- Max Jammer *The EPR Problem in Its Historical Development* in Symposium on the Foundations of Modern Physics: 50 years of the Einstein-Podolsky-Rosen Gedankenexperiment, edited by P. Lahti and P. Mittelstaedt. World Scientific. Singapore. 1985.
- Stanisław Jaśkowski On the Rules of Suppositions in Formal Logic *Studia Logica* 1, 1934. (reprinted in: *Polish logic 1920-1939*, Oxford University Press, 1967.)
- Simon Peyton Jones, Andrew Gordon, Sigbjorn Finne. *Concurrent Haskell*, POPL'96.
- Ken Kahn. *A Computational Theory of Animation* MIT EECS Doctoral Dissertation. August 1979.
- Matthias Kaiser and Jens Lemcke *Towards a Framework for Policy-Oriented Enterprise Management* AAAI 2008.
- Alan Karp, Rajiv Gupta, Guillermo Rozas, and Arindam Banerji. *Using Split Capabilities for Access Control* IEEE Software. January, 2003.
- Alan Karp and Jun Li. *Solving the Transitive Access Problem for the Services Oriented Architecture* HPL-2008-204R1. HP Laboratories 2008.
- Alan Karp and Jun Li. *Access Control for the Services Oriented Architecture* ACM Workshop on Secure Web Services. November 2007
- Rajesh Karmani and Gul Agha. *Actors*. Encyclopedia of Parallel Computing 2011.
- Alan Kay. "Personal Computing" in *Meeting on 20 Years of Computing Science* Istituto di Elaborazione della Informazione, Pisa, Italy. 1975. <http://www.mprove.de/diplom/gui/Kay75.pdf>
- Alan Kay. *Alan Kay on Messaging* Squeak email list. October 10, 1998.
- Frederick Knabe *A Distributed Protocol for Channel-Based Communication with Choice* PARLE'92.
- Jorgen Knudsen and Ole Madsen. *Teaching Object-Oriented Programming is more than teaching Object-Oriented Programming Languages* ECOOP'88. Springer. 1988.
- Bill Kornfeld and Carl Hewitt. *The Scientific Community Metaphor* IEEE Transactions on Systems, Man, and Cybernetics. January 1981.
- Bill Kornfeld. *Parallelism in Problem Solving* MIT EECS Doctoral Dissertation. August 1981.
- Robert Kowalski. *A proof procedure using connection graphs* JACM. October 1975.
- Robert Kowalski *Algorithm = Logic + Control* CACM. July 1979.
- Robert Kowalski. *Response to questionnaire* Special Issue on Knowledge Representation. SIGART Newsletter. February 1980.
- Robert Kowalski (1988a) *The Early Years of Logic Programming* CACM. January 1988.

- Robert Kowalski (1988b) *Logic-based Open Systems Representation and Reasoning*. Stuttgart Conference Workshop on Discourse Representation, Dialogue tableaux and Logic Programming. 1988.
- Stein Kroghdahl. *The birth of Simula* HiNC 1 Conference. Trondheim. June 2003.
- Albert Kwon, Udit Dhawan, Jonathan Smith, Tom. Knight, Jr., and André DeHon, “Low-fat pointers: Compact encoding and efficient gate-level implementation of fat pointers for spatial safety and capability-based security,” in 20th ACM Conference on Computer and Communications Security, November 2013.
- Butler Lampson. *Protection*. In Proceedings of the 5th Annual Princeton Conference on Information Sciences and Systems. Princeton University, 1971.
- Leslie Lamport *Time, Clocks, and Orderings of Events in a Distributed System* CACM. 1978.
- Leslie Lamport *How to make a multiprocessor computer that correctly executes multiprocess programs* IEEE Transactions on Computers. 1979.
- Peter Landin. *A Generalization of Jumps and Labels* UNIVAC Systems Programming Research Report. August 1965. (Reprinted in *Higher Order and Symbolic Computation*. 1998)
- Peter Landin *A correspondence between ALGOL 60 and Church’s lambda notation* CACM. August 1965.
- Edward Lee and Stephen Neuendorffer (June 2004). *Classes and Subclasses in Actor-Oriented Design*. Conference on Formal Methods and Models for Codesign (MEMOCODE).
- Henry Levy. *Capability-Based Computer Systems* Digital Press. 1985.
- Steven Levy *Hackers: Heroes of the Computer Revolution* Doubleday. 1984.
- Henry Lieberman. *An Object-Oriented Simulator for the Apiary* Conference of the American Association for Artificial Intelligence, Washington, D. C., August 1983
- Henry Lieberman. *Thinking About Lots of Things at Once without Getting Confused: Parallelism in Act 1* MIT AI memo 626. May 1981.
- Henry Lieberman. *A Preview of Act 1* MIT AI memo 625. June 1981.
- Henry Lieberman and Carl Hewitt. *A real Time Garbage Collector Based on the Lifetimes of Objects* CACM June 1983.
- Barbara Liskov *Data abstraction and hierarchy* Keynote address. OOPSLA’87.
- Barbara Liskov and Liuba Shriru *Promises: Linguistic Support for Efficient Asynchronous Procedure Calls* SIGPLAN’88.
- Barbara Liskov and Jeannette Wing. *Behavioral subtyping using invariants and constraints* in “Formal methods for distributed processing: a survey of object-oriented approaches” Cambridge University Press. 2001.
- Carl Manning. *Traveler: the Actor observatory* ECOOP 1987. Also appears in Lecture Notes in Computer Science, vol. 276.
- Carl Manning,. *Acore: The Design of a Core Actor Language and its Compile Master’s Thesis*. MIT EECS. May 1987.

- Satoshi Matsuoka and Aki Yonezawa. *Analysis of Inheritance Anomaly in Object-Oriented Concurrent Programming Languages Research Directions in Concurrent Object-Oriented Programming* MIT Press. 1993.
- John McCarthy *Programs with common sense* Symposium on Mechanization of Thought Processes. National Physical Laboratory, UK. Teddington, England. 1958.
- John McCarthy. *A Basis for a Mathematical Theory of Computation* Western Joint Computer Conference. 1961.
- John McCarthy, Paul Abrahams, Daniel Edwards, Timothy Hart, and Michael Levin. *Lisp 1.5 Programmer's Manual* MIT Computation Center and Research Laboratory of Electronics. 1962.
- John McCarthy. *Situations, actions and causal laws* Technical Report Memo 2, Stanford University Artificial Intelligence Laboratory. 1963.
- John McCarthy and Patrick Hayes. *Some Philosophical Problems from the Standpoint of Artificial Intelligence* Machine Intelligence 4. Edinburgh University Press. 1969.
- Erik Meijer and Gavin Bierman. *A co-Relational Model of Data for Large Shared Data Banks* ACM Queue. March 2011.
- Microsoft. *Asynchronous Programming with Async and Await* MSDN. 2013.
- Giuseppe Milicia and Vladimiro Sassone. *The Inheritance Anomaly: Ten Years After SAC*. Nicosia, Cyprus. March 2004.
- Mark S. Miller, Eric Dean Tribble, and Jonathan Shapiro. *Concurrency Among Strangers: Programming in E as Plan Coordination* Proceedings of the International Symposium on Trustworthy Global Computing. Springer. 2005.
- Mark S. Miller, Ka-Ping Yee, and Jonathan Shapiro. *Capability Myths Demolished* Submitted to Usenix Security 2003.
- Mark S. Miller and Jonathan Shapiro *Paradigm Regained: Abstraction Mechanisms for Access Control* ASIAN'03. 2003.
- Mark S. Miller *Robust Composition: Towards a Unified Approach to Access Control and Concurrency Control* Doctoral Dissertation. John Hopkins. 2006.
- Mark S. Miller *et. al.* *Bringing Object-orientation to Security Programming*. YouTube. November 3, 2011.
- Mark S. Miller. *mutable ArrayBuffer?* Communication on FriAM mailing list. May 14, 2016.
- George Milne and Robin Milner. "Concurrent processes and their syntax" *JACM*. April, 1979.
- Robert Milne and Christopher Strachey. *A Theory of Programming Language Semantics* Chapman and Hall. 1976.
- Robin Milner *Processes: A Mathematical Model of Computing Agents* Proceedings of Bristol Logic Colloquium. 1973.
- Robin Milner *Elements of interaction: Turing award lecture* CACM. January 1993.
- Marvin Minsky (ed.) *Semantic Information Processing* MIT Press. 1968.

- Ugo Montanari and Carolyn Talcott. *Can Actors and Pi-Agents Live Together?* Electronic Notes in Theoretical Computer Science. 1998.
- Eugenio Moggi *Computational lambda-calculus and monads* IEEE Symposium on Logic in Computer Science. Asilomar, California, June 1989.
- Allen Newell and Herbert Simon. *The Logic Theory Machine: A Complex Information Processing System*. Rand Technical Report P-868. June 15, 1956
- Kristen Nygaard. *SIMULA: An Extension of ALGOL to the Description of Discrete-Event Networks* IFIP'62. Kristen Nygaard. *Basic Concepts in Object Oriented Programming* Special Edition on Object-Oriented Programming Languages. SIGPLAN Notices. Vol. 21. November 1986.
- David Park. *Concurrency and Automata on Infinite Sequences* Lecture Notes in Computer Science, Vol. 104. Springer. 1980.
- Elliot Organick. *A Programmer's View of the Intel 432 System* McGraw-Hill, 1983.
- Carl Petri. *Kommunikation mit Automate* Ph. D. Thesis. University of Bonn. 1962.
- Simon Peyton Jones, Alastair Reid, Fergus Henderson, Tony Hoare, and Simon Marlow. *A semantics for imprecise exceptions* Conference on Programming Language Design and Implementation. 1999.
- Gordon Plotkin. *A powerdomain construction* SIAM Journal of Computing. September 1976.
- George Polya (1957) *Mathematical Discovery: On Understanding, Learning and Teaching Problem Solving Combined Edition* Wiley. 1981.
- Karl Popper (1935, 1963) *Conjectures and Refutations: The Growth of Scientific Knowledge* Routledge. 2002.
- Claudius Ptolemaeus, Editor. *System Design, Modeling, and Simulation: Using Ptolemy II* LuLu. <http://ptolemy.org/systems>. 2014
- Susan Rajunas. *The KeyKOS/KeySAFE System Design*. Technical Report SEC009-01. Key Logic, Inc. March 1989.
- John Reppy, Claudio Russo, and Yingqi Xiao *Parallel Concurrent ML* ICFP'09.
- John Reynolds. *Definitional interpreters for higher order programming languages* ACM Conference Proceedings. 1972.
- John Reynolds. *The Discoveries of Continuations* Lisp and Symbolic Computation 6 (3-4). 1993.
- Bill Roscoe. *The Theory and Practice of Concurrency* Prentice-Hall. Revised 2005.
- Alex Russell. *A design for Futures/Promises in DOM*. W3C. March 7, 2013.
- Dale Schumacher. *Implementing Actors in Kernel* February 16, 2012. <http://www.dalnfre.com/wp/2012/02/implementing-actors-in-kernel/>
- Dana Scott and Christopher Strachey. *Toward a mathematical semantics for computer languages* Oxford Programming Research Group Technical Monograph. PRG-6. 1971
- Dana Scott *Data Types as Lattices*. SIAM Journal on computing. 1976.
- Charles Seitz. *The Cosmic Cube* CACM. Jan. 1985.

- Peter Sewell, et. al. *x86-TSO: A Rigorous and Usable Programmer's Model for x86 Microprocessors* CACM. July 2010.
- Jonathan Shapiro and Jonathan Adams. *Coyotos Microkernel Specification* EROS Group. September 10, 2007.
- SIGPLAN. *Special Edition on Object-Oriented Programming Languages* SIGPLAN Notices. Vol. 21. November 1986.
- Michael Smyth. *Power domains*. Computer and System Sciences. 1978.
- Alfred Spiessens. *Patterns of Safe Collaboration*. Doctoral Thesis. Université catholique de Louvain. February 2007.
- Guy Steele Jr. *Lambda: The Ultimate Declarative* MIT AI Memo 379. November 1976.
- Lynn Stein, Henry Lieberman, and David Ungar. *A Shared View of Sharing: The Treaty of Orlando* Object-oriented concepts, databases, and applications. ACM. 1989
- Jan Stenberg. *Building Halo 4, a Video Game, Using Actor Model*. InfoQ. March 7, 2015.
- Gunther Stent. *Prematurity and Uniqueness in Scientific Discovery* Scientific American. December, 1972.
- Sun *Java Specification Request 133* 2004
- Gerry Sussman and Guy Steele *Scheme: An Interpreter for Extended Lambda Calculus* AI Memo 349. December, 1975.
- Daniel Theriault. *A Primer for the Act-1 Language* MIT AI memo 672. 1982.
- Daniel Theriault. *Issues in the Design and Implementation of Act 2* MIT AI technical report 728. June 1983.
- Hayo Thielecke *An Introduction to Landin's "A Generalization of Jumps and Labels"* Higher-Order and Symbolic Computation. 1998.
- Dave Thomas and Brian Barry. *Using Active Objects for Structuring Service Oriented Architectures: Anthropomorphic Programming with Actors* Journal of Object Technology. July-August 2004.
- Bill Tulloh and Mark S. Miller. *Institutions as Abstraction Boundaries* Humane Economics: Essays in Honor of Don Lavoie. Elgar Publishing. 2006.
- Vaughan Vernon. *Reactive Messaging Patterns with the Actor Model*. Pearson Education. 2016.
- Ulf Wiger. *1000 Year-old Design Patterns* QCon. Apr 21, 2011.
- Jonathan Woodruff, Robert N. M. Watson, David Chisnall, Simon W. Moore, Jonathan Anderson, Brooks Davis, Ben Laurie, Peter G. Neumann, Robert Norton, and Michael Roe. *The CHERI capability model: Revisiting RISC in an age of risk* International Symposium on Computer Architecture (ISCA). June 2014.
- Robert N. M. Watson, Jonathan Woodruff, Peter G. Neumann, Simon W. Moore, Jonathan Anderson, David Chisnall, Nirav Dave, Brooks Davis, Khilan Gudka, Ben Laurie, Steven J. Murdoch, Robert Norton, Michael Roe, Stacey Son, and Munraj Vadera. *CHERI: A Hybrid Capability-System Architecture for Scalable Software Compartmentalization* IEEE Symposium on Security and Privacy. May 2015

- Darrell Woelk. *Developing InfoSleuth Agents Using Rosette: An Actor Based Language* Proceedings of the CIKM '95 Workshop on Intelligent Information Agents. 1995.
- World Wide Web Consortium. *HTML5: A vocabulary and associated APIs for HTML and XHTML* Editor's Draft. August 22, 2012.
- Akinori Yonezawa, Ed. *ABCL: An Object-Oriented Concurrent System* MIT Press. 1990.
- Akinori Yonezawa *Specification and Verification Techniques for Parallel Programs Based on Message Passing Semantics* MIT EECS Doctoral Dissertation. December 1977.
- Takeshi Yoshino. *Intent to Implement: DOM Futures*. W3C. May 23, 2013
- Hadasa Zuckerman and Joshua Lederberg. *Postmature Scientific Discovery?* Nature. December, 1986.

Appendix 1. Historical background¹⁶

The Actor Model builds on previous models of nondeterministic computation. Several models of nondeterministic computation were developed including the following:

Concurrency versus Turing's Model

Turing's model of computation was intensely psychological.¹⁷ [Sieg 2008] formalized it as follows:

- *Boundedness*: A computer can immediately recognize only a bounded number of configurations.
- *Locality*: A computer can change only immediately recognizable configurations.

In the above, computation is conceived as being carried out in a single place by a device that proceeds from one well-defined state to the next.

Computations are represented differently in Turing Machines and Actors:

1. *Turing Machine*: a computation can be represented as a global state that determines all information about the computation.¹⁸ It can be nondeterministic as to which will be the next global state.
2. *Actors*: a computation can be represented as a configuration. Information about a configuration can be indeterminate.ⁱ

Lambda calculus

The Lambda calculus was originally developed as part of a system for the foundations of logic [Church 1932-33]. However, the system was soon shown to be inconsistent. Subsequently, Church removed logical propositions from the system leaving a purely procedural lambda calculus [Church 1941].¹⁹

However, the semantics of the lambda calculus were expressed using string substitution in which the values of parameters were substituted into the body of an invoked lambda expression. The substitution model is unsuitable for concurrency because it does not allow the capability of sharing of changing resources.

That Actors which behave like mathematical functions exactly correspond with those definable in the lambda calculus provides an intuitive justification for the rules of the lambda calculus:

- *Lambda identifiers*: each identifier is bound to the address of an Actor. The rules for free and bound identifiers correspond to the Actor rules for addresses.
- *Beta reduction*: each beta reduction corresponds to an Actor receiving a message. Instead of performing substitution, an Actor receives addresses of its arguments.

ⁱ For example, there can be messages in transit that will be delivered at some indefinite time.

Inspired by the lambda calculus, the interpreter for the programming language Lisp [McCarthy *et. al.* 1962] made use of a data structure called an environment so that the values of parameters did not have to be substituted into the body of an invoked lambda expression.²⁰

Note that in the definition in ActorScript [Hewitt 2011] of the lambda calculus below:

- All operations are local.
- The definition is modular in that each lambda calculus programming language construct is an Actor.
- The definition is easily extensible since it is easy to add additional programming language constructs.
- The definition is easily operationalized into efficient concurrent implementations.
- The definition easily fits into more general concurrent computational frameworks for many-core and distributed computation

The lambda calculus can be implemented in ActorScript as follows:

```
Actor Identifier<aType>[aString:String]
  implements Expression<aType> using
    eval[e:Environment]:aType → e.lookup[[]Identifier<aType>]
                                // lookup this identifier in anEnvironment
```

```
Actor ProcedureCall<aType, AnotherType>
  [operator:([aType]→ anotherType), operand:aType]
  implements Expression<anotherType> using
    eval[e:Environment]:anotherType →
      (operator.eval[e]).[operand.eval[e]]
```

```
Actor Lambda<aType, anotherType>
  [id:Identifier<aType>, body:anotherType]
  implements Expression<[aType]→ anotherType> using
    eval[e:Environment]:anotherType →
      [anArgument:aType]→ body.eval[e.bind[id, anArgument]]
      // create a new environment with anIdentifier bound to
      // anArgument in anEnvironment
```

In many practical applications, the parallel lambda calculus (*i.e.* using purely functional programming) can be exponentially slower than concurrent computation using Actors.ⁱ

ⁱ For example, implementations using Actors of Direct Logic can be exponentially faster than implementations in the parallel lambda calculus.

Petri nets

Prior to the development of the Actor Model, Petri nets²¹ were widely used to model nondeterministic computation. However, they were widely acknowledged to have an important limitation: they modeled control flow but not data flow. Consequently they were not readily composable thereby limiting their modularity.

Hewitt pointed out another difficulty with Petri nets:

Simultaneous action, *i.e.*, the atomic step of computation in Petri nets is a transition in which tokens simultaneously disappear from the input places of a transition and appear in the output places. The physical basis of using a primitive computational entity with this kind of simultaneity seemed questionable to him.

Despite these apparent difficulties, Petri nets continue to be a popular approach to modeling nondeterminism, and are still the subject of active research.

Simula

Simula 1 [Nygaard 1962] pioneered nondeterministic discrete event simulation using a global clock:

In this early version of Simula a system was modeled by a (fixed) number of “stations”, each with a queue of “customers”. The stations were the active parts, and each was controlled by a program that could “input” a customer from the station’s queue, update variables (global, local in station, and local in customer), and transfer the customer to the queue of another station. Stations could discard customers by not transferring them to another queue, and could generate new customers. They could also wait a given period (in simulated time) before starting the next action. Custom types were declared as data records, without any actions (or procedures) of their own. [Krogdahl 2003]

Thus at each time step, the program of the next station to be simulated would update the variables.

Kristen Nygaard and Ole-Johan Dahl developed the idea (first described in an IFIP workshop in 1967) of organizing objects into “classes” with “subclasses” that could inherit methods for performing operations from their super classes. In this way, Simula 67 considerably improved the modularity of nondeterministic discrete event simulations.

According to [Krogdahl 2003]:

Objects could act as processes that can execute in “quasi-parallel” that is in fact a form of nondeterministic sequential execution in which a simulation is organized as “independent” processes. Classes in Simula 67 have their own procedures that start when an object is generated. However, unlike Algol procedures, objects may choose to temporarily stop their execution and transfer the control to another process. If the control is later

given back to the object, it will resume execution where the control last left off. A process will always retain the execution control until it explicitly gives it away. When the execution of an object reaches the end of its statements, it will become “terminated”, and can no longer be resumed (but local data and local procedures can still be accessed from outside the object).

The quasi-parallel sequencing is essential for the simulation mechanism. Roughly speaking, it works as follows: When a process has finished the actions to be performed at a certain point in simulated time, it decides when (again in simulated time) it wants the control back, and stores this in a local “next-event-time” variable. It then gives the control to a central “time-manager”, which finds the process that is to execute next (the one with the smallest next-event-time), updates the global time variable accordingly, and gives the control to that process.

The idea of this mechanism was to invite the programmer of a simulation program to model the underlying system by a set of processes, each describing some natural sequence of events in that system (e.g. the sequence of events experienced by one car in a traffic simulation).

Note that a process may transfer control to another process even if it is currently inside one or more procedure calls. Thus, each quasi-parallel process will have its own stack of procedure calls, and if it is not executing, its “reactivation point” will reside in the innermost of these calls. Quasi-parallel sequencing is analogous to the notion of co-routines [Conway 1963].

Note that Simula operated on the global state of a simulation and not just on the local variables of simulated objects.²² Also Simula-67 lacked formal interfaces and instead relied on inheritance in a hierarchy of objects thereby placing limitations to the ability to define and invoke behavior not directly inherited.

Types in Simula are the names of implementations called “classes” in contrast with ActorScript in which types are interfaces that do not name their implementation. Also, although Simula had nondeterminism, it did not have concurrency.²³

Planner

The two major paradigms for constructing semantic software systems were procedural and logical. The procedural paradigm was epitomized by using Lisp [McCarthy *et al.* 1962; Minsky, *et al.* 1968] recursive procedures operating on list structures. The logical paradigm was epitomized by uniform resolution theorem provers [Robinson 1965].

Planner [Hewitt 1969] was a kind of hybrid between the procedural and logical paradigms.²⁴ An implication of the form ($P \text{ implies } Q$) was procedurally interpreted as follows:²⁵

- **When asserted P, Assert Q**
- **When goal Q, SetGoal P**
- **When asserted (*not* Q), Assert (*not* P)**
- **When goal (*not* P), SetGoal (*not* Q)**

Planner was the first programming language based on the pattern-directed invocation of procedural plans from assertions and goals. *It represented a rejection of the resolution uniform proof procedure paradigm.*

Smalltalk-72

Planner, Simula 67, Smalltalk-72 [Kay 1975; Ingalls 1983] and packet-switched networks had previously used message passing. However, they were too complicated to use as the foundation for a mathematical theory of computation. Also they did not address fundamental issues of concurrency.

Alan Kay was influenced by message passing in the pattern-directed invocation of Planner in developing Smalltalk-71. Hewitt was intrigued by Smalltalk-71 but was put off by the complexity of communication that included invocations with many fields including global, sender, receiver, reply-style, status, reply, operator, *etc.*

In November 1972, Kay visited MIT and presented a lecture on some of his ideas for Smalltalk-72 building on the Logo work of Seymour Papert and the “little person” metaphor of computation used for teaching children to program. Smalltalk-72 made important advances in graphical user interfaces.

However, the message passing of Smalltalk-72 was quite complex [Kay 1975]. Code in the language was viewed by the interpreter as simply a stream of tokens. According to [Ingalls 1983]:²⁶

*The first (token) encountered (in a program) was looked up in the dynamic context, to determine the receiver of the subsequent message. The name lookup began with the class dictionary of the current activation. Failing there, it moved to the sender of that activation and so on up the sender chain. When a binding was finally found for the token, its value became the receiver of a new message, and the interpreter activated the code for that object's class.*²⁷

Thus the message passing model in Smalltalk-72 was closely tied to a particular machine model and programming language syntax that did not lend itself to concurrency. Also, although the system was bootstrapped on itself, the language constructs were not formally defined as objects that respond to *eval* messages as in the definition of ActorScript [Hewitt 2010a].

Actors

The invention of digital computers caused a decisive paradigm shift when the notion of an interrupt was invented so that input that is received asynchronously from outside could be incorporated in an ongoing computation. At first concurrency was conceived using low level machine implementation concepts like threads, locks, coherent memory, channels, cores, queues, *etc.*

The Actor Model [Hewitt, Bishop, and Steiger 1973; *etc.*] was based on message passing that was different from previous models of computation because the sender of a message is not intrinsic to the semantics of a communication.²⁸

In contrast to previous global state model, computation in the Actor Model is conceived as distributed in space where computational devices called Actors communicate asynchronously using addresses of Actors and the entire computation is not in any well-defined state.²⁹

Axioms of locality including *Organizational* and *Operational* hold as follows:

- *Organization*: The local storage of an Actor can include *addresses* only
 1. that were provided when it was created
 2. that have been received in messages
 3. that are for Actors created here
- *Operation*: In response to a message received, an Actor can
 1. create more Actors
 2. send messagesⁱ to *addresses* in the following:
 - the message it has just received
 - its local storage
 3. designate how to process the next message received

In concrete terms for Actor systems, typically we cannot observe the details by which the order in which an Actor processes messages has been determined. Attempting to do so affects the results. Instead of observing the internals of arbitration processes of Actor computations, we await outcomes.³⁰ Indeterminacy in arbiters produces indeterminacy in Actors.ⁱⁱ

ⁱ Likewise the messages sent can contain addresses only

1. that were provided when the Actor was created
2. that have been received in messages
3. that are for Actors created here

ⁱⁱ The dashed lines are used only to disambiguate crossing wires.

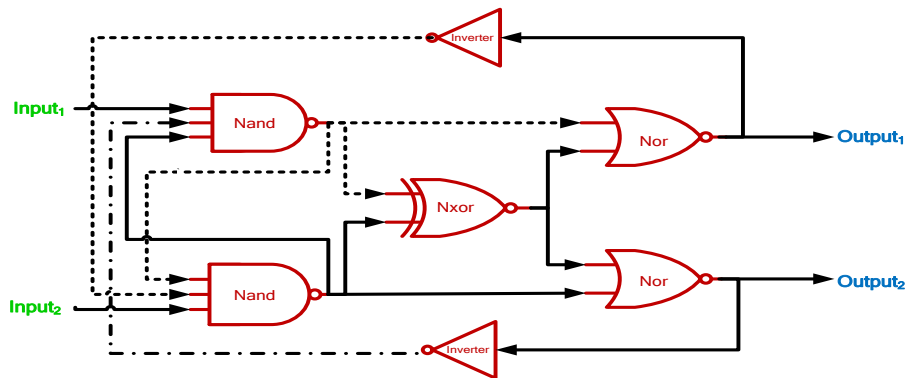

Arbiter Concurrency Primitive³¹

After the above circuit is started, it can remain in a meta-stable state for an unbounded period of time before it finally asserts either Output₁ or Output₂. So there is an inconsistency between the nondeterministic state model of computation and the circuit model of arbiters.³²

The internal processes of arbiters are not public processes. Attempting to observe them affects their outcomes. Instead of observing the internals of arbitration processes, we necessarily await outcomes. Indeterminacy in arbiters produces indeterminacy in Actors. The reason that we await outcomes is that we have no realistic alternative.

The Actor Model integrated the following:

- the lambda calculus
- interrupts
- blocking method invocation
- imperative programming using locks
- capabilities systems
- co-routines
- packet networks
- email systems
- Petri nets
- Smalltalk-72
- Simula-67
- pattern-directed invocation (from Planner)

In 1975, Irene Greif published the first operational model of Actors in her dissertation. Two years after Greif published her operational model, Carl Hewitt and Henry Baker published the Laws for Actors [Baker and Hewitt 1977].

Indeterminacy in Concurrent Computation

The first models of computation (*e.g.* Turing machines, Post productions, the lambda calculus, *etc.*) were based on mathematics and made use of a global

state to represent a computational *step* (later generalized in [McCarthy and Hayes 1969] and [Dijkstra 1976]). Each computational step was from one global state of the computation to the next global state. The global state approach was continued in automata theory for finite state machines and push down stack machines, including their nondeterministic versions.³³ Such nondeterministic automata have the property of bounded nondeterminism; that is, if a machine always halts when started in its initial state, then there is a bound on the number of states in which it halts.³⁴

Gordon Plotkin [1976] gave an informal proof as follows:

Now the set of initial segments of execution sequences of a given nondeterministic program P , starting from a given state, will form a tree. The branching points will correspond to the choice points in the program. Since there are always only finitely many alternatives at each choice point, the branching factor of the tree is always finite.³⁵ That is, the tree is finitary. Now König's lemma says that if every branch of a finitary tree is finite, then so is the tree itself. In the present case this means that if every execution sequence of P terminates, then there are only finitely many execution sequences. So if an output set of P is infinite, it must contain a nonterminating computation.³⁶

The above proof is quite general and applies to the Abstract State Machine (ASM) model [Blass, Gurevich, Rosenzweig, and Rossman 2007a, 2007b; Glausch and Reisig 2006], which consequently are not really models of concurrency. It also applies to the parallel lambda calculus, which includes all the capabilities of the nondeterministic lambda calculus. Researchers (before the Actor Model was invented) hypothesized that the parallel lambda calculus naturally modeled all of computation and their research programme was to reduce all computation to the parallel lambda calculus [Scott and Strachey 1971, Milne and Strachey 1976]. One of the important early discoveries in the development of the Actor Model was that all of computation is not reducible to the parallel lambda calculus. In fact, there are Actor computations that cannot be implemented in the parallel lambda calculus. For example, by the semantics of the Actor Model of computation [Clinger 1981] [Hewitt 2006], concurrently sending the Actor below both a **start** message and a **stop** message will result in returning an integer of unbounded size for the **stop** message.

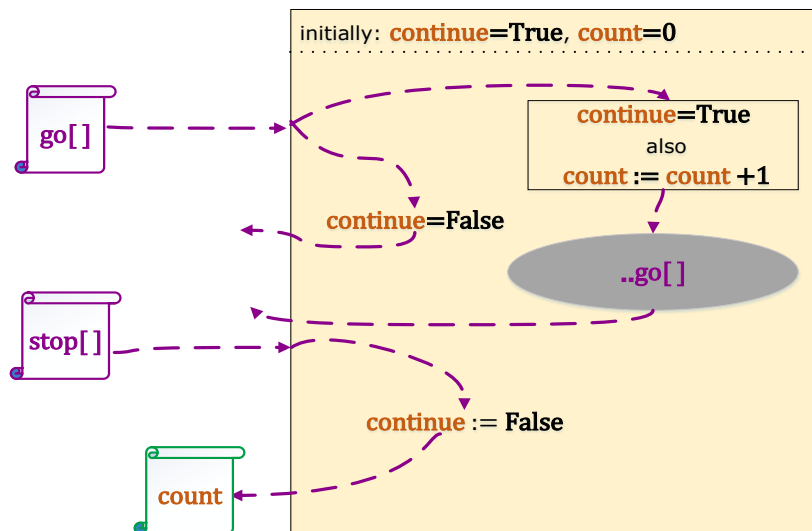

Theorem. There are nondeterministic computable functions on integers that cannot be implemented by a nondeterministic Turing machine.

Proof. The above Actor system implements a nondeterministic functionⁱ that cannot be implemented by a nondeterministic Turing machine.

ⁱ with graph $\{[] \rightsquigarrow 0, [] \rightsquigarrow 1, [] \rightsquigarrow 2, \dots\}$

Nondeterminism is a special case of Indeterminism.

Consider the following Nondeterministic Turing Machine that starts at *Step 1*:

Step 1: Either print 1 on the next square of tape or execute *Step 3*.

Step 2: Execute *Step 1*.

Step 3: Halt.

According to the definition of Nondeterministic Turing Machines, the above machine might never halt.

Note that the computations performed by the above machine are structurally different than the computations performed by the above counter Actor in the following way:

1. The decision making of the above Nondeterministic Turing Machine is internal (having an essentially psychological basis).
2. The decision making of the above counter Actor exhibits physical indeterminacy.

Edsger Dijkstra further developed the nondeterministic global state approach, which gave rise to a controversy concerning *unbounded nondeterminism*ⁱ. Unbounded nondeterminism is a property of concurrency by which the amount of delay in servicing a request can become unbounded as a result of arbitration of contention for shared resources *while providing a guarantee that the request will be serviced*. The Actor Model provides the guarantee of service. In Dijkstra's model, although there could be an unbounded amount of time between the execution of sequential instructions on a computer, a (parallel) program that started out in a well-defined state could terminate in only a bounded number of states [Dijkstra 1976]. He believed that it was impossible to implement unbounded nondeterminism.

Computation is not subsumed by logical deduction

Kowalski claims that "*computation could be subsumed by deduction*"³⁷ The gauntlet was officially thrown in *The Challenge of Open Systems* [Hewitt 1985] to which [Kowalski 1988b] replied in *Logic-Based Open Systems*.ⁱⁱ This was followed up with [Hewitt and Agha 1988] in the context of the Japanese Fifth Generation Project.

According to Hewitt, *et. al.* and contrary to Kowalski computation in general cannot be subsumed by deduction and contrary to the quotation (above)

ⁱ A system is defined to have *unbounded nondeterminism* exactly when both of the following hold:

1. When started, the system always halts.
2. For every integer n , the system can halt with an output that is greater than n .

ⁱⁱ [Kowalski 1979] forcefully stated:

There is only one language suitable for representing information -- whether declarative or procedural -- and that is first-order predicate logic. There is only one intelligent way to process information -- and that is by applying deductive inference methods.

attributed to Hayes computation in general is not subsumed by deduction. [Hewitt and Agha 1991] and other published work argued that mathematical models of concurrency did not determine particular concurrent computations because they make use of arbitration for determining the order in which messages are processed. These orderings cannot be deduced from prior information by mathematical logic alone. Therefore mathematical logic cannot implement concurrent computation in open systems.

A nondeterministic system is defined to have “*unbounded nondeterminism*”ⁱ exactly when both of the following hold:

1. When started, the system *always* halts.
2. For every integer n , it is possible for the system to halt with output that is greater than n .

This article has discussed the following points about unbounded nondeterminism controversy:

- A Nondeterministic Turing Machine cannot implement unbounded nondeterminism.
- A Logic Program³⁸ cannot implement unbounded nondeterminism.
- Semantics of unbounded nondeterminism are required to prove that a server provides service to every client.³⁹
- An Actor system [Hewitt, *et. al.* 1973] can implement servers that provide service to every client and consequently unbounded nondeterminism.
- Dijkstra believed that unbounded nondeterminism cannot be implemented [Dijkstra 1967; Dijkstra and van Gasteren 1986].
- The semantics of CSP [Francez, Hoare, Lehmann, and de Roever 1979] specified bounded nondeterminism for reasons mentioned above in the article. Since Hoare *et. al.* wanted to be able to prove that a server provided service to clients, the semantics of a subsequent version of CSP were switched from bounded to unbounded nondeterminism.
- Unbounded nondeterminism was but a symptom of deeper underlying issues with sequential processes using nondeterministic global states as a foundation for computation.ⁱⁱ

The Computational Representation Theorem [Clinger 1981, Hewitt 2006] characterizes the semantics of Actor Systems without making use of sequential processes.

ⁱ For example the following systems do *not* have unbounded nondeterminism:

- A nondeterministic system which sometimes halts and sometimes doesn't
- A nondeterministic system that always halts with an output less than 100,000.
- An operating system that never halts.

ⁱⁱ See [Knabe 1992].

Actor Model versus Classical Objects

The following are fundamental differences between the Actor Model and Classical Objects [Nygaard and Dahl 1967, Nygaard 1986]:

- Classical Objects⁴⁰ are founded on “a physical model, simulating the behavior of either a real or imaginary part of the world”⁴¹, whereas the Actor Model is founded on the physics of computation.
- Every Classical Object⁴² is an instance of a Classⁱ in a hierarchy⁴³, whereas an Actor can implement multiple interfaces.⁴⁴
- Virtual Procedures can be used to operate on Objects, whereas messagesⁱⁱ can be sent to Actors.⁴⁵

Unfortunately, Objects remain ill-defined. Consequently, the term “Object” has been used in inconsistent ways in the literature.

Hairy Control Structure

Peter Landin introduced a powerful co-routine control structure using his **J** (for Jump) operator that could perform a nonlocal goto into the middle of a procedure invocation [Landin 1965]. In fact the **J** operator enabled a program to jump back into the middle of a procedure invocation even after it had already returned!

[Reynolds 1972] introduced control structure continuations using a construct called **escape** that is a more structured version of Landin's **J** operator. Sussman and Steele called their variant of **escape** by the name “*call with current continuation*.” General use of **escape** is not compatible with usual stack discipline introducing considerable operational inefficiency. Also, using *escape* can leave customers stranded. Consequently, use of **escape** is generally avoided these days and exceptions⁴⁶ are used instead so that clean up can be performed.

In the 1960's at the MIT AI Lab a remarkable culture grew up around “*hacking*” that concentrated on remarkable feats of programming.⁴⁷ Growing out of this tradition, Gerry Sussman and Guy Steele decided to try to understand Actors by reducing them to machine code that they could understand and so developed a “*Lisp-like language, Scheme, based on the lambda calculus, but extended for side effects, multiprocessing, and process synchronization*.” [Sussman and Steele 1975].⁴⁸

ⁱ A Class is an implementation of an Actor.

ⁱⁱ A message can be one-way and each must be of type **Message**.

Their reductionist approach included primitives like the following:
START!PROCESS, STOP!PROCESS, and
EVALUATE!UNINTERRUPTIBLEY.¹

Of course, the above reductionist approach is unsatisfactory because it missed a crucial aspect of the Actor Model: *the reception ordering of messages*.

Using the **J** operator, McDermott, and Sussman [1972] developed the Lisp-based language Conniver based on “hairy control structure” that could implement non-chronological backtracking that was more general than the chronological backtracking in Planner. However, hairy control structure did not work out well in practice because it was very difficult to understand and debug procedures that could return more than once.

Pat Hayes remarked:

Their [Sussman and McDermott] solution, to give the user access to the implementation primitives of Planner, is however, something of a retrograde step (what are Conniver's semantics?). [Hayes 1974]

Hewitt had concluded:

*One of the most important results that has emerged from the development of Actor semantics has been the further development of techniques to semantically analyze or synthesize control structures as patterns of passing messages. As a result of this work, we have found that we can do without the paraphernalia of “hairy control structure.”*⁴⁹(emphasis in original)

Sussman and Steele [1975] noticed some similarities between Actor programs and the lambda calculus. They mistakenly concluded that they had reduced Actor programs to a “continuation-passing programming style”:

It is always possible, if we are willing to specify explicitly what to do with the answer, to perform any calculation in this way: rather than reducing to its value, it reduces to an application of a continuation to its value. That is, in this continuation-passing programming style, a function always “returns” its result by “sending” it to another function.
(emphasis in original)

However, some Actor programming language constructs are not reducible to a continuation-passing style. For example, futures are not reducible to continuation-passing style.

On the basis of their experience, Sussman and Steele developed the general thesis that Actors were merely the lambda calculus in disguise. Steele [1976] in the section “Actors \equiv Closures (mod Syntax)” disagreed with Hewitt who had

¹ “This is the synchronization primitive. It evaluates an expression uninterruptedly; i.e. no other process may run until the expression has returned a value.”

“expressed doubt as to whether these underlying continuations can themselves be expressed as lambda expressions.” However, customers cannot be expressed as lambda expressions because doing so would preclude being able to enforce the requirement that a customer will process at most one response (*i.e.* exception or value return). Also implementing customers as lambda expressions can leave customers stranded.

In summary, Sussman and Steele [1975] mistakenly concluded “we discovered that the ‘Actors’ and the lambda expressions were identical in implementation.”⁵⁰ The actual situation is that the lambda calculus is capable of expressing some kinds of sequential and parallel control structures but, in general, *not* the concurrency expressed in the Actor Model.⁵¹ On the other hand, the Actor Model is capable of expressing everything in the parallel lambda calculus [Hewitt 2008f] and is exponentially faster for important applications like information coordination [Hewitt 2012].

For example, futures can be adaptively created to do the kind of computation performed by hairy structure. [Hewitt 1974] invented the same-fringe problem as an illustration where the “fringe” of a tree is a list of all the leaf nodes of the tree.

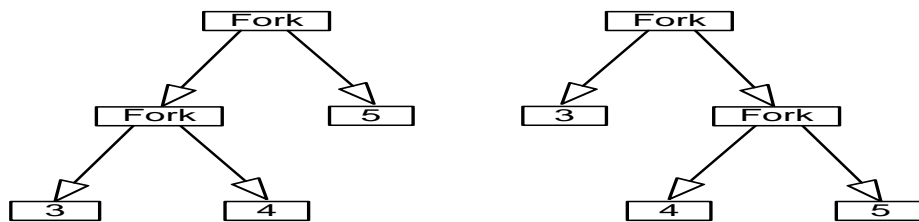

Two trees with the same fringe [3 4 5]

Below is the definition of a procedure that computes a **FutureList** that is the “fringe” of the leaves of tree.

```
Fringe.[aTree:Tree]:FutureList ≡
  aTree ♦ Leaf[x] ⚡ [x]
  Fork[tree1, tree2] ⚡
  [VFringe.[tree1], VPostpone Fringe.[tree2]]
```

The above procedure can be used to define SameFringe that determines if two lists have the same fringe [Hewitt 1972]:

```
SameFringe.[aTree:Tree, anotherTree:Tree]:Boolean ≡
  // test if two trees have the same fringe
  Fringe.[aTree]=Fringe.[anotherTree]■
```

Using Actors in this way obviates the need for explicit co-routine constructs, *e.g.*, `yield` in C# [ECMA 2006], JavaScript [ECMA 2014], *etc.*

Early Actor Programming languages

Henry Lieberman, Dan Theriault, *et al.* developed Act1, an Actor programming language. Subsequently for his master's thesis, Dan Theriault developed Act2. These early proof of concept languages were rather inefficient and not suitable for applications. In his doctoral dissertation, Ken Kahn developed Ani, which he used to develop several animations. Bill Kornfeld developed the Ether programming language for the Scientific Community Metaphor in his doctoral dissertation. William Athas and Nanette Boden [1988] developed Cantor which is an Actor programming language for scientific computing. Jean-Pierre Briot [1988, 1999] developed means to extend Smalltalk 80 for Actor computations. Darrell Woelk [1995] at MCC developed an Actor programming language for InfoSleuth agents in Rosette.

Hewitt, Attardi, and Lieberman [1979] developed proposals for delegation in message passing. This gave rise to the so-called inheritance anomaly controversy in concurrent programming languages [Satoshi Matsuoka and Aki Yonezawa 1993, Giuseppe Milicia and Vladimiro Sassone 2004]. ActorScript [Hewitt 2010] has proposal for addressing delegation issues.

Garbage Collection

Garbage collection (the automated reclamation of unused storage) was an important theme in the development of the Actor Model.

In his doctoral dissertation, Peter Bishop developed an algorithm for garbage collection in distributed systems. Each system kept lists of links of pointers to and from other systems. Cyclic structures were collected by incrementally migrating Actors (objects) onto other systems which had their addresses until a cyclic structure was entirely contained in a single system where the garbage collector could recover the storage.

Henry Baker developed an algorithm for real-time garbage collection in his doctoral dissertation. The fundamental idea was to interleave collection activity with construction activity so that there would not have to be long pauses while collection takes place.

Lieberman and Hewitt [1983] developed a real time garbage collection based on the lifetimes of Actors (Objects). The fundamental idea was to allocate Actors (objects) in generations so that only the latest generations would have to be examined during a garbage collection.

Cosmic Cube

The Cosmic Cube was developed by Chuck Seitz *et al.* at Caltech providing architectural support for Actor systems. A significant difference between the Cosmic Cube and most other parallel processors is that this multiple instruction multiple-data machine used message passing instead of shared variables for

communication between concurrent processes. This computational model was reflected in the hardware structure and operating system, and also the explicit message passing communication seen by the programmer.

Communicating Sequential Processes

Arguably, the first concurrent programs were interrupt handlers. During the course of its normal operation, a computer needed to be able to receive information from outside (characters from a keyboard, packets from a network, *etc.*). So when the information was received, execution of the computer was “interrupted” and special code called an interrupt handler was called to *put* the information in a buffer where it could be subsequently retrieved.

In the early 1960s, interrupts began to be used to simulate the concurrent execution of several programs on a single processor. Having concurrency with shared memory gave rise to the problem of concurrency control. Originally, this problem was conceived as being one of mutual exclusion on a single computer. Edsger Dijkstra developed semaphores. In contrast, the Actor Model does *not* take classical sequential processes as primitive and is *not* built on communicating sequential processes.

Dijkstra was certain that unbounded nondeterminism is impossible to implement. Hoare was convinced by Dijkstra's argument. Consequently, the semantics of CSP specified bounded nondeterminism.

Consider the following program written in CSP [Hoare 1978]:

```

[X :: Z!stop()           ① In process X, send Z a stop message
  ||                     ① process X operates in parallel with process Y
  Y :: guard: boolean; guard := true;
      ① In process Y, initialize boolean variable guard to true and then
      *[guard → Z!go(); Z?guard]
      ① while guard is true, send Z a go message and then input guard from Z
  ||                     ① process Y operates in parallel with process Z
  Z :: n: integer; n:= 0; ① In process Z, initialize integer variable n to 0 and then
      continue: boolean; continue := true;
      ① initialize boolean variable continue to true and then
      *[]
      X?stop() → continue := false;
      ① input a stop message from X, set continue to false and then
      Y!continue; ① send Y the value of continue
      ||
      Y?go() → n := n+1;
      ① input a go message from Y, increment n, and then
      Y!continue]] ① send Y the value of continue

```

According to Clinger [1981]:

this program illustrates global nondeterminism, since the nondeterminism arises from incomplete specification of the timing of signals between the three processes X, Y, and Z. The repetitive guarded command in the definition of Z has two alternatives: either the stop message is accepted from X, in which case `continue` is set to false, or a go message is accepted from Y, in which case `n` is incremented and Y is sent the value of `continue`. If Z ever accepts the stop message from X, then X terminates. Accepting the stop causes `continue` to be set to false, so after Y sends its next go message, Y will receive false as the value of its guard and will terminate. When both X and Y have terminated, Z terminates because it no longer has live processes providing input.

As the author of CSP points out, therefore, if the repetitive guarded command in the definition of Z were required to be fair, this program would have unbounded nondeterminism: it would be guaranteed to halt but there would be no bound on the final value of `n`. In actual fact, the repetitive guarded commands of CSP are not required to be fair, and so the program may not halt [Hoare 1978]. This fact may be confirmed by a tedious calculation using the semantics of CSP [Francez, Hoare, Lehmann, and de Roever 1979] or simply by noting that the semantics of CSP is based upon a conventional power domain and thus does not give rise to unbounded nondeterminism.

But Hoare knew that trouble was brewing because for several years, proponents of the Actor Model had been beating the drum for unbounded nondeterminism. To address this problem, he suggested that implementations of CSP should be as close as possible to unbounded nondeterminism! But his suggestion was difficult to achieve because of the nature of communication in CSP using nondeterministic select statements (from nondeterministic state machines, *e.g.*, [Dijkstra 1976]), which in the above program which takes the form

$$\begin{array}{l} [X?stop() \rightarrow \dots \\ \quad [] \\ Y?go() \rightarrow \dots] \end{array}$$

The structure of CSP is fundamentally at odds with guarantee of service.

Using the above semantics for CSP, it was impossible to formally prove that a server actually provides service to multiple clients (as had been done previously in the Actor Model). That's why the semantics of CSP were reversed from bounded non-determinism [Hoare CSP 1978] to unbounded non-determinism [CSP:1985]. However, bounded non-determinism was but a symptom of deeper underlying issues with nondeterministic transitions in communicating sequential processes (see [Knabe 1992]).

Smalltalk-80

Smalltalk-72 progressed to Smalltalk-80[Alan Kay, Dan Ingalls, Adele Goldberg, Ted Kaehler, Diana Merry, Scott Wallace, Peter Deutsch], which introduced the code browser as an important innovation.

For example, the following diagram depicts a code-browser window:

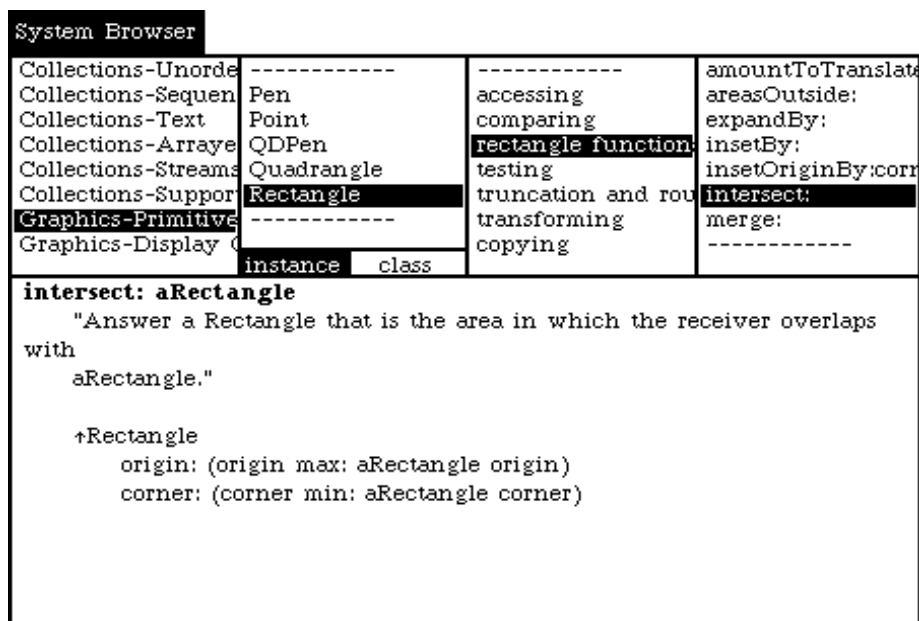

π -Calculus Actors

Robin Milner's initial published work on concurrency [Milner 1973] was notable in that it was not overtly based on sequential processes, although computation still required sequential execution (see below).

His work differed from the previously developed Actor Model in the following ways:

- There are a fixed number of processes as opposed to the Actor Model which allows the number of Actors to vary dynamically
- The only quantities that can be passed in messages are integers and strings as opposed to the Actor Model which allows the addresses of Actors to be passed in messages
- The processes have a fixed topology as opposed to the Actor Model which allows varying topology
- Communication is synchronous as opposed to the Actor Model in which an unbounded time can elapse between sending and receiving a message.

- Unlike the Actor Model, there is no reception ordering and consequently there is only bounded nondeterminism. However, with bounded nondeterminism it is impossible to prove that a server guarantees service to its clients, *i.e.*, a client might starve.

Building on the Actor Model, Milner [1993] removed some of these restrictions in his work on the π -calculus:

Now, the pure lambda-calculus is built with just two kinds of thing: terms and variables. Can we achieve the same economy for a process calculus? Carl Hewitt, with his Actors model, responded to this challenge long ago; he declared that a value, an operator on values, and a process should all be the same kind of thing: an Actor.

This goal impressed me, because it implies the homogeneity and completeness of expression ...

So, in the spirit of Hewitt, our first step is to demand that all things denoted by terms or accessed by names--values, registers, operators, processes, objects--are all of the same kind of thing....

However, some fundamental differences remain between the Actor Model and the π -calculus:

- The Actor Model is founded on physics whereas the π -calculus is founded on algebra.
- Semantics of the Actor Model is based on message orderings in the Computational Representation Theorem. Semantics of the π -calculus is based on structural congruence in various kinds of bi-simulations and equivalences.⁵²

Communication in the π -calculus takes the following form:

- *input*: $u[x].P$ is a process that gets a message from a communication channel u before proceeding as P , binding the message received to the identifier x . In ActorScript [Hewitt 2010a], this can be modeled as follows:
Let $x \leftarrow u.get[]$ ● P ⁵³
- *output*: $\bar{u}[m].P$ is a process that puts a message m on communication channel u before proceeding as P . In ActorScript, this can be modeled as follows: $u.put[x]$ ● P ⁵⁴

The above operations of the π -calculus can be implemented in Actor systems using a two-phase commit protocol [Knabe 1992; Reppy, Russo, and Xiao 2009]. The overhead of communication in the π -calculus presents difficulties to its use in practical applications.

Process calculi (*e.g.* [Milner 1993; Cardelli and Gordon 1998]) are closely related to the Actor Model. There are similarities between the two approaches, but also many important differences (philosophical, mathematical and engineering):

- There is only one Actor Model (although it has numerous formal systems for design, analysis, verification, modeling, etc.) in contrast with a variety of species of process calculi.
- The Actor Model was inspired by the laws of physics and depends on them for its fundamental axioms in contrast with the process calculi being inspired by algebra [Milner 1993].
- Unlike the Actor Model, the sender is an intrinsic component of process calculi because they are defined in terms of reductions (as in the lambda calculus).
- Processes in the process calculi communicate by sending messages either through channels (synchronous or asynchronous), or via ambients (which can also be used to model channel-like communications [Cardelli and Gordon 1998]). In contrast, Actors communicate by sending messages to the addresses of other Actors (this style of communication can also be used to model channel-like communications using a two-phase commit protocol [Knabe 1992]).

There remains a Great Divide between process calculi and the Actor Model:

- *Process calculi*: algebraic equivalence, bi-simulation [Park 1980], etc.
- *Actor Model*: futures [Baker and Hewitt 1977], Swiss cheese, garbage collection, etc.

J–Machine

The J–Machine was developed by Bill Dally *et al.* at MIT providing architectural support suitable for Actors.

This included the following:

- Asynchronous messaging
- A uniform space of Actor addresses to which messages could be sent concurrently regardless of whether the recipient Actor was local or nonlocal
- A form of Actor pipelining

Concurrent Smalltalk (which can be modeled using Actors) was developed to program the J Machine.

“Fog Cutter” Actors

[Karmani and Agha 2011] promoted “*Fog Cutter*”ⁱ Actors each of which is required to have a mailbox, thread, state, and program diagrammed as follows:⁵⁵

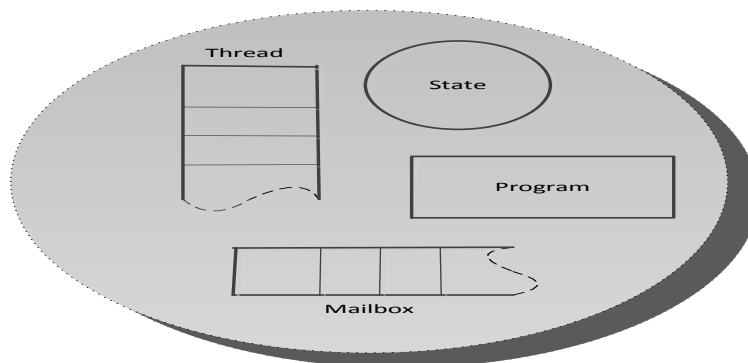

**Process a message from the Mailbox using the Thread,
then reset the Thread stack thereby completing the message-passing turn**

Fog Cutter Actors are special cases in that the following restrictions hold:ⁱⁱ

- *Each Fog Cutter Actor has a ‘mailbox’*. But if everything that interacts is an Actor, then a mailbox must be an Actor and so in turn needs a mailbox which in turn ... [Hewitt, Bishop, and Steiger 1973]. Of course, mailboxes having mailboxes is an infinite regress that has been humorously characterized by Erik Meijer as “down the rabbit hole.” [Hewitt, Meijer, and Szyperski 2012]
- *A Fog Cutter Actor ‘terminates’ when every Actor that it has created is ‘idle’ and there is no way to send it a message*. In practice, it is preferable to use garbage collection for Actors that are inaccessible. [Baker and Hewitt 1977]
- *Each Fog Cutter Actor executes a ‘loop’ using its own sequential ‘thread’ that begins with receiving a message followed by possibly creating more Actors, sending messages, updating its local state, and then looping back for the next message to complete a ‘turn’*. In practice, it is preferable to provide “Swiss cheese” by which an Actor can concurrently process multiple messages without the limitation of a sequential thread loop. [Hewitt and Atkinson 1977, 1979; Atkinson 1980; Hewitt 2011]
- *A Fog Cutter Actor has a well-defined local ‘autonomous’ ‘state’ that can be updated*⁵⁶ *while processing a message*. However, because of indeterminacy an Actor may not be in a well-defined local independent state. For example, Actors might be entangled⁵⁷ with each other so that

ⁱ so dubbed by Kristen Nygaard (private communication).

ⁱⁱ “Fog Cutter” is in *italics*.

their actions are correlated. Also, large distributed Actors (*e.g.* www.dod.gov) do not have a well-defined state. In practice, it is preferable for an Actor not to change its local information while it is processing a message and instead specify to how it will process the next message received (as in ActorScript [Hewitt 2011]).

Fog Cutter Actors have been extremely useful for exploring issues about Actors including the following alternatives:

- **Reception order of messaging** instead of *Mailbox*
- **Activation order of messaging** instead of *Thread*
- **Behavior** instead of *State+Program*

However, Fog Cutter Actors are fundamentally lacking in generality because they lack the holes of Swiss cheese.ⁱ

In practice, the most common and effective way to explain Actors has been *operationally* using a suitable Actor programming language (*e.g.*, ActorScript [Hewitt 2012]) that specifies how Actors can be implemented along with an English explanation of the axioms for Actors (*e.g.*, as presented in this paper).

Erlang Actors

Erlang Actors [Armstrong 2010] are broadly similar to Fog Cutter Actors:

1. Each Erlang Actor not share memory addresses with other Erlang Actors.
2. An Erlang Actor can retrieve a message from its mailbox by selectively removing a message matching a particular pattern.

Erlang made important contributions by emphasizing the importance of the following:

- referential transparency
- failure handling

However, Erlang Actors have the following issues:

- Messaging in Erlang is not robust because a sent message will be dropped without warning if there is no Actor for the address.ⁱⁱ
- Erlang imposes high overhead in sending messages between Actors. For example, it imposes coordination overhead that messages sent between two Erlang Actors are delivered in the order they are sent.
- Implementations of Erlang do not make efficient use of many-core coherent architectures because messages between Erlang Actors must be blobs.ⁱⁱⁱ

ⁱ See section on Swiss cheese in this article.

ⁱⁱ Such silent failures are a bane of robust software engineering.

ⁱⁱⁱ A blob is a data structure that cannot contain pointers.

- Instead of using exception handling, until recently Erlang relied on process failureⁱ propagating between processes and their spawned processes.
- Instead of using garbage collection to recover storage and processing of unreachable Actors, each Erlang Actor must perform an internal termination or be killed externally.⁵⁸
- Erlang does not have parameterized types, Actor aspects, interfaces or type discriminations.

Erlang Actors have been used in high-performance applications. For example, Ericsson uses Erlang in 3G mobile networks worldwide [Ekeröth and Hedström 2000].

Squeak

Squeak [Ingalls, Kaehler, Maloney, Wallace, and Kay 1997] is a dialect of Smalltalk-80 with added mechanisms of islands, asynchronous messaging, players and costumes, language extensions, projects, and tile scripting. Its underlying object system is class-based, but the user interface is programmed as though it is prototype-based.

Orleans Actors

Orleans [Bykov, Geller, Kliot, Larus, Pandya, and Thelin 2010; Bernstein, Bykov, Geller, Kliot, and Thelin 2014] is a *distributed* implementation of Actors that transparently sends messages between Actors on different computers enabling greater scalability and reliability of practical applications.

Orleans is based on single-threaded Actor message invocations. An Actor processes a message using a thread from a thread pool. When the message has been processed, the thread can be returned to the thread pool.⁵⁹

That an Orleans Actor does not share memory with other Actors is enforced by doing a deep copy of messages if required.

ⁱ based on an arbitrary time-out

A globally unique identifier⁶⁰ is created for each Orleans Actor with a consequence that there is extra storage overhead that can be significant for a very small Orleans Actor.⁶¹ A globally unique identifier can be used to send a message, which will, if necessary, create an activation⁶² of an Orleans Actor in the memory of a process.⁶³

Orleans has the following issues:

- Orleans allows the use of strings and long integers as globally unique identifiers in order to provide for perpetual Actors whose storage can only be collected using potentially unsafe means, which can result in a dangling globally unique identifier.
- A system design choice was made in Orleans not to use automated storage reclamation technology (garbage collection) to keep track of whether an Orleans Actor could have been forgotten by all applications and thus become inaccessible. Consequently, Orleans can have the following inefficiencies:
 - A short-lived Orleans Actor that has become inaccessible *does not have its storage in the process quickly recycled* resulting in a larger working set and decreased locality of reference.⁶⁴
 - A long-lived Orleans Actor that has become inaccessible *does not ever have its storage recycled*⁶⁵ resulting in larger memory requirements.⁶⁶ However, collection of the storage of long-lived Actors is not so important in some applications because long-term memory has become relatively inexpensive.

An Orleans Actor ties up a thread while it is taking a turn to process a message regardless of the amount of time required, *e.g.*, time to make a system call. In this way, Orleans avoids timing races in the value of a variable of an Actor.ⁱ

A consequence of being single-threaded can be reduced performance of Orleans Actors as follows:

- lack of parallelism in processing a message
- lack of concurrency between processing a message and executing waiting method calls invoked by processing the message.⁶⁷
- thread-switching overhead between sending and receiving a message to an Orleans Actor in the same process⁶⁸

ⁱ ActorScript goes even further in this direction by enforcing that the value of a variable can change only when it is leaving the cheese or before/after an internal delegated operation.

A waiting method call can be resolved using the **await**⁶⁹ construct as follows:

```
await anActor.aMethodName(...)i
```

For example:

```
var anActor = aFactory.GetActor(aGloBallyUniqueIdentifier);  
try {...aUse(await anActor.aMethodName(...))...  
      anotherUse(await anActor.anotherMethodName(...))...}  
catch ...;70
```

When reentrancy⁷¹ is enabled, the method calls for *aMethodName* and *anotherMethodName* above are executed *after* the current message-processing turn:

- If completed successfully, the value of a waiting method call is supplied in a *new* turn at the point of method invocation, *e.g.*, the value of the method call for *aMethodName* of is supplied to *aUse*.
- If a waiting method call throws an exception, it is given to the exception handler in a new turn.

Orleans uses C# compiler “stack ripping” to use behind-the-scenes sequential turns to execute waiting method calls.

A message sent to an Orleans Actor must return a promise⁷² Actor⁷³, which is a version of a future Actor. A promise Actor for a method call *anActor.aMethodName(...)* can be created using the following code:ⁱⁱ

```
try {return Task.FromResult(await anActor.aMethodName(...));}  
catch (Exception anException)  
      {return Task.FromException(anException);}iii
```

Note that a promise is *not* an Orleans Actor because it does not have a globally unique identifier.^{iv}

One of the motivations for the requirement that Orleans Actors must return promises when sent messages is to enable the **await** construct to *hide* promises so that clients of Orleans Actors do not have to deal with the return type `Task<T>` of each Orleans Actor method call for some application type `T`.

Orleans is an important step in furthering a goal of the Actor Model that application programmers need not be so concerned with low-level system

ⁱ ActorScript uses **@aFuture** to resolve *aFuture*

ⁱⁱ ActorScript uses **Future anExpression** to create a future for *anExpression*

ⁱⁱⁱ There is an inefficiency in the above code in that the method call returns a promise that is taken apart and then an equivalent promise is created to be returned.

^{iv} It would be impractical for promises to be Orleans Actors because

- they are created as the return value of *every* Orleans Actor method call
- the storage of inaccessible Orleans Actors is *not* recovered, *e.g.*, using garbage collection

details.ⁱ For example, in moving to the current version, Orleans reinforces the current trend of not exposing customer Actors⁷⁴ to application programmers.⁷⁵

As a research project, Orleans had to make some complicated tradeoffs to implement more reliable distributed Actors. Implementing Actor systems that are both *robust* and *performant* is an extremely challenging research project that has taken place over many decades. More research remains to be done. However, Orleans has already been used in some high-performance applications including multi-player computer games, *e.g.*, Halo[Bykov 2013, Stenberg 2015].

JavaScript Actors

JavaScript Actors are broadly similar to Fog Cutter Actors.⁷⁶

A *promise*⁷⁷ in JavaScript is a kind of future. JavaScript⁷⁸ will include asynchronous procedures as well as an **await**⁷⁹ construct that can be used to resolve promise Actors.

An asynchronous procedure *always*ⁱⁱ returns a promise. For example, the following procedure computes a promise for the sum of two promises:

```
async function PromiseForSumOfPromises(aPromise, anotherPromise)
  {return (await aPromise) + await anotherPromise};
```

A promise for an expression can be created by the procedure `CreatePromise`⁸⁰, which takes a thunk⁸¹ for the expression as its argument. For example, suppose we have the following:ⁱⁱⁱ

```
async function PromiseForSumOfTwoSlowCalls( )
  {const promise1 := CreatePromise(() => aSlowActor.do(10, 20));
   const promise2 := CreatePromise(() => aSlowActor.do(30, 40));
   return await PromiseForSumOfPromises(promise1, promise2)
  };
```

In an *asynchronous* procedure, **await** `PromiseForSumOfTwoSlowCalls()` is equivalent to the following in ActorScript:

```
(⊙Future aSlowActor.do[10, 20]) + ⊙Future aSlowActor.do[30,40]
```

To implement parallelism, JavaScript has workers.⁸² Although multiple workers can reside in a process, they do not share memory addresses and consequently cannot efficiently communicate using many-core coherency. A

ⁱ *e.g.* threads, throttling, load distribution, cores, persistence, automated storage reclamation, locks, location transparency, channels, ports, *etc.*

ⁱⁱ The use of asynchronous procedures can be contagious because a procedure using the return value of an asynchronous procedure needs to be asynchronous to use **await**.

ⁱⁱⁱ The code is written in this way to emphasize that an asynchronous procedure *always* returns a promise.

worker communicates with other workers using blobsⁱ in order to guarantee memory separation. Each worker acts as a *single-threaded, non-preemptive* time-sharing system for processing messages for Actors that reside in its memory.⁸³

However, JavaScript workers have the following efficiency issues:⁸⁴

1. There is no parallelism in processing messages for different Actors on a worker and the processing of a message by a slowly executing Actor *cannot* be preempted thereby bringing *all*ⁱⁱ other work on the worker to a *standstill*.ⁱⁱⁱ
2. An Actor on a worker can directly send a message an Actor on another worker only if the recipient has been transferred to the worker on which the sender resides.⁸⁵ An Actor can also indirectly send a blobbed message using a **MessageChannel**.
3. A very difficult efficiency issue is to decide how many Actors to put on each worker and which Actors to put on which worker.

JavaScript workers limit much of the modularity and efficiency available in coherent many-core processor architectures. Inherent inefficiencies and architectural deficiencies in JavaScript workers and HTML5 standards handicap^{iv} browsers in their competition with apps.

Capabilities Systems

Capabilities were proposed in order to provide protection in operating systems [Dennis and van Horn 1966] by placing authority to take certain actions in special lists stored in protected memory of the operating system. Capabilities originated as part of the MIT Multics Project whereas Actors originated at the AI Lab, which developed Lisp machines with a tagged-memory architecture (instead of special lists stored in the operating system) that could be used to implement secure Actor addresses. Lisp machines were not commercially successful because the developing companies were under-capitalized and lacked an adequate software foundation. Unfortunately, tagged-memory

ⁱ A blob is a data structure that cannot contain pointers. In the past, a more limited meaning called **BLOB** has been used as an acronym for **B**inary **L**arge **O**bject. In the Actor Model, an address (which is typed) can be used to send a message to an Actor. The model does not specify the physical representation of an address. So an address might be a (tagged) pointer. However, such pointers are not allowed in blobs.

ⁱⁱ including any queued promises

ⁱⁱⁱ Issues of non-preemption motivated the invention of time-slicing [Bemer 1957] by which tasks are switched at the expiration of a timer.

^{iv} due mainly to the legacy requirement not to break the Web. W3C and ECMA have done excellent work ameliorating the worst problems.

architectures fell out of fashion subsequently causing enormous security problems in our current cyber systems.⁸⁶

One of the motivations for developing the Actor Model in 1972 was that capabilities were awkward to use because their addresses were allocated in private memory of operating systems. Using tagged memory on Lisp Machines was a preferred implementation for Actors as opposed to using segmented memory on Multics. Also, the terms “capability” and “capabilities system” lacked axiomatizations and denotational semantics.

According to [Saltzer and Schroeder 1975]:

In a computer system, a capability is an unforgeable ticket, which when presented can be taken as incontestable proof that the presenter is authorized to have access to the object named in the ticket.

In contrast:

An Actor *address* is defined to be a shareableⁱ digital tokenⁱⁱ that together with a typeⁱⁱⁱ provides the ability to send a message^{iv} to the address.^v

ⁱ subject to type constraints

ⁱⁱ Not requiring that an Actor address is always required to be unguessable can allow for more efficient implementations. For example, suppose that amount1 and amount2 are both of type **Euro**. It might be that case that amount1 and amount2 are unboxed, *i.e.*, the respective amounts are encoded in their addresses.

ⁱⁱⁱ which is an Actor

^{iv} which is an Actor

^v For example in the following, **HTTPS**["google.com"] is an Actor address that can be used as follows to send a **get** message to Google:

HTTPS["google.com"].**get**[]

The following are some differences between Actor addresses and the Saltzer/Schroeder definition of capability:

- An address need not be unforgeable although it is typically unguessableⁱ.
- Unlike a capabilityⁱⁱ, an Actor address *per se* does not authorize anything. However, an Actor address together with a type enables a message to be sent to the address.ⁱⁱⁱ
- A message sent to an address does not have to be honored. However, it is generally good practice for an Actor to respond with an exception if it dishonors a message.

According to [Levy 1985]:

“Conceptually, a capability is a token, ticket, or key that gives the possessor permission to access an entity or object in a computer system. A capability is implemented as a data structure that contains two items of information: a unique object identifier and access rights.”

The above notion of capability can be modeled as a very specialized proxy Actor that filters messages.

Historically, capabilities have been handicapped by *awkwardness*, *vagueness*, *over-specialization*, *not being integrated with types*, and for being *single-computer centric*.⁸⁷

- **Awkwardness:** It is awkward to program in a system that requires permissions to be kept in lists maintained in operating systems memory.
- **Vagueness:** The [Saltzer and Schroeder 1975] definition above of a capability suffers from vagueness in specifying exactly what constitutes “access” to an object.
- **Over-specialization:** The [Levy 1985] definition above of a capability suffers from the additional limitation of over-specialization in that it specifies a particular data structure with two items.
- **Not integrated with types:** Capabilities were not integrated with the type systems of programming languages.
- **Single-computer centric:** Keeping permissions in lists maintained in the operating system memory makes coordination with other computers awkward.

ⁱ For example, an Actor address 4 of type **Integer** is plainly not unguessable.

ⁱⁱ In a capability, designation and permissions are inextricably bound together.

ⁱⁱⁱ The message might not actually be received for a variety of potential reasons. For example, because it is not properly received by an app for the intended recipient, because it is not properly received by a computer the for intended recipient, *etc.* It is good practice to throw an exception if a response is not received within some “reasonable” time.

Capabilities were further developed in [Organick 1983; Levy 1984; Chander, Dean, and Mitchell 2001; Shapiro and Adams 2007; Woodruff, *et. al.* 2014; Watson, *et. al.* 2015]. Unfortunately, capabilities have continued to be awkward to use because their addresses were allocated in private memory of operating systems. [Kwon, *et. al.* 2014] is a tagged capability architecture that includes a special register to hold capabilities for addresses. Capabilities systems can be considered to be approaches to security making use of specified principles [Miller 2006] that must include the locality laws of the Actor Model [Baker and Hewitt 1977].

The vision that motivated creation and development of the Actor Model is now coming into fruition in the **Internet of Things** with the following aspects [Hewitt 2015/2016]:

- Systems must function robustly even though at any time a computer can become temporarily or permanently unavailable.
- Systems must function as robustly as possible even though connections between computers can be intermittent.

A citizen will share a great deal of sensitive personal information among their insulin pump, bedroom TV, cell phone, home router, and potentially even a brain implant (new DARPA project).ⁱ Consequently, security of sensitive information heavily relies on encryption.

One of the fundamental principles is to use unguessable addresses for Actors on remote computers.ⁱⁱ In general, having an unguessable address and its type provides the computer that receives the unguessable address an opportunity to send a message to the address.⁸⁸

The only ways that an Actor can acquire an unguessable address is to be given the information to compute it from a combination of the following:

1. Using addresses provided by creating other Actors
2. Using addresses received in messages

*In practice, the information to compute an unguessable address must have come from the creator of the Actor for the unguessable address.*⁸⁹ Consequently, using unguessable Actor addresses provides significant security in helping confine sensitive personal information in the IoT devices owned by a citizen.

ⁱ Without warning, any of the above may fail permanently and have to be replaced. While the replacement is happening, life must continue as smoothly as possible.

ⁱⁱ both of the following are needed to securely and efficiently implement Actor addresses [Hewitt 1980, Miller 2006]:

1. tagged pointers in an address space
2. unguessable addresses sent to other computers

The intent of a [Saltzer and Schroeder 1975] capability is to *guarantee authorization to have access*, whereas the intent of an Actor address is to provide *an opportunity to send messages*. That is, an Actor address for IoT is **not** “incontestable proof of authorization to have access” because “authorization” and/or “access” might be prevented by *any* of the following:

1. the address being on another computer than an intended recipient may not decrypt using a type and consequently cannot be used for sending a message for that type
2. a message sent using the address and a type might not be received because message decryption might fail or authorization might fail at an app, computer, or router boundary along the path to a potential recipient
3. the message might be rejected at a recipient's computer because the message does not decrypt using the type of the recipient
4. an exception might be thrown by the recipient performing security checks disallowing access.

Furthermore, an Actor address has functionality beyond that of a [Saltzer and Schroeder 1975] capability. For example, a type might use an Actor address in upcasting, downcasting, or casting to an interface of an Actor as in ActorScript (see below).

The following definition of “capability” for the *Internet of Things* aims for both *precision* and *practicality*:ⁱ

A *capability* is defined to be an unguessableⁱⁱ, shareable digital designation that indivisibly combines permission and ability to perform operations on an objectⁱⁱⁱ implemented on some system that has certain security properties, *e.g.*, those specified in the Actor Model for unguessable addresses.^{iv}

The following difference is apparent:

- Capabilities are *prescriptive* specifying system properties which must hold.
- Actors are for *modeling* and *implementation*. Any digital computation can be *directly* modeled using Actors. ActorScript can *directly* efficiently implement any Actor system.^v Of course, good engineering principles and practices should be strongly encouraged.

ⁱ The following are examples of capabilities:

- Waterken [Close 2008]: an Actor address of type **WebKey**
- Zebra Copy [Karp and Li 2007]: an Actor address together with additional information that includes a list of allowed message types

ⁱⁱ In the Internet of Things, a designation of an object on a remote computer is unguessable but technically not unforgeable because it makes use of encryption for security. However, it is possible to use a capability that is technically unforgeable even though it is based on an unguessable (but forgeable) designation. However, it could be misleading to simply say that a capability is unforgeable when it is based on an unguessable designation.

ⁱⁱⁱ *i.e.*, Java, Hypertext Transfer Protocol, C++, *etc.* The object might reside on a computer that is remote from the one on which the operation is being invoked.

^{iv} The use of types in the Actor Model has some similarities and differences with Split Capabilities[Karp, Gupta, Rozas, and Banerji 2003]. In order to send a message to an Actor, both an address and a type are required. A difference is that this division is not the same as in Split Capabilities because a type is an Actor in its own right and not restricted to being a list of access rights. For example, if anAccount is of type **Account** then, anAccount.**deposit**[\$5] is equivalent to the following:

Account.send[anAccount, **deposit**[\$5]]

^v By default, ActorScript systems adhere to the prescriptions of capabilities and furthermore have stronger security properties as well, *e.g.*, making use of type encryption and not allowing insecure casting.

The interface type **Account** can be defined as follows:

```
Interface Account with availableBalance[ ]→Euro,  
deposit[Euro]→Void,  
withdraw[Euro]→Void
```

The following is an implementation of **Account**:

```
Actor SimpleAccount[startingBalance:Euro]  
myBalance := startingBalance.  
// myBalance is an assignable variable initialized with startingBalance  
implements Account using  
availableBalance[ ]:Euro → myBalance  
deposit[anAmount:Euro]:Void →  
Void // return Void  
afterward myBalance := myBalance+anAmount  
// the next message is processed with  
// myBalance reflecting the deposit  
withdraw[anAmount:Euro]:Void →  
(amount > myBalance) ⚡  
True ⚡ Throw Overdrawn[ ]  
False ⚡ Void // return Void  
afterward myBalance := myBalance-anAmount  
// the next message is processed with updated myBalance
```

The above implementation of **Account** can be extended as follows to provide the ability to revoke some abilities to change an account by providing **AccountSupervisor** and **AccountRevoker** interfaces:

The above implementation of **Account** can be extended as follows to provide the ability to revoke some abilities to change an account.⁹⁰ For example, the **AccountSupervisor** implementation below implements both the **Account** and **AccountRevoker** interfaces as an extension of the implementation **Account**:

As illustrated below, a qualified address of an Actor can be expressed using “`[]`” followed by the name of the qualifier.⁹¹

```

Actor AccountSupervisor[initialBalance:Euro]
  uses SimpleAccount[initialBalance].
                                     // uses Account implementation
  withdrawableIsRevoked := False,
  depositableIsRevoked := False.
  [[revoker]:AccountRevoker → []AccountRevoker]
                                     // this Actor as AccountRevoker

  [[account]:Account → []Account]
                                     // this Actor as Account
  withdrawFee[anAmount:Euro] →
    Void afterward myBalance := myBalance - anAmount$
                                     // withdraw fee even if balance goes negative
  partially reimplements Account using
  // (availableBalance[] → Euro) from SimpleAccount
  withdraw[anAmount]:Euro →
    withdrawableIsRevoked ⚡
    True ⚡ Throw Revoked[]
    False ⚡ []Account ◦ SimpleAccount . withdraw[anAmount] []
  deposit[anAmount]:Void →
    depositableIsRevoked ⚡
    True ⚡ Throw Revoked[]
    False ⚡ []Account ◦ SimpleAccount . deposit[anAmount] []$
  also implements AccountRevoker using
  revokeDeposit[]:Void →
    Void afterward depositableIsRevoked := True
  revokeWithdraw[]:Void →
    Void afterward withdrawableIsRevoked := True$

```

For example, the following expression returns *negative* €3:

```

Let anAccountSupervisor ← AccountSupervisor.[€3]。
Let anAccount ← anAccountSupervisor.[account],
    aRevoker ← anAccountSupervisor.[revoker]。
Prep anAccount.withdraw[€2] ● // the balance is €1
    aRevoker.revokeWithdrawable[] ●
    // withdrawableIsRevoked is True
Try anAccount.withdraw[€5] // try another withdraw
catch _ : Void ● // ignore the thrown exception92
    // the balance remains €1
anAccountSupervisor.withdrawFee[€4] ●。
    // €4 is withdrawn even though withdrawableIsRevoked
    // the balance is negative €3
anAccount.availableBalance[] | // the balance is negative €3

```

One-way Messaging

The following is an implementation of an arithmetic logic unit that implements **jumpGreater** and **addJumpPositive** one-way messages:

```

Actor ArithmeticLogicUnit<aType>[]
implements ALU<aType> using
    jumpGreater[x:aType, y:aType,
        firstGreaterAddress:Address,
        elseAddress:Address]→
    InstructionUnit←Execute[(x>y) ◆
        True : firstGreaterAddress□
        False : elseAddress ?]†
    addJumpPositive[x:aType, y:aType, sumLocation:Location<aType>,
        positiveAddress:Address, elseAddress:Address]→
    Let z ← (x+y)。
    sumLocation ◆
    aVariableLocation:VariableLocation<aType>i :
    Prep VariableLocation.store[z] ●。
        // continue after acknowledgement of store
    (z > 0) ◆ True : InstructionUnit←execute[positiveAddress] □
        False : InstructionUnit←execute[elseAddress] ? □
    aTemporaryLocation:TemporaryLocation<aType>ii :
    aTemporaryLocation←write[z],
        // continue concurrently with processing write
    (z > 0) ◆ True : InstructionUnit←execute[positiveAddress] □
        False : InstructionUnit←execute[elseAddress] ? ? § |

```

ⁱ VariableLocation<aType> has store[aType]→ Void |

ⁱⁱ TemporaryLocation<aType> has write[aType] → ⊖ |

Native types, e.g., JavaScript, JSON, Java, and HTML (HTTP)

Because Actor addresses are typed, almost any kind of addressed can be accommodated.

Object can be used to create JavaScript Objects. Also, **Function** can be used to bind the reserved identifier **This**. For example, consider the following ActorScript for creating a JavaScript object aRectangle (with length 3 and width 4) and then computing its area 12:

```
Let aRectanglei ← Object {"length": 3, "width": 4},
    aFunction ← Function [] → This["length"] * This["width"].
Prep Rectangle["area"] := aFunction ●.
aRectangle["area"].[]
```

The setTimeout JavaScript object can be invoked with a callback as follows that logs the string "later" after a time out of 1000:

```
setTimeout@JavaScript.[1000,
    Function [] →
        console@JavaScript.[["log"].["later"]] ]
```

HTML strings can be used to create Actor addresses. For example, the Wikipedia English homepage can be retrieved as follows:⁹³

```
(HTTPS["en.wikipedia.org"]).get[]
```

JSON is a restricted version of **Object** that allows only Booleans, numbers, strings in objects and arrays.ⁱⁱ

Native types can also be used from Java. For example, if `s:String@Java`, then `s.substring[3, 5]`ⁱⁱⁱ is the substring of `s` from the 3rd to the 5th characters inclusive.

Java types can be referenced using **Refer**^{iv}, e.g.:

```
Refer java.math.BigInteger
```

```
Refer java.lang.Number
```

After the above, `BigInteger.new["123"].instanceof[Number]` is equivalent to `True`.

ⁱ aRectangle is of type `Object@JavaScript`

ⁱⁱ *i.e.* the following JavaScript types are not included in JSON: Date, Error, Regular Expression, and Function.

ⁱⁱⁱ `substring` is a method of the `String` type in Java

^{iv} `Refer` is called `Import` in Java

Was the Actor Model premature?

The history of the Actor Model raises the question of whether it was premature.

Original definition of prematurity

As originally defined by [Stent 1972], “A discovery is premature if its implications cannot be connected by a series of simple logical steps to contemporary canonical or generally accepted knowledge.” [Lövy 2002] glossed the phrase “series of simple logical steps” in Stent's definition as referring to the “*target community's ways of asking relevant questions, of producing experimental results, and of examining new evidence.*” [Ghiselin 2002] argued that if a “*minority of scientists accept a discovery, or even pay serious attention to it, then the discovery is not altogether premature in the Stentian sense.*” In accord with Ghiselin's argument, the Actor Model was not premature. Indeed it enjoyed initial popularity and underwent steady development.

However, Stent in his original article also referred to a development as premature such that when it occurred contemporaries did not adopt it by consensus. This is what happened with the Actor Model partly for the following reasons:

- For over 30 years after the first publication of the Actor Model, widely deployed computer architectures developed in the direction of making a single sequential thread of execution run faster.
- For over 25 years after the first publication, there was no agreed standard by which software could communicate high level data structures across organizational boundaries.

Before its time?

According to [Gerson 2002], phenomena that lead people to talk about discoveries being before their time can be analyzed as follows:

We can see the phenomenon of 'before its time' as composed of two separate steps. The first takes place when a new discovery does not get tied to the conventional knowledge of its day and remains unconnected in the literature. The second step occurs when new events lead to the 'rediscovery' of the unconnected results in a changed context that enables or even facilitates its connection to the conventional knowledge of the rediscovering context.

But circumstances have radically changed in the following ways:

- Progress on improving the speed of a single sequential thread has stalled for some time now. Increasing speed depends on effectively using many-core architectures.
- Better ways have been implemented that Actors can use to communicate messages between computers.
- Actors have been increasingly adopted by industry.

Consequently, by the criteria of Gerson, the Actor Model might be described by some as *before its time*.

According to [Zuckerman and Lederberg 1986], premature discoveries are those that were made but neglected. [Gerson 2002] argued,

But histories and sociological studies repeatedly show that we do not have a discovery until the scientific community accepts it as such and stops debating about it. Until then the proposed solution is in an intermediate state.”

By his argument, the Actor Model is a discovery but since its practical importance is not yet accepted by consensus, its practical importance is not yet a discovery.

Index

- ⌈, 71
- ©, 71
- Actor
 - address, 2, 3, 5, 21, 22, 36, 41
 - communicating sequential processes, 51
 - customer, 5, 61
 - Erlang, 57
 - Fog Cutter, 56, *See* Fog Cutter
 - interface, 16
 - JavaScript, 24, 61
 - locality, 5
 - Orleans, 24, 58
 - promise, 31, 60, 61
 - security, 5
 - Swiss cheese, 19
 - π -Calculus, 54
- Actor Message
 - Virtual Procedure, 47
- Actor Model, 3
 - capabilities systems, 62
- Actors
 - Squeak, 58
 - uncountably many, 17
- Adams, J., 65
- address
 - Actor, 2, 3, 5, 21, 22, 36, 41
- Agha, G., 45, 56
- Allison, D., 24
- Armstrong, J., 57
- Athas, W., 50
- backdoor, 8
- Baker, H., 5, 18, 42
- Baran, P., 3
- Bernstein, P., 24, 58
- Bishop, P., 3, 41, 50
- blob, 57, 62
- Boden, N., 50
- Boley, H., 25
- Briot, J., 50
- Bykov, S., 24, 58
- capabilities systems
 - Actor Model, 62
- Capabilities Systems, 62
- capability, 3, 21, 42, *See* Actor
 - address
- Cardelli, L., 55
- Chander, A., 65
- cheese, 20
 - hole, 20
- Church, A., 1, 36
- Clinger, W., 52
- commerce agents, 10
- contradiction, 2
- Cosmic Cube, 50
- CSP, 51
 - 1978, 52
- Dahl, O., 38, 47
- Dally, W., 55
- Dean, D., 65
- Dennis, J., 3, 62
- Deutsch, P., 53
- Dijkstra, E., 43, 51
- Erlang
 - Actor, 57
- FBI COINTELPRO, 7
- Feynman, R., 13
- Fog Cutter
 - Actor, 56
 - mailbox, 56
 - thread, 56
- Function (JavaScript), 71
- Funder, A., 7
- future, 18, 20, 48, 49, 55, 60
- [FutureList](#), 20
- Garst, B., 24
- Geller, A., 58
- Goldberg, A., 53
- Gordon, A., 55
- Greif, I., 42
- Hayes, P., 43
- Hayes, T., 24
- Hewitt, C., 3, 42, 56
- Hibbert, C., 24
- Hoare, CAR, 5, 52
- Hopwood, D., 24
- [HTTPS](#), 71
- Huhns, M., 24

inconsistency
 denial, 2
 elimination, 2
 inconsistent, 2
 indeterminacy, 5
 Ingalls, D., 53, 58
 Smalltalk-72, 40
 interface
 Actor, 16
 Islets™, 7
 J operator, 47
 JavaScript, 71
 Actor, 24, 61
 J-Machine, 55
 JSON, 71
 Kaehler, t., 53
 Kaehler, T., 58
 Kahn, K., 24, 50
 Karmani, R., 56
 Karp, A., 24
 Kay, A., 3, 53, 58
 Smalltalk-71, 40
 Smalltalk-72, 40
 King, M. L., 7
 Klot, G., 24, 58
 Knabe, F., 52, 54
 lambda calculus, 1
 Lambda calculus, 36
 Lampson, B., 65
 Landin, P., 47
 J operator, 47
 Larus, J., 58
 Leslie, W., 24
 Let, 70, 71
 Levy, H., 64, 65
 Lieberman, H., 50
 Liskov, B., 18
 Lisp, 3
 locality
 Actor, 5
 Logic
 Classical, 15
 Matsuoka, S., 50
 McCarthy, J., 37, 39, 43
 McDermott, D., 48
 Meijer, E., 56
 Merry, D., 53
 Miller, M. S., 24, 65
 Milner, R., 53, 55
 Minsky, M., 39
 Mitchell, J., 65
 Miya, E., 24
 Mol, A., 13
 Nygaard, K., 38, 47, 56
 Object, 71
 versus Actor, 47
 Object (JavaScript), 71
 Object-oriented
 versus Actor Model, 47
 Oppenheimer, J. R., 7
 Organick, E., 65
 Orleans
 Actor, 24, 58
 packet switching, 3
 Pandya, R., 58
 Papert, S., 40
 Park, D., 55
 Petri Nets, 3
 Planner, 40
 Plotkin, G., 43
 Pratt, V., 24
 program control structure, 47
 promise
 Actor, 31, 60, 61
 quasi-commutative, 5
 Reynolds, J., 47
 Rovelli, C., 13
 Saltzer, J., 63, 64, 66
 Scheme, 47
 Schroeder, M., 63, 64, 66
 Schumacher, D., 24
 Scott, D., 1
 security
 Actor:, 5
 Seitz, C., 50
 sensitive citizen information, 7
 Shapiro, J., 65
 Simula, 38
 Simula 67, 40
 Simula-67, 3
 Smalltalk-72, 3, 40, 53
 Smalltalk-80, 53
 Squeak, 58
 Standard IoT™, 9
 Stasi, 7
 Steele, G., 47

Steiger, R., 3, 41
Suppes, P., 24
Sussman, G., 47, 48
Swiss cheese
 Actor:, 19
Szyperski, C., 56
Thelin, J., 58
Theriault, D., 50
This (JavaScript), 71
Turing, A., 36
type, 71
van Horn, E., 3, 62
Virtual Procedure
 Actor Message, 47
Wallace, S., 53
Wing, J., 18
Woelk, D., 50
Woodruff, J., 65
Woods, J., 2
Yonezawa, A., 50
 π -Calculus, 54

End Notes

¹ The Actor model makes use of two fundamental orders on computational events [Baker and Hewitt 1977; Clinger 1981, Hewitt 2006]:

1. The *activation order* (\rightsquigarrow) is a fundamental order that models one event activating another (there is energy flow from an event to an event which it activates). The activation order is discrete:

$$\forall [e_1, e_2 \in \text{Events}] \rightarrow \text{Finite}[\{e \in \text{Events} \mid e_1 \rightsquigarrow e \rightsquigarrow e_2\}]$$

There are two kinds of events involved in the activation order: reception and transmission. Reception events can activate transmission events and transmission events can activate reception events.

2. The *reception order* of an Actor $x(\rightarrow_x)$ models the (total) order of events in which a message is received at x . The reception order of each x is discrete:

$$\forall [r_1, r_2 \in \text{ReceptionEvents}_x] \rightarrow \text{Finite}[\{r \in \text{ReceptionEvents}_x \mid r_1 \xrightarrow{x} r \xrightarrow{x} r_2\}]$$

The *combined order* (denoted by \curvearrowright) is defined to be the transitive closure of the activation order and the reception orders of all Actors. So the following question arose in the early history of the Actor model: “*Is the combined order discrete?*” Discreteness of the combined order captures an important intuition about computation because it rules out counterintuitive computations in which an infinite number of computational events occur between two events (*à la* Zeno).

Hewitt conjectured that the discreteness of the activation order together with the discreteness of all reception orders implies that the combined order is discrete. Surprisingly [Clinger 1981; later generalized in Hewitt 2006] answered the question in the negative by giving a counterexample:

Any finite set of events is consistent (the activation order and all reception orders are discrete) and represents a potentially physically realizable situation. But there is an infinite set of sentences that is inconsistent with the discreteness of the combined order and does not represent a physically realizable situation.

The resolution of the problem is to take discreteness of the combined order as an axiom of the Actor model:¹

$$\forall [e_1, e_2 \in \text{Events}] \rightarrow \text{Finite}[\{e \in \text{Events} \mid e_1 \curvearrowright e \curvearrowright e_2\}]$$

Properties of concurrent computations can be proved using the above orderings [e.g. Bost, Mattern, and Tel 1995; Lamport 1978, 1979].

² better or worse

³ The receiver might be on another computer and in any the system can make use of threads, locks, location transparency, throttling, load distribution,

persistence, automated storage reclamation, queues, cores, channels, ports, *etc.* as it sees fit.

Messages in the Actor model are generalizations of packets in Internet computing in that they need not be received in the order sent. Not implementing the order of delivery, allows packet switching to buffer packets, use multiple paths to send packets, resend damaged packets, and to provide other optimizations.

For example, Actors are allowed to pipeline the processing of messages. What this means is that in the course of processing a message *m1*, an Actor can designate how to process the next message, and then in fact begin processing another message *m2* before it has finished processing *m1*. Just because an Actor is allowed to pipeline the processing of messages does not mean that it *must* pipeline the processing. Whether a message is pipelined is an engineering tradeoff.

⁴ The amount of effort expended depends on circumstances.

⁵ These laws can be enforced by a proposed extension of the X86 architecture that will support the following operating environments:

- CLR and extensions (Microsoft)
- JVM (Oracle, IBM, SAP)
- Dalvik (Google)

Many-core architecture has made the above extension necessary in order to provide the following:

- concurrent nonstop automated storage reclamation (garbage collection) and relocation to improve performance,
- prevention of memory corruption that otherwise results from programming languages like C and C++ using thousands of threads in a process,
- nonstop migration of iOrgs (while they are in operation) within a computer and between distributed computers

⁶ for example Amazon, Apple, Carrier, Cisco, Dell, Electrolux, Facebook, GE, Google, Haier, HP, Huawei, IBM, Intel, Lenovo, LG, Microsoft, Panasonic, Samsung, and Whirlpool.

⁷ The following is a interface for a customer that is used in request/response message passing for return type *aType*:

Interface Customer<*aType*> with

return[*aType*] ↪ Θ ,
throw[*Exception*] ↪ Θ !

⁸ It is not possible to guarantee the consistency of information because consistency testing is recursively undecidable even in logics much weaker than first order logic. Because of this difficulty, it is impractical to test whether information is consistent.

⁹ Consequently iInfo makes use of direct inference in Direct Logic to reason more safely about inconsistent information because it omits the rules of

classical logic that enable every proposition to be inferred from a single inconsistency.

¹⁰ This section shares history with [Hewitt 2008f].

¹¹ *cf.* denotational semantics of the lambda calculus [Scott 1976]

¹² One solution is to develop a concurrent variant of the Lisp meta definition [McCarthy, Abrahams, Edwards, Hart, and Levin 1962] that was inspired by Turing's Universal Machine [Turing 1936]. If *exp* is a Lisp expression and *env* is an environment that assigns values to identifiers, then the procedure *Eval* with arguments *exp* and *env* evaluates *exp* using *env*. In the concurrent variant, **eval[env]** is a message that can be sent to *exp* to cause *exp* to be evaluated. Using such messages, modular meta definitions can be concisely expressed in the Actor model for universal concurrent programming languages (*e.g.* ActorScript [Hewitt 2010a]).

¹³ However, they come with additional commitment. Inappropriate language constructs are difficult to leave behind.

¹⁴ *E.g.* processes in Erlang [Armstrong 2007] and vats in the object-capability model [Miller 2006].

¹⁵ Swiss cheese was called serializers in the literature.

¹⁶ In part, this section extends some material that was submitted to Wikipedia and [Hewitt 2008f].

¹⁷ Turing [1936] stated:

the behavior of the computer at any moment is determined by the symbols which he [the computer] is observing, and his 'state of mind' at that moment" and "there is a bound B to the number of symbols or squares which the computer can observe at one moment. If he wishes to observe more, he must use successive observations."

Gödel's conception of computation was formally the same as Turing but more reductionist in motivation:

There is a major difference between the historical contexts in which Turing and Gödel worked. Turing tackled the Entscheidungsproblem [computational decidability of provability] as an interesting mathematical problem worth solving; he was hardly aware of the fierce foundational debates. Gödel on the other hand, was passionately interested in the foundations of mathematics. Though not a student of Hilbert, his work was nonetheless deeply entrenched in the framework of Hilbert's finitistic program, whose main goal was to provide a meta-theoretic finitary proof of the consistency of a formal system "containing a certain amount of finitary number theory." [Shagrir 2006]

¹⁸ An example of the global state model is the Abstract State Machine (ASM) model [Blass, Gurevich, Rosenzweig, and Rossman 2007a, 2007b; Glausch and Reisig 2006].

¹⁹ The lambda calculus can be viewed as the earliest message passing programming language [Hewitt, Bishop, and Steiger 1973] building on previous work.

For example, the lambda expression below implements a tree data structure when supplied with parameters for a leftSubTree and rightSubTree. When such a tree is given a parameter message “getLeft”, it returns leftSubTree and likewise when given the message “getRight” it returns rightSubTree:

$$\lambda[\text{leftSubTree}, \text{rightSubTree}] \\ \lambda[\text{message}] \text{ message} \begin{cases} \text{“getLeft”} \text{ : leftSubTree} \\ \text{“getRight”} \text{ : rightSubTree} \end{cases}$$

²⁰ Allowing assignments to variables enabled sharing of the effects of updating shared data structures but did not provide for concurrency.

²¹ [Petri 1962]

²² Consequently in Simula-76 there was no required locality of operations unlike the laws for locality in the Actor mode [Baker and Hewitt 1977].

²³ The ideas in Simula became widely known by the publication of [Dahl and Hoare 1972] at the same time that the Actor model was being invented to formalize concurrent computation using message passing [Hewitt, Bishop, and Steiger 1973].

²⁴ The development of Planner was inspired by the work of Karl Popper [1935, 1963], Frederic Fitch [1952], George Polya [1954], Allen Newell and Herbert Simon [1956], John McCarthy [1958, *et. al.* 1962], and Marvin Minsky [1968].

²⁵ This turned out later to have a surprising connection with Direct Logic. See the Two-Way Deduction Theorem below.

²⁶ Subsequent versions of the Smalltalk language largely followed the path of using the virtual methods of Simula in the message passing structure of programs. However Smalltalk-72 made primitives such as integers, floating point numbers, etc. into objects. The authors of Simula had considered making such primitives into objects but refrained largely for efficiency reasons. Java at first used the expedient of having both primitive and object versions of integers, floating point numbers, etc. The C# programming language (and later versions of Java, starting with Java 1.5) adopted the more elegant solution of using boxing and unboxing, a variant of which had been used earlier in some Lisp implementations.

²⁷ According to the Smalltalk-72 Instruction Manual [Goldberg and Kay 1976]:

There is not one global message to which all message “fetches” (use of the Smalltalk symbols eyeball, ◀; colon, ::; and open colon, %) refer; rather, messages form a hierarchy which we explain in the following way-- suppose I just received a message; I read part of it and decide I should send my friend a message; I wait until my friend reads his message (the one I sent him, not the one I received); when he finishes reading his message, I return to reading my message. I can choose to let my friend read the rest of my message, but then I cannot get the message back to read it myself (note, however, that this can be done using the Smalltalk object *apply* which will be discussed later). I can also choose to include permission in my message to my friend to ask me to fetch some information from my message and to give that in information to him (accomplished by including :: or % in the message to the friend). However, anything my friend fetches, I can no longer have. In other words,

- 1) An object (let's call it the CALLER) can send a message to another object (the RECEIVER) by simply mentioning the RECEIVER's name followed by the message.
- 2) The action of message sending forms a stack of messages; the last message sent is put on the top.
- 3) Each attempt to receive information typically means looking at the message on the top of the stack.
- 4) The RECEIVER uses the eyeball, ◀, the colon, ::, and the open colon, %, to receive information from the message at the top of the stack.
- 5) When the RECEIVER completes his actions, the message at the top of the stack is removed and the ability to send and receive messages returns to the CALLER. The RECEIVER may return a value to be used by the CALLER.
- 6) This sequence of sending and receiving messages, viewed here as a process of stacking messages, means that each message on the stack has a CALLER (message sender) and RECEIVER (message receiver). Each time the RECEIVER is finished, his message is removed from the stack and the CALLER becomes the current RECEIVER. The now current RECEIVER can continue reading any information remaining in his message.
- 7) Initially, the RECEIVER is the first object in the message typed by the programmer, who is the CALLER.
- 8) If the RECEIVER's message contains an eyeball, ◀; colon, ::, or open colon, %, he can obtain further information from the CALLER's message. Any information successfully obtained by the RECEIVER is no longer available to the CALLER.

9) By calling on the object *apply*, the CALLER can give the RECEIVER the right to see all of the CALLER's remaining message. The CALLER can no longer get information that is read by the RECEIVER; he can, however, read anything that remains after the RECEIVER completes its actions.

10) There are two further special Smalltalk symbols useful in sending and receiving messages. One is the keyhole, `⌈`, that lets the RECEIVER “peek” at the message. It is the same as the `⋮` except it does not remove the information from the message. The second symbol is the hash mark, `#`, placed in the message in order to send a reference to the next token rather than the token itself.

²⁸ The sender is an intrinsic component of communication in the following previous models of computation:

- *Petri Nets*: the input places of a transition are an intrinsic component of a computational step (transition).
- *Lambda Calculus*: the expression being reduced is an intrinsic component of a computational step (reduction).
- *Simula*: the stack of the caller is an intrinsic component of a computation step (method invocation).
- *Smalltalk 72*: the invoking token stream is an intrinsic component of a computation step (message send).

²⁹ An Actor can have information about other Actors that it has received in a message about what it was like when the message was sent. See section of this paper on unbounded nondeterminism in ActorScript.

³⁰ Arbiters render meaningless the states in the Abstract State Machine (ASM) model [Blass, Gurevich, Rosenzweig, and Rossman 2007a, 2007b; Glausch and Reisig 2006].

³¹ The logic gates require suitable thresholds and other parameters.

³² Of course the same limitation applies to the Abstract State Machine (ASM) model [Blass, Gurevich, Rosenzweig, and Rossman 2007a, 2007b; Glausch and Reisig 2006]. In the presence of arbiters, the global states in ASM are mythical.

³³ Consider the following Nondeterministic Turing Machine:

Step 1: Next do either *Step 2* or *Step 3*.

Step 2: Next do *Step 1*.

Step 3: Halt.

It is possible that the above program does not halt. It is also possible that the above program halts. Note that above program is not equivalent to the one below in which it is not possible to halt:

Step 1: Next do *Step 1*.

³⁴ This result is very old. It was known by Dijkstra motivating his belief that it is impossible to implement unbounded nondeterminism. Also the result played a crucial role in the invention of the Actor Model in 1972.

³⁵ This proof does not apply to extensions of Nondeterministic Turing Machines that are provided with a new primitive instruction `NoLargest` which is defined to write an unbounded large number on the tape. Since executing `NoLargest` can write an unbounded amount of tape in a single instruction, executing it can take an unbounded time during which the machine cannot read input.

Also, the `NoLargest` primitive is of limited practical use. Consider a Nondeterministic Turing Machine with two input-only tapes that can be read nondeterministically and one standard working tape.

It is possible for the following program to copy both of its input tapes onto its working tape:

Step 1: Either

a) copy the next input from the 1st input tape onto the working tape and next do *Step 2*,

or

b) copy the next input from the 2nd input tape onto the working tape and next do *Step 3*.

Step 2: Next do Step 1.

Step 3: Next do Step 1.

It is also possible that the above program does not read any input from the 1st input tape (*cf.* [Knabe 1993]). Bounded nondeterminism was but a symptom of deeper underlying issues with Nondeterministic Turing Machines.

³⁶ Consequently,

- The tree has an infinite path. \Leftrightarrow The tree is infinite. \Leftrightarrow It is possible that P does not halt.

If it is possible that P does not halt, then it is possible that the set of outputs with which P halts is infinite.

- The tree does not have an infinite path. \Leftrightarrow The tree is finite. $\Leftrightarrow P$ always halts.

If P always halts, then the tree is finite and the set of outputs with which P halts is finite.

³⁷ [Kowalski 1988a]

³⁸ A Logic Program is defined by the criteria that it must logically infer its computational steps.

³⁹ A request to a shared resource might never receive service because it is possible that a nondeterministic choice will always be made to service another request instead.

⁴⁰ [Nygaard 1986] Starting with Simula-67, which was not a pure Object programming language because for efficiency reasons numbers, strings, and arrays, were not Objects in the Class hierarchy.

⁴¹ [Knudsen and Madsen 1988]

⁴² According to [Nygaard 1986] (emphases in original):

The term *object-oriented programming* is derived from the *object* concept in the Simula-67 programming language. ... Objects sharing a common structure are said to constitute a *class*, described in the program by a common *class description*.

[SIGPLAN 1986, Stein, Lieberman, and Ungar 1989] have discussions of object-oriented programming.

⁴³ Examples of Object programming languages include Simula-67, Smalltalk-80, Java, C++, C#, and future versions of JavaScript. Recent Object languages support other abstraction and code reuse mechanisms, such as traits, delegation, type classes, and so on, either in place of, or as well as inheritance.

⁴⁴ Every interface is a type and every type is an interface.

⁴⁵ [Kay 1998] wrote:

The big idea is “messaging” The key in making great and growable systems is much more to design how its modules communicate rather than what their internal properties and behaviors should be. Think of the internet - to live, it (a) has to allow many different kinds of ideas and realizations that are beyond any single standard and (b) to allow varying degrees of safe interoperability between these ideas.

⁴⁶ missing from initial versions of Scheme

⁴⁷ Notable members of this community included Bill Gosper, Richard Greenblatt, Jack Holloway, Tom Knight, Stuart Nelson, Peter Samson, Richard Stallman, *etc.* See [Levy 1984].

⁴⁸ According to [Steele and Gabriel 1994]:

Hewitt had noted that the actor model could capture the salient aspects of the lambda calculus; Scheme demonstrated that the lambda calculus captured nearly all salient aspects (excepting only side effects and synchronization) of the actor model.

Unfortunately, the above comment misses an important point: Actors that can be implemented in the parallel lambda calculus are special case Actors that have bounded nondeterminism and *cannot* change. In general, Actors that can be implemented in the parallel lambda calculus are exponentially slower than general Actor systems.

⁴⁹ [Hewitt 1976, 1977].

⁵⁰ This misconception was partially acknowledged in some of their subsequent work.

⁵¹ The parallel lambda calculus includes the following limitations:

- Message reception order cannot be implemented.
- Actors that change cannot be implemented
- The parallel lambda calculus does not have exceptions.
- In general, the parallel lambda calculus is exponentially slower than general Actor systems.

⁵² According to [Berger 2003], Milner revealed

...secretly I realized that working in verification and automatic theorem proving...wasn't getting to the heart of computation theory...it was Dana Scott's work that was getting to the heart of computation and the meaning of computation.

However, Milner continued his research on bi-simulation between systems and did not directly address the problem of developing mathematical denotations for general computations as in the Actor Model.

⁵³ Note that there is a limitation on concurrency because `u.get[]` must complete *before* P starts.

⁵⁴ As above, there is a limitation on concurrency because `u.put[x]` must complete *before* P starts.

⁵⁵ e.g. as in Erlang [Armstrong 2010].

⁵⁶ e.g. using assignment commands

⁵⁷ a concept from (quantum) physics

⁵⁸ However, data structures *within* an Erlang Actor are garbage collected.

⁵⁹ which can be optimized by reusing the thread if another message is waiting

⁶⁰ a globally unique identifier can be a 128-bit guid, long integer, or a string.

⁶¹ Also, a reference for an Orleans Actor can be created from a C# `anObjectAddress` using `aFactory.CreateObjectReference(anObjectAddress)`.

⁶² There can be optimizations for determinate message passing, *i.e.*, the same message always responds with the same result.

⁶³ Because of the ability to instantiate an Actor from its globally unique identifier, Orleans Actors are called “*virtual*” in their documentation. By analogy with virtual memory, the term “*virtual*” applied to an Orleans Actor would seem to imply that it would have to return to where it left. However, this terminology is misleading because an Actor can potentially migrate elsewhere and never come back.

Better terminology would be to say that an Orleans Actor is “*perpetual*.”

⁶⁴ unless it is deleted by potentially unsafe means, which can result in a dangling globally unique identifier.

⁶⁵ after it has been unused for a while, its storage can be moved elsewhere outside the process in which it currently resides

⁶⁶ unless it is deleted by potentially unsafe means, which can result in a dangling globally unique identifier.

⁶⁷ However, after the message is finished processing, sometimes waiting method calls it invoked can be processed concurrently if they are independent.

⁶⁸ provided that the Actor is not contended

⁶⁹ [Microsoft 2013]

⁷⁰ In ActorScript the program is:

```
Try ...aUse(□anActor.aMethodName(...))...
    anotherUse(□anActor.anotherMethodName(...))...
catch ...
```

⁷¹ reentrancy allows execution of waiting method calls to be freely interleaved

⁷² [Liskov and Shira 1988; Miller, Tribble, and Shapiro 2005]

⁷³ Orleans uses `Task<aType>` for the type of a promise which corresponds to the type `Future<aType>` in ActorScript.

⁷⁴ for requests, *e.g.*, method calls. Customers are sometimes called continuations in the literature although continuations often cannot handle exceptions.

⁷⁵ However, Orleans does still surfaces continuations using lower level primitives.

⁷⁶ [ECMA 2014]

⁷⁷ Promise Actors were sometimes called “futures” in the beginning [Russell 2013, Yoshino 2013].

⁷⁸ [Barton 2014]

⁷⁹ somewhat analogous the `await` construct in C# [Microsoft 2013]

```
80 function CreatePromise(thunkForExpression)
    {return Promise.resolve(true)
        .then((aValueToDiscard) =>
            thunkForExpression());};
```

⁸¹ A `thunk` is an intermediary procedure for assistance in carrying out a task [Church 1941, Ingerman, 1961].

⁸² which are a kind of `iOrg`

⁸³ Of course, at a different level of abstraction, workers can also be modeled as Actors that communicate with other workers.

⁸⁴ roughly in order of decreasing importance

⁸⁵ JavaScript has transferable Actors (which include the types `ArrayBuffer`, `MessagePort`, and `WorkerCanvas`) by various mechanisms. According to [Miller 2016] with regard to the `ArrayBuffer` detachment mechanism:

"It is an ownership transfer of exclusive access to the underlying data area in memory. When one worker does a `postMessage` of an `ArrayBuffer` to another, the sender loses access to the area of memory in which those bytes are stored. The receiver received a new `ArrayBuffer` object born providing access to the data in that same area of memory."

⁸⁵ due mainly to the legacy requirement not to break the Web. Under difficult circumstances, W3C and ECMA have worked to clean-up and make extensions without breaking the Web.

⁸⁶ In order to address these security problems, tagged-memory architectures need to be created as extensions of current ARM and Intel architectures.

⁸⁷ Capabilities were critiqued in [Bobert 1984; Rajunas 1989; Miller, Yee and Shapiro 2003] concerning the following issues:

- *revocability*: An Actor does not have to honor the message that it receives. Using proxies for Actors also enables revocability because messages are forwarded and so a proxy can revoke.
- *multi-level security*: Actors, *per se*, do *not* have levels of security although various security schemes can be implemented, which may require using membranes [Donnelley 1976, Hewitt 1980].
- *delegation*: Actors directly support delegation by passing addresses of Actors in messages. However, a receiver must have appropriate types in order to send messages to addresses that it has received.
- *confinement*: Actor can use encryption to help enforcement confinement of information. For example, a computer might accept communications to Actors that it hosts only if the communication is encrypted by certain other computers.

⁸⁸ The message might not actually be received for a variety of potential reasons. For example, because it is not properly received by an app the for intended recipient, because it is not properly received by a computer for the intended recipient, *etc.* It is good practice to throw an exception if a response is not received within some “reasonable” time.

⁸⁹ Bits cannot be converted into an Actor address of arbitrary type, i.e., an Actor cannot convert an address of type **BitString** into an address of type **Account**.

⁹⁰ The ability to extend implementation is important because it helps to avoid code duplication.

⁹¹ *cf.* [Crahen 2002, Amborn 2004, Miller, et. al. 2011]

⁹² ignoring exceptions in this way is *not* a good practice

⁹³ equivalently ([HTTPS\[en.wikipedia.org\]](https://en.wikipedia.org/))[]