



HAL
open science

The new bosonic mechanism

Rostislav Taratuta

► **To cite this version:**

| Rostislav Taratuta. The new bosonic mechanism. 2016. hal-01162606v7

HAL Id: hal-01162606

<https://hal.science/hal-01162606v7>

Preprint submitted on 22 Sep 2016

HAL is a multi-disciplinary open access archive for the deposit and dissemination of scientific research documents, whether they are published or not. The documents may come from teaching and research institutions in France or abroad, or from public or private research centers.

L'archive ouverte pluridisciplinaire **HAL**, est destinée au dépôt et à la diffusion de documents scientifiques de niveau recherche, publiés ou non, émanant des établissements d'enseignement et de recherche français ou étrangers, des laboratoires publics ou privés.



Distributed under a Creative Commons Attribution - NonCommercial - NoDerivatives 4.0 International License

The new bosonic mechanism.

Rostislav A. Taratuta

V.Ye. Lashkaryov Institute of Semiconductor Physics, Kiev, Ukraine

corresponding author, email: r.tr@verizon.net

ABSTRACT

1. Purpose

The main purpose of this paper is to introduce the new bosonic mechanism and new treatment of dark energy.

The bosonic mechanism focuses on obtaining masses by gauge bosons without assuming the existence of Higgs boson. This paper highlights the possibility for gauge boson to obtain mass not by means of interaction with Higgs boson, but by interacting with massive scalar mode of a single gravitational-dark field. The advantage of this approach over Higgs model is the manifest that the gauge boson acquires mass through interaction with combined gravitational dark field thus allowing the mechanism to account for the dark sector while Higgs model does not include dark sector. It has to be noted that obtaining masses in SM electroweak sector is not considered within the scope of this approach.

The hypothesis on dark energy as the energy of a postulated dark field was made and a combined gravitational-dark field was introduced. This field is the key to a specified approach and allows addressing the fundamental starting points of the mechanism.

i. Complex scalar field is introduced in the description of the mechanism and is divided into two components: Goldstone-dark field and tensor-gravitational field; tensor-gravitational component outlines the physics of obtaining masses by gauge bosons and causes the existence of Goldstone-dark component, which defines physics behind the Goldstone theorem.

ii. The meaning of spontaneous symmetry breaking ^{note} is understood in the context of changing between ‘mixed’ and ‘pure’ states of gauge field which appears in the framework of the outlined mechanism and can apply to global and local symmetry without violating the constraint denoted by Elitzur theorem (S. Elitzur, Phys. Rev. D 12, 3978-3982, 1975); thus the process of symmetry breaking is understood differently from the standard formulation (F. Mandl and G. Shaw, *Quantum Field Theory*, Wiley, 2010) used in Higgs mechanism and assumes the existence of two paths (direct and restoring). The entanglement of these two paths is quantified by entropy as a parameter, based on which paths are chosen.

General theory Lagrangian (for interaction) in case of ‘pure’ state of gauge field is due to the existence of one dimensional cosmic string (‘Mexican hat’ potential); General theory Lagrangian (for non-interaction) in case of ‘mixed’ state of gauge field is due to dark energy as the restoring force to restore state of symmetry from local to global and thus flattening potential from ‘Mexican hat’-type to Goldstone-type. This means that physics of Lagrangian appearance in the proposed mechanism very different from Higgs approach.

iii. Noted mechanism incorporates:

1. Mathematical apparatus of quantum field theory presented in M.E. Peskin and D.V. Schroeder, *An Introduction To Quantum Field Theory*, Westview Press, 1995; and C. Itzykson and J-B. Zuber, *Quantum Field Theory*, McGraw-Hill, 1980.
2. Fierz-Pauli approach (V. Fierz and W. Pauli, Proc. Roy. Soc. London. A 173, 211-232, 1939) for particles of arbitrary spin and is further developed based on the outlined hypothesis, thus distinguishing between presented theory and other theories (i.e., Massive gravity) from the perspective of relevancy to the Fierz and Pauli thesis.
It is shown that diffeomorphism invariance is preserved in the noted mechanism and interaction with matter is allowed. Higgs scalar is obtained within the scope of the presented approach and is included as a part of the mathematical expression, which describes obtaining mass by vector gauge boson. The noted scalar has properties consistent with the properties of Higgs scalar observed in the Standard Model.

iv. A possibility of formulating a consistent nonlinear interacting theory, which does not contradict de Wit (B. de Wit and D. Freedman, Phys. Rev. D 21, 358-367, 1980) and Deser's arguments (S. Deser, General Relativity and Gravitation 1, 9-18, 1970) was presented.

v. The cancellation mechanism leading to the absence of the observable Cherenkov radiation is also addressed in this article.

vi. AdS/CFT correspondence is incorporated into the framework of the outlined mechanism.

vii. Mass scale structure and the diagram representing mathematical connections between the new bosonic mechanism, Einstein theory and Higgs mechanism are presented in the framework of the outlined mechanism.

viii. Neutrino oscillation can be explained within the boundary of the presented approach.

ix. Solution to hierarchy problem is also presented within the scope of the outlined mechanism.

x. The theory addresses how fermions obtain mass as a consequence of application of mass-generation mechanism to fermions.

xi. Hawking radiation can be explained in the framework of the new bosonic mechanism using the approach, which outlines in the paper the existence of barrier – black hole.

xii. In the framework of the specified mechanism the renormalizability of the theory is formulated in the five-dimensional space.

Dark field represents the fifth dimension possessing a dark-like Killing field. Dark-like Killing field corresponds to the conserved quantity, i.e. dark energy.

As follows from the notes (E. Witten, arXiv: hist-ph/1401.8048 v1, 2014) fifth dimension can be introduced in a non-contradictory way that is still referenced from a physical standpoint to four dimensions.

The physics of the fifth dimension appears as a Lorentz violation and the mechanism of cancellation of this violation is presented in the paper.

xiii. The notion of time is defined as a result of mathematical consequence of T – invariance violation.

note

The meaning of the spontaneous symmetry breaking and its relevance to Elitzur theorem (S. Elitzur, 1975) is emphasized as follows:

1. As specified by the proposed approach there are two paths for spontaneous symmetry breaking, namely, direct and restoring.

a) In direct path:

symmetry breaking mechanism is analogous to the standard approach (F. Mandl and G. Shaw, 2010) with Elitzur constraint, i.e., spontaneously breaking global symmetry \mapsto explicitly breaking of local symmetry by a gauge fixing term. Thus, equations of the proposed theory formally coincide with standard theory equations although the physics are very different.

As outlined in the essence of the mechanism, the first stage of this process leads to mass appearance in dark sector and the second stage leads to mass appearance in gravitational (metric) sector. This process corresponds to moving gauge field from ‘mixed’ state at the first stage (coupled with gravitational-dark scalar mode) to ‘pure’ state at the second stage (decoupled from gravitational-dark tensor mode). This results in obtaining gauge bosons mass by means of application of a two-stage schema.

b) In restoring path:

There is a restoring force (due to dark sector in reference to dark energy), which restores the symmetry from local to global. In this context restoring means cancellation of gauge field, so there is no gauge fixing anymore, thus no spontaneous breaking of local symmetry can occur. State of symmetry is therefore restored to global.

This process corresponds to moving gauge field from ‘pure’ (-split) state (decoupled from gravitational-dark tensor mode) back to ‘mixed’ state (coupled with gravitational-dark scalar mode). This results in losing mass by gauge bosons and returning into massless form.

a, b \succ The process of coupling and decoupling of gauge field, i.e., moving between ‘mixed’ and ‘pure’ states is spontaneous and as such is used in this context throughout the paper. This spontaneous process is entropy directed and driven and plays a crucial role in obtaining masses in gravitational (metric) sector. Thus, entropy plays a role of a parameter to determine preference of a) –path over b) –path.

2. In the context of local symmetry, the spontaneous symmetry breaking means that the state of gauge field spontaneously changes from ‘mixed’ to ‘pure’, thus explicitly breaking local symmetry by gauge fixing term on a) –path; the state of gauge field can also spontaneously change from ‘pure’ to ‘mixed’, thus restoring the state of global symmetry by restoring force on b) –path).

end_of_note

2. Mechanism

Presented here is the developing theory on the subject of obtaining masses by bosons (in particular gauge vector bosons).

The scope of the suggested consideration is introducing a mechanism, which is an alternative to the Higgs mechanism; in addition, the proposed new mechanism incorporates dark energy. It was considered that work by (V. Fierz and W. Pauli, 1939) should foster another model for obtaining nonzero masses by fundamental particles.

While negative conclusions regarding construction of consistent interacting theories of higher spin in a form of the gauge theory of several coupled or self-coupled fields were outlined (B. de Wit and D. Freedman, 1980), it is noted that spontaneous breakdown of the unacceptable symmetries is a possibility in order to evade these difficulties.

The emphasized original hypothesis behind suggested alternative approach mainly constitutes:

a) Dark field.

P1. Postulate: Dark energy determines the existence of a dark field.

b) Curvature of spacetime (the pseudo-Riemannian metric).

P2. Postulate: Gravitational and dark fields compose a single gravitational – dark field.

The essence of the mechanism is:

i. massless gravitational-dark field acquires mass due to the spontaneous symmetry breaking and the contribution of matter;

ii. massless vector bosons acquire mass due to the interaction with a massive gravitational-dark field.

➤ Following are the differences of the underlying mechanism as compared to the Higgs mechanism:

i. there is not a scalar field associated with the Higgs boson, the existence of Higgs boson is not assumed;

ii. gravitational massless component of a gravitational –dark field acquires mass as a result of local symmetry breaking (ref. note above: The meaning of the spontaneous symmetry breaking and its relevance to Elitzur theorem); coupling to matter;

iii. dark massless component acquires mass as a result of global symmetry breaking; gravitational field determines the dark field appearance, as the source of the dark field is the stress-energy tensor; coupling to matter;

iv. gauge bosons acquire mass not as a result of symmetry breaking but due to the interaction with a gravitational-dark field;

v. there is no specific assumption, which is limited to the consideration by gauge vector bosons only.

➤ Following is the analysis of these mechanisms:

1. Higgs mechanism (ref. Fig. TF-1.1).

Higgs approach demonstrates physical and mathematical discrepancies.

a)

i. physical discrepancy consists in formulated instability of vacuum.

(In the framework presented in the paper this discrepancy can be explained by referencing the second law of thermodynamics which states that entropy must increase so as to reach the state with maximum symmetry, ref. ‘the special symmetry evolution principle’, (J. Rosen, *Comment: The symmetry principle*, Entropy **7**, 308-313, 2005).

Higgs’ approach assumes that gauge bosons acquire mass as a result of symmetry breaking (on misuse of this terminology, ref. M. Dine, T. Banks and S. Sachdev, *String Theory and Its Applications TASI 2010 From meV to the Planck Scale*, World Scientific, 2012) and, in this model, there is no driving force to restore the state of maximum symmetry, i.e., there is no mechanism of increasing entropy in this theory.

This leads to the instability of Higgs’ solution (ref. instability of vacuum, (M.S. Turner and F. Wilczek, Nature 298 (5875); 633–634,1982)).

ii. application of Elitzur theorem to Higgs theory leads to the conclusion that Higgs field does not have expectation value and as a result cannot spontaneously break symmetry.

b)

i. mathematical discrepancy follows from the analysis outlined in Higgs model presentation in (F. Mandl and G. Shaw, 2010) where the main focus of the analysis is on the usage of unitary gauge, which assumes the elimination of ‘ghost field’; however, proving renormalizability of this model is provided in ‘tHooft gauge requiring reintroduction of the ‘ghost field’.

Presence of virtual particles (quantum fluctuations) associated with the ‘ghost field’ leads to instability of vacuum solution in Higgs model.

This two contradictory mathematical procedures which are required to prove Higgs model demonstrate build-in mathematical discrepancy and their existence points to the necessity of introducing the driving force to restore the state of maximum symmetry.

2. The new bosonic mechanism (ref. Fig. TF-1.2).

The new bosonic approach demonstrates physical consistency and, as result, does not include mathematical discrepancy.

The mechanism described in this paper represents a stable solution whereas Higgs mechanism represents an unstable solution. The scalar term obtained within the scope of the presented approach is consistent in action of assigning mass to vector gauge boson with the corresponding result obtained by means of Higgs scalar.

Physical consistency is determined by the following: the mechanism presented in this paper incorporates the driving force which restores the state of maximum symmetry from the state of symmetry breaking.

The dark energy, which is the driving force, increases the volume, which leads to the state with more entropy, i.e. symmetry. This driving force is determined by the requirement to cancel local vacuum fluctuations (i.e. maintain the thermodynamic equilibrium between baryonic sector and the thermal bath).

The thermal bath – micro black hole (b.h.) system increases entropy due to accretion of matter and uses Hawking’s radiation to make this entropy equal to the baryonic sector entropy in order to reach thermodynamic equilibrium and obtain stable solution.

➤ The description of new bosonic mechanism structure.

This paper introduces the mechanism based on two postulates: P1, P2.

This mechanism is constructed upon a model of spontaneous breaking of local symmetry (ref. note above: The meaning of the spontaneous symmetry breaking and its relevance to Elitzur theorem).

The model describes massive gravitational and dark fields and their interaction with the vector field based on the Fierz-Pauli approach.

Gauge bosons acquire masses as a result of the interaction with a massive combined gravitational- dark field.

a) in the ‘mixed’ state gravitational-dark field is reduced to case characterized by scalar mode. This corresponds to the Higgs model:

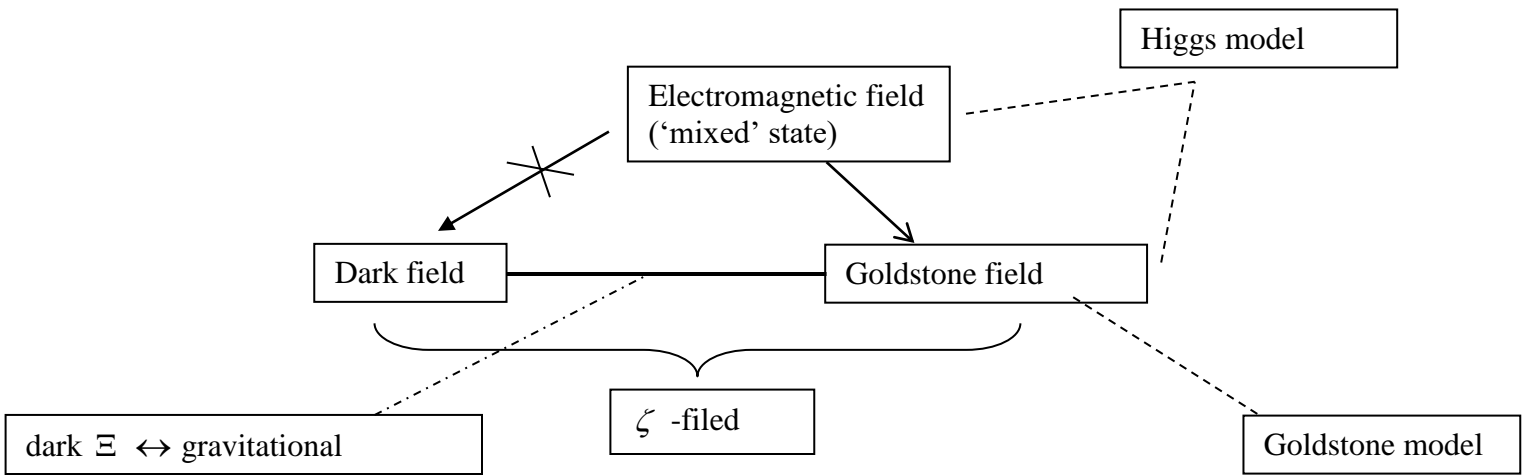

Fig. TF-1.1 Correspondence to Higgs mechanism (theory framework).

In this case the mass channel is driven by Goldstone boson.

Obtaining mass by vector gauge boson is due to coupling between vector gauge boson and scalar mode. Scalar mode mass range is characterized by dark boson value.

↪ electromagnetic (gauge) field is massless due to non- interaction with scalar mode.

Viz. Ansatz: Lagrangian under small perturbations incorporates (Ivo van Vulpen, *The Standard Model Higgs Boson*, www.niknef.nl/~ivov/HiggsLectureNote.pdf, 2014):

⋪

1. the appearance of mass term for photon, which is associated with gauge field of the theory in ‘mixed’ state (case before symmetry breaking);

2. the additional term $-evA_i(\partial^i\eta)$, which is associated with the coupling limit of the presented theory, thus having specific meaning.

⋭ the equations below are presented by notations which are specific to the new bosonic mechanism

1, 2. Unitary gauge is defined as follows:

$$A'_i(x) = A_i(x) + \partial_i f(x), f(x) = -\frac{e\eta(x)}{v}$$

where,

$\eta(x)$ tensor-gravitational::dark field $\{h::\Xi\}$;

the presented mechanism describes Goldstone-dark scalar beyond the decoupling limit.

⋪ ⋪ Proving renormalizability of the presented theory is based on renormalizability of theories with spontaneously broken symmetries. This includes the proof that Lagrangian of the theory corresponds to the special cases, which are described in *Renormalization and symmetry* by T. Banks (ref. *Modern Quantum Field Theory A Concise Introduction*, Cambridge University Press, 2008).

⋭ ⋭ ‘tHooft gauge is defined as follows:

$$\partial_i A^i(x) - k_h h(x) = 0$$

where,

$h(x)$ tensor-gravitational field $\left\{ \left(\equiv \langle g^{ik} \rangle h_{ik} \right), \langle \ \ \rangle \right.$ is the vacuum value $\left. \right\}$ defines scalar;

k_h is gravitational field mass;

the presented mechanism describes gravitational scalar in decoupling limit.

This eqs. are relevant to the presented new mechanism and they mathematically formulate the process of spontaneous symmetry breaking on direct path (i.e. transition from the ‘mixed’ state to ‘pure’ state of the gauge field). While the former corresponds to tensor-gravitational::dark field coupling limit (i.e., ref. electromagnetic field in ‘mixed’ state); the later corresponds to tensor-gravitational::dark field decoupling limit (i.e., ref. electromagnetic field in ‘pure’ state).

Since the dark mode can initiate vacuum instability in the theory (direct path), this process have to be augmented by the implementation of the mechanism of restoring symmetry (restoring path).

b) in the ‘pure’ state the gravitational-dark field is reduced to case characterized by tensor mode. This corresponds to ‘the new bosonic mechanism’ model:

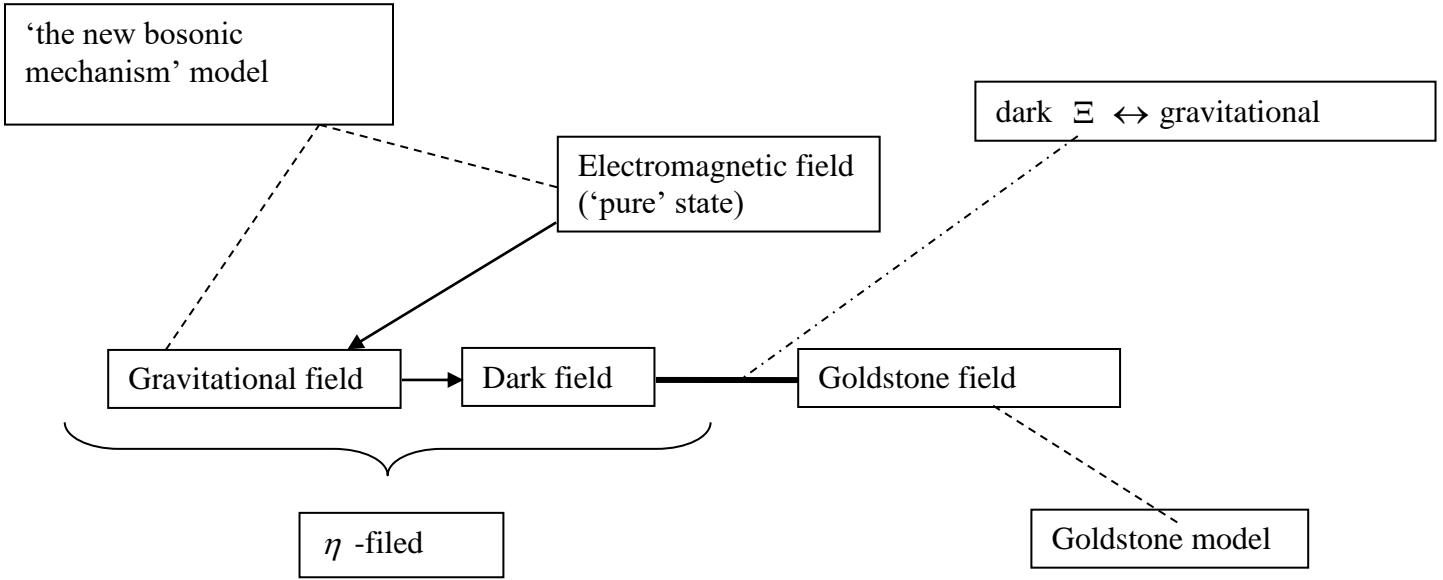

Fig. TF-1.2 Correspondence to ‘the new bosonic mechanism’ (theory framework).

In this case the mass channel is driven by gravitational field.

1-channel (gravitational): \exists coupling between vector gauge boson B_k and gravitational field h_{ik} .

2-channel (tensor-gravitational): \exists coupling (due to tensor-graviton h) between vector gauge boson B_k and dark boson Ξ .

↳ Obtaining mass by vector gauge boson is due to coupling between vector gauge boson and tensor-graviton (tensor mode, in this case, is reduced to tensor-gravitational scalar mode by coupling with inverse metric tensor).

In the outlined mechanism tensor-graviton represents connection bundle, which connects (\Leftrightarrow couples) dark boson and vector boson.

➤ This coupling results in the fact that the mass of vector gauge boson in scalar sector is identical to combined dark boson mass. Thus, the corresponding mass term in the theory Lagrangian can denote either one.

Following diagram depicts two possible channels of gravitational coupling.

↳ gravitational coupling in the theory framework

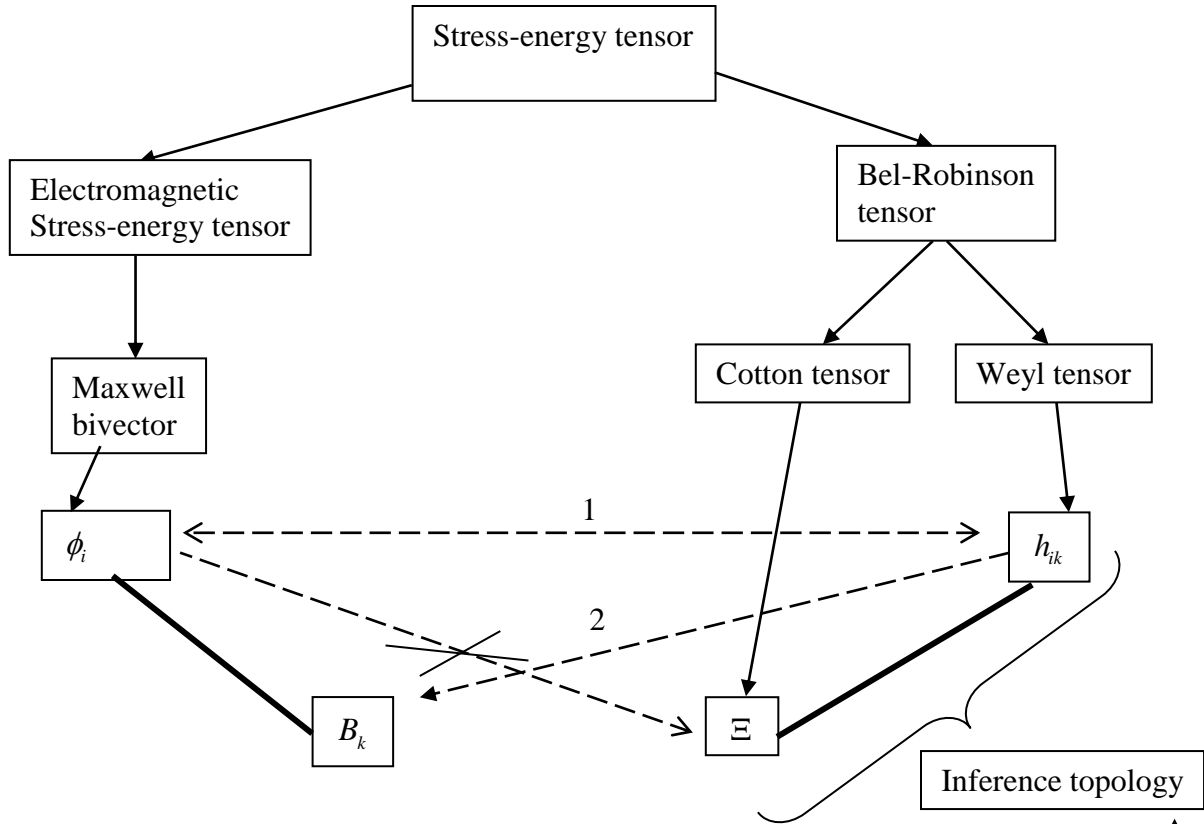
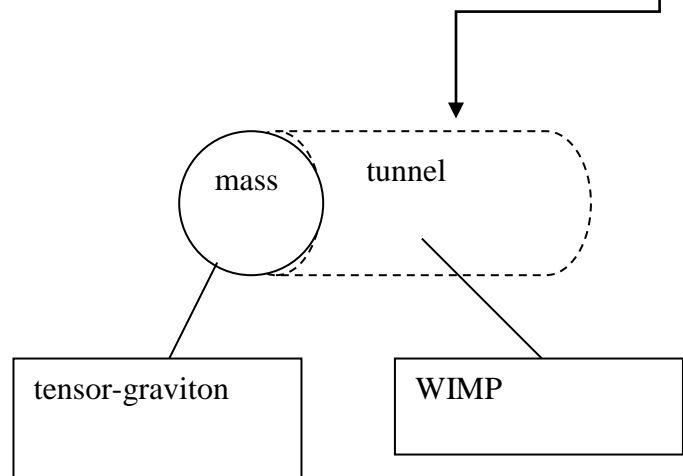

Fig. TF-1.3 Coupling due to h - tensor-graviton.



WIMP (dark part \leftrightarrow tunnel) interacts with baryonic matter by means of tensor-graviton (gravitational part \leftrightarrow mass).

↗ 1-channel (gravitational): \exists coupling between photon with gravitational field h_{ik} ; there is no interaction between photon ϕ_i and dark sector Ξ .

↖ electromagnetic (gauge) field is massive due to non minimal interaction with tensor mode, thus corresponding to the Ginzburg -Landau model.

Sections identified below represent major segments in the structure of the paper. The structure is focused on the role which the electromagnetic field plays in the mechanism.

I.

Step 1 (Model of gravitational-dark field masses).

As Weyl's conjecture associates gauge with a local symmetry and the change of phase with $U(1)$ gauge symmetry, the electromagnetic field appears as a result of quantum mechanical consideration of the wave function of a charged particle.

The electromagnetic field, which appears as a result of the above-mentioned process, is presented in 'mixed' and 'pure' states, which accordingly correspond to the cases Before symmetry breaking (ref. 'Lagrangian for non-interaction') and After symmetry breaking (ref. 'Lagrangian for interaction')^{note}.

Step 2 (Case: before symmetry breaking).

The paper presented in this case the description of obtaining mass by dark (Goldstone-dark) field.

The consideration starts from the assumption that Goldstone and gravitational-dark fields interact. The composite system of electromagnetic field in 'mixed' state and a scalar gravitational-dark field interact with a vacuum state.

As result of this interaction the following is obtained:

a) in the domain of electromagnetic field - vacuum state, vacuum state coincides with the Goldstone field.

Expectation value of this field spontaneously breaks underlying global symmetry which leads to the appearance of massless Goldstone bosons.

b) in the domain of gravitational-dark - vacuum state, there appears a split of massless gravitational and dark components of a massless gravitational-dark field.

Mass term for the dark field appears from substitution vacuum state::tensor-gravitational::dark field -field in 'Lagrangian for non-interaction'.

note

a 'mixed' state is represented as the superposition state of composite system including electromagnetic field \mapsto 'Lagrangian for non-interaction';

a 'pure' state assumes interaction between electromagnetic field and system \mapsto 'Lagrangian for interaction';

the vacuum state represents redundant degrees of freedom, i.e., it is manifestly associated with 'mixed' state of electromagnetic field (gauge field) and Goldstone boson.

ν is the expected value of the vacuum state and appears as a result of gauge symmetry breaking, which, in this framework, means the following:

a) gauge symmetry is the gauge structure represented by a set of three labels-components: vacuum state, tensor-gravitational, dark field;

b) gauge symmetry breaking is the change of gauge structure (i.e., Landau phase transition with order parameter ν), which results in change of the labeling schema from 'mixed' to 'pure'.

end_of_note

(Sub-case: no matter)

a) it is demonstrated by the results described above that matter directly contributes only to the mass of gravitational field;

- for massless spin - 0 (Goldstone) field Fierz-Pauli eq. refers to Goldstone mechanism and is inline with vacuum Einstein eq.;

- for massless gravitational field Fierz-Pauli eq. is reduced to 0;

- dark field is massive due to the first channel - Step 2, item b).

Step 3 (Case: after symmetry breaking).

The consideration includes different topics logically connected and combined under a specified title.

The paper presents in this chapter the description of obtaining mass by massless gravitational field and the appearance of Nambu-Goldstone boson.

It addresses the spontaneous breaking of a local symmetry which leads to obtaining mass by gravitational and Goldstone (appearance of Nambu-Goldstone bosons) components of gravitational-dark field.

As a result of substituting vacuum state::tensor-gravitational::dark field -field in 'Lagrangian for interaction' presented:

mass term for the Goldstone-dark field, i.e. Nambu-Goldstone boson (Goldstone boson remain massless in Step 2) provided that there is non - interaction between dark field and electromagnetic field;

b) massive gravitational field;

i. (Sub-case: force free eq.)

The appearance of the massive gravitational field determines the second channel (in addition to the first channel - Step 2, item b) of the source of mass for dark field, namely the coupling between massive dark field and vacuum metric tensor is described by Klein-Gordon eq. for gravitational interaction action; this coupling exists because the source of dark field is stress-energy tensor for scalar field.

This chapter continues the analysis taking into account the contribution of matter (baryonic).

ii. (Sub-case: matter)

this sub-case determines the second channel (in addition to the first channel - Step 3) of the source of mass for gravitational field, namely the appearance of mass for the gravitational – dark field is due to “stress – energy tensor factor” channel.

According to this mechanism, mass for the gravitational field appears directly as a result of \exists stress – energy tensor, while mass term for dark field appears as a result for the account of the second channel of source of mass for dark field.

In this case, DVZ discontinuity disappears in covariant limit thus reflecting the fact that massive gravitational-dark field in covariant form couples to matter.

II. (Model of boson masses).

This chapter of the paper outlines mechanism of assigning mass to the vector gauge bosons due to the interaction with a massive gravitational - dark field.

Resulted Lagrangian includes terms proportional to square of vector boson field (i.e., mass terms for vector bosons) as well as terms proportional to square of gravitational field and dark field parts of gravitational-dark field (i.e., mass terms corresponding to these parts).

III. (Quantization).

The approach in this chapter is focused on reducing the problem of quantization of gravitational field to the standard methodology of quantization scalar field. To address this issue, the gravitational field is defined through Weyl complex scalar, thus reducing mathematical formulation of quantization to the quantization of scalar field.

Two modes are specifically addressed:

- quantization of tensor-gravitational field (gravitational field in scalar mode) is represented as standard expression for quantized scalar field;
- quantization of gravitational field (tensor mode) is represented by the expression for the quantized form of spin $n (=2)$ field.

The validity of this form is due to the fact that the propagator for spin $n (=2)$ field is expressed through the propagator of scalar field, so that the tensor mode appears from a scalar mode and not from tensor rank - 2 mode.

The outline above means that quantization of tensor mode is provided by means of the extension result obtained for quantized scalar mode transferring to the case of spin $n(=2)$ field (on the basis of corresponding propagator identity) and not by direct quantization of tensor rank - 2 mode (M. Kachelrieß, *Advanced Quantum Field Theory*, Department of Physics NTNU Trondheim Norway, 2010).

IV. (Logically connected and interlinked topics).

This chapter of the paper addresses different topics including, but not limited to, the following:

1. the definition of gauge theory (as the theory which is mathematically related to fiber bundle) application is introduced via ‘inference topology’ defined in the paper and addressing related aspects.

The subject of inference topology is directly related to the types of curvatures which exist in the reference to the space-like hypersurface. These types depend on the value of electromagnetic field and are represented by hypersphere or hypersadle.

The geometry of topological structure constitutes compound of dark (tunnel) and gravitational (mass) parts.

Geometry is characterized as AdS_3 for the dark part and Lorentzian CFT for the gravitational part, which defines the arrow of time.

In the context of gauge theory, the gravitational part is characterized by mass; while the dark part is represented by connected helicoids with two ends in separate points in spacetime. This corresponds to the Piccei-Quinn symmetry.

‘Inference topology’ radiation dynamics corresponds to the solution of the Navier-Stokes eq. in blow-up regime.

2.

a) This theory incorporates the complete Lagrangian, EoM and canonically quantized gravitational field. It was checked for the asymptotic behavior and coincides with Einstein eq. within appropriate limits.

b) Obtained results have specific applications, for example:

1. Case of changing spacetime geometry;
2. It is shown how the theory naturally leads to AdS/CFT correspondence;
3. Obtained reformulation of quantum mechanical wavefunction, i.e. presented the way to treat wavefunction as a continuous function, which describes the object from inside and outside;
4. Based on the group theory, mathematically demonstrated the solution to the arrow of time problem;
5. Obtained a mathematical topological explanation to the entanglement problem and a mechanism of the existence of stable traversable and non-traversable wormholes.

c) Appendixes of this paper present further itemization of the different topics relevant to the outlined framework.

This include:

- i. the mathematical definition to prove different eqs. is referred to in the mechanism;
- ii. consistent Lagrangian of the theory is presented in the paper;
- iii. additional terms are presented which account for non-minimal coupling in ‘Lagrangian for interaction’;
- iv. underlying statistical field theory is introduced in this paper, which is used to explain the quantum effects considered in the framework of the mechanism, namely:
 1. presented mathematical formulation of compact - 3 manifold to compact - 2 manifold correspondence. This framework points out \exists of singularity embedded into hyperkähler manifold.
 2. Presented entropic approach to the analysis of microstates characterizing singularity ^{note} . Noted that the microstates of the system (black body + singularity) are described by quantum mechanics of non-observables developed in Extensions Chapter. The paper also presents the formulation of wavefunction as probability to obtain specific shape at particular point and related to entropy at this point.
 3. The following consideration addresses the structure of gravitational field and the context of the forming singularity. This chapter of the paper presents the formula for vacuum metric which include mathematical reference to \exists of connected helicoids outlined in physical description of dark part of ‘inference topology’ geometry. This is followed by the analysis of the expression for the vacuum metric which is defined by means of ‘power law’ function, thus addressing the presence of renormalization group; and the β -function behavior, which is determined by dint of the mechanism generation of entropy (ref. ^{note} in consideration of microstates characterizing singularity).

In the reference to phase transition, order phase and the behavior of a chaotic attractor of the system ('inference topology') relative to a system parameter are evaluated.

The appendix points to \exists of vortex solution in order phase. The paper also addresses the investigated regimes related to the different behavior of a chaotic attractor. It is also noted in the paper that the wormhole structure can form in tunnel area of system in 'intermitted switching' regime.

v. Connections between the following items are described in the paper as well:

1. instability point;
2. instanton solution;
3. soliton solution;
4. exciton model for the BE condensate (this includes a program for the solution of the Navier-Stokes existence and smoothness problem);
5. absence of vacuum instability in gravitational coupling regime (Fig. TF-1.3), ref. Implication of quantum fluctuations paragraph.

vi. The appearance and the cancellation mechanism for Lorentz violation are discussed in Supplementary Chapter.

vii. Mass scale structure for the outlined mechanism is also presented in Supplementary Chapter.

3. Predictions and findings of the theory

1. The existence of dark boson is predicted. This boson is manifested at the same time as a quant of dark field and as a gauge boson of interaction between particles of dark matter. Dark field represents the fifth dimension possessing a dark-like Killing field with a conserved quantity dark energy.
2. The presented model contributes to Lorentz violation as a result of taking into account dark sector, which leads to the appearance of corresponding terms in Lagrangian of the theory and EoM.
3. The program for the solution of the Navier-Stokes existence and smoothness problem is presented.
4. Resonance peak observed with the mass of 125 GeV at LHC as well as possible resonance peaks at 750 GeV and 2 TeV are explained within the framework of this theory.
5. Observing the appearance of Majorana fermion in 125 GeV decay spectrum would verify this model.

Keyword(s): Unified field theories and models; Quantum mechanics
PACS number(s): 12.10.-g; 03.65.-w

CONTENTS

Abstract	i
I. Introduction	2
II. Framework	5
III. The Mechanism	13
IV. Results and Discussion	43
V. Conclusion	46
Appendix A	
1. The second channel of the mass source for dark field	48
2. Lagrangian of the presented theory	52
3. Considering of non-minimal coupling	56
4. The quantum effects and underlying statistical field theory	57
5. Connections between different topics within a single theoretical framework	65
Appendix A- Additions Chapter: Electrodynamics of thin (non-geometric case) layers	
1. Introduction and purpose	78
2. Plane-parallel plate modes	79
3. Equation for photon density one-particle matrix	87
4. Formula for far zone field energy	89
Appendix B- Extensions Chapter: The quantum theory of non- observables	
1. Perturbation theory	94
2. Proposed model	95
3. Considering Hamiltonian	97
4. Hamilton-Schrödinger equation	102
5. Predicting future values in time series	106
6. Summary	110
7. Expression for a normalized wavefunction	111
8. Constant \hbar in equation for the dynamic of the i -th state wavefunction	113
9. Expression for an average of non-observable measurement	113
10. Expression for standard deviation of measurement	115
11. Expression for eigenvectors and eigenvalues	118
12. Specified applicable time interval for the model	119
13. Influence of perturbations	119
Appendix C- Supplementary Chapter	
1. On the subject of Lorentz violation	124
2. On the subject of quantum statistics	134
3. On the subject of AdS/CFT correspondence	136
4. Mass scale structure and the mathematical connections diagram	138
5. Neutrino oscillation	142
6. The new bosonic mechanism's approach to hierarchy problem	144
7. The new bosonic mechanism approach to resonance peaks at 750 GeV and 2TeV	148
8. On the subject of fermion masses	152
9. On the subject of Hawking radiation	153
10. On the renormalizability of the theory Lagrangian	155
11. Time reversal symmetry violation and Katz schema	161
References	164

CHAPTER I: INTRODUCTION

Presented here is the developing theory on the subject of obtaining masses by bosons (in particular gauge vector bosons).

The scope of the suggested consideration is introducing a mechanism, which is an alternative to the Higgs mechanism; in addition, the proposed new mechanism incorporates dark energy. It was considered that work by (V. Fierz and W. Pauli, 1939) should foster another model for obtaining nonzero masses by fundamental particles.

While negative conclusions regarding construction of consistent interacting theories of higher spin in a form of the gauge theory of several coupled or self-coupled fields were outlined (B. de Wit and D. Freedman, 1980), it is noted that spontaneous breakdown of the unacceptable symmetries is a possibility in order to evade these difficulties (ref. note below).

⋪ The emphasized original hypothesis behind suggested alternative approach mainly constitutes:

a) Dark field.

P1. Postulate: Dark energy determines the existence of a dark field.

b) Curvature of spacetime (the pseudo-Riemannian metric).

P2. Postulate: Gravitational and dark fields compose a single gravitational – dark field.

⋫ The essence of the mechanism is:

i. massless gravitational-dark field acquires mass due to the spontaneous symmetry breaking^{note} and the contribution of matter;

ii. massless vector bosons acquire mass due to the interaction with a massive gravitational-dark field.

⋫ Following are the differences of the underlying mechanism as compared to the Higgs mechanism:

i. there is not a scalar field associated with the Higgs boson, the existence of Higgs boson is not assumed;

ii. gravitational massless component of a gravitational –dark field acquires mass as a result of local symmetry breaking (ref. note, item 2); coupling to matter;

iii. dark massless component acquires mass as a result of global symmetry breaking; gravitational field determines the dark field appearance, as the source of the dark field is the stress-energy tensor; coupling to matter;

iv. gauge bosons acquire mass not as a result of symmetry breaking but due to the interaction with a gravitational-dark field;

v. there is no specific assumption, which is limited to the consideration by gauge vector bosons only.

note:

The meaning of the spontaneous symmetry breaking and its relevance to Elitzur theorem (S. Elitzur, 1975) is emphasized.

1. As specified by the proposed approach there are two paths for spontaneous symmetry breaking, namely, direct and restoring.

↳ a) In direct path:

symmetry breaking mechanism (G-type, described below) is analogous to the standard approach (F. Mandl and G. Shaw, 2010; R. Durka, 2008; Ivo van Vulpen, 2014) with Elitzur constraint, i.e., spontaneously breaking global symmetry \mapsto explicitly breaking of local symmetry by a gauge fixing term, ref. eqs. (0.1.1) and (0.1.2). Thus, equations of the proposed theory formally coincide with standard theory equations although the physics are very different.

As outlined in the essence of the mechanism (Chapter 1), the first stage of this process leads to mass appearance in dark sector and the second stage leads to mass appearance in gravitational (metric) sector. This process corresponds to moving gauge field from ‘mixed’ state at the first stage (coupled with G-D scalar mode) to ‘pure’ state at the second stage (decoupled from G-D tensor mode). This results in obtaining gauge bosons mass by means of application of a two-stage schema.

↳ b) In restoring path:

There is a restoring force (due to dark sector in reference to dark energy), which restores the symmetry from local to global. In this context restoring means cancellation of gauge field in eq. (0.1.2), so there is no gauge fixing anymore, thus no spontaneous breaking of local symmetry can occur. State of symmetry is therefore restored to global, ref. eq. (0.1.1). This process corresponds to moving gauge field from ‘pure’ (-split) state (decoupled from G-D tensor mode) back to ‘mixed’ state (coupled with G-D scalar mode). This results in loosing mass by gauge bosons and returning into massless form.

a, b \succ The process of coupling and decoupling of gauge field, i.e., moving between ‘mixed’ and ‘pure’ states is spontaneous and as such is used in this context throughout the paper. This spontaneous process is entropy directed and driven and plays a crucial role in obtaining masses in gravitational (metric) sector (G-type). Thus, entropy plays a role of a parameter to determine preference of a) –path over b) –path.

2. In the context of local symmetry, the spontaneous symmetry breaking means that the state of gauge field spontaneously changes from ‘mixed’ to ‘pure’, thus explicitly breaking local symmetry by gauge fixing term on a) –path; the state of gauge field can also spontaneously change from ‘pure’ to ‘mixed’, thus restoring the state of global symmetry by restoring force on b) –path).

<Flowchart to the mechanism>

I. Model of gravitational-dark field masses:

- introduced types of interactions and their interpretations;
- presented a symmetry breaking mechanism with corresponding Lagrangians.

Cases:

- before symmetry breaking

- presented the split in a gravitational-dark field as a result of an interaction with a vacuum state (see note);
- FP Lagrangian for massless fields;
- FP eq. to describe the behavior of massless spin 0 field and spin 2 field;
- acquire masses by Goldstone- dark field;

Sub-cases:

- no matter

- FP eq. to describe the behavior of massless spin 0 and spin 2 fields;

- after symmetry breaking

- FP Lagrangian for massive fields;
- FP eq. to describe the behavior of massless spin 2 field interaction with an electro- magnetic field;
- massless spin 0 field does not interact with an electromagnetic field;
- acquiring masses by a gravitational field;

Sub-cases:

- force-free eq.

- FP eq. to describe the behavior of massive spin 2 field, which determines the appearance of a massive dark field, as the source of a dark field is the stress-energy tensor (see note);
- eq. to describe massive spin 0 field (note coupling to gravity as it depends on the spin 2 field);

- matter

- system Lagrangian;
- gravitational massless component acquires mass due to coupling to matter; dark massless component acquires mass due to coupling to matter.

II. Model of boson masses, as a result of the application of a specified mechanism:

- with $h-B$, $\zeta-B$ interaction

- FP Lagrangian in the form of h_{ik} , ζ accounts for the interaction with a spin 1 field to address for masses obtained by gauge vector bosons;
- FP eq. for massive spin 2 and spin 0 fields interaction with massless spin 1 field.

III. Quantization:

- real and complex scalar fields;
- gravitational field.

IV. Logically connected and interlinked topics.

CHAPTER II: FRAMEWORK

The main purpose of the paper is the comparison between the noted (new bosonic) mechanism and Higgs mechanism.

Following is the analysis of these mechanisms:

1. Higgs mechanism.

Higgs approach demonstrates physical and mathematical discrepancies.

a)

i. physical discrepancy consists in formulated instability of vacuum. The subject of the vacuum instability is outlined in presentations by Joseph Lykken at AAAS and Steven Hawking in “Starmus”; as well as in Frank Wilczek’s article in Nature (M.S. Turner and F. Wilczek, 1982).

(In the framework presented in the paper this discrepancy can be explained by referencing the second law of thermodynamics which states that entropy must increase so as to reach the state with maximum symmetry, ref. ‘the special symmetry evolution principle’, (J. Rosen, 2005)).

Higgs’ approach assumes that gauge bosons acquire mass as a result of symmetry breaking (on misuse of this terminology, ref. M. Dine, T. Banks and S. Sachdev, TASI, 2012) and, in this model, there is no driving force to restore the state of maximum symmetry, i.e., there is no mechanism of increasing entropy in this theory.

This leads to the instability of Higgs’ solution (ref. instability of vacuum, (M.S. Turner and F. Wilczek, 1982)).

ii. application of Elitzur theorem to Higgs theory leads to the conclusion that Higgs field does not have expectation value and as a result cannot spontaneously break symmetry.

b)

i. mathematical discrepancy follows from the analysis outlined in Higgs model presentation in (F. Mandl and G. Shaw, 2010; R. Durka, 2008; Ivo van Vulpen, 2014) where the main focus of the analysis is on the usage of unitary gauge, which assumes the elimination of ‘ghost field’; however, proving renormalizability of this model is provided in ‘tHooft gauge requiring reintroduction of the ‘ghost field’.

Presence of virtual particles (quantum fluctuations) associated with the ‘ghost field’ leads to instability of vacuum solution in Higgs model.

This two contradictory mathematical procedures which are required to prove Higgs model demonstrate build-in mathematical discrepancy and their existence points to the necessity of introducing the driving force to restore the state of maximum symmetry.

2. The new bosonic mechanism.

The new bosonic approach demonstrates physical consistency and, as result, does not include mathematical discrepancy.

The mechanism described in this paper represents a stable solution whereas Higgs mechanism represents an unstable solution. The scalar term obtained within the scope of the presented approach is consistent in action of assigning mass to vector gauge boson with the corresponding result obtained by means of Higgs scalar (ref. Chapter IV, item v. a).

Physical consistency is determined by the following: the mechanism presented in this paper (ref. Conclusion) incorporates the driving force which restores the state of maximum symmetry from the state of symmetry breaking.

The dark energy, which is the driving force, increases the volume, which leads to the state with more entropy, i.e. symmetry. This driving force is determined by the requirement to cancel local vacuum fluctuations (i.e. maintain the thermodynamic equilibrium between baryonic sector and the thermal bath).

The thermal bath – micro black hole (b.h.) system increases entropy due to accretion of matter and uses Hawking’s radiation to make this entropy equal to the baryonic sector entropy in order to reach thermodynamic equilibrium and obtain stable solution.

Viz. Ansatz: the Higgs mechanism (F. Mandl and G. Shaw, 2010; R. Durka, 2008; Ivo van Vulpen, 2014), Lagrangian under small perturbations incorporates:

↳

1. the appearance of mass term for photon, which is associated with gauge field of the theory in ‘mixed’ state (case before symmetry breaking);

2. the additional term $-evA_i(\partial^i\eta)$, which is associated with the coupling limit of the presented theory, thus having specific meaning.

↳

1, 2. Unitary gauge is defined as follows:

$$A'_i(x) = A_i(x) + \partial_i f(x), f(x) = -\frac{e\eta(x)}{v} \quad (0.0.1)$$

where,

$\eta(x)$ ref. eqs. (1.1), (1.1 b);

the presented mechanism describes Goldstone-dark scalar, ref. eq. (1.3 a) beyond the decoupling limit.

↖ ↗ Proving renormalizability of the presented theory is based on renormalizability of theories with spontaneously broken symmetries (ref. Renormalization and symmetry by T. Banks, 2008).

■

The proof that Lagrangian of the theory (ref. eq. 1.4.1a) corresponds to the special cases (ref. T. Banks, 2008) is outlined in Appendix A, paragraph 2, item II (ref. eqs. (A 2.2.1), (A 2.2.2)).

■

↘ ↙ 'tHooft gauge is defined as follows:

$$\partial_i A^i(x) - k_h h(x) = 0 \quad (0.0.2)$$

where,

$h(x)$ ref. eq. (1.1 a);

the presented mechanism describes gravitational scalar, ref. eq. (1.5) in decoupling limit.

This eqs. are relevant to the presented new mechanism and they mathematically formulate the process of spontaneous symmetry breaking on direct path (i.e. transition from the 'mixed' state to 'pure' state of the gauge field). While the former corresponds to tensor-gravitational::dark field coupling limit, ref. eq. (0.1.1); the later corresponds to tensor-gravitational::dark field decoupling limit, ref. eq. (0.1.2).

Since the dark mode can initiate vacuum instability in the theory (direct path), this process have to be augmented by the implementation of the mechanism of restoring symmetry (restoring path).

3. The description of new bosonic mechanism structure.

This paper introduces the mechanism based on two postulates: P1, P2 and outlines its structure in <Flowchart to the mechanism>. Next in the paper is the presentation of the detailed description of the mechanism which is formulated as a consistent schema build upon different logically connected and interlinked topics. The methodology presented in the paper addresses the problem of obtaining masses by gauge vector bosons and the solutions to the interconnected problems within the outlined framework.

Further consideration is presented in the steps below and is focused on the role which the electromagnetic field plays in the schema.

I.

Step 1 (ref. Flowchart, paragraph I – Model of gravitational-dark field masses).

As Weyl's conjecture associates gauge with a local symmetry and the change of phase with $U(1)$ gauge symmetry, the electromagnetic field appears as a result of quantum mechanical consideration of the wave function of a charged particle.

The electromagnetic field, which appears as a result of the above-mentioned process, is presented in 'mixed' and 'pure' states, which accordingly correspond to the cases Before symmetry breaking (ref. 'Lagrangian for non-interaction') and After symmetry breaking (ref. 'Lagrangian for interaction')^{note}.

Step 2 (ref. Flowchart, paragraph I – Case: before symmetry breaking).

The paper presented in this case the description of obtaining mass by dark (Goldstone-dark) field.

The consideration starts from the assumption that Goldstone and gravitational-dark fields interact. The composite system of electromagnetic field in 'mixed' state and a scalar gravitational-dark field interact with a vacuum state.

As result of this interaction the following is obtained:

a) in the domain of electromagnetic field - vacuum state, vacuum state coincides with the Goldstone field.

Expectation value of this field spontaneously breaks underlying global symmetry which leads to the appearance of massless Goldstone bosons.

b) in the domain of gravitational-dark - vacuum state, there appears a split of massless gravitational and dark components of a massless gravitational-dark field.

Mass term for the dark field appears from substitution Φ -field (ref. below) in 'Lagrangian for non-interaction'.

note:

a 'pure' state assumes interaction between electromagnetic field and system;
a 'mixed' state is represented as the superposition state of composite system including electromagnetic field.

(Ref. below) for 'Lagrangian for non-interaction' and 'Lagrangian for interaction', i.e. eq. (0.1.1) and eq. (0.1.2) correspondently.

(ref. Flowchart, paragraph I – Sub-case: no matter):

a) it is demonstrated by the results described above that matter directly contributes only to the mass of gravitational field;

- for massless spin - 0 (Goldstone) field FP eq. refers to Goldstone mechanism and is inline with vacuum Einstein eq.;
- for massless gravitational field FP eq. is reduced to 0;
- dark field is massive due to the first channel - Step 2.

Step 3 (ref. Flowchart, paragraph I – Case: after symmetry breaking).

The consideration includes different topics logically connected and combined under a specified title.

(ref. Sub-cases)

1. The paper presents in this chapter the description of obtaining mass by massless gravitational field and the appearance of Nambu-Goldstone boson.

It addresses *the spontaneous breaking of a local symmetry* which leads to obtaining mass by gravitational and Goldstone (appearance of Nambu-Goldstone bosons) components of gravitational-dark field.

As a result of substituting Φ -field in ‘Lagrangian for interaction’ presented:

- a) mass term for the Goldstone-dark field, i.e. Nambu-Goldstone boson (Goldstone boson remain massless in Step 2) provided that there is non - interaction between dark field and electromagnetic field;
- b) massive gravitational field;

(ref. Flowchart, paragraph I – Sub-case: force free eq.):

The appearance of the massive gravitational field determines the second channel (in addition to the first channel - Step 2) of the source of mass for dark field, namely the coupling between massive dark field and vacuum metric tensor is described by Klein-Gordon eq. for gravitational interaction action; this coupling exists because the source of dark field is stress-energy tensor for scalar field.

2. This chapter continues the analysis taking into account the contribution of matter (baryonic).

(ref. Flowchart, paragraph I – Sub-case: matter):

b) this sub-case determines *the second channel* (in addition to *the first channel - Step 3*) of the source of mass for gravitational field, namely the appearance of mass for the gravitational – dark field *is due to “stress – energy tensor factor” channel.*

According to this mechanism, mass for the gravitational field appears directly as a result of \exists stress – energy tensor, while mass term for dark field appears as a result for the account of the second channel of source of mass for dark field.

In this case, DVZ discontinuity disappears in covariant limit thus reflecting the fact that massive gravitational-dark field in covariant form couples to matter.

II. (ref. Flowchart, paragraph II – Model of boson masses).

This chapter of the paper outlines mechanism of assigning mass to the vector gauge bosons due to the interaction with a massive gravitational - dark field.

Resulted Lagrangian includes terms proportional to square of vector boson field (i.e., mass terms for vector bosons) as well as terms proportional to square of gravitational field and dark field parts of gravitational-dark field (i.e., mass terms corresponding to these parts).

III. (ref. Flowchart, paragraph III – Quantization).

The approach in this chapter is focused on reducing the problem of quantization of gravitational field to the standard methodology of quantization scalar field. To address this issue, the gravitational field is defined through Weyl complex scalar, thus reducing mathematical formulation of quantization to the quantization of scalar field.

Two modes are specifically addressed:

- quantization of tensor-gravitational field (gravitational field in scalar mode) is represented as standard expression for quantized scalar field;
- quantization of gravitational field (tensor mode) is represented by the expression for the quantized form of spin $n(= 2)$ field.

The validity of this form is due to the fact that the propagator for spin $n(= 2)$ field is expressed through the propagator of scalar field, so that the tensor mode appears from a scalar mode and not from tensor rank - 2 mode.

The outline above means that quantization of tensor mode is provided by means of the extension result obtained for quantized scalar mode transferring to the case of spin $n(= 2)$ field (on the basis of corresponding propagator identity) and not by direct quantization of tensor rank - 2 mode (M. Kachelrieß, 2010; J. Thaler, 2003).

IV. (ref. Flowchart, paragraph IV – Logically connected and interlinked topics).

This chapter of the paper addresses different topics including, but not limited to, the following:

1. the definition of gauge theory (as the theory which is mathematically related to fiber bundle) application is introduced via ‘inference topology’ defined in the paper and addressing related aspects.

The subject of inference topology is directly related to the types of curvatures which exist in the reference to the space-like hypersurface. These types depend on the value of electromagnetic field and are represented by hypersphere or hypersadle.

The geometry of topological structure constitutes compound of dark (tunnel) and gravitational (mass) parts.

Geometry is characterized as AdS_3 for the dark part and Lorentzian CFT for the gravitational part, which defines the arrow of time.

In the context of gauge theory, the gravitational part is characterized by mass;

while the dark part is represented by connected helicoids with two ends in separate points in spacetime. This corresponds to the Piccei-Quinn symmetry.

‘Inference topology’ radiation dynamics corresponds to the solution of the Navier-Stokes eq. in blow-up regime.

2. Appendixes of this paper present further itemization of the different topics relevant to the outlined mechanism.

- Appendix A1 presents the mathematical definition to prove different eqs. referred to in Flowchart.

-Appendix A2 presents considerations which make possible to formulate and prove consistent Lagrangian of the theory.

-Appendix A3 formulates additional terms which account for non-minimal coupling in ‘Lagrangian for interaction’.

-Appendix A4 addresses the formulation of underlying statistical field theory which is used to explain the quantum effects considered in this appendix, namely

a) presented mathematical formulation of compact - 3 manifold to compact - 2 manifold correspondence. This framework points out \exists of singularity embedded into hyperkähler manifold.

b) presented entropic approach to the analysis of microstates characterizing singularity^{note}. Noted that the microstates of the system (black body + singularity) are described by quantum mechanics of non-observables developed in Appendix B - Extensions Chapter. The paper also presents the formulation of wavefunction as probability to obtain specific shape at particular point and related to entropy at this point.

c) The following consideration addresses the structure of gravitational field and the context of the forming singularity.

This chapter of the paper presents the formula for vacuum metric which include mathematical reference to \exists of connected helicoids outlined in physical description of dark part of ‘inference topology’ geometry. This is followed by the analysis of the expression for the vacuum metric which is defined by means of ‘power law’ function, thus addressing the presence of renormalization group; and the β -function behavior, which is determined by dint of the mechanism generation of entropy (ref. ^{note}, in consideration of microstates characterizing singularity).

In the reference to phase transition, order phase and the behavior of a chaotic attractor of the system (‘inference topology’) relative to a system parameter are evaluated.

The appendix points to \exists of vortex solution in order phase. The paper also addresses the investigated regimes related to the different behavior of a chaotic attractor. It is also noted in the paper that the wormhole structure can form in tunnel area of system in ‘intermitted switching’ regime.

- Appendix A5 presents the diagram which depicts the connections between different topics within a single framework of the theory.

Each part of the diagram is marked and contains the description of the context of the mark. The text of the appendix following the diagram provides corresponding definitions of the following items in the diagram:

- a) instability point;
- b) instanton solution;
- c) soliton solution;
- d) exciton model for the BE condensate (this includes a program for the solution of the Navier-Stokes existence and smoothness problem);
- e) role of quantum fluctuations in reference to the presented mechanism.

3. Relevant issues of Lorentz violation and the corresponding constraints are discussed. The spin-statistics theorem is considered mathematically in the framework of the outlined approach.

The presented approach denotes that AdS/CFT correspondence can be incorporated into the framework of the outlined mechanism under the consideration of the theory of superconductivity.

CHAPTER III: THE MECHANISM

Model of gravitational-dark field masses.

Following approach specifies tensor-gravitational-dark field $\eta(x)$ as a single field and dark energy as energy of a dark field and can formulate a mechanism for obtaining masses in bosonic systems.

1. Abelian symmetry breaking.

According to the standard approach to spontaneous symmetry breaking (F. Mandl and G. Shaw, 2010; R. Durka, 2008; Ivo van Vulpen, 2014), the transition from a global symmetry of the system to a local symmetry is provided by introducing an interaction gauge field, i.e. electromagnetic field ϕ_i .

Interaction:

i. Before symmetry breaking, vacuum state::tensor-gravitational-dark field $\Phi(x)$ is not coupled^{note¹} to an electromagnetic (gauge) field;

ii. When symmetry is broken, the field $\Phi(x)$ is coupled (^{note} ref. on symmetry breaking mechanism) to a gauge electromagnetic field.

note:

¹ for a phase of vacuum to define a gauge (i.e., electromagnetic field appears as a result of the restoring of the invariance relative to local phase rotations), a scalar field Φ must have a phase (i.e., be complex), then have a nonzero vacuum expectation value V .

The vacuum state represents redundant degrees of freedom, i.e., it is manifestly associated with ‘mixed’ state of electromagnetic field (gauge field) and Goldstone boson.

Thus, V is the expected value of the vacuum state and appears as a result of gauge symmetry breaking, which, in this framework, means the following:

a) gauge symmetry is the gauge structure represented by a set of three labels-components mentioned above (separated by ::) which denote $\Phi(x)$;

b) gauge symmetry breaking is the change of gauge structure (i.e., Landau phase transition with order parameter V ^[1,1]), which results in change of the labeling schema from ‘mixed’ (ref. Mark 2, Fig. 6 below) to ‘pure’ (-split, ref. Mark 4, Fig. 6 below).

This corresponds to Interaction **ii** (Chapter III, paragraph 1) and is not affected by Elitzur’s theorem (as Mark 2, Fig. 6 below indicates global symmetry, while Mark 4, Fig. 6 below indicates local symmetry). As depicted by Mark 4, Fig. 6 below, spontaneous^[1,2] breaking of local symmetry occurs due to the presence of gauge fixing term. The state, which represents local symmetry is a ‘pure’ state of gauge field decoupled (- split) from the G-D tensor mode (ref. eq. 0.1.2). The cancellation of gauge fixing term reduces symmetry to global (ref. eq. 0.1.1), thus implying the mechanism of restoring symmetry with dark energy as the driving force.

^{1,1} this parameter is not a result of calculation of the expectation value of gauge -covariant quantity (ref. note 0.1., Interaction **ii**). Since the gauge redundant term (i.e., fluctuation of order parameter around its expectation value outside of the ordered phase) equates to zero and the order parameter is non-zero at the ordered phase then there exist Goldstone modes in the direction where the symmetry is not broken (assuming there is no Higgs mechanism) and is described by σ -models (ref. Fig. 3, case **c**) below).

^{1,2} the term ‘spontaneous’ means spontaneous changing of states from ‘mixed’ to ‘pure’(-split), which denotes the following:

- a) explicit breaking of local symmetry (in this case);
- b) spontaneous breaking of global symmetry (ref. gauge symmetry breaking above).

end_of_note

⋈ without interacting with an electromagnetic field, i.e. before symmetry breaking (Mexican hat potential has a flat direction, corresponds to a U(1) model –Goldstone)

$$L(\Phi) = |\partial\Phi|^2 - \lambda(|\Phi|^2 - v^2)^2 \quad (0.1.1)$$

so $\Phi(x)$ corresponds to **1 i**);

⋈ this model is an origin of appearance v at the vacuum state, i.e. gives mass to the Goldstone-dark field (gapless excitation).

⋈ interacting with an electromagnetic field, i.e. after symmetry breaking (transforms from Lagrangian invariant with respect to global symmetry from a U(1) group – Abelian to one invariant with respect to local symmetry or gauge-invariant)

$$L(\Phi, \phi) = -\frac{1}{4} F^{ik} F_{ik} + |D\Phi|^2 - \lambda(|\Phi|^2 - v^2)^2 \quad (0.1.2)$$

where,

$$F_{ik} = \partial_i \phi_k - \partial_k \phi_i;$$

ϕ_i is a covariant four-potential of the electromagnetic field;

the interaction with photons via minimal substitution (ref. 4.8 Problems; (M. Kachelrieß, 2010)

$$D_i \Phi = \partial_i \Phi + ie\phi_i \Phi;$$

so $\Phi(x)$ corresponds to **1 ii**);

⋈ this model is an origin of appearance of only a massive gravitational field and a Goldstone-dark field (due to the massive Goldstone field).

$\left(\partial \rightarrow \frac{\partial}{\sqrt{2}}, \sqrt{\lambda} \rightarrow \frac{\sqrt{\lambda}}{\sqrt{2}}, v \rightarrow \frac{v}{\sqrt{2}} \right)$ substitutions eliminate the constant term from the eq. (0.1.1) - (0.1.2).

1.1. Before symmetry breaking.

The theory, as presented here, will assume that the Goldstone field^{note¹} and a gravitational-dark field interact.

In this case, a scalar field is complex, applying scheme (F. Mandl and G. Shaw, 2010; R. Durka, 2008; Ivo van Vulpen, 2014):

$$\Phi(x) = \nu + \xi(x) + i\eta(x) \quad (1.1)$$

where,

$\xi(x)$ -vacuum state (coincides with Goldstone field);

$\eta(x)$ - gravitational –dark field is complex due to the interaction with a Goldstone field^{note²}

$$\eta(x) = h(x) - i\Xi(x) \quad (1.1 \text{ a})$$

It is normally assumed that:

$h(x)$ - gravitational field part^{note^{cf.}}, i.e. massless tensor of second rank spin 2 field;

$\Xi(x)$ - dark field part, i.e. massless scalar spin 0 field (dark boson)^{note³}.

When substituting eq. (1.1 a) in eq. (1.1), the following is obtained:

$$\Phi(x) = \nu + \xi(x) + \Xi(x) + ih(x) \quad (1.1 \text{ b})$$

^{note^{cf.}}. Viz. tensor-gravitational field $h \left\{ \left(\equiv \langle g^{ik} \rangle h_{ik} \right), \langle \quad \rangle \right\}$ is the vacuum value } defines scalar, where $\langle g^{ik} \rangle$ is conditioned by the existence of $\varepsilon^{jlk} C_{jlk}^i$ vector field \mathcal{G}^i (Weyl curvature tensor C_{jlk}^i , ε^{jlk} Levi-Civita symbol) when $\phi^i = 0$ in a ‘pure’ state, i.e. in accordance with the theorem on constructing spacetime from a compact manifold, namely (ref. spacetime):

➤ A compact manifold can be turned into a spacetime only if its Euler characteristic is 0 (the existence of a Lorentzian metric is shown to be equivalent to the existence of a nonvanishing vector field);

as a metric tensor is attributed to Riemannian manifold (Riemann curvature tensor expresses the curvature of Riemannian manifold) and Ricci tensor is defined as a trace of the Riemann curvature tensor, and is related to the matter by means of the Einstein field equation, therefore, h defines the physics of the curvature of spacetime.

Ansatz: in case of tensor-gravitational field, eq. (1.1 a) defines $\eta(x)$ and Goldstone-dark field $\zeta(x)$ is defined by eq. (1.3 b);

thus eq. (1.1 b) represents a ‘mixed’ state for a system of gravitational-dark and Goldstone-dark fields.

note .

composite system of an electromagnetic ϕ_i field and a scalar η gravitational-dark field that attribute to the geometry of the space-time, described as a superposition (A.S. Davidov,1976) state, interacts with a vacuum state:

¹ as a result of ξ - ϕ interaction, vacuum state ξ coincides with the Goldstone field, i.e. ξ is the scalar field of continuous symmetry, which is spontaneously broken to the Goldstone field.

ξ field assumes a certain value V , i.e. a value of the ξ field viz., the potential energy is zero but the value of the ξ field is nonzero;

V - shift ^{note} in field $\Phi(x)$ corresponds to the vacuum state ξ which contains no particles:

vacuum state (a vacuum expectation value of a scalar field) \mapsto

V expectation value which breaks the internal symmetry of a vacuum, i.e. spontaneous symmetry breaking occurs \mapsto

spontaneous symmetry breaking of the underlying global symmetry leads to the conversion of components of this ξ field to Goldstone bosons.

² as a result of ξ - η interaction, a split of η into gravitational (spin 2) and dark (spin 0) components of single η field appears;

where,

ξ - Ξ ($\equiv \zeta$) interaction is the same as Goldstone-dark field ζ and is the source of spontaneous violation of local Lorentz invariance;

thus the appearance of h in eq. (1.1 a) is conditioned by ζ .

³ note the negative sign before the second term, which points out that dark energy is negative.

note:

have to differentiate the postulated Higgs field from a vacuum state, so V is due to a vacuum state and not the Higgs field.

FP. Lagrangian in a form is ^{note¹} (for notation (ref. (A 2.1))):

$$L_{FP} = k^2 (A_{ik})^2 + \left(\frac{\partial A_{ik}}{\partial x_l} \right)^2 - 2 \frac{\partial A_{rk}}{\partial x_r} \frac{\partial A_{sk}}{\partial x_s} - \frac{3}{4} k^2 C^2 - \frac{3}{8} \left(\frac{\partial C}{\partial x_l} \right)^2 + \frac{\partial A_{rk}}{\partial x_r} \frac{\partial C}{\partial x_k} \quad (1.2.1 \text{ a})$$

for massless ($k_h = 0, k_\zeta = 0$) gravitational and dark fields:

$$L_{FP} = \left(\frac{\partial A_{ik}}{\partial x_l} \right)^2 - 2 \frac{\partial A_{rk}}{\partial x_r} \frac{\partial A_{sk}}{\partial x_s} - \frac{3}{8} \left(\frac{\partial C}{\partial x_l} \right)^2 + \frac{\partial A_{rk}}{\partial x_r} \frac{\partial C}{\partial x_k} \quad (1.2.1 \text{ b})$$

Fierz-Pauli eq. for massless gravitational and dark fields without interaction is ^{note²}

$$-2\Box A_{ik} + 2 \left\{ \frac{\partial^2 A_{sk}}{\partial x_s \partial x_i} + \frac{\partial^2 A_{si}}{\partial x_s \partial x_k} - \frac{1}{2} \delta_{ik} \frac{\partial^2 A_{rs}}{\partial x_r \partial x_s} \right\} - \frac{\partial^2 C}{\partial x_i \partial x_k} + \frac{1}{4} \delta_{ik} \Box C = 0 \quad (1.2.2 \text{ a})$$

$$\frac{3}{4} C - \frac{\partial^2 A_{rk}}{\partial x_r \partial x_k} = 0$$

where, $\Xi(x)$ is an auxiliary scalar field in Fierz-Pauli theory, i.e. corresponds to $\zeta(x)$ in a specified approach.

^{note} :

¹ without interaction with the electromagnetic field ϕ_i
(here and further under interaction with ϕ_i assume a ‘pure’ state) ;

² according to the superposition principle (A.S. Davidov, 1976), if an auxiliary scalar field can exist in states described by ξ and Ξ , then it can exist in a state described by the Goldstone-dark field

$$\zeta(x) = \xi(x) + \Xi(x)$$

Viz., further refers to a dark field, however, where it is appropriate to assume it rather refers to the Goldstone-dark field.

Referring to (0.1.1) and (1.1 b) leads to (using $h-\zeta$ notation to be intact with (A 2.2.1))

$$L = \frac{1}{2}(\partial_i \zeta)^2 + \frac{1}{2}(\partial_i h)^2 - \frac{1}{2}\lambda v^2 \zeta^2 - \frac{1}{2}\lambda v \zeta (\zeta^2 + h^2) - \frac{1}{8}\lambda (\zeta^2 + h^2)^2 \quad (1.3 \text{ a})$$

where,

a shifted Goldstone-dark field is defined as

$$\zeta(x) = v + \xi(x) + \Xi(x) \quad (1.3 \text{ b})$$

$$v = \pm \sqrt{\frac{-k_{\zeta-h}^2}{\lambda}}$$

λ - self - interaction coupling constant;

$k_{\zeta-h}$ - mass for $\Phi(x)$ ($k_{\zeta-h}^2 < 0$);

In case of $v < 0$, it corresponds to dark energy ^{note¹}; if $v > 0$, it corresponds to gravitational energy ^{note²};

massless (k_h) for h and mass ($k_\zeta \equiv \sqrt{\lambda}v$) for ζ .

it is presented that the Goldstone field and the dark field ^{note³} in fact are two real Klein-Gordon fields.

^{note} .

^{1,2} addressing gravitational (gauge) and dark (non-gauge) fields reflects the fact that bosonic mechanism does not follow from a gauge principle;

³ k_Ξ appears as a result of obtaining mass by a dark field, i.e. $k_\Xi = k_\zeta$; ansatz Goldstone boson does not disappear.

i. No matter.

1.1.0. Massless gravitational and dark fields (before symmetry breaking).

Viz., (A1.1)-(A1.2), i.e. FP eq. for **Re** $\Phi(x)$ and **Im** $\Phi(x)$ parts in (1.1 b);
rest-mass $k_\zeta = 0$, $k_\Xi = 0$

massless spin 0 scalar field, i.e. **Re** $\Phi(x)$ part represented for $\Xi(x)$ ^{note¹}

$$-\square\left(\frac{1}{4}\delta_{ik}C\right) - \frac{\partial^2 C}{\partial x_i \partial x_k} + \frac{\partial^2}{\partial x_l \partial x_l} \left(\frac{1}{4}\delta_{lk}C\right) + \frac{\partial^2}{\partial x_l \partial x_k} \left(\frac{1}{4}\delta_{li}C\right) = 0 \quad (1.3.0 \text{ a})$$

i.e. inline with the Einstein eq. without matter, ref. Appendix A1, paragraph 2.

Im $\Phi(x)$ part represented by the Fierz-Pauli eq. for massless spin 2 field

$$\frac{\partial^2 A_{lk}}{\partial x_l \partial x_i} + \frac{\partial^2 A_{li}}{\partial x_l \partial x_k} = 0 \quad (1.3.0 \text{ b})$$

if applied (A1.3.2) , reduced to zero ^{note²} .

note

(ref. A_{ik} defined by (A 2.1), case $\phi_i = 0$):

¹ no coupling between $\langle g^{ik} \rangle$ and dark boson;

² corresponds to absence of h_{ik} in A_{ik} .

1.2. After symmetry breaking.

Following is a presentation of obtaining masses by gravitational and dark components of a combined gravitational-dark field as a result of spontaneous breaking of local symmetry and application of Fierz-Pauli approach (V. Fierz and W. Pauli, 1939) in sub-cases:

i. Force-free.

1.2.0. Obtaining masses for gravitational and dark fields.

It corresponds to the interaction of the gravitational field and the Goldstone field with the electromagnetic field ϕ_i .

Ansatz FP eq. for interaction of massless spin 2 and massless spin 0 Goldstone field with ϕ_i ; then continue to the mechanism of obtaining masses for spin 2 and spin 0 fields, as a result of symmetry breaking.

↖ (dark field does not interact, i.e. $\zeta \mapsto \xi$)

$$i\Pi_k = \frac{\partial}{\partial x_k} - ie\phi_k \tag{1.4.0}$$

$$f_{ik} = \Pi_i \Pi_k - \Pi_k \Pi_i = i \left\{ \frac{\partial \phi_k}{\partial x_i} - \frac{\partial \phi_i}{\partial x_k} \right\}$$

FP. Lagrangian in a form is ^{note¹}:

(1.4.1 a)

$$L_{FP} = k^2 A_{ik}^* A_{ik} + \Pi_l A_{ik} \Pi_l^* A_{ik}^* - 2\Pi_r A_{rk} \Pi_s^* A_{sk}^* + f_{ir} A_{rk} A_{ik}^* + \frac{1}{2} \left\{ \Pi_r A_{rk} \Pi_k^* C^* + \Pi_r^* A_{rk}^* \Pi_k C \right\} - \frac{3}{4} k^2 C^* C - \frac{3}{8} \Pi_l C \Pi_l^* C^*$$

^{note} :

¹ with interaction with electromagnetic field ϕ_i .

for massless spin 2 field interaction with an electromagnetic field

$$(k_h = 0, k_\xi = 0)$$

(1.4.1 b)

$$L_{FP} = \Pi_l A_{ik} \Pi_l^* A_{ik}^* - 2\Pi_r A_{rk} \Pi_s^* A_{sk}^* + f_{ir} A_{rk} A_{ik}^* + \frac{1}{2} \{ \Pi_r A_{rk} \Pi_k^* C^* + \Pi_r^* A_{rk}^* \Pi_k C \} - \frac{3}{8} \Pi_l C \Pi_l^* C^*$$

then for h, ξ fields the following is obtained:

(1.4.1 c)

$$L_{FP} = \frac{\partial A_{ik}}{\partial x_l} \frac{\partial A_{ik}^*}{\partial x_l} + e^2 \phi_l^2 A_{ik} A_{ik}^* - 2 \frac{\partial A_{rk}}{\partial x_r} \frac{\partial A_{sk}^*}{\partial x_s} - 2e^2 \phi_r \phi_s A_{rk} A_{sk}^* + \frac{1}{2} \frac{\partial A_{rk}}{\partial x_r} \frac{\partial C^*}{\partial x_k} + \frac{1}{2} e^2 \phi_r \phi_k A_{rk} C^* +$$

$$\frac{1}{2} \frac{\partial A_{rk}^*}{\partial x_r} \frac{\partial C}{\partial x_k} + \frac{1}{2} e^2 \phi_r \phi_k A_{rk}^* C - \frac{3}{8} \frac{\partial C}{\partial x_l} \frac{\partial C^*}{\partial x_l} - \frac{3}{8} e^2 \phi_l^2 C C^* +$$

$$i \left\{ e\phi_l A_{ik}^* \frac{\partial A_{ik}}{\partial x_l} - e\phi_l A_{ik} \frac{\partial A_{ik}^*}{\partial x_l} - 2e\phi_s A_{sk}^* \frac{\partial A_{rk}}{\partial x_r} + 2e\phi_r A_{rk} \frac{\partial A_{sk}^*}{\partial x_s} + A_{rk} A_{ik}^* \frac{\partial \phi_r}{\partial x_i} - A_{rk} A_{ik}^* \frac{\partial \phi_i}{\partial x_r} + \frac{1}{2} e\phi_k C^* \frac{\partial A_{rk}}{\partial x_r} - \right.$$

$$\left. \frac{1}{2} e\phi_r A_{rk} \frac{\partial C^*}{\partial x_k} - \frac{1}{2} e\phi_k C \frac{\partial A_{rk}^*}{\partial x_r} + \frac{1}{2} e\phi_r A_{rk}^* \frac{\partial C}{\partial x_k} - \frac{3}{8} e\phi_l C^* \frac{\partial C}{\partial x_l} + \frac{3}{8} e\phi_l C \frac{\partial C^*}{\partial x_l} \right\}$$

Fierz-Pauli eq. for massless spin 2 field interaction with an electromagnetic field (minimal coupling) in a form

(1.4.2 a)

$$2\Pi^2 A_{ik} - 2 \left\{ \Pi_i \Pi_s A_{sk} + \Pi_k \Pi_s A_{si} - \frac{1}{2} \delta_{ik} \Pi_r \Pi_s A_{rs} \right\} + f_{ir} A_{rk} + f_{kr} A_{ri} + \frac{1}{2} \{ \Pi_i \Pi_k + \Pi_k \Pi_i \} C - \frac{1}{4} \delta_{ik} \Pi^2 C = 0$$

$$-\frac{3}{4} \Pi^2 C + \Pi_r \Pi_s A_{rs} = 0$$

then for h , ξ fields the following is obtained:

(1.4.2 b)

$$\left\{ \begin{aligned} & -2 \left(\frac{\partial A_{ik}}{\partial x} \right)^2 + 2e^2 \phi^2 A_{ik} + 2 \frac{\partial}{\partial x_i} \frac{\partial A_{sk}}{\partial x_s} - 2e^2 \phi_i \phi_s A_{sk} + 2 \frac{\partial}{\partial x_k} \frac{\partial A_{si}}{\partial x_s} - 2e^2 \phi_k \phi_s A_{si} - \delta_{ik} \frac{\partial}{\partial x_r} \frac{\partial A_{rs}}{\partial x_s} + \delta_{ik} e^2 \phi_r \phi_s A_{rs} \\ & - \frac{1}{2} \frac{\partial}{\partial x_i} \frac{\partial C}{\partial x_k} + \frac{1}{2} e^2 \phi_i \phi_k C - \frac{1}{2} \frac{\partial}{\partial x_k} \frac{\partial C}{\partial x_i} + \frac{1}{2} e^2 \phi_k \phi_i C + \frac{1}{4} \delta_{ik} \left(\frac{\partial C}{\partial x} \right)^2 - \frac{1}{4} \delta_{ik} e^2 \phi^2 C \end{aligned} \right\}$$

$$+ i \left\{ \begin{aligned} & 4e \frac{\partial \phi}{\partial x} A_{ik} - 2e \frac{\partial \phi_s}{\partial x_i} A_{sk} - 2e \phi_i \frac{\partial A_{sk}}{\partial x_s} - 2e \frac{\partial \phi_s}{\partial x_k} A_{si} - 2e \phi_k \frac{\partial A_{si}}{\partial x_s} + \delta_{ik} e \frac{\partial \phi_s}{\partial x_r} A_{rs} + \delta_{ik} e \phi_r \frac{\partial A_{rs}}{\partial x_s} \\ & \frac{\partial \phi_r}{\partial x_i} A_{rk} - \frac{\partial \phi_i}{\partial x_r} A_{rk} + \frac{\partial \phi_r}{\partial x_k} A_{ri} - \frac{\partial \phi_k}{\partial x_r} A_{ri} + \frac{1}{2} e \frac{\partial \phi_k}{\partial x_i} C + \frac{1}{2} e \phi_i \frac{\partial C}{\partial x_k} + \frac{1}{2} e \frac{\partial \phi_i}{\partial x_k} C + \frac{1}{2} e \phi_k \frac{\partial C}{\partial x_i} - \frac{1}{2} \delta_{ik} e \frac{\partial \phi}{\partial x} C \end{aligned} \right\} = 0$$

$$\left\{ \frac{3}{4} \left(\frac{\partial C}{\partial x} \right)^2 - \frac{3}{4} e^2 \phi^2 C - \frac{\partial}{\partial x_r} \frac{\partial A_{rs}}{\partial x_s} + e^2 \phi_r \phi_s A_{rs} \right\} + i \left\{ -\frac{3}{2} e \frac{\partial \phi}{\partial x} C + e \frac{\partial \phi_s}{\partial x_r} A_{rs} + e \phi_r \frac{\partial A_{rs}}{\partial x_s} \right\} = 0$$

Adheres to the Mexican hat potential, i.e. to the case of unstable equilibrium and in reference to (0.1.1) \mapsto (0.1.2), obtain (omitted terms cubic and quartic in fields h, ζ, ϕ_i)
(using $h-\zeta$ notation to be intact with (A 2.2.2))

(1.5)

$$L = -\frac{1}{4} F_{ik} F^{ik} + \frac{1}{2} (\partial_i \zeta)^2 + \frac{1}{2} (\partial_i h + e v \phi_i)^2 - \frac{1}{2} \lambda v^2 \zeta^2 - \frac{1}{2} \lambda v \zeta (\zeta^2 + h^2) - \frac{1}{8} \lambda (\zeta^2 + h^2)^2$$

where, ^{note¹}

mass ($k_h \equiv$) $e v$ for h ^{note²} and mass ($k_\zeta \equiv$) $\sqrt{\lambda} v$ for ζ .

Therefore, a massive gravitational field with mass k_h and a massive Goldstone-dark field with mass k_ζ ^{note³} is obtained.

^{note} :

¹ coupling to a composite spin 1 field, i.e. electromagnetic and B_i , leads to an expression

for electromagnetic field

$$F_{ik} = i(\Pi_i \phi_k - \Pi_k \phi_i), \quad i\Pi_i = \frac{\partial}{\partial x_i} - iB_i \quad (\text{in force-free case than } i\Pi_i = \frac{\partial}{\partial x_i});$$

for spin 1 B_i field, the following is obtained:

$$\mathcal{G}_{ik} = i(\Pi_i B_k - \Pi_k B_i), \quad i\Pi_i = \frac{\partial}{\partial x_i} - i\phi_i;$$

$$^2 \quad h \mapsto \phi_i + \frac{1}{e v} \partial_i h \quad (\equiv z_i);$$

when Ricci theorem is applied for tensor analysis the following is obtained:

$$\phi_i + \frac{1}{e v \langle g_{ik} \rangle} \partial_i h_{ik} \quad (\equiv z_i);$$

³ the k_ζ is not related to ϕ_i , i.e., it does not contain charge e since dark field does not interact with an electromagnetic field;

k_ξ appears as a result of obtaining mass by Goldstone boson, i.e. $k_\xi = k_\zeta$.

1.2.1. Force-free eq.

Then Fierz-Pauli eq. for Ξ massive spin 0 field without interaction is

$$2k^2 A_{ik} - 2\Box A_{ik} + 2 \left\{ \frac{\partial^2 A_{sk}}{\partial x_s \partial x_i} + \frac{\partial^2 A_{si}}{\partial x_s \partial x_k} - \frac{1}{2} \delta_{ik} \frac{\partial^2 A_{rs}}{\partial x_r \partial x_s} \right\} - \frac{\partial^2 C}{\partial x_i \partial x_k} + \frac{1}{4} \delta_{ik} \Box C = 0 \quad (1.6)$$

$$-\frac{3}{2} k^2 C + \frac{3}{4} \Box C - \frac{\partial^2 A_{rk}}{\partial x_r \partial x_k} = 0$$

thus, satisfies *P 2*.

As the appearance of the spin 0 field is described by Klein-Gordon eq., then referring to the massive spin 0 field, i.e. $\Xi(x)$ in eq. (1.1 b), leads to (ref. Klein-Gordon eq.; Gravitational interaction, Action)

$$\frac{-1}{\sqrt{-g}} \partial_i \left(\langle g^{ik} \rangle \sqrt{-g} \partial_k \Xi \right) + k_{\Xi}^2 \Xi = 0 \quad (1.6.1 \text{ a})$$

therefore, dark boson acquires a mass ($k_{\Xi} \neq 0$) and is coupled with gravitational potential field $\langle g^{ik} \rangle$;

this coupling between $\langle g^{ik} \rangle$ and dark boson ($k_{\Xi} \neq 0$, so no singularity appears) is originated, as the source of the Ξ field is the stress-energy tensor for scalar field^{note}, which satisfies the Klein-Gordon eq.

$$T^{ik} = \frac{1}{k_{\Xi}} \left(\langle g^{i\alpha} \rangle \langle g^{k\beta} \rangle + \langle g^{i\beta} \rangle \langle g^{k\alpha} \rangle - \langle g^{ik} \rangle \langle g^{\alpha\beta} \rangle \right) \partial_{\alpha} \Xi^* \partial_{\beta} \Xi - \langle g^{ik} \rangle k_{\Xi} \Xi^* \Xi \quad (1.6.1 \text{ b})$$

note :

as a gradient of scalar can describe only particles of spin 0, and applying analogous to the Lorentz condition for a dark field part (as for gravitational, (V. Fierz and W. Pauli, 1939)), the following is obtained:

$$T^{ik} = -\langle g^{ik} \rangle k_{\Xi} \Xi^* \Xi \propto \langle g^{ik} \rangle$$

(as in dark energy (G. 't Hooft, 2008));

thus obeying *P 1*.

ref. to Ξ not ζ as Goldstone field ζ origin is different.

$\frac{-1}{\sqrt{-g}} \partial_i \langle g^{ik} \rangle \sqrt{-g} \partial_k \mapsto$ two-dimensional Laplacian on the vortex sheet $\tilde{x}^{\mu}(\sigma)$ ref. (M. Baker and R. Steinke, 2000); $\therefore g \rightarrow -g$.

ii. Model of masses for gravitational and dark fields (contribution of matter).

Following is a presentation of obtaining masses by gravitational and dark components of a combined gravitational-dark field as a result of the interaction with matter.

Ansatz Lagrangian ^{note¹} viz., (B. Janssen, 2006), (S. Deser, 1970)

$$L = L_{FP} + L_{\varphi} + \{k_h h_{ik} T^{ik}(\varphi) + h_{ik} T^{ik}(h)\} + \{h \leftrightarrow \zeta\} \quad (2.1)$$

where,

L_{FP} is defined by (1.2.1);

kinetic term L_{φ} for matter field φ acts as a mass term ^{note²}

$$L_{\varphi} = \frac{1}{2} \partial_i \varphi^* \partial^i \varphi \quad (2.2)$$

(ref. 4.4 Problems; (M. Kachelrieß, 2010)

$h_{ik} T^{ik}(\varphi)$ term represents the massive spin 2 field h_{ik} , which couples with $T^{ik}(\varphi)$ like spin 2 boson, and DVZ discontinuity disappears in a covariant case ^{note³}, i.e. in the limit $k_{h,\Xi} \rightarrow 0$ obtains a spin 2 boson and a scalar dark boson, which couples with the stress-energy tensor(matter); as the stress-energy tensor is defined in a form

$$T^{ik}(\varphi) = -\partial^i \varphi \partial^k \varphi + \frac{1}{2} \eta^{ik} (\partial \varphi)^2 \quad (2.3)$$

^{note} :

¹ term $\{h \leftrightarrow \zeta\}$ corresponds to $\{...\}$ for h_{ik} with substitution by ζ ; for ζ part

$$t_{ik} = g_{ik} \underbrace{-\varepsilon \zeta}$$

$$\varepsilon \Xi \langle g_{ik} \rangle$$

$$\left(k_{\Xi} \Xi \langle g_{ik} \rangle T^{ik}(\varphi) + \Xi \langle g^{ik} \rangle T_{ik}(\Xi) \right)$$

where, $T_{ik}(\Xi)$ denoted by (1.6.1 b);

² $m^2 = (\partial \varphi)^2$ - mass due to the contribution of the matter;

³ within the outlined mechanism, the disappearance of DVZ discontinuity is determined by the fact, that in 3D finite-mass relativistic bosons, characterized by BE condensation transition of the third order. For bosons of mass $O(10^{-32})$ eV, the condensation transition is indistinguishable from the second order related to massless relativistic bosons (F. Zwicky, 1961; S. Fujita, T. Kimura and Y.Zheng, 1991).

where,

in Minkovski space linear perturbation $t_{ik} = g_{ik} - \varepsilon h_{ik}$

ε - expansion parameter,

allows for vacuum metric $t_{ik} = \langle g_{ik} \rangle$; (B. Altschul, Q. G. Bailey and A. Kosteleyky, 2009)

$$\sqrt{g} = \exp \left[\frac{1}{2} Tr \log (t_{ik} + \varepsilon h_{ik}) \right] = t_{ii} + \frac{1}{2} \varepsilon h_{ii}; \{h \leftrightarrow \zeta\}$$

$k = M_p^{-1}$ - coupling strength to the source T_{ik} (M_p - Planck mass).

Consider ^{note¹}

$$h_{ik} T^{ik}(\varphi) = -h_{ik} g_{\varphi}^{ik} + \frac{1}{2} h_{ik} g^{ik} (\partial\varphi)^2 - \frac{1}{2} \varepsilon h^2 (\partial\varphi)^2 \quad (2.4)$$

as a kinetic term of φ , which acts as a mass term for h_{ik} proportional to h^2 ^{note²}.

For $h-h$ field coupling is described by the term $h_{ik} T_{ik}(h)$

$$h_{ik} T_{ik}(h) = -h_{ik} \left(-\frac{1}{2} \partial_i h_{\rho\lambda} \partial_k h^{\rho\lambda} + \partial_i h_{\rho\lambda} \partial^\rho h_k^\lambda - \frac{1}{2} \partial_i h \partial^\rho h_{k\rho} - \frac{1}{2} \partial^\rho h \partial_i h_{k\rho} + \frac{1}{2} \partial_i h \partial^i h + t_{ik} L_{FP} \right) \quad (2.5)$$

where,

$T_{ik}(h)$ -gravitational energy-momentum (stress-energy) tensor.

^{note} :

¹ the outlined mechanism does not contradict the Coleman-Mandula theorem (S. Coleman and J. Mandula, 1967), as consistency is preserved due to the fact that the gravitational-dark field contains only one spin 2 field (gravitational) and one spin 0 (dark) field;

² term linear in h_{ik} is removed:

$$g_{\varphi}^{ik} - \frac{1}{2} g_{ik} (\partial\varphi)^2 = 0 \quad (g_{ik} = g^{ik} - \text{Minkowski metric})$$

where,

metric tensor is generated by matter (G. 't Hooft, 2008)

$$g_{\varphi}^{ik} = \partial_i \varphi \partial_k \varphi;$$

and eq. (2.5) takes into account nonlinear effects.

Eq. (2.5) also takes into consideration massive (Fodor, Forgács and Grandclément, 2014) and massless or small-mass (Rosen, 2010) self-interacting real scalar fields.

Diffeomorphism invariance is restored from the breaking state due to the contribution of the last term in (2.5). Structurally, this term incorporates local field fluctuations and the restoring path (ref. the essence of the mechanism, Chapter 1), both of which are attributed to the appearance of scalar field in eq. (1.2.1).

Local field fluctuations can point on the presence of Vainshtein-like behavior (A.I. Vainshtein, 1972) within the scope of the presented mechanism. As far as the restoring path is concerned, the appearance of negative energy states associated with the existence of dark boson, ref. eq. (3.6 a) can explain the appearance of ghost-like mode (D. G. Boulware and S. Deser, 1972) in nonlinear Fierz –Pauli theory.

Within the scope of the outlined mechanism, a coupling (tensor- gravitational, ref. Chapter III, paragraph 3, item 3.2, sub-item 1) regime and a decoupling (gravitational, ref. Chapter III, paragraph 3, item 3.2, sub-item 2) regime can correspondently explain the disappearance (for example, dRGT and bigravity) and the reappearance (for example, bigravity with doubly coupled matter) of ghost-like behavior ^{note} in different modifications and extensions of massive gravity.

note:

Massive gravity theory with all its modifications and extensions is not considered within the scope of the presented approach, since it is not relevant to the presented mechanism.

1.2.2. Model of boson masses.

Introduction of interactions: gravitational –dark - spin 1 field interaction.

Assume the interaction of a massive gravitational – dark field with a massless spin 1 field (i.e. vector field B_k):

$$i\Pi_k = \frac{\partial}{\partial x_k} - iB_k \quad (2.6.0)$$

$$f_{ik} = \Pi_i \Pi_k - \Pi_k \Pi_i = i \left\{ \frac{\partial B_k}{\partial x_i} - \frac{\partial B_i}{\partial x_k} \right\}$$

massless B_k coupling with massive (h_{ik}, ζ) , viz. FP. Lagrangian in a form

$$(2.6.1 a)$$

$$L_{FP} = k^2 A_{ik}^* A_{ik} + \Pi_l A_{ik} \Pi_l^* A_{ik}^* - 2\Pi_r A_{rk} \Pi_s^* A_{sk}^* + f_{ir} A_{rk} A_{ik}^* + \frac{1}{2} \left\{ \Pi_r A_{rk} \Pi_k^* C^* + \Pi_r^* A_{rk}^* \Pi_k C \right\} - \frac{3}{4} k^2 C^* C - \frac{3}{8} \Pi_l C \Pi_l^* C^*$$

i.e. spin 1 field acquires mass as a result of the interaction with massive spin 2 and spin 0 fields;

mixed $h_{ik} - \zeta$ terms also account for self interaction;

for h, ζ, B fields, the following is obtained:

$$(2.6.1 b)$$

$$L_{FP} =$$

$$\left\{ k^2 A_{ik}^* A_{ik} + \frac{\partial A_{ik}}{\partial x_l} \frac{\partial A_{ik}^*}{\partial x_l} + B_l B_l^* A_{ik} A_{ik}^* - 2 \frac{\partial A_{rk}}{\partial x_r} \frac{\partial A_{sk}^*}{\partial x_s} - 2 B_r B_s^* A_{rk} A_{sk}^* + \frac{1}{2} \frac{\partial A_{rk}}{\partial x_r} \frac{\partial C^*}{\partial x_k} \right. \\ \left. + \frac{1}{2} B_r B_k^* A_{rk} C^* + \frac{1}{2} \frac{\partial A_{rk}^*}{\partial x_r} \frac{\partial C}{\partial x_k} + \frac{1}{2} B_r^* B_k A_{rk} C - \frac{3}{4} k^2 C^* C - \frac{3}{8} \frac{\partial C}{\partial x_l} \frac{\partial C^*}{\partial x_l} - \frac{3}{8} B_l B_l^* C C^* \right\}$$

$$+ i \left\{ \frac{\partial A_{ik}}{\partial x_l} A_{ik}^* B_l^* - A_{ik} \frac{\partial A_{ik}^*}{\partial x_l} B_l - 2 \frac{\partial A_{rk}}{\partial x_r} A_{sk}^* B_s^* + 2 A_{rk} \frac{\partial A_{sk}^*}{\partial x_s} B_r + \frac{\partial B_r}{\partial x_i} A_{rk} A_{ik}^* - \frac{\partial B_i}{\partial x_r} A_{rk} A_{ik}^* \right. \\ \left. + \frac{1}{2} \frac{\partial A_{rk}}{\partial x_r} B_k^* C^* - \frac{1}{2} B_r A_{rk} \frac{\partial C^*}{\partial x_k} - \frac{1}{2} \frac{\partial A_{rk}^*}{\partial x_r} B_k C + \frac{1}{2} \frac{\partial C}{\partial x_k} B_r^* A_{rk}^* - \frac{3}{8} \frac{\partial C}{\partial x_l} B_l^* C^* + \frac{3}{8} \frac{\partial C^*}{\partial x_l} B_l C \right\}$$

➤ as a vector field mass term in Lagrangian is proportional to $B_l B_l^*$;

then consider^{note}

(2.6.2 a)

$$2k^2 A_{ik} + 2\Pi^2 A_{ik} - 2 \left\{ \Pi_i \Pi_s A_{sk} + \Pi_k \Pi_s A_{si} - \frac{1}{2} \delta_{ik} \Pi_r \Pi_s A_{rs} \right\} + f_{ir} A_{rk} + f_{kr} A_{ri} + \frac{1}{2} \{ \Pi_i \Pi_k + \Pi_k \Pi_i \} C - \frac{1}{4} \delta_{ik} \Pi^2 C = 0$$

$$-\frac{3}{2} k C - \frac{3}{4} \Pi^2 C + \Pi_r \Pi_s A_{rs} = 0$$

which represents the Fierz-Pauli eq. for massive spin 2 and spin 0 fields with the interaction;

for h, ζ, B fields, the following is obtained:

(2.6.2 b)

$$\left\{ \begin{aligned} & 2k^2 A_{ik} - 2 \left(\frac{\partial A_{ik}}{\partial x} \right)^2 + B^2 A_{ik} + 2 \frac{\partial}{\partial x_i} \frac{\partial A_{sk}}{\partial x_s} - 2 B_i B_s A_{sk} + 2 \frac{\partial}{\partial x_k} \frac{\partial A_{si}}{\partial x_s} - 2 B_k B_s A_{si} - \delta_{ik} \frac{\partial}{\partial x_r} \frac{\partial A_{rs}}{\partial x_s} \\ & + \delta_{ik} B_r B_s A_{rs} - \frac{1}{2} \frac{\partial}{\partial x_i} \frac{\partial C}{\partial x_k} + \frac{1}{2} B_i B_k C - \frac{1}{2} \frac{\partial}{\partial x_k} \frac{\partial C}{\partial x_i} + \frac{1}{2} B_k B_i C + \frac{1}{4} \delta_{ik} \left(\frac{\partial C}{\partial x} \right)^2 - \frac{1}{4} \delta_{ik} B^2 C \end{aligned} \right\} +$$

$$i \left\{ \begin{aligned} & 4 \frac{\partial B}{\partial x} A_{ik} - 2 \frac{\partial B_s}{\partial x_i} A_{sk} - 2 B_i \frac{\partial A_{sk}}{\partial x_s} - 2 \frac{\partial B_s}{\partial x_k} A_{si} - 2 B_k \frac{\partial A_{si}}{\partial x_s} + \delta_{ik} \frac{\partial B_s}{\partial x_r} A_{rs} + \delta_{ik} B_r \frac{\partial A_{rs}}{\partial x_s} + \frac{\partial B_r}{\partial x_i} A_{rk} \\ & - \frac{\partial B_i}{\partial x_r} A_{rk} + \frac{\partial B_r}{\partial x_k} A_{ri} - \frac{\partial B_k}{\partial x_r} A_{ri} + \frac{1}{2} \frac{\partial B_k}{\partial x_i} C + \frac{1}{2} B_i \frac{\partial C}{\partial x_k} + \frac{1}{2} \frac{\partial B_i}{\partial x_k} C + \frac{1}{2} B_k \frac{\partial C}{\partial x_i} - \frac{1}{2} \delta_{ik} \frac{\partial B}{\partial x} \end{aligned} \right\} = 0$$

$$\left\{ -\frac{3}{2} k C + \frac{3}{4} \left(\frac{\partial C}{\partial x} \right)^2 - \frac{3}{4} B^2 C - \frac{\partial}{\partial x_r} \frac{\partial A_{rs}}{\partial x_s} + B_r B_s A_{rs} \right\} + i \left\{ -\frac{3}{2} \frac{\partial B}{\partial x} C + \frac{\partial B_s}{\partial x_r} A_{rs} + B_r \frac{\partial A_{rs}}{\partial x_s} \right\} = 0$$

^{note} :

eq. for massive spin-1 field (by virtue of interaction) in contrary to free vector boson field, compare Proca eq.

2. Symmetry breaking mechanism (G-type).

Following is a schematic representation of the symmetry breaking mechanism for participating gauge fields (with corresponding Lagrangians specified in: ^{note} eq. (0.1.1, 2)).

As electromagnetic field ϕ_i is represented by U(1) group

$$\phi = (\phi)$$

and for a gravitational-dark field $\eta(x)$

$$\Phi' = (\eta)$$

after modification of the field, the following is obtained:

$$\nu: \phi \rightarrow \Phi'$$

where,

$$: \phi \mapsto \nu(\eta, \phi) \phi = \eta;$$

represents spontaneous symmetry breaking as a symmetric system (gravitational – dark) goes into a vacuum state as a result of an interaction with an electromagnetic field:

$$\Phi' = \nu(\eta, \phi) \phi$$

the following is obtained:

$$\nu(\eta, \phi) = \Phi' \phi^{-1}$$

where,

$$\Phi = \begin{pmatrix} \eta \\ \nu + \xi \end{pmatrix} = \langle \Phi \rangle + \Phi'$$

and a fluctuating real value field with $\langle \xi(x) \rangle = 0$;
vacuum expectation value

$$\langle \Phi \rangle = \begin{pmatrix} 0 \\ \nu \end{pmatrix} \tag{2.7}$$

3. Quantization.

Consider the noted in (A 2.1):

- i.** Following standard approach (F. Mandl and G. Shaw, 2010; R. Durka, 2008; Ivo van Vulpen, 2014) in application to the real scalar fields $contr(A_{ik})$, C for $(\phi_i = 0)$ and the complex scalar field C for $(\phi_i \neq 0)$.
- ii.** By referring to the gravitational field A_{ik} for $(\phi_i \neq 0)$.

Therefore, as item **i**) is well defined, refer to item **ii**).

3.1. Gravitational field.

1. The regular, unphysical spacetime (M, g_{ik}) address to the case $(\phi_i \neq 0)$ in Minkovski space.

Minkowski space $\mathbb{R}^{n-1,1}$ with the flat Minkowski metric is the model of the Lorentzian manifold.

A Lorentzian manifold is a special case of a pseudo-Riemannian manifold in which the signature of the metric is $(n-1, 1)$; such metrics are called Lorentzian metrics.

So $\langle g_{ik} \rangle$ is the Lorentz metric on manifold M .

The singular, physical spacetime $(\tilde{M}, \tilde{g}_{ik})$ related to (M, g_{ik}) by function Ω is defined on M ($M \supset \tilde{M}$), such that:

$$\langle \tilde{g}_{ik} \rangle = \Omega^2 \langle g_{ik} \rangle \quad , \quad \Omega > 0 \quad (3.1)$$

$$\Omega \rightarrow 0 \quad \text{on} \quad \Sigma$$

where, Σ is a smooth spacelike hypersurface in M , called the singularity surface (Anguige and K.P. Tod, 2008), (ref. hypersurface).

2. In gauge theory, curvature (scalar quantity) represents a field, i.e.:

in case $(\phi_i \neq 0)$, it can be associated with the gravitational field, thus pointing to the known association between curvature and gravity;

in case $(\phi_i = 0)$, the existence of Weyl curvature for flat manifold determines the dark field Ξ component (\exists for $\phi_i = 0$) of η^{note} , which by virtue of $P I$ defines the value of dark energy.

note:

in case $(\phi_i = 0)$, derives a flat-space spin-2 theory, i.e. for tensor-gravitational field.

3. The manifested approach to the quantization of gravitational field 3.ii is reduced to the consideration 3.i.

Eq. for A_{ik} (A 2.1, Viz.) in unphysical spacetime (M, g_{ik}) , in case $(\phi_i \neq 0)$, take form:

$$A_{ik} = ih_{ik}$$

then in physical spacetime $(\tilde{M}, \tilde{g}_{ik})$, obtain ref. eq. (3.1):

$$A_{ik} = i \frac{1}{\Omega^2} h_{ik} \quad (3.2)$$

where, $M \supset \tilde{M}$;

according to § 3.1,1-2 $\Omega \rightarrow 0$ for Σ in (M, g_{ik}) , thus singularity can exist only in physical spacetime $(\tilde{M}, \tilde{g}_{ik})$ viz. A_{ik} not divergent.

•• (A 2.1, 1.2.1), eq. (3.2) defined ^{note} :

$$(ih = \Psi_4 \Rightarrow h = i\Psi_4^* \mapsto h_{ik} = i \langle g_{ik} \rangle \Psi_4^*)$$

$$A_{ik} = -\frac{1}{\Omega^2} \langle \tilde{g}_{ik} \rangle \Psi_4^* \quad (3.3 a)$$

where, Ψ_4 is the Weyl complex scalar.

From (3.3 a) using def. for Ψ_4 , obtain:

$$A_{ik} = \frac{1}{\Omega^2} \langle \tilde{g}_{ik} \rangle (\ddot{h}_+ + i\ddot{h}_x) \quad (3.3 b)$$

where, indexes and dots correspondently denote polarizations and time-differentiation of gravitational field.

By virtue of the Klein-Gordon eq. time-differentiation can be addressed as follows

$$((-i\nabla)^2 + k_h^2)h_{+,x} = i^2 \partial_t^2 h_{+,x} \quad (3.3.1)$$

note:

thus, instead of referring to 3.ii in form (A 2.1), it is reduced to the form (3.3 a) in case $(\phi_i \neq 0)$, which is falls under the case 3.i.

then, obtain ^{note}

$$A_{ik} = -\frac{1}{\Omega^2} \langle \tilde{g}_{ik} \rangle ((-i\nabla)^2 + k_h^2) (h_+ + ih_x) \quad (3.4)$$

and apply def. of Laplacian on an arbitrary curved manifold (ref. Laplacian)

$$\nabla^2 h_{+,x} = \langle \tilde{g}^{ik} \rangle \frac{\partial^2 h_{+,x}}{\partial x^i \partial x^k} - \Gamma^i \frac{\partial h_{+,x}}{\partial x^i} \quad (3.4.1)$$

where, Γ_{kj}^i is Christoffel symbol of the first kind ('potentials')

eq. (3.4) takes the form

(3.5)

$$A_{ik} = \frac{1}{\Omega^2} \left(\frac{\partial^2 h_+}{\partial x^i \partial x^k} - \langle \tilde{g}_{ik} \rangle \Gamma^i \frac{\partial h_+}{\partial x^i} + i \frac{\partial^2 h_x}{\partial x^i \partial x^k} - i \langle \tilde{g}_{ik} \rangle \Gamma^i \frac{\partial h_x}{\partial x^i} - \langle \tilde{g}_{ik} \rangle k_h^2 h_+ - i \langle \tilde{g}_{ik} \rangle k_h^2 h_x \right)$$

according to note (ref. eq. (3.3 a)).

note:

¹ in a general case Lorentz gauge can not be used:

$$(-i\nabla)h_{+,x} = 0$$

as spacetime is singular ($\tilde{M}, \tilde{g}_{ik}$) and curved (\exists Weyl curvature on: M, \tilde{M} for $\phi_i = 0$; $\phi_i \neq 0$);

in case $\phi_i \neq 0$ omit metric fluctuation in Minkovski space;

² (case $\phi_i \neq 0$, in expanded form (eq. (3.5)):

due to singularity mass k_h^2 and 'potentials' Γ_{kj}^i renormalized by $\langle \tilde{g}_{ik} \rangle$ (\tilde{g}_{ik} in general case, i.e. including metric fluctuations);

$\propto \Gamma_{kj}^i$ term is associated with the fact that the gravitational field determines the dark field appearance, as the source of the dark field is the stress-energy tensor (ref. a gradient of scalar; note eq. (1.6.1 b));

source-free equation terms include a metric and not a time part (in correspondence with

^{note} ref. eq. (A 2.1.1)).

3.2. Tensor fields.

1. Tensor-gravitational representation.

Consider tensor-gravitational field h (eq. (3.4)), which satisfies the time-independent Klein-Gordon eq. (ref. Klein-Gordon eq.) , using complex ('charged' -- Ξ mass) scalar field representation:

$$h(x) = \int \frac{d^3 p}{(2\pi)^3 2E_p} \left[a(p) e^{-ipx} + b^+(p) e^{+ipx} \right] \quad (3.6 \text{ a})$$

where,

$$E_p = \sqrt{p^2 + k_\Xi^2}.$$

The first term (denote particle with $k_h > 0$) annihilates a particle with positive energy \mapsto graviton (tensor-gravitational mode).

The second term (denote antiparticle with $k_\Xi < 0$); and creates an antiparticle with negative energy \mapsto dark boson.

Scalar propagator defined ^{note}

$$\Delta_F(p) = \frac{1}{p^2 - k_\Xi^2 + i\epsilon}$$

(Note the scalar field: the propagator for the complex field is the same as for the real field).

2. Gravitational representation.

Addressed from h gravitational field h_{ik} (ref. (A 2.1)), correspondently obtain (M. Kachelrieß, 2010)

$$h_{ik}(x) = \sum_r \int \frac{d^3 p}{(2\pi)^3 2E_p} \left[a_r(p) \varepsilon_{ik}^r e^{-ipx} + b_r^+(p) \varepsilon_{ik}^{r*} e^{+ipx} \right] \quad (3.6 \text{ b})$$

where,

tensor fields of rank n corresponds to particles with spin $s = n$;
polarization tensor ε^r (polarization states ε_{ik}^r).

note:

•• consider (3.6 a) as corresponding to scalar mode, where tensor rank 2 mode disappears; scalar mode appears;

•• consider (3.6 b) represents tensor mode, where rank 2 mode appears from a scalar mode (ref. graviton propagator, which is defined by scalar propagator), not from a tensor rank 2 mode.

Propagator for spin $s = 2$ field is derived as a sum over polarization states ε_{ik}^r times scalar propagator

$$D_F^{ik\rho\sigma}(p) = \sum_r \varepsilon_r^{ik}(p) \varepsilon_r^{*\rho\sigma}(p) \Delta_F(p)$$

defined by metric fluctuations (correspond to case $\phi_i = 0$) in 't Hooft gauge (M. Kachelrieß, 2010)

$$D_F^{ik\rho\sigma}(p) = \frac{\frac{1}{2} \left(-\langle g \rangle_{ik} \langle g \rangle_{\rho\sigma} + \langle g \rangle_{i\rho} \langle g \rangle_{k\sigma} + \langle g \rangle_{i\sigma} \langle g \rangle_{k\rho} \right)}{p^2 + i\varepsilon} \quad (3.7 \text{ a})$$

in case of $\phi_i \neq 0$

$$D_F^{ik\rho\sigma}(p) = \frac{\frac{1}{2} \left(-\frac{2}{3} \langle g \rangle_{ik} \langle g \rangle_{\rho\sigma} + \langle g \rangle_{i\rho} \langle g \rangle_{k\sigma} + \langle g \rangle_{i\sigma} \langle g \rangle_{k\rho} \right)}{p^2 - k_h^2 + i\varepsilon} \quad (3.7 \text{ b})$$

(Note the factor of $\frac{1}{3}$ instead of $\frac{1}{2}$ in the last term of the propagator. This is related to the DVZ discontinuity (ref paragraph 1.2, **ii**), i.e. massless gravity differs from the $k_h \rightarrow 0$ limit of massive gravity (J. Thaler, 2003); ref. gravitons of mass $O(10^{-32})$ eV).

Thus ^{note¹} operators in eq. (3.6 a) - (3.6 b) denote:

2.1. First term with a positive mass means positive curvature and denotes graviton in tensor-gravitational ^{note²} and gravitational representations correspondently; ref. positive curvature hypersphere (3D spherical surface);

2.2. Second term in eq. (3.6 a) - (3.6 b) with negative mass means negative curvature and denotes dark boson and dark boson in form $\langle \tilde{g}_{ik} \rangle$ coupled with dark field Ξ correspondently; ref. negative curvature hypersaddle.

^{note:}

¹ applied Lorentz gauge, i.e. consider Lorentzian manifold (\exists Weyl curvature);

² case $\phi_i \neq 0$, due to factor $\langle \tilde{g}_{ik} \rangle$ in eq. (3.5) obtain:

\therefore (3.6 a);

tensor-gravitational representation is defined by:

renormalized by $\langle \tilde{g}_{ik} \rangle$ tensor- gravitational form to denote gravitational field h_{ik} .

Causality: ref. 3.1.2 and (1.1 b) tensor- gravitational mode shifted.

3. Following this, consider two possible types of curvatures, which can exist in reference to Σ (in case $\phi_i \neq 0$):

3.1.

Euclidian manifold:

$\phi_i = \phi_i^0$ corresponds to changing metric tensor from $\langle g^{ik} \rangle$ to $\langle g_{ik} \rangle$, i.e. $\langle g^{ik} \rangle = \langle g_{ik} \rangle$ (Cartesian tensor).

FLRW metric, $k = 0$.

Lorentzian manifold:

FLRW metric, $k = 1$.

$\phi_i > \phi_i^0$, then $\langle g_{ik} \rangle + o_{ik}$ hypersphere : defines (A 2.1.1); tensor mode.

FLRW metric, $k = -1$ (3-dim pseudo-sphere).

$\phi_i < \phi_i^0$, then $\langle g^{ik} \rangle + o^{ik}$ hypersaddle: defines (1.1 a); scalar mode.

3.2.

$\phi_i = 0$ obtain case 1.1 ref. (A 2.1);

$\phi_i \gg \phi_i^0$ obtain case 2.1 ref. (A 2.1).

This outlines the case of changing geometry of spacetime.

4. The whole topological structure looks like the following compound:

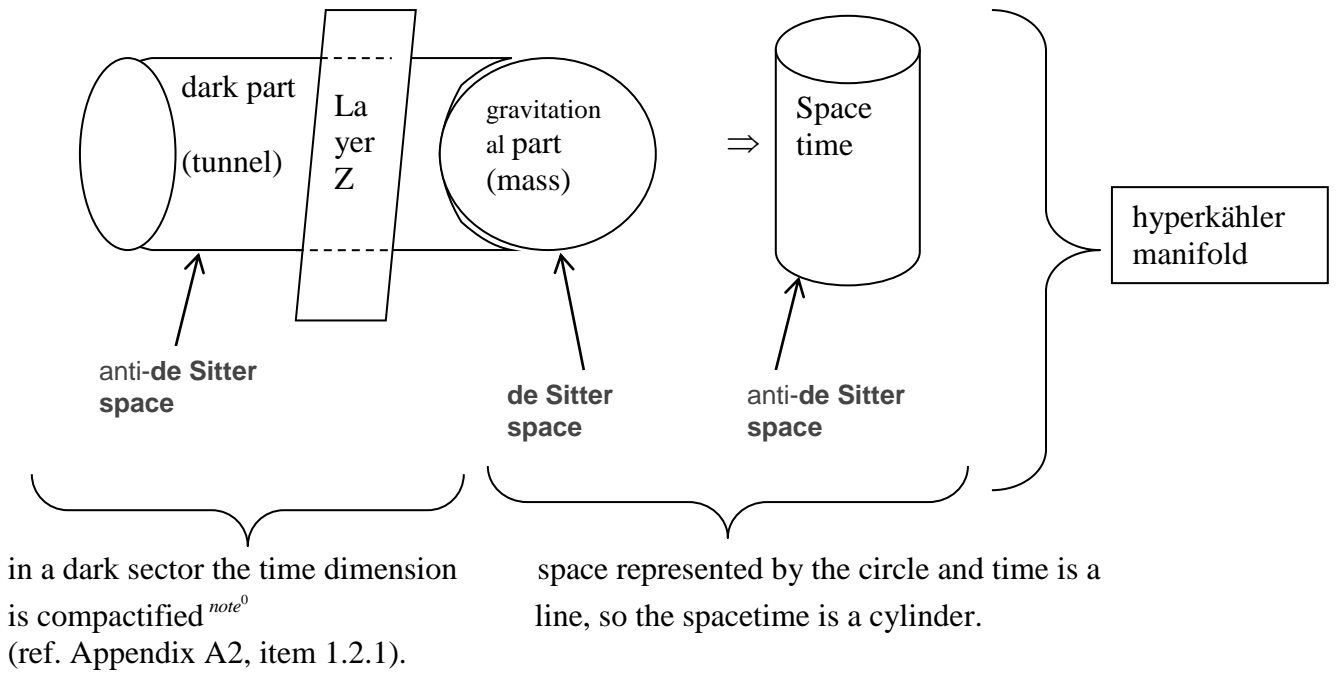

Fig.1 Fiber bundle (fiber- dark part, base- gravitational part) hypersaddle represent dark part and hypersphere gravitational part.

This geometry corresponds to AdS_3 (Lorentzian analogue to hyperbolic space) geometry on the dark part and Lorentzian CFT on the gravitational part (cases for Euclidean ^{note¹} CFT and Lorentzian CFT, ref. 3, 3.1); the shape of the fiber bundle at every point is described by the Gauss-Bonnet theorem, which addresses the geometric classification of surfaces(paragraph 3, item 3.2, sub-item 3) according to the uniformization theorem.

\wedge where ^{note²},

a) Gravitational part $SO(3)$ group is isomorphic (ref. Spin(3)) to $SU(2)$; the conformal group is isomorphic to the restricted Lorentz group $SO^+(1,3)$, which preserves direction of time, thus addressing to the arrow of time problem.

note:

⁰ This explains the introduction of ‘cylinder condition’ in Kaluza-Klein theory. Also electric and magnetic parts of the Weyl tensor are compactified (G. ‘t Hooft,, 2008), (G. ‘t Hooft, 1990) ref.(A 2.1 b).

¹ Euclidean space is an analogue to Minkovski space;

² thus to tie the definition to the Lorenz group, i.e. one-particle states (address to the reservations on applicability of FP theory by (S. Weinberg, 1965); charged fields can not be observable, as they are not invariant under gauge transformations (A.S. Fulling, 1973).

Gravitational part due to the Weyl anomaly (\exists Weyl curvature, ref. Fig. 6) characterized by the central charge ($--h$ mass) \mathbb{C} , thus corresponding Hilbert space of states is defined by Virasoro algebra for \mathbb{C} :

1. $\mathbb{C} = 0$ conformal symmetry is unbroken and corresponds to the case **1.1**;
2. $\mathbb{C} \neq 0$ conformal symmetry is spontaneously broken, i.e. case **1.2**.

In case 2, the dark field does not interact with the electromagnetic field due to the fact that \exists conformal anomaly leads to the following: trace of electromagnetic stress-energy tensor has non-vanishing expectation value. In turn, for this to be true, the trace of electromagnetic stress-energy tensor must $\neq 0$, which contradict to algebraic property of electromagnetic stress-energy tensor, which is traceless.

\succ Massive scalar (dark) field from case 1 can not interact with electromagnetic field in case 2.

b) Dark part represents the connected helicoids with two ends, each in separate points in spacetime. This corresponds^{note¹} to the Piccei-Quinn symmetry.

4.1 .*. Tunnel and topological defects.

1. Spontaneous broken symmetry addresses to the formation of cosmic strings inside and textures along the helicoids;

Breaking the Piccei-Quinn symmetry^{note²} in the tunnel resulted in \exists of axion, which is described by:

a) eq. (1.3 a) (G-type symmetry is not broken, i.e. addressed to the aforementioned symmetry breaking mechanism);

b) coupling to the instanton field (the ‘misalignment mechanism’) correlated with the presence of the Bose-Einstein condensate; ref. Fig. 6.

c) A cosmic string emits radiation:
gravitational as part of the inference topology;
electromagnetic as part of the ‘mixed’ state (also note 2).

↖ Axions as part of breaking the Piccei-Quinn symmetry. The dark boson combines with an axion to form a complex scalar field (A 2.1.2).

note:

¹ the tunnel is characterized by \exists of U(1) global symmetry (due to the absence of dark-electromagnetic field interaction);

² in the tunnel part, PQ symmetry is considered as an additional component of U(1) global symmetry, which relates to the charged complex scalar field (the field is charged due to the mass of dark field (Ξ) ref. eq. (1.3 b)); PQ symmetry is spontaneously broken by the expectation value of vacuum state, which leads (in case of non-interaction (1.3 a)) to the appearance of massless Goldstone boson. In case of interaction, gauge symmetry is broken^[2,2] and as a result the dark boson combines with an axion to form a complex scalar field (A 2.1.2).

^{2,2} ref. to the appearance of the mass of dark boson (i.e., no massless Goldstone boson appears in this case).

2. This inference topology ^{note¹} (ref. 4 **ii-iii**, below) can enclose any object, which leads to:

2.1. Zero-inference topology \mapsto field transverses through the tunnel, as massless (forces long-range); gravitational part exists, as massless.

2.2. Before symmetry breaking inference topology \mapsto tunnel shrinks, as dark part becomes massive (forces are reduced to short-range), negative mass is transferred to the objects enclosed by the tunnel; gravitational part exists, as massless.

2.3. After symmetry breaking inference topology \mapsto tunnel is not changed from the previous state; gravitational part exists as massive, thus transferring positive mass to the enclosed object.

5. Vacuum structure in the tunnel.

a) If considering layer Z with thickness $L \ll \lambda$ of a smooth vector field ϕ_i inside, in the physical vacuum the process of creation of electron-(positron, hole) ^{note²} pair is defined by the process of absorption or emission of vector field ϕ_i (λ -wavelength).

According to eq. (A 4.2) this is described by entropy in layer Z , therefore, changing entropy in Z can be associated with vacuum fluctuations in Z .

b) In the application to the electromagnetic field, detailed calculations are outlined in Appendix A - Additions Chapter represents the structure of modes and radiation from layer Z . As seen from eq.(26), modes are characterized by strongly marked peaks of radiation, therefore, if the right side fiber bundle is attached to the left side fiber bundle (Fig.1), it will obtain surfaces of revolution, where:

1. Max kink will correspond to the superposition of maximum radiation from the right-left fiber bundle connection;
2. Min radiation will correspond to the superposition of minimum radiation from right-left fiber bundle connection.

The surfaces of revolution (obtained due to consideration of smooth vector field ϕ_i structure of radiation (ref. eq.(26)) represent a universal cover, which defines the structure of compact-3 manifold (eq. (A 4.2)).

note:

¹ ‘inference topology’ radiation dynamics that corresponds to the solution of the Navier-Stokes eq. (A 5.0.1) in blow-up regime (J.Eggers and M.A. Fontelos, 2015; part I) (when \exists tensor-graviton) leads to the schema (N.H. Katz and N. Pavlovic, 2004; Y. Habara, Y. Nagatani, H.B. Nielsen and M. Ninomiya, 2007), where energy flow is const at the reduction of volume, due to the existence of 3D steady-state vortex (J.Eggers and M.A. Fontelos, 2015; part III) solution along the helicoids from within the tunnel;

² state of this pair is ‘mixed’, which corresponds to ref. (note, eq. (1.1 b)), described by density matrix ref. (Appendix A - Additions Chapter, eq. (16)); also ref. Appendix A4.

This description is referred to the Dirac hole-theory. The applicability of this theory for bosonic systems is specified in (N.H. Katz and N. Pavlovic, 2004; Y. Habara, Y. Nagatani, H.B. Nielsen and M. Ninomiya, 2007).

end_of_note

CHAPTER IV: RESULTS AND DISCUSSION

i. Considered here is the new bosonic mechanism for describing the obtaining of masses by bosons. This mechanism is constructed upon a model of spontaneous breaking of local symmetry (applies only in the context of the essence of the mechanism, Chapter I) and the hypothesis that the dark energy is represented as energy of a dark field in a single gravitational-dark field.

ii. The model describes massive gravitational and dark fields and their interaction with the vector field based on the Fierz-Pauli approach.

iii. Gauge bosons acquire masses ^{note} as a result of the interaction with a massive combined gravitational- dark field.

iv. Fermion masses are not considered in this paper. However, it is described how fermions obtain mass as a consequence of application of mass-generation mechanism of the noted theory to fermions.

v. Physical interpretation of terms proportional to $B_l B_l^*$ (ref. description in Appendix A5, paragraph 4, eq. (2.6.1 b)).

The following is an explanation of the physical meaning of the terms of eq. (2.6.1 b):

a) in the ‘mixed’ state the representation (gravitational-dark field (A 2.1.1)- (A 2.1.2)) is reduced to case characterized by scalar mode. This corresponds to the Higgs model:

➤ gauge vector boson mass term is determined by $-\frac{3}{8} B_l B_l^* C C^*$ (ref. eq. (2.6.1 b)), where C is in the form of eq. (A 2.1.2); $-\frac{3}{4} k^2 C^* C$ is the corresponding free-field term;

NB:

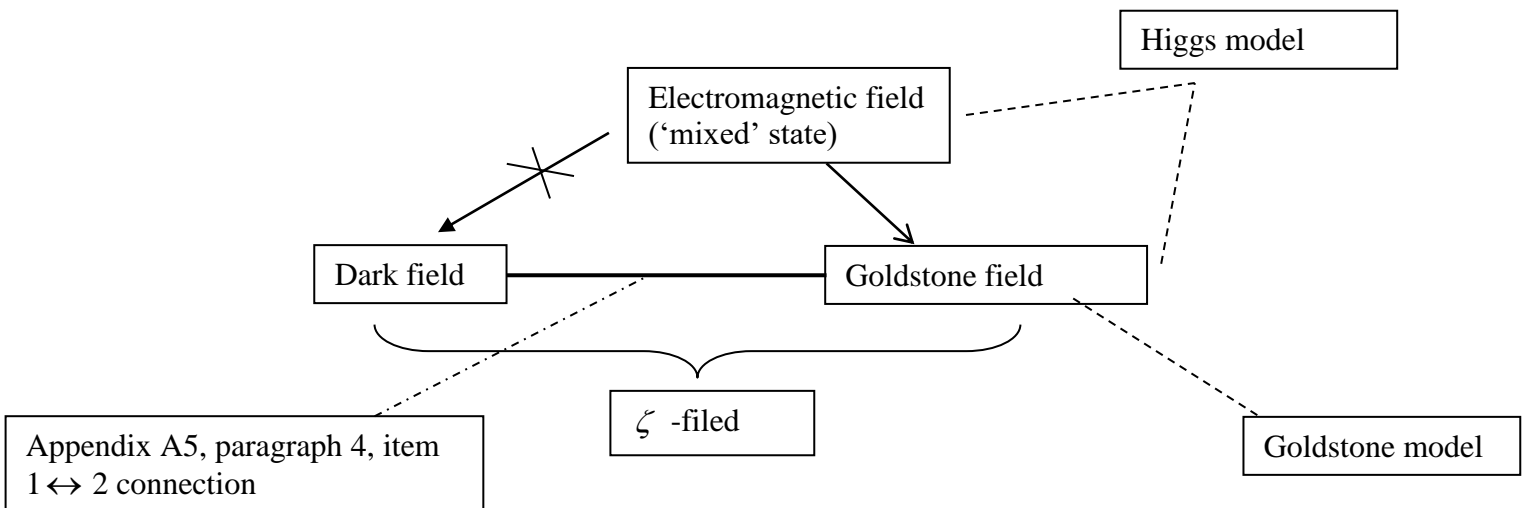

Fig. 1.1 Correspondence to Higgs mechanism (theory framework).

NB:

In the case v.a), the mass channel is driven by Goldstone boson (i.e., $\sim CC^*$ term). Obtaining mass by vector gauge boson is due to coupling between vector gauge boson and scalar mode and is described by schema (ref. Appendix A5, paragraph 4).

$\prec B_l B_l^* A_{ik} A_{ik}^*, k^2 A_{ik}^* A_{ik}$ terms are due to contribution of dark sector, which is not included into Goldstone-Higgs model and reduced to scalar mode. Scalar mode mass range is characterized by dark boson value (ref. note 2, paragraph 1.1).

\prec electromagnetic (gauge) field is massless due to non- interaction with scalar mode.

b) in the ‘pure’ state the representation (gravitational-dark field (A 2.1.1)- (A 2.1.2)) is reduced to case characterized by tensor mode. This corresponds to ‘the new bosonic mechanism’ model:

\succ gauge vector boson mass term is determined by $B_l B_l^* A_{ik} A_{ik}^*$ (ref. eq. (2.6.1 b)), where A_{ik} is in the form of eq. (A 2.1.0); $k^2 A_{ik}^* A_{ik}$ is the corresponding free-field term;

NB:

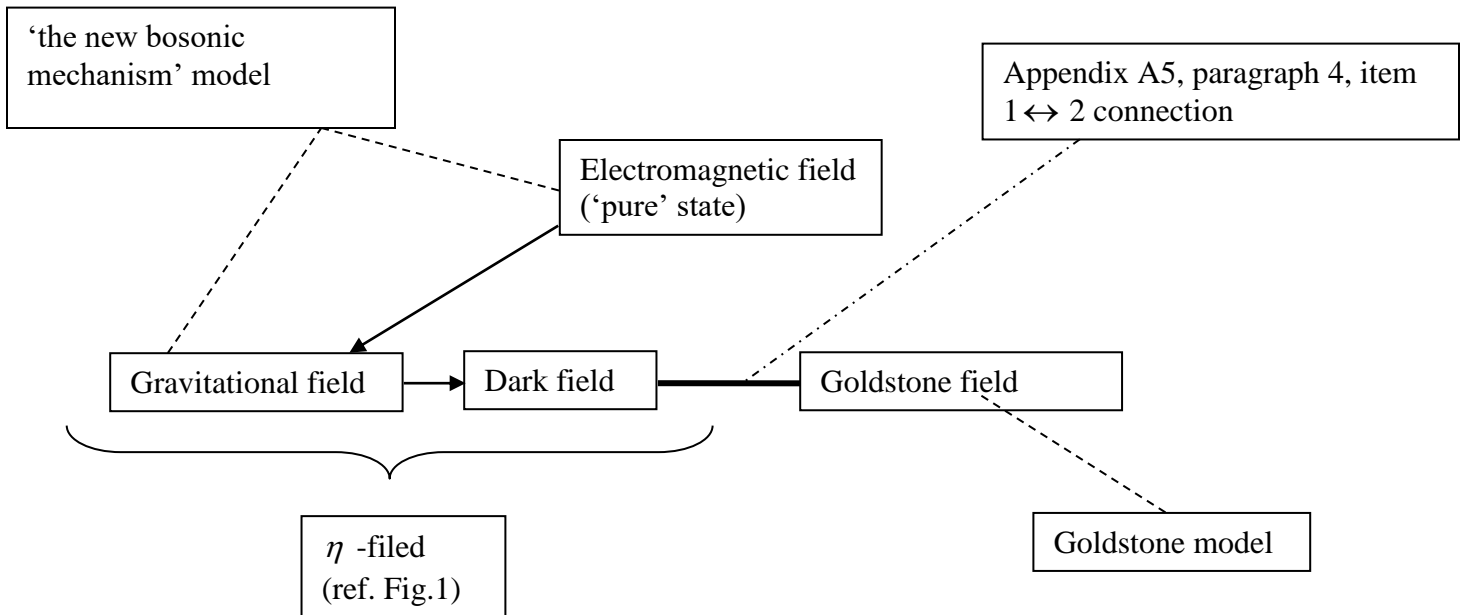

Fig. 1.2 Correspondence to ‘the new bosonic mechanism’ (theory framework).

NB:

In the case v.b) the mass channel is driven by gravitational field (i.e., $\sim A_{ik}A_{ik}^*$ term).

1-channel (gravitational) is presented in Fig. 8.2 below.

Obtaining mass by vector gauge boson is due to coupling between vector gauge boson and tensor mode as described by schema (ref. Appendix A5, paragraph 4, item 1).

< \exists coupling between photon with gravitational field h_{ik} ; there is no interaction between photon ϕ_i and dark sector Ξ .

> Electromagnetic (gauge) field is massive due to non-minimal interaction with tensor mode (ref. Appendix A3, eq. (A 3.2)), thus corresponding to the Ginzburg -Landau model ^{note}.

2-channel (tensor-gravitational) is presented in Fig. 8.2 below.

Obtaining mass by vector gauge boson is due to h - coupling.

< in this case tensor-graviton is the connection bundle (tensor mode by coupling with inverse metric tensor is reduced to tensor-gravitational scalar mode, which correspondently acquires dark boson value (ref. Fig.14 below)).

> This coupling results in the fact that the mass of vector gauge boson in scalar sector is identical to combined dark boson mass ((ref. case v.a) above). Thus, the corresponding mass term in the theory Lagrangian can denote either one (ref. Appendix A5, paragraph 4, item 2, a).

note:

Ginzburg -Landau model relations (ref. Fig. 3):

< area a) is related to Higgs model;

< area b) represents the renormalization group flow from area a) \rightarrow area c); and is defined by the β - function (ref. Appendix A4, paragraph 3);

< area c) is related to sigma model on Calabi-Yau manifold. This model describes the low energy dynamics of complex 2-dim theories with monopoles (ref. Fig. 6, Mark 2, 4).

CHAPTER V: CONCLUSION

i. The theory originally addressed the subject of obtaining masses by vector gauge bosons but the suggested approach is different from the Higgs mechanism.

This paper highlights the possibility for gauge boson to obtain mass not by means of interaction with Higgs boson, but by interacting with massive scalar mode of a single gravitational-dark field. The advantage of this approach over Higgs model is the manifest that the gauge boson acquires mass through interaction with combined gravitational dark field thus allowing the mechanism to account for the dark sector while Higgs model does not include dark sector. It has to be noted that obtaining masses in SM electroweak sector is not considered within the scope of this approach.

The theory includes topological issues (singularity embedded into hyperkähler manifold) and specifies the property and characteristic radiation of physical vacuum.

ii. In the framework of the outlined approach the subject of dark energy and dark matter is addressed. It is shown, that the origin and the mathematical description of dark sector naturally follows from a specified mechanism.

The existence of dark boson is predicted. This boson is manifested at the same time as a quant of dark field and as a gauge boson of interaction between particles of dark matter. Dark field represents the fifth dimension possessing a dark-like Killing field with a conserved quantity dark energy.

iii. As the theory spans over cosmological sector and includes items 1 and 2, it incorporate the complete Lagrangian ^{note} of the theory, EoM and canonically quantized gravitational field.

It was checked for the asymptotic behavior and coincides with Einstein eq. within appropriate limits.

The presented model contributes to Lorentz violation as a result of taking into account dark sector, which leads to the appearance of corresponding terms in Lagrangian of the theory and EoM.

iv. Obtained results have specific applications, for example:

1. Case of changing spacetime geometry;
2. It is shown how the theory naturally leads to AdS/CFT correspondence;
3. Obtained reformulation of quantum mechanical wavefunction, i.e. presented the way to treat wavefunction as a continuous function, which describes the object from inside and outside;
4. The notion of time is defined as a result of mathematical consequence of T -invariance violation; the solution to the arrow of time problem is mathematically demonstrated based on the group theory.

5. Obtained a mathematical topological explanation to the entanglement problem and a mechanism of the existence of stable traversable and non-traversable wormholes.

v. Introduced physics approach, which allows a program for the solution of the Navier-Stokes existence and smoothness problem.

vi. Discussed the cancellation mechanism (ref. Appendix C - Supplementary Chapter, paragraph 1), which can explain the absence of the observable Cherenkov radiation in the theory.

vii. Mechanism of Hawking radiation is addressed in the framework; the connections with Unruh effect and Schwinger effect are outlined.

viii. The renormalizability of the theory Lagrangian is presented in the paper.

note:

Lagrangian for the outlined mechanism is described by the formula eq. (1.4.1 a). Gauge vector boson mass terms are defined in Lagrangian eq. (2.6.1 b) and are proportional to $B_l B_l^*$; their description is outlined in Appendix A5, paragraph 4.

APPENDICES

Appendix A

1. The second channel of the mass source for dark field.

1. Derivation of eq. (1.6.1 a) from eq. (1.6) (in case $\phi_i = 0$).

From the first eq. condition ($= 0$) is satisfied for:

$$2k^2 A_{ik} - 2\Box A_{ik} + 2 \left\{ \frac{\partial^2 A_{sk}}{\partial x_s \partial x_i} + \frac{\partial^2 A_{si}}{\partial x_s \partial x_k} - \frac{1}{2} \delta_{ik} \frac{\partial^2 A_{rs}}{\partial x_r \partial x_s} \right\} = 0 \quad (\text{A 0.1})$$

$$-\frac{\partial^2 C}{\partial x_i \partial x_k} + \frac{1}{4} \delta_{ik} \Box C = 0$$

then using relations

$$\frac{\partial^2 A_{sk}}{\partial x_s \partial x_i} = \delta_{ik} \frac{\partial^2 A_{si}}{\partial x_s \partial x_i}; \quad \frac{\partial^2 A_{si}}{\partial x_s \partial x_k} = \delta_{ik} \frac{\partial^2 A_{sk}}{\partial x_s \partial x_k}$$

with the second eq.

$$-\frac{3}{2} k^2 C + \frac{3}{4} C - \frac{\partial^2 A_{rk}}{\partial x_r \partial x_k} = 0 \quad (\text{A 0.1a})$$

will obtain (A 0.1) in a form:

$$2k^2 A_{ik} - 2\Box A_{ik} + 3\delta_{ik} \left(-\frac{3}{2} k^2 C + \frac{3}{4} C \right) = 0 \quad (\text{A 0.1.1})$$

$$-\frac{\partial^2 C}{\partial x_i \partial x_k} + \frac{1}{4} \delta_{ik} \Box C = 0$$

follow (V. Fierz and W. Pauli, 1939) for symmetrical tensor A_{ik} whose trace vanishes, then consider;

case $i \neq k$

$$k^2 A_{ik} - \square A_{ik} = 0 \quad (\text{A 0.1.1 a})$$

$$\frac{\partial C}{\partial x_i} = 0$$

to satisfy eq. (A 0.1.1).

By substitution (A 2.1) into (A 0.1.1 a) from first eq., eq. (1.6.1 a) is derived.

2. Ansatz Fierz-Pauli eq. (1.6) for ($k = 0$) viz.,

where derivation of the metric is a small quantity of first order (V. Fierz and W. Pauli, 1939) for:

the metric tensor

$$g_{ik} = \delta_{ik} + \gamma_{ik}, \gamma_{ii} = \gamma$$

and the metric fluctuation

$$\gamma_{ik} = A_{ik} + \frac{1}{4} \delta_{ik} C, \gamma = C;$$

is reduced to the same eq. as Einstein eq. for space containing no matter:

(A.1)

$$-\square \left(A_{ik} + \frac{1}{4} \delta_{ik} C \right) - \frac{\partial^2 C}{\partial x_i \partial x_k} + \frac{\partial^2}{\partial x_l \partial x_i} \left(A_{lk} + \frac{1}{4} \delta_{lk} C \right) + \frac{\partial^2}{\partial x_l \partial x_k} \left(A_{li} + \frac{1}{4} \delta_{li} C \right) + \frac{1}{2} \delta_{ik} \left\{ \square C - \frac{\partial^2}{\partial x_l \partial x_r} \left(A_{lr} + \frac{1}{4} \delta_{lr} C \right) \right\} = 0$$

$$\square C - \frac{\partial^2}{\partial x_l \partial x_r} \left(A_{lr} + \frac{1}{4} \delta_{lr} C \right) = 0$$

where C is defined by (A 2.1) (in case $\phi_i = 0$);

from this eq., a system of eq. for $A-C$ components is obtained correspondently:

$$-\square A_{ik} + \frac{\partial^2 A_{ik}}{\partial x_l \partial x_i} + \frac{\partial^2 A_{li}}{\partial x_l \partial x_k} + \frac{1}{2} \delta_{ik} \frac{\partial^2 A_{lr}}{\partial x_l \partial x_r} = 0 \quad (\text{A1.1a})$$

$$\frac{\partial^2}{\partial x_l \partial x_r} A_{lr} = 0$$

and C component

$$-\square \left(\frac{1}{4} \delta_{ik} C \right) - \frac{\partial^2 C}{\partial x_i \partial x_k} + \frac{\partial^2}{\partial x_l \partial x_i} \left(\frac{1}{4} \delta_{lk} C \right) + \frac{\partial^2}{\partial x_l \partial x_k} \left(\frac{1}{4} \delta_{li} C \right) + \frac{1}{2} \delta_{ik} \left\{ \square C - \frac{\partial^2}{\partial x_l \partial x_r} \left(\frac{1}{4} \delta_{lr} C \right) \right\} = 0 \quad (\text{A1.1 b})$$

$$\square C - \frac{\partial^2}{\partial x_l \partial x_r} \left(\frac{1}{4} \delta_{lr} C \right) = 0$$

this eq. (A1.1 a) - (A1.1 b) is reduced to

$$-\square A_{ik} + \frac{\partial^2 A_{ik}}{\partial x_l \partial x_i} + \frac{\partial^2 A_{li}}{\partial x_l \partial x_k} = 0 \quad (\text{A1.2 a})$$

$$-\square \left(\frac{1}{4} \delta_{ik} C \right) - \frac{\partial^2 C}{\partial x_i \partial x_k} + \frac{\partial^2}{\partial x_l \partial x_i} \left(\frac{1}{4} \delta_{lk} C \right) + \frac{\partial^2}{\partial x_l \partial x_k} \left(\frac{1}{4} \delta_{li} C \right) = 0 \quad (\text{A1.2 b})$$

where A_{ik} satisfies the wave eq.

$$\square A_{ik} = k^2 A_{ik} \quad (\text{A1.3.1})$$

with condition

$$\frac{\partial A_{ik}}{\partial x_i} = 0$$

;

for $k_{\Xi} = 0$, $k_{\xi} = 0$

$$\frac{\partial A_{ik}}{\partial x_i} \neq 0$$

but choosing a gauge to satisfy

$$\frac{\partial A_{ik}}{\partial x_i} = 0 \quad (\text{A1.3.2})$$

this is an analog to the Lorentz condition for electromagnetic potentials;

$$\frac{\partial^2 A_{ik}}{\partial x_i \partial x_k} = 0 \quad (\text{A1.3.3})$$

and

$$C \neq 0 \quad (\text{A1.3.4})$$

2. Lagrangian of the presented theory.

Consider an expression for Lagrangian from which equations in full nonlinear form are derived.

Let us consider eq. (1.4.1 a) and compare it with eq. (A 2.0) (general form of eq. (1.2.1 a)).

$$L_{FP} = k^2 A_{ik} A_{ik} + \frac{\partial A_{ik}}{\partial x_l} \frac{\partial A_{ik}}{\partial x_l} - 2 \frac{\partial A_{rk}}{\partial x_r} \frac{\partial A_{sk}}{\partial x_s} - \frac{3}{4} k^2 C^2 - \frac{3}{8} \frac{\partial C}{\partial x_l} \frac{\partial C}{\partial x_l} + \frac{\partial A_{rk}}{\partial x_r} \frac{\partial C}{\partial x_k} \quad (\text{A 2.0})$$

this FP eq. can be obtained from eq. (1.4.1 a) in case of no interaction.

According to the approach developed in § 1.1.:

i. The following correspondence exists:

(A 2.1)

case $\phi_i = 0 \mid C_{jlk}^i = 0$

case $\phi_i \neq 0 \mid C_{jlk}^i \neq 0$

$$i\Pi_k = \frac{\partial}{\partial x_k}$$

$$i\Pi_k = \frac{\partial}{\partial x_k} - ie\phi_k$$

$$\text{contr}(A_{ik}) = \iota_{ii}\Xi$$

$$A_{ik} = ih_{ik}$$

$$C = \nu + \xi$$

$$C = \nu + \xi + i\xi'$$

where

a wave-field A_{ik} is a symmetrical tensor of the second rank (ref. Fierz-Pauli);

C is an auxiliary scalar field.

1. For $\phi_i = 0$ dark field is not coupled (ref. ^{note1} eq. (1.4.1)), follow FP schema A_{ik} real, also C real.

1.1. According to (Anguige and K.P. Tod, 2008) the electric and magnetic parts of the Weyl tensor of g_{ik} are defined by:

$$E_{ik} = C_{idk}^c t_c^d$$

$$B_{ik} = \frac{1}{2} \varepsilon_{ie}^{cd} C_{kcd}^f t^e t_f$$

where

t^d unit timelike vector,
is determined by $\exists C_{jlk}^i \neq 0$;

i.e. $\langle g^{ik} \rangle \Leftrightarrow (E_{ik}, B_{ik})$, $\forall C_{jlk}^i \neq 0$

(ref. theorem on constructing spacetime from compact manifold);

1.2. If $C_{jlk}^i = 0$:

$$\left. \begin{array}{l} E_{ik} = 0 \\ B_{ik} = 0 \\ \langle g_{ik} \rangle = 0 \end{array} \right\} \Rightarrow A_{ii} = t_{ii} \Xi \quad (\text{A 2.1 a})$$

by Weyl curvature hypothesis at start-up time (Lorentz metric);

1.2.1. If $C_{jlk}^i \neq 0$:

$$\left. \begin{array}{l} E_{ik} \neq 0 \\ B_{ik} \neq 0 \\ \langle g_{ik} \rangle \neq 0 \end{array} \right\} \Rightarrow A_{ii} = t_{ii} \Xi + \text{contr} \{ E_{ik}, B_{ik} \} ih \quad (\text{A 2.1 b})$$

then obtain the case of (tensor-dark field), i.e. g_{ik} decoupled from the dark field Ξ
viz. $A_{ik} \mapsto \langle g^{ik} \rangle A_{ik}$;

if $\langle g^{ik} \rangle$ is coupled with the gravitational field h_{ik} (tensor-gravitational field), then
Goldstone-dark field ζ (ref. ^{note²} eq. (1.3.0)) can be considered;

if $\langle g_{ik} \rangle$ coupled with the dark field Ξ , then Goldstone and dark fields is of different origin.

$\therefore ih(x)$ is the Weyl complex scalar Ψ_4 (ref. Weyl scalars);

this term leads to the Mexican hat potential and determines a Goldstone boson existence
(ref. complex scalar field theory).

2. for $\phi_i \neq 0$ dark field does not interact with the electromagnetic field, therefore, omit the Goldstone-dark field terms; according to the FP schema, A_{ik} , C are complex.

2.1. If $C_{jlk}^i \neq 0$:

$$\left. \begin{array}{l} E_{ik} \neq 0 \\ B_{ik} \neq 0 \\ g_{ik} \neq 0 \end{array} \right\} \Rightarrow A_{ik} = ih_{ik} \quad (\text{A 2.1 c})$$

(Lorentz metric)

where

$\therefore o_{ik}$ metric fluctuation, i.e. $\langle g_{ik} \rangle \mapsto g_{ik}$:
 $(ih_{ik} = i\langle g_{ik} \rangle h \mapsto ig_{ik} h = ig_{ik} \langle g^{ik} \rangle h_{ik}, g_{ik} = \langle g_{ik} \rangle + o_{ik})$

$$A_{ik} = ih_{ik} [1 + o_{ik} \langle g^{ik} \rangle] \quad (\text{A 2.1.0})$$

second term represents the gravitational entropy.

3. combining cases 1, 2 (ref. (A 2.1))^{note}

\therefore a wave-field A_{ik} :

$$A_{ik} [\delta_{ik} \delta_{\phi}^0 + (1 - \delta_{\phi}^0)] = t_{ii} \Xi \delta_{\phi}^0 + ih_{ik} [(1 - \delta_{\phi}^0) + \langle g^{ik} \rangle (\delta_{\phi}^0 - \delta_C^0)] \quad (\text{A 2.1.1})$$

can exist in states described by h_{ik} and Ξ , then it can exist in a state described by the gravitational - dark field η (ref. eq. (1.1 a)), i.e. further referring to a gravitational field, however, where it is appropriate it refers to the gravitational -dark field; compare eq. (1.1 a) and case 1.2.1, $A_{ii} = i\eta, \forall C_{jlk}^i \neq 0$ is obtained.

$A_{ik} (\exists: C_{jlk}^i \neq 0, \phi_i = 0)$ represents a state, which incorporates a characteristic of time (time scalar t_{ii}) and characteristic of space (metric tensor g_{ik}), thus defining spacetime.

\therefore an auxiliary scalar field:

$$C = \nu + \xi + i\xi' (1 - \delta_{\phi}^0) \quad (\text{A 2.1.2})$$

where complex scalar field referred to by Goldstone theorem and $(\phi_i = 0)$ represents massless Goldstone bosons; when $(\phi_i \neq 0)$ represents pseudo-Goldstone bosons.

note:

this interpretation corresponds to the principle of general covariance in general relativity (ref. Wheeler- DeWitt eq.), compare to case 2.1.

ii. By substituting (A 2.1) correspondently into mass terms for eqs. (1.4.1 a) and (A 2.0):

\therefore case $\phi_i = 0$

compare eq. (0.1.1) and mass term for eq. (A 2.0) and by virtue of Goldstone theorem ($k_\xi = 0$) and ref. eq. ((1.3 a), note 3), obtain

$$2\lambda\Xi^2\nu^2 = k_\Xi^2 \left(\langle g^{ik} \rangle \right)^2 A_{ik}^2 \quad (\text{A 2.2.1})$$

i.e. $k_\Xi \sim \sqrt{\lambda}\nu$ (if quartic interaction terms are omitted and the constant terms are contracted), masses for dark field (ref. eq. (1.3 b)) are obtained.

\therefore case $\phi_i \neq 0$

from eq. (M.E. Peskin and D.V. Schroeder, 1995; C. Itzykson and J-B. Zuber, 1980) of complex massless boson field coupled minimally with an electromagnetic field (compare eq. (0.1.2)) and eq. (1.4.1 a) by virtue of dark field, which does not interact with electromagnetic field, therefore Goldstone-dark field can be omitted altogether, and the following is obtained

$$\frac{1}{2} (\partial h_{ik} + e A_{ik} \nu)^2 = k_h^2 A_{ik}^* A_{ik} \quad (\text{A 2.2.2})$$

then ref. eq. (1.5)^{note²}, obtain masses for gravitational field $k_h \sim e\nu$.

Thus, it is confirmed that mass terms in FP eqs. (A 2.0) and (1.4.1 a) and eqs. (1.3 b) and (1.5) correspond and have the same values.

➤ Based on the following facts:

1. FP Lagrangian eq. (A 2.0) is a non interactive limit of eq. (1.4.1 a);
2. Fierz-Pauli field eqs. (1.2.2 a) and (1.4.2 b) for massless gravitational and dark fields can be obtained correspondently from eqs. (A 2.0) and (1.4.1 a) by performing the variations.

⤵ Therefore, follows the conclusion that eq. (1.4.1 a) is sought for Lagrangian^{note}.

note:

the mechanism of appearing mass terms in FP eqs. (A 2.0) and (1.4.1 a) is specified in paragraph 1.

3. Considering of non-minimal coupling.

In additional terms the fields h, ζ, ϕ_i in (1.5) appear, i.e. ^{note}

$$L_{h-\zeta}^1 = \sqrt{2}e\phi_i\zeta(\partial_i h + e\nu\phi_i) - \sqrt{2}e\phi_i h(\partial_i \zeta + e\nu\phi_i) + \sqrt{2}e^2\phi_i^2\nu h \quad (\text{A 3.1})$$

$$L_{h-\zeta}^2 = e^2\phi_i^2(\zeta^2 + h^2)$$

where

Noether's current (or real-valued fields) is

$$j_i = i[h(\partial_i \zeta + e\nu\phi_i) - \zeta(\partial_i h + e\nu\phi_i)]$$

see ref. in note 2 on (1.5);

last term in $L_{h-\zeta}^1$ of $\nu - h$ coupling.

Therefore, the following is obtained:

$$L_{h-\zeta}^1 = i\sqrt{2}e\phi_i j_i + \sqrt{2}e^2\phi_i^2\nu h \quad (\text{A 3.1.1})$$

$$L_{h-\zeta}^2 = e^2\phi_i^2(\zeta^2 + h^2)$$

To retain a correct number of degrees of freedom for spin 2 field, non minimal interaction term is to appear (C.R. Hagen, 1972)

$$L_{non\ min} = \frac{1}{4}ie h_{\alpha} F^{\alpha\beta} h_{\beta}^i \quad (\text{A 3.2})$$

note:

this approximation holds in the case of minimal electromagnetic coupling.

4. The quantum effects and underlying statistical field theory.
The structure of quantum effects.

1. Following with the consideration (J. Eggers and M.A. Fontelos,2015; part I) of the theorem of Stokes' and corresponding connections to gradient, curl, and divergence theorems (ref. Stokes' theorem); obtain (I.E. Tamm, 1979):

curl theorem

$$\oint_L \phi_s ds = \int_s \text{rot}_n \vec{\phi} ds \quad (\text{A } 4.1)$$

where

$$\oint_s \text{rot}_n \vec{\phi} ds = 0$$

divergence theorem

$$\oint_s \phi_n ds = \int_V \text{div} \vec{\phi} dV \quad (\text{A } 4.2)$$

Green's theorem

$$\int (\psi \nabla^2 \phi - \phi \nabla^2 \psi) dV = \oint_s \left(\psi \frac{\partial \phi}{\partial n} - \phi \frac{\partial \psi}{\partial n} \right) ds \quad (\text{A } 4.3)$$

using Helmholtz diff. eq. and Lie brackets definition, from (A 4.2) , (A 4.3), derives:

$$[\psi_{-\vec{n}}, \phi_{\vec{n}}] = \text{div} \vec{\phi} \quad (\text{A } 4.4)$$

where ^{note:}

note:

noted that in order for necessary and sufficient condition for a smooth vector field $\vec{\phi}$ to be the gradient of F - function, the *curl* of $\vec{\phi}$ must be equal to 0 (Poincare's theorem), since

$$\text{grad} F = \frac{\partial F}{\partial n} \vec{n},$$

obtained

$$\text{grad} (\psi_{-\vec{n}} \phi_{\vec{n}}) = \psi \frac{\partial \phi}{\partial n} \vec{n} - \phi \frac{\partial \psi}{\partial n} (-\vec{n})$$

where, factorized on boundary, i.e. due to the existence boundary conditions on surface S when changing from $-\vec{n}$ to \vec{n} :

$$\vec{\phi} = \text{grad} (\psi_{-\vec{n}} \phi_{\vec{n}}) ;$$

$\psi_{-\vec{n}}, \phi_{\vec{n}}$ are wavefunctions of state of the inside and outside surfaces (i - shapes) correspondently.

↳ eq. (A 4.2) denotes the correspondence of compact-3 manifold to compact -2 manifold^{note⁰} (J. Eggers and M.A. Fontelos, 2015; part II); ϕ_s represent information written on the surface.

↳ Existence of the singularity follows from eqs., refers to the contour L of surface S , which limits volume V .

This contour determines the boundary of the singularity under consideration.

1.1. The following addresses to singularity.

i. use parallelism of eq. for the entropy of the set of events and the quantity of information described by this set through the eq.

$$H = -\sum_{j=1}^n P(A_j) \log_a P(A_j) \quad (\text{A 4.5})$$

$P(A_j)$ is probability of event A_j ; $a \mapsto e$;

and the formula, which specifies the entropy of a discrete variable X with defined probabilities^{note¹}

$$H = -\sum_{j=1}^n p_j \log_a p_j \quad (\text{A 4.6})$$

p_j is probability of value x_j ;

and refers to the reflective correspondence(bijection) between the event and the microscopic state of the (defined by singularity) system, which can comprise from injective metric spaces.

note:

⁰ This leads to the AdS/CFT correspondence taking into account the following:

1. condensation of massless relativistic bosons in 2D phase transition of the third order is consistent with the condensation of 3D finite-mass relativistic bosons (F. Zwicky, 1961; S. Fujita, T. Kimura and Y.Zheng, 1991);

2. a) and assumption on barrier – black hole dynamic (ref. Appendix A4, paragraph 2.1, Fig.7). This results in the appearance of free massless relativistic bosons moving in 3D.

b) Since no condensation occurs in 1D (F. Zwicky, 1961; S. Fujita, T. Kimura and Y.Zheng, 1991), this dimension represents quantum (Bohmian) trajectories (ref. note 2, Appendix A5, paragraph 2.2, sub-item **ii**).

¹ Also addresses to the differential entropy (with continuous series of values):

$$H = -\int_{-\infty}^{\infty} f(x) \log_a f(x) dx$$

$f(x)$ is probability density function, can be expressed through the wavefunction of Schrödinger eq. in the framework of a certain physical system model (ref. note 2, Appendix A4, paragraph 1, item 1.1, sub-item **ii**).

ii. Viz., correspondence between continuous distribution of value of non-observables and discrete distribution of the events, noted by the eq.

$$f(x) = \sum_{k=1}^n p_k \delta(x - x_k) \quad (\text{A 4.7})$$

where the events addressed to the microscopic states of the system under consideration, described by the quantum mechanics of non-observables ^{note²}.

iii. injective metric spaces directed into the interior of the black body is indeed the entropy generation attributed to the emission of radiation into a vacuum; according to (P. Würfel, 1988) generation of entropy is not due to the emission of radiation into the vacuum, but rather the absence of absorption from the vacuum, which comprises the case.

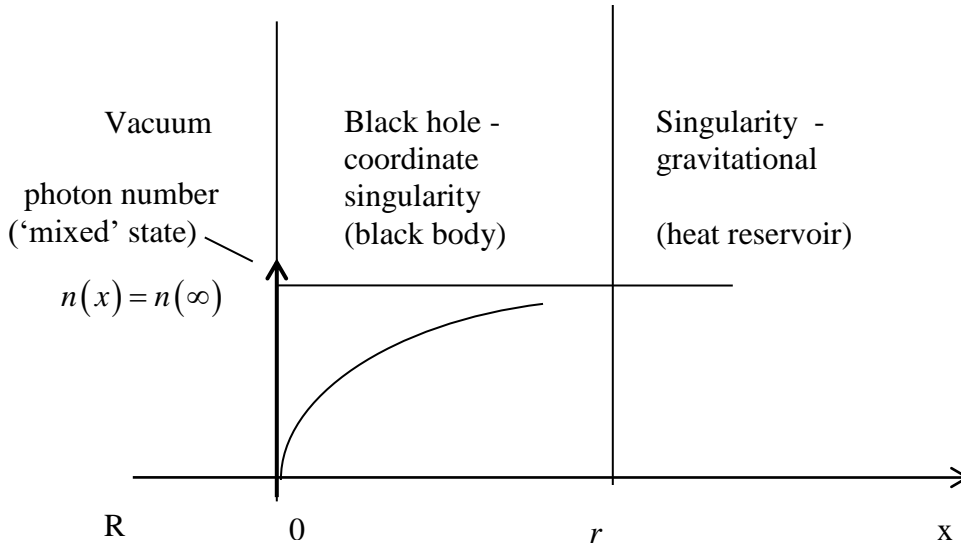

Fig. 2 System (black body + singularity)
Ref. (Fig. 1 (P. Würfel, 1988));

2. eq. (A 4.4) addresses the collapse wavefunction, as postulate of quantum mechanics, which is complete information about the system encoded in its wavefunction;

therefore, the wavefunction ^{note³} can be considered as probability to obtain specific *i*-shape (i.e. particle) received at particular point as a projection of information at particular time, described by entropy at this point - $div\vec{\phi}$.

^{note:}

² to develop this approach, a certain physical system model (time series to address non-observables) is utilized;
ref. Appendix B – Extensions Chapter.

³ P_i , which is defined in the section Appendix B – Extensions Chapter determines quantum potential for the *i*-shape.

3. eq. (A 2.1.1) addresses the structure of a wave-field

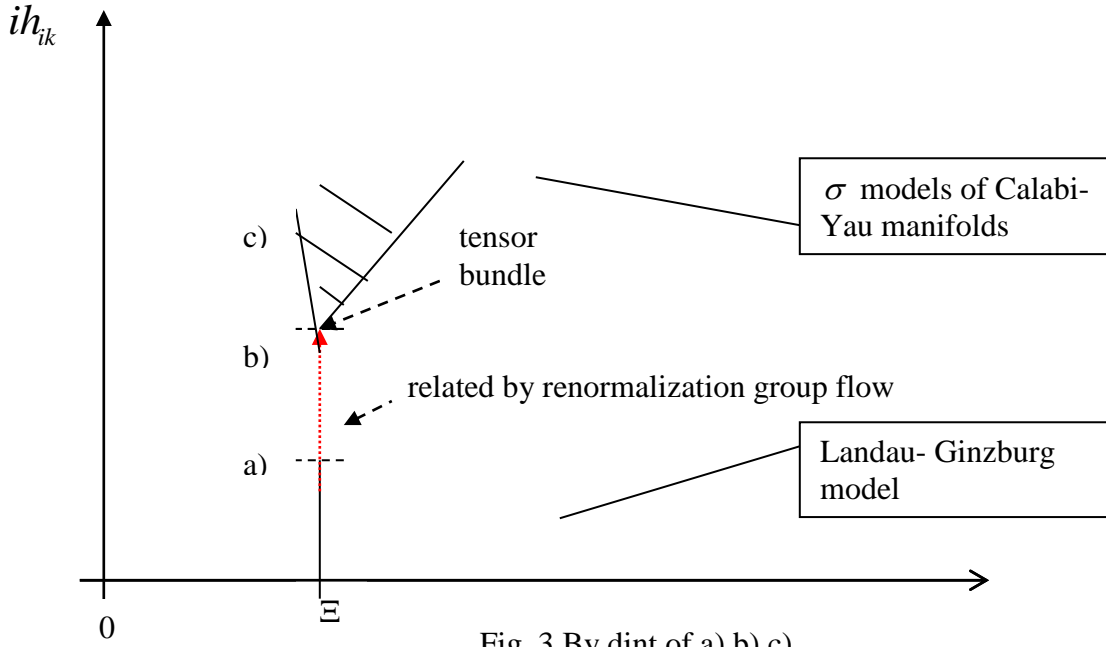

Fig. 3 By dint of a),b),c)

a) $\phi_i = 0, \langle g^{ik} \rangle : \therefore ih_{ik} \langle g^{ik} \rangle;$

b) $\phi_i \neq 0, \langle g_{ik} \rangle : \therefore \langle g_{ik} \rangle = \langle g^{ik} \rangle \Rightarrow \phi_i^0; V = \mathbb{R}^n, V^* = Hom(V, \mathbb{C}) : \therefore h_i^k = \left(\left(\begin{matrix} k \\ \otimes V \end{matrix} \right) \right) \otimes \left(\left(\begin{matrix} i \\ \otimes V^* \end{matrix} \right) \right)$

with a tensor representation of $GL(n) \wedge SO(3) \subset GL(n)$

c) $\phi_i \neq 0: \phi_i > \phi_i^0, g_{ik} : \therefore ihg_{ik} = ih(\langle g_{ik} \rangle + o_{ik}) = ih_{ik} \langle g^{ik} \rangle (\langle g_{ik} \rangle + o_{ik}) = ih_{ik} (1 + o_{ik} \langle g^{ik} \rangle)$

ref Appendix A2, paragraph 2.1.

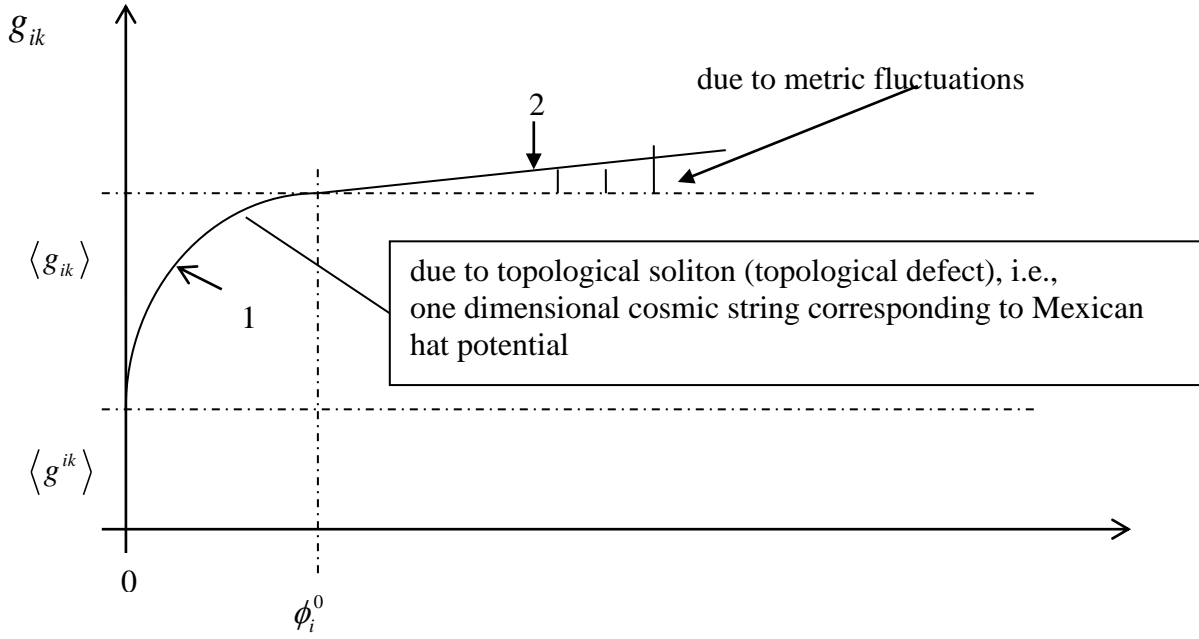

Fig. 4 Metric tensor as a representation by the power law function $(\phi^i)^n$

1. area a)-b) Fig. 3: $\phi_i < \phi_i^0$

$$\langle g^{ik} \rangle = \left((\phi^i)^n + \mathcal{G}^i \right) \theta^k + \left((\phi^i)^n + \mathcal{G}^i \right) \mathcal{G}^k + \delta^{ik}$$

and represents dyadic product;

where

$$n = 1/2;$$

\mathcal{G}^i -stochastic uncertainty

$$\mathcal{G}^i = \varepsilon^{jlk} C_{jlk}^i,$$

i.e. stochastic uncertainty defined by the Weyl curvature tensor (ref. Viz., (1.1 b));

θ^k is the torsion 2-form (due to the metric torsion tensor: ref. connected helicoids, paragraph 3.2, item 4).

2. area c) Fig. 3: $\phi_i > \phi_i^0$

$$g_{ik} = \langle g_{ik} \rangle + o_{ik} \text{ (ref. case b), Fig. 3);}$$

o_{ik} - metric fluctuations are due to entropy (T. Jacobson, 1995).

note:

metric variations are separated into two parts:

1. induced (vacuum(quantum)) metric fluctuations, which determine the existence of primordial fields, are due to stochastic source leading to the exponential instabilities;
2. intrinsic (classical) metric perturbations, which relate to the entropy and represent feedback mechanism, cancel instabilities arising due to the induced part.

Therefore, sector a)-b) Fig .3 represents a renormalization group with a specification of the renormalization trajectory (for the group equation) of the metric parameter g_{ik} by the power law function.

➤ Dependence of the β -function ^{note⁰} on the energy scale is determined by dint of the mechanism generation of entropy (Fig. 2), which is caused by ϕ^i and is described by the Gell-Mann-Low eq.(consideration address fixed physical mass) and not of Callan - Symanzik type.

Figure 4 (in the framework applied to Calabi-Yau manifolds in two complex dimensions) outlines the importance of account for topological defects considering renormalization group flow (G. Zumbach, 1995).

The power exponent addresses the critical exponent ^{note¹} in the phase transition.

i. In the order phase (spontaneous symmetry breaking ^{note²} of G-type), specifies:

1. order parameters indicate the presence of line-like excitations such as vortex (note1, Fig.1, paragraph 5) or defect lines (G. Zumbach, 1995).

ii. according to (C. Grebogi, E. Ott and J.A. Yorke, 1986), values of the critical exponents for boundary crises and interior crises regimes are obtained:

$n = 1/2$ for one-dimensional maps with a quadratic maximum; \mapsto cosmic string.

$n = 2$ for two-dimensional maps, also applies to three-dimensional continuous-time systems. (\mapsto domain wall, False vacuum).

$$x_{n+1} = p - x_n$$

which recovers a Henon map for the case $J \rightarrow 0$ for a one-dimensional map; and

$$x_{n+1} = p - x_n - Jy_n$$

$$y_{n+1} = x_n$$

For a two-dimensional map,

where

J is the Jacobian of the map (const).

note:

⁰ explicit expression for β -function in case of scalar Φ^4 theory is in ref. (A.A. Vladimirov and D.V. Shirkov, 1979);

¹ it has no explicit dependence on the reduced temperature;

² on singularity and spontaneous symmetry breaking, ref. (M. Golubitsky and D. Schaeffer, 1983).

1. The chaotic transient regime and the intermittent bursting addresses to the Mark 1 on Fig. 6; (ref. to example: Ikeda map).

$\exists \phi^i$ as part of composite system with field η (ref. note eq.(1.1 b)).

2. Intermittent switching addresses to the Mark 3 on Fig. 6; (ref. to example: Forced double-well duffing equation)

$$\frac{d^2x}{dt^2} + v \frac{dx}{dt} + \frac{\partial V}{\partial x} = p \sin(\omega t)$$

where

$$V = \frac{\alpha x^4}{4} - \beta \frac{x^2}{2}$$

with two minima

$$x = \pm \left(\frac{\beta}{\alpha} \right)^{\frac{1}{2}}$$

case: $p = p_c$ corresponds to eq. (1.3 a);

the external force determined by the presence of radiation from layer Z (ref., Fig.1);

case: $p > p_c$ corresponds to the intermitted switching between $x > 0$ and $x < 0$ wells;

this can address to forming the conditions of \exists wormhole geometry in a tunnel area (Fig.1).

p, p_c - parameters and addresses to the critical value.

4. Application to wormhole geometry.

Inference topology structure (Fig.1) in a double symmetric geometry can connect these geometries by a double tunnel.

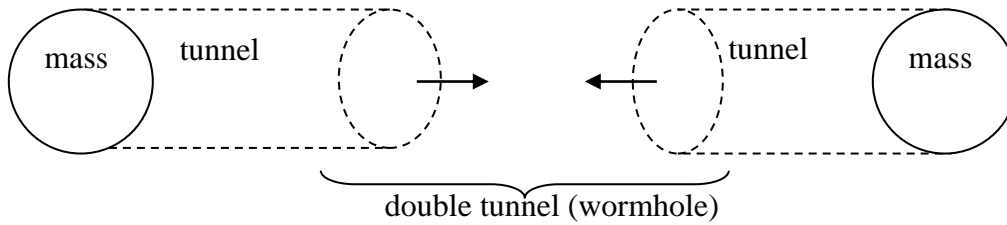

Fig. 5.1 two tunnels construct a wormhole structure (dynamics of tunnels is defined by: ref. Paragraph 4.1, item 2: 2.1-2.3).

Inverse topology of the geometrical model in Fig. 5.1 represents connected chain as depicted in Fig. 5.2

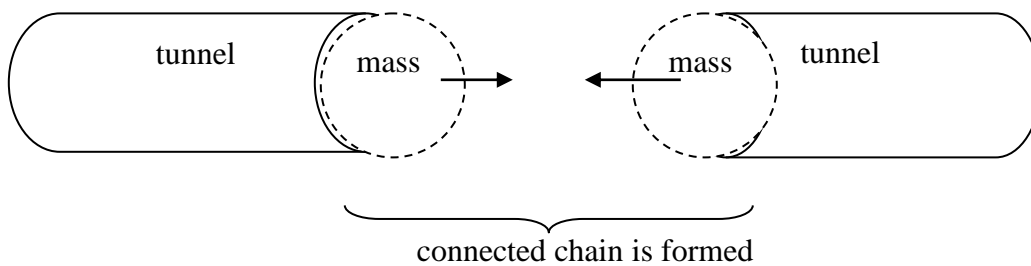

Fig. 5.2 inverse geometrical model.

5. Connections between different topics within a single theoretical framework.

To a unified field theory

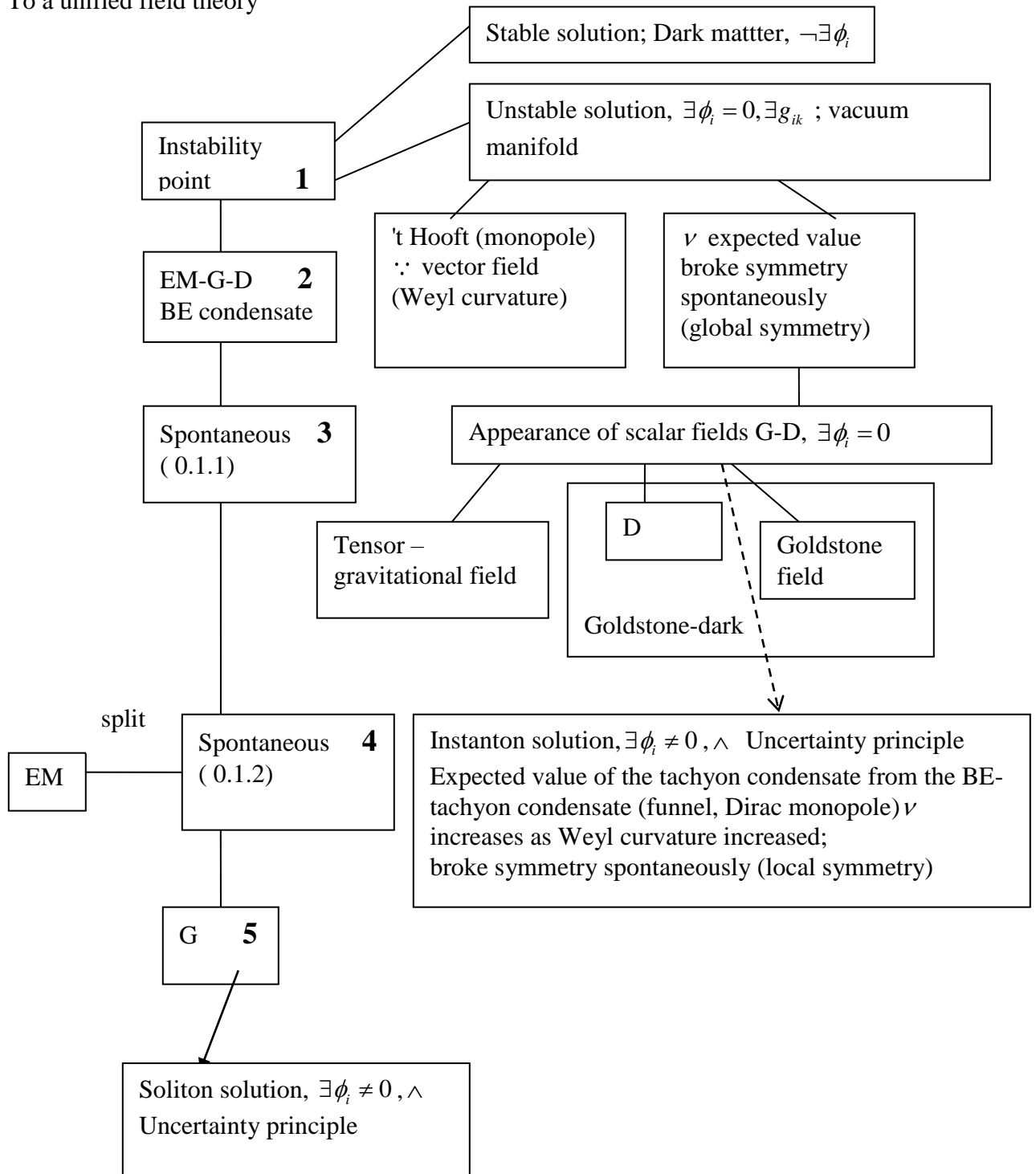

Fig. 6 Ref. Symmetry breaking mechanism and eq. (1.1 b)
(EM: electromagnetic field, D: dark field,
G: gravitational field).

Mark 1:

low entropy content; Weyl curvature tensor vanish.

Mark 3:

i. \exists scalar mode comprises a tensor-gravitational field + dark field; consider the Weyl curvature increase;

ii. assign mass to the dark boson, ref. eq. (1.3 a).

Mark 4:

assign mass to the gravitational field and the appearance of the massive Goldstone boson, ref. eq. (1.5).

Mark 5:

assign mass to particles, ref. Model of boson masses.

Corollary:

The EM field does not interact with the D field, due to the difference in underlying mechanisms of appearance.

The G field is present during noted processes, i.e. it can be applied to the D and the EM fields.

← Possibility for the asymmetry between baryons and antibaryons.

1. Mark 1-3 outlines a possibility for asymmetry between the baryonic and dark matter due to the appearance of the electromagnetic field in a 'mixed' state after gauge, conformal symmetry breaking. The annihilation of massive dark matter particles results in antimatter production which (according to the mechanism described in Appendix A5, paragraph 3, sub-item **a**)) leads to the CP violation (ref. Appendix C - Supplementary Chapter , paragraph 1) in the presence of the electromagnetic field in a 'mixed' state and results in asymmetry.

2. Mark 4-5 corresponds to obtaining mass by particles as a result of a spontaneous symmetry breaking with the electromagnetic field in a 'pure' state.

1. Consideration ^{note} of the Bose-Einstein-tachyon condensate with funnel leads to the Navier-Stokes eq. in the form (N.H. Katz and N. Pavlovic, 2004; Y. Habara, Y. Nagatani, H.B. Nielsen and M. Ninomiya, 2007):

$$\frac{\partial \vec{v}}{\partial t} = -(\vec{v}\nabla)\vec{v} + \nu\Delta\vec{v} - \frac{1}{\rho}\nabla p + \vec{f} \quad (\text{A 5.0.1})$$

where \vec{v} -velocity vector field; ν -coefficient of kinematic viscosity; \vec{f} -represents gravity and includes electromagnetic forces; ρ -density; p - pressure.

According to the outlined approach, define the convection term, by a vector calculus identity

$$(\vec{v}\nabla)\vec{v} = \nabla\left(\frac{\|\vec{v}\|^2}{2}\right) + (\nabla \times \vec{v}) \times \vec{v} \quad (\text{A 5.0.2})$$

where, the second term defines the funnel (Dirac monopole);

also term \vec{f} can represent in the form

$$f_i = z_i \quad (\text{A 5.0.3})$$

where

$$z_i = \phi_i + \frac{1}{e\nu} \partial_i h, \text{ ref. (note 2, eq. (1.5)).}$$

As specified in (in: D. Vorberg, W. Wustmann, R. Ketzmerick and A. André Eckardt, 2013) rotating the Bose-Einstein condensate develops vortices, which are phase singularities (ref. note1, paragraph 5 and Appendix A5, paragraph 2.1, sub-item **iii**).

note:

the condensation temperature T_c of this condensate comprised of free relativistic bosons massless and massive is specified in ref. (F. Zwicky, 1961; S. Fujita, T. Kimura and Y. Zheng, 1991).

2. Instability point ^{note}.

Define the point in spacetime ε^0

$$\lim_{|\varepsilon| \rightarrow 0} \varepsilon = \varepsilon^0 \quad (\text{A 5.1})$$

∴ $+\varepsilon \rightarrow 0, -\varepsilon \rightarrow 0, \therefore$ noise fluctuations appear in the area ε around $\varepsilon = 0$, i.e.

∃ resonator due to noise-induced fluctuations around equilibrium \Rightarrow

∴ inherent fluctuations ∴ lack of global restoring force due to a continuous global symmetry.

Corollary:

i. curve and rift spacetime in ε^0 ∴ Weyl curvature appears with a characteristics mark 1; source of \mathcal{V} , ref. note (paragraph 1.1).

ii. define entropic arrow of time ∴ mark 2 (Weyl curvature increase), ref. Appendix A2, paragraph 1.1.

iii. refer to the scalar domain \Rightarrow
mark 3: due to mass for the D ∴ $\Phi(x)$ is charged (i.e. complex scalar);
tensor-gravitational field refers to the renormalization group, ref. Fig. 3;

∴ in eq. (1.1 b), applies to the phase domain.

note:

Ref. Kibble mechanism and address the sector a)-b) Fig .3.

2.1. Instanton solutions ^{note}.

Consider black holes (\exists exclusive principle), i.e. :

i. Area bounded by event horizon $[r, 0[$ denoted by the Heisenberg uncertainty principle ^{note¹}

$$\Delta E \Delta t \geq \frac{\hbar}{2} \quad (\text{A 5.2})$$

where,

$$\prec \Delta t \rightarrow 0, \Delta E \rightarrow \infty; \quad (\text{A 5.2.1 a})$$

this solution corresponds to the Bose-Einstein condensate represented by fields, which lost both information component ^{note²} $\forall x=0$ and mass $\forall x \in [r, 0[$.

ii. Quantum tunneling ^{note³}, which occurs under the barrier – black hole, characterized by $x \in [r, 0[$

$$\succ \Delta t \sim \varepsilon, \Delta E \gg 0 \quad (\text{A 5.2.1 b})$$

\Rightarrow transmitted wave constitutes energy flux and can be related to the Hawking radiation;
spectrum of radiation is analogous to spectrum of black body radiation.

iii. Bose-Einstein condensate indicates \exists 't Hooft monopole.

Phase domain Appendix A5, paragraph 2, sub-item **iii**, related to spontaneous symmetry breaking and emergence of scalar fields in vacuum ref. eq. (1.1 b).

When configuration space of scalar fields contains non-contractible circles then Nielsen-Olesen vortex is obtained and, in application to cosmic string geometry, it is described by Nambu-Goto action.

note:

3D steady-state vortex solution of (A 5.0.1);

¹ reservations by Pauli regarding time operator can be addressed by the following considerations (V.S. Olkhovsky and E. Recami, Nuovo Cimento, 1974);

² ref. Appendix A4.

³ The graviton mass $O(10^{-32})$ eV (F. Zwicky, 1961; S. Fujita, T. Kimura and Y. Zheng, 1991) appears under this consideration as the mass of the ground state (Kaluza-Klein) modes, which exist in BE condensate.

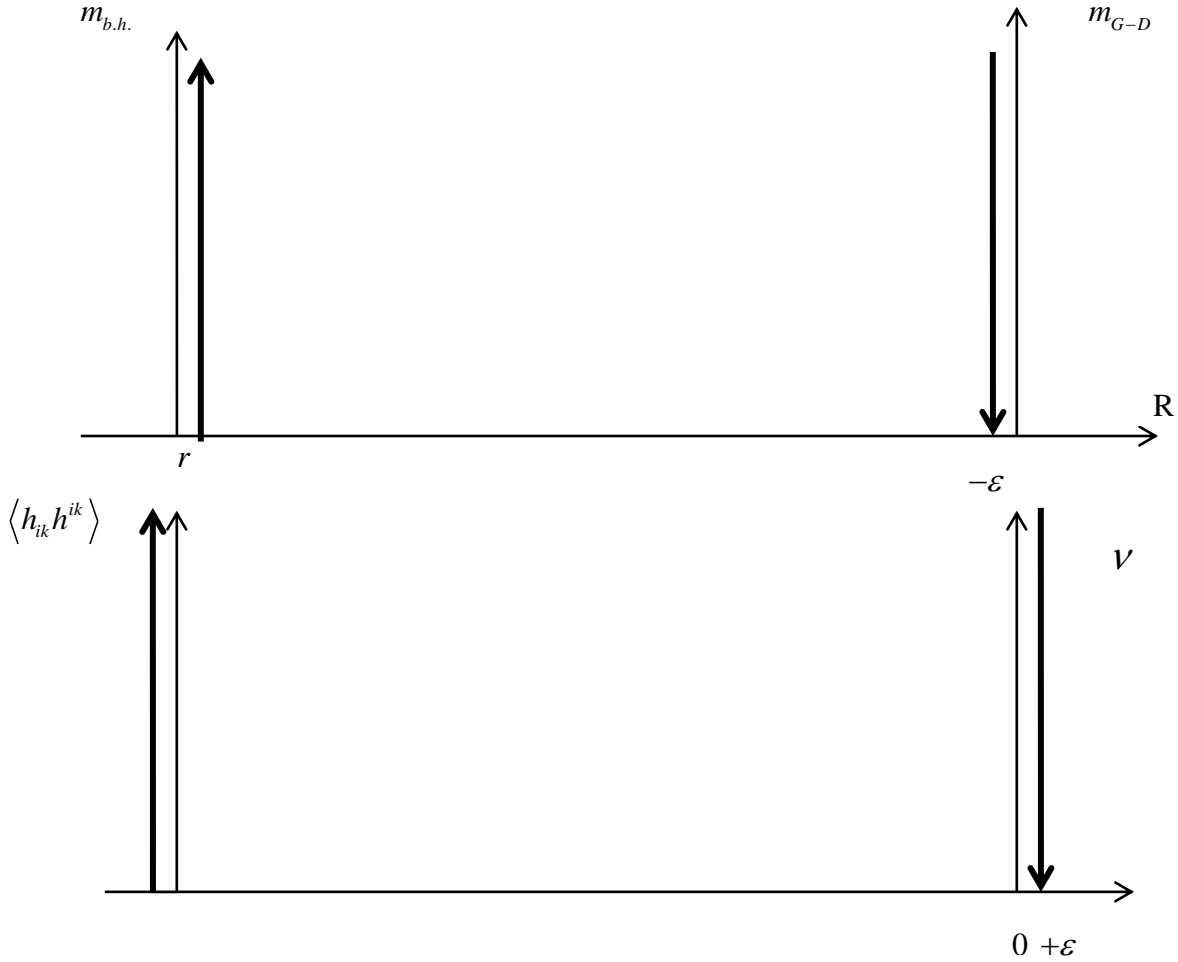

Fig. 7 Corollary of instanton solution
 $(\phi_i = 0, \forall x \in [r, 0[; \phi_i \neq 0, \forall x \in [0, R[;)$
 by dint of a), b).

a) $\langle h_{ik} h^{ik} \rangle$ is tachyon condensation, ref. tensor-gravitational field h is included in complex part of eq. (1.1 b);

b) mathematical expression for spacetime is reduced to scalar $\langle g^{ik} g_{ik} \rangle$.

Barrier – black hole in the area $x = 0$ ‘peels off’^{note} information structure and mass from matter fields, thus obtaining a ‘sandwich’ structure within the framework denoted by eqs. (A 4.1) - (A 4.3).

note:

¹ this represents a virtual particle, which infalls into b.h.; the outside virtual particle state correlates with the state of the particle in b.h., i.e. these two particles (subsystems) exist in a ‘mixed’ state. Complete quantum system comprised from these subsystems exists in a ‘pure’ state^[1,1], i.e. accounting for off-diagonal elements of the density matrix, which represent the coherences in the system of the ‘mixed’ states. This takes into account correlations between vacuum entangled states (the state of the particle in b.h. is defined in the framework of AdS/CFT correspondence) (G. ‘t Hooft, 1990), but not the correlations between outside states, which do not exist in thermal case. The decoherence of quantum superposition of outside states in low-energy limit is due to the contribution of gravitational field when background spacetime is considered, ref. (I. Pikovski, M. Zych, F. Costa and Č. Brukner, 2015).

^{1,1} proof of this statement utilizes formulas (2.3), (3.11) and (4.2) from Appendix B. The concluding results are represented by the following eqs. ($b \mapsto [1, n], b' \mapsto [n, m]$), i.e. correspondently orthogonal and non-orthogonal sets of the whole set $b \times b' \mapsto [1, m]$):

a) for density matrix:

$$\rho_{[1, m]} = \sum_{bb'} P_r^b P_r^{b'} = \rho_{[n, m]}^2 \quad (\text{A 5.2.2 a})$$

where,

the state of the particle in b.h.(non-observables) is described by the non-orthogonal set; the state of the outside particle (observable state, which is vacuum entangled with non-observable state) is described by the orthogonal set.

Thus the whole set, which represents ‘mix’ of these sets (‘mixed’ set) corresponds to the ‘mixed’ state.

According to the formula above, the unitarity is preserved due to the contribution of off-diagonal elements, which represent interactions and correlations between the outside virtual particle state and the state of the particle on the horizon.

b) for the trace of the density matrix:

$$\text{Tr}(\rho) = \sum_b |k_b^2| = 1 \quad (\text{A 5.2.2 b})$$

due to the normalization of the total probability.

² Under this framework, vacuum is represented as a self-consistent system comprised of a positive energy (b.h.) component and a negative energy (w.h.) component.

The vacuum fluctuations appear as a result of stochastic nature of equilibrium between these two components, which are interconnected by the mechanism of broken symmetry (ref. Chapter III, paragraph 1, note item 0.1).

Under the Dirac hole-theory notation, this system is represented as a zero band-gap structure with valence and conductivity bands formed by w.h. and b.h. correspondently.

At equilibrium this system is compensated (i.e. preserves a zero band-gap structure) and goes out of equilibrium due to the symmetry breaking, thus leading to the appearance of a non-zero band-gap.

2. 2. Soliton solutions^{note¹} (\exists exclusive principle).

Consider a certain physical system, i.e. :

i. area denoted by the Heisenberg uncertainty principle (5.2)

where,

$$\prec \Delta t \rightarrow \infty, \Delta E \rightarrow 0 \quad (\text{A 5.3})$$

this solution corresponds to the orbit structure;

the state of the inside and outside surfaces (as described in note to eq. (A 4.4)) reflects the homomorphism between the structure of the field, where the quantum mechanical description of the outermost part is given by quantum mechanics of non-observables (ref. Appendix B-Extensions Chapter), and connection with the innermost part which is given by eq. (A 4.4).

ii. Developed in the Appendix B-Extensions Chapter mechanism is an outline, which presents deriving of a well- defined particle trajectories^{note²} in the relation to the Nelson stochastic mechanics (E. Nelson, 1966), and directly related to the forming of such trajectories in the mechanism described by the crisis-induced intermittency (C. Grebogi, E. Ott, F. Romeiras and J.A. Yorke, 1987) in the case of the quadratic map (ref. to example: Pairwise merging of chaotic bands in period-doubling cascades).

p, p_m parameters and address to the forming of unstable orbits of period m .

note:

¹ given mathematical description of this solution in the framework of the soliton solution of (A 5.0.1).

² quantum (Bohmian) trajectories form the microscopic structures (i - shapes), i.e., a microscopic quantum state described by the wavefunction P_i , which comprise BE condensate (i.e., a macroscopic quantum state described by the wavefunction $P^{\text{superstate}}$). This wavefunction determines quantum potential of BE condensate.

Both wavefunctions mentioned above are defined in the section Appendix B-Extensions Chapter.

Creation of this macroscopic quantum state occurs as a result of free massless relativistic boson condensation moving in 3D and relates to the condensation condition $T < T_c$

(F. Zwicky, 1961; S. Fujita, T. Kimura and Y. Zheng, 1991), i.e., black-body radiation regime referenced in Appendix A4, paragraph 1.1, sub-item **iii**.

3. In the application to the exciton model for the Bose-Einstein condensate.

Consistence of a condensate can be represented by two types of component structures which comprise it, namely:

- i. bh-bf: black hole + baryonic foam;
- ii. wh-df: white hole + dark matter foam.

These two types of exciton-like structures comprise the BE condensate corresponding to:

1. Mark 2: in the form of ‘mixed’ state. Corresponds to Fig. 4, 1;

↳ case **i**), $\exists \phi_i$ is a part of ‘mixed’ state:

this type represents spacetime in the granulated form, i.e. inference structure Fig.1 collapses to a chain of mass parts as tunnel parts are reduced to zero.

ϕ_i confined to a surface of mass parts as \vec{r} granulated in a micro b.h. (mass part) and a baryonic foam (tunnel part).

Ref. Appendix A5, paragraph 2.1 ^{note}.

↳ case **ii**), $\neg \exists \phi_i$ as a part of ‘mixed’ state:

this type represents the granulated form, which consists of micro w.h. and a dark matter as a foam.

In this case Appendix A5, paragraph 2.1 can not be applied ϕ_i can not enter area of 3, **ii**.

2. Mark 4: in the form of ‘pure’ state, where condensate is shaken by EM.

Corresponds to Fig. 4, 2;

↳ case $\exists \phi_i$ is a part of ‘pure’ state:

this type represent continuous, smooth gravitational structure; ϕ_i localized to volume as \vec{r} is not granulated.

↳ Case $\neg \exists \phi_i$ is a part of ‘pure’ state:

this type represents a continuous, smooth dark matter structure; ϕ_i does not exists.

note:

in previous version of this document dated Aug. 27, 2009, the following is outlined:
there exists a possibility of tunneling near b.h. as a mechanism leading to the Hawking radiation (i.e. applicability of the Schwinger effect);
there exists an analogue b.h. laser-like structure, which appears as a result of quantum tunneling (Appendix A5, paragraph 2.1, sub-item **ii**; also, ref. experiment (J. Steinhauer, 2014)) with periodic boundary conditions.

The following conjectures on CP symmetry are related to inference topology:

a) As result of contact with a thermal bath ^{note}, provided that dark part does not interact with ϕ_i , the component structure bh-bf leads to:

1. Mass part is broken;
2. Tunnel part is unbroken.

b) As result of absence of contact with a thermal bath, provided that ϕ_i cannot enter the area, the component structure wh-df leads to:

1. Mass part is unbroken;
2. Tunnel part is broken.

↖ So the structure of the inference topology adheres to the CP symmetry and by dint of

the Landau-Yang theorem determines the hypothesis, which is due to postulates P1, P2.

↗ A micro b.h. (mass part) and a baryonic foam (tunnel part) corresponds to topological structure ref. Fig. 1 and represents positive energy.

The topological structure of micro w.h. and a dark matter as a foam corresponds to anti-structure ref. Fig. 1 and represents negative energy.

Cancellation of these two types of structures creates vacuum structure with vacuum state \mathcal{V} . Cancellation mechanism is analogous to the creation of cooper pairs in BCS theory, but in this case micro b.h.- micro w.h. components are bound by the exchange of dark bosons.

note:

Fig. 2 addresses the case of time-periodically driven by electromagnetic field in a ‘mixed’ state systems in weak contact with a thermal bath (in: D. Vorberg, W. Wustmann, R. Ketzmerick and A. André Eckardt, 2013).

4. Implication of quantum fluctuations.

Considering inference topology presented in Fig.1, then due to the second law of thermodynamics and as specified in paragraph 3.1, **i)** the following is obtained:

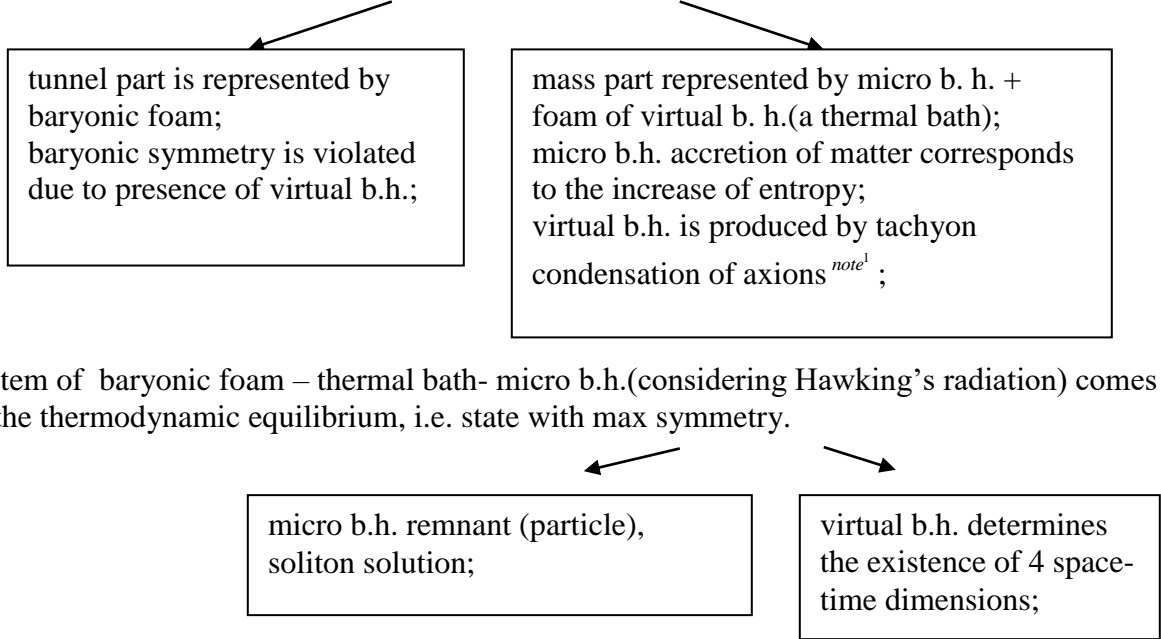

Fig. 8.1 The explanation of the value of mass acquired by gauge bosons.

1. As referenced in paragraph 1, item 1.2.2 the vector boson mass term is determined by $B_l B_l^* A_{ik} A_{ik}^*$ (ref. eq. (2.6.1 b)), where A_{ik} is defined in the following form eq. (A 2.1.0);

2. combined dark boson mass term (ref. paragraph 4, item 4.1.1) is determined by $-\frac{3}{8} B_l B_l^* C C^*$ (ref. eq. (2.6.1 b)), where C is in the following form eq. (A 2.1.2).

a) Mass term for the reversible ^{note²} ‘inference topology’ structure (dark ↔ gravitational, Fig. 8.3 below) is reduced to the vector boson mass term (as explained in paragraph 4, item 4.1.2, sub-item 2.3).

^{note:} (G.W.Fraser, et.al., 2014; C. Bonvin, R. Durrer and R. Maartens, 2014):

^{1,1} denotes experimental proof of axion existence;

^{1,2} the appearance of Dirac monopole (ref. Fig. 6, Mark 4) is determined by existence of primordial magnetic field, which also addresses the magnetic field in Primakoff effect.

² reversibility reflects geometrical equivalence between dark and gravitational sectors and mathematical symmetry between corresponding terms in Lagrangian eq. (2.6.1 b).

⌋ tensor-graviton (h -coupling) in the theory framework

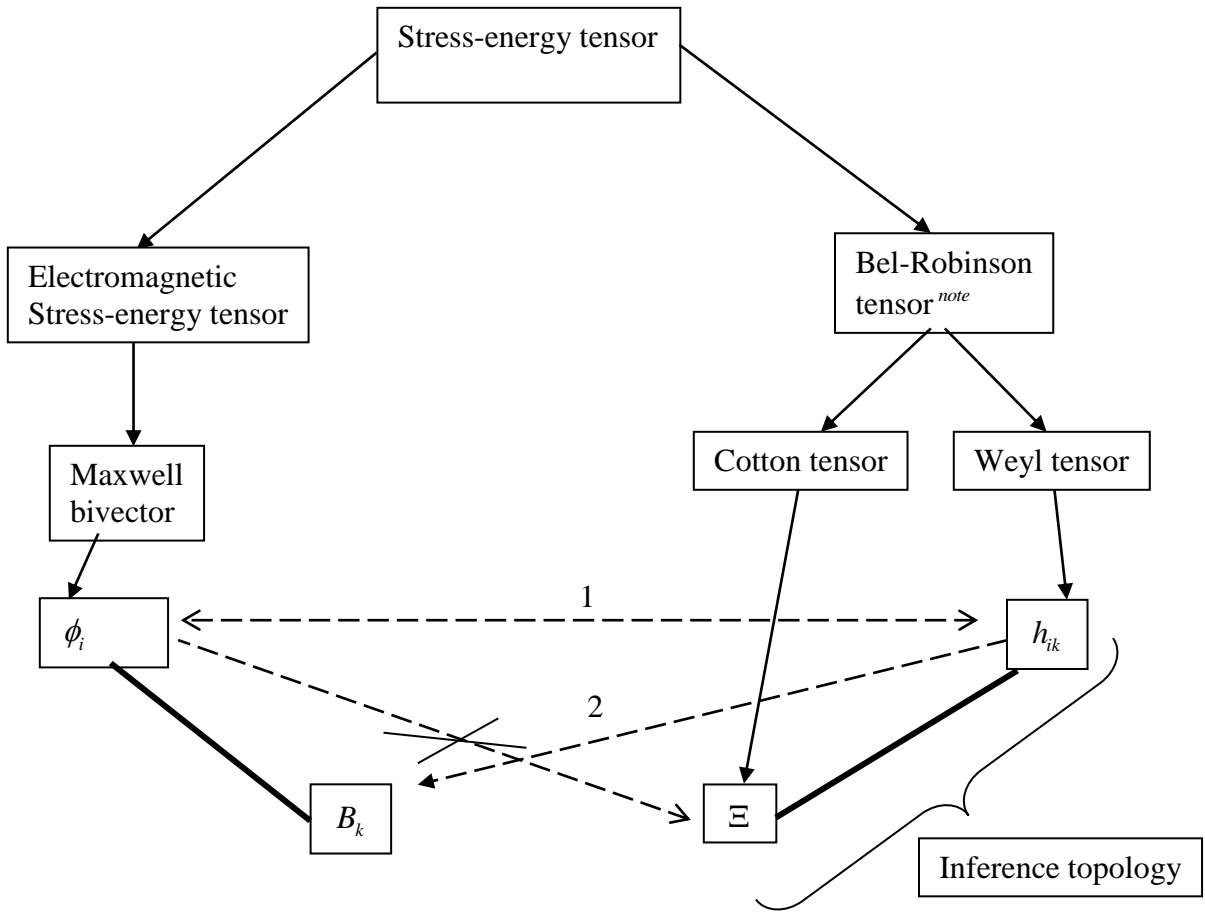

Fig. 8.2 Coupling due to h - tensor-graviton.

1-channel: \exists coupling between photon with gravitational field h_{ik} , there is no interaction between photon ϕ_i and dark sector Ξ .

2-channel: \exists coupling (due to tensor-graviton h) between gauge vector boson B_k and dark sector Ξ .

note:

For connection between Bel-Robinson tensor and gravitational energy-momentum (ref. Garecki, 1973).

Structure: WIMP - tensor-graviton ^{note¹}

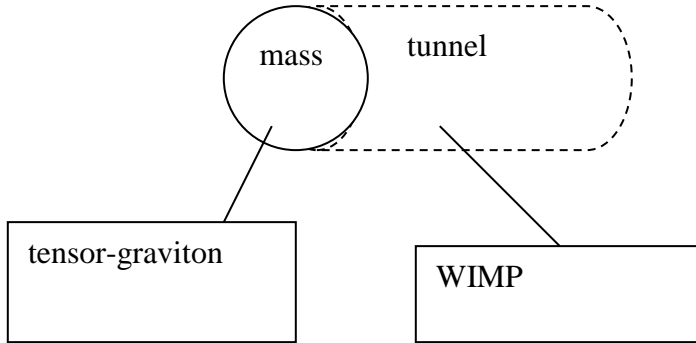

Fig. 8.3 Tensor-graviton (ref. Fig. 6 below, Mark 2, 4); WIMP (ref. Fig. 6, Mark 3).

WIMP (dark part \Leftrightarrow tunnel) interacts with baryonic matter by means of tensor-graviton (gravitational part \Leftrightarrow mass).

b) The value of dark energy ^{note²} is determined by the requirement to cancel local vacuum fluctuations (i.e. maintain thermodynamic equilibrium between the baryonic sector and the thermal bath).

note:

¹ tensor-graviton \Leftrightarrow 4-dim hyperkähler manifold (ref. Fig.1);
instanton is defined as vector bundle with self-dual connections on \mathbb{R}^4 .

² In case of $(\phi_i \neq 0)$, the value of dark energy is defined based on the conditions indicating equality between the baryonic sector's entropy constraint reduced to $4\pi nats$ on one side and the entropy of thermal bath – micro black hole (b.h.) system determined by eq. ((A 4.6), note 1) and (A 4.7) on another side.
Dark energy influence is incorporated explicitly into eq. (A 4.7) (for p_k : ref. A. Bassi, et.al., 2013) by means of replacing eq. (4.1, ref. Appendix B – Extensions Chapter)) with eq. denoting the forced NLSE (J. Eggers and M.A. Fontelos, 2015; part III) with the dark energy as driving force.

In case of $(\phi_i = 0)$ the value of dark energy (ref. paragraph 3, item 3.1, sub-item 2) is determined by eqs. (A 2.1 a)- (A 2.1 b).

Appendix A – Additions Chapter: Electrodynamics of thin (non-geometric case) layers.

An interzone radiation from plane-parallel plate due to direct-band-gap transitions is theoretically studied.

The plate thickness in one direction is less or of the order of the radiation wave length. The system of characteristic nodes for the radiation being emitted from such a plate is obtained.

It is shown that the radiation has strongly marked radiation peaks for resonance transmission.

1. Introduction and purpose.

Over prolonged periods the problem of investigation of cavity resonators radiation character for non-geometrical optics has been given a significant attention.

A sufficiently completed overview of investigations in this field is given in (H.P. Baltes and F.K. Kneubuhl, 1972), where different studies containing solutions in the form of infinite series with residual terms of different kinds are listed; also, the radiation of samples of different geometry is considered.

These results remain topical until present. As the appropriate review showed, the works published afterwards do not comprise any significant supplementary information.

The aim of this section is to obtain an analytically precise solution for the problem being discussed as applied to physical vacuum, which enables to appropriately take into account the properties of a plane-parallel plate as a resonator.

The solution for the problem in case of different geometries may be found in a similar way.

2. Plane-parallel plate modes.

a) The system of modes.

Transitions between two different states of a hole in the filled band under the secondary quantized radiation emission are represented by the Hamilton operator:

$$\hat{H} = -\frac{e}{2c} (\vec{\nabla}_{\vec{p}} \vec{A}^{\vec{r}} + \vec{A}^{\vec{r}} \vec{\nabla}_{\vec{p}}) \quad (1)$$

where,

$$\vec{A}^{\vec{r}} = \sum_{\nu} \sqrt{\frac{2\pi\hbar c^2}{\omega_{\nu} V}} \left(b_{\nu} \vec{a}_{\nu}^{\vec{r}} + b_{\nu}^{\dagger} \vec{a}_{\nu}^{\vec{r}*} \right) \quad (1a)$$

Here the denotations are as follows:

$\vec{\nabla}_{\vec{p}}$ - holes velocity operator; $\vec{A}^{\vec{r}}$ - secondary quantized vector potential; ω_{ν} - ν mode frequency; $b_{\nu}^{\dagger} |b_{\nu}|$ - Bose operator of creation (annihilation) for ν -mode; $\vec{a}_{\nu}^{\vec{r}}$ - describes the polarization characteristics and space structure for ν -mode; ν includes: μ - polarization index $|s, p|$. j -mode index $|r, l, L|$. \vec{q}_{\parallel} - longitudinal wave vector; the mode cross structure is determined by wave vectors –

continuous ones \vec{q}, \vec{q} for l, r modes, and discrete \vec{k} - for L mode;

r, l, L - right, left, and in-plate localized modes respectively; V - normalized volume.

As stated in (V.S. Pekar, 1974), the modes system for the medium with dielectric constant $\varepsilon^{\vec{r}}$ is derived from the following equations:

$$\text{rot rot } \vec{a}_{\nu}^{\vec{r}} - \left(\frac{\omega_{\nu}}{c} \right)^2 \varepsilon^{\vec{r}} \vec{a}_{\nu}^{\vec{r}} = 0 \quad (2)$$

$$\frac{1}{V} \int_{(v)} d\vec{r} \varepsilon^{\vec{r}} \vec{a}_{\nu}^{\vec{r}*} \vec{a}_{\nu}^{\vec{r}} = \delta_{\nu\nu} \quad (2a)$$

which should be solved separately for S -polarization $|\text{div } \vec{a}_{\nu}^{\vec{r}} = 0|$ and p - polarization $|\text{div } \vec{a}_{\nu}^{\vec{r}} \neq 0|$.

In a one-dimensional case with inhomogeneous conditions being under consideration ($\vec{r} = (\vec{\tau}, x)$, \vec{e}_x - normal to the plate) the solution for the system (2-2a) will be as follows:

$$\vec{a}_v^{\vec{r}} = \exp(i\vec{q}_{\parallel}\vec{\tau}) \left\{ \frac{[\vec{e}_x \times \vec{q}_{\parallel}]}{q_{\parallel}} a_{qx}^{v_s} + \left[\vec{e}_x a_{qx}^{v_p} + \frac{i\vec{q}_{\parallel}}{q_{\parallel}^2 \varepsilon^x} \frac{d}{dx} (\varepsilon^x a_{qx}^{v_p}) \right] \right\} \quad (3)$$

where the first item represents the solution for S -polarization, and the second and the third ones - for p -polarization.

Let us consider only S -type solutions for which the scalar functions $a_{qx}^{v_s}$ are derived from the following equations:

$$\frac{d^2 a_{qx}^{v_s}}{dx^2} + \left[\left(\frac{\omega_v}{c} \right)^2 \varepsilon^x - q_{\parallel}^2 \right] a_{qx}^{v_s} = 0 \quad (3a)$$

$$\frac{1}{L} \int_{(L)} dx \varepsilon^x a_{qx}^{v_s*} a_{qx}^{v_s'} = \delta_{v_s v_s'} \quad (3b)$$

where, L - normalized length in x - direction.

b) Mode structure.

For the piecewise-homogeneous medium, the wave equation is solvable for regions where $\varepsilon^x = const$. At jumps of ε^x the boundary conditions

$$\frac{da_{qx}}{dx} \Big|_{-0}^{+0} = 0, a_{qx} \Big|_{-0}^{+0} = 0 \quad (4)$$

are used.

In order to find all the constants of the wave equation for stratified medium, in addition to the boundary conditions (BC) at all the jumps of ε^x - , two BC's at $\pm\infty$ are needed.

Types of solutions:

r - and l - solutions: the amplitude of right-incident (r) or left-incident (l) wave is given i.e. two BC's are set at $+\infty$ or $-\infty$.

L - solutions: localized modes for which $a_{qx} \Big|_{-\infty}^{+\infty} = 0$.

\vec{a}_v^x is continuous at jumps of ε^x (i.e. a_{qx}^v and a_{qx}^p functions are continuous), but p - polarization-generated term $\frac{i}{q_{\parallel}\varepsilon^x} \frac{d}{dx} (\varepsilon^x a_{qx}^p)$ has a jump at the interface.

Since the system (2–2 a) is linear and homogeneous, one of the constants for L -solutions is not determined by BC and dispersion equation is obtained.

Let us consider three-layer medium case:

$$\varepsilon^x = \begin{cases} 1, x < 0 \\ \varepsilon^s, 0 < x < d \\ \varepsilon, d < x \end{cases} \quad (5)$$

Solutions for the system (3 a, b) are sought in the following form:

$$a_{qx} = \begin{cases} A_+ \exp(i\bar{q}x) + A_- \exp(-i\bar{q}x), x < 0 \\ a_+ \exp(ikx) + a_- \exp(-ikx), 0 < x < d \\ B_+ \exp(i\tilde{q}x) + B_- \exp(-i\tilde{q}x), d < x \end{cases} \quad (6)$$

where, wave vectors:

$$\left. \begin{aligned} \bar{q}^2 &= \left(\frac{\omega_v}{c}\right)^2 - q_{\parallel}^2 \\ k^2 &= \left(\frac{\omega_v}{c}\right)^2 \varepsilon^s - q_{\parallel}^2 \\ \tilde{q}^2 &= \left(\frac{\omega_v}{c}\right)^2 \varepsilon - q_{\parallel}^2 \end{aligned} \right\} \quad (6a)$$

Using (4) at jumps of ε^x will be obtained:

$$x=0 \quad (7a)$$

$$\left. \begin{aligned} A_+ + A_- &= a_+ + a_- \\ \bar{q}(A_+ - A_-) &= k(a_+ - a_-) \end{aligned} \right\}$$

$$x = d$$

$$a_+ \exp(ikd) + a_- \exp(-ikd) = B_+ \exp(i\tilde{q}d) + B_- \exp(-i\tilde{q}d) \quad (7b)$$

$$k[a_+ \exp(ikd) - a_- \exp(-ikd)] = \tilde{q}[B_+ \exp(i\tilde{q}d) - B_- \exp(-i\tilde{q}d)]$$

L -solution

System (7 a, b) takes the form:

$$\left. \begin{aligned} A &= a_+ + a_- \\ \bar{q}' A &= ik(a_+ - a_-) \\ B &= a_+ \exp(ikd) + a_- \exp(-ikd) \\ -\tilde{q}' B &= ik[a_+ \exp(ikd) - a_- \exp(-ikd)] \end{aligned} \right\} \quad (8)$$

where,

$$\left. \begin{aligned} \bar{q}' &= \sqrt{q_{\parallel}^2 - \left(\frac{\omega_v}{c}\right)^2} > 0 \\ \tilde{q}' &= \sqrt{q_{\parallel}^2 - \left(\frac{\omega_v}{c}\right)^2} \varepsilon > 0 \end{aligned} \right\} \quad (8a)$$

From (8) a system of two equations for a_+ , a_- solvability condition is obtained, which leads to the dispersion equation:

$$\begin{vmatrix} \bar{q}' - ik & \bar{q}' + ik \\ -(\tilde{q}' + ik)\exp(ikd) & -(\tilde{q}' - ik)\exp(-ikd) \end{vmatrix} = 0 \quad (9)$$

From (9) an expression for a discrete set of vectors \mathbf{k} can be obtained

$$-\frac{\bar{q}'\tilde{q}' - k^2}{k(\bar{q}' + \tilde{q}')} = \text{ctg } kd \quad (10)$$

When all the coefficients in (8) are expressed through a_+ , the following is obtained:

$$a_{qx} = a_L \begin{cases} \frac{2ik}{ik + \bar{q}} \exp(\bar{q}' x), & x < 0 \\ \exp(ikx) + \frac{ik - \bar{q}'}{ik + \bar{q}} \exp(-ikx), & 0 < x < d \\ \left[\exp(ikd) + \frac{ik - \bar{q}'}{ik + \bar{q}} \exp(-ikd) \right] \exp[-\tilde{q}'(x-d)], & d < x \end{cases} \quad (11)$$

where, $a_L \equiv a_+$.

l -solution

System (7 a, b) will take form:

$$\left. \begin{aligned} A_+ + A_- &= a_+ + a_- \\ \bar{q}(A_+ - A_-) &= k(a_+ - a_-) \\ a_+ \exp(ikd) + a_- \exp(-ikd) &= B_+ \exp(i\tilde{q}d) \\ k[a_+ \exp(ikd) - a_- \exp(-ikd)] &= \tilde{q}B_+ \exp(i\tilde{q}d) \end{aligned} \right\} \quad (12)$$

When all the coefficients in (12) are expressed through a_+ and a new normalization constant $a_l = a_+ \exp(ikd)$ is introduced, the following is obtained:

$$a_{qx} = a_l \left\{ \begin{array}{l} \left[(\bar{q} + k) \exp(-ikd) + (\bar{q} - k) \exp(ikd) \frac{k - \tilde{q}}{k + \tilde{q}} \right] \frac{\exp(i\bar{q}x)}{2\bar{q}} \\ + \left[(\bar{q} - k) \exp(-ikd) + (\bar{q} + k) \exp(ikd) \frac{k - \tilde{q}}{k + \tilde{q}} \right] \frac{\exp(-i\bar{q}x)}{2\bar{q}}, \quad x < 0 \\ \exp[ik(x-d)] + \frac{k - \tilde{q}}{k + \tilde{q}} \exp[-ik(x-d)], \quad 0 < x < d \\ \frac{2k}{k + \tilde{q}} \exp[i\tilde{q}(x-d)], \quad d < x \end{array} \right. \quad (13)$$

r -solution

System (7 a, b) will be:

$$\left. \begin{array}{l} A_- = a_+ + a_- \\ -\bar{q}A_- = k(a_+ - a_-) \\ a_+ \exp(ikd) + a_- \exp(-ikd) = B_+ \exp(i\tilde{q}d) + B_- \exp(-i\tilde{q}d) \\ k[a_+ \exp(ikd) - a_- \exp(-ikd)] = \tilde{q}[B_+ \exp(i\tilde{q}d) - B_- \exp(-i\tilde{q}d)] \end{array} \right\} \quad (14)$$

When all the coefficients in (14) are expressed through a_- , the following is obtained:

$$a_{qx} = a_r \begin{cases} \frac{2k}{k + \bar{q}} \exp(-i\bar{q}x), & x < 0 \\ \frac{k - \bar{q}}{k + \bar{q}} \exp(ikx) + \exp(-ikx), & 0 < x < d \\ \left[(\tilde{q} + k) \frac{k - \bar{q}}{k + \bar{q}} \exp(ikd) + (\tilde{q} - k) \exp(-ikd) \right] \frac{\exp[i\tilde{q}(x - d)]}{2\tilde{q}} \\ + \left[(\tilde{q} - k) \frac{k - \bar{q}}{k + \bar{q}} \exp(ikd) + (\tilde{q} + k) \exp(-ikd) \right] \frac{\exp[-i\tilde{q}(x - d)]}{2\tilde{q}}, & d < x \end{cases} \quad (15)$$

where, $a_r \equiv a_-$.

After substitution of expressions (11), (13), (15) into the normalization condition (3 b), the constants a_L, a_l, a_r are obtained respectively.

3. Equation for photon density one-particle matrix.

In the problem being considered, the interaction between holes and the photons emitted by the holes during the transition from the heavy to light part of the energy spectrum are assumed to be weak.

According to (V.G. Barjachtar and S.V. Peletminsky, 1963), stationary quantum kinetic equation for one-particle matrix for photon density will be:

$$i(\omega_{\nu'} - \omega_{\nu}) N_{\nu\nu'} = L_{\nu\nu'}^{(p)} \{N, f\} \quad (16)$$

where, $L_{\nu\nu'}^{(p)} \{N, f\}$ - collision operator.

Similarly, as presented in (F.T. Vasko, 1988), in case of great distances equation (16) is transformed, with respect to Wigner representation, in to the following form:

$$\mathbf{v}_\perp \frac{\partial N_{\vec{q}_\parallel}^{jj'}}{\partial x} = L_R^{(p)} \quad (17)$$

where, $L_R^{(p)}$ - relaxation mechanisms governing the process of photon attenuation beyond the d -layer (holes are localized within the layer, with thickness $d \ll q_\perp^{-1}$).

Boundary condition for equation (17) is:

$$\mathbf{v}_\perp N_{\vec{q}_\parallel}^{jj'}(q_\perp, x)|_0^d = L_{\vec{q}_\parallel, q_\perp}^{(p)jj'} \{f\} \quad (17a)$$

where, the expression for non-diagonal (with respect to index j) photon generation rate

$L_{\vec{q}_\parallel, q_\perp}^{(p)jj'} \{f\}$ presented using dipole approximation for matrix transition element has the following form:

$$L_{\vec{q}_\parallel, q_\perp}^{(p)jj'} \{f\} = \frac{(2\pi e)^2 \hbar}{\omega_q V \varepsilon^s} \sum_m \sum_{\vec{p}\vec{p}'} M_{q_\perp}^{jj'} \left(n\vec{p} \left| n' \vec{p}' \right. \right) f_{n\vec{p}} \left(1 - f_{n'\vec{p}'} \right) \delta \left(\varepsilon_{n'\vec{p}'} + \omega_q - \varepsilon_{n\vec{p}} \right), \quad (18)$$

$$M_{q_\perp}^{jj'} \left(n\vec{p} \left| n' \vec{p}' \right. \right) = \left(n\vec{p} \left| \frac{[\vec{e}_x \times \vec{q}_\parallel]}{q_\parallel} a_{q_\perp}^j \cdot \vec{v}_{\vec{p}} \right| n' \vec{p}' \right) \left(n\vec{p} \left| \frac{[\vec{e}_x \times \vec{q}_\parallel]}{q_\parallel} a_{q_\perp}^j \cdot \vec{v}_{\vec{p}} \right| n' \vec{p}' \right)^*$$

where, $\varepsilon_{n\vec{p}}, f_{n\vec{p}}$ - dispersion laws and distribution functions for light ($n=l$) and heavy ($n'=h$) holes respectively.

Given description for photon emission is applicable where conditions

$$x \gg q_{\perp}^{-1}, l_{ph-p} \gg q_{\perp}^{-1} \quad (19)$$

are satisfied (l_{ph-p} – photon relaxation length in case of on-hole scattering).

The left hand inequality is satisfied where photons are registered in the far-field zone, while the right hand inequality eliminates from consideration the term specifying on-hole photon relaxation.

4. Formula for far zone field energy.

Let us consider the secondary quantized operator for Poynting's vector in symmetrized form:

$$\hat{S} = i \left\{ \frac{c}{4\pi} \left[\hat{E} \times \hat{H} \right] - \frac{c}{4\pi} \left[\hat{H} \times \hat{E} \right] \right\} \quad (20)$$

The first term in (20) in view of (1 a) is re-presentable in the following form:

$$\hat{S}_{(1)} = -\frac{i\hbar}{4\pi} \sum_{\nu\nu'} \sqrt{\frac{\omega_{\nu'}}{\omega_{\nu}}} \left[\left(b_{\nu} \text{rot } \vec{a}_{\nu}^{\vec{r}} + b_{\nu}^+ \text{rot } \vec{a}_{\nu}^{\vec{r}*} \right) \times \left(b_{\nu'} \vec{a}_{\nu'}^{\vec{r}} - b_{\nu'}^+ \vec{a}_{\nu'}^{\vec{r}*} \right) \right] \quad (20a)$$

With a precision of the second order nonzero contribution (with respect to photon interaction) to the average value $\langle \hat{S} \rangle$ will be only from $\langle b_{\nu}^+ b_{\nu'} \rangle$ and $\langle b_{\nu} b_{\nu'}^+ \rangle$;

from (20 a) it is obtained:

$$\vec{S}_{(1)} = -\frac{i\hbar}{4\pi} \sum_{\nu\nu'} \sqrt{\frac{\omega_{\nu'}}{\omega_{\nu}}} \left\{ \left\langle b_{\nu}^+ b_{\nu'} \right\rangle \left[\text{rot } \vec{a}_{\nu}^{\vec{r}*} \times \vec{a}_{\nu'}^{\vec{r}} \right] - \left\langle b_{\nu} b_{\nu'}^+ \right\rangle \left[\text{rot } \vec{a}_{\nu}^{\vec{r}} \times \vec{a}_{\nu'}^{\vec{r}*} \right] \right\} \quad (21)$$

Similarly, examine the second term in (20);

thus, the following is obtained:

$$\vec{S}_{(2)} = -\frac{i\hbar}{4\pi} \sum_{\nu\nu'} \sqrt{\frac{\omega_{\nu'}}{\omega_{\nu}}} \left\{ -\left\langle b_{\nu}^+, b_{\nu'} \right\rangle \left[\vec{a}_{\nu'}^{\vec{r}*} \times \text{rot } \vec{a}_{\nu}^{\vec{r}} \right] + \left\langle b_{\nu} b_{\nu'}^+ \right\rangle \left[\vec{a}_{\nu}^{\vec{r}} \times \text{rot } \vec{a}_{\nu'}^{\vec{r}*} \right] \right\} \quad (22)$$

From (20) the average value for Poynting's vector operator in symmetrized form is obtained, which, when (21), (22) under approximation of photon mode macro occupancy (V.B. Berestetsky, E.M. Lifshyts and L.P. Pytayeovsky, 1989) is taken into account, will have the following form:

$$\vec{S} = \frac{\hbar}{2\pi} \sum_{\nu\nu'} \sqrt{\frac{\omega_{\nu'}}{\omega_{\nu}}} \left\{ \left\langle b_{\nu}^+ b_{\nu'} \right\rangle \left[\text{rot } \vec{a}_{\nu}^{\vec{r}*} \times \vec{a}_{\nu'}^{\vec{r}} \right] - \left\langle b_{\nu} b_{\nu'}^+ \right\rangle \left[\text{rot } \vec{a}_{\nu}^{\vec{r}} \times \vec{a}_{\nu'}^{\vec{r}*} \right] \right\} \quad (23)$$

Consider radiation in $x < 0$ area. Using (23) with respect to (6) (in which $A_+ = 0$ are set) and (17 a), the following is obtained:

$$\bar{S}^{(-)} = -\bar{e}_x \frac{\hbar}{2\pi v_{\perp}} \sum_{jj'} \sum_{\bar{q}} L^{(p)\bar{q}} \{f\} A_-^{j*} A_-^j \quad (24)$$

Using (13), (15) (L₋ mode is excluded for it attenuates beyond the plate), and (18), compute (24) for Lattinger's isotropic model (V.F. Hantmacher and I.B. Levinson, 1984). Then, the following is obtained:

$$\bar{S}^{(-)} = -\bar{e}_x \frac{3}{\sqrt{2\pi}} \frac{e^2 \eta_-^{\frac{5}{2}}}{V \hbar^2 v_{\perp} \epsilon^s m^2} \sin^2 \theta \sum_{\bar{q}} \omega_{\bar{q}}^2 \left\{ \left[k^2 (\bar{q} - \tilde{q})^2 + (k^2 - \bar{q}^2)(k^2 - \tilde{q}^2) \sin^2 kd \right] \frac{|a_l|^2}{\bar{q}^2 (k + \tilde{q})^2} + \frac{4k^2 |a_r|^2}{(k + \bar{q})^2} \right\}^2 \quad (25)$$

$$\left\{ \frac{\exp \left[\frac{\hbar \omega_{\bar{q}} \eta_-}{m_l} - \mu(T) \right]}{kT} + 1 \right\}^{-1} \left(1 - \left\{ \frac{\exp \left[\frac{\hbar \omega_{\bar{q}} \eta_-}{m_h} - \mu(T) \right]}{kT} + 1 \right\}^{-1} \right)$$

$$\text{where, } \theta = \hat{p}, \hat{p}', \frac{1}{m_l} - \frac{1}{m_h} = \frac{1}{\eta_-}$$

Using (25), it is obtained:

$$\phi S_n^{(-)} ds = \frac{3}{\sqrt{2\pi}} \frac{e^2 \eta_-^{\frac{5}{2}} s}{V \hbar^2 \nu_{\perp} \epsilon^s m^2} \sin^2 \theta$$

$$\sum_{\tilde{q}} \omega_{\tilde{q}}^{\frac{1}{2}} \left\{ \left[k^2 (\bar{q} - \tilde{q})^2 + (k^2 - \bar{q}^2)(k^2 - \tilde{q}^2) \sin^2 kd \right] \frac{|a_l|^2}{\bar{q}^2 (k + \tilde{q})^2} + \frac{4k^2 |a_r|^2}{(k + \bar{q})^2} \right\}^2 \quad (26)$$

$$\left(\frac{\exp \left[\frac{\hbar \omega_q \eta_-}{m_l} - \mu(T) \right]}{kT} + 1 \right)^{-1} \left(1 - \frac{\exp \left[\frac{\hbar \omega_q \eta_-}{m_h} - \mu(T) \right]}{kT} + 1 \right)^{-1}$$

Thus, the theoretical study of physical vacuum radiation for non-geometrical optics is conducted.

It is shown that the radiation is characterized by strongly marked peaks for resonance transmission as can be seen from (26).

Appendix B – Extensions Chapter: The quantum theory of non-observables.

This mathematical modeling can be considered primarily as a contribution to applications of quantum mechanics.

Consider many-objects interaction systems on sampling of a certain physical system. In this article presented is a general expression of the interaction Hamiltonian for pair interaction, which can be used in Schrödinger's equation and can be applied to any many-objects mathematical modeling. Consideration is given to a mathematical description of a model, which uses quantum mechanics formalism to determine the outcomes depicting an average of the non-observable measurements for i -th 'pure' state and the 'superposition' state.

Also calculated is the influence of perturbations on quantum states, and a specified condition for noise induced fluctuations.

A central problem of quantum mechanics is formulating a probabilistic model of the time evolution of quantum states measurements, allowing reliable predictions on their future deviation, when taking measurements of specified quantum mechanical value from its average value.

Theoretical and statistical analysis of data questions martingale model, i.e. the use of a random walk and more general martingale techniques to model behavior of quantum states measurements.

Measurements do not completely follow the random walk (a Winner process is the scaling limit of random walk in dimension 1) (R.N. Mantegna and H.E. Stanley, 2000), (D. Rickles, 2007). Noted model can be considered as approximation limit of the approach ^{note^o}, which is based on the Schrödinger equation (A. Khrennikov, 2006), (D. Dürr, S. Goldstein and N. Zanghi, 1992).

Such relation between the Brownian motion and the Schrödinger equation is specified by the Feynman-Kac formula (P.E. Kloeden and E. Platen, 1992).

In this article the presented quantum mechanics approach is also in references (W. Seagal and I.E. Seagal, 1998), (E. Nelson, 1966), (N.C. Petroni and M. Pusterla, 2009) which is based on a hidden analogy between modeling for the states of a certain physical system on one side, and the many-objects problem in quantum mechanics on the other.

The behavior of the i -th state in a certain physical system is affected by a certain physical system perturbations and other states. A certain physical system can be considered as a physical system (K. Ilinski, 2001), (P. Bak, S.F. Norrelykke and M. Shubik, 1999), which undergoes the same many- objects interactions, but with states in place of the bodies.

Using this analogy as the way to account for state -to- state interactions, and influence of different certain physical system perturbations on state, which have affected state and a certain physical system over time, a mathematical wavefunction formalism of quantum mechanics may be introduced.

The main goal is to introduce mathematical formalism for a wavefunction of a whole certain physical system $P^{\text{superstate}}$ and a specific i -th state in a certain physical system P_i . This approach allows to define time dependence for an average $\langle \rangle$ of non-observable measurements for i -th state q_i and a certain physical system q . Individual behavior of q_i and q related to the presented model used for forecasting various univariate GARCH-type time series properties in the conditional variance and an ARMA specification in the conditional mean (D. Wurtz, Y. Chalabi and Y. Luksan, 2002).

1. Perturbation theory.

A certain physical system can be viewed as a sum of two parts: a replication part and a replicable part. The replication part should consist of a min- number of states, which is sufficient to represent a certain physical system.

If wavefunction of a certain physical system is $P^{\text{superstate}}$ with wavefunctions of the replication part is P_r and the replicable part is P_r' (r -replication, r' -replicable), then, based on a superposition principle (A.S. Davidov,1976):

$$P^{\text{superstate}} = P_r + P_r' \quad (1.1)$$

will present as a linear approximation (such that accuracy of the approximation tends to improve as the number of the degenerate states gets smaller)

$$P^{\text{superstate}} = \sum_{i=1}^n P_r^i + \sum_{i=n+1}^m P_r'^i \quad (1.2)$$

wherein n represents a replication state and m represents all states in a given certain physical system i -state (state in a certain physical system).

According to (A.S. Davidov,1976) in the first term (1.2), the wavefunction P_r^i is multiplied by coefficients of expansion (any complex numbers, not depending on time), corresponding to the same state, and, analogically, in the second term (1.2) for $P_r'^i$ (scale invariant), therefore, expansion coefficients in (1.2) may be omitted:

$$P^{\text{superstate}} = \sum_{i=1}^n a_i P_r^i + \sum_{i=n+1}^m a_i P_r'^i$$

Consider the first term, replication part, as the ‘superposition’ state and the second term as the replicable part, as perturbation to the ‘superposition’ state, which is how all states in a certain physical system, not included into the first replication part, are affected by it. This is a standard consideration of perturbation theory (L.V. Keldysh, 1964).

note^{0: 1} Developed approach does not address the Bohmian wave modeling, up to the point of considering the guiding eq. in specified context [ref. note³ to eq. (B 17)] with the main focus on nonlocality and contribution of the electromagnetic field $\vec{\phi}$ (ref. note to eq. (A 4.4)). This consideration of the guiding eq. complements the description of wavefunction whose ^[1,1] value on the boundary is the same as the value on the opposite boundary (periodic boundary condition).

² Also (O.A. Choustova, 2007) distinguish between different studies from the perspective of relevancy to the aforementioned problem and to decouple from the consideration of other applications of quantum mechanics formalism for noted research, e.g. (E. Haven, 2003); or implementation of the path integral methods (B.E. Baaquie, 2004) within the framework of the developed formalism.

- Suitable criteria for the state to be entered in the replication or the replicable part correspondently.

Consider an orthonormal basis (S. Lang, 1984). When adapted to a certain physical system it requires determination of states, which forms a states system coordinate, in which all other states can be presented. Analogous to a mathematical system coordinate, this ‘superposition’ state must consist of orthogonal securities (not correlated). It is a matrix of orthogonal states, which will create this system and size of matrix - n from the equation (1.2) and will determine the ‘superposition’ state size.

Such system as a mathematical normal system will be independent. It will not necessarily be stable or self consistent all the time, because a certain physical system dynamics a certain physical system can frequently go out of equilibrium (F. Allen, S.C. Myers and R. A. Brealey, 2006).

2. Proposed model.

The general method of calculating a wavefunction of a normal (orthogonal) part –the ‘superposition’ state was described in Appendix B1. This method is based on eliminating a not-normal (non-orthogonal) part from the ‘superposition’ state.

Based on the foregoing, an approach to a certain physical system can be formulated as follows:

Lemma (2.1):

- Consider a certain physical system as a set of states, characterized by wavefunction P_i for i-th system state.
- Each wavefunction P_i represents a state from an orthogonal system (‘superposition’ state) or non-orthogonal system, which can be represented through expansion by use of ‘superposition’ state states.
- Wavefunction $P^{superstate}$ of a certain physical system at t comprise superposition of wavefunctions P_i for each system states in t .
- A dynamic of a system wavefunction $P^{superstate}$ is arrived at by superposition of dynamic (sum of dynamics) P_i wavefunctions for each of the system states.
- A dynamic of wavefunction P_i for i-th system state described by the Hamilton-Schrödinger equation.

- Representation of non-orthogonal input through an orthogonal system of states.

According to Appendix B1 it is possible to find a wavefunction of orthogonal part P_r , but a real system distorts at any given moment t out of equilibrium because of the contribution of a wavefunction of the non-orthogonal part P_r of the system.

To estimate a total contribution of P_r into $P^{superstate}$ in equation (1.1) uses form (1.2)

$$P_r = \sum_{i=n+1}^m P_r^i \quad (2.2)$$

where P_r^i is a wavefunction of an i -th state from a non-orthogonal part.

Can P_r^i express through wavefunctions of the i -th state from the ‘superposition’ state:

$$P_r^i = \sum_{b=1}^n k_b^i P_r^b \quad (2.3)$$

where k_b^i -expansion coefficient for wavefunction of the i -th state from the non-normal set P_r on orthogonal basis of wavefunctions for states from normal set P_r^b .

- Representation of a system dynamic.

Presented is a system as a combination of an equilibrium part, characterized by a normal system- the ‘superposition’ state and represented by the H_0 - orthogonal Hamiltonian:

$$\hat{H}_r P_r = \sum_{i=1}^n \hat{F}_r^i P_r^i \quad (2.4)$$

where F – operator of equilibrium system meaning orthogonal;

and a non-equilibrium part characterized by a non-normal system -other states are not included into the ‘superposition’ state (dependable on the ‘superposition’ state) and represented by the H_{int} - non-orthogonal Hamiltonian.

Dependable states play a role of getting the ‘superposition’ state out of equilibrium, so they play a role of an outside perturbation related to the ‘superposition’ state and can be presented as:

$$\hat{H}_r P_r = \sum_{i=n+1}^m \hat{F}_r^i P_r^i \quad (2.5)$$

where F_r - operator of a non-equilibrium system meaning a non-orthogonal.

Then total Hamiltonian is represented based on (1.2), (2.4) and (2.5) as

$$\hat{H} P = H_0 + H_{\text{int}} \quad (2.6)$$

where $H \left(\equiv \hat{H} P \right)$;

the operators F_r^i and F_r^i will depend on time t and P_r^i, P_r^i will not depend on time t (Heisenberg picture). Future consideration will be based on the Schrödinger picture, where F_r^i and F_r^i do not depend on time t , but P_r^i, P_r^i are time dependent.

3. Considering Hamiltonian.

Applying the following properties for the orthogonal part P_r^i and the non-orthogonal part P_r^i correspondently:

a) configuration-space of measurements for the orthogonal part $Q_+ = R_+^n$, R_+ -real set domain

$q = (q_1, \dots, q_n)$, where q_i is the measurement of i -th state on interval $i \in [1, \dots, n]$;

configuration-space of measurements for non-orthogonal part $Q_+ = R_+^{m-n}$,

$q = (q_{n+1}, \dots, q_m)$, where q_i is the measurement of i -th state on interval $i \in [n, \dots, m]$

where the whole set $Q^m = Q \times Q' (\equiv R^n \times R^{m-n})$, R -real set;

b) time t .

- Calculation of the respective contribution of the orthogonal and non-orthogonal parts.

Will represent operators of number of \hat{F}_r^i of the i -th orthogonal state in the form (operator \hat{F}_r^i is the operation of multiplication by m_i):

$$\hat{F}_r^i P_r^i = m_i P_r^i, \quad i \in [1, \dots, n] \quad (3.1)$$

m_i - number of degenerate of i -th state (orthogonal) on $i \in [1, \dots, n]$;

and correspondently:

\hat{F}_r^i - operators of number of the i -th non-orthogonal state,

m_i - number of degenerate of i -th state (non-orthogonal) on $i \in]n, \dots, m]$.

- Calculating a contribution of perturbations.

Into (2.6) H_{int} also include the system perturbations (mathematical perturbation as a weak disturbance to the system, etc), which contributes as an outside perturbation related to the ‘superposition’ state and can be presented in the following form:

$$H_i^{\text{int}}(q_1, \dots, q_n) \quad (3.2)$$

where $i \in [1, \dots, n]$, because do not have to take into account q properties of a non-orthogonal system, which can be represented through orthogonal states of the system characterized by properties q .

Consider configuration-space for sources of perturbation $\alpha = N^s$, N - normal set, then

$$\alpha = (\alpha_1, \dots, \alpha_s) \quad (3.3)$$

where α_l - l -th perturbation is defined on interval $l \in [1, \dots, s]$ and corresponds to perturbations (also ref. Appendix B13).

Allowing that perturbation and changing the measurement of i -th state independently (locally), affects each state of the system, represented in the following form:

$$\alpha_l H_i^{\text{int}}(q_1, \dots, q_n, \alpha_l) = \prod_{i \neq j=1}^n H_j^i(q_i, q_j) \alpha_l A_i^i(q_i, q_i) \quad (3.4)$$

where

first term - allows that changing of the measurement of an i -th state affects the behavior of a j -th state $i \neq j$ (non-local interaction);

second term- includes contribution of perturbations α_l and needs not contain a non-local interaction of states (i.e. local $i = j$).

- Representation of a non-factorized states interaction term.

Lemma (3.5):

a). For a non-local interaction, if there is any change in measurement, one state will affect measurements of all other agents of the system and represent a symmetric form:

$$H_j^i(q_i, q_j) = H_i^j(q_j, q_i) \quad (3.5.1)$$

which encompasses a symmetry property of H_j^i following from the invisibility of the i, j -th states on the complete space Q^m .

b). Perturbations, which do not contain interactions, can be represented in a bilinear form:

$$\alpha_l A_i^i(q_i, q_i) = \alpha_l A_i^i(q_i^2) \quad (3.5.2)$$

where

Hamiltonian has symmetric and bilinear properties to satisfy both of these property forms, must be a symmetric bilinear form, which is equivalent to a quadratic form, then obtains (3.5.2).

c). Form (3.5.2) must be real by definition and this property corresponds to a Hermitian form and a Hermitian form (symmetric sesquilinear form) is a sesquilinear form (S. Lang, 1984) on a complex vector space V is a map $V \times V \rightarrow \mathbb{C}$, a sesquilinear form generalizes to the Euclidian form:

$$H_j^i(q_i, q_j) = H_j^i(q_i q_j) \quad (3.5.3)$$

d). Because correspondence between quadratic forms on V and symmetric forms on V given by (over a ring where 2 invertible):

$$B(q_i, q_j) = \frac{1}{2} (Q(q_i + q_j) - Q(q_i) - Q(q_j)) \quad (3.5.4)$$

and on $V \times V \rightarrow \mathbb{C}$ can be presented by a wavefunction of an orthogonal part for the i -th state as (in a form according to Lemma (2.1, a)):

$$P_i(q_i) = e^{iq_i} \quad (3.6)$$

defined on the configuration-space of measurements Q_+ and satisfying conditions (a)-(d).

Then satisfying the Lemma (3.5.) obtained an interaction term between states $i \neq j$ in the following form:

$$\text{int } H_j^i(q_i, q_j) = m^i m_j e^{iq_i(-iq_j)} \quad (3.7)$$

$$\text{int } H_j^i(q_i, q_j) = m_j^i e^{q_i q_j}$$

influence of perturbations (mathematical perturbation as a weak disturbance to the system, etc) can present in the following form:

$$\alpha_l A_i^i(q_i, q_i) = \alpha_l m_i^{\alpha_l} m_i e^{(i \alpha_l q_i)^2} \quad (3.8)$$

$$\alpha_l A_i^i(q_i, q_i) = \alpha_l m_i^i e^{-\alpha_l q_i^2}$$

where

there are different perturbations to the interaction Hamiltonian $\in \alpha$ set (3.3) (independent or local). Substituting in (2.6) with (3.4), (3.7), (3.8) is computed as:

$$H = \sum_{i=1}^n m_i e^{iq_i} + \sum_{i=n+1}^m m_i e^{iq_i} + \prod_{l=1}^s \prod_{i=1}^n \prod_{i \neq j=1}^{j=n} m_j^i e^{q_i q_j} \alpha_l m_i^i e^{-\alpha_l q_i^2} \quad (3.9)$$

where $H_i \left(\equiv \hat{H} P_i \right)$ defined on set Q^m .

Substituting in (2.6) with (3.9) can present a system in terms of orthogonal states ('superposition' state):

$$\begin{aligned}
H = & \sum_{i=1}^n m_i e^{iq_i} + \\
& \sum_{i=n+1}^m \sum_{b=1}^n m_i \int_{R_+} P_r^i(y) P_r^{*b}(y) dy e^{iq_b} + \\
& \prod_{l=1}^s \prod_{i=1}^n \prod_{i \neq j=1}^{j=n} m_j^i e^{q_l q_j} \alpha_l m_i^i e^{-\alpha_l q_i^2}
\end{aligned} \tag{3.10}$$

the coefficients of the expansion in (2.3) of the wavefunction P_r^i by the normal orthogonal system of functions P_r^i determined by the formula (A.S. Davidov,1976):

$$k_b^i = \int_{R_+} P_r^i(y) P_r^{*b}(y) dy \tag{3.11}$$

Can represent H_{int} (third term) in (3.10) in the form:

$$H_{\text{int}} = \prod_{\lambda=1}^{n-1} \prod_{j=\lambda+1}^n m_j^{\lambda^2} e^{2 \sum_{\lambda=1}^{n-1} \sum_{j=\lambda+1}^n q_\lambda q_j} \prod_{l=1}^s \prod_{g=1}^n \alpha_l m_g^g e^{-\sum_{l=1}^s \sum_{g=1}^n \alpha_l q_g^2} \tag{3.12}$$

and after substitution (3.12) in (3.10) obtains:

$$\begin{aligned}
H = & \sum_{i=1}^n m_i e^{iq_i} + \\
& \sum_{i=n+1}^m \sum_{b=1}^n m_i \int_{R_+} P_r^i(y) P_r^{*b}(y) dy e^{iq_b} + \\
& \prod_{\lambda=1}^{n-1} \prod_{j=\lambda+1}^n m_j^{\lambda^2} e^{2 \sum_{\lambda=1}^{n-1} \sum_{j=\lambda+1}^n q_\lambda q_j} \prod_{l=1}^s \prod_{g=1}^n \alpha_l m_g^g e^{-\sum_{l=1}^s \sum_{g=1}^n \alpha_l q_g^2}
\end{aligned} \tag{3.13}$$

4. Hamilton-Schrödinger equation.

The dynamic of the i -th state wavefunction $P_i(q_i, t)$ is described by Hamiltonian equations in the form of the Schrödinger equation (T. Tao, 2014; A.R. Bishop, M.G. Forest, D.W. McLaughlin and E.A. Overman II, 1990):

$$ih \frac{\partial P_i(q_i, t; q_1, \dots, q_{i-1}, q_{i+1}, \dots, q_n, \alpha_l)}{\partial t} = H_i, \quad (4.1)$$

with initial condition $P_i(q_i, 0) = P_i(q_i)$,

where H represented by (3.13) and defined on set Q^m .

If know $P_i(q_i, 0)$ then using (4.1) can find the i -th state wavefunction dynamic (also ref. to Appendix B8):

$$P_i(q_i, t; q_1, \dots, q_{i-1}, q_{i+1}, \dots, q_n, \alpha_l) = e^{\frac{-itH_i}{\hbar}} P_i(q_i, 0) \quad (4.2)$$

$$P_i(q_i, t; q_1, \dots, q_{i-1}, q_{i+1}, \dots, q_n, \alpha_l) = e^{\frac{-itH_i}{\hbar}} e^{iq_i}$$

According to Lemma (2.1, d) the dynamic of a wavefunction for a certain physical system $P^{\text{superstate}}(q_1, \dots, q_n, t; \alpha_l)$ can be presented as a superposition (1.2) of the dynamic of wavefunctions for each state of the system $P_i(q_i, t; q_1, \dots, q_{i-1}, q_{i+1}, \dots, q_n, \alpha_l)$.

Applying solutions (4.2) of Hamilton-Schrödinger equation obtains:

$$P^{\text{superstate}}(q_1, \dots, q_n, t; \alpha_l) = \sum_{i=1}^n P_i(q_i, t; q_1, \dots, q_{i-1}, q_{i+1}, \dots, q_n, \alpha_l) = \sum_{i=1}^n e^{\frac{-itH_i}{\hbar}} P_i(q_i, 0) \quad (4.3)$$

- Consider the application of the Hamiltonian for Schrödinger equation in the form of degree $n=2$.

Applying equation (3.13) to (4.1) obtains:

$$ih \frac{\partial P_i(q_i, t; q_1, \dots, q_{i-1}, q_{i+1}, \dots, q_n, \alpha_l)}{\partial t} = H_0(q_i) + \alpha_l H_i^{\text{int}}(q_i; q_1, \dots, q_{i-1}, q_{i+1}, \dots, q_n, \alpha_l) \quad (4.4)$$

For first state (4.4) with third term in equation (3.13) in the form of degree $n=2$ (simple case interaction only with second state) ^{note1}:

$$ih \frac{\partial P_1(q_1, t; q_2, \alpha_1)}{\partial t} = H_0(q_1) + \alpha_1 H_1^{\text{int}}(q_1; q_2, \alpha_1) \quad (4.5)$$

Let $l=1$, then from (4.4) obtains:

$$ih \frac{\partial P_1(q_1, t; q_2, \alpha_1)}{\partial t} = m_1 e^{iq_1} + \alpha_1 H_1^{\text{int}}(q_1; q_2, \alpha_1) \quad (4.6)$$

where

$$\alpha_1 H_1^{\text{int}}(q_1; q_2, \alpha_1) = m_2^{1^2} e^{2q_1 q_2} \alpha_1 m_1^1 \alpha_1 m_2^2 e^{-\left(\alpha_1 q_1^2 + \alpha_1 q_2^2\right)};$$

$$m_2^1 = m^1 m_2, \alpha_1 m_1^1 = \alpha_1 m_1 \alpha_1 m_1, \alpha_1 m_2^2 = \alpha_1 m_2 \alpha_1 m_2.$$

From equations (4.2) and (4.6), obtain a Hamilton-Schrödinger dynamic for a wavefunction of the first state in the form:

$$P_1(q_1, t; q_2, \alpha_1) = e^{\frac{-itH_1}{h}} P_1(q_1, 0) \quad (4.7)$$

where

$$H_1 = m_1 e^{iq_1} + m_2^{1^2} e^{2q_1 q_2} \alpha_1 m_1^1 \alpha_1 m_2^2 e^{-\left(\alpha_1 q_1^2 + \alpha_1 q_2^2\right)}$$

Analogically for the second state (4.4) with the third term in the equation (3.13) in the form of the degree n=2 (simple case interaction only with the first state):

$$ih \frac{\partial P_2(q_2, t; q_1, \alpha_1)}{\partial t} = H_0(q_2) + \alpha_1 H_2^{\text{int}}(q_2; q_1, \alpha_1) \quad (4.8)$$

Let $l=1$, then from (4.4) obtains:

$$ih \frac{\partial P_2(q_2, t; q_1, \alpha_1)}{\partial t} = m_2 e^{iq_2} + \alpha_1 H_2^{\text{int}}(q_2; q_1, \alpha_1) \quad (4.9)$$

where

$$\alpha_1 H_2^{\text{int}}(q_2; q_1, \alpha_1) = m_2^{1^2} e^{2q_1 q_2} \alpha_1 m_1^1 \alpha_1 m_2^2 e^{-\left(\alpha_1 q_1^2 + \alpha_1 q_2^2\right)}$$

From equations (4.2) and (4.9), obtain a Hamilton-Schrödinger dynamic for a wavefunction of the second state in the form:

$$P_2(q_2, t; q_1, \alpha_1) = e^{\frac{-itH_2}{h}} P_2(q_2, 0) \quad (4.10)$$

where

$$H_2 = m_2 e^{iq_2} + m_2^{1^2} e^{2q_1 q_2} \alpha_1 m_1^1 \alpha_1 m_2^2 e^{-\left(\alpha_1 q_1^2 + \alpha_1 q_2^2\right)}$$

Follow (4.3) applying (4.7) and (4.10):

$$P^{\text{superstate}}(q_1, q_2, t; \alpha_1) = P_1(q_1, t; q_2, \alpha_1) + P_2(q_2, t; q_1, \alpha_1) \quad (4.11)$$

obtains:

$$P^{superstate}(q_1, q_2, t; \alpha_1) = e^{\frac{-it\alpha_1 H_1^{int}}{h}} \left[P_1(q_1, 0) e^{\frac{-it m_1 e^i q_1}{h}} + P_2(q_2, 0) e^{\frac{-it m_2 e^i q_2}{h}} \right] \quad (4.12)$$

and ${}^{\alpha_1} H_2^{int}(q_2; q_1, \alpha_1) \equiv {}^{\alpha_1} H_1^{int}(q_1; q_2, \alpha_1)$ can represent in the form:

$${}^{\alpha_1} H_1^{int}(q_1; q_2, \alpha_1) = m_2^2 e^{2(q_1 q_2 - {}^{\alpha_1} q_1 {}^{\alpha_1} q_2)} {}^{\alpha_1} m_1^1 {}^{\alpha_1} m_2^2 e^{-\left({}^{\alpha_1} q_1 - {}^{\alpha_1} q_2\right)^2}$$

$\left| {}^{\alpha_1} q_1 - {}^{\alpha_1} q_2 \right|$ is spread;

$\left| q_1 q_2 - {}^{\alpha_1} q_1 {}^{\alpha_1} q_2 \right|$ is the most important factor of measurements in different frames of reference of specified quantum mechanical value and is determined by the contribution of the perturbations.

Individual outcomes of the measurements for the i -th state q_i and a certain physical system q are purely statistical (O.A. Choustova, 2007).

In the Schrödinger picture use quantum-like formalism to determine the outcomes (time dependence) for an average $\langle \rangle$ of non-observable q_i and q , (A.S. Davidov, 1976):

$$\langle q_i \rangle_{\alpha_l} = \int P_i^* (q_i, t; q_1, \dots, q_{i-1}, q_{i+1}, \dots, q_n, \alpha_l) q_i P_i (q_i, t; q_1, \dots, q_{i-1}, q_{i+1}, \dots, q_n, \alpha_l) d(q_1, \dots, q_{i-1}, q_{i+1}, \dots, q_n) \quad (4.13)$$

where $q_i \rightarrow {}^0 q_i, \alpha_l = 0$; $q_i \rightarrow {}^{\alpha_l} q_i, \alpha_l \neq 0$; $l \in [1, \dots, s]$;

$$\langle q \rangle_{\alpha_l} = \int_{Q^n} P^{superstate*} (q_1, \dots, q_n, t; \alpha_l) q P^{superstate} (q_1, \dots, q_n, t; \alpha_l) d(q_1, \dots, q_n) \quad (4.14)$$

(also ref. to Appendix B10).

note!

In general, in case of the ‘superposition’ state:

$$m(t) = \frac{1}{n} \sum_{i=1}^n m_i(t) ; q(t) = \frac{1}{n} \sum_{i=1}^n q_i(t)$$

5. Predicting future values in time series.

1. Consider stochastic process with a state space q , i.e. stochastic process F is a collection

$$\{F_t : t \in T\}$$

where each F_t is q -valued random variable ($(F_{t_1}, F_{t_2}, \dots, F_{t_k})$ is random variable taking values in q_k).

Let F be an q -valued stochastic process, such that

$$(F \equiv) F(\mu, \sigma_t^2) \quad (5.1)$$

1.1) This process includes random shocks, which is represented by perturbations, thus these shocks can propagate to future values of the time series.

2. Follow finite mixture ARMA heteroskedastic model approach for nonlinear modeling

2.1) without assumptions:

a) independent identically-distributed random variables (i.i.d.); normally distributed data;

b) mean $E(q_t)$ is identical for all values of t .

2.2) incorporate conditional heteroskedasticity, which can be attributed (G.C. Lamoureux and W.D. Lastrapes, 1990) to a time dependence in the rate of information arrival to the system.

ARMA(p, l) with μ_t and σ_t^2 incorporated correspondently in (B 3), (B 8)

attn. Appendix B10:

$$q_t = \mu_t + F_t + \sum_{i=1}^p \varphi_i q_{t-i} + \sum_{i=1}^l \theta_i F_{t-i} \quad (5.2)$$

where $\varphi_1, \dots, \varphi_p$ (for AR); $\theta_1, \dots, \theta_l$ (for MA) are parameters of the model; F_t (for CH) denote the error terms σ_t^2 -defined, that is not an ARCH approximation.

- The derivation of equation for a model with input $F(\mu, \sigma_t^2)$.

1. Referring to (5.2), then simulating a random vector approach, which reduces $F(\mu, \sigma_t^2)$ to a white random vector ε_t :

$$F = \aleph \varepsilon_t + \mu \quad (5.2.1)$$

where

$$\aleph = E\Lambda^{\frac{1}{2}},$$

E, Λ is related to a diagonalization of a covariance matrix $\text{cov}(F)$ (for the calculation of E, Λ refer to Appendix B11);

$\varepsilon_t \sim f(\mu, \sigma_t^2)$ i.e., incorporate heteroskedasticity, ref. 2.2; where f is not a normal distribution.

Multiplying (5.2) by q_{t-m} and taking expected value yields:

$$E[q_t q_{t-m}] = \mu_t E[q_{t-m}] + E[F_t q_{t-m}] + \sum_{i=1}^p \varphi_i E[q_{t-i} q_{t-m}] + \sum_{i=1}^q \theta_i E[F_{t-i} q_{t-m}] \quad (5.2.2)$$

Calculate separately each term in (5.2.2):

$$E[q_{t-m}] = \mu_t \delta_m;$$

$$E[F_t q_{t-m}] = E[(\aleph \varepsilon_t + \mu) q_{t-m}] = \aleph \sigma_t^2 \delta_m + \mu_t \mu \delta_m;$$

$$\sum_{i=1}^p \varphi_i E[q_{t-i} q_{t-m}] = \sum_{i=1}^p \varphi_i \gamma_{m-i},$$

where autocorrelation function of q

$$\gamma_m = E[q_t q_{t-m}];$$

$$\sum_{i=1}^l \theta_i E[F_{t-i} q_{t-m}] = \sum_{i=1}^l \theta_i E[(\aleph \varepsilon_{t-i} + \mu) q_{t-m}] = \aleph \sigma_t^2 \theta_m + \mu_t \mu \delta_m \sum_{i=1}^l \theta_i;$$

Then can present (5.2.2) in the form:

$$\gamma_m = 2\mu_t \mu \delta_m + \aleph \sigma_t^2 \delta_m + \sum_{i=1}^p \varphi_i \gamma_{m-i} + \aleph \sigma_t^2 \theta_m + \mu_t \mu \delta_m \sum_{i=1}^l \theta_i \quad (5.3)$$

For an AR model, modified Yule-Walker equations (R. Prado and M. West, 2010) provide a fit. From (5.3) obtains:

$$\gamma_m = \sum_{i=1}^p \varphi_i \gamma_{m-i} + \aleph \sigma_t^2 \delta_m + \mu_t \mu \delta_m \quad (5.4)$$

for $m \geq 0$.

For $m < 0$:

$$\gamma_{-m} = \sum_{i=1}^p \varphi_i \gamma_{|m|-i} + \aleph \sigma_t^2 \delta_m + \mu_t \mu \delta_m \quad (5.4.1)$$

For $m > 0$:

$$\begin{bmatrix} \gamma_1 \\ \gamma_2 \\ \vdots \end{bmatrix} = \begin{bmatrix} \gamma_0 & \gamma_{-1} & \gamma_{-2} & \cdots \\ \gamma_1 & \gamma_0 & \gamma_{-1} & \cdots \\ & & \ddots & \\ \vdots & & & \end{bmatrix} \begin{bmatrix} \varphi_1 \\ \varphi_2 \\ \vdots \end{bmatrix}$$

solving all φ .

For $m = 0$:

$$\gamma_0 = \sum_{k=1}^p \varphi_k \gamma_{-k} + \aleph \sigma_t^2 + \mu_t \mu \quad (5.4.2)$$

solving μ .

2. Follow the two-stage LSM (N. Sandgren and P. Stoica,2006) calculate F_t in the form:

$$F_t = \Phi(B)q_t \quad (5.5)$$

where

$$\Phi(B) = 1 + \sum_{i=1}^p \varphi_i B^i \quad (5.5.1)$$

B -backshift operator;

$$F_t = \sum \varepsilon_t \quad (5.5.2)$$

solving ε_t ;

than obtains:

$$q_t - F_t \approx [\theta_1 \dots \theta_l] \begin{bmatrix} F_{t-1} \\ \vdots \\ F_{t-l} \end{bmatrix} \quad (5.6)$$

solving all θ .

The model order p selected via the Akaike's information criterion; $p = 2l$.

6. Summary.

In this Appendix B - Extensions Chapter the model for predicting future values in time series is presented.

Using parallelism (E. Nelson, 1966) between stochastic approach and quantum mechanics a Schrödinger equation can be applied to incorporate complicated behavior of a certain physical system, which is considered as many- objects interaction system.

Within the model framework obtained is the theoretical expression in lower limit

approximation ($\alpha_1 = 1, l = 1$) and ${}^{\alpha_1}H_i^{\text{int}}$ in the form of degree $n=2$

for an average $\langle \rangle$ of non-observable q and a standard deviation σ of q , which specifies how the actual value (final measurement) is dispersed from the average value (mean final measurement) attn. Appendix B10 and incorporates heteroskedasticity features.

1. Introduced is the corresponding stochastic process to model stochastic behavior of the system.

As a result, the formulation of the stochastic process $F(\mu, \sigma_i^2)$ underlying the model incorporates the behavior of a certain physical systems through the Hamiltonian of the Schrödinger equation.

This process represents an input of the model and is not restricted by the i.i.d. assumption and is related to the correlated, non-normally distributed data.

2. Obtained an expression for conditional mean of measurement of i -th state, which depends on time, meaning it allows for non-stationarity.

3. Calculated an expression for conditional variance of measurement of i -th state, which depends on time, meaning it incorporates heteroskedasticity.

4. Shocks (perturbations) are assumed to be uncorrelated, but not necessarily i.i.d. conditioned. Calculated influence of shocks on states behavior.

5. Specified condition for measurements in different frames of reference of a specified quantum mechanical value.

6. Noted applicable time interval for the model.

7. Obtained expression for standard deviation of measurement can be considered as a 'signal' for noting fleeting moves in states behavior.

7. Expression for a normalized wavefunction.

Normalization condition for the wavefunction of the first state considering that the integral diverges (A.P. Prudnikov, Yu.A. Brychkov and O.I. Marichev, 1986)

$$\int_0^{\infty} e^{\frac{2tm_1 \sin q_1}{h}} dq_1 \rightarrow \infty \quad (\text{B 0.1})$$

i.e. $P_1(q_1, t; q_2, \alpha_1)$ is not square-integrable can present in the form:

$$\Upsilon_{q_1 \in q_1^0 : q_1^0 + n2\pi} (t) \propto \int_{q_1^0}^{q_1^0 + n2\pi} e^{\frac{2tm_1 \sin q_1}{h}} dq_1 = n2\pi \mathbf{J}_0\left(\frac{i2tm_1}{h}\right), \quad n \in N \quad (\text{B 0.2})$$

only on the interval $q_1 \in [q_1^0, q_1^0 + n2\pi]$, the Υ - probability is defined on the interval \mathbf{q}_1 .

The integral is defined on the space $L_2(Q)$ where Q is the configuration measurement space $Q \subset R^n_+$, let denote map

$$L_2[q_1^0, q_1^0 + k\Delta q] \rightarrow L_2[q_1^0, q_1^0 + n2\pi], \quad n \in N, k \in R^n_+$$

then

$$\Upsilon_{q_1 \in q_1^0 : q_1^0 + k\Delta q} (t) \propto \int_{q_1^0}^{q_1^0 + k\Delta q} e^{\frac{2tm_1 \sin q_1}{h}} dq_1 = k\Delta q \mathbf{J}_0\left(\frac{i2tm_1}{h}\right), \quad n=1 \quad (\text{B 0.2.1})$$

Transition from the equation (B 0.1) to (B 0.2) means that on the interval \mathbf{q}_1 a continuous spectrum can be approximated as discrete, so the wavefunction can be normalized, then can represent a normalized wavefunction of the first state in the form:

$$\Psi_1(q_1, t; q_2, \alpha_1) = \frac{1}{N} P_1(q_1, t; q_2, \alpha_1) \quad (\text{B 0.3})$$

where N^2 - the norm of the wavefunction $P_1(q_1, t; q_2, \alpha_1)$.

Equation (B 0.2) satisfies a condition on the $t_0 \in \mathbf{t}$ -interval;

from the outcome of the measurement for the first state $q_1(t)$ at t_0 defined as $q_1 : t \rightarrow q_1$ can obtain:

$$q_1^0 = q_1(t_0) \Rightarrow t_0 = q_1^{-1}(q_1^0)$$

where q_1^{-1} - inverse function of $q_1(t)$ on the interval $\mathbf{q}_1(q_1^0 \in q_1)$, $t_0 \leftrightarrow q_1^0$ and bijective on the domain \mathbf{t} and the codomain \mathbf{q}_1 if considered for one exchange;

then can represent (B 0.2) in the form:

$$\Upsilon_{q_1 \in q_1^0 : q_1^0 + 2\pi}(t_0) \propto 2\pi \mathbf{J}_0\left(\frac{i2t_0 m_1}{h}\right) = 2\pi \mathbf{J}_0\left(\frac{i2q_1^{-1}(q_1^0) m_1}{h}\right) = N^2 \quad (\text{B 0.4.1})$$

Consider (B 0.2) in the small vicinity of $q_1^0 (n=1)$, then

$$|q_1 - q_1^0| < k\Delta q = 2\pi$$

and from (B 0.4.1) obtains:

$$\Upsilon_{q_1 \in q_1^0 : q_1^0 + k\Delta q}(t_0) \propto k\Delta q \mathbf{J}_0\left(\frac{i2t_0 m_1}{h}\right) = k\Delta q \mathbf{I}_0\left(\frac{2q_1^{-1}(q_1^0) m_1}{h}\right) \quad (\text{B 0.4.2})$$

Considering (B 0.4.2), a normalized wavefunction (has a unit norm) of the first state is computed as:

$$\Psi_1(q_1, t; q_2, \alpha_1) = \frac{1}{\sqrt{k\Delta q \mathbf{I}_0\left(\frac{2q_1^{-1}(q_1^0) m_1}{h}\right)}} P_1(q_1, t; q_2, \alpha_1) \quad (\text{B 0.5})$$

and is defined on the interval \mathbf{q}_1 .

8. Constant \hbar in eq. (4.1).

Ref. (A.S. Davidov,1976) if associate fields $\phi_i(t)$ in classical field theory with a measurement of the state $q_i(t)$, then transition from the classical to the quantum field theory is provided by interpreting conjugate variables, i.e. $q_i(t)$ and its conjugate $\dot{q}_i(t)$ as subjected to the canonical commutation relations

$$\left[q_i(t), \dot{q}_j(t) \right] = i\hbar\delta(i-j) \quad (\text{B 0.6})$$

where

i, j indexes of states;

so \hbar is const in commutator for the measurement and measurement time derivative of the state.

9. Expression for an average of non-observable measurement.

In explicit form, the average of non-observable measurement of the first state q_1 , in fixed state

$P_1(q_1, t; q_2, \alpha_1)$ is computed as:

$$\langle q_1 \rangle = \frac{1}{k\Delta q_1^0 \left(\frac{2q_1^{-1}(q_1^0)m_1}{\hbar} \right)} \int_0^\infty e^{\frac{2tm_1 \sin q_1}{\hbar}} q_1 dq_1 \quad (\text{B 1})$$

where $q_1 \in]0, \infty[$,

tm_1 - tuning parameter for the system (refer to the linear approximation in (1.1)).

Considering that the integral diverges, i.e. can only be computed on the interval, $q_1 \in [0, n\pi]$ obtains:

$$\left\langle q_1 \right\rangle_{q_1 \in 0:n\pi} = \frac{1}{k\Delta q \mathbf{1}_0 \left(\frac{2q_1^{-1}(q_1^0)m_1}{h} \right)} \int_0^{0+n\pi} e^{\frac{2tm_1 \sin q_1}{h}} q_1 dq_1 \quad (\text{B 2})$$

let denote map

$$L_2[0, l\Delta q] \rightarrow L_2[0, n\pi], \quad n \in N, l \in R^+_+$$

Consider (B 2) in the small vicinity of q_1 ($n=1$), then

$$|q_1| < l\Delta q = \pi$$

and from (B 2) obtains

$$\left\langle q_1 \right\rangle_{q_1 \in 0:l\Delta q} = \frac{1}{k\Delta q \mathbf{1}_0 \left(\frac{2q_1^{-1}(q_1^0)m_1}{h} \right)} \int_0^{0+l\Delta q} e^{\frac{2tm_1 \sin q_1}{h}} \sin q_1 dq_1, \quad n=1 \quad (\text{B 2 a})$$

Can represent (B 2 a) in the form:

$$\left\langle q_1 \right\rangle_{q_1 \in 0:l\Delta q} = - \frac{1}{k\Delta q \mathbf{1}_0 \left(\frac{2q_1^{-1}(q_1^0)m_1}{h} \right)} \int_{\frac{\pi}{2}}^{\frac{\pi}{2}+l\Delta q} e^{\frac{-2tm_1 \cos q_1}{h}} \cos q_1 dq_1 \quad (\text{B 2.1})$$

and from (B.2.1) obtains:

$$\left\langle q_1 \right\rangle_{q_1 \in 0:l\Delta q} = -\frac{1}{k\Delta q \mathbf{l}_0 \left(\frac{2q_1^{-1}(q_1^0)m_1}{h} \right)} i l \Delta q \mathbf{J}_1 \left(\frac{i2tm_1}{h} \right) \quad (\text{B 2.1 a})$$

Can present in the form:

$$\left\langle q_1 \right\rangle_{q_1 \in 0:l\Delta q} = \frac{1}{k\Delta q \mathbf{l}_0 \left(\frac{2q_1^{-1}(q_1^0)m_1}{h} \right)} l \Delta q \mathbf{l}_1 \left(\frac{2tm_1}{h} \right) \quad (\text{B 3})$$

10. Expression for standard deviation of measurement.

Uncertainty of measurement q_i in the fixed state $P_i(q_i, t; q_1, \dots, q_{i-1}, q_{i+1}, \dots, q_n, \alpha_l)$ is expressed as:

$$\begin{aligned} \sigma_{P_i}^2(q_i) &= \langle q_i^2 \rangle - \langle q_i \rangle^2 = \\ & \left(q_i^2 P_i(q_i, t; q_1, \dots, q_{i-1}, q_{i+1}, \dots, q_n, \alpha_l), P_i(q_i, t; q_1, \dots, q_{i-1}, q_{i+1}, \dots, q_n, \alpha_l) \right) \\ & - \left(q_i P_i(q_i, t; q_1, \dots, q_{i-1}, q_{i+1}, \dots, q_n, \alpha_l), P_i(q_i, t; q_1, \dots, q_{i-1}, q_{i+1}, \dots, q_n, \alpha_l) \right)^2 \end{aligned} \quad (\text{B 4})$$

For the first state q_1 in the fixed state $P_1(q_1, t; q_2, \alpha_1)$ obtains (in Schrödinger picture):

$$\begin{aligned} \sigma_{P_1}^2(q_1) &= \langle q_1^2 \rangle - \langle q_1 \rangle^2 = \\ & \left(q_1^2 P_1(q_1, t; q_2, \alpha_1), P_1(q_1, t; q_2, \alpha_1) \right) \\ & - \left(q_1 P_1(q_1, t; q_2, \alpha_1), P_1(q_1, t; q_2, \alpha_1) \right)^2 \end{aligned} \quad (\text{B 4 a})$$

Let's compute a standard deviation for the first state q_1 in the fixed state $P_1(q_1, t; q_2, \alpha_1)$, calculate each term in (B 4 a) separately:

$$\langle q_1^2 \rangle = \frac{1}{k\Delta q \mathbf{1}_0 \left(\frac{2q_1^{-1}(q_1^0)m_1}{h} \right)} \int_0^\infty e^{\frac{2tm_1 \sin q_1}{h}} q_1^2 dq_1 \quad (\text{B 5})$$

where $q_1 \in]0, \infty[$;

on the interval, $q_1 \in [0, n\pi]$ obtains:

$$\langle q_1^2 \rangle_{q_1 \in [0, n\pi]} = \frac{1}{k\Delta q \mathbf{1}_0 \left(\frac{2q_1^{-1}(q_1^0)m_1}{h} \right)} \int_0^{0+n\pi} e^{\frac{2tm_1 \sin q_1}{h}} q_1^2 dq_1 \quad (\text{B 6})$$

let denote map

$$L_2[0, l\Delta q] \rightarrow L_2[0, n\pi], \quad n \in \mathbb{N}, l \in \mathbb{R}_+$$

Consider (B 6) in the small vicinity of q_1 ($n=1$), then

$$|q_1| < l\Delta q = \pi$$

and from (B 6) obtains:

$$\langle q_1^2 \rangle_{q_1 \in [0, l\Delta q]} = \frac{1}{k\Delta q \mathbf{1}_0 \left(\frac{2q_1^{-1}(q_1^0)m_1}{h} \right)} \int_0^{0+l\Delta q} e^{\frac{2tm_1 \sin q_1}{h}} \sin^2 q_1 dq_1, \quad n=1 \quad (\text{B 6 a})$$

Can represent (B 6 a) in the form:

$$\left\langle q_1^2 \right\rangle_{q_1 \in 0:l\Delta q} = \frac{1}{k\Delta q \mathbf{l}_0 \left(\frac{2q_1^{-1}(q_1^0)m_1}{h} \right)} \int_{\frac{\pi}{2}}^{\frac{\pi}{2}+l\Delta q} e^{\frac{-2tm_1 \cos q_1}{h}} \cos^2 q_1 dq_1 \quad (\text{B 6.1})$$

and from (B 6.1) obtains:

$$\left\langle q_1^2 \right\rangle_{q_1 \in 0:l\Delta q} = \frac{1}{k\Delta q \mathbf{l}_0 \left(\frac{2q_1^{-1}(q_1^0)m_1}{h} \right)} \sqrt{l\Delta q} \frac{h}{itm_1} \Gamma\left(\frac{3}{2}\right) \mathbf{J}_1\left(\frac{i2tm_1}{h}\right) \quad (\text{B 6.1 a})$$

Can present in the form:

$$\left\langle q_1^2 \right\rangle_{q_1 \in 0:l\Delta q} = \frac{1}{k\Delta q \mathbf{l}_0 \left(\frac{2q_1^{-1}(q_1^0)m_1}{h} \right)} \sqrt{l\Delta q} \frac{h}{tm_1} \Gamma\left(\frac{3}{2}\right) \mathbf{I}_1\left(\frac{2tm_1}{h}\right) \quad (\text{B 7})$$

Substituting (B 3), (B 7) in (B 4) obtains:

$$\sigma_{P_1}(q_1) = \frac{1}{\sqrt{k\Delta q \mathbf{l}_0 \left(\frac{2q_1^{-1}(q_1^0)m_1}{h} \right)}} \sqrt{\sqrt{l\Delta q} \frac{h}{tm_1} \Gamma\left(\frac{3}{2}\right) \mathbf{I}_1\left(\frac{2tm_1}{h}\right) - \left(l\Delta q \mathbf{l}_1 \left(\frac{2tm_1}{h} \right) \right)^2} \quad (\text{B 8})$$

where

there is an existing dependence on q_i^0 ($q_i^0 = q_i(t_0)$);

randomness is included through parameter Δq (for the i -th state $\Delta q_i = q_i - q_i^0$).

11. Expression for E, Λ .

As F is a stochastic process with a state space q (ref. Appendix B5, paragraph 1), the random vector F takes values in the column vector q

$$\mathbf{q} = \begin{bmatrix} q_1 \\ \vdots \\ q_k \end{bmatrix}$$

then $\text{cov}(F)$ represents a covariant matrix of the vector q in the form:

$$K_{qq} = \text{cov}(\mathbf{q}) = E \left[(\mathbf{q} - E[\mathbf{q}])(\mathbf{q} - E[\mathbf{q}])^T \right] = E(\mathbf{q}\mathbf{q}^T) - \mu\mu^T \quad (\text{B } 9)$$

is Hermitian symmetric and positive semidefinite, can diagonalize the matrix as:

$$K_{qq} = \text{cov}(\mathbf{q}) = E\Lambda E^T \quad (\text{B } 9 \text{ a})$$

where

E - orthogonal matrix of eigenvectors (k -column is eigenvector q_k of K_{qq} , $k = (1, \dots, N_q)$);

$\sum_{i=1}^{N_\lambda} M_i = N_q$, M_i - geometric multiplicity of λ_k),

Λ - diagonal matrix of eigenvalues (i.e. $\Lambda_{kk} = \lambda_k$);

can represent eigenvalue equation in the form:

$$K_{qq} \mathbf{q} = \lambda \mathbf{q} \quad (\text{B } 10)$$

this yields a characteristic equation:

$$\det(K_{qq} - \lambda I) = 0 \quad (\text{B } 11)$$

solving all of eigenvalues λ_k .

For each eigenvalue λ_k has a specific eigenvalue equation:

$$(K_{qq} - \lambda_k I) \mathbf{q} = 0 \quad (\text{B 11 a})$$

solving for eigenvectors \mathbf{q}_k associated with the eigenvalue λ_k .
Algorithm for solving (B 11), (B 11 a) is iterative.

12. Specified applicable time interval for the model.

As a result of consideration (refer to Appendix B10):

$$\Delta q = q_1(\Delta t) \Rightarrow \Delta t = q_1^{-1}(\Delta q)$$

where $q_1(t)$ is defined by (5.2);
time interval can be represented in the form:

$$l_{q_1}(\Delta t) = \pi \quad (\text{B 12})$$

13. Influence of perturbations.

Allow, that local interaction of states affected by perturbations can consider dependence measurement of the i -th state on perturbations α_i , i.e. ${}^{\alpha_i}q_i (\equiv q_i(\alpha_i))$ in equation (3.8). Consider shock wave α_i^{-1} (J. Eggers and M.A. Fontelos, 2015; part III) in the form ${}^l A J_0(t)$ (S. Solomon, 2002) disturbance - disturbance interactions as a response to α_i . Then represent ${}^{\alpha_i}q_i$ as convolution of measurement of the i -th state q_i , not affected by perturbations α_i and a shock wave, which approached the system:

$${}^{\alpha_i}q_{i(t)} = {}^l A \int_{t_0}^t q_i(\tau) J_0(t-\tau) d\tau \quad (\text{B 13})$$

where

$q_i(t)$ defined by (5.2);

$t-t_0$ - time delay between time, when shock wave reaches system t_0 and system responses;

${}^l A$ - shock wave amplitude;

$t-\tau$ - define information in a form of durations between system events.

In particular durations supplemented by information on disturbance activity and a no-information case, represented by Poisson arrivals of events (M. Coppejans and I. Domowitz, 1999).

To model the durations of disturbance within the time interval, use an autoregressive conditional duration (ACD) model to describe the evolution of time durations for (high disturbance) states ^{note} :

$$t - \tau = \tau_t = \theta_t x_t$$

where

x_t i.i.d. random variables, $x_t > 0$; $E(x_t) = 1$;

$$\theta_t = \alpha_0 + \sum_{i=1}^q \alpha_i \tau_{t-i} + \sum_{i=1}^p \beta_i \theta_{t-i}$$

and $\alpha_0 > 0, \alpha_i \geq 0, \beta_i \geq 0, i > 0$;

for approximate time interval refer to Appendix B12.

note:

the ACD model and GARCH model refer to the clustering of data in systems.

The autoregressive form of $ACD(q, p)$ allows to capture the duration clustering observed in high frequency data, i.e., small (large) durations followed by other small (large) durations in a way similar to the GARCH model accounting for deviation, when taking measurements of specified quantum mechanical value from its average value clustering (M. Pacurar, 2006). This is the difference between the use of ACD-type and CH (GARCH-type) in (B 13) and (5.2) correspondingly.

Consider Taylor series expansion, in the small interval Δt :

$$q_1(t_0 + \Delta t) |_{\Delta t=t-t_0} = q_1(t_0) + \frac{\partial q_1(t_0)}{\partial t} \Delta t \quad (\text{B 14})$$

From (B 12) obtains:

$$t = t_0 + \frac{\pi - lq_1^0}{\frac{\partial q_1(t_0)}{\partial t}} \quad (\text{B 14 a})$$

and substituting (B 14 a) in (B 13) can present in the form:

$${}^{\alpha_1} q_1 = {}^1 A \int_{t_0}^{t_0 + \frac{\pi - lq_1^0}{\frac{\partial q_1(t_0)}{\partial t}}} q_1(\tau) J_0(t - \tau) d\tau \quad (\text{B 15})$$

Applying mean-value theorem for (B 15) obtains:

$$(\text{B 16})$$

$${}^{\alpha_1} q_1 = {}^1 A q_1 \left(t_0 + \theta \left(\frac{\pi - lq_1^0}{\frac{\partial q_1(t_0)}{\partial t}} \right) \right) \times \left\{ \Delta t [J_1(\Delta t) S_{0,0}(\Delta t) - J_0(\Delta t) S_{-1,-1}(\Delta t)] - \left[\left(\Delta t - \frac{\pi - lq_1^0}{\frac{\partial q_1(t_0)}{\partial t}} \right) \left[J_1 \left(\Delta t - \frac{\pi - lq_1^0}{\frac{\partial q_1(t_0)}{\partial t}} \right) S_{0,0} \left(\Delta t - \frac{\pi - lq_1^0}{\frac{\partial q_1(t_0)}{\partial t}} \right) - J_0 \left(\Delta t - \frac{\pi - lq_1^0}{\frac{\partial q_1(t_0)}{\partial t}} \right) S_{-1,-1} \left(\Delta t - \frac{\pi - lq_1^0}{\frac{\partial q_1(t_0)}{\partial t}} \right) \right] \right\}$$

where

$$0 < \theta < 1.$$

note:

¹ superposition principle, i.e. system $r \cup r'$ can exist in the states described by P_r and $P_{r'}$, then it can exist in the state described by $P^{\text{superstate}}$; and this is equally related to parts $r \subset r \cup r'$ described by P_r^i and $r' \subset r \cup r'$ described by $P_{r'}^i$ for P_r , $P_{r'}$ correspondingly; so $P^{\text{superstate}}$, $P_r, P_{r'}$ are wavefunctions of states which can attain to the system $r \cup r'$ and r, r' parts; according to the superposition principle, sum of 'pure' states is again 'pure' state, so a certain physical system is expanded to orthogonal and non-orthogonal terms ('pure' group states), eq. (1.1); each group state is expanded to a set of i -th system states, where $i \in [1, \dots, n]$ on orthogonal set; $i \in [n, \dots, m]$ on non-orthogonal set correspondently, eq. (1.2).

² wavefunction P_i for i -th system state expressed in a form of solution of the Schrödinger equation (4.4).

Viz. as an approximation limit of the Schrödinger equation; ansatz a general expression of the interaction Hamiltonian for pair interaction, which can be used in the Schrödinger's equation.

P_i is factorized for non-interaction approximation, i.e.

$$\alpha_l H_i^{\text{int}}(q_i; q_1, \dots, q_{i-1}, q_{i+1}, \dots, q_n, \alpha_l) = 0;$$

probability distribution is characterized by probability density function $f(y)$ defined by

$$P(q_i)P(q_i).$$

P_i is not factorized (the behavior of the i -th state of the system is affected by system perturbations α_l and other states j), so any changes of measurement q_i will change the measurement of other states $i \neq j$;

$$\text{i.e. } \alpha_l H_i^{\text{int}}(q_i; q_1, \dots, q_{i-1}, q_{i+1}, \dots, q_n, \alpha_l) \neq 0$$

conditional probability distribution is characterized by conditional probability density function

$$f_Y(y | \alpha_l X = x) \text{ defined by } P_i^*(q_i | \cdot) P_i(q_i | \cdot) \text{ where}$$

i def Y related to $H_0(q_i)$;

$$y = q_i;$$

$|\cdot\rangle$ def $\alpha_l X = \{q_1, \dots, q_{i-1}, q_{i+1}, \dots, q_n, \alpha_l\}$ related to $\alpha_l H_i^{\text{int}}(q_i; q_1, \dots, q_{i-1}, q_{i+1}, \dots, q_n, \alpha_l)$;

$x \in \alpha_l X$, $x = q_j$.

Ref. (A.S. Davidov, 1976).

³ a) In reference to the subject of the stochastic structure of spacetime, consideration of nonlocality (ref. eq. (4.1) and compare notes $0^{[1]}$, $0^{[1,1]}$ (M. Veltman, 2013)) the mechanism continues from the connection between Bohmian mechanics^{note} and Schrödinger eq. Consider contribution of $n-1$ states, i.e. for i -th state (4.4) with third term in eq. (3.13) in the form of degree $n-1$ and apply eq. (4.3).

The configuration space Q_+ of $n-1$ states evolves according to the guiding eq., accounting for an electromagnetic field applying to i -th state measurement, points to the connection with Bell's theorem and the direction of measurement:

$$\frac{d\vec{q}_i}{dt} = \frac{1}{2} \left[\begin{array}{l} P^{* \text{superstate}}(\vec{q}_1, \dots, \vec{q}_n, t; \alpha_l) (-ih\nabla_i) P^{\text{superstate}}(\vec{q}_1, \dots, \vec{q}_n, t; \alpha_l) \\ - P^{\text{superstate}}(\vec{q}_1, \dots, \vec{q}_n, t; \alpha_l) (-ih\nabla_i) P^{* \text{superstate}}(\vec{q}_1, \dots, \vec{q}_n, t; \alpha_l) \\ \times \frac{1}{|P^{\text{superstate}}(\vec{q}_1, \dots, \vec{q}_n, t; \alpha_l)|^2} - e\vec{\phi}_i \end{array} \right] \quad (\text{B } 17)$$

Applying (B 12) obtains:

(B 17 a)

$$\vec{q}_i = \int_0^{q_i^{-1}\left(\frac{\pi}{l}\right)} \frac{1}{2} \left[\begin{array}{l} P^{* \text{superstate}}(\vec{q}_1, \dots, \vec{q}_n, t; \alpha_l) (-ih\nabla_i) P^{\text{superstate}}(\vec{q}_1, \dots, \vec{q}_n, t; \alpha_l) \\ - P^{\text{superstate}}(\vec{q}_1, \dots, \vec{q}_n, t; \alpha_l) (-ih\nabla_i) P^{* \text{superstate}}(\vec{q}_1, \dots, \vec{q}_n, t; \alpha_l) \\ \times \frac{1}{|P^{\text{superstate}}(\vec{q}_1, \dots, \vec{q}_n, t; \alpha_l)|^2} - e\vec{\phi}_i \end{array} \right] dt$$

where $q_i \rightarrow \vec{q}_i$ in eq. (4.3) - (4.4).

\succ thus defines dependence on $\vec{\phi}_i$, and determines existence of the described stochastic process $F(\mu, \sigma_i^2)$, which defines \vec{q}_i .

b) The approach specified in (A. Chantasri, J. Dressel and A.N. Jordan, 2013) determines the path for chosen initial and final quantum states that satisfy both preselection and postselection boundary conditions.

The outlined mechanism does not require specifying postselection condition and defining path as trajectory associated with a specific quantum state.

The prediction of postselection result is based on the underlying progressively measurable stochastic process q_t (ref. eq. (5.2)).

note:

applicability of Bohmian mechanics is noted in D.H. Mahler, *et al.*, 2016.

1. On the subject of Lorentz violation.

1.1. This chapter addresses physical and mathematical considerations related to Lorentz violating terms in eq. (2.6.1 b). Detailization of physical origin of approximately non-manifestation of Lorentz violations in experiments and corresponding mathematical interpretation reflecting underlying physical processes is related to the context of the paper outlined in paragraph 4, item 4.1.2, sub-item 2.3.

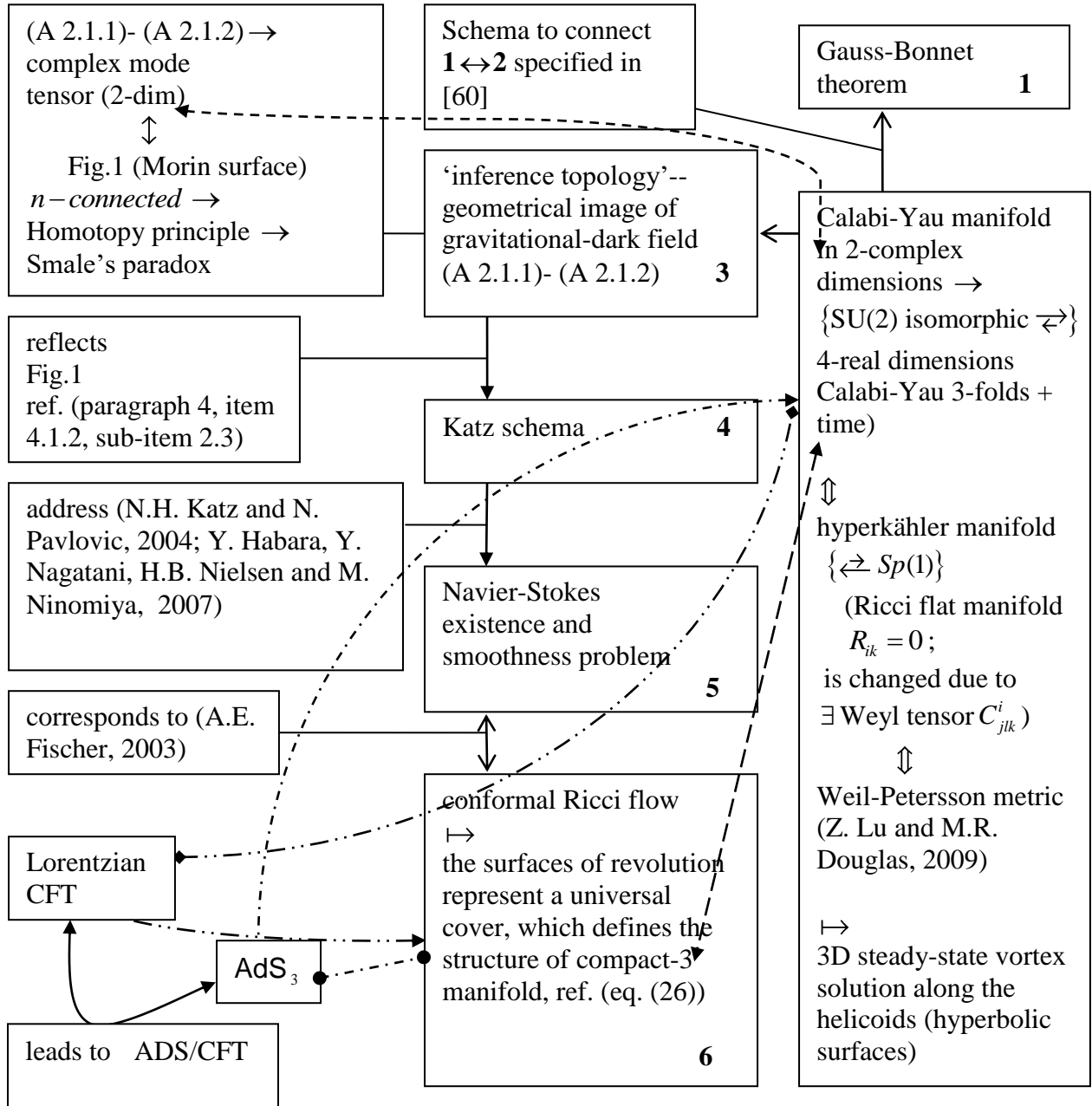

Fig. 9 Mathematical correspondences required to formulate underlying physical processes.

The following scheme is applied:

1. In the ‘vacuum state’ the radiation dynamics of ‘inference topology’ is related to the classical statistical case (Ref. paragraph 4, item 4.1.2, sub-item 2.1);
2. in the ‘mixed’ state the radiation dynamics of ‘inference topology’ is related to the classical statistical case and is determined by the first law of thermodynamics (Ref. paragraph 4, item 4.1.2, sub-item 2.2).

This results in the following:

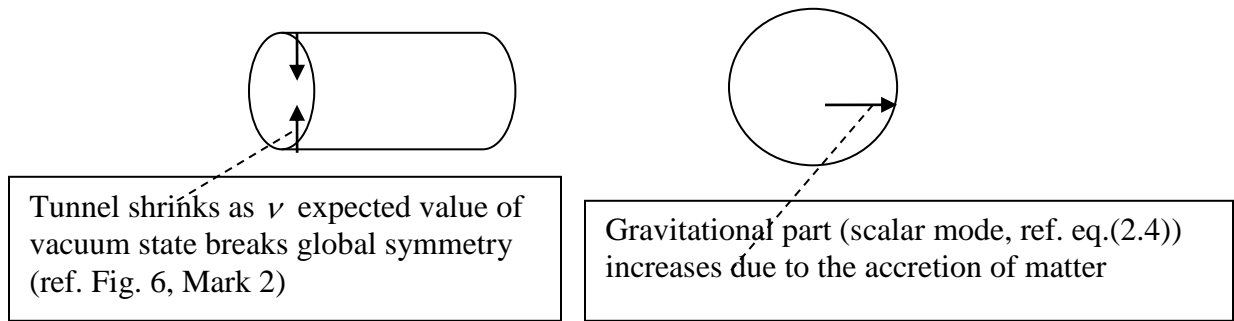

Fig. 10.1 Tunnel- gravitational part dynamics (step 1).

3. in a ‘pure’ state the radiation dynamics of ‘inference topology’ is related to the quantum statistical case and is determined by the dynamics of Navier-Stokes eq. (A 5.0.1) (ref. paragraph 4, item 4.1.2, sub-item 2.3).

This results in the following:

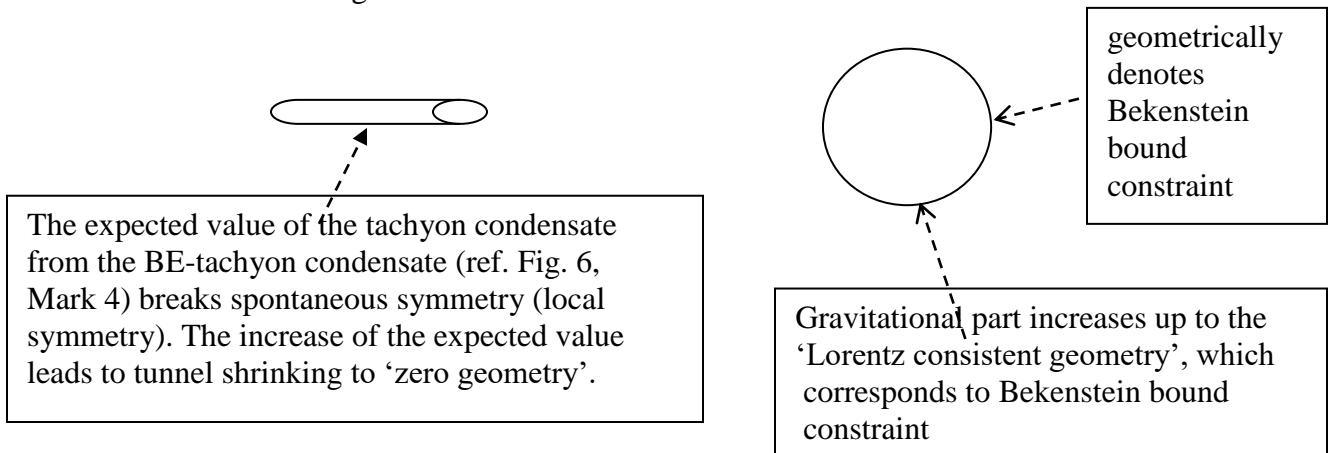

Fig. 10.2 Tunnel- gravitational part dynamics (step 2).

Fig. 10.2 represents ‘direct’ path:

‘zero geometry’ in tunnel part \leftrightarrow ‘Lorentz consistent geometry’ in gravitational part.

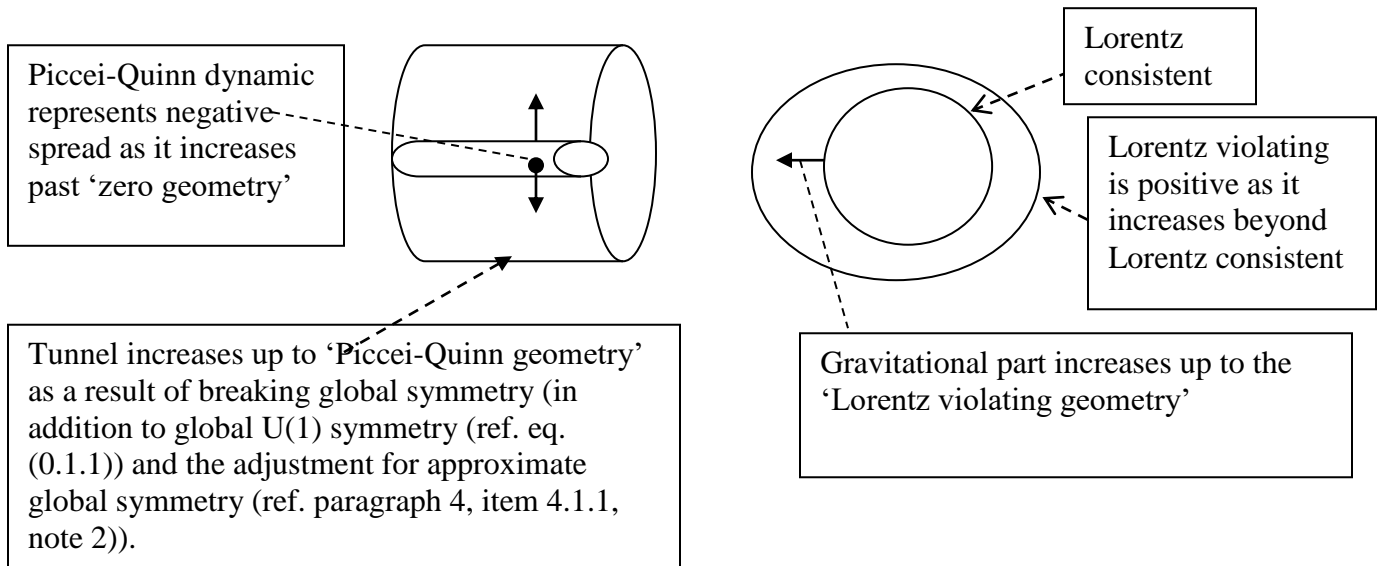

Fig. 10.3 Tunnel- gravitational part dynamics (step 3).

Fig. 10.3 represents 'feedback' path:

'Piccei-Quinn geometry' in tunnel part \leftrightarrow 'Lorentz violating geometry' in gravitational part.

Negative CP violating ^{note¹} spread in tunnel part cancels positive Lorentz violating spread in gravitational part. This leads to obtaining geometry of Bekenstein bound constraint (Fig. 10.2), which corresponds to normalized Ricci flow.

As such, the compensation of these two mechanisms ^{note²} can explain the negative results of the experimental searches on the Lorentz violation (V.A Kosteletsky and N. Russell, 2014).

The cases of breaking symmetry is defined by Mark 2 for global and Mark 4 for gauge correspondingly (ref. Fig. 6).

➤ Mark 2 describes obtaining massless goldstone boson from paragraph 1.1. In this case, Lorentz symmetry is global.

➤ Mark 4 is described by eq. (A 2.1.2); Goldstone boson becomes massive in tensor mode (ref. eq. (1.5), note 3). In this case, Lorentz symmetry becomes local (V.A Kosteletsky and N. Russell, 2014) (Lorentz symmetry breaking does not force CPT symmetry breaking).

note:

¹ broken Piccei-Quinn symmetry addresses CP violation dynamic, which is related to Lorentz violation dynamic(Fig. 10.3);

² spontaneous breaking of CPT and Lorentz symmetry is related to the vacuum instability (topological soliton (topological defect), i.e., domain wall) and becomes CPT- and Lorentz-symmetric in the vacuum stable case, even though other non-related to the vacuum stability symmetries (ref. eq. (0.1.1)-(0.1.2)) can be violated.

In this case, CPT symmetry breaking implies Lorentz symmetry breaking, thus \exists CP violation forces \exists Lorentz violation as the compensating mechanism.

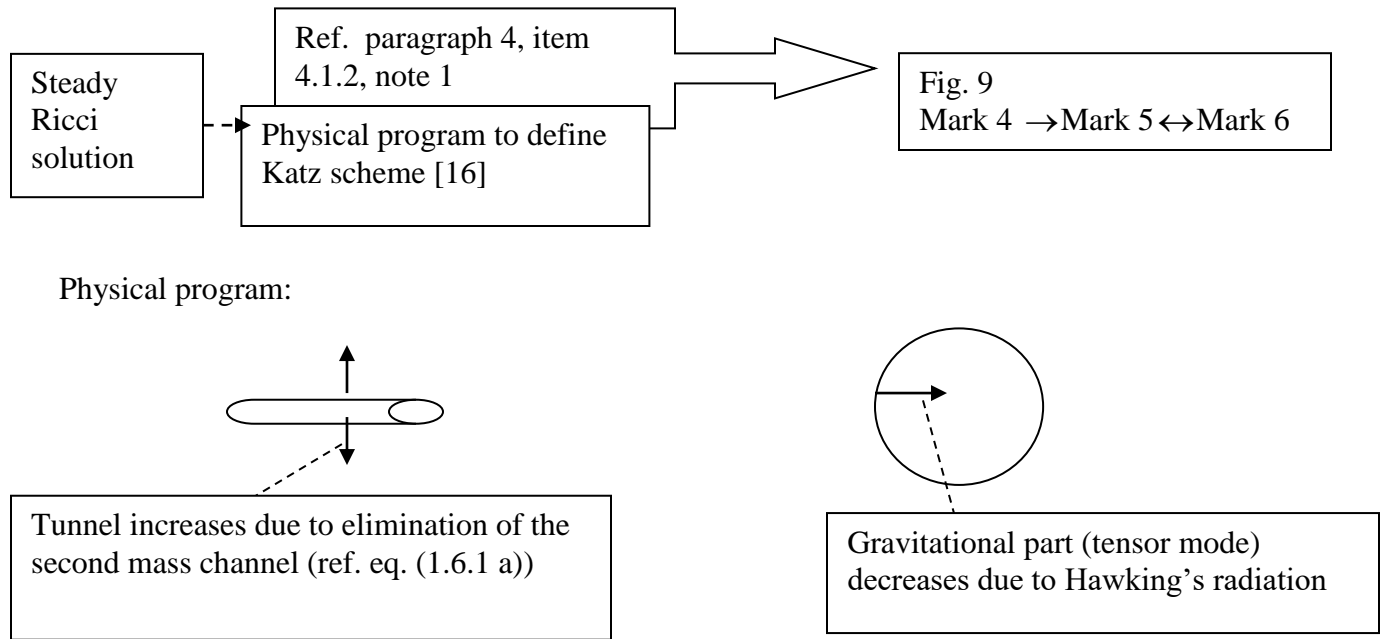

Fig. 10.4 Tunnel-gravitational part dynamics (step 4).

Dark part (tunnel) dynamic restores the state of maximum symmetry from the state of symmetry breaking (ref. Conclusion; Framework, paragraph 2), which leads to 'vacuum state' thus obtaining steady Ricci solution.

As specified in (Z. Lu and M.R. Douglas, 2009) (ref. Fig.9, Mark 2), a) \Leftrightarrow is b) where:

a) Calabi-Yau manifold (D. Gaiotto, S. Gukov and N.Seiberg, 2013) in 2-complex dimensions (Z.L. Gao and S.-T. Yau, 1986) (4-real dimensions \Leftrightarrow Calabi-Yau 3-folds + time);

b) Hyperkähler manifold (\subset Ricci flat manifold $R_{ik} = 0$) \Leftrightarrow Weil-Petersson metric.

Ricci flow^{note} affects metric (ref. paragraph 3), thus Thurston model geometries can be considered:

➤ Ricci-flat (Euclidian) is unchanged;

➤ sphere (Lorentzianian) is collapsed to a point (for unrenormalized Ricci flow) in case of positive curvature (mass part). This point acts like an attractor (for renormalized Ricci flow) in case of positive curvature;

➤ hyperbolic is an expansion for negative curvature (example: tunnel is negatively curved 2-manifold, n-connected).

note:

ref. Hamilton - Perelman theory of Ricci flow.

Corollary:

i) Ricci flow produces singularities (ref. Appendix A4).

ii) The **a)** case related to Fig. 10.4 points out correspondence between cigar soliton solution (complex plane \equiv complex mode in the bosonic mechanism) \leftrightarrow ‘Bryant soliton’+ time (ref. Appendix A5, paragraph 2.2).

iii) In case of Ricci flow, Thurston model geometries act like an attractor, thus pointing out the applicability of the developed chaotic attractor theory (ref. Appendix A4, paragraph 3, sub-item **ii**)).

iv) All closed 3- manifolds accept metrics with negative Ricci curvature (B.R. Greene, C. Vafa and N.P. Warner, 1989).

This directly follows from the ‘inference topology geometry’ (Fig.1), which admits to positive (mass) and negative (tunnel) geometries.

1.2. Presented below (Fig.11) is the graphical representation of the connections between a) the symmetry breaking approach ^{note} developed in the theory and b) the Lagrangian of the theory (including case - Lagrangians) in the context of Lorentz non-invariance of the presented theory Lagrangian eq. (1.4.1 a).

note:

specified in the section 1.1 the dynamic cancellation of Lorentz violation is applicable to the Lagrangian (1.4.1 a). In this context, references to ‘direct’ path and ‘feedback’ path are interconnected with ‘direct’ and ‘restoring’ paths of the symmetry breaking mechanism, which refers to dark sector of the theory as the driving force for restoring broken symmetry and, at the same time, appears as the source of Lorentz invariance violation. Ref. (D. Blas, M. M. Ivanov and S. Sibiryakov, 2012) on possibility of constraining deviation from Lorentz invariance in dark sector.

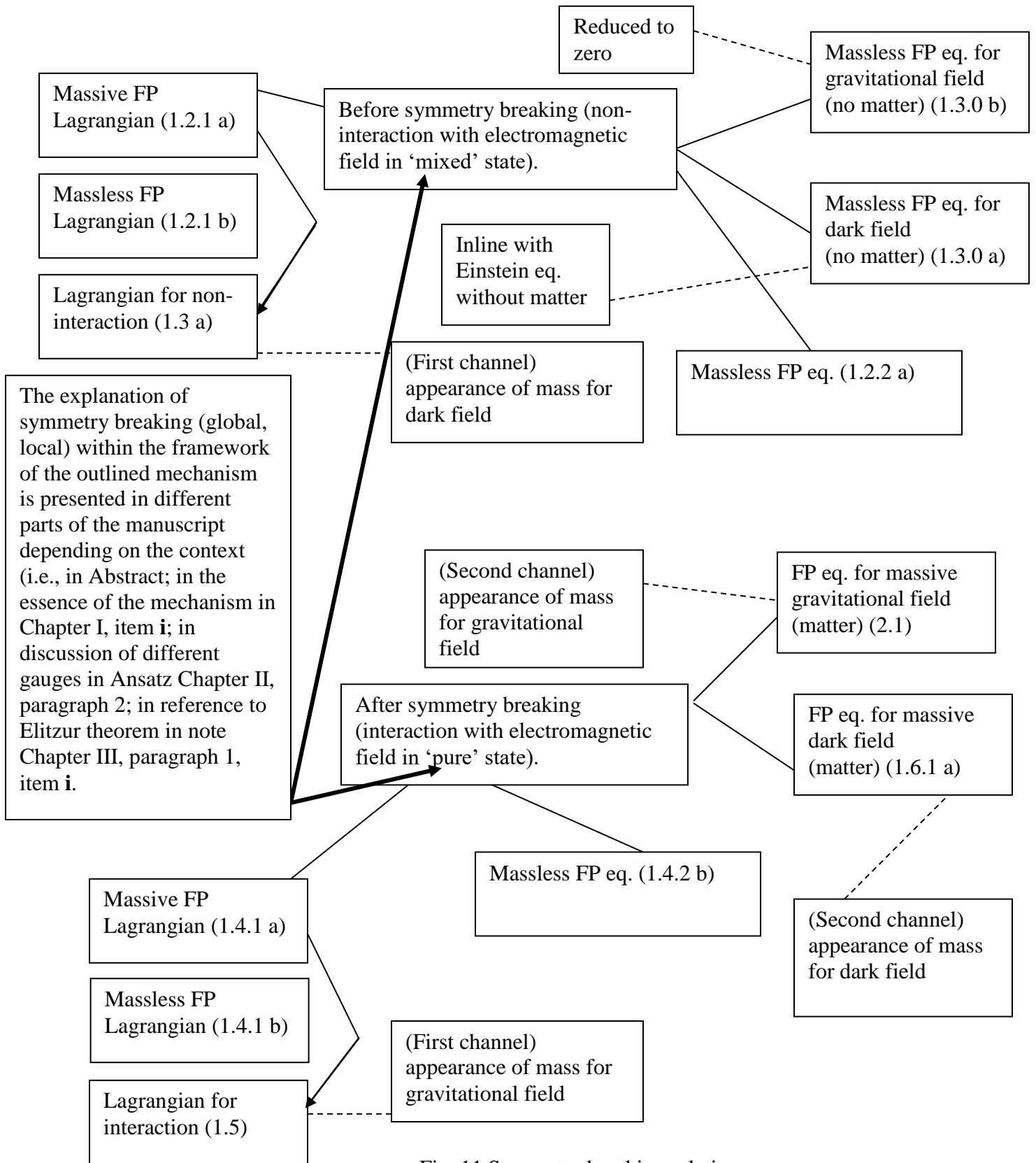

Fig. 11 Symmetry breaking relations, case - Lagrangians and EoM.

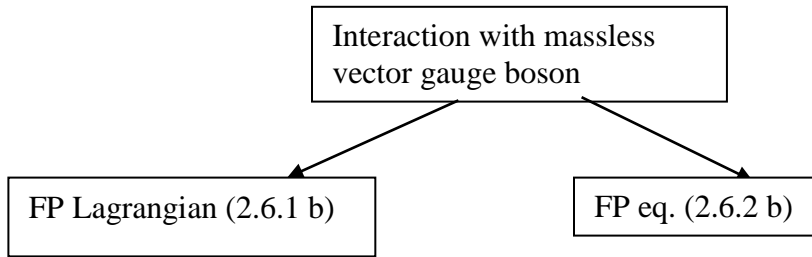

Fig.12 Representation of obtaining spin 1 boson masses.

1.1, 1.2 \succ

1. ‘direct’ path is associated with symmetry breaking and is related to scalar mode. This mode is Lorentz invariant, ref. (F. Halzen and A.Martin, 1984);

2. ‘restoring’ path which is associated with restoring symmetry from the breaking state is related to vector mode ^{note}. This mode is characterized by the cancellation of gauge field in ‘pure’ state ref. the essence of the mechanism (Chapter 1), but maintaining it in ‘mixed’ state. This mode violates Lorentz invariance as this path is determined by the role of dark sector.

The subject of spontaneous Lorentz breaking is addressed in the article by B. Altschul, Q. G. Bailey and V.A. Kostelecky, 2009 where the gravitational coupling involving Lorentz violation is said to be controlled by coefficient fields (ref. V.A. Kostelecky, 2004). The article and references therein also address constraints on some coefficients.

note

This is due to the vector character of gauge field and the bivector structure of dark sector.

1.3. Mathematical analysis of eq. (2.6.1 b) and (1.4.1 a) is conducted in accordance with physical considerations which are presented in Appendix C - Chapter 1 in paragraph 1.1 and in paragraph 1.2 correspondently.

a) The analysis of eq. (2.6.1 b) can be conducted based on the analysis of eq. (1.4.1 a) (theory Lagrangian). Ref. Fig. 10.1-Fig.10.4 for the connection to physical structure.

⤵ case of photon in ‘mixed’ state

1. Tunnel- gravitational part dynamics (step 1– symmetry breaking direction):

1.1. terms of type $\frac{\partial A_{ik}}{\partial x_l}$ and h.c. is 3– form denote volume dynamics;

1.2. terms of type $\sim C$ and h.c. spontaneously break global U(1) symmetry^{note¹}.

⤵ case of photon in ‘pure’ state

terms of type ϕ_l^2 represent mass terms for photon.

2. Tunnel- gravitational part dynamics (steps 2 and 3 – symmetry breaking direction):

‘direct’ path

2.1. terms of type $\frac{\partial \phi_l}{\partial x_r}$ and h.c. correspond to scalar (divergence) and bivector fields^{note²}

are responsible for breaking local symmetry (i.e., gauge field explicitly breaks local symmetry, ref. Elitzur theorem).

note:

¹ In ‘mixed’ state, according to G-type mechanism (i.e., symmetry breaking with electromagnetic field in ‘mixed’ state), eq. (2.7) results in $\langle \Phi \rangle = \nu$.

This value corresponds to nonvanishing vacuum expectation of Nambu-Goldstone mode eq. (1.1 b), while vanishing value equals 0. Complex form of this eq. account for appearance of Nambu-Goldstone mode for scalar field Φ due to global symmetry breaking by electromagnetic field in ‘mixed’ state.

² Listed below is the definition of ∇ acting on the space dimensions

$$\nabla M = \nabla \cdot M + \nabla \wedge M \text{ where } M \text{ is multivector field.}$$

$M \mapsto \vec{v} : \nabla M \mapsto \nabla \vec{v} = \nabla \cdot \vec{v} + \nabla \wedge \vec{v}$, where \vec{v} – vector field;

$M \mapsto \omega : \nabla M \mapsto \nabla \omega$, where ω – scalar field.

∇ acting on type (r, s) tensor field of order $n \mapsto$ tensor field of order $n + 1$.

‘feedback’ path (in the context of returning to global symmetry breaking)

3.1. redefined according to the transition from ‘mixed’ ref. Fig. 6, Mark 2 to ‘pure’ ref. Fig. 6, Mark 4 states, terms of type $\sim C$ and h.c. break global symmetry (Piccei-Quinn).

4. Tunnel-gravitational part dynamics (step 4 – symmetry restoring direction):

‘restoring’ path ref. note, Appendix C - Chapter 1, paragraph 1.2

4.1. terms of type $\sim k^2$, A_{ik} ($\mapsto \text{contr}(A_{ik}) \sim \Xi$ i.e., dark field); and of type

$\sim k^2$, $\sim \text{Im}C$ ($\mapsto \text{Re}C$ i.e., corresponding to unbroken symmetry for the constraint $\phi_i = 0$) are eliminated from eq. (1.4.1 a), which denotes ‘vacuum’ state. Simultaneous elimination of the noted terms and the reduction of constraint $\phi_i = 0$ can be interpreted as the mutual cancellation of dark field (i.e., tensor-dark field reduced to scalar form) and gauge field (i.e., transfer photon in ‘mixed’ state); ref. Appendix C - Chapter 1, paragraph 1.1, item 1.

From eq. (1.4.1 a) under a specified constraint, the following is obtained (viz. $k \equiv k_{(\eta, \xi)}$):

terms of type $\text{contr}(A_{ik}) \sim \Xi$ include multiplier k_{Ξ}^2 (cf. eq. (1.1 a); $\because \ni$ (s.t.) ‘mixed’ state $\therefore k_h = 0$)

where

eq. (1.1 a) is the mathematical representation of the ‘inference topology’ geometrical structure v.s. ‘vacuum’ state;

terms of type $\text{Re}C$ include multiplier k_{Ξ}^2 (cf. note 2, eq. (1.2.2 a); $\because \ni$ (s.t.) ‘mixed’ state $\therefore k_{\xi} = 0$).

The mass part of eq. (1.4.1 a) in ‘vacuum’ state is determined by the contribution of mass from dark sector, i.e. mass terms of ‘pure’ state are reduced to mass terms of ‘mixed’ state.

v.s. mass part in eq. (1.4.1 b) is related to the consideration of ‘mixed’ state as non-interaction limit of the ‘pure’ state (cf. eq. (1.4.1 a)). Under this notation, ‘vacuum’ state accounts for the existence of mass terms due to the dark sector.

b) The eq. (2.6.1 b) for spin 1 boson would be analyzed in the same way.

Eq. (2.6.1 b) and eq. (1.4.1 a) are invariant under the following substitution:

$B_k \mapsto e\phi_k$ (cf. eq. (1.4.0) and eq. (2.6.0)).

➤ Thus, the following is obtained (viz. eq. (1.4.1 a) s.t. eq. (A 2.1))^{note} :

(C 0.1.4.1 a) i.e., (C 1.1)

$$\begin{aligned}
L_{FP} = & \left\{ \begin{array}{l} k_h^2 A_{ik}^* A_{ik}, : A_{ik} = ih_{ik}, \exists \phi_i \neq 0, \eta \mapsto h, \zeta \mapsto \xi \triangleleft \text{'pure'} \\ 0, : \exists \phi_i = 0, \eta \mapsto h, \zeta \mapsto \xi \triangleleft \text{'mixed'} \\ k_{\Xi}^2 A_{ik}^* A_{ik}, : A_{ik} \mapsto \text{contr}(A_{ik}), -\exists \phi_i, \eta \mapsto \Xi, \zeta \mapsto \Xi \triangleleft \text{'vacuum'} \end{array} \right\} + \\
& \frac{\partial A_{ik}}{\partial x_i} \frac{\partial A_{ik}^*}{\partial x_i} + e^2 \phi_i^2 A_{ik} A_{ik}^* \\
& - 2 \frac{\partial A_{rk}}{\partial x_r} \frac{\partial A_{sk}^*}{\partial x_s} - 2e^2 \phi_r \phi_s A_{rk} A_{sk}^* + \frac{1}{2} \frac{\partial A_{rk}}{\partial x_r} \frac{\partial C^*}{\partial x_k} + \frac{1}{2} e^2 \phi_r \phi_k A_{rk} C^* + \frac{1}{2} \frac{\partial A_{rk}^*}{\partial x_r} \frac{\partial C}{\partial x_k} + \frac{1}{2} e^2 \phi_r \phi_k A_{rk}^* C - \frac{3}{8} \frac{\partial C}{\partial x_i} \frac{\partial C^*}{\partial x_i} \\
& - \frac{3}{4} \left\{ \begin{array}{l} k_{\xi}^2 C^* C, : C = \nu + \xi + i\xi', \exists \phi_i \neq 0, \eta \mapsto h, \zeta \mapsto \xi \triangleleft \text{'pure'} \\ 0, : \exists \phi_i = 0, \eta \mapsto h, \zeta \mapsto \xi \triangleleft \text{'mixed'} \\ k_{\Xi}^2 C^* C, : C = \nu + \xi, -\exists \phi_i, \eta \mapsto \Xi, \zeta \mapsto \Xi \triangleleft \text{'vacuum'} \end{array} \right\} \\
& - \frac{3}{8} e^2 \phi_i^2 C C^* + \\
& i \left\{ \begin{array}{l} e\phi_i A_{ik}^* \frac{\partial A_{ik}}{\partial x_i} - e\phi_i A_{ik} \frac{\partial A_{ik}^*}{\partial x_i} - 2e\phi_s A_{sk}^* \frac{\partial A_{rk}}{\partial x_r} + 2e\phi_r A_{rk} \frac{\partial A_{sk}^*}{\partial x_s} + A_{rk} A_{ik}^* \frac{\partial \phi_r}{\partial x_i} - A_{rk} A_{ik} \frac{\partial \phi_i}{\partial x_r} + \frac{1}{2} e\phi_k C^* \frac{\partial A_{rk}}{\partial x_r} - \\ \frac{1}{2} e\phi_r A_{rk} \frac{\partial C^*}{\partial x_k} - \frac{1}{2} e\phi_k C \frac{\partial A_{rk}^*}{\partial x_r} + \frac{1}{2} e\phi_r A_{rk}^* \frac{\partial C}{\partial x_k} - \frac{3}{8} e\phi_i C^* \frac{\partial C}{\partial x_i} + \frac{3}{8} e\phi_i C \frac{\partial C^*}{\partial x_i} \end{array} \right\}
\end{aligned}$$

N.B.

Multivector field is a mathematical expression, which corresponds to physical structure including \exists mass, tunnel and type of mass-tunnel connection ref. Fig1, which are reflected in gauge/gravity duality.

Geometric representation of mass dynamics is mathematically described by the divergence part and geometrical representation of tunnel dynamics is mathematically described by the bivector part.

Maxwell eq. (two divergence- type and two curl- type) mathematically describes the electromagnetic gauge field. This eq. is geometrically represented by mass and tunnel dynamics. Mathematical-geometrical correspondence is the proof of postulated structure of 'inference topology'.

note:

$k \equiv k_{(\eta, \zeta)} = 0 \triangleleft$ 'unbroken' state.

2. On the subject of quantum statistics ^{note} .

The following eqs. outline the dependence of ‘gauge bosons of interaction’ statistics and fermions statistics upon gravitational-dark component (ref. renormalization group, Appendix 4, paragraph 3).

a) Bosons, transfer of interaction:

$$\text{Spin} (S_{GB}) = 1$$

b) Fermions:

$$\text{Spin} (S_F) = 1/2$$

Bosons, transfer of mass:

Graviton (G)

Dark (D)

$$\text{Spin} (S_G) = 2$$

$$\text{Spin} (S_D) = 0$$

➤ a) Equality between ‘gauge bosons of interaction’ and gravitational-dark component:

$$S_{GB} = S_G^{S_D} \tag{C 2.1}$$

The formula above indicates involvement of dark boson.

This eq. mathematically represents the statement, that rescaling the system ‘gauge bosons of interaction’ \leftrightarrow gravitational-dark by factor S_G is equivalent to rescaling bosonic field by a factor $S_G^{S_D}$.

➤ b) Equality between fermions and gravitational-dark component:

$$S_F = S_G^{-S_{GB}} \tag{C 2.2}$$

The formula above indicates involvement of interaction by dint of (C 2.1).

This eq. mathematically represents the statement, that rescaling the system fermion \leftrightarrow gravitational-dark by factor S_G is equivalent to rescaling fermion field by a factor $S_G^{-S_{GB}}$.

note:

Ref. n – vector model ($n = 4$) (H.E. Stanley, 1968).

Under the present consideration, the reflection between a) and b) cases is defined by means of the rescaling factor S_G .

Thus, the following is obtained:

$$S_G : \begin{pmatrix} S_G \\ S_D \end{pmatrix} \mapsto \begin{pmatrix} -S_G \\ S_D \end{pmatrix} \tag{C 2.3}$$

vectors parity ($p = -1$).

Appearance of the negative sign before S_G leads to Pauli expulsion principle, i.e. denotes the fact that fermionic system is described by antisymmetric wavefunction.

↔ a), b) The following is obtained by considering Fig.1 and Fig. 5.1-5.2:

i) 'inference topology'(bosonic) geometry is represented by (C 2.1);



ii) fermion geometry is represented by ($\equiv S_F = S_G^{S_D - S_{GB}}$) (C 2.2);

Dirac geometry

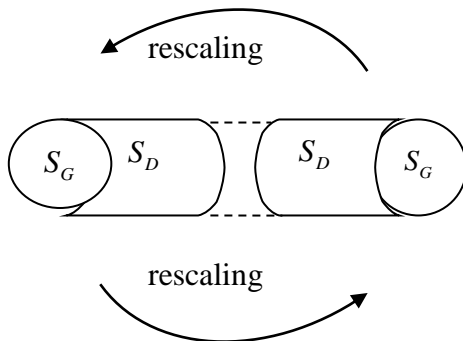

Majorana geometry

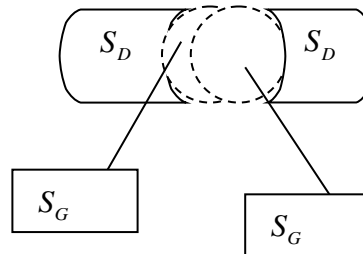

3. On the subject of AdS/CFT correspondence ^{note} .

3.1. Derivation of gauge/gravity duality can be explained within the framework of the outlined approach and follows from it. Utilizing results obtained in paragraph 2 (v.s. Appendix C) it is possible to apply Dirac sea (not Higgs ocean) specification of vacuum to the consideration of cross relation between superconductivity and the presented approach.

The following consideration of different states ref. eq. (C 0.1.4.1 a) is presented below in application to type-II superconductivity.

a) ‘unbroken’ state

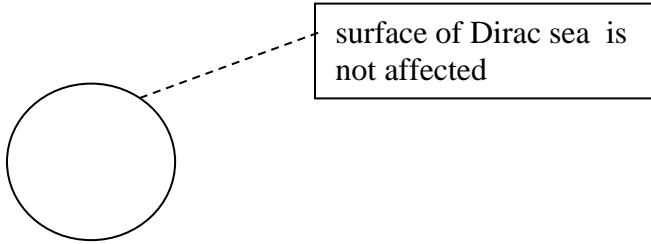

Fig. 13.1 No vortices (\exists superconductivity).

In this case, surface is unbroken, so $\neg \exists \eta, \phi_i \Rightarrow \langle \Phi \rangle = 0$ (ref. G-type, paragraph 2).

b) ‘vacuum’ state \rightarrow ‘mixed’ state

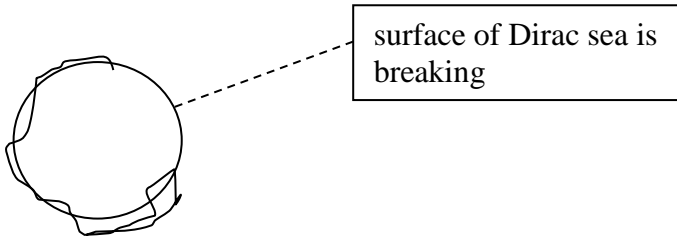

Fig. 13.2 Vortices breaking surface (\exists superconductivity).

In this case surface is breaking, i.e., spontaneous global symmetry breaking has occurred. This corresponds to the case noted as ‘Before symmetry breaking’ (ref. ‘Lagrangian for non-interaction’). Thus, the following is obtained:

$$\neg \exists \phi_i, \exists \eta \rightarrow \Xi, \zeta \rightarrow \Xi \Rightarrow \exists \phi_i = 0, \exists \eta \rightarrow h, \zeta \rightarrow \xi : \langle \Phi \rangle = v \quad (\text{C 3.1})$$

this results in appearance of false vacuum for scalar field Φ cf. eq. (1.1 b) initiated by the effect of BE condensate vortices (ref. Appendix A5, paragraph 1) penetrating surface. Goldstone theorem is applicable in this case. This is the case of massive dark boson creation ref. eq. (1.3 a), which results in transfer from false to true vacuum.

Under this scenario, the interaction of gravitational part of η -field with electromagnetic field ‘locked’ within Dirac sea boundary results in appearance of photon mass ref. eq. (A 3.2). The dark field, mathematically represented by bivector field ref. NB (Appendix C - Chapter 1, paragraph 1.3), is expelled from the inner side of sea boundary due to Meissner effect, which results in localizing it on the outer side of surface structure.

c) ‘pure’ state

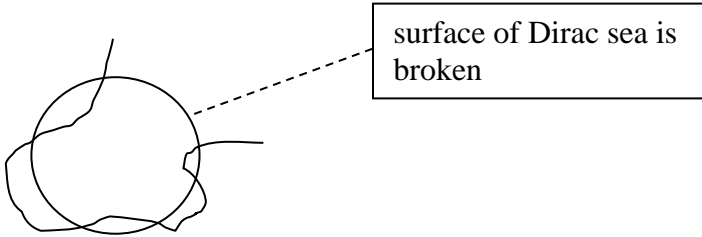

Fig. 13.3 Vortices have broken surface ($\neg \exists$ superconductivity).

In this case, the surface is broken, i.e., explicit local symmetry breaking has occurred. This corresponds to the case noted as ‘After symmetry breaking’ (ref. ‘Lagrangian for interaction’). Thus, the following is obtained:

$$\exists \phi_i \neq 0, \eta \rightarrow h, \zeta \rightarrow \xi : \ni (s.t.) \phi_i \notin \Xi$$

this results in appearance of true vacuum for scalar field Φ cf. eq. (1.1 b) initiated by the effect of BE condensate vortices (ref. Appendix A5, paragraph 1) which have penetrated surface. This is the case of massive gravitational field creation ref. eq. (1.5).

➤ Dark component at stage b) is attached to bounded (by the Dirac sea boundary due to unbroken geometry) surface structure, and gravitational component at stage c) which represents internal (unbounded by the Dirac sea boundary due to broken geometry) volume structure. These components reflect surface-volume connection according to mathematical duality cf. postulate **P2**.

In application to elementary particles (ref. Appendix A5, paragraph 2.2) this results in AdS/CFT ■

➤ ➤ \exists of quantum vortices are associated with Majorana bound states.

3.2. In the outlined framework, black hole can be considered as type-I superconductor.

In this case, surface is inevitably broken and the tunneling to a true vacuum for scalar field Φ cf. eq. (1.1 b) is due to instanton effects (ref. Appendix A5, paragraph 2.1).

note:

The stages of surface breaking of Dirac sea correspond to stages of penetration of electromagnetic field in vacuum, which results in gradual distraction of original superconducting state of vacuum.

4. Mass scale structure and the mathematical connections diagram.

4.1. The following diagram depicts mass scales (in order of magnitude) in the framework of the specified mechanism.

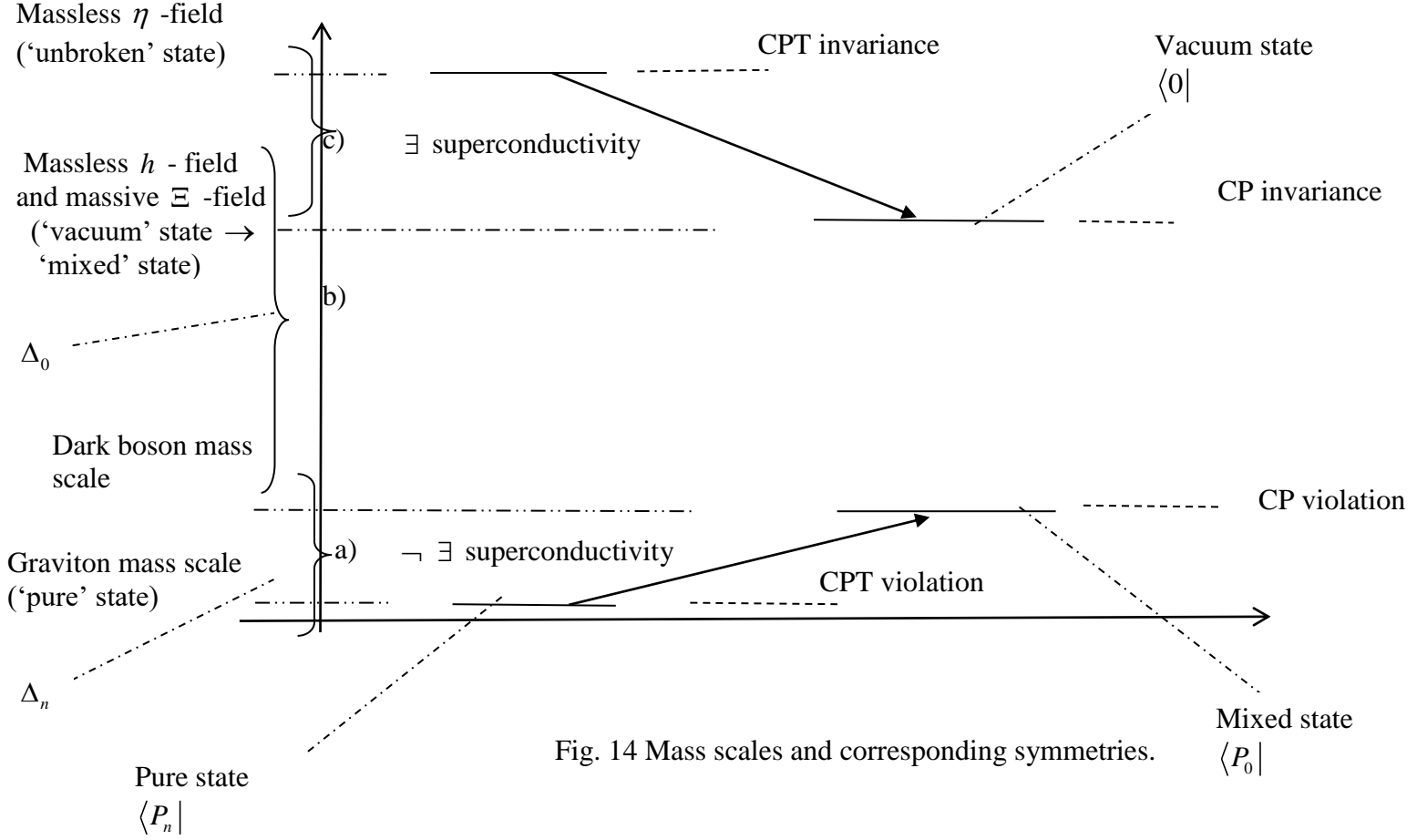

Mathematical definitions below are used to describe the following expressions:

a) the 'mixed' \rightarrow 'pure' state transition is defined by

$$\langle P_n | L_{FP_{pure}} | P_n \rangle \geq \langle P_0 | L_{FP_{mixed}} | P_0 \rangle + \Delta_n \quad (C 4.1)$$

b) the 'vacuum' \rightarrow 'mixed' state transition is defined by

$$\langle P_0 | L_{FP_{mixed}} | P_0 \rangle \geq \langle 0 | L_{FP_{vacuum}} | 0 \rangle + \Delta_0 \quad (C 4.2)$$

c) the ‘vacuum’ state $\langle \Phi \rangle \equiv (\langle 0 | \Phi | 0 \rangle) = \nu$ and ‘unbroken’ state $\langle \Phi \rangle \equiv (\langle 0 | \Phi | 0 \rangle) = 0$ define G-type spinor in eq. (2.7).^{note1}

In these equations, $L_{FP_{pure}}$, $L_{FP_{mixed}}$, $L_{FP_{vacuum}}$ are denoted correspondently by eq. (C 0.1.4.1 a) in ‘pure’, ‘mixed’ and ‘vacuum’ states with substitution of (Appendix C, paragraph 1, item 1.3, sub-item 4.1 b).

P_i is denoted by (Appendix B, eq.(4.1)); $P_0 = P_i: H_i \rightarrow H_0$.^{note2}

4.2. The following diagram depicts mathematical connections within the theory framework.

a) ‘unbroken’ \rightarrow ‘vacuum’ state

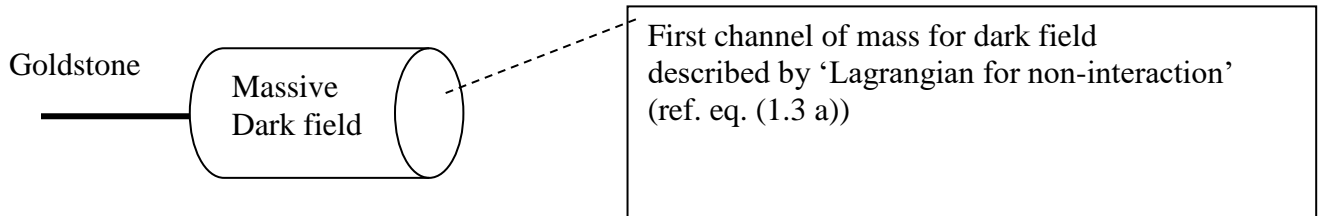

note:

¹ \exists empty waves of Ξ -type for ‘vacuum’ state; where $\langle 0 |$ describes the ground state of sine-Gordon model.

\therefore

dark part *s.t.* anti-de Sitter space \Leftrightarrow sine-Gordon model *s.t.* surface of constant negative curvature

■

² $\langle P_0 |$ solution of eq. (4.1) is orthogonal, normalized and non-invariant under shifts of the scalar η -field. This is the evidence of the spontaneous breaking of the field-shift symmetry.

∴

$$ih \frac{\partial P_0(q_0, t; q_0)}{\partial t} \Big|_{t=0} = k_{\pm} P_0(q_0), \text{ where } i=0 \text{ is 'mixed' state;}$$

$$ih [P_0(q_0)]^{-1} \frac{\partial P_0(q_0, t)}{\partial t} \Big|_{t=0} = k_{\pm} P_0(q_0) : (P_0(q_0, t; q_0) \equiv [P_0(q_0)]^{-1} P_0(q_0, t))$$

applying (3.6):

$$P_0(q_0, t) = P_0(q_0) e^{\frac{-itk_{\pm} e^{iq_0}}{\hbar}}, \text{ } tk_{\pm} \text{ -tuning parameter;}$$

$q_0 (\equiv \alpha_i q_{i(t)}|_{t=0}, i=0)$ is defined by eq. (B 13) where ${}^l A \mapsto \eta$ -field shifts

■

end_of_note

b) 'vacuum' → 'mixed' state

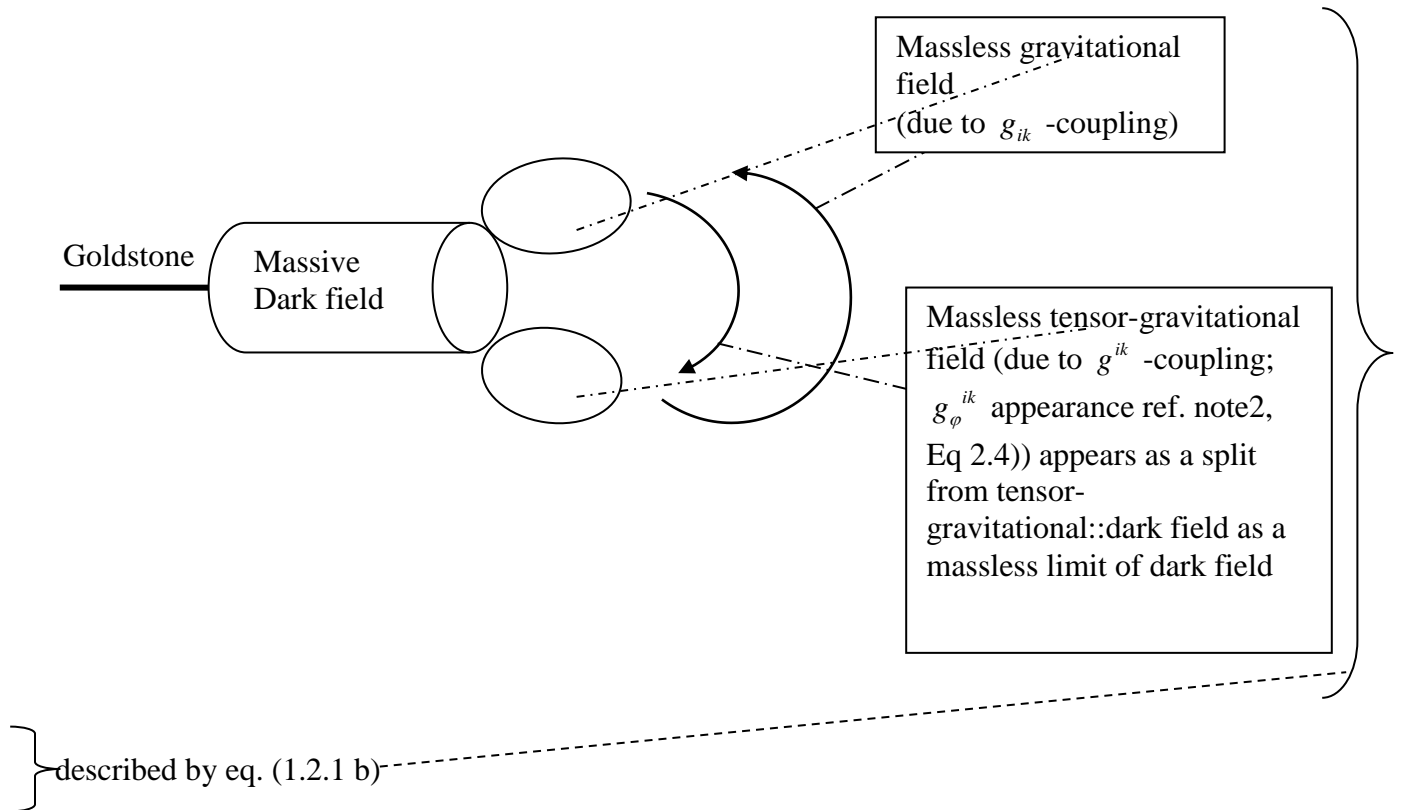

c) 'mixed' → 'pure' state

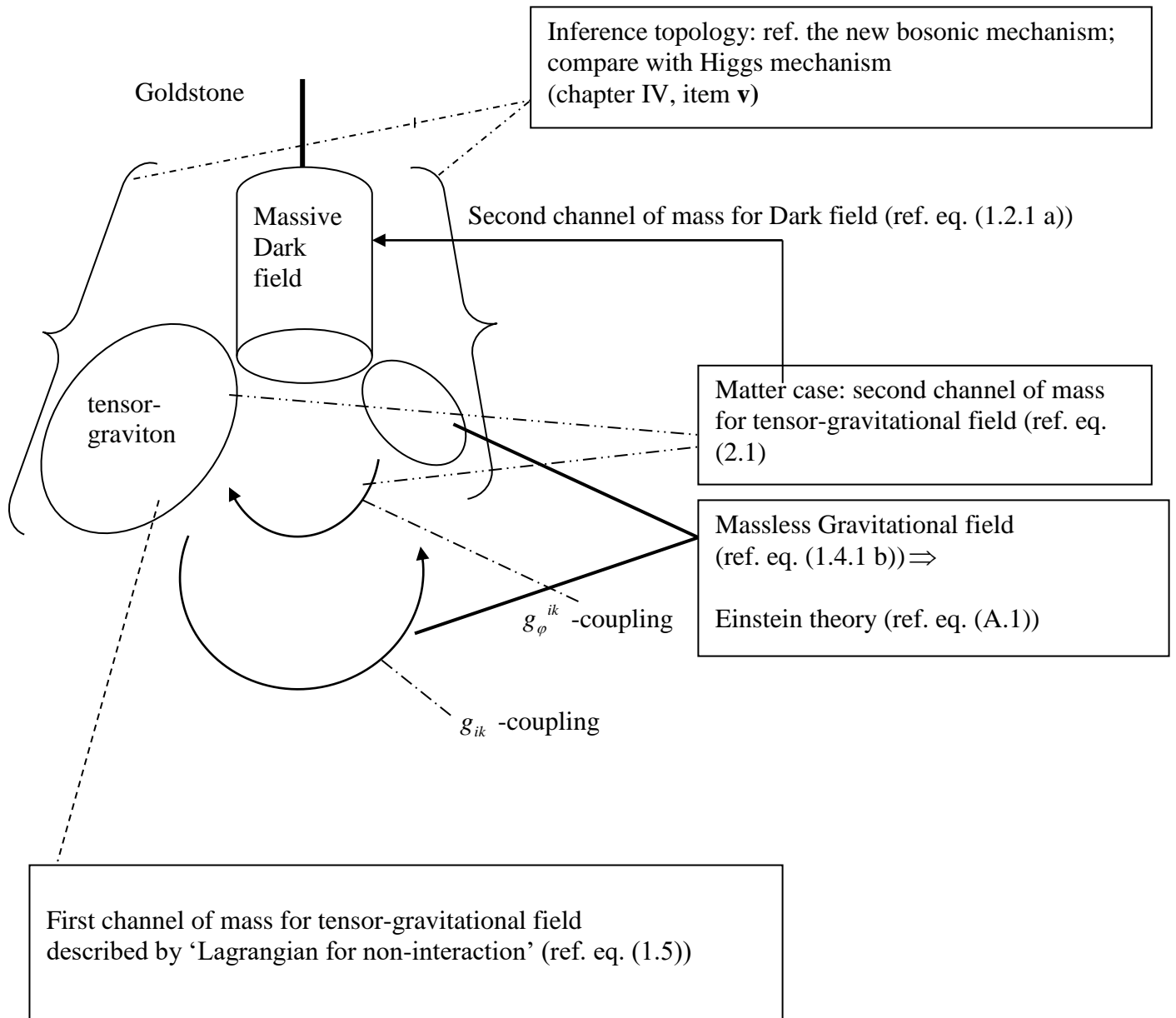

Fig. 15 (a), b), c) above) Mathematical connections, which depict the states of gauge field and corresponding interactions.

a), b), c) \succ ref. eq. (1.4.1 a) .

5. Neutrino oscillation.

See-saw mechanism is built-in into the new bosonic mechanism framework (as indicated in Appendix C, paragraph 3). See-saw mass matrix (A-matrix) can be mathematically formulated in non-contradictory way:

1. The appearance of Dirac M-mass is due to Yukawa coupling of Dirac field with scalar mode, thus resulted in electroweak mass scale.

➤ In case of Reissner-Nordstrom white hole :: black hole charge limit \mapsto Schwarzschild solution. This is interpreted as following for Reissner-Nordström solution:

Dirac field (RN white hole :: black hole) ^{note1}.

2. The appearance of Majorana B-mass can be classified as Kerr white hole:: black hole (appears due to the transition ^{note2} of Majorana bound state from state type-II superconductivity to state type-I superconductivity in Husimi Q representation) associated term.

Majorana B-mass term can then be represented as Yukawa coupling of scalar mode and Majorana bound state in state type-I superconductivity.

➤ The solution of Majorana equation is represented by Kerr white hole :: black hole two-particle construction. Mathematically, Kerr white hole is described by ψ spinor and Kerr black hole is described by ψ_c .

➤ In case of Majorana spinor, i.e., $\psi = \psi_c$, there exists two-particle construction, which cannot be isolated singularly. This case then satisfies Dirac equation.

This is interpreted as the following for Kerr solution:

Majorana field (Kerr white hole :: black hole) ^{note1}.

3. The coupling constant is determined in note 0: Appendix A 4, paragraph 3.

note:

¹ type – II superconductor
Case a) – white hole;

type – I superconductor
Case c) - fluctuating vortex (M. Baker and R. Steinke, 2000) \mapsto Majorana bound state (ref. item 3.1, case c)) on the border between type- II and type- I superconductors. It appears as black hole in type- I superconductor state (ref. item 3.2);

² the dynamics of transition to this state is described by Gross–Pitaevskii equation.

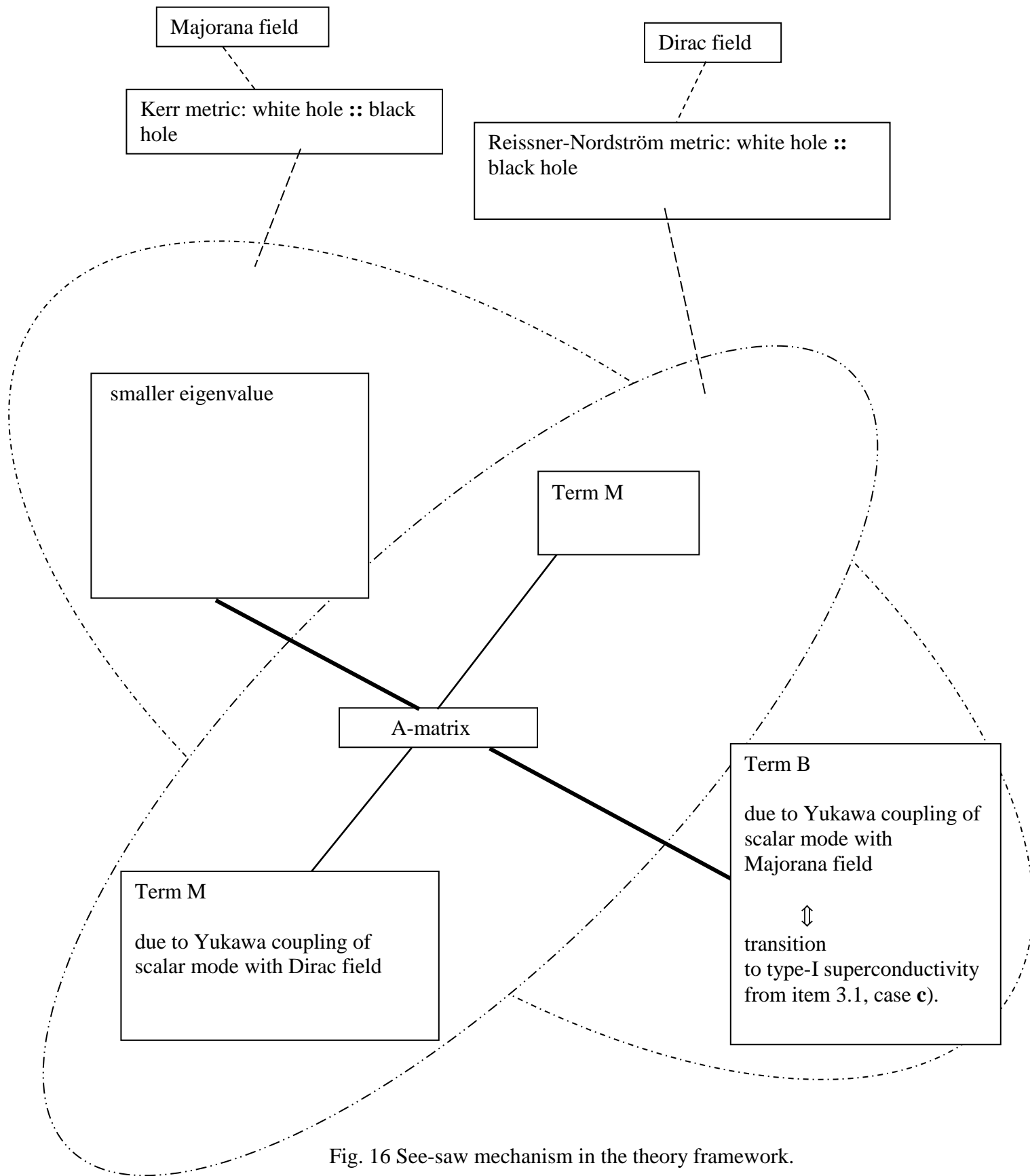
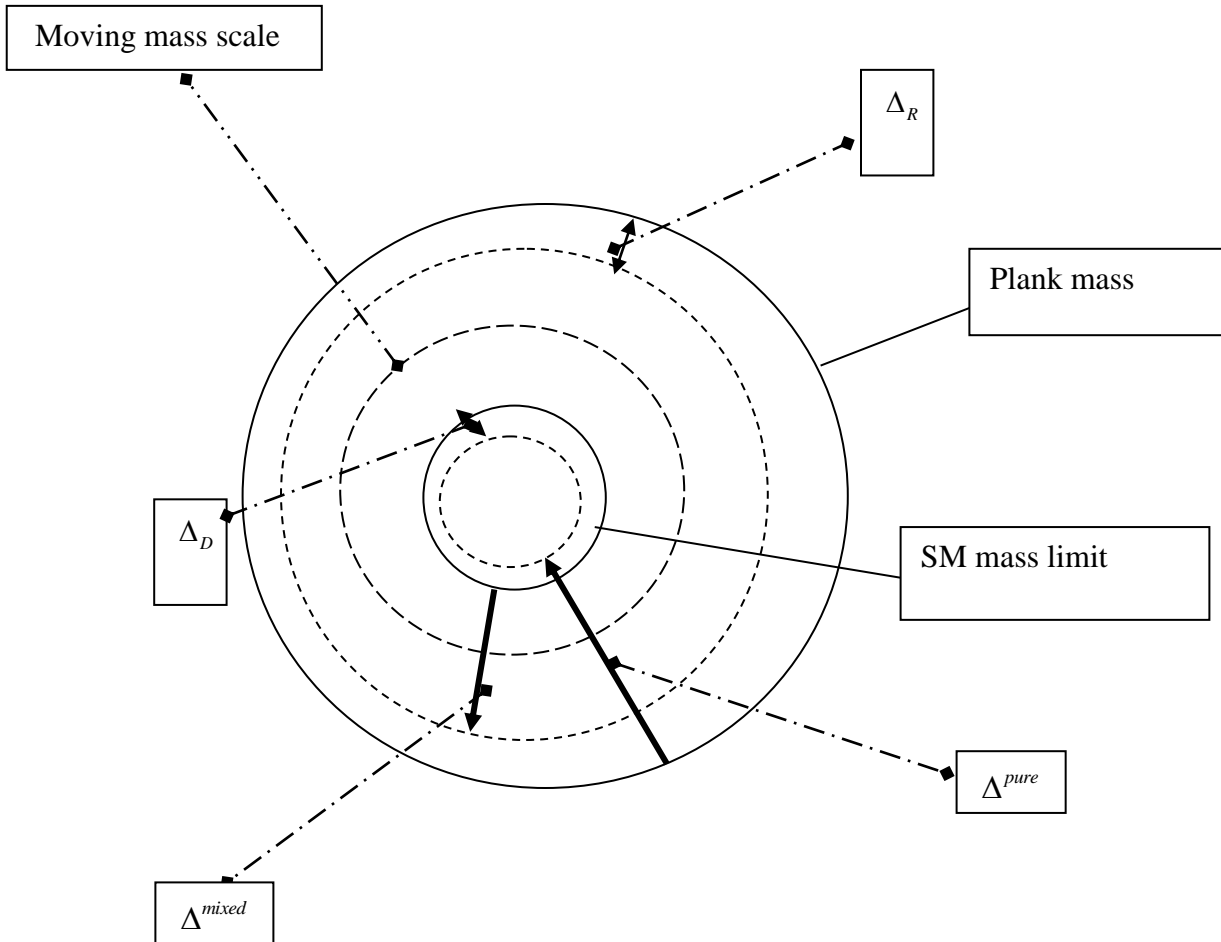

Fig. 16 See-saw mechanism in the theory framework.

6. The new bosonic mechanism's approach to hierarchy problem.

a) Mass scale is moving due to Dark energy (Ξ – field)



1. direct path:

Mass scale dynamic Δ^{pure} is defined by De Donder–Weyl eqs. with Lagrangian in form $L_{FP_{pure}}$ (C 4.1):

$$\frac{\partial p_a^i}{\partial x^i} = \frac{-\partial p_a^i \partial_i y^a - L_{FP_{pure}}}{\partial y^a} \quad (C 6.1)$$

$$\frac{\partial y^a}{\partial x^i} = \frac{\partial p_a^i \partial_i y^a - L_{FP_{pure}}}{\partial y^a}$$

where

$$p_a^i = \frac{\partial L_{FP_{pure}}}{\partial (\partial_i y^a)}$$

Oscillation Δ_D is due to forced NLSE with the dark energy as the driving force (ref. note 2: Appendix A 5, paragraph 4, item 2 b)) with SM limit boundary.

2. restoring path:

Mass scale dynamic Δ^{mixed} is defined by De Donder–Weyl eqs. with Lagrangian in form $L_{FP_{mixed}}$ (C 4.2):

$$\frac{\partial p_a^i}{\partial x^i} = \frac{-\partial p_a^i \partial_i y^a - L_{FP_{mixed}}}{\partial y^a} \quad (C 6.2)$$

$$\frac{\partial y^a}{\partial x^i} = \frac{\partial p_a^i \partial_i y^a - L_{FP_{mixed}}}{\partial y^a}$$

where

$$p_a^i = \frac{\partial L_{FP_{mixed}}}{\partial (\partial_i y^a)}$$

Oscillation Δ_R is due to \exists of Plank scale.

\forall Eqs. (C 6.1) - (C 6.2) :

$$i \in [1, 4] \subset Z, \quad a \in [1, 3] \subset Z; \quad (y^1, y^2, y^3) = (A_{ik}, C, \phi_i) .$$

b) Δ : Dark matter constituent

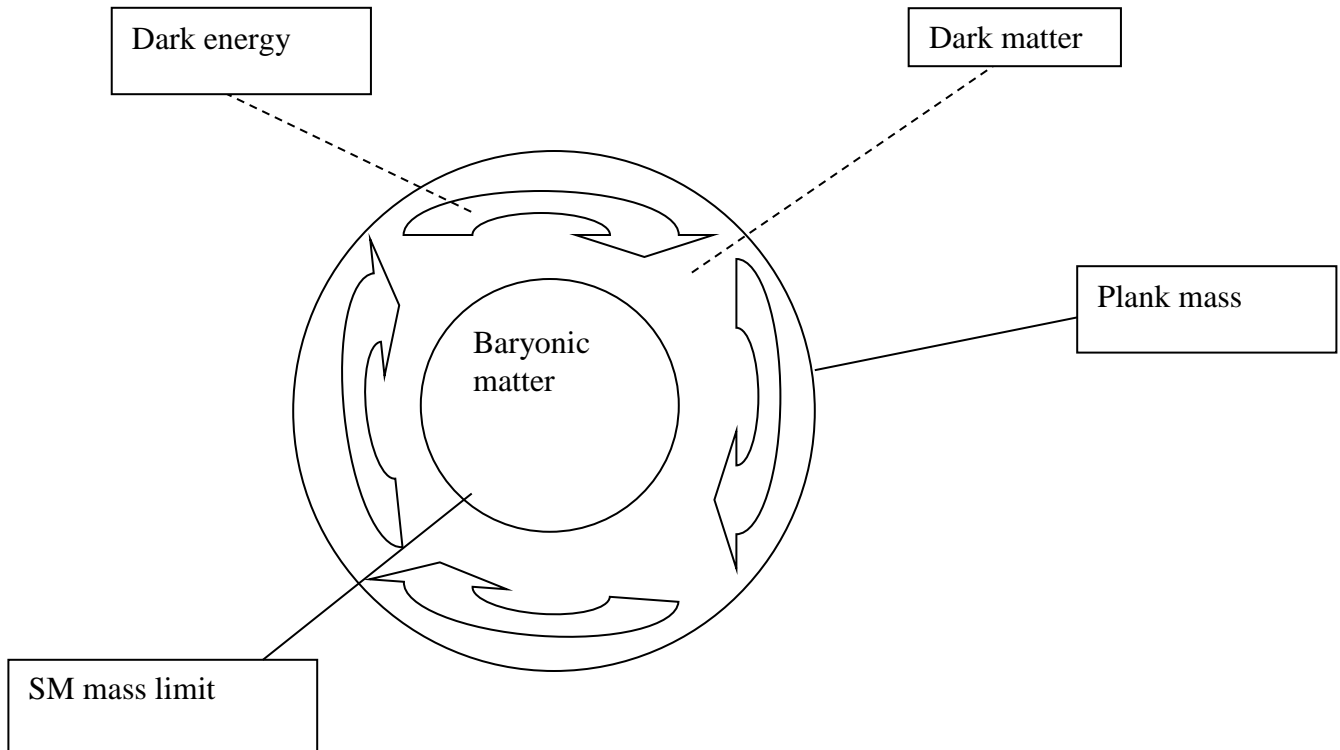

Fig. 17 a) Δ - Mass gap between SM mass limit and Plank mass is determined by Dark energy (Ξ - field);
b) Δ - Dark matter location.

1. Dark matter constituent is located within the boundary of Δ ;
2. Δ is defined according to the mass scale dynamic and is mathematically represented in item 6 a), ref. above.

c) Lorentz gauge and De Donder gauge conditions

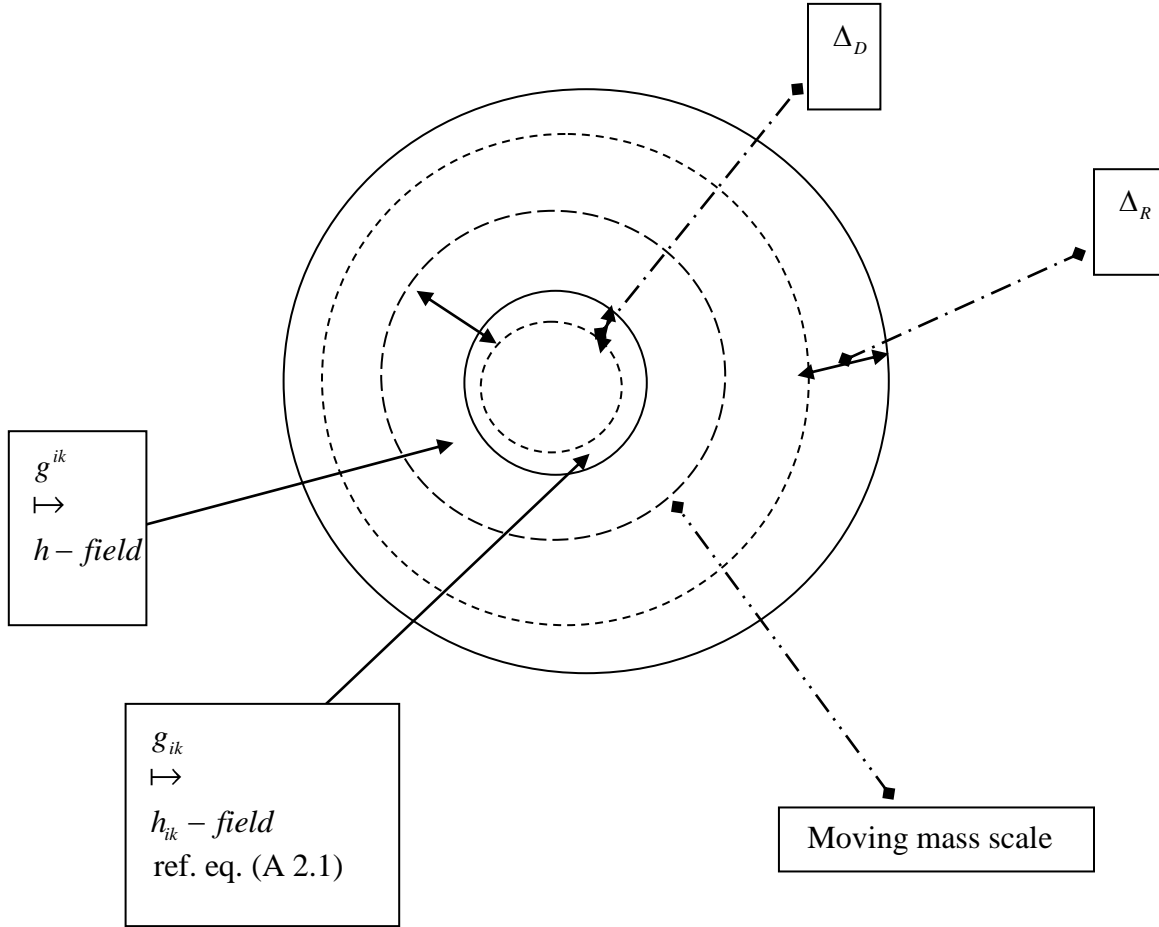

Fig. 17 c) Identification of gauge conditions for eqs. (C 6.1) - (C 6.2).

Oscillation Δ - eq. (C 1.1) correspondence:

1. $\geq \Delta_R \triangleleft$ 'unbroken' state;

2. $]Moving\ mass\ scale, \Delta_R[\triangleleft$ 'vacuum' state;

De Donder gauge is applied $\Rightarrow \partial_k (g^{ik} \sqrt{-g}) = 0$;

$\exists \partial_i f(x) \wedge \neg \exists A_i(x)$ ref. eq. (0.0.1);

3. $] \Delta_D, Moving\ mass\ scale[\triangleleft$ 'mixed' state;

Lorentz gauge is applied $\Rightarrow \partial_i A^i(x) = 0$

$\exists A_i(x)$ ref. eq. (0.0.1);

\succ the condition (ref. note 2: Appendix A 5, paragraph 4, item 2 b)) with SM limit boundary is satisfied for entropic electromagnetic field ϕ_i .

4. $\leq \Delta_D \triangleleft$ 'pure' state.

7. The new bosonic mechanism approach to reported resonance peaks at 750 GeV and 2TeV.

The new bosonic mechanism can explain the resonance peak observed with the mass of 125 GeV at LHC as well as possible resonance peaks at 750 GeV and 2 TeV as follows (also ref. M. Sachs, 2004):

↖ 'vacuum' state

resonance at 125 GeV:

scalar mode -before symmetry breaking \mapsto one component:
 \therefore spin-0 representation of Lorentz group.

↖ 'pure' state

resonance at 750 GeV:

tensor mode -after symmetry breaking (direct path) \mapsto six components:
 \therefore one component of spin-0 representation of Lorentz group;
 \therefore five components of Poincare group \wedge satisfied eq. (1.6.1 a).

resonance at 2TeV:

tensor mode -after symmetry breaking (restoring path) \mapsto sixteen components:
 \therefore ten components of Einstein group \wedge six components of Maxwell eq.

(C 7.1)

Decomposition properties (direct path \leftrightarrow restoring path):

\succ 'vacuum' state

resonance at 2TeV (restoring path) \leftrightarrow resonance at 125 GeV (direct path) \Rightarrow

end of the direct path coincides with the beginning of the restoring path;

scalar mode -before symmetry breaking \mapsto one component:

\therefore spin-0 representation of Lorentz group;

($\ni 1$)

\succ 'pure' state

resonance at 750 GeV:

tensor mode -after symmetry breaking \mapsto six components:

\therefore one component of spin-0 representation of Lorentz group;

($\ni 1$)

\therefore five components of Poincare group \wedge satisfied eq. (1.6.1 a)

($D=5$: $D(D-3)/2$)

resonance at 2 TeV:

tensor mode -after symmetry breaking \mapsto sixteen components:

\therefore ten components of Einstein group \wedge six components of Maxwell eq.

($D=5$: $D(D-1)/2-1$: $\ni 1$)

Fig. a) Dark boson decay properties (direct path):

γ 'vacuum' state
resonance at 2TeV:

γ 'pure' state
resonance at 750 GeV:

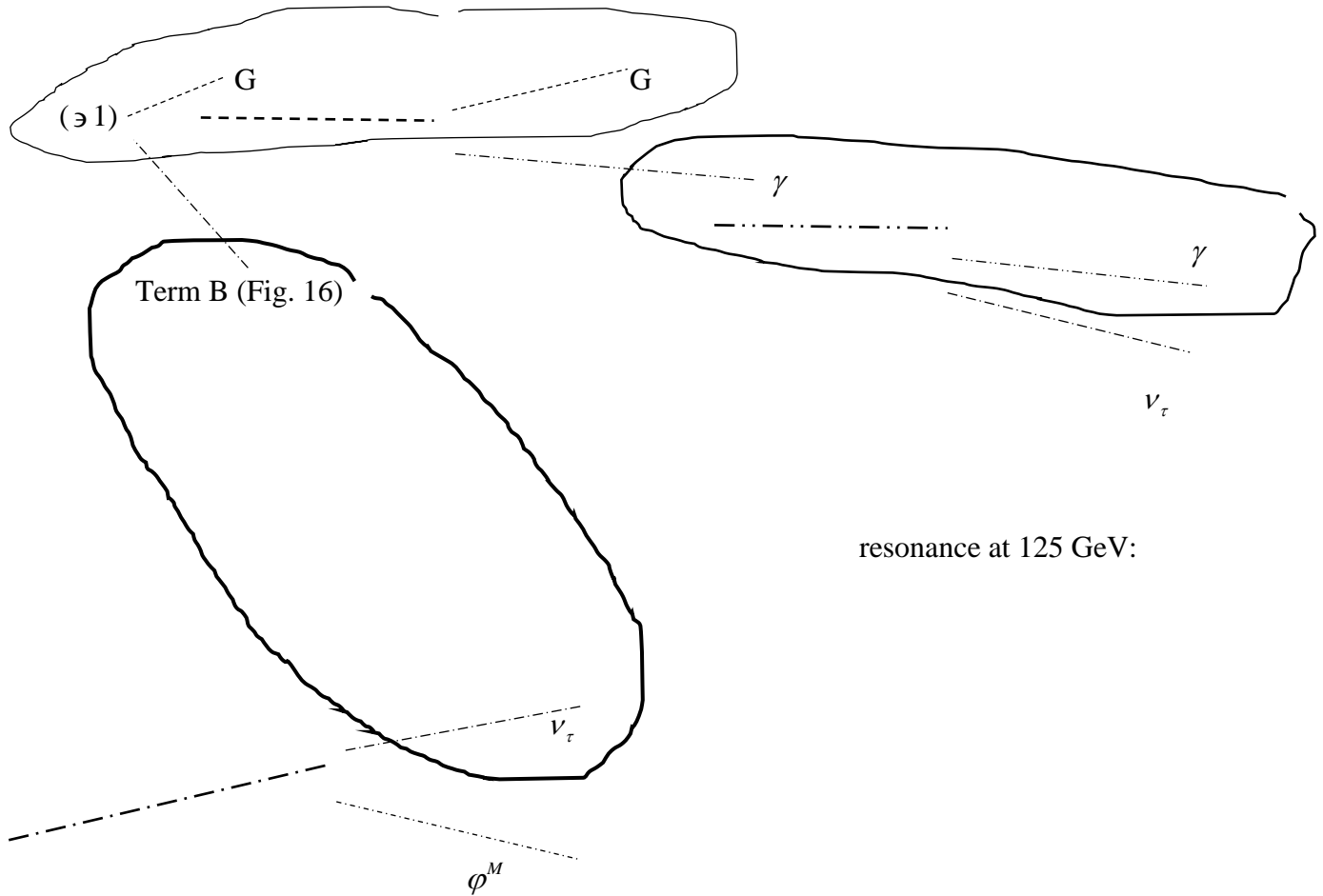

resonance at 125 GeV:

Observing the appearance of Majorana fermion in 125 GeV decay spectrum would verify this model.

Fig. b) Dark boson decay properties (restoring path):

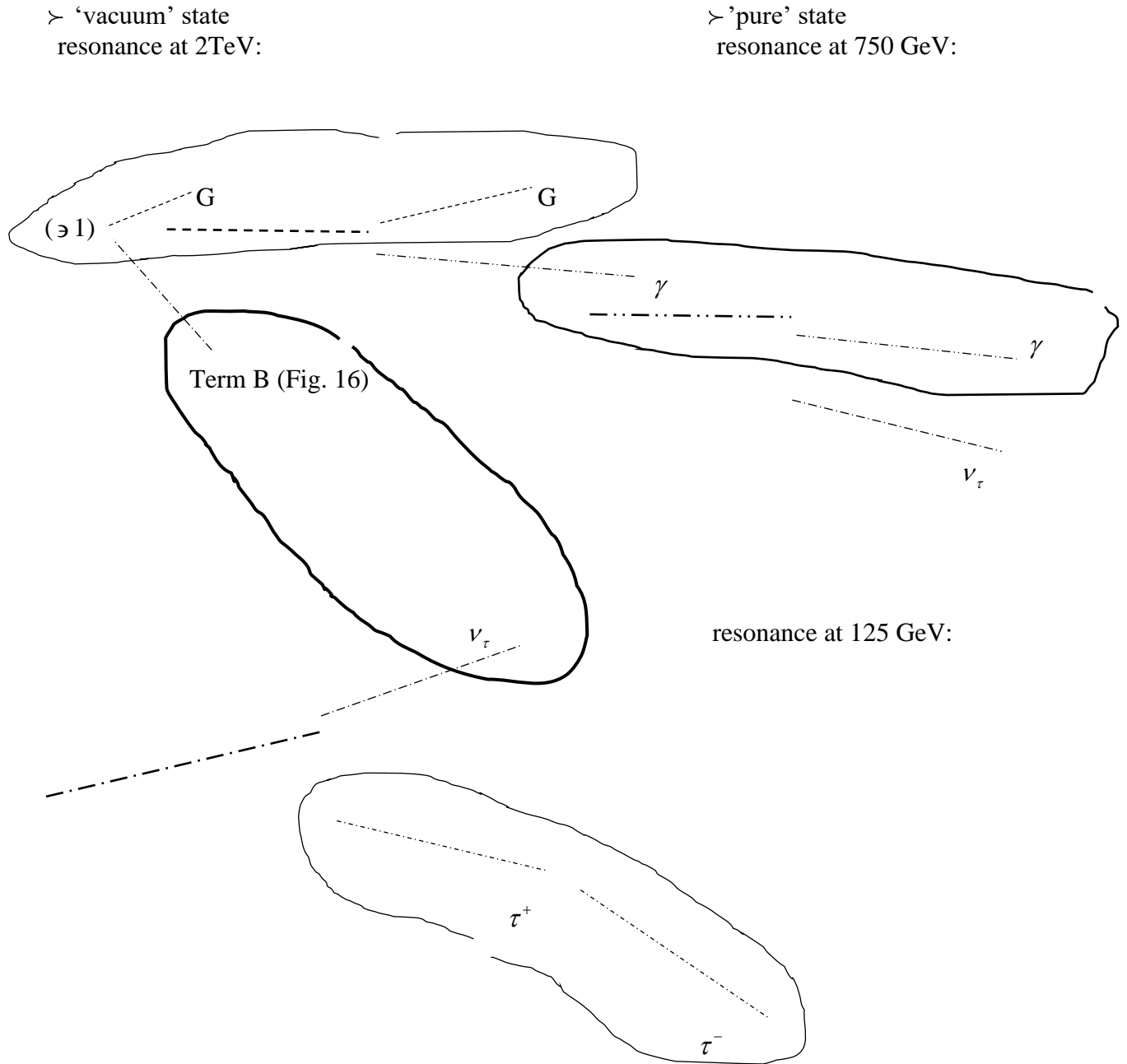

Fig. 19 Dark boson decay
 a) ϕ^M channel;
 b) $\tau^+\tau^-$ pair.

8. On the subject of fermion masses.

Within the framework of the specified mechanism the general consideration (as ref. Chapter IV, paragraph iv, full details are outside of the research scope) appears for the Yukawa coupling term as following (Ivo van Vulpen, 2014):

$$-L_{Yukawa}(\Phi, \left| \begin{matrix} \varphi^D \\ \varphi^M \end{matrix} \right.) = \left| \varphi^D \right. g \overline{\varphi^D} \Phi \varphi^D = g \overline{\varphi^D} \left[C + (t_{ii}^{-1} \delta_k^i + g^{ik}) A_{ik} \right] \varphi^D \quad (C 8.1)$$

where

φ^D denotes Dirac field;

φ^M denotes Majorana field.

Substituting (1.1 b) and (A 2.1) into (C 8.1), obtain:

$$\begin{aligned} -L_{Yukawa}(\Phi, \left| \begin{matrix} \varphi^D \\ \varphi^M \end{matrix} \right.) &= g \overline{\varphi^D} C \varphi^D + g \overline{\varphi^D} (t_{ii}^{-1} \delta_k^i + g^{ik}) A_{ik} \varphi^D = \\ &g \overline{\varphi^D} (\nu + \xi) \varphi^D + g \overline{\varphi^D} (t_{ii}^{-1} \delta_k^i + g^{ik}) A_{ik} \varphi^D = \\ &g \nu \overline{\varphi^D} \varphi^D + g \left[\overline{\varphi^D} \xi \varphi^D + \overline{\varphi^D} (t_{ii}^{-1} \delta_k^i + g^{ik}) A_{ik} \varphi^D \right] = \\ &g \nu \overline{\varphi^D} \varphi^D + g \left[\xi + (t_{ii}^{-1} \delta_k^i + g^{ik}) A_{ik} \right] \overline{\varphi^D} \varphi^D \end{aligned} \quad (C 8.2)$$

In (C 8.2) first term is the mass term for a fermion with mass $g\nu$;

Dirac (Majorana) field interaction with tensor- gravitational and goldstone-dark components of scalar field Φ is denoted in the second term.

9. On the subject of Hawking radiation.

Hawking radiation can be explained in the framework of the new bosonic mechanism using the approach outlined in Appendix A5, paragraph 2.1. Fig. 7, which outlines the existence of barrier - b.h.

Fig. 18 bellow depicts the mechanism of changing effective photon mass (ref. Appendix C, paragraph 1.3, item 1.2) as a result of the renormalization on the barrier-b.h. (ref. note: Appendix A5, paragraph 3).

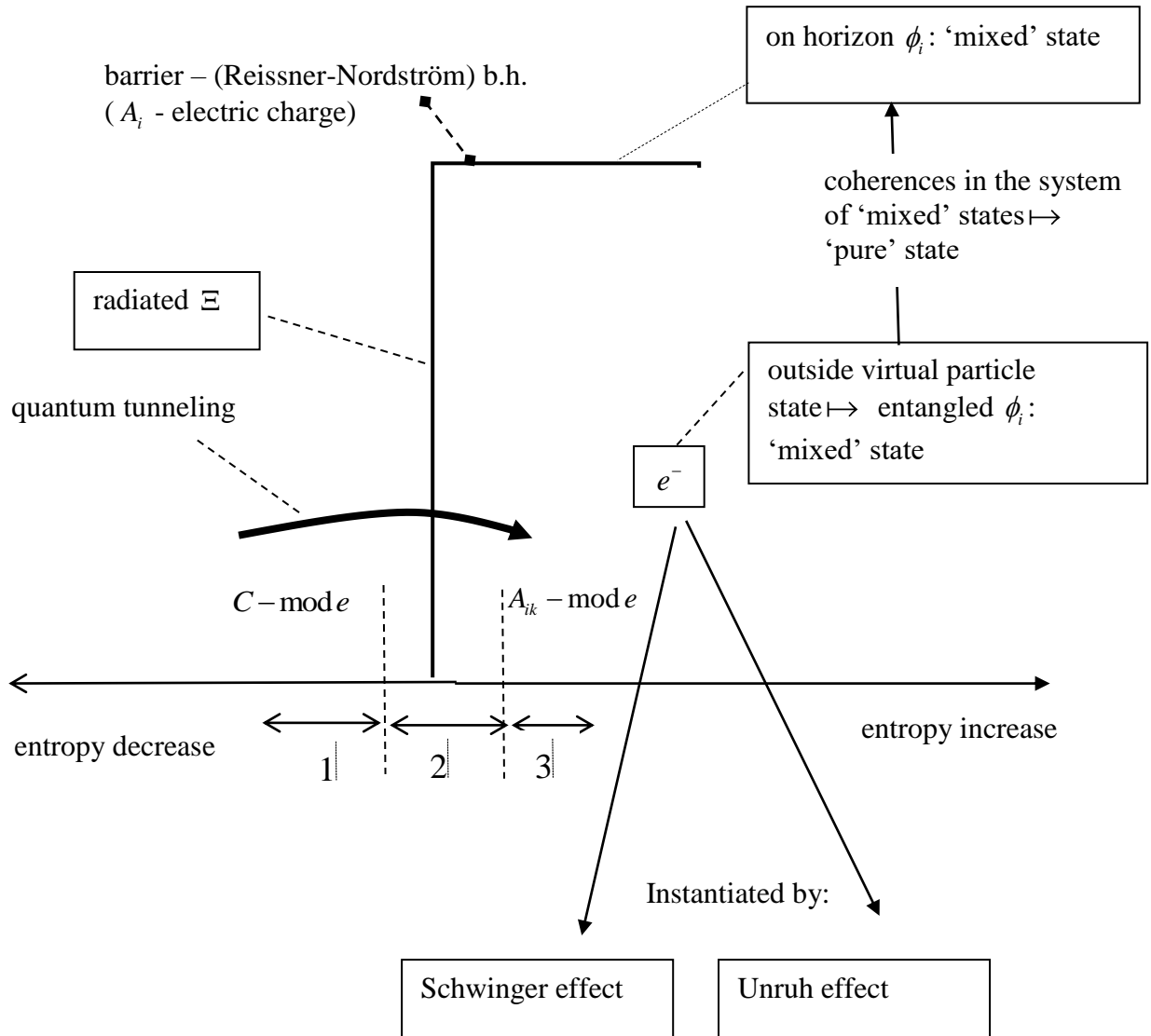

Fig. 18 Renormalization of photon mass on barrier-b.h.

Dark matter (particle), which is charged b.h. radiates Ξ (dark boson, which is a quant of dark field and a gauge boson of interaction between particles of dark matter).

Quantum tunneling for dark boson results in appearance of virtual e^- (Dirac sea) instantiated either by Schwinger or Unruh effects, which corresponds to entangled photon ϕ_i .

Fig.18 above presents the following correspondences:

area 1 \mapsto ‘vacuum’ state: $\neg\exists\phi_i; \forall\Xi$;

area 2 \mapsto ‘mixed’ state: $\exists\phi_i = 0; \forall\eta = h - i\Xi$;

area 3 \mapsto ‘pure’ state: $\exists\phi_i \neq 0; \forall h_{ik} = g_{ik} h \propto \frac{\delta_i^k}{g^{ik}} h; A_i \mapsto A_k \dot{;}_{\tau}$

$$\} \Rightarrow A_i h_{ik} A_k = A_k \dot{;}_{\tau} \frac{h}{g^{ik}} A_k \delta_i^k .$$

The appearance of quantum tunneling (area 1 \rightarrow area 2 \rightarrow area 3) is due to the fact that there is no ground state (Φ^3 type) in barrier-b.h. (ref. M. Srednicki, 2006).

10. On the renormalizability of the theory Lagrangian.

The following correspondence exists within the theory framework:

$$\text{case } \phi_i = 0 \mid C_{jlk}^i = 0 \qquad \text{case } \phi_i \neq 0 \mid C_{jlk}^i \neq 0 \qquad (\text{A 2.1})$$

$$i\Pi_k = \frac{\partial}{\partial x_k}$$

$$\text{contr}(A_{ik}) = t_{ii}\Xi$$

$$C = \nu + \xi$$

$$i\Pi_k = \frac{\partial}{\partial x_k} - ie\phi_k$$

$$A_{ik} = ih_{ik}$$

$$C = \nu + \xi + i\xi'$$

where,

a wave-field A_{ik} is a symmetrical tensor of the second rank;

C is an auxiliary scalar field;

C_{jlk}^i is Weyl curvature tensor;

ϕ_i is electromagnetic field.

The following formula includes scalar field Φ :

$$\Phi(x) = \nu + \xi(x) + i\eta(x) \qquad (1.1)$$

where,

$\xi(x)$ is vacuum state (coincides with Goldstone field);

ξ field assumes a certain value ν , i.e. a value of the ξ field viz., the potential energy is zero but the value of the ξ field is nonzero;

ν - shift ^{note} in field $\Phi(x)$ corresponds to the vacuum state ξ which contains no particles:

vacuum state (a vacuum expectation value of a scalar field) \mapsto

ν expectation value which breaks the internal symmetry of a vacuum, i.e. spontaneous symmetry breaking occurs \mapsto

spontaneous symmetry breaking of the underlying global symmetry leads to the conversion of components of this ξ field to Goldstone bosons;

note.

have to differentiate the postulated Higgs field from a vacuum state, so ν is due to a vacuum state and not the Higgs field.

end_note

$\eta(x)$ is gravitational –dark field. It is complex due to the interaction with a Goldstone field;

$$\eta(x) = h(x) - i\Xi(x) \quad (1.1 a)$$

$h(x)$ is tensor-gravitational field $h\left\{\left(\equiv \langle g^{ik} \rangle h_{ik}\right), \langle \quad \rangle$ - vacuum value $\right\}$ which is scalar;

h_{ik} is gravitational field part, i.e. massless tensor spin 2 field;

$\Xi(x)$ is dark field part, i.e. massless scalar spin 0 field (dark boson);

The negative sign before the second term is important, which points out that dark energy is negative.

Eq. (1.4.1 c) describes the interaction of the gravitational field and the Goldstone field with the electromagnetic field ϕ_i

$$\begin{aligned} L_{FP} = & \frac{\partial A_{ik}}{\partial x_l} \frac{\partial A_{ik}^*}{\partial x_l} + e^2 \phi_l^2 A_{ik} A_{ik}^* - 2 \frac{\partial A_{rk}}{\partial x_r} \frac{\partial A_{sk}^*}{\partial x_s} - 2e^2 \phi_r \phi_s A_{rk} A_{sk}^* + \frac{1}{2} \frac{\partial A_{rk}}{\partial x_r} \frac{\partial C^*}{\partial x_k} + \frac{1}{2} e^2 \phi_r \phi_k A_{rk} C^* + \\ & \frac{1}{2} \frac{\partial A_{rk}^*}{\partial x_r} \frac{\partial C}{\partial x_k} + \frac{1}{2} e^2 \phi_r \phi_k A_{rk}^* C - \frac{3}{8} \frac{\partial C}{\partial x_l} \frac{\partial C^*}{\partial x_l} - \frac{3}{8} e^2 \phi_l^2 C C^* + \\ & i \left\{ e\phi_l A_{ik}^* \frac{\partial A_{ik}}{\partial x_l} - e\phi_l A_{ik} \frac{\partial A_{ik}^*}{\partial x_l} - 2e\phi_s A_{sk}^* \frac{\partial A_{rk}}{\partial x_r} + 2e\phi_r A_{rk} \frac{\partial A_{sk}^*}{\partial x_s} + A_{rk} A_{ik}^* \frac{\partial \phi_r}{\partial x_i} - A_{rk} A_{ik}^* \frac{\partial \phi_i}{\partial x_r} + \frac{1}{2} e\phi_k C^* \frac{\partial A_{rk}}{\partial x_r} - \right. \\ & \left. \frac{1}{2} e\phi_r A_{rk} \frac{\partial C^*}{\partial x_k} - \frac{1}{2} e\phi_k C \frac{\partial A_{rk}^*}{\partial x_r} + \frac{1}{2} e\phi_r A_{rk}^* \frac{\partial C}{\partial x_k} - \frac{3}{8} e\phi_l C^* \frac{\partial C}{\partial x_l} + \frac{3}{8} e\phi_l C \frac{\partial C^*}{\partial x_l} \right\} \end{aligned} \quad (1.4.1 c)$$

Eq. (A 2.0) describes the gravitational field and the Goldstone field without interaction with the electromagnetic field ϕ_i

$$L_{FP} = k^2 A_{ik} A_{ik} + \frac{\partial A_{ik}}{\partial x_l} \frac{\partial A_{ik}}{\partial x_l} - 2 \frac{\partial A_{rk}}{\partial x_r} \frac{\partial A_{sk}}{\partial x_s} - \frac{3}{4} k^2 C^2 - \frac{3}{8} \frac{\partial C}{\partial x_l} \frac{\partial C}{\partial x_l} + \frac{\partial A_{rk}}{\partial x_r} \frac{\partial C}{\partial x_k} \quad (A 2.0)$$

When $\phi_i = 0$:

Eq. (0.1.1)

$$L(\Phi) = |\partial\Phi|^2 - \lambda(|\Phi|^2 - \nu^2)^2 \quad (0.1.1)$$

is compared to eq. (A 2.0);

By virtue of Goldstone theorem ($k_\xi = 0$) and ref. eq. (1.3 a) below

$$L = \frac{1}{2}(\partial_i \zeta)^2 + \frac{1}{2}(\partial_i h)^2 - \frac{1}{2}\lambda\nu^2\zeta^2 - \frac{1}{2}\lambda\nu\zeta(\zeta^2 + h^2) - \frac{1}{8}\lambda(\zeta^2 + h^2)^2 \quad (1.3 a)$$

The following is obtained:

$$2\lambda\xi^2\nu^2 = k_\Xi^2 \left(\langle g^{ik} \rangle \right)^2 A_{ik}^2 \quad (A 2.2.1)$$

i.e., $k_\Xi \sim \sqrt{\lambda}\nu$ (if quartic interaction terms are omitted and the constant terms are contracted), masses for dark field (ref. eq. (1.3 b)) are obtained.

In eq. 1.3 a, shifted Goldstone-dark field is defined as

$$\zeta(x) = \nu + \xi(x) + \Xi(x) \quad (1.3 b)$$

$\nu < 0$ corresponds to dark energy; $\nu > 0$ corresponds to gravitational energy;

massless (k_h) for h and mass ($k_\zeta \equiv$) $\sqrt{\lambda}\nu$ for ζ .

k_Ξ appears as a result of obtaining mass by a dark field, i.e. $k_\Xi = k_\zeta$; ansatz Goldstone boson does not disappear.

When $\phi_i \neq 0$:

Eq. (0.1.2)

$$L(\Phi, \phi) = -\frac{1}{4} F^{ik} F_{ik} + |D\Phi|^2 - \lambda(|\Phi|^2 - v^2)^2 \quad (0.1.2)$$

where,

$$F_{ik} = \partial_i \phi_k - \partial_k \phi_i;$$

ϕ_i is a covariant four-potential of the electromagnetic field;

the interaction with photons via minimal substitution (ref. 4.8 Problems; (M. Kachelrieß, 2010)

$$D_i \Phi = \partial_i \Phi + ie\phi_i \Phi;$$

is compared to eq. (1.4.1 c).

By virtue of dark field, which does not interact with electromagnetic field, therefore Goldstone-dark field can be omitted altogether and ref. eq. (1.5) below

$$L = -\frac{1}{4} F_{ik} F^{ik} + \frac{1}{2} (\partial_i \zeta)^2 + \frac{1}{2} (\partial_i h + e v \phi_i)^2 - \frac{1}{2} \lambda v^2 \zeta^2 - \frac{1}{2} \lambda v \zeta (\zeta^2 + h^2) - \frac{1}{8} \lambda (\zeta^2 + h^2)^2 \quad (1.5)$$

The following is obtained

$$\frac{1}{2} (\partial h_{ik} + e A_{ik} v)^2 = k_h^2 A_{ik}^* A_{ik} \quad (A 2.2.2)$$

where

k_h ($k_h \equiv$) $e v$ for h ^{note1} is a massive gravitational field;

k_ζ ^{note2} ($k_\zeta \equiv$) $\sqrt{\lambda} v$ for ζ is a massive Goldstone-dark field.

note1:

$$h \mapsto \phi_i + \frac{1}{e\nu} \partial_i h;$$

when Ricci theorem is applied for tensor analysis the following is obtained: $\phi_i + \frac{1}{e\nu \langle g_{ik} \rangle} \partial_i h_{ik}$

note2:

the k_ζ is not related to ϕ_i , i.e., it does not contain charge e since dark field does not interact with an electromagnetic field;

k_ξ appears as a result of obtaining mass by Goldstone boson, i.e., $k_\xi = k_\zeta$.

end_note

Thus, it is confirmed that mass terms in eqs. (A 2.0) and (1.4.1 c) correspond to mass terms in eqs. (1.3 a) and (1.5) and have the same values respectively.

This correspondence is a proof that current theory Lagrangian (1.4.1 c) (\leftrightarrow (1.5)) is of Φ^4 type^{*note*}. Renormalizability of the interacting Lagrangians in four space-time dimensions, which contains a symmetric tensor field (1.4.1 c), is proved in five dimensions.

The existence of the fifth dimension appears as a required mathematical condition for the Lagrangian of the theory to be renormalizable.

note

The replacement of the original Lagrangian by one for scalars only is an approximation.

end_note

In the framework of the specified mechanism:

i. dark field represents the fifth dimension possessing a dark-like Killing field, which breaks the symmetry into four dimensions. As follows from the notes (ref. Witten, 2014), this dimension can be introduced in a non-contradictory way that is still referenced from a physical standpoint to four dimensions.

The physics of the fifth dimension appears as a Lorentz violation and the mechanism of cancellation of this violation is presented in Appendix C, paragraph 1.

ii. dark-like Killing field corresponds to the conserved quantity, i.e. dark energy.

Thus, the renormalizability of the theory is formulated in the five-dimensional space.

11. Time reversal symmetry violation and Katz schema.

Appendix C- Supplementary Chapter: On the subject of Lorentz violation presented mechanism of CP -violation compensation. This addendum addresses T -invariance violation.

1. This addendum presents the definition of current ${}^T j$, which defines T -invariance violation as a set of events on the corresponding path. This set of events is determined by the entropy of the events on the noted corresponding path (ref. eq. (A 4.5) - (A 4.7)), i.e.,

on direct path: $\exists K$ -set of events and entropy are defined by K - set of events;

$${}^{T(K)} j = - \sum_{k \in K} \delta(x - x_k) \int_{-\infty}^{\infty} f(x) \log_a f(x) dx \quad (\text{C 11.1})$$

on restoring path: $\exists L$ -set of events and entropy are defined by L - set of events;

$${}^{T(L)} j = - \sum_{l \in L} \delta(x - x_l) \int_{-\infty}^{\infty} f(x) \log_a f(x) dx \quad (\text{C 11.2})$$

thus, resulting ${}^{T(K \setminus L)} j$ current is denoted as

$${}^{T(K \setminus L)} j = - \sum_{k, l \in K \setminus L} \delta(x_k - x_l) \int_{-\infty}^{\infty} f(x) \log_a f(x) dx \quad (\text{C 11.3})$$

2. The electromagnetic energy flux of ‘inference topology’ is defined by:

$$\succ \vec{S}^{(+)} | \{K \cap L\} = \rho \vec{v} = \rho \left[\int_{T(K)}^{T(L)} dt (\vec{v} \nabla) \vec{v} + \vec{f} \right] \quad (\text{C 11.4})$$

direct path - ‘pure’ state \mapsto restoring path - ‘mixed’ state, ref. Appendix A5, eq. (A 5.0.1) in mass part; for the following conditions: 1) vortex solution (corresponding to case of inviscid flow, i.e. ideal flow) and 2) without internal sources;

$$\succ \vec{S}^{(-)} | \{K \setminus L\} \quad (\text{C 11.5})$$

(ref. Appendix A - Additions Chapter, eq. (26) in tunnel);

thus, obtaining total energy flux through ‘inference topology’, which is defined by:

$$\vec{S} | \{K \cap L\} \cup \{K \setminus L\} = \vec{S}^{(+)} + \vec{S}^{(-)} \quad (\text{C 11.6})$$

3. Noted current and electromagnetic energy flux are used to further develop physical program for Katz schema. T -invariance violation applies to ‘inference topology’ as follows:

\succ in mass part, i.e. in sets K, L (ref. eqs. (C 11.1) -(C 11.2)) where ${}^{T(K)}j \neq 0$,
 ${}^{T(L)}j \neq 0 \mapsto \exists T$ - violation.

Case $K \cap L$ resulted in different (${}^{T(K)}j \neq {}^{T(L)}j$) T -invariance violations on direct path (ref. eq. (C 11.1)) and restoring path (ref. eq. (C 11.2)), thus determining the direction of current in mass part of ‘inference topology’ (ref. Fig.1).

\succ in tunnel, i.e. in set $K \setminus L$ (ref. eq. (C 11.3)) where ${}^{T(K \setminus L)}j = 0$ (${}^{T(L)}j \neq 0$)
 $\mapsto \neg \exists T$ -invariance violation.

Compensation of T -invariance violations exists in a tunnel and expressed by eq. (C 11.3).

■

Thus, the condition for preserving T -invariance in tunnel (${}^{T(K \setminus L)}j = 0$; ${}^{T(L)}j \neq 0$) implies that energy flux \vec{S} through ‘inference topology’ is constant at the reduction of volume (mass part); ref. paragraph 5: Vacuum structure in the tunnel, note 1 (Katz schema).

■

4. Further consideration of T -invariance violations will define the notion of time within framework of the specified mechanism.

Inconsistency in sets of events $K \cap L$ on direct k path and restoring l path is mathematically expressed in different values of wave function $\Psi_k(q_k, t; q_l, \alpha_1)$,

$$\Psi_l(q_l, t; q_k, \alpha_1)$$

ref. Appendix B- Extensions Chapter, eq. (B 0.5).

Let’s consider probability current on $k \leftrightarrow l$ paths:

$$\Psi_{k \leftrightarrow l} j_{k \leftrightarrow l} = \frac{\hbar}{m} \text{Im}(\Psi_k^* \vec{\nabla} \Psi_l) \neq 0 \quad (\text{C 11.7})$$

where m denotes mass part of ‘inference topology’;

Eq. (C 11.7) implies that a physical field is required to compensate for existence of $j_{k \leftrightarrow l}$, thus leading to

$$\Psi_{k=L} j_{k \leftrightarrow l} = 0 \Rightarrow k = l;$$

the condition where $k = l$ corresponds to compensation of T -invariance violation.

k, l is indistinguishable under the following conditions:

$$\succ \Psi_{k=L} j_{k \leftrightarrow l} = 0, \text{ thus preserving probability of events } K \cap L;$$

$$\succ k_{\text{directpath}} = l_{\text{restoringpath}}, \text{ thus preserving reversibility of events } K \cap L.$$

■

The above noted field is time.

■

↔ Consequently, combined mechanisms of compensation of CP-violation and T-violation constitute the mechanism of restoring of CPT invariance.

REFERENCES

- V. Fierz and W. Pauli, Proc. Roy. Soc. London. A **173**, 211-232 (1939).
- B. de Wit and D. Freedman, Phys.Rev. D **21**, 358-367 (1980);
- S. Elitzur, Phys. Rev. D **12**, 3978-3982 (1975).
- M.S. Turner and F. Wilczek , *Nature* **298** (5875), 633–634 (1982).
- J. Rosen, Comment: The symmetry principle, Entropy **7**, 308-313 (2005).
- M. Dine, T. Banks and S. Sachdev, *String Theory and Its Applications TASI 2010 From meV to the Planck Scale* (World Scientific, 2012).
- F. Mandl and G. Shaw, *Quantum Field Theory* (Wiley, 2010);
also: R. Durka, *Higgs mechanism and Goldstone's bosons* (Instytut Fizyki Teoretycznej, Wrocław, 2008);
Ivo van Vulpen (2014) www.nikhef.nl/~ivov/HiggsLectureNote.pdf [2014, June 6].
- T. Banks, *Modern Quantum Field Theory A Concise Introduction* (Cambridge University Press, 2008).
- M. Kachelrieß, *Advanced Quantum Field Theory* (Department of Physics, NTNU Trondheim Norway, 2010).
- J. Thaler, (2003) <http://v1.jthaler.net/physics/notes/btsm/GravityUnitarity.pdf> [2013, Nov.15].
- A.S. Davidov, *Quantum Mechanics* (Moscow: Nauka, 1973) 2nd ed.; English ed. (Pergamon Press, 1976), 2nd ed.
- G. 't Hooft, arXiv: hep-th/0708.3184 (2008).
- M. Baker and R. Steinke, arXiv:hep-th/9905375v2.
- B. Janssen, *From Fierz-Pauli to Einstein-Hilbert* (Gravity as a special relativistic field theory, UGR & CAFPE, 2006).
- A.I. Vainshtein, Phys. Lett. **39B**, 393-394 (1972).
- S. Deser, General Relativity and Gravitation **1**, 9-18 (1970).
- D. G. Boulware and S. Deser, Phys. Rev. D **6**, 3368-3382 (1972).
- B. Altschul, Q. G. Bailey and A. Kostelecky, arXiv: gr-qc/0912.4852 (2009).

- S. Coleman and J. Mandula, Phys. Rev. **159**, 1251-1256 (1967).
- K. Anguige and K.P. Tod, arXiv:gr-qc/9903008 (2008).
- F. Zwicky, *Cosmic and terrestrial tests for the rest mass of gravitons*, Publications of the Astronomical Society of the Pacific **73**, 314-317 (1961);
also: S. Fujita, T. Kimura and Y. Zheng, Found. Phys. **21**, 1117- 1130 (1991).
- G. Fodor, P. Forgács and P. Grandclément, Relativity and Gravitation 157,
doi: 10.1007/978-3-319-06761-2 (2014).
- G. Rosen, Europhys. Lett. **89**, 19002 (2010).
G. Rosen, Proceeding of the International Workshop on Physics and Mathematics (IWPM 2011);
also: G. Rosen, J. Math. Phys. **6**, 1269 - 1272 (1965).
G. Rosen, J. Math. Phys. **8**, 573 – 575 (1967).
- S. Weinberg, Phys. Rev. **138**, B988-1002 (1965).
- A.S. Fulling, Phys. Rev. D **7**, 2850 - 2862 (1973).
- N.H. Katz and N. Pavlovic, Trans. Am. Math. Soc. 357, 695-708 (2004);
also: Y. Habara, Y. Nagatani, H.B. Nielsen and M. Ninomiya, arXiv: hep-th/0603242;
hep-th/0607182 (2007).
- J. Eggers and M. A. Fontelos, *Singularities: Formation, Structure, and Propagation* (Cambridge University Press, 2015).
- M.E. Peskin and D.V. Schroeder, *An Introduction To Quantum Field Theory* (Westview Press, 1995);
C. Itzykson and J-B. Zuber, *Quantum Field Theory* (McGraw-Hill, 1980).
- C.R. Hagen, Phys. Rev. D **6**, 984-987 (1972).
- I.E. Tamm, *Fundamentals of The Theory of Electricity* (Mir, 1979).
- P. Würfel, Journal of Physics and Chemistry of Solids **49**, 721-723 (1988).
- T. Jacobson, arXiv:gr-qc/9504004 (1995).
- G. Zumbach, Physics Letters A **200**, 257-263 (1995).
Topological Defects, (No date) [www. damtp.cam.ac.uk/research/gr/public/cs_top.html](http://www.damtp.cam.ac.uk/research/gr/public/cs_top.html)
[2014, Nov. 11];
also: The Kibble-Zurek mechanism.
- A.A. Vladimirov and D.V. Shirkov, Usp. Fiz. Nauk **129**, 407-441 (1979).

C. Grebogi, E. Ott and J.A. Yorke, Phys. Rev. Lett. **57**, 1284-1287 (1986).

Physics **6**, 138 (2013) | doi: 10.1103/Physics.6.138; in: D. Vorberg, W. Wustmann, R. Ketzmerick and A. André Eckardt, Phys. Rev. Lett. **111**, 240405 (2013).
M. Golubitsky and D. Schaeffer, *Singularities* **40** (1), 499-515 (1983).

V.S. Olkhovsky and E. Recami, Nuovo Cimento, **22A**, 263-277 (1974);
experiment: J. Steinhauer, arXiv: cond-mat.quant-gas/1409.6550 (2014).

G. 't Hooft, Nucl. Phys. B **335**, 138-154 (1990).

E. Nelson, Phys.Rev. **150**,1079-1085 (1966).

I. Pikovski, M. Zych, F. Costa and Č. Brukner, Nature Physics, doi:10.1038/nphys3366 (2015).

C. Grebogi, E. Ott, F. Romeiras and J.A. Yorke, Phys. Rev. A **36**, 5365-5380 (1987).

experiment: G.W.Fraser, et.al., arXiv: astro- ph.HE/1403.2436 (2014);
also: C. Bonvin, R. Durrer and R. Maartens, Phys. Rev. Lett.**112**, 191303 (2014).

J.Garecki, Acta Physica Polonica B **4**, 347-351(1973).

A. Bassi, K. Lochan, S. Satin, T. P. Singh and H. Ulbricht, Rev. Mod. Phys. **85**, 471-527 (2013).

H.P. Baltes and F.K. Kneubuhl, Helvetica Physica Acta **45**, 481-528 (1972).
V.S. Pekar, Journal of Experimental and Theoretical Physics **67**, 471 (1974).

V.G. Barjachtar and S.V. Peletminsky, Proceeding of Colleges. Radio-physics **6**, 1115 (1963).

F.T. Vasko, Solid State Physics **30**, 2092 (1988).

V.B. Berestetsky, E.M. Lifshyts and L.P. Pytayevsky, *Quantum Electrodynamics* (Moscow: Nauka, 1989).

V.F. Hantmacher and I.B. Levinson, *Scattering of Charge Carriers in Metals and Semiconductors* (Moscow: Nauka, 1984).

R.N. Mantegna and H.E. Stanley *Introduction to Econophysics* (Cambridge: Cambridge Univ. Press, 2000).

D. Rickles, *Econophysics and the Complexity of Financial Markets*, (J.Collier and C. Hooker ,eds. Handbook of the Philosophy of Science, vol.10: Philosophy of Complex Systems. North Holland: Elsevier, 2007).

A. Khrennikov, Physics Letters A **357**, 171-176 (2006).

- D. Dürr, S. Goldstein and N. Zanghi, *Physics Letters A* **172**, 6-12 (1992).
- P.E. Kloeden and E. Platen, *Numerical solution of stochastic differential equations* (Berlin; New York: Springer-Verlag, 1992).
- W. Seagal and I.E. Seagal, *Proc. Natl. Acad. Sci. USA* **95**, 4072-4075 (1998).
- N.C. Petroni and M. Pusterla, *Physics A* **388**, 824-836 (2009).
- K. Ilinski, *Physics of Finance: Gauge Modelling in Non-equilibrium Pricing*, (John Wiley & Sons, LTD, 2001).
- P. Bak, S.F. Norrelykke and M. Shubik, *Physical Review E* **60**, 2528-2532 (1999).
- D. Wurtz, Y. Chalabi and Y. Luksan, *Journal of Statistical Software*:
faculty.washington.edu/ezivot/econ589/WurtzEtAlGarch.pdf, 1-40 (2002).
- L.V. Keldysh, *Zh. Eksp. Teor. Fiz.* **47**, 1515-1527 (1964).
- O.A. Choustova, *Physica A* **374**, 304-314 (2007); O.A. Choustova, *Journal of Physics: Conference Series* 70: 012006 (2007). doi:10.1088/1742-6596/70/1/012006.
- E. Haven, *Physica A* **324**, 201-206 (2003).
- B.E. Baaquie, *Quantum Finance: Path Integrals and Hamiltonians for Options and Interest Rates* (Cambridge University Press, 2004).
- S. Lang, *Algebra* (Reading: Addison-Wesley, 1984).
- F. Allen, S.C. Myers and R. A. Brealey, *Principles of Corporate Finance* (Irwin: McGraw-Hill, 2006) 8 th ed.
- T. Tao, (No date) www.math.ucla.edu/~tao/preprints/schrodinger.pdf
 [2014, Dec. 20];
 also: A.R. Bishop, M.G. Forest, D.W. McLaughlin and E.A. Overman II, *Physics Letters A* **144**, 17-25 (1990).
- G.C. Lamoureux and W.D. Lastrapes, *Journal of Finance* **45**, 221-229 (1990).
- R. Prado and M. West, *Time Series: Modeling, Computation, and Inference* (CRC Press, 2010).
- N. Sandgren and P. Stoica (2006)
www.it.uu.se/research/publications/reports/2006.../2006-022-nc.pdf [2013, May 20];
20th European Signal Processing Conference (EUSIPCO), Bucharest, Romania,
 2012, p. 2348-2351.

- A.P. Prudnikov, Yu.A. Brychkov and O.I. Marichev, *Integrals and Series, Volume 1: Elementary Functions* (Gordon and Breach Science Publishers, 1986).
- S. Solomon, *Nature* (2002). doi:10.1038/news020923-18.
- M. Coppejans and I. Domowitz, (1999) www.itg.com/news_events/papers/omx4.pdf [2013, June 13].
- M. Pacurar, (2006) <http://neumann.hec.ca/gestiondesrisques/06-10.pdf> [2013, June 13].
- M. Veltman, *The LHC and the Higgs Bosson* (Instituto de Física Teórica IFT). [2013, March 11].
- A. Chantasri, J. Dressel and A.N. Jordan, *Physical Review A* **88**, 042110 (2013).
- D. H. Mahler, L. Rozema, K. Fisher, L. Vermeyden, K. J. Resch, H. M. Wiseman, A. Steinberg, *Science Advances* 2016; 2:e1501466.
- Z. Lu *Gauss-Bonnet Theorem on Moduli Spaces* (UC Irvine, 2009);
also: Z. Lu and M.R. Douglas, arXiv: math.DG/0902.3839 v1 (2009).
A.E. Fischer, arXiv: math/0312519v1 (2003).
- V.A Kostelecky and N. Russell, arXiv: hep-ph/0801.0287 v7 (2014);
also: V.A Kostelecky, (2014) www.physics.indiana.edu/~kostelec/faq.html [2014, October 30].
- B.R. Greene, C. Vafa and N.P. Warner, *Nuclear Physics B* **324**, 371-390 (1989).
- D. Gaiotto, S. Gukov and N.Seiberg, arXiv: hep-th/1307.2578 v1 (2013).
- Z.L. Gao and S.-T. Yau, *Inventiones Mathematicae* **85**, 637-652 (1986).
- D. Blas, M. M. Ivanov and S. Sibiryakov, arXiv: astro-ph.CO/1209.0464v1 (2012).
- F. Halzen and A.Martin, *Quarks and Leptons: An Introductory Course in Modern Particle Physics*(WILEY, 1984).
- V.A. Kostelecký, *Phys. Rev D* **69**, 105009 (2004).
- H.E. Stanley, *Phys. Rev. Lett.* **20**, 589-592 (1968);
also:H.E. Stanley, *Introduction to Phase Transitions and Critical Phenomena* (Oxford University Press, 1971).
- M. Sachs, *Quantum Mechanics and Gravity* (Springer, 2004).
- M. Srednicki, *Quantum Field Theory* (University of California, Santa Barbara, 2006).

E. Witten, arXiv: hist-ph/1401.8048 v1 (2014);
also: E. Cremmer and J. Scherk, Nuclear Physics B **103**, 399-425 (1976); **108**, 409-416 (1976).
j. Scherk and J.H. Schwarz, Physics Letters **52B**, 347-350 (1974).