



HAL
open science

Experimental Validation of Adjusting the Resonances of a Simplified Bass Clarinet Through Modal Active Control

Thibaut Meurisse, Adrien Mamou-Mani, Simon Benacchio, Victor Finel,
Baptiste Chomette, René Causse, David J. Sharp

► **To cite this version:**

Thibaut Meurisse, Adrien Mamou-Mani, Simon Benacchio, Victor Finel, Baptiste Chomette, et al..
Experimental Validation of Adjusting the Resonances of a Simplified Bass Clarinet Through Modal
Active Control. International Symposium on Musical Acoustics (ISMA2014), Jul 2014, Le Mans,
France. pp.1-1. hal-01161033

HAL Id: hal-01161033

<https://hal.science/hal-01161033>

Submitted on 8 Jun 2015

HAL is a multi-disciplinary open access archive for the deposit and dissemination of scientific research documents, whether they are published or not. The documents may come from teaching and research institutions in France or abroad, or from public or private research centers.

L'archive ouverte pluridisciplinaire **HAL**, est destinée au dépôt et à la diffusion de documents scientifiques de niveau recherche, publiés ou non, émanant des établissements d'enseignement et de recherche français ou étrangers, des laboratoires publics ou privés.



Experimental Validation of Adjusting the Resonances of a Simplified Bass Clarinet Through Modal Active Control

T. Meurisse^a, A. Mamou-Mani^a, S. Benacchio^a, V. Finel^a, B. Chomette^b, R. Caussé^c and D. Sharp^d

^aIRCAM, 1, place Igor Stravinsky, 75004 Paris, France

^bMPIA/d'Alembert, UMR CNRS 7190, UPMC Univ. Paris 06, Sorbonne Universités, 4 place Jussieu, 75005 Paris, France

^cIrcam UMR STMS & UPMC, 1 place Igor Stravinsky, 75004 Paris, France

^dThe Open University, Walton Hall, MK7 6AA Milton Keynes, UK
thibaut.meurisse@ircam.fr

This paper reports the experimental results of modifying the resonances of wind instruments using modal active control. Resonances of a simplified bass clarinet (a cylindrical tube coupled to a bass clarinet mouthpiece including a reed) are adjusted either in frequency or in damping in order to modify its playing properties (pitch, strength of the harmonics of the sound, transient behavior). This is achieved using a control system made up of a collocated loudspeaker and microphone linked by an observer, which contains a model of the system, and a controller. Modifications of the transfer function, input impedance and radiated sound of the instrument are obtained.

1 Introduction

This study aims at modifying the resonances of the air column of a musical wind instrument using modal active control [1]. It is achieved using a control system composed of a collocated microphone and speaker linked by a controller and an observer, which uses a state space representation of the system. This is a mathematical model which represents the system in terms of state variables (expressed as vectors and matrices) containing the modal parameters (frequency, damping) of the system. Modal active control enables the modal parameters of a system to be modified so that individual resonances can be adjusted to reach target frequency and damping values [2, 3]. Simulations have shown that the control of self-sustained oscillating systems such as a clarinet is theoretically feasible [4, 5]. There have been relatively few applications of modal active control to musical instruments [6, 7] and no application to wind instruments to the authors' knowledge.

In this paper, experimental results of modal active control applied to a simplified bass clarinet (a cylindrical tube coupled to a bass clarinet mouthpiece with a reed) are presented. The control is used with the intent of adjusting the resonances of the instrument, thereby altering the timbre of the sound it produces as well as its playing properties. Such adjustments provide similar effects to those that would result from modifying the instrument's bore profile [8].

In Section II, the state-space representation of the resonator of the simplified instrument (i.e. a cylindrical tube) used by the observer of the control system is presented, as well as the principle of the modal control. In Section III, the controlled simplified bass clarinet with incorporated collocated microphone and speaker, as well as measurements of the effects of the control on the transfer function, input impedance and radiated sound of the instrument are presented. In a first example, the control aims at decreasing the frequency of the 7th resonance of the system, and in a second example, the control aims at increasing the damping of resonances 4 to 10. Finally, Section IV provides some conclusions and outlines the proposed next steps for the research.

2 State-Space Model

In this section, the state-space representation of the resonator is presented. This representation takes into account the excitation from the speaker of the active control system, as well as monitoring of the pressure by the microphone of the active control system. Finally, the designs of the observer and controller elements of the active control system are described.

2.1 The Resonator

Modal active control makes it possible to control the frequencies and damping factors of the modes of a system. To be able to apply modal active control, however, the system must be expressed in terms of a state-space model, comprising vectors and matrices which describe the system's dynamics. Here, a state-space model of the resonator of the simplified bass clarinet is described.

The state-space model of the cylindrical tube used in this paper is derived in [2] and can be found with more details in [4] and [5]. The diameter of the tube is sufficiently small compared with its length L_t , that the tube can be considered to be a one-dimensional waveguide with spatial coordinate z , where $0 \leq z \leq L_t$. In the model, the speaker element of the control system is positioned at $z = z_s$ and the microphone at $z = z_m$. The microphone and speaker are collocated ($z_s = z_m$).

The pressure in the tube, with the speaker incorporated in the tube wall, is described by the nonhomogeneous equation [2]:

$$\frac{1}{c^2} \ddot{p}(z, t) = p''(z, t) + \rho_0 \dot{v}_s(t) \delta(z - z_s) \quad (1)$$

where p is the acoustic pressure, v_s the speaker baffle velocity, ρ_0 the density of the acoustic medium and δ the Kronecker delta. The $''$ symbol represents the second order spatial derivative and the $\dot{}$ and $\ddot{}$ symbols represent respectively the first and second order time derivatives. $\rho_0 \dot{v}_s$ represents the command sent by the control speaker.

In order to project eq.(1) in the modal base, let

$$p(z, t) = \sum_{i=0}^{\infty} V_i(z) q_i(t) \quad (2)$$

where V_i is the modal shape of mode i and q_i the particle displacement of mode i inside the tube. To obtain a modal state-space description of the cylindrical tube, with embedded control system, truncated with r modes and including a proportional modal damping, let

$$\mathbf{x}(t) = [q_1(t) \dots q_r(t) \dot{q}_1(t) \dots \dot{q}_r(t)]^T \quad (3)$$

where $\mathbf{x}(t)$ is the state vector used in the linear model so that

$$\dot{\mathbf{x}}(t) = \mathbf{A}\mathbf{x}(t) + \mathbf{B}u_s(t) \quad (4)$$

$$y(t) = \mathbf{C}\mathbf{x}(t) \quad (5)$$

where $u_s(t)$ is the command produced by the controller and transmitted to the speaker, $y(t)$ is the output of the system, and

$$\mathbf{A} = \begin{bmatrix} \mathbf{0}_{r,r} & \mathbf{I}_{r,r} \\ -\text{diag}(\omega_i^2) & -\text{diag}(2\xi_i \omega_i) \end{bmatrix} \quad (6)$$

is the dynamical matrix which contains the frequencies ω_i and damping factors ξ_i of the resonances of the cylindrical tube for the i_{th} mode. The modal parameters of these modes

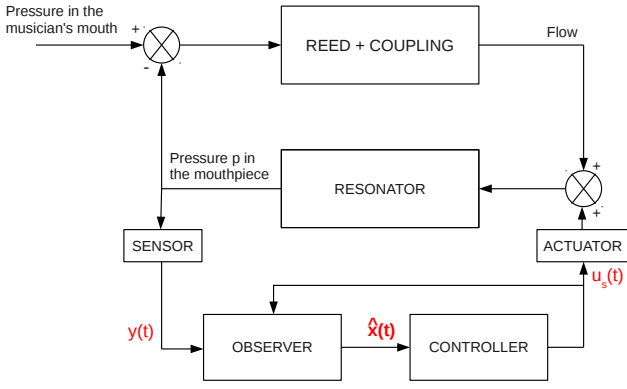

Figure 1: Model of a self-sustained wind instrument [9] with control system. $y(t)$ is defined in eq.(5), $u_s(t)$ is defined in eq.(9). $\hat{x}(t)$ is defined in eq.(12).

are extracted from a transfer function measured between the microphone and speaker of the control system with a Rational Fraction Polynomials (RFP) algorithm [10]. Meanwhile, $\mathbf{I}_{r,r}$ is the identity matrix,

$$\mathbf{B} = \begin{bmatrix} \mathbf{0}_{r,1} & K_s K_m V_1^2(z_s) & \dots & K_s K_m V_r^2(z_s) \end{bmatrix}^T \quad (7)$$

is the actuator matrix with K_s and K_m gains, considering that the transfer functions of the speaker and microphone are pure gains, $V_i(z)$ as described in eq.(2), $K_s K_m V_i^2(z)$ is identified between the speaker and the microphone with the RFP algorithm, and

$$\mathbf{C} = \begin{bmatrix} \mathbf{1}_{1,r} & \mathbf{0}_{1,r} \end{bmatrix} \quad (8)$$

is the sensor matrix.

2.2 Modal Control

Schematically, a self-sustained wind instrument is a reed coupled to a resonator (cylindrical tube) through a non linear coupling (see Figure 1). To apply modal active control to this resonator to modify its frequencies and damping factors, a control system composed of a collocated microphone and speaker linked by a Luenberger [11] observer and a controller is added to the resonator. The observer directly receives what is measured by the microphone; its role is to rebuild the state vector $\mathbf{x}(t)$ using a model of the system and the measurement $y(t) = p(t)$. Let $\hat{\mathbf{x}}(t)$ be the built state vector estimated by the Luenberger observer. $\hat{\mathbf{x}}(t)$ is used by the controller to generate a command $u_s(t)$ that is transmitted through the speaker in order to apply the control to the resonator. This command $u_s(t)$, the same as in eq.(4), can be expressed as

$$u_s(t) = -\mathbf{K}\hat{\mathbf{x}}(t) \quad (9)$$

where \mathbf{K} is the control gain vector used to move the conjugate poles s_i of the \mathbf{A} matrix, that is its eigenvalues, so that [12]:

$$Re(s_i) = -\xi_i \omega_i, \quad (10)$$

$$Im(s_i) = \pm \omega_i \sqrt{1 - \xi_i^2}. \quad (11)$$

\mathbf{K} is determined, together with the \mathbf{A} and \mathbf{B} matrices, using a pole placement algorithm (in this work, the algorithm

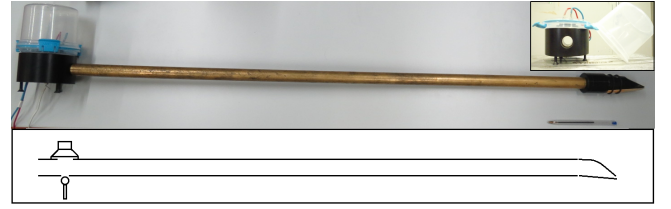

Figure 2: Top : Simplified bass clarinet (a cylindrical tube with a bass clarinet mouthpiece and a reed) with embedded control system with collocated microphone and speaker. Top right corner : control system removed from the instrument. Bottom : Schematic view of the instrument with embedded control system.

developed by Kautsky et al. [13] is used).

By using control gains \mathbf{K} , these poles can be moved in order to reach new, target values for the resonator's frequencies (angular frequencies ω_i) and damping factors (ξ_i). These new poles are the eigenvalues of $\mathbf{A} - \mathbf{BK}$.

The dynamics of the observer used to estimate the state of the system can be written

$$\dot{\hat{\mathbf{x}}}(t) = \mathbf{A}\hat{\mathbf{x}}(t) + \mathbf{B}u_s(t) + \mathbf{L}(y(t) - \hat{y}(t)), \quad (12)$$

$$\hat{y}(t) = \mathbf{C}\hat{\mathbf{x}}(t) \quad (13)$$

where \mathbf{L} is the observer gain vector. \mathbf{L} is chosen such that the error between the measurement and its estimation, $e_y(t) = y(t) - \hat{y}(t)$, converges to zero. It is calculated using the same pole placement algorithm than for \mathbf{K} , with the \mathbf{A} and \mathbf{C} matrices.

The instrument and experimental measurements are presented and discussed over the remainder of the paper.

3 Measurements

In this Section, the actual controlled system is presented. Then, examples of the effect of the control on the transfer function, the input impedance and the sound produced by the instrument are provided. In a first example, the control aims at decreasing the frequency of the 7th resonance of the system, and in a second example, the control aims at increasing the damping of resonances 4 to 10.

3.1 The Instrument

The controlled instrument is on Figure 2. It is a closed-open cylindrical tube with a bass clarinet mouthpiece and a reed at its closed end. Its length is 1.19 m and its radius 11 mm. The control system is composed of a collocated speaker and microphone and is placed 50 mm from the open end of the tube. The speaker is linked to the tube by a cylindrical cavity of length 5 mm and radius 20 mm and a hole of mean thickness 1.5 mm and radius 5 mm. The components used in the control system are a 2'' Tympany Peerless PLS-P830983 speaker and an Endevco piezoelectric pressure resistive model 8507C-5 microphone. The control is achieved using Simulink under Xenomai [14, 15], a real-time development framework cooperating with the Linux kernel, which allows a latency of about 20 μs when controlling 10 modes.

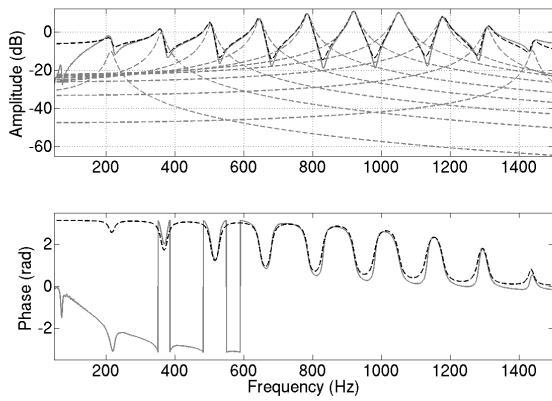

Figure 3: Top: Measured (solid grey line) and identified (dash black line) transfer functions of the tube, and 10 identified modes (dash grey lines). Bottom: Measured (solid grey line) and identified (dash black line) phase of the transfer functions of the tube.

Table 1: Modal parameters of the identified modes.

Mode	Freq. (Hz)	Damping	Mode	Freq. (Hz)	Damping
2	214	0.0448	7	920	0.0113
3	361	0.0262	8	1050	0.0115
4	504	0.0172	9	1177	0.0100
5	646	0.0141	10	1306	0.0083
6	785	0.0114	11	1439	0.0065

Figure 3 shows the transfer function measured between the microphone and the speaker of the control system, and the transfer function identified using a RFP algorithm. Ten modes are identified, from the second mode to the eleventh. Table 1 gives the modal parameters (frequency, damping) of the identified modes. The first mode of the tube (71 Hz) is not identified. This is due to the resonance frequency of the speaker (147.5 Hz) below which its response is very weak. It is also due to the position of the control system, close to the open end of the tube, where the first modes are low in amplitude. The second mode is not well identified, particularly with regards to its phase, with a difference of 0.62 rad, and results in the impossibility of controlling this mode. The 9 other modes are well identified. The acoustical cut-off frequency of the control system is approximately 1500 Hz. As a result, measurements have been limited to frequencies below this value.

3.2 Control of the 7th resonance frequency

In this Section, the frequency of the 7th resonance of the system is controlled, with the aim of decreasing it from 920 Hz to 860 Hz.

Figure 4 shows the transfer functions of the system, measured between the speaker and the microphone of the control system, without control and with the control applied. The effects of the control on the 7th peak are detailed in Table 2 (top). The frequency of the peak is close to the targetted frequency for the 7th resonance, with a difference of 2 Hz. However, moving the frequency of the peak has also resulted in a reduction in its amplitude. Effects on the other peaks are also observed when controlling the

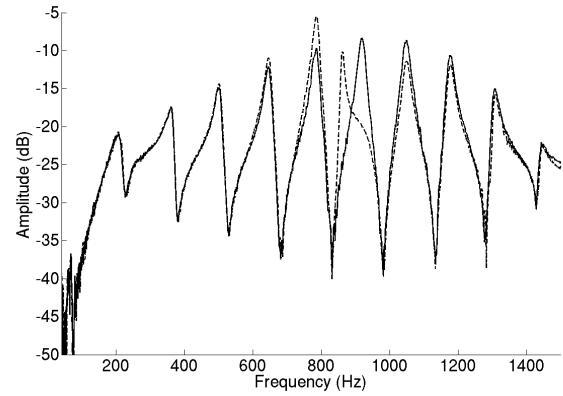

Figure 4: Transfer functions of the tube without control (solid black line) and the with control applied so that the frequency of the seventh resonance is decreased from 920 Hz to 860 Hz (dash black line).

Table 2: Frequency and amplitude of the seventh peak of the transfer functions (top) from Figure 4 and input impedances (bottom) from Figure 5 without control (U) and with the control applied (C). Under brackets are the differences between uncontrolled and controlled cases.

Case	Frequency (Hz)	Amplitude (dB)
U	920	-8.4
C	862 (-58)	-10.2 (-1.8)
U	920	13.9
C	860 (-60)	18.5 (+4.6)

7th resonance. The amplitudes of peaks 5, 6, 8 and 9 are affected, particularly peak 6 which increases in amplitude by 4 dB.

Figure 5 shows the input impedance magnitude of the system without control and with the control applied. The measurements are achieved using the BIAS system. The effects of the control on the 7th peak are detailed in Table 2 (bottom). The frequency of the peak is exactly that targetted for the 7th resonance. The control of the frequency of the 7th resonance has also resulted in its amplitude being increased. Effects on the other peaks are also observed when the control is applied. The amplitude of peaks 5, 6, 8 and 9 are all affected, particularly peak 6 which increases by 5 dB. The antiresonances after peaks 6, 7, 8 and 9 are increased in amplitude by 20 dB to 5 dB, so that the antiresonances between peaks 6 and 7 and between peaks 7 and 8 almost disappear.

Figure 6 shows the spectrogram of the sound emitted by the instrument, when blowing in it, with the control applied. In this figure, the control is applied between times 2 and 5 seconds. When the control is not applied, the sound shows only the odd harmonics, which is characteristic of a closed-open tube. When the control is applied, the amplitude of the 7th odd harmonic (about 920 Hz) is weakened, because the 7th resonance is less harmonically related to the fundamental. However, the even harmonics six to nine (about 852 Hz, 994 Hz, 1136 Hz and 1278 Hz) are enhanced, particularly the sixth even harmonic which is really close to the frequency of the controlled 7th resonance. This correlates with what has been observed on Figure 5. When the control stops, the sounds is again composed mainly of

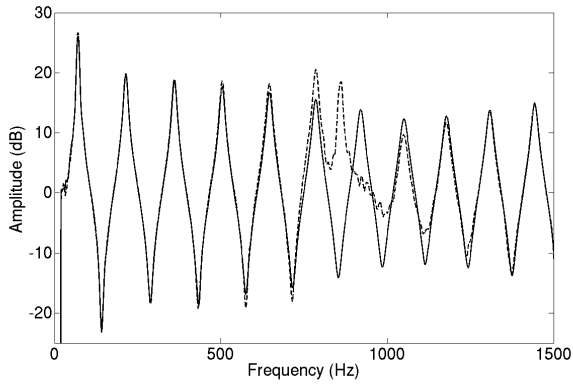

Figure 5: Input impedance of the tube without control (solid black line) and the with control applied so that the frequency of the seventh resonance is decreased from 920 Hz to 860 Hz (dash black line).

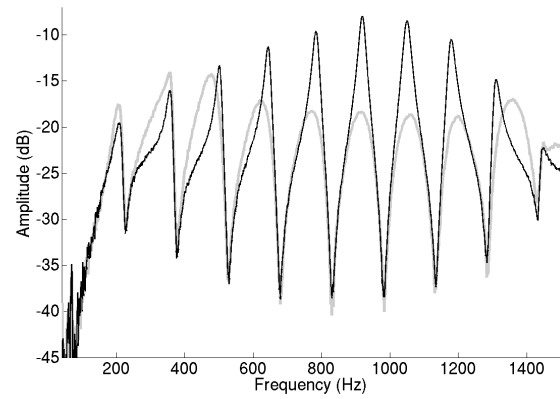

Figure 7: Transfer functions of the tube without control (solid black line) and with control of the damping of resonances 4 to 10, increased by 300 % (solid grey line).

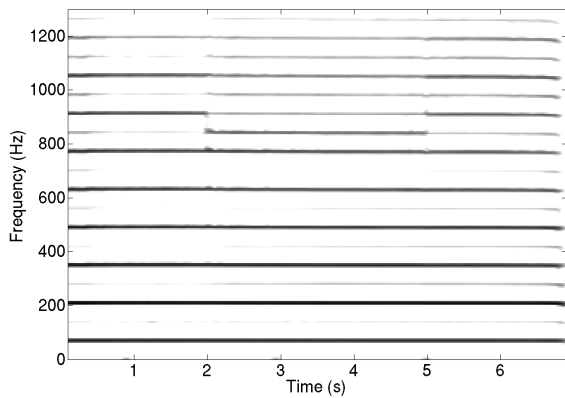

Figure 6: Spectrogram of the sound emitted by the instrument. The control is applied for 3 seconds, between times 2 and 5 seconds.

the odd harmonics of the fundamental.

3.3 Control of the damping of resonances 4 to 10

In this Section, the damping factors of the resonances 4 to 10 are controlled and increased by 300 %.

Figure 7 shows the transfer functions of the system without control and with the control applied. The effects of the control on peaks 4 to 10 are detailed in Table 3 (top). The amplitudes of all the peaks are reduced, with a maximum reduction for peak 7 of 10.3 dB. Apart from for the 7th peak, the increase in damping also has an effect on the peak frequency. Below the 7th peak, the frequency decreases (by as much as 54 cents for peak 4) while, above the 7th peak, the frequency increases (by as much as 41 cents for peak 10). The control also has an effect on the amplitudes of peaks 2 and 3, with respectively increases of 2.2 dB and 2 dB.

Figure 8 shows the input impedance of the system without control and with the control applied. The effects of the control on peaks 4 to 10 are detailed in Table 3 (bottom). The amplitudes of all the peaks are reduced, with a maximum reduction for peak 6 with 9.9 dB. Apart from for the fifth peak, the increase in the damping also results

Table 3: Frequency and amplitude peaks 4 to 10 of the transfer functions (top) from Figure 7 and input impedances (bottom) from Figure 8 without control (U) and with the control applied (C). Under brackets are the differences between uncontrolled and controlled cases.

Peak	Freq. (Hz) (U)	Amp. (dB) (U)	Freq. (Hz) (C)	Amp. (dB) (C)
4	501	-13.4	479 (-22)	-14.2 (-0.8)
5	644	-11.3	619 (-25)	-17.1 (-5.8)
6	784	-9.6	770 (-14)	-18.3 (-8.7)
7	920	-8	920 (0)	-18.3 (-10.3)
8	1050	-8.4	1063 (+13)	-18.6 (-10.2)
9	1179	-10.5	1200 (+21)	-18.8 (-8.3)
10	1311	-14.8	1357 (+46)	-16.9 (-2.1)
4	505	17.7	493 (-12)	9 (-8.7)
5	647	16.7	647 (0)	8.3 (-8.4)
6	786	15.7	796 (-10)	5.8 (-9.9)
7	920	14	915 (-5)	4.7 (-9.3)
8	1052	12.2	1050 (-2)	2.8 (-9.4)
9	1180	12.6	1172 (-8)	4.9 (-7.7)
10	1310	13.7	1307 (-3)	6.3 (-7.4)

in a decrease in the frequencies of the peaks (by as much as 29 cents for peak 4). All the antiresonances are increased in amplitude by as much as 10 dB. The control also has an effect on the amplitudes of peaks 2 and 3, with respectively increases of 2.2 dB and 1.2 dB. These side effects may be due to the latency of the control system, to calculation errors or to model errors.

Figure 9 shows the spectrogram of the sound emitted by the instrument, when blowing in it, with the control applied. In this figure, the control is applied between times 3 and 6 seconds. When the control is applied, odd harmonics 4 to 9 are weakened. Harmonic 10 is not shown on the figure, because it was too weak to be visible even before the control. The control also has an effect on the even harmonics, particularly on even harmonics 2 to 4 which are enhanced. This correlates with what has been observed on Figure 8.

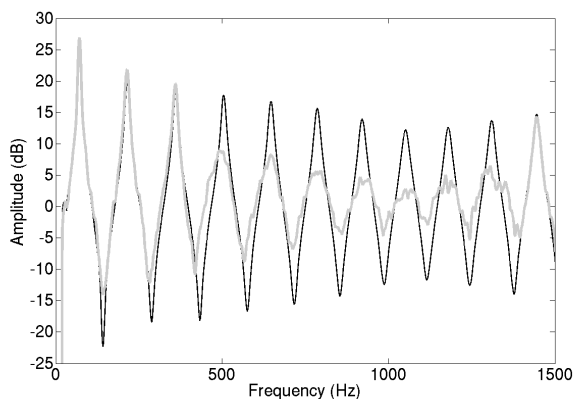

Figure 8: Input impedances of the tube without control (solid black line) and with control of the damping of resonances 4 to 10, increased by 300 % (solid grey line).

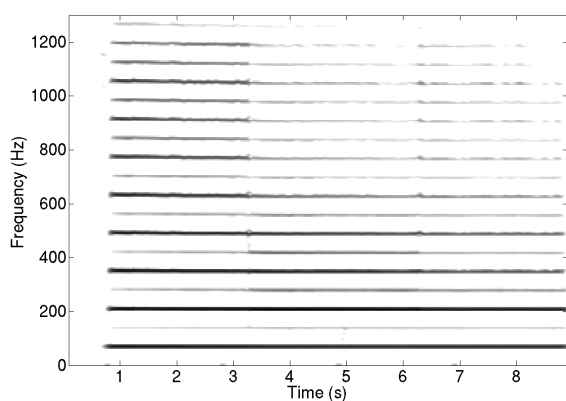

Figure 9: Spectrogram of the sound emitted by the instrument when increasing the damping of resonances 4 to 10 by 300 %. The control is applied for 3 seconds, between times 3 and 6 seconds.

4 Conclusion and perspectives

In this paper, experimental validation of modal active control applied to a simplified self-sustained musical wind instrument has been presented. Effects of the control have been studied in two sets of measurements. Modifications were observed of the transfer functions, the input impedance and the emitted sound of the instrument when blowing in it. The effects are similar to what would happen with modifications of the bore profile of the instrument. It is next planned to apply modal active control to real musical wind instruments, starting with a bass clarinet.

Acknowledgments

This work was carried out during the PhDs of Simon Benacchio and Thibaut Meurisse, funded by Agence Nationale de la Recherche (ANR IMAREV project) and Université Pierre et Marie Curie (UPMC, Paris 6). We thank gratefully Robert Pièchaud for his help with Xenomai, and Alain Terrier for his precious help in building the system. We thank the Newton International Fellowship scheme for funding the collaboration between France and UK.

References

- [1] C.R. Fuller, S.J. Elliott and P.A. Nelson, *Active Control of Vibration*, Academic Press, 1996.
- [2] J. Hong et al, "Modeling, Identification, and Feedback Control of Noise in an Acoustic Duct," *IEEE Transactions on Control Systems Technology*, vol. 4, no. 3, May 1996.
- [3] B. Chomette, D. Remond, S. Chesné, and L. Gaudiller, "Semi-adaptive modal control of on-board electronic boards using identification method", *Smart Material and Structures*, vol. 17, pp. 1-8, 2008.
- [4] T. Meurisse, A. Mamou-Mani, R. Caussé, D. Sharp, "Simulations of Modal Active Control Applied to the Self-Sustained Oscillations of the Clarinet," in *Proc. of the Stockholm Music Acoustics Conference 2013 (SMAC 2013)*, Stockholm, Sweden, 30 July - 3 August 2013.
- [5] T. Meurisse, A. Mamou-Mani, R. Caussé, B. Chomette D. Sharp, "Simulations of Modal Active Control Applied to the Self-Sustained Oscillations of the Clarinet," *under review*.
- [6] S. Hanagud, S. Griffin, "Active Structural Control for a Smart Guitar," in *Proc. of the 4th European Conference On Smart Structures and Materials*, Harrogate, United Kingdom, July 6-8 1998.
- [7] S. Benacchio, A. Mamou-Mani, B. Chomette, F. Ollivier, "Simulated Effects of Combined Control Applied to an Experimentally Identified Soundboard," in *Proc. of the Stockholm Music Acoustics Conference 2013 (SMAC 2013)*, Stockholm, Sweden, August 2013.
- [8] A. Mamou-Mani, D. Sharp, T. Meurisse, W. Ring, "Investigating the consistency of woodwind instrument manufacturing by comparing five nominally identical oboes", *J. Acoust. Soc. Amer.*, vol. 131, no. 1, pp.728-736, January 2012.
- [9] M. E. McIntyre, R.T. Schumacher, J. Woodhouse, "On the oscillations of musical instruments", *J. Acoust. Soc. Am.*, vol.74, no.5, pp.1325-1345, November 1983.
- [10] T. Richardson, D. Formenti, "Parameter estimation from frequency response measurements using rational fraction polynomials" in *1eIMAC Conference*, 1982.
- [11] D. Luenberger, "An introduction to Observers," *IEEE Transactions on Automatic Control*, vol. 16, no. 6, pp. 596-602, 1971.
- [12] A.Preumont, *Vibration Control of Active Structures, An Introduction - Third Edition*, Springer, 2011.
- [13] J. Kautsky, N.K. Nichols, "Robust Pole Assignment in Linear State Feedback", *Int. J. Control*, vol. 41, pp.1129-1155, 1985.
- [14] <http://www.xenomai.org/>
- [15] S. Benacchio, R. Pièchaud, A. Mamou-Mani, B. Chomette, V. Finel, "Active Control of String Instruments using Xenomai", in *Proc. of the Fifteenth real-Time linux Workshop*, pp.133-141, Lugano-Manno, Switzerland, October 28-31 2013.