



HAL
open science

Towards the Next Generation Video Broadcasting

Ming Liu, Jean-François H elard, Maryline H elard, Matthieu Cruss ere

► **To cite this version:**

Ming Liu, Jean-Fran ois H elard, Maryline H elard, Matthieu Cruss ere. Towards the Next Generation Video Broadcasting: Improved Performance using Distributed MIMO. *Wireless Personal Communications*, 2015, 84 (4), pp.2635-2649. 10.1007/s11277-015-2757-8 . hal-01154842

HAL Id: hal-01154842

<https://hal.science/hal-01154842>

Submitted on 1 Jun 2015

HAL is a multi-disciplinary open access archive for the deposit and dissemination of scientific research documents, whether they are published or not. The documents may come from teaching and research institutions in France or abroad, or from public or private research centers.

L'archive ouverte pluridisciplinaire **HAL**, est destin ee au d ep ot et  a la diffusion de documents scientifiques de niveau recherche, publi es ou non,  emanant des  tablissements d'enseignement et de recherche fran ais ou  trangers, des laboratoires publics ou priv es.

Towards the Next Generation Video Broadcasting

Improved Performance using Distributed MIMO

Ming Liu · Jean-François H elard ·

Maryline H elard · Matthieu Cruss ere

Received: date / Accepted: date

Abstract Distributed multiple-input multiple-output (MIMO) is a promising technique for the future terrestrial TV broadcasting systems due to its higher efficiency over the traditional single-antenna transmission scheme. In this article, we investigate the application of distributed MIMO technique in the future broadcasting systems. We first show the advantage of the distributed MIMO from the channel capacity perspective. Then different space-time block codes

The authors would like to thank the support of French ANR “Mobile MultiMedia (M3)” project.

M. Liu

Beijing Key Lab of Transportation Data Analysis and Mining, Beijing Jiaotong University,
Beijing 100044, China

E-mail: mingliu@bjtu.edu.cn

J.-F. H elard, M. H elard and M. Cruss ere

Universit e Europ enne de Bretagne, INSA, IETR, UMR 6164, F-35708, Rennes, France

E-mail: jean-francois.helard@insa-rennes.fr, maryline.helard@insa-rennes.fr,
matthieu.crussiere@insa-rennes.fr

(STBCs) that can be applied in the distributed MIMO broadcasting scenarios are discussed and compared with real system configurations and channel conditions. It is shown that the simple and sophisticated STBCs have mutually complementary application scenarios. Particularly, short 3D MIMO code is a good performance versus decoding complexity compromise among different application scenarios.

Keywords distributed MIMO · space-time block code · broadcasting · power imbalance · complexity

1 Introduction

Nowadays, we are stepping into a new era of TV broadcasting. Emerging TV services such as three-dimensional (3D) TV, ultra high definition TV (UHDTV) and mobile TV will be more and more widely delivered in a short future. Rapidly growing new services pose a huge demand of capacity, efficiency and reliability of the TV broadcasting system. The latest Digital Video Broadcasting-Terrestrial second generation (DVB-T2) standard offers a maximum data rate of 50.3 Mbit/s with mainly stationary and portable receptions in a traditional 8 MHz TV channel [1]. Facing the ever-increasing requirements on the service qualities with scarcer and scarcer spectrum resources, new techniques should be employed in broadcasting systems to provide improved performance.

Multiple-input multiple-output (MIMO) technology adopts multiple antennas at both transmit and receive sides and enables parallel data transmission

over several virtual single-input and single-output (SISO) sub-channels. With proper space-time (ST) coding schemes, MIMO can greatly increase the system throughput with improved reliability [2]. Since late 1990's, MIMO technology has been widely applied in many state-of-the-art communication systems such as IEEE 802.11n, 3GPP Long Term Evolution (LTE) and WiMAX. However, it has not been employed in any existing terrestrial TV broadcasting standard yet.

The first effort of applying ST coding to a TV broadcasting system has been made in the DVB project. A diversity transmission option using the Alamouti scheme [3] has been integrated into the latest DVB-T2 standard [1]. Two adjacent transmission sites transmit ST encoded data streams to enhance the reception performance. Yet, since only one antenna is used by each transmission site as well as by the receiver, the ST scheme used in DVB-T2 cannot fully exploit the merits of MIMO theory in terms of efficiency and robustness.

The latest DVB-Next Generation Handheld (DVB-NGH) [4,5] system takes one more step forward. Two antennas are used by each transmission site and by the receiver in order to not only increase the efficiency but also enhance the reliability of the TV services in severe mobile scenarios. Moreover, applying MIMO technique to enhance the capacity of terrestrial TV broadcasting is under serious consideration in the DVB consortium [6]. The objective is to provide high-quality TV services for the fixed receivers, i.e. home, business and public users, which requires much higher transmission capacity. In addition, broadcasters and cellular service providers are working together towards

a common broadcasting system which adopts MIMO technique to achieve better performance as well [7]. The application of MIMO technique in future broadcasting systems has become a popular trend recently.

In this article, we first show from the channel capacity perspective that distributed MIMO is a promising technique compared with traditional SISO solutions. Moreover, we investigate several state-of-the-art space-time block codes (STBCs) that can be applied in the distributed MIMO broadcasting systems. The performances of STBCs are evaluated with real system configurations and channel conditions. Through the performance and complexity comparisons, we demonstrate that the simple spatial multiplexing is suitable for low data rate services, while the sophisticated STBCs such as the 3D MIMO code are preferred solutions for high data rate services. Moreover, the novel short 3D MIMO code achieves a good compromise between performance and decoding complexity, and is therefore promising for the future broadcasting systems.

2 Broadcasting Scenarios—From Single Frequency Network to Distributed MIMO Network

2.1 Classical single frequency broadcasting network

Single frequency network (SFN) is a popular and spectrally efficient network implementation in the modern digital TV broadcasting systems [8]. Several geographically separated transmitters in a SFN simultaneously transmit the

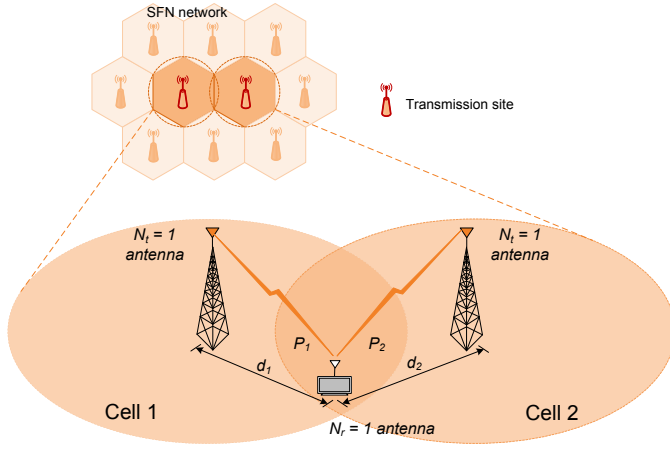

Fig. 1 SISO SFN broadcasting network.

same signal (TV program) in the same TV frequency band. Hence, SFN can easily achieve a large coverage without requiring extra frequency bands. Fig. 1 shows a simple example of a SFN with two transmission sites.

In the orthogonal frequency-division multiplexing (OFDM) based DVB system with N subcarriers, the ergodic capacity of SFN channel with two transmission sites can be computed as:

$$C_{\text{SFN}} = \mathbb{E} \left\{ \frac{1}{N} \sum_{k=0}^{N-1} \log_2 \left(1 + \frac{P}{2N\sigma_n^2} \sum_{j=1}^2 \lambda_j^2 |H_j(k)|^2 \right) \right\}, \quad (1)$$

where $H_j(k)$, $j = 1, 2$ are the frequency response of the k th subcarrier of the channel connecting j th transmission site and the receiver; λ_j^2 , $j = 1, 2$ are the power scale factor representing the path losses associated with the two channels, respectively; P is the overall transmission power of the two sites; σ_n^2 is the variance of the noise; $\mathbb{E}\{\cdot\}$ is the expectation value.

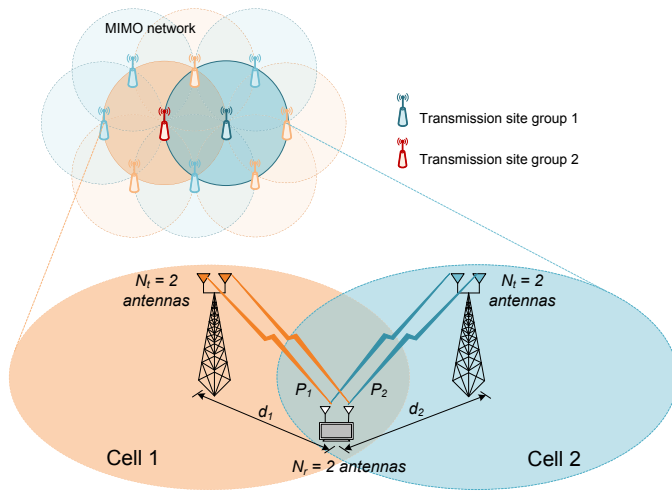

Fig. 2 Distributed MIMO broadcasting network.

2.2 Distributed MIMO broadcasting network

Traditionally, MIMO is realized using several co-located transmit antennas on the same transmission site. In fact, MIMO transmission can also be implemented among multiple cooperated, geographically separated transmission sites. This yields the so-called distributed MIMO which not only extends the coverage of the services but improves the efficiency and reliability of the transmission. As shown in Fig. 2, we investigate the distributed MIMO scenario where two adjacent transmission sites cooperate with each other. Each transmission site has two transmit antennas and receiver has two receive antennas as well.

It is worth noting that we consider the distributed MIMO with two sites in order to limit the decoding complexity and the user cost. Yet, the two-cell distributed MIMO structure can be easily applied in a network with larger

number of transmission sites. In fact, the transmission sites of the network can be divided into two groups. The distributed MIMO designed for the two-cell case are applied to the two site groups. With proper planning of the locations of transmission sites, the broadcasting network can be easily extended to a large area. For example, one implementation of distributed MIMO network based on two-cell element networks is presented in Fig. 2. The geographical locations of the transmission sites are the same as in the traditional SFN, which suggests a good compatibility with the existing broadcasting networks. Hence, the implementation of the distributed MIMO technique in the SFN broadcasting network will not introduce a significant increase of the overall system complexity. On the transmitter side, the backhaul network that is in charge of delivering the contents to the transmission sites, as well as the network synchronization mechanism remain unchanged. The major upgrades lie in the air interface implementation. More precisely, a second transmit antenna should be mounted on each transmission site. Accordingly, the new MIMO encoding functionality should be implemented in the transmission sites with respect to the group that they belong to. On the other hand, the receiver should integrate two receive antennas and the associated MIMO decoding algorithms so that the received MIMO signals can be properly recovered. In general, the implementation of the new distributed MIMO broadcasting network does not cause much complexity boost on the transmission network side, while new MIMO-reception-compatible receivers are needed by the users to benefit from the enhanced services. Therefore, the computational complexity

introduced by the MIMO reception, instead of MIMO transmission, will be our main focus in the following discussion in Section 3.

Since the channel information is unknown for the transmitter in the broadcasting scenarios, the channel capacity is achieved when the different antennas have same transmission power. The ergodic capacity of the DVB system through distributed MIMO channel is expressed as:

$$C_{\text{MIMO}} = \mathbb{E} \left\{ \frac{1}{N} \log_2 \left(\det \left(\mathbf{I} + \frac{P}{2NN_t\sigma_n^2} \sum_{j=1}^2 \lambda_j^2 \mathbf{H}_j \mathbf{H}_j^H \right) \right) \right\}, \quad (2)$$

where $\mathbf{H}_j = \text{diag}([\mathbf{H}_j(1), \dots, \mathbf{H}_j(N)])$ is a block diagonal matrix representing the channel matrix associated with the j th transmission site; its k th element $\mathbf{H}_j(k)$ is an $N_r \times N_t$ matrix in which the (p, q) th element $H_{pq}(k)$ is the frequency response of the channel link from the q th transmit antenna to the p th receive antenna; N_t and N_r are the number of transmit antennas in each site and number of receive antennas in the receiver; λ_j^2 is the power scale factor associated with the j th transmit site; $\det(\cdot)$ is the determinant of the matrix.

2.3 Channel capacity comparison

The capacity improvements brought by the distributed MIMO over the traditional SISO SFN is evaluated with the two-cell broadcasting network implementation as shown in Fig. 1 and Fig. 2. Fig. 3 presents the ratios of the two channel capacities ($C_{\text{MIMO}}/C_{\text{SFN}}$) in different geographical locations. The two transmission sites locate in ‘‘A’’ and ‘‘B’’ positions in Fig. 3. The distance between the two sites is 10 km. The total transmission power P is 10 kW.

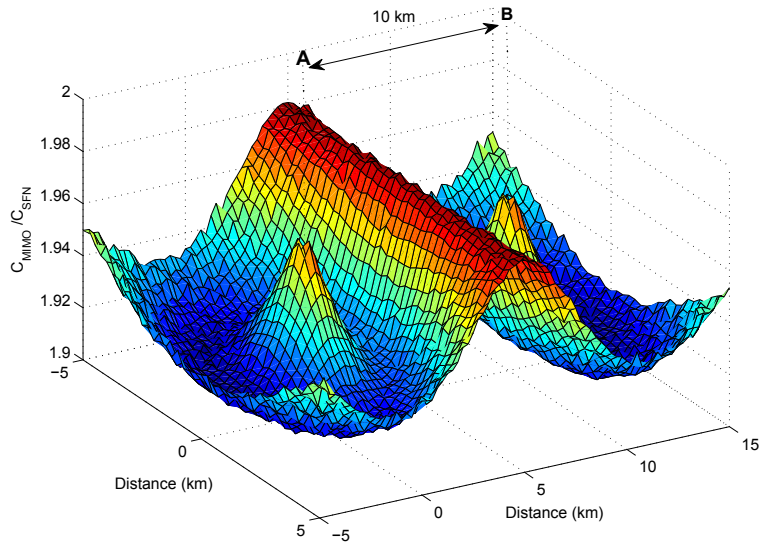

Fig. 3 Channel capacity improvements with respect to different geographical locations in distributed MIMO broadcasting. The colour scale gives the ratio values of the two channel capacities, i.e. $C_{\text{MIMO}}/C_{\text{SFN}}$.

Suppose that the signal experiences independent and identically distributed (i.i.d.) Rayleigh small-scale fading and signal power exponentially decays with respect to the distance between receiver and transmitter. The power decaying factor is chosen to be 3.5 which represents the typical propagation scenario in the urban area. The channel capacities of the two broadcasting scenarios are computed according to the results given in previous sections. It can be seen in Fig. 3 that the distributed MIMO broadcasting can achieve around twice channel capacity than the traditional SFN broadcasting within the coverage of the two-cell network with the same overall transmission power. More interestingly, the improvements are more significant in the border area of the two cells, which leads to a better coverage in the edges of the cells. This example

shows that the distributed MIMO broadcasting has better potential in terms of transmission efficiency.

3 Space-Time Coding For Distributed MIMO

3.1 Specific features of distributed MIMO

It has been well known that the spatial multiplexing (SM) technique provides higher communication capacity than the traditional SISO transmission [9]. The orthogonal space-time block coding (STBC) such as Alamouti scheme [3] can easily extract the spatial diversity by linear processing. Since last decades, various STBCs [2, 10, 11, 13–16] have been proposed for different application scenarios achieving different trade-offs among efficiency (coding rate), reliability (diversity) and orthogonality (decoding complexity).

As far as the distributed MIMO broadcasting scenario is concerned, one significant characteristic of the propagation scenario is the unequal power levels of the received signals. As shown in Fig. 2, the distances between receiver and different transmission sites are not the same, i.e. $d_1 \neq d_2$, for most locations in the network. This indicates that signals coming from different transmission sites experience different path losses. This yields power imbalances between signals sent from different cells at the receiver side. In contrast, signals sent from the same transmission site may have the same average power level. Classical STBCs are not optimized to such feature and can suffer performance degradation due to power imbalances even though they can be used in normal

4×2 MIMO cases. In fact, this characteristic could also be taken into account to design suitable STBCs for distributed MIMO broadcasting.

3.2 STBCs designed for distributed MIMO

Intuitively, the STBC can be designed in a hierarchical manner. That is, information symbols of the same cell can be encoded using a STBC scheme. This is called intra-cell ST coding. According to the propagation characteristics, the intra-cell ST coding should be efficient with balanced received signal power. Consequently, the resulting encoded symbols of different transmission sites are encoded by a second ST coding scheme, namely inter-cell ST coding. In contrast to the intra-cell counterpart, inter-cell ST scheme should be robust against signal power imbalances.

With the knowledge of the characteristics of distributed MIMO broadcasting and using the hierarchical ST encoding methodology, a so-called 3D MIMO code has been proposed for the distributed MIMO scenarios [10]. The powerful Golden code [11] is selected as the intra-cell ST coding, because it is the most efficient 2×2 ST coding scheme with equal received signal power. The Alamouti scheme [3] is adopted as the inter-cell ST coding because it offers full diversity and is robust against power imbalances. Two Golden codewords are encoded in an Alamouti manner to generate the final codeword. The resulting 3D MIMO codeword provides a ST coding rate of 2 with high diversity. The combination of Alamouti and Golden codes achieves strong adaptability to different signal power situations while preserving the transmission efficiency

offered by the Golden code. Its efficiency in distributed MIMO broadcasting has been shown with the iterative interference-cancellation receiver [10]. However, it results in a high decoding complexity if the state-of-the-art sphere decoder [12] is used.

Recently, a new STBC is proposed in [13] for the distributed MIMO scenario aiming at reducing the sphere decoding complexity while preserving the robustness against power imbalances. It also exploits the merits of Golden code and Alamouti code. The first and second time slots of one Golden codeword are encoded in an Alamouti structure. It yields a short version 3D MIMO code which offers a ST coding rate of 2. Since four information symbols, instead of eight in the 3D MIMO code, are stacked within one codeword, the short 3D MIMO code can be decoded within a much smaller searching space when maximum likelihood (ML) decoding is employed. Therefore, it can achieve much lower decoding complexity than the original 3D MIMO code.

3.3 Classical STBCs compatible with distributed MIMO

Apart from the 3D MIMO codes presented in the previous section, several STBCs in the literatures can be applied in the distributed MIMO broadcasting as well. For instance, the simple SM scheme [9] can adapt to the 4×2 distributed MIMO scenarios. More specifically, two transmission sites send the same signals at the same time forming a SFN. For each site, two independent information symbols are transmitted via the two antennas forming a SM

transmission. This is the simplest ST coding scheme in a SFN. It yields a 4×2 SM scheme with a ST coding rate of 2.

The classical quasi-orthogonal Jafarkhani code [14] is also a potential candidate for the distributed MIMO broadcasting. The Alamouti scheme is applied in both intra-cell and inter-cell ST codings providing a ST coding rate of 1. The Jafarkhani code has a quasi-orthogonal structure [14] which enables group-wise decoding at a low complexity cost.

Recently, some STBCs were proposed based on the group-wise orthogonal structures aiming at providing efficient performance with low decoding complexity. For instance, the Biglieri-Hong-Viterbo (BHV) code [15] is constructed based on two Jafarkhani codewords. The underlying Jafarkhani code structure provides implicit group-wise orthogonality that enables low complexity decoding. Similarly, the Srinath-Rajan code [16] is formed by two coordinated interleaved orthogonal design (CIOD) which also yields simple decoding algorithm. Both BHV and Srinath-Rajan codes offer a ST coding rate of 2.

3.4 Comparisons of STBCs

Table 1 gives an overview of the most important features of the involved STBCs such as coding rate, intra-/inter-cell coding schemes and decoding complexities.

The decoding complexities are presented in terms of the number of possible STBC codewords visited during the sphere decoding. If the exhaustive search is used for the decoding, the ML solution can be found after evalu-

Table 1 STBCs for distributed MIMO broadcasting scenarios.

STBC	Rate	Structure				Decoding
		Nb. info	Nb. chn.	Intra-cell	Inter-cell	Complexity
		symb	uses	ST coding	ST coding	
SM 4×2	2	2	1	SM 2×2	SFN	$O(M^2)$
short 3D	2	4	2	Golden	Alamouti	$O(M^4)$
Jafarkhani	1	4	4	Alamouti	Alamouti	$O(M^2)$
BHV	2	8	4	Based on 2 Jafarkhani codes		$O(M^{4.5})$
3D MIMO	2	8	4	Golden	Alamouti	$O(M^{4.5})$
Srinath-Rajan	2	8	4	Based on 2 CIOD codes		$O(M^{4.5})$

ating M^Q codewords where M is the size of the constellation and Q is the number of information symbols stacked within one STBC codeword. That is, for a given modulation order, the more information symbols in one codeword, the more difficult the decoding process. Yet, due to the embedded group-wise orthogonality, lower complexity can be expected when the sphere decoder is used. As shown in Table 1, in the worst sphere decoding case, Jafarkhani, 3D MIMO and BHV codes require decoding complexities of $O(M^2)$, $O(M^{4.5})$ and $O(M^{4.5})$, instead of $O(M^4)$, $O(M^8)$ and $O(M^8)$, respectively.

Since these STBCs are designed with different trade-offs between efficiency and complexity, in order to know which of them are appropriate for the distributed MIMO broadcasting, it is necessary to compare them with the real system settings.

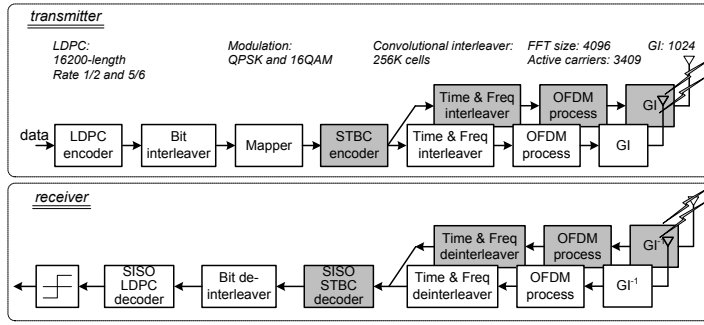

Fig. 4 Generic block diagram of the DVB-NGH system. The shaded blocks are the new functionalities of DVB-NGH while others are inherited from DVB-T2.

4 Analysis and Performance Comparison of STBCs

4.1 Simulation settings

In this section, we investigate the potential enhancements to the existing broadcasting networks that are brought by the new distributed MIMO technique. Different STBCs are evaluated using the latest DVB-NGH specification which is, up to now, the only TV broadcasting standard that supports MIMO transmission. Most of important parameters of DVB-NGH such as sampling frequency, FFT size, and number of active subcarriers are compatible with the DVB-T2 standard. The generic block diagram of the DVB-NGH system and some important simulation parameters are illustrated in Fig. 4. It can be seen that DVB-NGH has a similar structure to DVB-T2 expect for the blocks needed by MIMO processing. That is, the discussion carried out in this article is not only applied for the DVB-NGH standard, but also meaningful for the future terrestrial broadcasting standard as well as the common broadcasting standard. The 4K (4096-point FFT, 3409 active subcarriers) OFDM mode

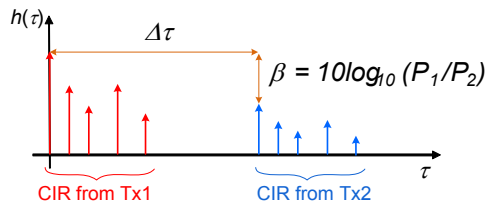

Fig. 5 Channel impulse response (CIR) of distributed MIMO broadcasting scenario.

which is recognized as a favorable transmission mode for the mobile broadcasting scenarios is employed in the simulation. The OFDM mode could align to the smaller FFT-size (1K or 2K) modes to adapt to higher mobility scenarios, or to the larger FFT-size (8K or 16K) modes to adapt to larger coverage scenarios. The complexity in terms of OFDM modulation/demodulation will reduce or increase accordingly, but the MIMO decoding complexity remains unchanged. QPSK and 16QAM are used for the rate-2 and rate-1 STBCs, respectively, in order to achieve the same spectral efficiency in the comparison. Two 16200-length LDPC codes with rates 1/2 and 5/6 specified in [1] are used in the simulation. The state-of-the-art soft-output sphere decoder [12] is used to decode the received MIMO signal for all STBCs.

The performance of concerned STBCs is evaluated using the realistic DVB-NGH MIMO outdoor channel which simulates a cross-polarized 2×2 MIMO transmission in the UHF band [17]. The two-cell distributed MIMO propagation scenarios are simulated using two uncorrelated DVB-NGH 2×2 MIMO channels. Due to the difference of propagation distances, the channel coefficients related to the farther transmission site contain a time delay ($\Delta\tau$) and power imbalance (β), as shown in Fig. 5. The β is defined as $\beta =$

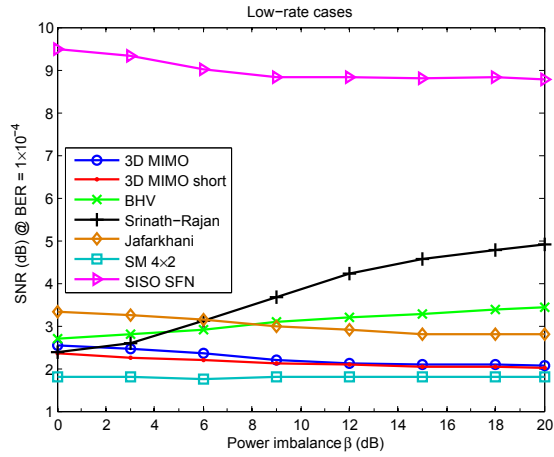

Fig. 6 Required SNR to achieve the BER level of 1×10^{-4} after LDPC decoder with respect to different values of received signal power imbalance, LDPC rate 1/2, DVB-NGH outdoor MIMO channel, Doppler frequency 33.3 Hz.

$10 \log_{10} P_1/P_2$, where P_1 and P_2 are received signal powers related to the first and second transmission sites, respectively. We assume the perfect synchronization and channel information at the receiver side.

4.2 Low data-rate applications

Fig. 6 shows the required SNR to achieve a BER level of 1×10^{-4} at the output of the LDPC decoder with respect to different values of power imbalances (β). The rate-1/2 LDPC specified in [1] is used in these simulations. The low channel coding rate suggests that this is a work mode to deliver low data-rate applications. Since the power imbalance is determined by the signal path loss, this experiment suggests the performance of STBCs in different geographical locations. In fact, the robustness of STBCs against power imbalances is crucial

for distributed MIMO broadcasting because the broadcasters should guarantee equally good quality of service for all users within the coverage of the services no matter where they locate. The performance of the classical SISO SFN broadcasting is also given for comparison.

From Fig. 6, it can be seen that STBCs significantly outperform SFN with both balanced and imbalanced powers. For instance, SM 4×2 , short 3D MIMO, 3D MIMO and Jafarkhani codes achieve 7.7 dB, 7.1 dB, 7.0 dB and 6.2 dB gains over SISO SFN with balanced power, i.e. $\beta=0$ dB. These gains become 7.0 dB, 6.7 dB, 6.7 dB and 6.0 dB when the power imbalance is 20 dB. Moreover, 3D MIMO, short 3D MIMO, Jafarkhani and SM 4×2 codes are robust against received signal power imbalances. In contrast, Srinath-Rajan and BHV codes suffer 2.5 dB and 0.7 dB degradations compared with the balanced power case when the power imbalance level is 20 dB. Interestingly, the simple SM 4×2 code achieves the best performance among all STBCs when the strong LDPC code with rate $1/2$ is used. Thanks to the strong error-correction capability of the low-rate LDPC code and long time interleaver, the LDPC decoding process can extract high time diversity and can efficiently correct the error in the received signal. Therefore, the effect of the diversity extracted by the STBCs is less significant in such case. On the other hand, accurate STBC decoding becomes more difficult when there are many information symbols stacked in one STBC codeword. As a result, the simplest SM 4×2 code achieves best performance among all STBCs when strong forward error correction (FEC) scheme is used.

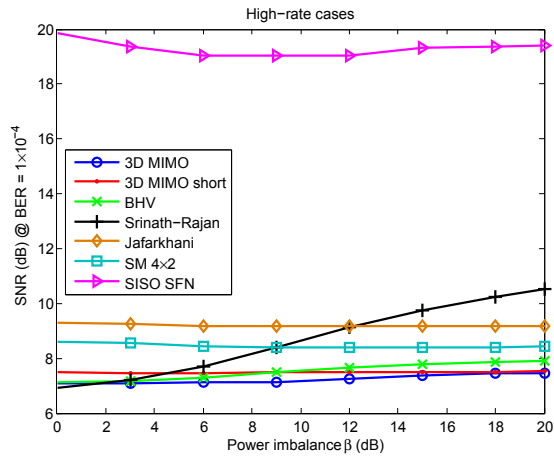

Fig. 7 Required SNR to achieve the BER level of 1×10^{-4} after LDPC decoder with respect to different values of received signal power imbalance, LDPC rate 5/6, DVB-NGH outdoor MIMO channel, Doppler frequency 33.3 Hz.

4.3 High data-rate applications

Fig. 7 presents the BER performance against power imbalances with a weaker FEC configuration. LDPC with rate 5/6 is used in this experiment while other settings remain the same as the previous part. In contrast to the previous case, high channel coding rate supports higher data-rate application. STBCs show similar power imbalance resistance behaviors as in Fig. 6. Jafarkhani, 3D MIMO, short 3D MIMO, BHV and SM 4x2 codes are still robust within a wide range of power imbalances with a weaker FEC. Srinath-Rajan code suffers 3.6 dB degradation when the power imbalance value is 20 dB compared with the balanced power case. Moreover, the SM 4x2 code is not efficient with weak FEC configuration. It is 1~1.5 dB worse than the sophisticated STBCs such as 3D MIMO and short 3D MIMO codes, because the diversity embedded in the

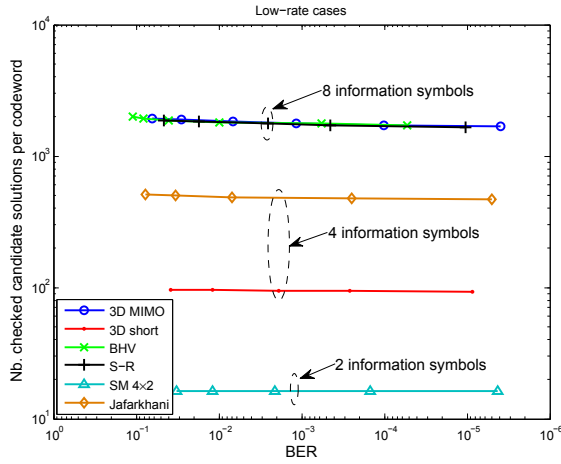

Fig. 8 MIMO decoding complexity in terms of average checked candidate solutions per ST codeword in the soft-output sphere decoder, LDPC coding rate 1/2.

STBCs is crucial for the error-correction process when a weaker FEC is adopted. The short 3D MIMO code, on the other hand, does not suffer significant performance loss like SM 4×2 code. It is less than 0.4 dB worse than 3D MIMO and BHV codes with balanced powers, and approaches the performance of the 3D MIMO code when the power imbalance value is 20 dB. Finally, it is worth noting that the better performance of the sophisticated STBCs comes along with the higher decoding complexity, which will be discussed in the next section.

4.4 Decoding complexity considerations

Fig. 8 and Fig. 9 present the average number of solutions checked to decode one ST codeword when the state-of-the-art soft-output sphere decoder is adopted [12]. It reflects the actual computational load needed by the MIMO decod-

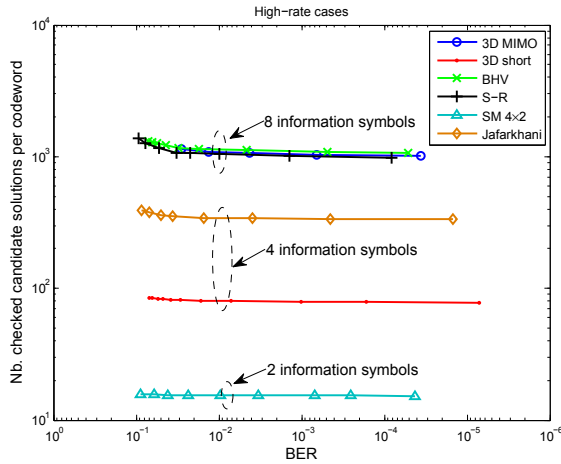

Fig. 9 MIMO decoding complexity in terms of average checked candidate solutions per ST codeword in the soft-output sphere decoder, LDPC coding rate 5/6.

ing process [17]. As indicated in the figure, the sphere decoding significantly reduces the complexity compared with the brute-force ML search. Whereas sophisticated STBCs still need considerable computational load.

More precisely, from the figures, it can be seen that the decoding complexity mainly depends on the number of information symbols stacked within one STBC codewords. The more information symbols stacked in one codeword, the more complex the decoding process. For instance, the sphere decoder checks 15 possible codewords on an average to decode each SM 4×2 codeword which contains two information symbols. For the STBCs containing eight information symbols, the sphere decoder has to examine about 1000~1900 possibilities for each codeword, depending on the SNR. The short 3D MIMO code which stacks four information symbols in a codeword achieves an intermediate decoding complexity between the previous two types. The decoder checks 77~97

possibilities for each codeword, depending on the SNR. It is worth noting that if we normalize the complexity by the number of information symbols, the decoding complexities are around 7.5, 19~24 and 125~238 for STBCs with 2, 4 and 8 information symbols, respectively. Taking into account the analyses in previous sections, short 3D MIMO code offers satisfactory performance in combination with both strong and weaker FEC configurations with an acceptable decoding complexity. Hence, it achieves a very good trade-off between complexity and BER performance in any case.

5 Concluding Remarks

In this article, distributed MIMO, a promising technique for the future TV broadcasting system, is presented. We first show that the distributed MIMO outperforms the traditional SISO SFN broadcasting network in terms of the channel capacity, which indicates that distributed MIMO has the potential to provide higher system capacity.

Consequently, we investigate several STBCs that can be applied for the distributed MIMO broadcasting scenarios. Performance of the STBCs is evaluated using the real system configurations and realistic MIMO broadcasting channel models. It can be concluded from the comprehensive experiments that STBCs outperform the traditional SISO SFN in the typical broadcasting scenarios. Moreover, different STBCs have different preferred application scenarios. For example, simple STBC, i.e. SM 4×2 scheme offers satisfactory performance in combination with strong FEC configurations, namely low-rate

channel coding and low-order modulations. In addition, it requires much less decoding complexity compared with other sophisticated STBCs. Therefore, SM 4×2 scheme is suitable to deliver low data rate services for portable or mobile receptions.

On the other hand, the sophisticated STBCs such as 3D MIMO and BHV codes are suitable solutions for high data-rate services, because they can be used in combination with weaker FEC configurations. On the contrary, simple solution such as SM 4×2 scheme is not efficient with such configurations any more. Furthermore, high rate services are commonly delivered to the fixed receivers belonging to family, business and public users. The fixed receivers can afford higher decoding complexity and power consumption than the battery-powered handheld devices. Therefore, the sophisticated 3D MIMO code is a suitable solution for high data-rate services.

In general, distributed MIMO exhibits a notable advantage over the traditional SISO SFN broadcasting network. Simple and sophisticated STBCs can be applied in mutually complementary application scenarios. In particular, short 3D MIMO code is a good compromise in any case between strong and weaker FEC configurations with an acceptable decoding complexity. Therefore, it can be a promising candidate for the future broadcasting systems.

References

1. Digital Video Broadcasting (DVB); Frame structure channel coding and modulation for a second generation digital terrestrial television broadcasting system (DVB-T2), ETSI EN 302 755 V1.2.1 (Feb. 2011).

2. Tarokh, V., Seshadri, N., Calderbank A.: Space-time codes for high data rate wireless communication: Performance criterion and code construction. *IEEE Trans. Inf. Theory*, vol. 44, No. 2, pp. 744-765 (March 1998).
3. Alamouti, S.: A simple transmit diversity technique for wireless communications. *IEEE J. Sel. Areas Commun.*, vol. 16, No. 8, pp. 1451-1458 (October 1998).
4. Digital Video Broadcasting (DVB); Next Generation broadcasting system to Handheld, physical layer specification (DVB-NGH). *DVB Document A160* (November 2012).
5. Vargas, D., Gozalvez, D., Gomez-Barquero, D., Cardona, N.: MIMO for DVB-NGH, the next generation mobile TV broadcasting, *IEEE Commun. Mag.*, vol.51, no.7, pp. 130-137 (July 2013).
6. DVB, TM-MIMO. <http://www.dvb.org/groups/TM-MIMO>. Accessed 18 March 2014.
7. Mobile Multi-Media (M3) project. <https://m3.rd.francetelecom.com/espace-public/deliverables>.
8. Mattsson, A.: Single frequency networks in DTV. *IEEE Trans. Broadcast*, vol. 51, No. 4, pp. 413-422 (December 2005).
9. Wolniansky, P.W., Foschini, G.J., Golden, G.D., Valenzuela, R.A.: V-BLAST: an architecture for realizing very high data rates over the rich-scattering wireless channel. *Proc. URSI International Symposium on Signals, Systems, and Electronics*, pp. 295-300 (1998).
10. Nasser, Y., H elard, J.-F., Cruss iere, M.: 3D MIMO scheme for broadcasting future digital TV in single-frequency networks. *Electronics Letters*, vol. 44, No. 13, pp. 829-830 (June 2008).
11. Belfiore, J.-C., Rekaya, G., Viterbo, E.: The Golden code: a 2×2 full-rate space-time code with nonvanishing determinants. *IEEE Trans. Inf. Theory*, vol. 51, No. 4, pp. 1432-1436 (April 2005).
12. Studer, C., Bolcskei, H.: Soft-input soft-output single tree-search sphere decoding. *IEEE Trans. Info. Theory*, vol. 56, No. 10, pp. 4827-4842 (October 2010).
13. Liu, M., H elard, M., Cruss iere, M., H elard, J.-F.: Distributed MIMO coding scheme with low decoding complexity for future mobile TV broadcasting. *Electronics letters*, vol. 48, No. 17, pp. 1079-1081 (August 2012).

14. Jafarkhani, H.: A quasi-orthogonal space-time block code. *IEEE Trans. Commun.*, vol. 49, No. 1, pp. 1-4 (January 2001).
15. Biglieri, E., Hong, Y., Viterbo, E.: On fast-decodable space-time block codes. *IEEE Trans. Inf. Theory*, vol. 55, No. 2, pp. 524-530 (February 2009).
16. Srinath, K., Rajan, B.: Low ML-decoding complexity, large coding gain, full-rate, full-diversity STBCs for 2×2 and 4×2 MIMO systems. *IEEE J. Sel. Topics Signal Process.*, vol. 3, No. 6, pp. 916-927 (December 2009).
17. Moss, P., Poon, T. Y., Boyer, J.: A simple model of the UHF cross-polar terrestrial channel for DVB-NGH. *Research & Development White Paper WHP205* (September 2011).