



HAL
open science

Third body concept and wear particle behavior in dry friction sliding conditions

Jean Denape

► **To cite this version:**

Jean Denape. Third body concept and wear particle behavior in dry friction sliding conditions. Tribological Aspects in Modern Aircraft Industry, 2014, vol. 640, pp.1-12. 10.4028/www.scientific.net/KEM.0.1 . hal-01154602

HAL Id: hal-01154602

<https://hal.science/hal-01154602>

Submitted on 22 May 2015

HAL is a multi-disciplinary open access archive for the deposit and dissemination of scientific research documents, whether they are published or not. The documents may come from teaching and research institutions in France or abroad, or from public or private research centers.

L'archive ouverte pluridisciplinaire **HAL**, est destinée au dépôt et à la diffusion de documents scientifiques de niveau recherche, publiés ou non, émanant des établissements d'enseignement et de recherche français ou étrangers, des laboratoires publics ou privés.



Open Archive Toulouse Archive Ouverte (OATAO)

OATAO is an open access repository that collects the work of Toulouse researchers and makes it freely available over the web where possible.

This is an author-deposited version published in: <http://oatao.univ-toulouse.fr/>
Eprints ID: 13679

To link to this article: DOI:10.4028/www.scientific.net/KEM.0.1
<http://www.ttp.net/978-3-03835-425-3.html>

To cite this version:

Denape, Jean *Third body concept and wear particle behavior in dry friction sliding conditions*. (2014) In: Tribological aspects in modern aircraft industry. Trans Tech Publications, pp. 1-12. ISBN 978-3-03835-425-3

Any correspondence concerning this service should be sent to the repository administrator: staff-oatao@listes-diff.inp-toulouse.fr

Third body concept and wear particle behavior in dry friction sliding conditions

Jean DENAPE

Université de Toulouse – Ecole Nationale d'Ingénieurs de Tarbes
B.P. 1629, 65016 TARBES Cedex - FRANCE

jean.denape@enit.fr

Keywords: friction, wear, third body, tribological triplet, accommodation mechanisms, tribological transformed structures, tribological circuit.

Abstract. The third body concept is a pragmatic tool for analyzing and understanding the friction and wear of sliding materials. This approach is based on the dominating role played by the wear particles under dry sliding conditions. These particles constitute the major part of what is called the third body. The third body concept was introduced by Maurice Godet in the middle of the 70's and developed by Yves Berthier since the end of the 80's who added complementary conceptual tools as the tribological triplet, the accommodation mechanisms and the tribological circuit. The aim of this paper is to give a synthetic view of these concepts, which involves mechanical, material and physicochemical subjects. Concrete examples and case studies from various practical applications are given to illustrate the validity and the efficiency of such a phenomenological approach.

Introduction

Engineers have to solve friction problems, but they are not always educated about it. Their main practical problems can be summed up to two fundamental questions: *which contact material to choose? Which value of friction coefficient to consider?* Unfortunately, friction and wear are not intrinsic properties, but only *use properties*, depending on a multitude of parameters including material properties, operating conditions and interfacial rheology. Furthermore, a lot of intuitive and received ideas is out there, such as *the harder it is, the less it wears! The smoother it is, the better it slides! High friction involves high wear!...* Such claims are often justified in particular cases, but they are generalized too rapidly and then used as postulates.

This paper starts with a bit of history for briefly reviewing the classical approach of friction and wear, and then proceeds to introduce the third body concept and the modern conceptual and structuring tools for analyzing wear.

1. Overview of the situation: a bit of history

The control of friction is a stake of all the times, which implies a compromise between dissipated power and motion. The ancient Egyptians, almost 4000 years ago, moved colossal statuary as the example of the famous low relief in the tomb of Tchuti Hetep, in Egypt, where a pre-tribologist poured water between the contacting surfaces to reduce the traction forces [1].

The pioneers

The first man who tries to understand friction was Leonardo da Vinci (1452-1519). He first made experiments and formulated the early *friction laws*. He observed the proportionality between friction force and normal load and concluded that *the friction of any weight equals the quarter of this load*, which means a coefficient of proportionality equals 0.25. He also observed an unexpected phenomenon: *the friction due to the same weight exhibits the same friction, even if the contact has different length and width*, which implies the independence of the contact area for a same normal load (Fig. 1a). If the first law is questionable, the second one is relatively true.

Two centuries later, Guillaume Amontons in 1699, made experimental studies on materials for pulleys and capstans, funded by the French royal navy. He rediscovered the two friction laws of da Vinci independently: *the friction resistance is approximately equal the third of the applied pressure as well as on wood, iron, copper or lead whatever the sliding conditions when coated with grease.* He proposed a proportionality coefficient of 0.33 whatever the materials. Bernard Forest de Bélidor in 1737, like Amontons and later Coulomb, thought that the origin of friction force resulted from the required force to raise the asperities of a surface above those of the antagonist surface. He simulated asperity interactions by spheres and found a theoretical formula, independent of the number of asperities, which gives approximately 0.35 in agreement with the experimental results (Fig. 1b and 1c). Unfortunately, this attractive approach has now strong energetically and experimental objections, so asperity interlocking is not the main reason for friction force. Furthermore, the great mathematician Leonhard Euler introduced in 1748, the concept of friction angle, he noted it with the well-known symbol μ , which has definitively ossified the idea of proportionality between tangential and normal forces.

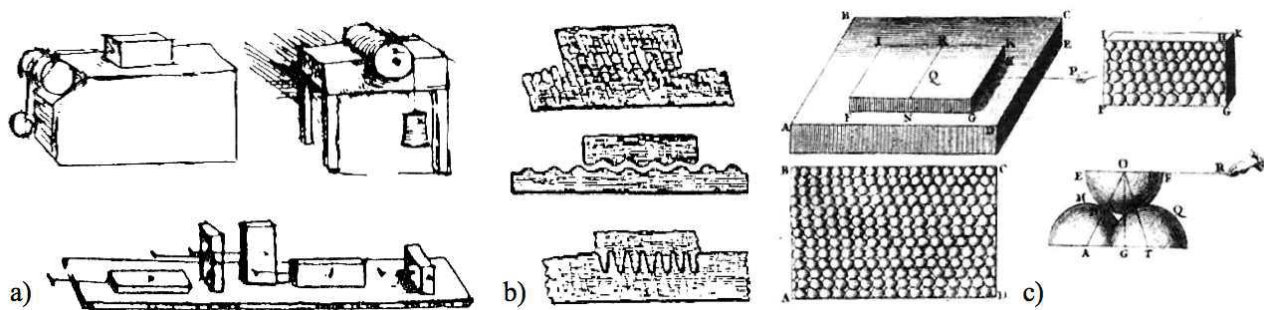

Figure 1: a) Experiments of da Vinci on friction force, torque and the influence of sliding area; b) first interpretation of the origin of friction force by Amontons and Coulomb; c) theoretical simulation of the friction force resulting of spherical asperities interlocking by Bélidor.

During the same period, in 1725, John Theophilus Désaguliers, a French Huguenot seeking in Great Britain, discovered the phenomenon of adhesion of solids by measuring the tensile force necessary to break the welding (sticking) of two spheres of lead initially pressed together strongly. Finally, the famous Charles Augustin Coulomb, after a large series of friction experiments on various metals and woods under dry and lubricated conditions, proposed in 1781, a general formula for friction, which takes into account a parameter relative to the cohesion of surfaces, so that friction force is not exactly proportional to normal force [2]. This is not the definition of the so-called friction coefficient of Coulomb, currently in use nowadays!

Classical approach of friction

The classical approach of friction is due to Bowden and Tabor in the middle of the 20th century. It is a *two-body approach* described in three stages at a microscopic level (Fig. 2) [3].

- The first stage concerns the *contact formation*. Shocks and interpenetrating of asperities on the *real contact area* produce plowing, crushing and spinning by elastic and plastic deformations.
- The second stage results from the intimate contact between atoms and leads to the formation of an *adhesive junction* (cold-welding between asperities).
- The third stage concerns the *contact separation* where the junction must be sheared to maintain the movement.

This approach focuses on the double contribution, both mechanical and physico-chemical, of the friction mechanism.

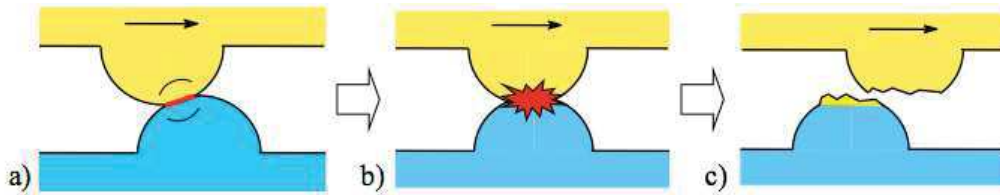

Figure 2: The three stages of the two-body approach of friction
 a) contact formation, b) adhesive junction and c) contact separation (Bowden & Tabor).

In such way, the *classical definition of wear* is the mass lost from the surface of one or/and the other solid in contact. Wear mechanisms are classified considering the mode of surface damage observed on worn surfaces, such as abrasion, adhesion, surface fatigue, delamination, tribochemical... A lot of *wear laws* are based on the Archard's law, which is the wear volume divided by the applied load and the sliding distance [4]. Dimensionless speaking, it is expressed as the inverse of a mechanical strength. Energetic laws are also proposed on the basis of the dissipated energy by friction, but the large majority are empiric laws, closely linked to working conditions [5]. Some attempts of wear maps have also been published as a function of pressure and speed [6].

In summary, tribology is still a young science: the word itself has less than fifty years [7]. Predictive models with advanced mathematical formalism, based on the three fundamental equations of mechanics, are used for lubrication problems and contact mechanics, but only descriptive models, based on the quasi unlimited concepts of material science, are available for friction and wear.

2. The third body concept

The third body concept is a mechanical transposition of the lubrication concepts to dry friction introduced by Maurice Godet in the middle of the 70's. The so-called third body gathers all the interfacial elements separating the contacting surfaces [8]. This third body plays a role of inset screen lying between the contacting solids (the two so-called first bodies).

The third body refers to the zone of speed discontinuity: it is a dynamic interphase produced by detached particles, debris... or lubricants. Its characteristic dimension is from 1 to 10 μm . The third body could also refer to the zone of composition discontinuity: it includes static superficial films, adsorbed layers, oxide films... Two-body contacts (literal sense) don't exist.

The three fundamental processes of wear

Wear process can be described in three stages focused upon the *debris behavior* (Fig. 3):

- The first stage begins by the detachment of particles from first body surfaces by classical mechanisms of abrasion, adhesion, delamination...
- During the second stage, the particles are trapped and circulate within the contact zone. Their accumulation can produce a bed of powder, which separates (partially or completely) the surfaces and reduces the surface interactions.
- At the last stage, debris is finally ejected outside the contact zone. The interaction between surfaces intensifies, wear appears and the cycle starts again.

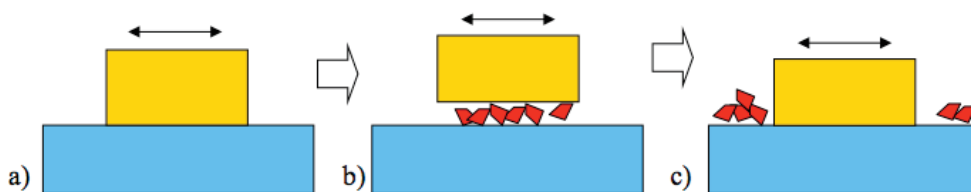

Figure 3: The three stages of the third-body approach of wear a) debris emission, b) debris circulation and c) debris ejection (Godet).

The current definition of wear corresponds to the global mass of material *definitively lost* by the system. So wear rate results from a balance between the detachment and the elimination of debris. We can say that “a good friction pair is one which is willing to sacrifice its surface to save its volume”.

Application to friction and wear of structural ceramics

Brittle materials such as ceramics perfectly illustrate the model. Four structural ceramics were studied in dry condition in air: an aluminum oxide, a silicon carbide, a silicon nitride and a partially stabilized zirconia, for speeds ranged from 0.1 m/s to 4 m/s and loads from 1 N to 40 N, using a ceramic roller sliding against a flat sample made of the same ceramic material [9].

Microscopic examinations revealed the production of a large quantity of debris within and also outside the wear track (Fig. 4a). Wear rates and friction coefficients as a function of sliding speed, always show an opposite evolution, so that the minimum wear rate corresponds to the maximum friction coefficient with a critical speed close to 0.5 m/s for all ceramics (Fig. 4b). These unexpected results can be clearly explained on the basis of the third body approach:

- Below 0.5 m/s, increasing speed causes wear rate reduction, which indicates a rise in load-carrying capacity of debris. This phase confirms an accumulation of debris trapped inside the contact zone as a result of recycled debris by the rotating roller. This phase also indicates that a debris accumulation corresponds to a rise in the friction coefficient.
- Above 0.5 m/s, the wear rate increases and the friction coefficient decreases. This fact indicates a reduction of load-carrying capacity of debris as a consequence of the expulsion of debris from the contact zone.
- The critical speed of 0.5 m/s corresponds to the limit of both phases of accumulation and elimination. Actually, it's related to the centrifugal action of the rotating roller, which becomes sufficient to expulse debris from the track and prevents their recycling. This is a characteristic of the device kinetic: it is logically independent of the ceramic materials.

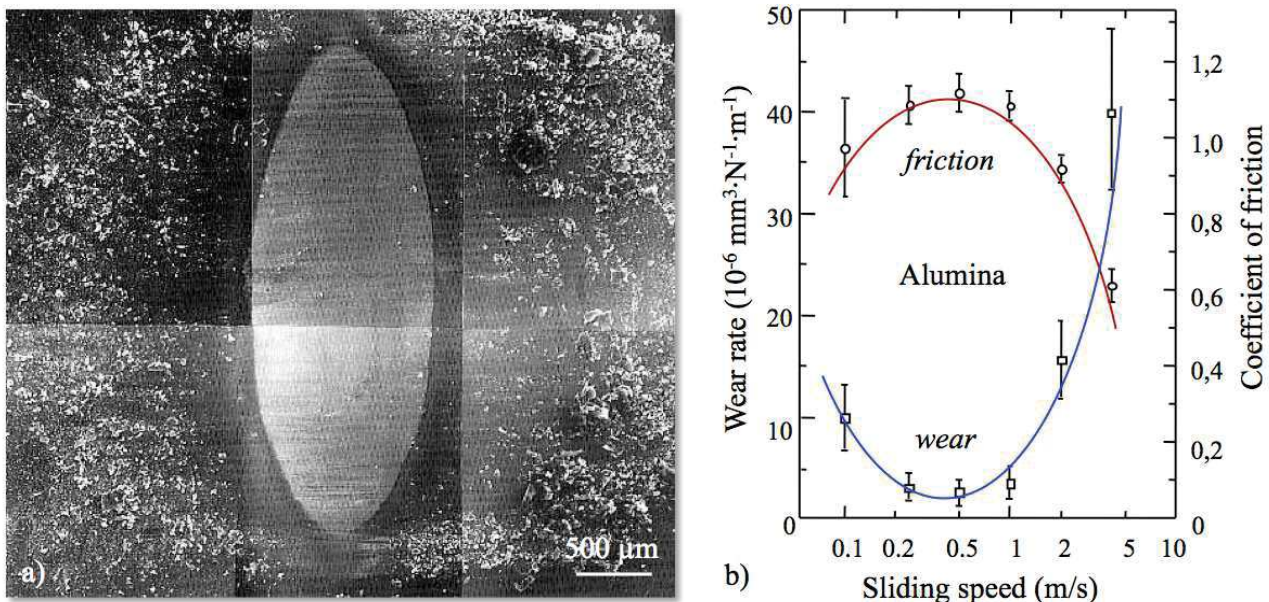

Figure 4; a) Optical observation of a silicon carbide surface showing debris in and out of the track and b) opposite evolution of friction and wear for an alumina-alumina contact as a function of speed.

These results show that the coefficient of friction reveals the amount of debris lying in the contact zone, and the wear rate determines the debris flow moving inside the contact zone. The cohesion and the rheology of debris influence the wear behavior. In this study, when small free debris forms a bed of individual particles, they separate the surfaces, assume a load-carrying

capacity and have a protective aspect. But when particles form large films adherent to the worn surfaces, they are usually associated to high wear by large grain pull-out as a result of a lower load-carrying capacity compared to free particles. If wear particles are intentionally removed from the contact zone (wet brush), it induces a drop in the friction coefficient and, in parallel, a quite marked increase in wear rate. This proves that the removal of debris causes wear rate increasing and therefore that wear particles present an effective load-carrying effect.

3. Conceptual and structuring tools

The absence of unifying model and the fact that there is no predictive theory of friction and wear must be balanced by a helpful and pragmatic methodology to describe precisely wear processes. Three conceptual tools, developed by Yves Berthier since the end of the 80's, are available for a better understanding of friction phenomena and improving performance and reliability of rubbing contacts.

- The *tribological triplet*, which is a multi-scale description of the tribo-system.
- The *accommodation mechanisms*, which identifies the sites and the modes of local operating mechanisms to achieve the displacement.
- The *tribological circuit*, which is a dynamic view of the particle flows moving through the contact zone.

First tool: the tribological triplet

A tribo-system must be considered at three levels [10]:

- The *working device* imposes the working conditions, transmits the load and the sliding mode. The main parameter is here the mechanism stiffness.
- The *contacting materials* sustain the working conditions of the device, react by mechanical and chemical changes. The effect of the contact geometry and the nature of the contacting materials are dominating factors.
- The *interfacial elements* separate the contacting materials, transmit the load from one solid to the other. The effect of particle adhesion and rheology governs the local behavior of the contact.

An illustration can be found with the attempt to standardize tribological practices (VAMAS). A large repeatability and comparability campaign of friction and wear data was initiated at the end of the 80's where 31 laboratories from 7 countries performed the same test [11]. The aim was to experiment steel-steel (AISI 52100) sliding on ball-on-disc configuration (ball of 10 mm in diameter, running at a radius of 16 mm from the center of the disc) under close controlled conditions (10 N, 0.1 m/s, 1 km, dry conditions of 50 % RH). The results in terms of coefficient of friction are given in Fig. 5.

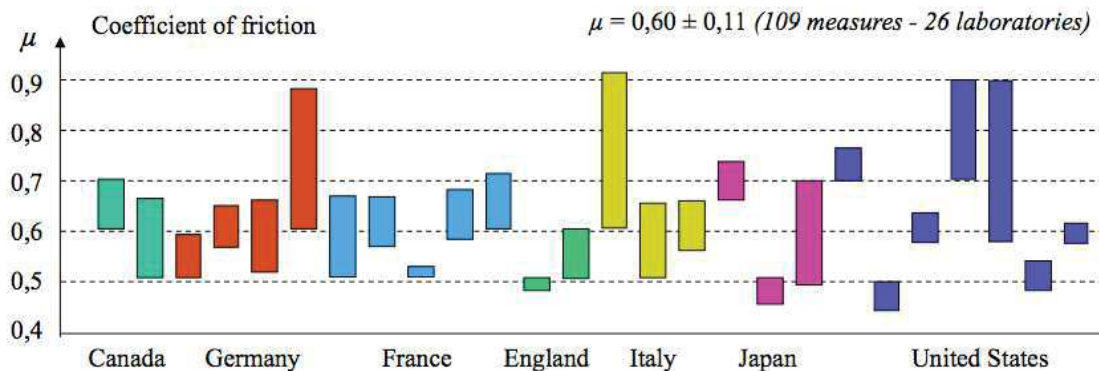

Figure 5: VAMAS results of repeatability and comparability of friction for a steel-steel contact under dry condition and close controlled operating parameters.

The main reason for a so large scatter in the results is that no specifications were done considering the experimental device. The different stiffness of the devices can explain such dispersion.

Second tool: the accommodation mechanisms

The second tool identifies how the relative displacement between the two contacting solids is done, in particular on how speed gradient through the interfacial elements is formed. The speed accommodation can be localized at different *sites* and produced by different *modes* (Fig. 6).

In a basic contact, the sites of accommodation should be [12]:

- in the working device referred to as S_0 ,
- in the skin of the sliding materials (first bodies) referred to as S_1 and S_2 ,
- in the volume part of the third body referred to as S_3 .
- in the natural screens (the superficial part of the third body) referred to as S_4 and S_5 .

The modes cover the basic concepts of fracture mechanics and material behavior, that is:

- the elastic deformation referred to as M_0 (no energy dissipation mode),
- the plastic deformation M_1 ,
- the fracture mode M_2 (crack propagation),
- the shearing mode M_3 ,
- the rolling mode M_4 (roller formation).

The combination of one site and one mode, referred to as $SiMj$, constitutes an accommodation mechanism occurring on the observed spot of the contact zone. In practice, for symmetry reasons, only eight of them are usually observed: three in the first bodies, one in the screens and four in the third body [13].

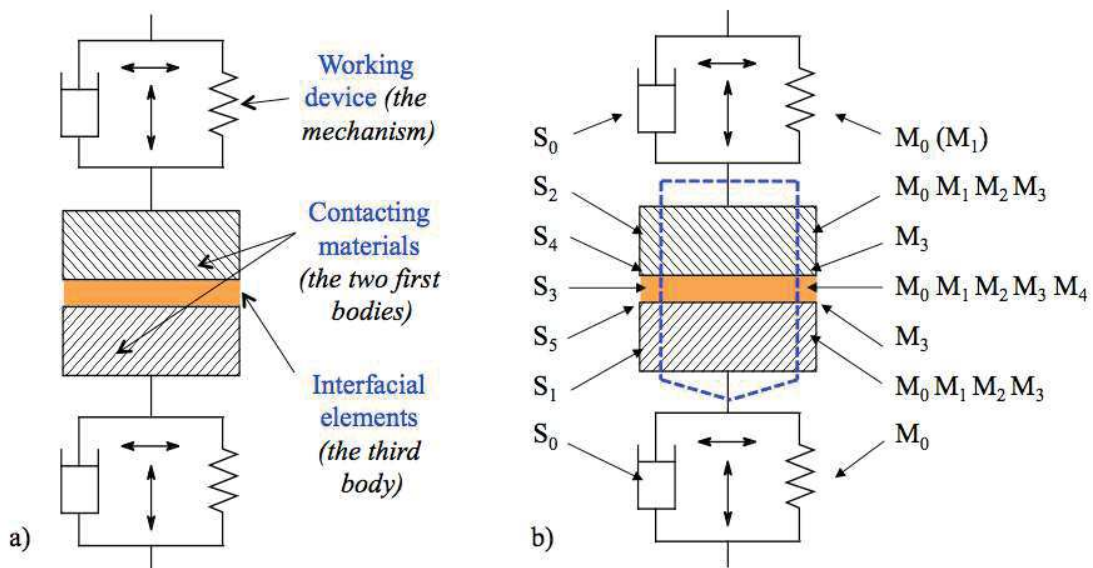

Figure 6: a) The tribological triplet defines the tribo-system; b) The different sites and modes of speed accommodation in a tribo-system.

Figures 7 and 8 illustrate several cases of accommodation mechanisms: superficial creep S_1M_1 , superficial cracking S_1M_2 , interfacial shearing S_3M_3 and rolls formation S_3M_4 .

The materials "choose" to locally activate the suitable accommodation mechanism able of side stepping the locking effect imposed by surface adhesion. In dry friction, several mechanisms can coexist in the same contact. Migrating site and changing mode during friction are possible: the contact is subdivided into active zones, de-active zones or re-active zones...

An additional concept concerns the *tribological transformed structures* (TTS). It corresponds to a first body response by superficial (phase) transformations, tribologically activated, often observed, in particular after fretting-wear (friction induced by small displacements under vibrating actions)

[14]. Different mechanisms have been proposed such as Mechanical Mixing Layer (MML), High Temperature Phase Transformation Material (HTPTM) and Dynamic Crystallization (which produces nanometric grain size under high plastic deformation). These TTS often lead to the detachment of particles that feed the third body.

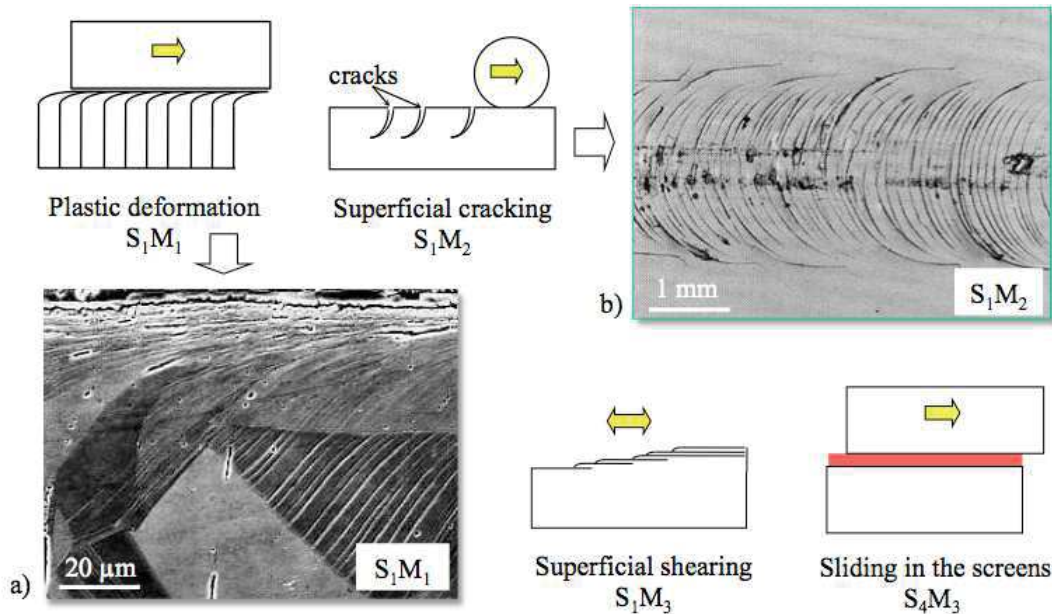

Figure 7: Schematic views of accommodation mechanisms in the first bodies and the screens; a) cross section of an austenitic steel showing superficial creep S_1M_1 and b) glass surface after friction on a steel ball showing superficial cracking S_1M_2 (Hertzian cracks behind the contact).

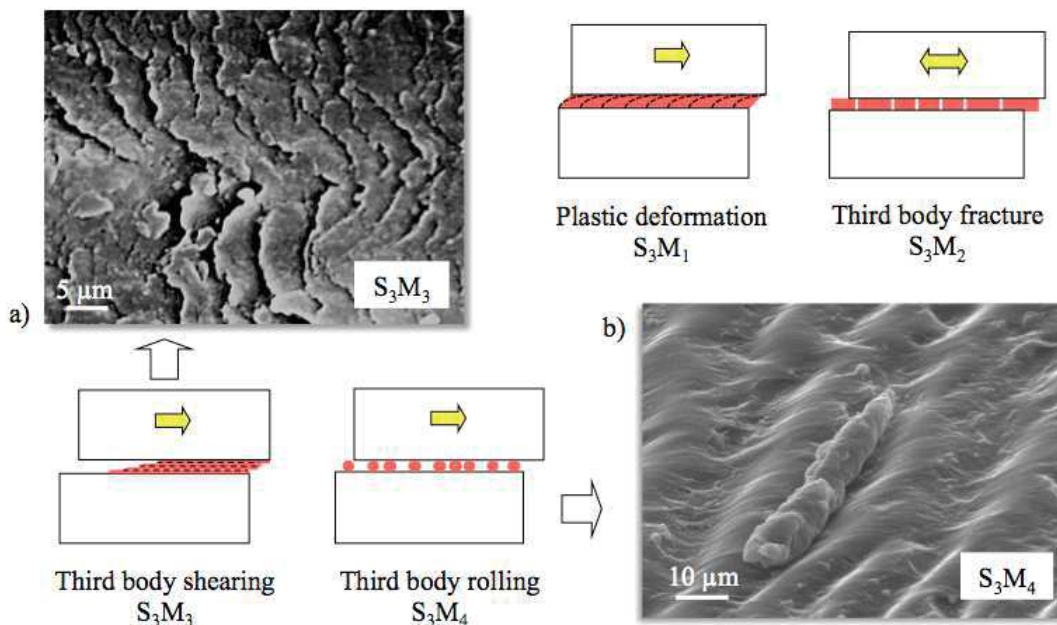

Figure 8: Schematic views of accommodation mechanisms in the third body; a) interfacial shearing S_3M_3 in an alumina-alumina contact and b) roll particle associated to Schallamach waves illustrating a rolling accommodation S_3M_4 in an elastomer (TPU)-steel contact.

Third tool: the tribological circuit

The last tool defines the different flows of matter into, through and out of the contact. It helps to establish the mass balance between what comes into the contact and what comes out (Fig. 9a).

- The *source flow* Q_s is the matter, which feeds the contact by detachment of particles from the surfaces of the two first bodies Q_s^{int} or by introduction of an artificial lubricant Q_s^{ext} .
- The *external flow* Q_e is the matter, which gets out. Part of this matter can be re-introduced Q_r and the rest is definitively lost by the contact: this final part is the *wear flow* Q_w .
- The amount of particles moving inside the contact is referred to as the *internal flow* Q_i .

A competition establishes between the wear flow Q_w and the source flow Q_s . The mass equilibrium of the system involves that the amount of particles M_i of third body per unit of time (dM_i/dt) should be equal to the difference between Q_s and Q_w [15].

A closed contact, where no ejection is possible ($Q_w = 0$), allows the study of particle detachment. The source flow Q_s is found to be inversely proportional to the amount M_i of particles in the contact. Actually, if the amount of third body rises then stresses on the first bodies decrease, so the amount of third body tends towards a maximum M_i^{max} until the source flow stops (Fig. 9b).

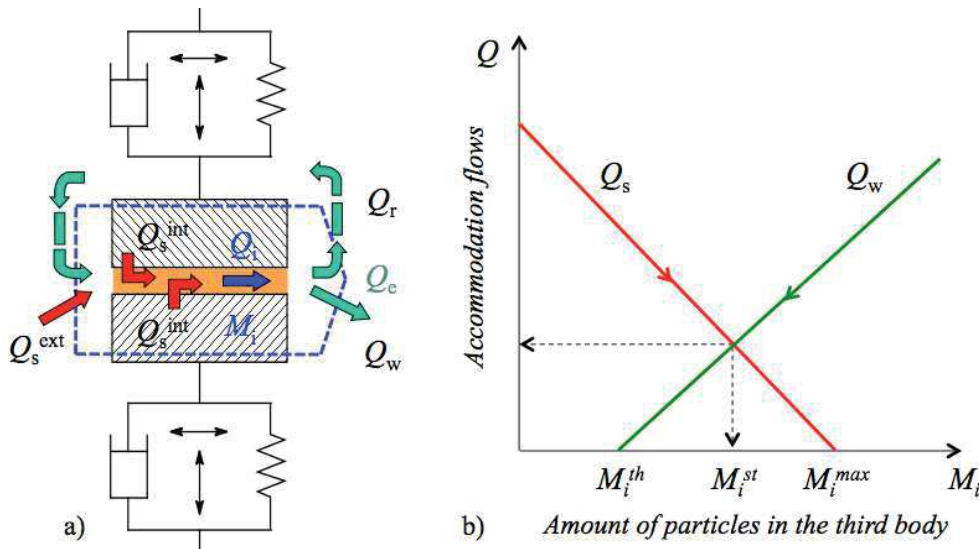

Figure 9: a) Partition in flows of matter into, through and out of the contact, defining the tribological circuit and b) Competition between source flow and wear flow leading to a matter balance during the steady state of sliding (symbol definitions are given in the text).

In an open contact, ejection reduces the amount of third body trapped in the contact, so stresses on the first bodies and source flow increase until it stabilizes at a certain amount M_i^{st} of third body. That proves wear flow controls source flow. Moreover, a minimum amount of third body M_i^{th} is required to operate ejection. The steady state is reached when the wear flow balances the source flow ($Q_w = Q_s$) and the amount M_i^{st} of third body stabilizes between the range of M_i^{th} and M_i^{max} .

Future progress will ensure by numerical simulation methods with the possibility to study separately interactive parameters, like mechanical and adhesive interactions between spheres (Discrete Element Method) [16].

Illustrating applications

The first example reported here concerns wear tests of *artificial hip joints*. Such tests are usually carried out with simulators using a flexion-extension movement with a specific load cycle (where the applied load was chosen at 3500 N during flexion and at 800 N during extension, which is representative of a stairs ascent). Results reported here were performed using femoral heads made of alumina or zirconia ceramics and cups made of polyethylene (UHMWPE) run in distilled water during $2 \cdot 10^6$ cycles [17].

The friction coefficient is directly account for the imposed kinetic and load cycle of flexion and extension and observations of the polyethylene cups reveal a contact partitioning in specific accommodation zones (Fig. 10):

- The first zone is at the beginning of the flexion where high friction coefficients were recorded (about 0.35). This zone was characterized by abrasive wear associated with permanent deformation. It corresponds to the source flow Q_s and the accommodation mechanism was identified as $S_1 M_3$.
- The intermediate zone (polar zone) is in permanent contact with the ceramic head during the whole test duration. Here, the coefficient of friction is low (about 0.05). The polymer remains undamaged but thin superposed layers of debris have protected the initial surface where machining striations can still be observed beneath the debris layers. This zone corresponds to the internal flow Q_i associated to an $S_3 M_3$ accommodation mechanism.
- The third zone is at the beginning of the extension where high friction coefficients (about 0.4) were recorded again. This zone is periodically released like the first one. There is decohesion and fracture of the layers. It corresponds to the wear flow Q_w now associated to an $S_3 M_2$ mechanism.

The originality of this particular configuration lies in the fact that such zones are usually hardly distinguishable in classical tribological situations and are well separated here.

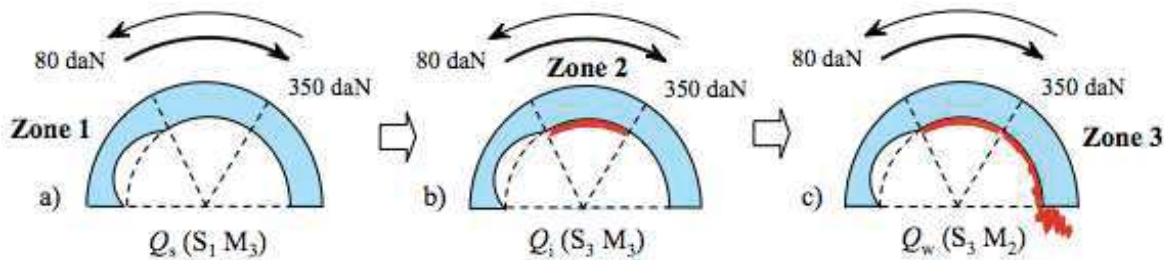

Figure 10: Partition of the contact in an artificial hip joint simulator; a) back equatorial zone (beginning of flexion and source flow origin), b) polar position zone (permanent contact and internal flow location) and c) front equatorial zone (beginning of extension and wear flow production).

A second example is referring to *drill bit insert* made of cemented carbide such as WC·Co. Alumina was used to accelerate the wear kinetics compared to rock samples [18]. Wear kinetics were established by video recording and mechanisms of third body formation were analysed. The role of the metallic blinder of the cemented carbide was related to the surface hardness and to the third body rheology. The same methodology was followed for the effect of grain size. Finally, specific accommodation circuits were proposed in the form of schematic images in order to give a general view of the wear phenomena (Fig. 11).

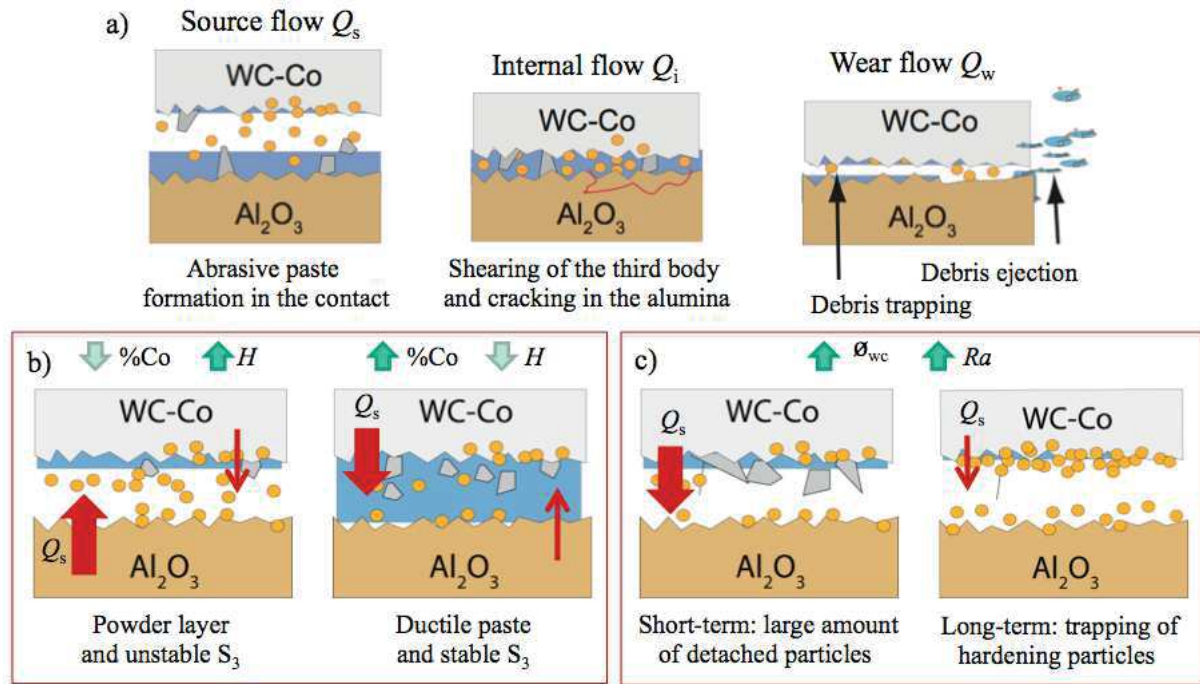

Figure 11: Wear study of drill bit insert WC.Co; a) Proposed tribological circuit, b) role of the Co metallic blinder of the insert in the third body formation and c) role of the grain size of the insert in the third body formation (arrow size illustrates the intensity of the different flows of matter).

Aircraft challenge

The main objectives for aircraft industry consist to save weight (passive parts of the plane) and to enhance engine performances (active part of the plane involving propulsive and brake systems). These two challenges are close to a precise knowledge of structural materials. Composites materials, enhanced aluminum-lithium or titanium alloys are intensively studied for their interesting compromise between performances and density, while strengthened superalloys and ceramics give rise to higher working temperature and then higher powerful turbo-engines. However, surfaces generally remain the weak point of all materials, so friction and wear of numerous parts could rapidly achieve to critical situations because of severe operating conditions in terms of contact stresses, permanent vibrating environment, poor lubricating conditions and wide temperature ranges. Such components, in particular for assemblies and sliding parts, usually work at the limits of its capacities and any change could induce important and unexpected damages.

The vibrating environment could involve severe consequences on friction parts by introducing small displacement (fretting phenomenon), which must disrupt the equilibrium of the different particle flows, like spurious particle ejection... Many studies have considered such fretting phenomenon because of its major importance on security, especially for the engaging firtree between turbine disk and associated blades [19, 20]. Actually, such displacements could cause severe wear and contact instabilities (fretting-wear), but also crack propagation and fracture (fretting-fatigue). This phenomenon occurs everywhere in aircraft assemblies and must be considered as an additional component in the global stress field. Important structural parts of a plane are subjected to such complex stresses like socket connection elements of the engine pylon (ball-joint link) or carbon graphite bushing in the vicinity of the combustion chamber because of enhance working temperature [21].

Finally, carbon/carbon brakes widely used for aeronautic applications are relevant to a more classical sliding situation. Friction behavior is widely studied by considering not only the surface and interface response of the contacting material but also the mechanical role of the surrounding structure mainly determined by elasticity and stiffness, as recommended by the analysis of the tribological triplet [22].

Synthesis and last comments

A realistic analysis of any practical tribological application requires to consider all the contributions of the tribological system with respect to different scales including the working device, contacting materials (or first bodies) and interfacial elements (or third body). A third body always separates the contacting materials and usually imposes a dominating action.

Friction is relevant to the instantaneous changes in sites and modes of velocity accommodation within the contact zone. Transitions in friction coefficients often give information for separating the successive stages, which defines the contact life.

Wear must be analyzed as a dynamic flow considering emission, retention and ejection of debris. Adhesion, abrasion, delamination, surface fatigue... are only mechanisms of particle detachment which are only one stage of the overall wear process.

Wear mechanisms are relevant of a sequence of stages focused on the debris behavior significantly dependent from the tribometer stiffness.

The efficiency of the third body approach is now amply proven. However, this approach is not a predictive model but it provides a useful and structuring tool, a general and unifying method based on academic and industrial experience, which helps to identify the multi-scale interactions occurring in a tribological processes.

References

- [1] D. Dowson (1979), *History of tribology*, 720 pages, Professional Engineering Publishing ISBN 1-86058-070-X (reprint 1998).
- [2] C.A. Coulomb (1821), *Théorie des machines simples*, *Mém. Acad. Roy. Sci. Paris* Tome X, pp. 161-342; new edition Hachette 2012 (in French) 368 pages, ISBN 9782012628021; Free on BNF site: gallica.bnf.fr/ark:/12148/bpt6k1095299.
- [3] F.P. Bowden, D. Tabor (1950), *The friction and lubrication of solids*, Part I, Clarendon Press, Oxford (374 pages), ISBN 0 19 850777 1.
- [4] J.F. Archard (1953), Contact and rubbing of flat surfaces, *J. of Applied Physics* 24, pp. 981-986.
- [5] M.C. Meng, K.C. Ludema (1995), Wear models and predictive equations: their form and content, *Wear* 181, 443-457.
- [6] S.C. Lim, M.F. Ashby (1987), Wear mechanism maps, *Acta Metallurgica*, 35, pp. 1-24.
- [7] P. Jost (1966) Jost Report Education and research, UK Dept. Education and Science, HMSO.
- [8] M. Godet (1984) The third body approach: a mechanical view of wear *Wear* 100, pp. 437-452.
- [9] J. Denape, J. Lamon (1990), Sliding friction of ceramics: mechanical action of the wear debris *J. of Mat. Sci.* 25, pp. 3592-3604.
- [10] Y. Berthier (1988), *Mécanismes et tribologie*. Thèse d'état es-sciences, INSA de Lyon, 156 pages.
- [11] H. Czichos, S. Beker, J. Lexow (1987), Multilaboratory tribotesting: results from the Versailles Advanced Materials And Standards programme on wear test methods (VAMAS), *Wear* 114, pp. 109-130.
- [12] Y. Berthier, L. Vincent And M. Godet (1992), Velocity accommodation sites and modes in tribology, *Eur. J. Mech. A/solids*, vol. 11, 1, pp. 35-47.
- [13] J. Denape, Y. Berthier, L. Vincent (2001) Wear particle life in a sliding contact under dry conditions: third body approach, *Fundamentals of Tribology and Bridging the Gap Between Macro and Micro-Nanoscale*, NATO Science Series II, vol. 10, pp. 393-411.
- [14] E. Sauger, L Ponsonnet, J.-M. Martin, L. Vincent (2000), Study of the Tribologically Transformed Structure created during fretting tests, *Tribol. Intern.* 33, pp. 743-750.
- [15] S. Descartes, Y. Berthier (2002) Rheology and flows of solid third bodies: background and application to a MoS_{1.6}, *Wear* vol. 252, pp. 546-556.

- [16] N. Fillot, I. Iordanoff, Y. Berthier (2005) Simulation of wear through mass balance in a dry contact, *ASME Journal of Tribology*, vol 127, pp. 230-237.
- [17] C. Boher (1992) *Simulation expérimentale du comportement tribologique des matériaux prothétiques de la hanche* Doctorat de l'Institut National Polytechnique de Toulouse, n° 561, 160 pages.
- [18] M. Yahiaoui, J.-Y. Paris, J. Denape, A. Dourfaye (2014) Wear mechanisms of WC-Co drill bit inserts against alumina counterface under dry friction: Part 1 - WC-Co inserts with homogenous binder phase content, submitted to *Wear*.
- [19] S. Fouvry, C. Paulin, S. Deyber (2009) Impact of contact size and complex gross-partial slip conditions on Ti6Al4V/Ti6Al4V fretting wear, *Tribol. Intern.* vol. 42, pp. 461-474.
- [20] G. Ural, J.-Y. Paris, J. Denape, J.-D. Beguin, J. Gurt Santanach, A. Weibel, A. Peigney, Ch. Laurent, G. Chevallier, C. Estournes, Y. Paranthoen (2009) Fretting behavior of alumina nanocomposites densified by SPS, *2nd European Conf. on Tribology (ECOTRIB)*, vol. 1, pp. 213-218, ISBN 978-884672426-7.
- [21] K. Delbe, S. Orozco Gomez, J.-M. Carrillo Mancuso, J.-Y. Paris, J. Denape (2012) Tribological behaviour of stellite matrix composites for high temperature applications *Key Engineering Materials*, vol. 498, pp. 89-101.
- [22] W. Österle, I. Dörfel, C. Prietzel, H. Rooch, A.-L. Cristol-Bulthé, G. Degallaix, Y. Desplanques (2009) A comprehensive microscopic study of third body formation at the interface between a brake pad and brake disc during the final stage of a pin-on-disc test, *Wear*, vol. 267, pp. 781-788.