



HAL
open science

Heavy Duty Vehicle Cooling System Auxiliary Load Management Control: An Application of Linear Control Strategy (MIMO and SISO)

Salvador Sermeno Mena, Eric Bideaux, Tessa Morgan, Xavier Brun, Omar Ameur

► **To cite this version:**

Salvador Sermeno Mena, Eric Bideaux, Tessa Morgan, Xavier Brun, Omar Ameur. Heavy Duty Vehicle Cooling System Auxiliary Load Management Control: An Application of Linear Control Strategy (MIMO and SISO). 2014 International Mechanical Engineering Congress and Exposition, Nov 2014, Montréal, Canada. IMECE2014-39534, pp. V08AT10A085, 14 p., 10.1115/IMECE2014-39534 . hal-01153976

HAL Id: hal-01153976

<https://hal.science/hal-01153976v1>

Submitted on 30 Mar 2023

HAL is a multi-disciplinary open access archive for the deposit and dissemination of scientific research documents, whether they are published or not. The documents may come from teaching and research institutions in France or abroad, or from public or private research centers.

L'archive ouverte pluridisciplinaire **HAL**, est destinée au dépôt et à la diffusion de documents scientifiques de niveau recherche, publiés ou non, émanant des établissements d'enseignement et de recherche français ou étrangers, des laboratoires publics ou privés.

IMECE2014-39534

HEAVY DUTY VEHICLE COOLING SYSTEM AUXILIARY LOAD MANAGEMENT CONTROL: AN APPLICATION OF LINEAR CONTROL STRATEGY (MIMO AND SISO).

Salvador Sermeno

Institut National des Sciences Appliquées de
Lyon
Villeurbanne, Rhones-Alpes, France

Eric Bideaux

Institut National des Sciences Appliquées de
Lyon
Villeurbanne, Rhones-Alpes, France

Tessa Morgan

Volvo GTT
St Priest, Rhones-Alpes,
France

Xavier Brun

Institut National des
Sciences Appliquées de Lyon
Villeurbanne, Rhones-Alpes,
France

Omar Ameer

Institut National des
Sciences Appliquées de Lyon
Villeurbanne, Rhones-Alpes,
France

ABSTRACT

Vehicle Thermal Management covers the engineering field of solutions that maintain the complete vehicle in acceptable operating conditions regarding components and fluid temperatures in an engine. The maximum efficiency rating of a Diesel engine reaches up to 45%; a vast amount of the energy produced is transformed into heat. This heat is partly rejected in the exhaust gases and partly transmitted to the engine cooling circuit. The latter can be seen in two different ways, on the one hand, cooling is necessary to regulate the fluids and component temperature to an optimum operating point for fuel efficiency and maintain engine performance. On the other hand it constitutes a loss since the coolant system actuators are engine driven (pump, fan, etc.).

In order to improve the fuel efficiency of the vehicle one can reduce the losses generated by the cooling system. Ideally, the full motive force of the engine should be used for propulsion, and new and more efficient energy sources have to be explored to power the secondary systems (cooling, compressed air...). The electrification of some components in the cooling system can limit losses and improve component energy efficiency but it is not the only answer and in many cases this approach might be a limited. Recent studies have shown that by improving the control strategy of the cooling system the fuel consumption can be improved, however no real data is available since its implementation has been limited.

In keeping with latter approach, this paper introduces a novel control which aims at a more efficient regulation of the

cooling system operation of a Heavy Duty Truck cooling system. The main complexity in such a system remains the interactions between actuators. In this paper we propose a way to solve this using a control based on model inversion and decoupling strategy. It needs to be noted that any new approach requires the current control specifications to be modified. This enables also a better understanding of the system. However, other goals can be exploited through the use of an advanced control and the new control specifications such as a reduction of thermal shock, reduction of thermal fatigue, minimization of system overcooling (directly impacts fuel consumption but also the noise levels).

Finally, the controller has been tested on a Simulation Platform using a Matlab/Simulink (Controller) and compared to the existing system control using a reference driving cycle.

INTRODUCTION

Typically cooling systems of internal combustion engines are designed to protect the engine from overheating in the worst driving conditions. It still is the main aspect for the sizing of such systems even if those conditions are rarely achieved (5% of the time). However, the complexity of systems that demand cooling has increased (oil cooler, EGR cooler, air management for example). As a result, the cooling system concept is changing.

Recently, researchers have agreed that the cooling system shouldn't be conceived just to dissipate the heat produced, but to regulate it for all the different conditions. "Thermal

Management” is the term used to describe new technologies (materials, design tools, components, and controllers) that cooling systems developers apply to regulate the heat caused by the normal operation of an engine, an electronic system, or any other device. And this is becoming an important part of the industry’s drive to achieve higher performances.

Three main focus points can be drawn from the review of literature: development of new components (electric valves, electric pumps...), system simulations and advanced control (implementation of newly developed components). The cooling system is becoming more complex and, in most cases, it results in a modification of the demands made to the cooling system (oil cooler bypass, EGR cooler, air compressor, engine brakes, engine performance ...).

When several changes are made, a global view is needed and the complexity of said systems might hide interactions between controlled components that become evident in the final stages of vehicle validation (troubleshooting). The review of the current literature indicates that this hasn’t been studied yet, since most papers relate to a specific modification to the system. But future vehicles will be possibly using many different technologies.

A detailed list of Thermal Management concepts for heavy vehicles was given and reviewed by Wambsganss [23]. He also discussed some thermal management trends (computer control, heat storage...) but no tests were pursued. The work of Allen and Lasecki[2] completed this list. Electric valves, electric pumps, control of EGR cooler flow are some of the discussed concepts. The expected benefits of these optimizations are improved fuel economy (by decreasing the fan “On-Time” for example), decreasing engine warm-up time, increased oil life (optimized oil temperature) and decreased engine emissions (optimized combustion temperatures, fewer parasitic losses).

Exploitable results concerning an improvement in the cooling system control were first presented by Kluger and Harris [10]. They studied a HD truck (16 tons) and a minivan, both with electrified components and the fuel economy improvements obtained were in the range of 3 to 9 %. Similar improvements were obtained by Page et al. [14] for an army truck running at different constant speeds (steady state evaluations). In a similar domain, a transit bus was modified (replacement of the accessories and development of a different radiator to match the cooling performance of the electric fans) by Page et al.[15]. Page et al.’s bus was part of a fleet of public buses in the US for one month and showed a 2% fuel economy. However, the driving cycles weren’t specified and further work is expected.

THERMAL MANAGEMENT AND CONTROL THEORY

During the last decades, with the uprising of digital and computational technologies, the development of control applications is now emerging.

New modeling, control, estimation and monitoring strategies are being studied. Foremost, the new developed controlled laws shouldn’t interfere with the proper working of the vehicle. They have to suffer the inputs from the driver but the protection of the integrity of the vehicle must comply with current performance.

A list of evaluation criteria for control algorithms are:

- It needs to comply with all the requisites of the current cooling system.
- Faster warm up
- Reduction in overall fan-on time (noise, fuel economy)
- Limitation of the engine derating time
- Keep the engine (components) to an appropriate temperature

A main aspect that was studied for this works concerned the specifications for the control. Usually requirements are given by the supplier. If it was possible to understand better the true needs, not only it would be possible to anticipate them but optimize the system response. In this paper we use results of modifying the current way of working in order to use actual heat requirements, rather than coolant temperature.

In the truck industry, control techniques are also being developed. For Daimler AG, G thler et al. [25] patented a system that has actuators for adjusting liquid mass flow and air mass flow through a liquid-air heat exchanger, respectively. They also patented a controller using model predictive control for the pump (Reckels et al.[26]). This system focused mainly on the reduction of the fan activation, not the actual fan control. No results have been seen of such a system. A simple control was designed by Choukroun and Chanfreau [6], their aim was to improve fuel economy which they achieved in a test bench (2% improvement). Al Tamini et al. [1] built a servo-motor based cooling system. Lower power consumption was obtained and the controller performance was satisfactory during the simulations. Also, Lehner et al. [12], using a model based feedback control strategy for heavy duty diesel trucks in a simulated environment, proved that the power consumption of cooling systems actuators can be reduced considerably.

In this paper a flatness based approach for the control of two cooling system actuators (fan and oil thermostat) is presented. The originality of this article is given by the use and identification of the interactions of the oil circuit and the coolant circuit in order to improve the system performance. Currently the control is performed independently and in some industries is done separately. One of the advantages of the flatness approach is that it enables the decoupling of the systems outputs and inputs. ¹

Advanced control has different meanings according to the user (researcher or engineer). It is more than just the use of state of the art software or the use of a complex algorithm. It is central point to understand the process and its dynamics. Some

¹ Reviewer 1 comment 4

advantages of said technologies are lower energy consumptions, reduce wasted energy, improve safety and reduce emissions. This environment will lead to the development, in industry, of a model based control methodology enabling us to predict behaviors, anticipate issues and have a better understanding of the system's dynamics.

In the real system it could be possible to control up to 4 actuators (coolant thermostat, oil thermostat, water pump and fan) while only 2 sensors (outputs) are used (Engine outlet temperature and oil feed temperature). As a result of such architecture, a full system decoupling is not possible, there's an input/output mismatch. In order to apply the flatness control directly to the system it would be necessary to define 4 outputs. Nevertheless, it is possible to consider different operating conditions which are common in every driving cycle, in order to select the adequate input set in each case. These driving conditions are presented in the following table and are explained in the following paragraphs.

Table 1: Operating conditions for Flatness control

Operating Conditions/ Component	Warm Up (wu)	Driving around an operating Temperature (nc)	Driving high oil temp (ho)
Thermostat	Opening according to coolant temperature	Completely Open	Completely Open
Coolant Pump (low/high speed)	Low/high (not controlled using flatness)	Low/high (not controlled using flatness)	High
Fan (% speed)	OFF	Variable	Variable
Oil Bypass (% valve)	OFF	OFF	ON

The thermostat valve will not be controlled. It will remain the current wax thermostat that is temperature dependent. The coolant pump is a two speed pump (High and low speed). The fan speed is variable accordingly to the engine speed. And finally a variable bypass valve is used to control the flow through the oil cooler oil side.

In the first mode (wu), the primary objective consists in allowing the cooling system to achieve the set operating temperature (oil and coolant) In this case the fan action is unwanted (fan can only cool the coolant) . The oil bypass is kept closed so the oil reaches its operating temperature as soon as possible (colder oil increases the engine friction losses).

For the second mode (nc), the system has reached its operating temperature (coolant and oil). In this mode's objective is to regulate the coolant temperature at a given range. According to table 1, two controllable components are available. However in this paper, a simple control law has been used for the coolant pump (similar to the current control).

Finally the last mode (ho) corresponds to a too high oil temperature. The oil quality and its properties could be deteriorated if the temperature keeps rising. In this mode it is assumed that the pump is fully engaged and two outputs can be controlled (Fan and Oil Bypass).²

FLATNESS APPROACH

Let us discuss now the approach taken to develop an advanced control technique for the cooling system's components. This approach is based on the Flatness principle proposed by Fliess et al. [8] based on this, nonlinear and linear controls have been developed and will be described later.

According to Fliess a system is said to be differentially flat or simply flat if there exist variables x and its derivatives given by an equation of the form

$$y = h(t, x, x', x'', \dots, x^k) \quad (1)$$

such that the state variables x and the inputs u can be recovered from y (locally) by an equation of the form :

$$x = g(t, y, y', y'', \dots, y^l) \quad (2)$$

$$y = [u_1, u_2, \dots, u_m]^T \quad (3)$$

The variables y are referred to as flat outputs. When y is only a function of time and states, the system is said to be in a flat configuration.

Fliess et al studied the feedback linearization problem in the context of differential algebra and introduced the concept of differential flatness. The theory of differential flatness consists of a parameterization of the trajectories of a system by some outputs y , called the flat output and its derivatives.

Nonlinear systems that have the property of differential flatness are relatively easy to control. The most difficult part of using differential flatness is determining the flat outputs. Structural information can be exploited to determine if a system is flat and how to find the flat outputs. Proof of concept has been presented by Sira-Ramirez, H. K. Agrawal, S. [22] For a linear system, the flat outputs can be easily identified using the canonic form of controllability.

COOLING SYSTEM MODELLING

The Bond Graph (BG) approach has been chosen here to examine the circuits as a whole (coolant, oil, air and exhaust gases). This multidomain applicability is one of the strengths of the technique. It also offers a structured view of the system. The representation can evolve and be as simple (or complex) as the designer desires, thus enabling the conception of the system to a

² Reviewer 2 comment 3

certain precision (the level of precision depending on the goals of the analysis to be performed). In figure 1 we present a word bond graph of the cooling system which focuses on the functional level. As long as the initial bond graph is not simplified, it shows a clear resemblance to the topological structure in the system schematic

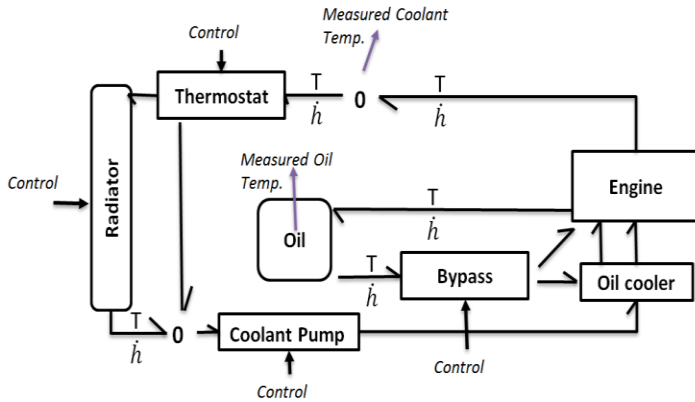

Fig.1. Word Bond graph of a basic Cooling system

However, the cooling system is a thermodynamic process in which both the thermal and fluid properties vary. The mutual dependency of these two domains adds complexity to the layout of the system (thermal flow depends on the mass flow from one point to the other). These complexities contribute to difficulties

advantage is that modeling of thermodynamic systems may become easier.

A sketch of a pseudo bond graph in for a cooling circuit is presented in figure 2. However, not all the components are represented, and only the coolant circuit is studied. The main hypothesis made was that the pressure drop is neglected in the system, and the pressure is nearly constant; only the flow rate is controlled. As a result, the pseudo bond graph is only relevant in the thermal domain.

In this paper we will present the linear approach for flatness control of this set of the cooling system. For control purposes, a simplified model is considered where only the heat exchange in the components is taken into account. Said components are the oil cooler, engine, radiator, the oil circuit and the coolant volume in the pump. The system is presented in figure 2. In the pseudo bond graph language, thermal capacities such as the radiator, the engine,... are represented by C elements. These C elements are storage components. The dynamics of the control volume (liquid volume and specific heat capacity of the metal) are given in equation (4).

$$C_p = \left(\frac{\partial Q}{\partial T} \right)_p = \left(\frac{\partial H}{\partial T} \right)_p \quad (4)$$

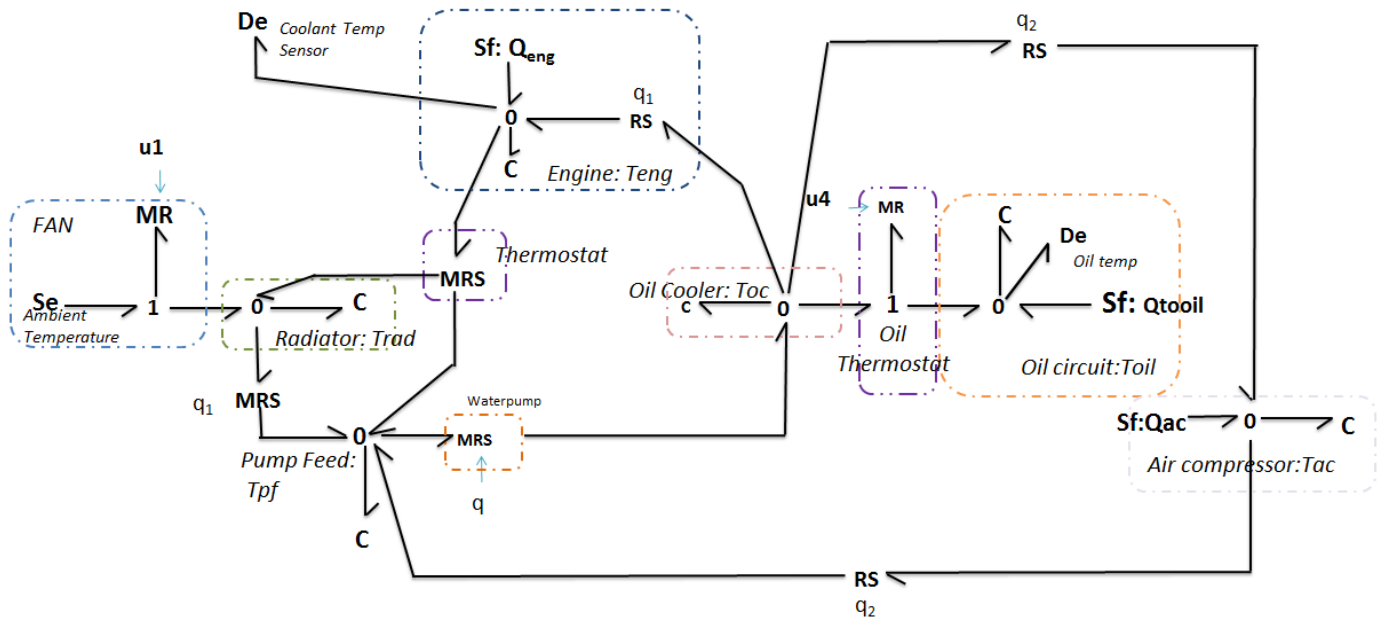

Fig. 2. Bond Graph of the simplified cooling system (oil cooler, air compressor and engine are represented for the coolant side)

in understanding and modeling of the process and system.

The pseudo bond graphs will be implemented. Although basic principles no longer apply, the basic elements describing physical effects can still be idealized and introduced in the layout. Furthermore, the conventional construction of a bond graph from a schematic and, then, the systematic derivation of equations from the bond graph still remain applicable. Their

The heat transfers are represented by RS elements. Said elements have been defined so that the coolant flow is respected during the BG analysis. Heat sources (e.g. heat from engine to

coolant) as Sf elements. If an element is controlled (Sf and RS) it is noted by a prefix M and said to be Modulated (MSf and MRS). Temperature sources such as ambient temperature are represented by source of effort that is a Se element. Finally 0-nodes represent temperature nodes and 1-nodes represent enthalpy flow nodes. It is possible to write the dynamics of the system directly from the pseudo BG.³

$$\frac{dT_{pf}}{dt} = \left[-cqT_{pf} + c(q - q_1 - q_2)T_{eng} + cq_1T_{rad} + cq_2T_{AC} \right] \times \frac{1}{C_{pf}} \quad (5)$$

$$\frac{dT_{oc}}{dt} = \left[cqT_{pf} - u_4(T_{oc} - T_{oil}) - cq_2T_{oc} \right] \times \frac{1}{C_{oc}} \quad (6)$$

$$\frac{dT_{eng}}{dt} = \left[c(q - q_2)T_{oc} - c(q - q_2)T_{eng} + \dot{Q}_{eng} \right] \times \frac{1}{C_{eng}} \quad (7)$$

$$\frac{dT_{rad}}{dt} = \left[cq_1T_{eng} - cq_1T_{rad} + u_1(T_{amb} - T_{rad}) \right] \times \frac{1}{C_{rad}} \quad (8)$$

$$\frac{dT_{AC}}{dt} = \left[cq_2T_{oc} - cq_2T_{AC} + \dot{Q}_{AC} \right] \times \frac{1}{C_{AC}} \quad (9)$$

$$\frac{dT_{oil}}{dt} = \left[u_4(T_{oc} - T_{oil}) - \dot{Q}_{toil} \right] \times \frac{1}{C_{oil}} \quad (10)$$

The equations above describe the nonlinear model which we obtain for the Bond Graph representation in Figure 2.

Where T_i is the temperature in a given node, C_i is the heat Capacity of a component, q is the coolant flow at the oil cooler, q_2 is the coolant flow through the air compressor, $(q - q_2)$ is the coolant flow through the engine, q_1 is the coolant flow through the radiator and Q_i are the respective heat inputs in each component when needed. Finally u_1 and u_4 are respectively the radiator heat exchange and the oil cooler heat exchange. It is related to our control specifications since u_1 depends on fan speed demand, and u_4 depends on the opening of the oil thermostat.

It has been assumed that heat capacity for each component is a function of the volume of coolant in the component and specific heat given by the mass of the material and is constant,

as is the density of the fluid and the materials conductivity. Additionally, the dynamics of the actuator aren't included in the model presented; the goal of this paper is not the precise modeling of the system but the implementation of a new control strategy.

Finally, considering the heat inputs into the cooling system, It can be said that the components can be classified either as heat generating or heat dissipating components. In the next paragraphs we will distinguish these classes.

The heat generating components category regroups all of the components that generate heat. These are the engine, the oil cooler, the air compressor, the retarder, the gearbox oil exchanger (if available). In normal operation we can identify the main heat source as the engine.

In the previous equations the heat inputs are required so it's necessary to determine them accordingly. For this case test data has been used to determine the heat input from the engine (as for other components). The heat generated by the engine has been found to be function of load and engine speed. For the algorithm that will be presented shortly after, we iterate values using the engine specifications and the current state of load and engine speed. The only component where heat is dissipated and that we can act on is the radiator. The heat dissipation depends on several factors including the geometry, the vehicle speed, the coolant flow and the fan speed.

A validation of the previous model in regards with real data was carried out regarding equations (5) to (10) and is presented in figure 3. The model used is a control model and does not intend to provide accurate results but this model is well adapted for control design purposes. As shown in figure 3, considering the simplicity of the results we are able to follow the dynamics of the system with a slight error (4 % maximum error). The error corresponds to the difference of the coolant temperature at engine outlet given by simulation results compare to the measured temperature using the same driving cycle.⁴ The error is mainly due to the approximation of some parameters of the dynamics, but also to a lack of information in the system (actual pump engagement is not always known, activation of oil thermostat,...).

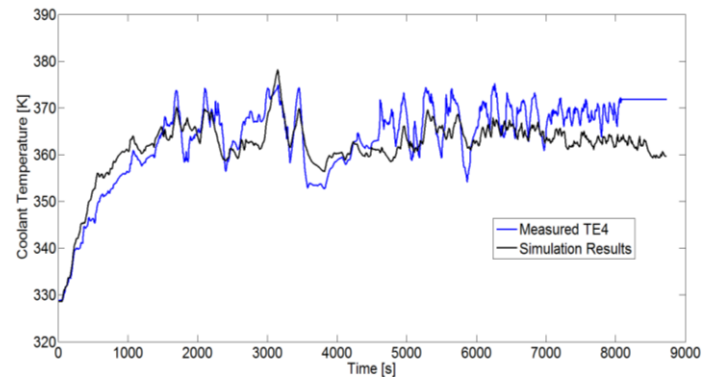

Fig.3. Engine coolant temperature error compared to test results

³ Reviewer 1 comment 1 comment 3

⁴ Reviewer 2 comment 4

LINEAR SYSTEM FLATNESS CONTROL

If a linear system can be proved to be controllable, then it is differentially flat, and the flat output can be easily identified using the canonic form of controllability [21]. This property can easily be proved when dealing with single input single output (SISO) systems, and an extension can be used for a multiple input multiple output (MIMO) system.

In this paper this two approaches are presented. Firstly we will determine the flat output for a SISO system, for which only the fan will be assumed to be controlled by the flat controller. The oil thermostat and pump are controlled by a simple set of rules. For these, full speed and full opening will be assumed from a set temperature. The thermostatic valve will remain temperature controlled. For both controllers, we will only deal with the regulation of the coolant temperature and Oil temperature. During the simulation, the controller isn't active during the warm up stage bounded by a set temperature (current operating temperature).

Accordingly, the previous model (5)-(10) has been linearized around an equilibrium point which is found in the regulation point of our control. The complete system dynamics can be found in Annex C.

The linear model determined for the SISO system is represented by (11) and (12).

$$\dot{x} = Ax + Bu \quad (11)$$

With:

$$A = \begin{bmatrix} \frac{-cq^o}{c_{pf}} & 0 & \frac{c(q^o - q_1^o - q_2^o)}{c_{pf}} & \frac{cq_1^o}{c_{pf}} & \frac{cq_2^o}{c_{pf}} \\ \frac{cq^o}{c_{oc}} & \frac{-cq^o}{c_{oc}} & 0 & 0 & 0 \\ 0 & \frac{c(q^o - q_2^o)}{c_{eng}} & \frac{-c(q^o - q_2^o)}{c_{eng}} & 0 & 0 \\ 0 & 0 & \frac{cq_1^o}{c_{rad}} & \frac{-(cq_1^o + u_1^o)}{c_{rad}} & 0 \\ 0 & \frac{cq_2^o}{c_{AC}} & 0 & 0 & \frac{-cq_2^o}{c_{AC}} \end{bmatrix}$$

$$B = \begin{bmatrix} 0 \\ 0 \\ 0 \\ \frac{(T_{amb}^o - T_{rad}^o)}{c_{rad}} \\ 0 \end{bmatrix}$$

$$x = [\partial T_{pf}, \partial T_{oc}, \partial T_{peng}, \partial T_{rad}, \partial T_{AC}]^T$$

$$u = [\partial u_1] \quad (12)$$

The controllability matrix is of full rank if

$$q_2^o \neq 0, q^o \neq 0, T_{rad}^o \neq T_{amb}^o$$

A brief demonstration of the method to determine the flat output for a SISO system is given in the Annex A.

The flat output is determined exploiting the results presented in Annex A.

$$\zeta = Gx \quad (13)$$

With

$$G = [0 \ 0 \ 0 \ 0 \ 1] [B \ AB \ A^2B \ A^3B \ A^4B]^{-1}$$

$$\zeta = G_1 \partial T_{eng} + G_2 \partial T_{AC} \quad (14)$$

With:

$$G_1 = \frac{c_{AC} c_{oc} c_{pf} c_{rad} c_{eng}^2}{c^4 q^o q_1^o (q^o - q_2^o - q_1^o) (c_{eng} q_2^o - c_{ac} (q^o - q_2^o)) (T_{amb}^o - T_{rad}^o)}$$

$$G_2 = -\frac{c_{rad} c_{oc} c_{pf} c_{eng} c_{AC}^2}{c^4 q^o q_1^o q_2^o (c_{eng} q_2^o - c_{AC} (q^o - q_2^o)) (T_{amb}^o - T_{rad}^o)} \quad (15)$$

For simplicity and clarity they have been presented in the previous equations. The complete solution is given in Annex A.

The fan control can be rewritten using the inversion (Annex C)

$$u_1 = \zeta^{(5)} + \alpha_4 \zeta^{(4)} + \alpha_3 \zeta^{(3)} + \alpha_2 \ddot{\zeta} + \alpha_1 \dot{\zeta} + \alpha_0 \zeta \quad (16)$$

In order to calculate the command, we need then to calculate the α_i which are defined in the matrix Λ of annexA and are a function of the considered equilibrium point. For simplicity and clarity they are presented in this paper in Annex A.

The flat output doesn't correspond to a physical output of the system. This forces us to rewrite the specifications for the control. It also has been proven in [21] that the found flat output is unique.

LINEAR SYSTEM FLATNESS CONTROL (MIMO)

Some cases deal with multiple inputs multiple outputs (MIMO) system. An extension of the SISO canonic form is presented in [21].

The linear model determined for the SISO system is represented by:

$$A = \begin{bmatrix} \frac{-cq^o}{c_{eng}} & 0 & \frac{c(q^o - q_1^o - q_2^o)}{c_{eng}} & \frac{cq_1^o}{c_{eng}} & \frac{cq_2^o}{c_{eng}} & 0 \\ cq^o & -(cq^o + u_4^o) & 0 & 0 & 0 & \frac{u_4^o}{c_{oc}} \\ c_{oc} & \frac{c_{oc}}{c_{eng}} & -c(q^o - q_2^o) & 0 & 0 & 0 \\ 0 & \frac{c(q^o - q_2^o)}{c_{eng}} & -c(q^o - q_2^o) & 0 & 0 & 0 \\ 0 & 0 & \frac{cq_1^o}{c_{rad}} & -\frac{(cq_1^o + u_1^o)}{c_{rad}} & 0 & 0 \\ 0 & \frac{cq_2^o}{c_{AC}} & 0 & 0 & \frac{-cq_2^o}{c_{AC}} & 0 \\ 0 & \frac{u_4^o}{c_{oil}} & 0 & 0 & 0 & \frac{-u_4^o}{c_{oil}} \end{bmatrix}$$

$$B = \begin{bmatrix} 0 & \frac{0}{-(T_{oc}^0 - T_{oil}^0)} \\ 0 & c_{oc} \\ 0 & 0 \\ \frac{T_{amb}^0 - T_{rad}^0}{c_{rad}} & 0 \\ 0 & 0 \\ 0 & \frac{T_{oc}^0 - T_{oil}^0}{c_{oc}} \end{bmatrix}$$

$$x = [T_{pf}, T_{oc}, T_{peng}, T_{rad}, T_{AC}, T_{oil}]^T$$

$$u = [u_1, u_4]^T \quad (17)$$

Given a linear system in state space formulation as shown in equation (11), the controllability of the system implies that we can deduce the Kalman controllability matrix such as:

$$\mathcal{C} = [B_1, AB_1, \dots, A^{\gamma_1-1}B_1, B_2, AB_2, \dots, A^{\gamma_2-1}B_2, \dots, B_m, AB_m, \dots, A^{\gamma_m-1}B_m] \quad (18)$$

Where γ_i , are the systems' Kronecker indexes of controllability, knowing that $\sum \gamma_i = m$, m being the system dimension.

As define for the previous mode the MIMO system have flat outputs of the type:

$$F = \begin{bmatrix} \Phi_1 \\ \Phi_2 \\ \Phi_3 \\ \vdots \\ \Phi_m \end{bmatrix} \mathcal{C}^{-1}x \quad (19)$$

Φ_i are row vectors defined such as:

$$\Phi_j = [0 \quad 0 \quad \dots \quad 0 \quad 1 \quad 0 \quad \dots \quad 0]$$

As is shown in (16), the control inputs to be calculated are the fan and oil overall heat transfer coefficient.

For the system shown, the controllability matrix is of full rank if

$$q_2^o \neq 0, q^o \neq 0, T_{rad}^o \neq T_{amb}^o, T_{oc}^o \neq T_{oil}^o$$

There is no restrictions in the choosing of γ_i , however it must respect $\sum \gamma_i = 6$. Two flat outputs are needed, and deciding that $\gamma_1 = \gamma_2 = 3$, allows both exits to have similar dynamics.

The found flat outputs are of the form:

$$\zeta_{il} = G_1 \partial T_{pf} + G_2 \partial T_{oc} + G_3 \partial T_{peng} + G_4 \partial T_{rad} + G_5 \partial T_{AC} + G_6 \partial T_{oil}$$

Where $G_i = f(q^o, q_1^o, T_i^o, C_i)$ and depends on the current coolant circuit characteristics. The output is presented in such a way for simplicity and clarity.

And the correspondent control inputs are determined in equations (19) and (20).

$$u_1 = \zeta_1^{(3)} + \alpha_2 \ddot{\zeta}_1 + \alpha_1 \dot{\zeta}_1 + \alpha_0 \zeta_1 \quad (20)$$

$$u_4 = \zeta_2^{(3)} + \alpha_2 \ddot{\zeta}_2 + \alpha_1 \dot{\zeta}_2 + \alpha_0 \zeta_2 \quad (21)$$

In order to calculate the command, we need then to calculate the α_i which are defined in the matrix Λ in annex A and are a function of the considered equilibrium points. For simplicity and clarity they are not presented in this paper.

IMPLEMENTATION OF THE FLATNESS CONTROLLER (MIMO AND SISO)

The implementation of previous controllers for the cooling system is shown in figure 4.

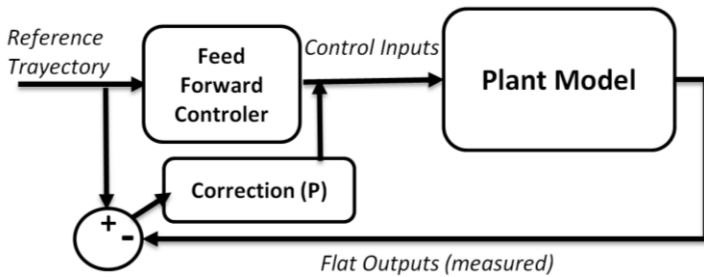

Fig.4. Flatness Control Basic Schematics

The controller will be used to regulate the cooling system around an operating temperature; in this case, the reference trajectory is constant and its derivatives are null. The reference input is obtained by inversion in the feed forward controller using equations (16), (20) and (21).

As previously stated the proposed control needs will be compared to the current control and an optimal control using a dynamic programming algorithm. Both controllers need to comply with all the requisites of the current cooling system in particular we must keep the engine (components) to an appropriate temperature, reduction in overall fan-on time (noise, fuel economy), limitation of the engine derating time.⁵

A closed loop is used in order to give robustness to the system. The correction is needed to deal with model uncertainties and better deal with unknown inputs. It has been set as a proportional gain.

FLATNESS CONTROL PERFORMANCE EVALUATION

Currently, no actual vehicle test has been foreseen for this work. The first results are being compared using simulations

only. Said simulations have been correlated using test results (On vehicle, test bench...). Firstly a simplified model using the equations presented in this paper was used. This model has been built using MATLAB/SIMULINK. A simulation platform is being prepared within the company, using both Matlab/Simulink for the controller and GT Suite for the cooling system. The GT suite simulation is currently being used for transient and steady state analysis of the cooling system and some work has been done coupling it with Matlab/Simulink. The two solutions presented (MIMO and SISO flat control) have been tested. The results are shown in figures 5 to 8 for a given cycle. We use data from a previous test for a 13 LT Heavy Duty vehicle in a partly highway, partly urban cycle.

The controller's performance has also been tested, comparing it not only to current control, but to also to an optimal control issued from an offline energetic optimization base dynamic programming (figure 10). The dynamic programming algorithm has been developed using the ETH toolbox [24]. The used model for this simulation was correlated with test results as well. The optimization of the cooling system was achieved by using the following cost function (22), the comparison of these results is presented in figure 7.

$$J = \int_T g(T_{eng}, W_{fan}, T_{max}, T_{ref}) \quad (22)$$

Where g is a function of the engine outlet coolant temperature (using a reference T_{ref} and a maximum temperature T_{max}), the fan energy consumption.

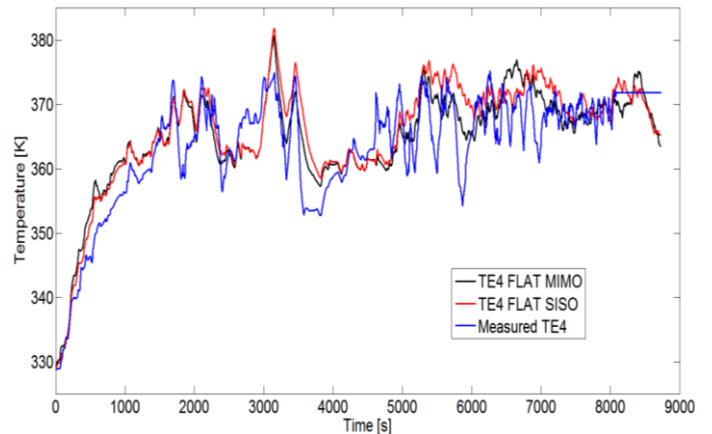

Fig.5. Coolant temperature at engine outlet for MIMO and SISO strategies and the current control.

In figure 5, it is shown the results of the coolant temperature evolution using the flat output control both by the MIMO and SISO controller. They are compared to a previous test result using the current control strategy in the company. The final temperatures are different in every case. Temperatures are lower in both cases. This can be an advantage when dealing with hot shutdowns that could lead to coolant leakage. True benefits of lower final temperature depend on the truck utility

⁵ Reviewer 2 comment 6

(distribution, highway). It is more interesting to show it the temperature evolutions rather than the flat output evolution since they do not correspond to a physical output, they represent a sort of heat capacity of the system, and its analysis does not appear to be of interest for the audience. A similar performance is shown by both controllers.

In figure 6, the evolution of the oil temperature is shown. Test results of the oil temperature were not provided, nor the oil thermostat activation. Moreover, the oil circuit has been simplified to equation (10) and the heat generated by the engine to the oil circuit is not known, an estimation has been used as explained previously. Only in the MIMO the oil thermostat is controlled. For the SISO solution, an approach similar to the current is used.

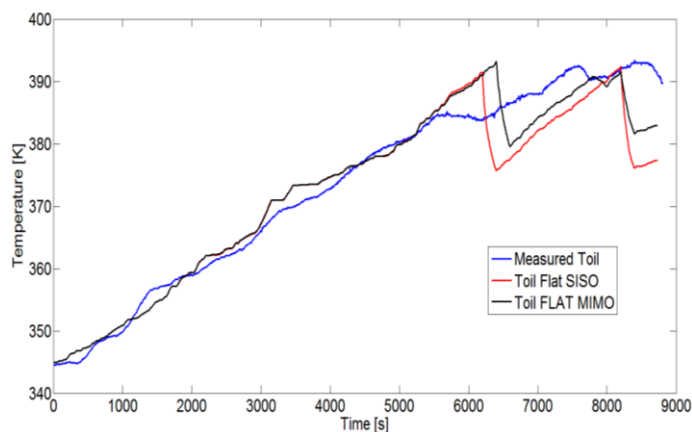

Fig.6. Oil temperature for MIMO and SISO strategies.

In figure 7, it is shown the fan request for each control strategy for the same reference cycle. Similar performance has been achieved by both controllers. The total energy used is shown in table 2. This might be caused by the assumptions made (thermostat assumed fully opened and pump assumed at full speed) but mainly, due to the action of the oil bypass. This can be seen in figure 8. Opening of the valve is done merely for cooling purposes just one the set temperature has been reached for the SISO system. However in our MIMO flat control the oil bypass, the oil temperature is held in a lower range. The effects of such a lower oil temperature cannot be estimated in the paper presented (engine performance might be affected due to increased friction losses).

In figures (6) to (9), the fan speed and oil thermostat opening is given. Since the model presented doesn't take into account the actuators dynamics, the fan speed is a function of the current engine speed and the fan request (in percentage). The requests are held during a specified time. Even if the controller is able to continuously update the signal, an actual fan is not able to respond fast enough; the controller has been downgraded to provide more realistic results.

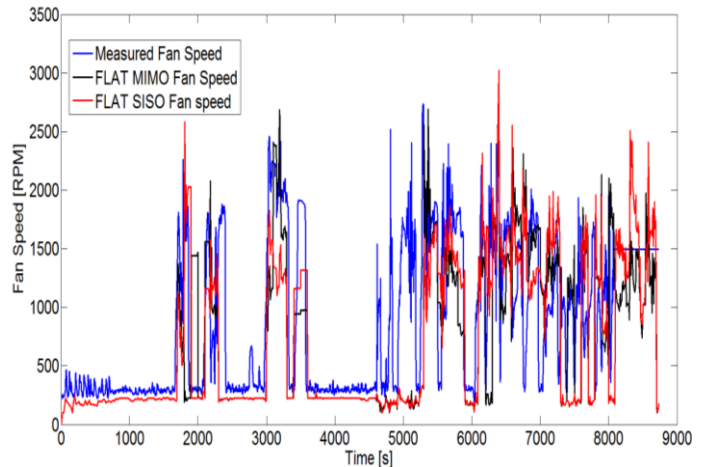

Fig.7. Fan request for MIMO and SISO strategies and the current control.

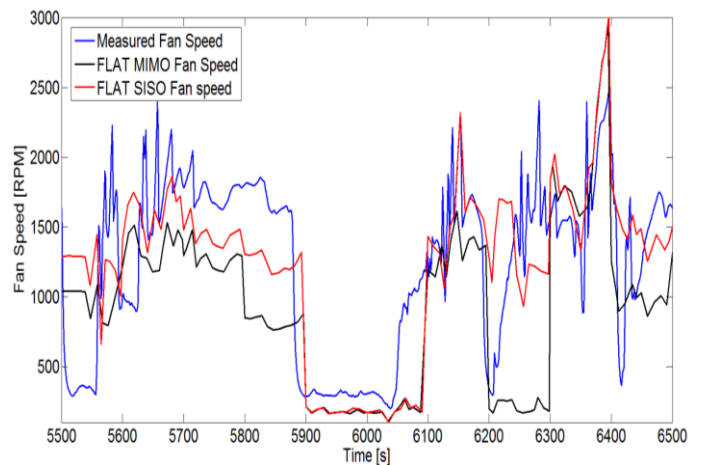

Fig.8. Zoom in Fan request for MIMO and SISO strategies and the current control.

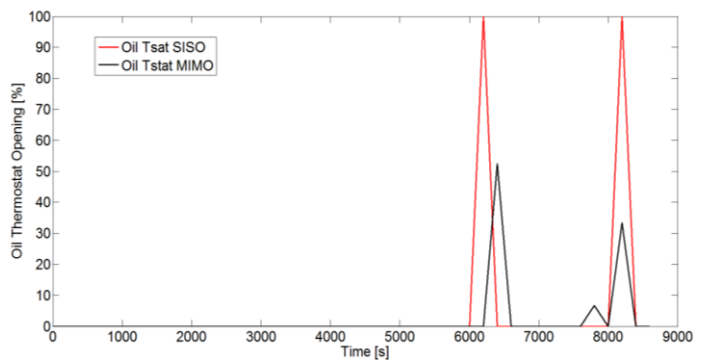

Fig.9. Oil thermostat request for MIMO and SISO strategies and the current control.⁶

Table 2: Energy Consumed during the same cycle for the different control strategies compared to the current control

⁶ Reviewer 2 comment 7

Component/ Control Strategy	Fan Consumption (% Energy gain)	Peak Fan Power (kW)
Linear Flatness SISO	+28	31
Linear Flatness MIMO	+30	41
Dynamic Programming	+60	54
Current Control	0%	31

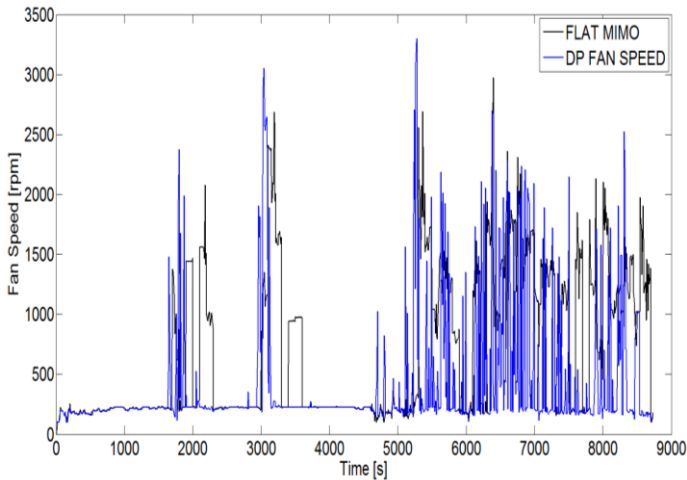

Fig 10. Comparison to an optimal solution (DP)

The dynamic programming solution was calculated for the same reference cycle. The DP algorithm controlled the fan speed, and a simplified model of the system was used. Using this results we can determined that DP control solution provides a large number of peaks compared to the current control that maintains the fan speed constant for a small window of time. The benefits of this haven't been determined in the algorithm. Some peaks are also present for the MIMO solution. It could be possible to introduce energy management through a combination of control theories (introduction of a prediction) to become aware of the energy consumption of the fan. Improvements can still be made on the flatness algorithm.

It also needs to be noted that the engine coolant temperature is 10 degrees cooler at the final state (which is the reference temperature used for the linearization). Knowing the limitations of the software we obtain a 60 % reduction in Fan consumption for the cycle. This number will be different when the controller will be tested on a better simulation platform.

The peak power of the flat control solution is 54 kW against 31 kW for the test result. Low consumptions are partly explained by the dominance of peaks in the solution, these peaks cannot be physically reproduced (limitations of the fan clutch approximately 30s to ramp up and down to selected speed).

CONCLUSION

In this paper a new approach for the control of the cooling system components was introduced. This approach is based in the flatness characteristics of a system. It was shown that flat outputs can be found for the linear SISO and MIMO systems presented. An implementation of said controllers is possible in a simulation environment. Even though results are not conclusive, just an early implementation phase has been presented, the evaluation of the concept remains of interest. This novel approach is based on the use of a simplified model of the system and the introduction of new control outputs completely decoupled. It was compared and outperformed the current control strategy that was developed experimentally in terms of energy gain.

From experience, in order to fully exploit the fan's power we then should use it when full flow is allowed to the radiator branch (coolant pump is at full flow and the thermostatic valve is fully open). Conclusions presented in this paper are issued from a solely fuel economy point of view. This is the most interesting aspect for the manufacturer since it is a marketing opportunity. However other objectives can be pursued such as comfort (noise reduction), improve drivability (derating strategies, reliability) and weight (cooling package size reduction mainly).

Due to an absence of heat rejection data, some assumptions have to be made regarding the simulation model (not all temperatures where known, not all flows are measured...) and presented gains will be different in case of a vehicle implementation.

It needs to be noted that improvements still can be made to introduce the energy management constraint into the flat controller, even if results are better for the linear approach, it needs to be noted that results from the dynamic programming algorithm are based on a much simpler model, which correlates with the test results, but nonetheless has shown differences when tested with a more complex model. The dynamics of the actuators haven't been introduced into the models. As a result, the control requests and the actual activation of the actuator are equal. This is not the case in a real vehicle. In figure 9, the fast activation of the bypass valve is not desirable in an actual system due to a possible water hammer.⁷

The current implementation is dependent on the availability of all the states, this is however not the case in any truck configuration, either an estimator needs to be design to rebuild the states or new sensors need to be installed.

Finally, a flatness controller for a nonlinear model has also been studied, but it is not to be presented in this paper. A method to define the flat outputs like the one used for linear systems does not exist.⁸

⁷ Reviewer 2 comment 8

⁸ Reviewer 1 comment 4

NOMENCLATURE

Indexes

<i>ac</i>	air compressor
<i>eng</i>	engine
<i>oc</i>	oil cooler
<i>oil</i>	oil circuit
<i>pf</i>	pump volume
<i>rad</i>	radiator

Prefixes

<i>d</i>	infinitesimal increase of the system
δ	emphasizes that is an inexact differential

Mechanics

<i>q</i>	coolant flow	[kg/s]
<i>q₁</i>	flow through radiator	[kg/s]
<i>q₂</i>	flow through Air compressor	[kg/s]
ω	Angular speed	[rad/s]
<i>C</i>	Heat Capacity	[J/(kg.K)]
<i>c</i>	Coolant specific heat	[J/(kg.K)]
\dot{Q}	Heat Flux	[J]
<i>T</i>	Temperature	[K]

ACKNOWLEDGMENTS

The author would like to acknowledge the support given by Volvo GTT Powertrain and Chassis and Vehicle dynamic staff that provided valuable information concerning the actuators and the systems architecture. This work is part of the author's Thesis funded by the French Government and Renault Trucks SAS through a CIFRE scholarship.

REFERENCES

- Al Tamimi, A., Salah, M., and Al-Jarrah PhD, A., "Neural Network-based Optimal Control for Advanced Vehicular Thermal Management Systems," SAE Technical Paper 2011-01-2184, 2011, doi:10.4271/2011-01-2184.
- Allen, D. and Lasecki, M., "Thermal Management Evolution and Controlled Coolant Flow," SAE Technical Paper 2001-01-1732, 2001, doi:10.4271/2001-01-1732.
- Bhat, N., Joshi, S., Shiozaki, K., Ogasawara, M. et al., "Adaptive Control of an Externally Controlled Engine Cooling Fan- Drive," SAE Technical Paper 2006-01-1036, 2006, doi:10.4271/2006-01-1036.
- Chalgren, R. and Barron, L., "Development and Verification of a Heavy Duty 42/14V Electric Powertrain Cooling System," SAE Technical Paper 2003-01-3416, 2003, doi:10.4271/2003-01-3416.
- Chanfreau, M., Gessier, B., Farkh, A., and Geels, P., "The Need for an Electrical Water Valve in a Thermal Management Intelligent System (THEMISTM)," SAE Technical Paper 2003-01-0274, 2003, doi:10.4271/2003-01-0274.
- Choukroun, A. and Chanfreau, M., "Automatic Control of Electronic Actuators for an Optimized Engine Cooling Thermal Management," SAE Technical Paper 2001-01-1758, 2001, doi:10.4271/2001-01-1758.
- Cortona, E. and Onder, C., "Engine Thermal Management with Electric Cooling Pump," SAE Technical Paper 2000-01-0965, 2000, doi:10.4271/2000-01-0965.
- Fleiss, M. Levine, J, Martin, P. and Rouchon, P. "Flatness and defect of nonlinear systems: Introductory theory and examples". Int. J. Control, Vol 61, p1327-1361; 1995
- Gnielinski, V., 1976, "New equations for heat and mass transfer in turbulent pipe and channel flows," Int. Chem. Eng., 16, pp. 359-368.
- Hnatzuk, W.; Lasecki, M.; Bishop, J. & Goodell, J. "Parasitic Loss Reduction for 21st Century Trucks", SAE Technical Paper no. 2000-01-3423, 2000.
- Kluger, M. and Harris, J., "Fuel Economy Benefits of Electric and Hydraulic Off Engine Accessories," SAE Technical Paper 2007-01-0268, 2007, doi:10.4271/2007-01-0268.
- Lehner, C., Parker, G, Arici, O., and Johnson, J., "Design and Development of a Model Based Feedback Controlled Cooling System for Heavy Duty Diesel Truck Applications Using a Vehicle Engine Cooling System Simulation," SAE Technical Paper 2001-01-0336, 2001, doi:10.4271/2001-01-0336.
- Melzer, F., Hesse, U., Rocklage, G, and Schmitt, M., "Thermomanagement," SAE Technical Paper 1999-01-0238, 1999, doi:10.4271/1999-01-0238.
- Page, R., Bedogne, R., Steinmetz, T., and Bryant, A., "A "Mini-Hybrid" Transit Bus with Electrified Cooling System," SAE Technical Paper 2006-01-3475, 2006, doi:10.4271/2006-01-3475.
- Page, R., Hnatzuk, W., and Kozirowski, J., "Thermal Management for the 21st Century - Improved Thermal Control & Fuel Economy in an Army Medium Tactical Vehicle," SAE Technical Paper 2005-01-2068, 2005, doi:10.4271/2005-01-2068.
- Petukhov, B. S., Irvine, T. F., and Hartnett, J. P., 1970, Advances in Heat Transfer, Academic Press, New York.
- Redfield, J., Surampudi, B., Gustavo, R., Montemayor, A. et al., "Accessory Electrification in Class 8 Tractors," SAE Technical Paper 2006-01-0215, 2006, doi:10.4271/2006-01-0215.
- Salah, M., Mitchell, T., Wagner, J. and Dawson, D., "Nonlinear-Control Strategy for Advanced Vehicle Thermal-Management Systems", IEEE Transaction on Vehicular Technology, Vol. 57, no.1, 2008.

19. Salah, M., Mitchell, T., Wagner, J. and Dawson, D., "Multiple Cooling Loops in Advanced Vehicle Thermal Management Systems", IEEE/ASME Transactions on Mechatronics, June 2007.
20. Setlur, P., Wagner, J., Dawson, D., and Chen, J., "Nonlinear Controller for Automotive Thermal Management Systems", proceedings of the 2003 American Control Conference, Denver, Colorado, 2003.
21. Setlur, P., Wagner, J., Dawson, D., and Marotta, E., "An Advanced Engine Thermal Management System: Nonlinear Control and Test", IEEE/ASME Transactions on Mechatronics, VOL. 10 no.2, April 2005.
22. Sira-Ramirez, H. K. Agrawal, S. "Differentially Flat Systems." Control engineering series, 17. MARCEL DEKKER, INC, NEW YORK. BASEL, ISBN:0-8247-5470-0, p.467, (2004)
23. Wambsganss, M., "Thermal Management Concepts for Higher-Efficiency Heavy Vehicles," SAE Technical Paper 1999-01-2240, 1999, doi:10.4271/1999-01-2240.
24. Wang, C., Fu, W. and Chang, C. (1997), "Heat Transfer and Friction characteristics of Typical wavy Fin-and-tube Heat exchangers, Exp. Thermal Fluid Sci., Vol. 14 (2), pp. 174-186.
25. G thler, D., Traub, M. and W nsche, M., "Cooling system for diesel engine of lorry, has controller designed to determine operating parameter from group of operating parameters under consideration of measurement parameter, so as to lead to minimum fuel consumption of engine", Patent Number: DE102008014518A Company: DAIMLER AG, Filling date: 2009.
26. Reckels, D., Paun, C. and Duraiswamy, S. "Predictive auxiliary load management (PALM) control apparatus and method". Patent Number: US7424868 B2, Company: Daimler Trucks North America Llc, filling date: 15/05/2007.
27. Elbert, P., Ebbesen, S. and Guzzella, L., IEEE Transactions on Control Systems Technology, DOI: 10.1109/TCST.2012.219035.

ANNEX A: FLAT OUTPUT AND INPUT DEFINITION FOR SISO SYSTEM

A brief demonstration of the method to determine the flat output for a SISO system is given in the following paragraphs.

Let's define the following SISO system:

$$\dot{x} = Ax + Bu \quad (D.1)$$

Where \dot{x} are the system dynamics, x are the states, u are the control inputs. We introduce a coordinate change so that:

$$z = Tx \quad (D.2)$$

Where T is the inverse of the controllability matrix as such:

$$T = [B, AB, A^2B, \dots, A^{n-1}B]^{-1} \quad (D.3)$$

Where n is the system dimension. The system is then equivalent to:

$$\dot{z} = \Lambda z + Yu \quad (D.4)$$

Given:

$$\Lambda = TAT^{-1} \quad Y = TB \quad (D.5)$$

With:

$$\Lambda = \begin{bmatrix} 0 & 0 & 0 & \dots & -\alpha_0 \\ 1 & 0 & 0 & \dots & -\alpha_1 \\ 0 & 1 & 0 & \dots & -\alpha_2 \\ \vdots & \vdots & \vdots & \ddots & \vdots \\ 0 & 0 & 0 & \dots & -\alpha_{n-1} \end{bmatrix} \quad Y = \begin{bmatrix} 1 \\ 0 \\ 0 \\ \vdots \\ 0 \end{bmatrix} \quad (D.6)$$

We can deduce that the state variable $\zeta = z_n$ describes all of the state variables in the new coordinate system, the input and the original system.

As a property widely used for the flatness approach:

$$\begin{aligned} z_{n-1} &= \dot{\zeta} + \alpha_{n-1}\zeta \\ z_{n-1} &= \ddot{\zeta} + \alpha_{n-1}\dot{\zeta} + \alpha_{n-2}\zeta \\ &\vdots \\ z_1 &= \zeta^{(n-1)} + \alpha_{n-1}\zeta^{(n-2)} + \dots + \alpha_1\dot{\zeta} \\ u &= \zeta^{(n)} + \alpha_{n-1}\zeta^{(n-1)} + \dots + \alpha_0\zeta \end{aligned} \quad (D.7)$$

We can then describe all the state variables using $\zeta = z_n$. ζ is then a flat output of the system. In this case the determination of the flat output just requires solving the following:

$$\zeta = [0 \ 0 \ 0 \ \dots \ 1] [B \ AB \ A^2B \ \dots \ A^{n-1}B]^{-1} x \quad (D.8)$$

In The SISO development we discussed:

$$\zeta = G_1 \partial T_{eng} + G_2 \partial T_{AC} \quad (D.9)$$

With:

$$G_1 = \frac{c_{AC} c_{oc} c_{pf} c_{rad} c_{eng}^2}{c^4 q^o q_1^o (q^o - q_2^o - q_1^o) (c_{eng} q_2^o - c_{ac} (q^o - q_2^o)) (T_{amb}^o - T_{rad}^o)} \quad G_2 = - \frac{c_{rad} c_{oc} c_{pf} c_{eng} c_{AC}^2}{c^4 q^o q_1^o q_2^o (c_{eng} q_2^o - c_{AC} (q^o - q_2^o)) (T_{amb}^o - T_{rad}^o)} \quad (D.10)$$

The fan control can be rewritten using the inversion in equation (28)

$$u_1 = \zeta^{(5)} + \alpha_4 \zeta^{(4)} + \alpha_3 \zeta^{(3)} + \alpha_2 \ddot{\zeta} + \alpha_1 \dot{\zeta} + \alpha_0 \zeta \quad (D.11)$$

$$\dot{\zeta} = \frac{G_1}{c_{eng}} [c(q^o - q_2^o) \partial T_{oc} - c(q^o - q_2^o) \partial T_{eng}] + \frac{G_2}{c_{AC}} [c q_2^o \partial T_{oc} - c q_2^o \partial T_{AC}]$$

$$\dot{\zeta} = c \left[(q^o - q_2^o) \frac{G_1}{c_{eng}} + q_2^o \frac{G_2}{c_{AC}} \right] \partial T_{oc} - c (q^o - q_2^o) \frac{G_1}{c_{eng}} \partial T_{eng} - c q_2^o \frac{G_2}{c_{AC}} \partial T_{AC}$$

If we define:

$$H_1 = c \left[(q^o - q_2^o) \frac{G_1}{c_{eng}} + q_2^o \frac{G_2}{c_{AC}} \right] \quad H_2 = -c(q^o - q_2^o) \frac{G_1}{c_{eng}} \quad H_3 = -cq_2^o \frac{G_2}{c_{AC}}$$

Then the first derivative can be written as

$$\dot{\zeta} = H_1 \partial T_{oc} + H_2 \partial T_{eng} + H_3 \partial T_{AC} \quad (D.12)$$

Subsequent derivatives can be written as:

$$\zeta^{(i)} = L_1 \partial T_{pf} + L_2 \partial T_{oc} + L_3 \partial T_{eng} + L_4 \partial T_{rad} + L_5 \partial T_{AC} \quad (D.16)$$

Where L_i are functions of c , q_0, q_1, q_2 and C_i .

The input is calculated using the previous derivatives and evaluating them in equation (D.11).

A similar approach has been done for the MIMO system.