



HAL
open science

Driftsondes: Providing In Situ Long-Duration Dropsonde Observations over Remote Regions

Cohn Stephen A., Hock Terry, Cocquerez Philippe, Wang Junhong, Rabier
Florence, Parsons David, Harr Patrick, Wu Chun-Chieh, Philippe Drobinski,
Fatima Karbou, et al.

► **To cite this version:**

Cohn Stephen A., Hock Terry, Cocquerez Philippe, Wang Junhong, Rabier Florence, et al.. Driftsondes: Providing In Situ Long-Duration Dropsonde Observations over Remote Regions. Bulletin of the American Meteorological Society, 2013, 94 (11), pp.1661-1674. 10.1175/BAMS-D-12-00075.1 . hal-01153825

HAL Id: hal-01153825

<https://hal.science/hal-01153825v1>

Submitted on 15 Apr 2022

HAL is a multi-disciplinary open access archive for the deposit and dissemination of scientific research documents, whether they are published or not. The documents may come from teaching and research institutions in France or abroad, or from public or private research centers.

L'archive ouverte pluridisciplinaire **HAL**, est destinée au dépôt et à la diffusion de documents scientifiques de niveau recherche, publiés ou non, émanant des établissements d'enseignement et de recherche français ou étrangers, des laboratoires publics ou privés.



Distributed under a Creative Commons Attribution 4.0 International License

DRIFTSONDES

Providing In Situ Long-Duration Dropsonde Observations over Remote Regions

BY STEPHEN A. COHN, TERRY HOCK, PHILIPPE COCQUEREZ, JUNHONG WANG, FLORENCE RABIER, DAVID PARSONS, PATRICK HARR, CHUN-CHIEH WU, PHILIPPE DROBINSKI, FATIMA KARBOU, STÉPHANIE VÉNEL, ANDRÉ VARGAS, NADIA FOURRIÉ, NATHALIE SAINT-RAMOND, VINCENT GUIDARD, ALEXIS DOERENBECHER, HUANG-HSIUNG HSU, PO-HSIUNG LIN, MING-DAH CHOU, JEAN-LUC REDELSPERGER, CHARLIE MARTIN, JACK FOX, NICK POTTS, KATHRYN YOUNG, AND HAL COLE

A field-tested, balloon-borne dropsonde platform fills an important gap in in-situ research measurement capabilities by delivering high-resolution, MIST dropsondes to remote locations from heights unobtainable by research aircraft.

High-quality in situ measurements from radiosondes and dropsondes are the gold standard for vertical profiles of fundamental atmospheric measurements such as wind, temperature (T), and relative humidity (RH). Satellite-borne remote sensors provide much-needed global, long-term coverage; however, they do not match the ability of sondes to capture sharp transitions and fine vertical structure, and have significant performance limitations (e.g., the inability of infrared sounders to penetrate clouds, poor accuracy in the boundary layer). Sondes are also a trusted means to calibrate and validate

remote sensors. However, it is challenging to launch radiosondes from remote locations such as the ocean surface or the interior of Antarctica. Aircraft release dropsondes above such locations but are limited by the range and endurance of the aircraft. The driftsonde system fills an important gap in our ability to use sondes to measure atmospheric profiles in remote locations. Although its creation was motivated by The Observing System Research and Predictability Experiment (THORPEX; e.g., Shapiro and Thorpe 2004) to optimize the global observing system, it has contributed to varied investigations ranging from

understanding the development of tropical cyclones to validating satellite retrievals in Antarctica.

The driftsonde is a unique balloonborne instrument that releases dropsondes to provide high-resolution in situ profiles of atmospheric temperature, humidity (H), pressure (P), and winds from the lower stratosphere down to the surface. It is ideal for applications over oceans and remote polar and continental regions, filling critical gaps in data coverage where the release of surface-based radiosondes is not possible. Figure 1 shows the driftsonde system concept in which a stratospheric

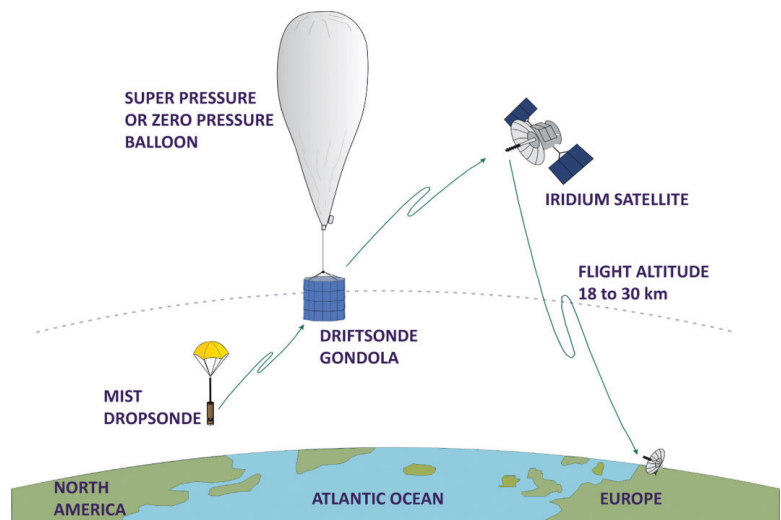

FIG. 1. The driftsonde system concept.

balloon carries the driftsonde gondola with a large number of Miniature In-situ Sounding Technology (MIST) dropsondes for days to months. The balloon drifts with the wind and sondes are released upon command. They parachute to the ground, providing high-vertical-resolution profiles. Data from each sonde are transmitted back to the gondola, and from there to the ground via an Iridium satellite link. Commands from the ground are also relayed to the gondola via satellite link. Data can be quality checked in near-real time and sent to the Global Telecommunications System (GTS), making it available for operational and research uses, such as numerical weather prediction (NWP) models, and to direct in-the-field experimental planning. The driftsonde concept of launching dropsondes from balloons was initially developed in the 1970s for the Global Atmospheric Research Program (GARP; e.g., Lally and Passi 1976). Although test flights were successfully completed, the instrument was not used for GARP. The concept was revived for THORPEX in a discussion at the National Center for Atmospheric Research (NCAR) between Melvin Shapiro, Vin Lally, Terry Hock, and Hal Cole, with subsequent simulations by Rolf Langland (Naval Postgraduate School) confirming its potential reach.

The driftsonde system consists of the flight train shown in Fig. 2, ground control software that is web based, and ground control servers and associated hardware located at NCAR in Boulder, Colorado. Web-based software adds flexibility, so that an experiment operations center can be located worldwide or it may rotate through several locations to support the continuous (24 hours a day, seven days a week) nature of balloon flight operations. The latest version of the gondola structure (Fig. 3), made of insulating foam, contains up to 54 MIST dropsondes, a custom electronics motherboard that acts as the brain of the system, lithium batteries to power the gondola for the expected flight duration, radio equipment to communicate with both a released dropsonde and Iridium satellites, and electric heaters to maintain the gondola electronics and batteries at an operational temperature. The heaters are powered by solar panels mounted outside the gondola. Heating the sonde electronics and batteries before they are released from the gondola ensures the sensors will operate normally. Early driftsonde tests were done with several ballooning partners.¹ Subsequent deployments have been a close collaboration between NCAR and the French Centre National d'Etudes Spatiales (CNES), with NCAR developing the driftsonde measurement capability (gondola, MIST sondes, communications, data quality, etc.) and CNES having responsibility for all ballooning development and flight operations.

Characteristics of the driftsonde's MIST dropsondes are shown in Table 1. They are physically smaller and lighter than current aircraft dropsondes but both use the Vaisala RSS921 sensor module, with the same pressure, temperature, and humidity sensors as the well-documented RS92-SGP radiosonde (Vaisala 2013). Each MIST dropsonde undergoes a calibration verification step at NCAR. While the MIST dropsondes make similar measurements to aircraft dropsondes, the two platforms—driftsonde gondola and aircraft—have notable differences. Capabilities of the stratospheric balloons used to lift driftsonde are central to its strengths and limitations. Aircraft are maneuverable but can remain aloft for only a few hours. They also can precisely target specific locations. The driftsonde is not maneuverable but can remain aloft for several months. Sondes

AFFILIATIONS: COHN, HOCK, WANG, MARTIN, FOX,* POTTS, YOUNG, AND COLE—National Center for Atmospheric Research,[†] Boulder, Colorado; COCQUEREZ, VÉNEL, AND VARGAS—Centre National d'Etudes Spatiales, Toulouse, France; RABIER, KARBOU, FOURRIÉ, SAINT-RAMOND, GUIDARD, AND DOERENBECHER—CNRM-GAME, Météo-France and CNRS, Toulouse, France; PARSONS—University of Oklahoma, Norman, Oklahoma; HARR—Naval Postgraduate School, Monterey, California; WU AND LIN—National Taiwan University, Taipei, Taiwan; DROBINSKI—Ecole Polytechnique/CNRS, Palaiseau, France; HSU—Research Center for Environmental Change, Academia Sinica, Taipei, Taiwan; CHOU—National Central University, Chung-Li, Taiwan; REDELSPERGER—Laboratoire de Physique des Océans, CNRS, IFREMER, IRD, UBO, Plouzané, France

***CURRENT AFFILIATION:** Advanced Radar Corporation, Boulder, Colorado.

[†]The National Center for Atmospheric Research is sponsored by the National Science Foundation.

CORRESPONDING AUTHOR: Stephen A. Cohn, National Center for Atmospheric Research, P.O. Box 3000, Boulder, CO 80307-3000
E-mail: cohn@ucar.edu

The abstract for this article can be found in this issue, following the table of contents.

DOI:10.1175/BAMS-D-12-00075.1

In final form 20 February 2013
©2013 American Meteorological Society

¹ Before and between field projects, we received assistance with ballooning tests from Terry Deshler and the University of Wyoming; Tim Lachenmeier and Near Space Corporation, Inc.; and the National Aeronautics and Space Administration (NASA) Columbia Scientific Balloon Facility.

are released from much higher altitudes than most aircraft (Fig. 4), and multiple driftsondes can be in flight simultaneously. In the just completed Concordiasi experiment, a constellation of 13 driftsondes were aloft simultaneously for about two months, with drops controlled from the ground in McMurdo Station, Antarctica; Toulouse, France; and Boulder, Colorado. In general, because stratospheric balloons drift with the wind and have long duration, driftsonde data can provide synoptic-scale or finer observations with wide-ranging geographical coverage that would be difficult to obtain with research aircraft. On the other hand, precise targeting of drops is limited by the accuracy of balloon trajectory forecasts.

FIELD EXPERIMENTS AND SCIENCE APPLICATIONS. As the driftsonde system was developed (Fig. 5), it was deployed in three field experiments associated with THORPEX activities (Table 2). Each revealed and led to needed improvements, and from these experiments we also learned how to take better advantage of the system's strengths for varied science applications. Details of the driftsonde system performance and scientific applications in each experiment are presented in the following sections.

² AMMA, based on a French initiative, was organized by an international scientific group and is currently funded by a large number of agencies, especially from France, the United Kingdom, the United States, and Africa. It has been the beneficiary of a major financial contribution from the European Community's Sixth Framework Programme. Detailed information on scientific coordination and funding is available on the AMMA International website.

Driftsonde observations during the African Monsoon Multidisciplinary Analyses. The first field project experience with driftsonde was in the African Monsoon Multidisciplinary Analyses (AMMA; www.amma-international.org) project,² both as a rigorous field test and for its scientific value. AMMA was organized to advance understanding of the West African monsoon

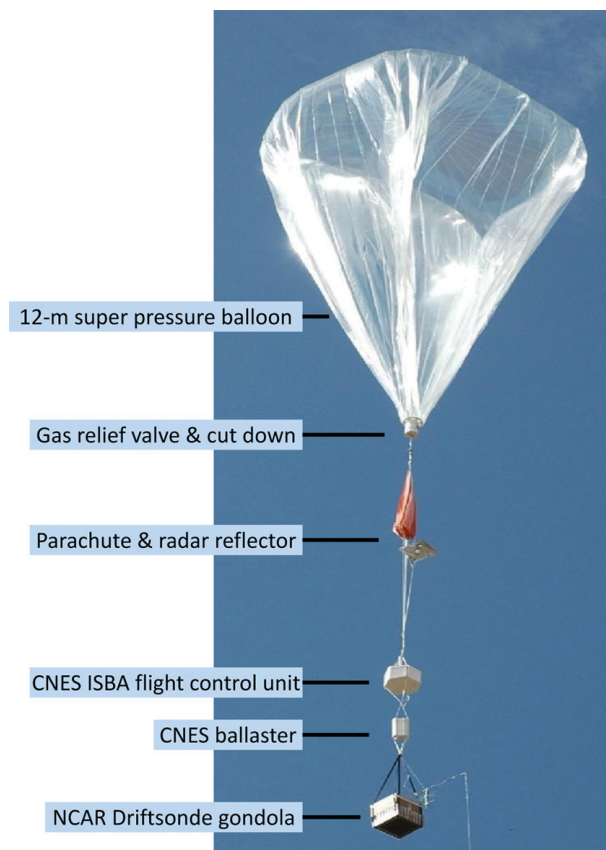

FIG. 2. AMMA driftsonde flight train.

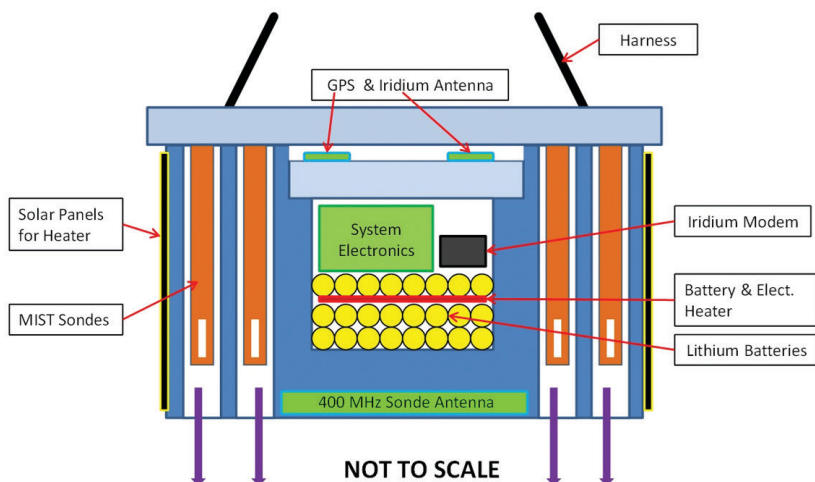

FIG. 3. Driftsonde gondola.



TABLE 1. MIST dropsonde characteristics.

MIST sonde	Weight: 175 g Length: 30.5 cm Diameter: 4.6 cm
Pressure, temperature, and dual-humidity sensors (used for T-PARC and Concordiasi, not AMMA)	Vaisala module RSS921 (same as in RS92 radiosonde) Sample rate: 0.5 s Resolution: P: 0.01 hPa, T: 0.01°, RH: 0.1%
Wind speed and direction	GPS Sample rate: 0.25 s Resolution: 0.01 m s ⁻¹ and 0.1°, respectively
Sonde fall speed	Approx 90 m s ⁻¹ at 30 km, 45 m s ⁻¹ at 20 km, and 10 m s ⁻¹ at sea level
Sonde fall time	Approx 19 min from 30 km, 16 min from 20 km

system and to improve predictions of its variability and the associated wide range of societal impacts. It is a major international program led by France but involves agencies and scientists located in the United Kingdom, Germany, the United States, and other countries across Africa and Europe. The driftsonde deployment supported AMMA's research focus on high-impact weather and was undertaken through a collaboration between AMMA and THORPEX. The program is summarized in Redelsperger et al. (2006), with the driftsonde-observing strategy described in Rabier et al. (2008).

The AMMA measurement strategy included long-term observations from 2002 through 2010

to investigate the interannual variability of the West African monsoon. Within this period was an extended observing period (EOP) from 2005 to 2007 to document the annual cycle, and four special observing periods (SOPs) during 2006 to provide specific observations of physical processes and weather systems. The driftsonde operations took place during the fourth SOP, covering the late monsoon period in August and September 2006.

The driftsonde deployment was considered a THORPEX observing system test (e.g., Shapiro and Thorpe 2004). Thus, a large component of driftsonde operations concentrated on engineering tests, including the first major test of NCAR's new smaller

and lighter dropsonde called MIST, which at 175 g was less than half the weight of the previous dropsondes and was developed specifically for use in the driftsonde. Miniaturization of the dropsonde was necessary for ballooning, where weight is more critical than for aircraft deployments. For AMMA, the driftsonde gondola held 49 MIST dropsondes. The AMMA deployment was the first scientific use of the new CNES 12-m superpressure balloons, the new NCAR gondolas, and the MIST dropsondes.

Eight driftsondes were launched from Zinder, Niger, and floated at about 20 km as they drifted eastward, reaching the Atlantic Ocean. The location was chosen to allow investigators to study both African easterly waves over central and western Africa and the potential intensification of

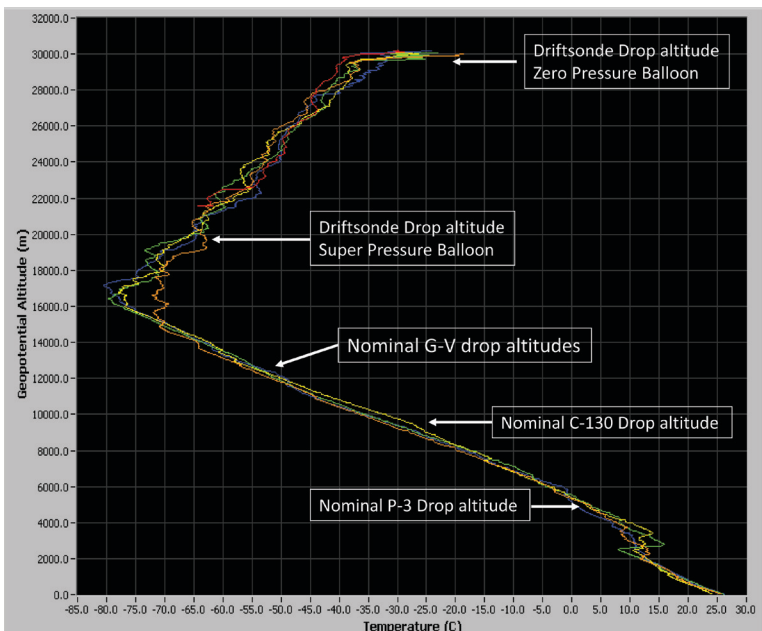

FIG. 4. Sample driftsonde temperature profiles, with the drop altitudes of driftsonde and the T-PARC aircraft.

these waves into tropical disturbances or even hurricanes over the subtropical Atlantic. Flight trajectories and the dropsonde locations are shown in Fig. 6. The dropsondes were able to sample both the Saharan air layer that is often advected over the tropical Atlantic and precursor environments, and the near-storm environments associated with 2006 Tropical Storm Florence and Hurricanes Gordon and Helen. The first balloon was launched on 28 August 2006, and the termination of the final balloon over the central subtropical Atlantic occurred on 22 September. Two balloons had mission durations in excess of eight days. Sondes were typically deployed near 0000 and 1200 UTC, as well as on demand for promising weather conditions. For further details on the driftsonde operations during

AMMA, a description of the challenges associated with balloon and dropsonde design, and preliminary scientific results, refer to the overview of the deployment presented in Drobinski et al. (2006, 2013a).



FIG. 5. Four images of driftsonde deployments. (a) Launch from McMurdo Station, Antarctica, during Concordiasi (2010). (b) Shortly after launch during Concordiasi. Dropsondes are visible at the perimeter of the driftsonde gondola below the CNES superpressure balloon. (c) Launch from Hawaii during T-PARC (2008). Driftsonde gondola is on its deployment sled. (d) Driftsonde before launch during AMMA (2006). This earlier version of the driftsonde gondola was constructed from cardboard rather than hard foam.

TABLE 2. Driftsonde evolution through three field projects.

AMMA, Aug–Sep 2006
• Launch site: Zinder, Niger
• Superpressure balloon: 8 flights, 3–18-day duration, 20-km float level
• 178 MIST sondes with <i>T</i> , RH, GPS winds; no pressure sensor
• Ground control through a terminal modem program with simple text commands and manual operation
T-PARC, Aug–Oct 2008
• Launch site: Hawaii (the Big Island)
• Zero-pressure balloon: 15 flights, 3–6-day duration, 30-km float level
• 254 MIST sondes with <i>P</i> , <i>T</i> , RH, GPS winds (equivalent to dropsonde sensor suite)
• Web-based ground control for drops and display position and sounding data
Concordiasi field experiment, Sep–Dec 2010
• Launch site: McMurdo Station, Antarctica
• Superpressure balloon: 13 flights, 50+-day duration, 18-km float level
• 644 MIST sondes with <i>P</i> , <i>T</i> , RH, GPS winds (equivalent to dropsonde sensor suite)
• Enhanced web-based ground control to schedule automatic drops and display position and sounding data

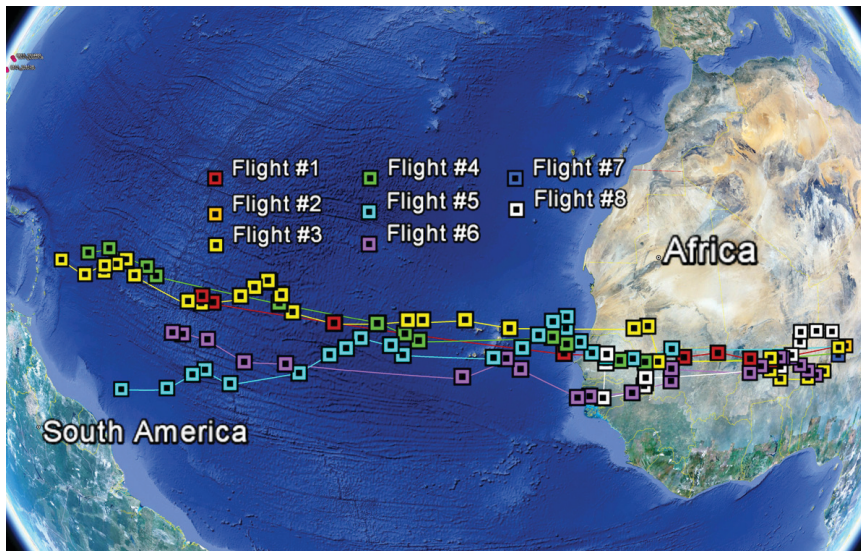

FIG. 6. Trajectories of the eight driftsondes launched from Zinder, Niger, located 640 km east of Niamey. Each square indicates the location of a dropsonde release.

Much was learned about the system's operation and performance as 124 sondes were successfully deployed from the eight driftsonde gondolas. While there was one premature failure of a stratospheric balloon and lessons learned about driftsonde launch procedures, most engineering challenges highlighted the need to improve aspects of the driftsonde gondola design and usability of system software. There were many cases where sondes failed to launch, as well as periods of lost communication between the ground control station and the gondola. Another significant conclusion was the need to redesign the MIST sonde to include a pressure sensor. A pressure sensor was not included in the AMMA version of the MIST sonde because of the incorrect assumption that the pressure for the dropsonde profile could be obtained from knowledge of the pressure and GPS altitude at launch and the hydrostatic equation. However, the flight-level pressure sensor on the gondolas did not have sufficient accuracy, so small errors in the initial pressure were magnified by the downward integration of the hydrostatic equation.

A success of AMMA was the demonstrated ability to target measurements with driftsondes launched 4–5 days before the sampling window. The successful sampling of storms was due to the accuracy of the upper-level winds predicted from operational NWP models, the quasi-nondivergent nature of the flow at 20 km, and the successful tropical storm genesis forecasts by the AMMA team through combining experimental and operation products for storm genesis.

dropsonde observations and the model analysis and prediction. The concept was to improve performance in key regions and different flow regimes using the special dropsonde observations to supplement the assessment procedure employed by the operational centers. This technique was extended to evaluate the impacts of recent upgrades in model physics and assimilation techniques.

The findings from Drobinski et al. (2013b) include that these models well represent the complex vertical structure of humidity associated with the Saharan air layer (Fig. 7a). However, the comparison identified temperature errors of several degrees Celsius in both modeling systems near the base of the Saharan air layer (Fig. 7b). The relatively large errors are likely because of the lack of dust and the associated radiative impacts within NWP models. This result suggests shortcomings in the assimilation system, perhaps due to the vertical resolution of the satellite data, and argues for the inclusion of aerosols and their radiative effects in NWP models. In this case, static stability errors in the vicinity of the Saharan dust could, in turn, impact the likelihood, intensity, and structure of convection. Considerable debate currently exists in determining and explaining the potential impacts of the Saharan air layer on tropical cyclones [e.g., see Braun (2010) and references therein]. It was also found that within the analyses, the zonal and meridional winds in the Saharan air layer cases have significant errors (Figs. 7c,d). The driftsonde observations were also valuable as “ground truth”

Despite technical challenges, AMMA demonstrated the scientific value of driftsonde, in particular to evaluate operational model performance and to identify specific areas for model improvement. Drobinski et al. (2013b) use driftsonde and other data to evaluate the performance of the European Centre for Medium-Range Weather Forecasts (ECMWF) Integrated Forecast System (IFS) and the two versions of the Météo-France Action de Recherche Petite Echelle Grande Echelle (ARPEGE) operational forecast system through comparison of the

in data impact and data assimilation experiments (Drobninski et al. 2013b).

Driftsonde observations during the THORPEX Pacific Asian Regional Campaign. The driftsonde experience in AMMA was a success both in identifying technical issues that needed attention after the campaign and collecting scientifically valuable observations. Prior to the next large field use in the THORPEX Pacific Asian Regional Campaign (T-PARC)³ in 2008, many parts of the system were upgraded. In particular, a pressure measurement was added to the MIST sonde, robustness of the satellite communication link was improved, and reliability of the sonde separation from the gondola when a drop is commanded was also improved.

As a multinational field campaign and research initiative, T-PARC addressed the shorter-range dynamics and forecast skill of one region (eastern Asian and the western North Pacific) and its downstream impact on the medium-range dynamics and forecast skill of another region (eastern North Pacific and North America). High-impact weather events over the regions examined in T-PARC have strong dynamical links downstream. For example, persistent deep tropical convection or the extratropical transition of tropical cyclones can trigger downstream responses over the eastern North Pacific, North America, and beyond via upper-tropospheric wave packets on the primary midlatitude waveguides (Anwender et al. 2008, Harr et al. 2008). Then, wave packets can be invigorated by subsequent downstream cyclogenesis events that are often associated with reduced predictability. High-impact weather events over North America driven by these processes can include intense extratropical cyclones, floods, severe weather, and hot, dry winds that increase the risk of wildfires and the severity of droughts. While T-PARC objectives encompassed mesoscale and synoptic-scale processes associated with tropical cyclones over the western North Pacific and eastern Asia, they also addressed medium-range forecast skill associated with downstream impacts across the North Pacific and beyond.

Droptsondes were an important contribution to T-PARC. In addition to use of driftsonde, four aircraft from three countries [United States: U.S. Air Force (USAF) WC-130J and Naval Research Laboratory (NRL) P-3, Taiwan: Dropwindsonde

³ T-PARC was supported financially by Germany, Canada, Japan, Australia, France, Korea, Taiwan, the United Kingdom, ECMWF, and the United States.

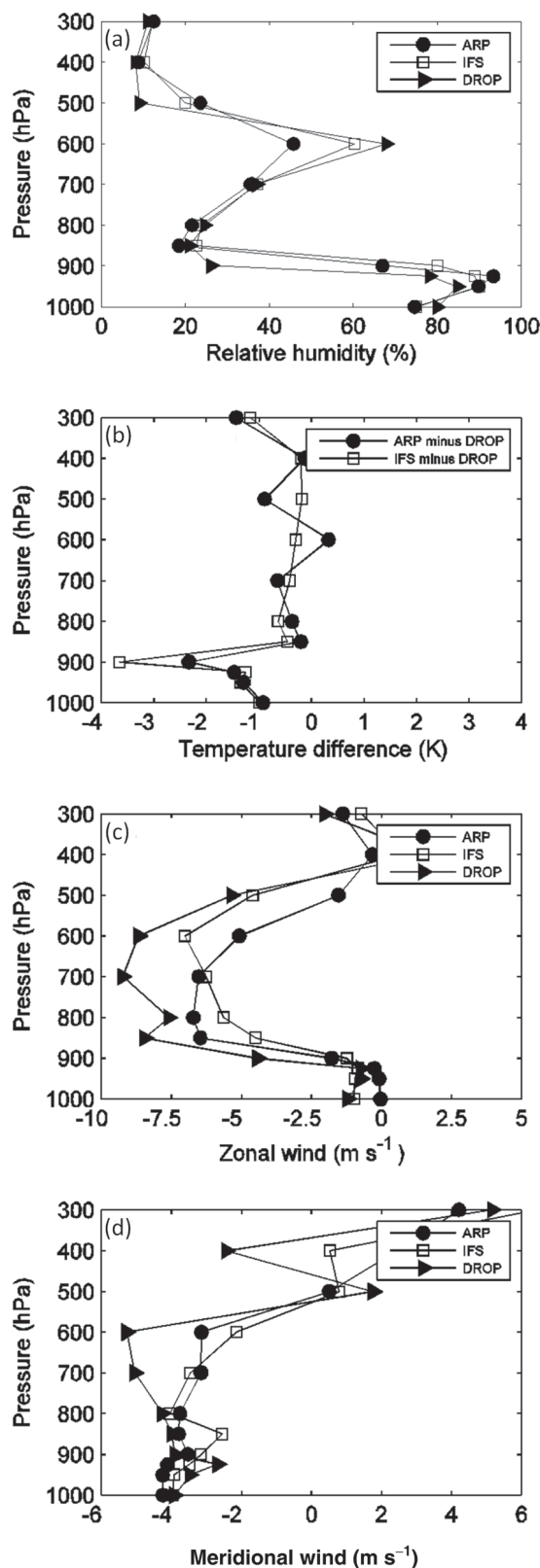

FIG. 7. Vertical profiles of (a) relative humidity, (b) temperature difference, (c) zonal wind, and (d) meridional wind from the ARPEGE (ARP) and ECMWF IFS model analyses collocated with droptsondes (DROP) within the Saharan air layer.

Observations for Typhoon Surveillance near the Taiwan Region (DOTSTAR) Astra (Wu et al. 2005, 2007b), and Germany: Deutsches Zentrum für Luft- und Raumfahrt (DLR) Falcon] were used to take special observations. The collaborative program required an experimental design that covered a very wide geographic range to address three primary components: 1) a tropical measurement strategy examined circulations of the tropical western North Pacific monsoon environment as they related to enhanced and reduced periods of widespread deep convection, tropical cyclone formation, tropical cyclone intensification, and tropical cyclone structure change; 2) a measurement strategy for the extratropical transition and its downstream impacts followed the poleward movement of a decaying tropical cyclone and the intense cyclogenesis that results from its interaction with the midlatitude circulation; and 3) a targeted observation strategy focused on regions in which extra observations may reduce numerical forecast error growth (Wu et al. 2007a, 2009; Harnisch and Weissmann 2010; Reynolds et al. 2010; Weissmann et al. 2011; Chou et al. 2011). In T-PARC, the targeted observations were aimed at reducing errors associated with tropical cyclone track forecasts, which included whether a tropical cyclone would recurve, the longitude of recurvature, and the orientation and speed along the track following recurvature.

To accomplish the primary objectives of T-PARC, a complete tropical-to-extratropical measurement strategy was necessary. For example, predictability associated with extratropical transition depends on the intensity and structure of the tropical cyclone,

where and when the tropical cyclone arrives in the midlatitude westerlies, the characteristics of the midlatitude waveguide that impact the extratropical-transition-related cyclogenesis, and the downstream propagation and evolution of the wave packets.

The motivation for deployment of driftsondes in T-PARC was to provide measurements over data-sparse regions of the tropical central Pacific. The data from the driftsonde complemented satellite observations and provided calibration and validation data for new satellite-based observations (Hawkins and Velden 2011) and global reanalysis products (Wang et al. 2010). During T-PARC, 16 driftsondes were launched from the southern end of the Big Island of Hawaii between 15 August and 30 September 2008. Thirteen of the driftsondes traveled at an altitude of about 30 km for up to five days to reach the western North Pacific and the primary T-PARC observation region (Fig. 8). Throughout T-PARC, 254 dropsondes were deployed from the driftsondes. The location and timing of the dropsonde deployments were coordinated from the T-PARC operations center at the Naval Postgraduate School in Monterey, California, taking advantage of the now web-based driftsonde control and display software. During each balloon flight, data were relayed to the T-PARC operations center, quality controlled, and transmitted to the GTS for use at operational weather centers.

As an example of driftsonde use during T-PARC, the fourth Driftsonde was launched on 24 August 2008 and on 29 August it reached a tropical disturbance that was being investigated by the T-PARC aircraft (Fig. 9). While the driftsonde was overflying the tropical disturbance in the lower stratosphere,

two aircraft were deploying dropsondes from their respective flight-level altitudes. Seven dropsondes were deployed from the driftsonde and provided measurements of two upper-tropospheric cyclonic systems that were preventing the development of the tropical disturbance.

Driftsondes in T-PARC were flown with zero-pressure balloons. These were designed to float much higher than the superpressure balloons used for AMMA (and later in Concordiasi), but they

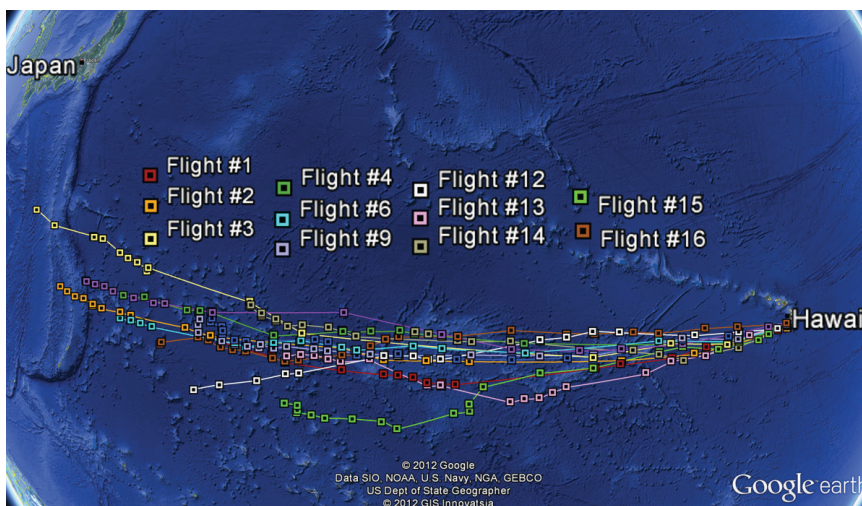

FIG. 8. Locations of dropsondes deployed from the 16 driftsonde balloons launched from the Big Island of Hawaii during T-PARC. Each square indicates the location of a dropsonde release.

also had a shorter flight lifetime. Because of light winds and a flaw in the ballooning technique, several flights failed to advect far enough westward to enter the most interesting measurement region. However, overall, data obtained from dropsondes released from the driftsondes provided valuable measurements of persistent deep convection, with special emphasis on the detailed vertical structure, impacts of vertical wind shear, and upper-level divergent outflow. Because of the driftsonde launch location and trajectories, data were instrumental in monitoring tropical cloud clusters that migrated over the data-sparse region of the tropical central Pacific until the clusters reached the region of T-PARC aircraft operations.

Driftsonde observations during the Concordiasi field experiment. The third major driftsonde deployment was in 2010 for the Concordiasi field experiment⁴ (Rabier et al. 2010, 2013), a multidisciplinary effort jointly conducted by several groups in France and the United States to study the lower stratosphere and troposphere above Antarctica. Concordiasi was one of the cluster of THORPEX projects associated with the International Polar Year (e.g., Renfrew et al. 2008; Hanesiak et al. 2010; Kristjánsson et al. 2011). The primary focus of Concordiasi was to validate the use of satellite observations and to document which observing systems are most relevant for numerical weather prediction over the polar areas. Concordiasi field experiments took place in austral springs 2008–10, including surface measurements and radiosoundings at the Concordia Antarctica station at Dome C, and radiosoundings at the Dumont d'Urville and Rothera sites on Antarctica. In 2010 driftsonde was part of an innovative constellation of balloons that provided a unique set of measurements spanning a large spatial extent (both horizontal and vertical) and time. The balloons drifted for several months in

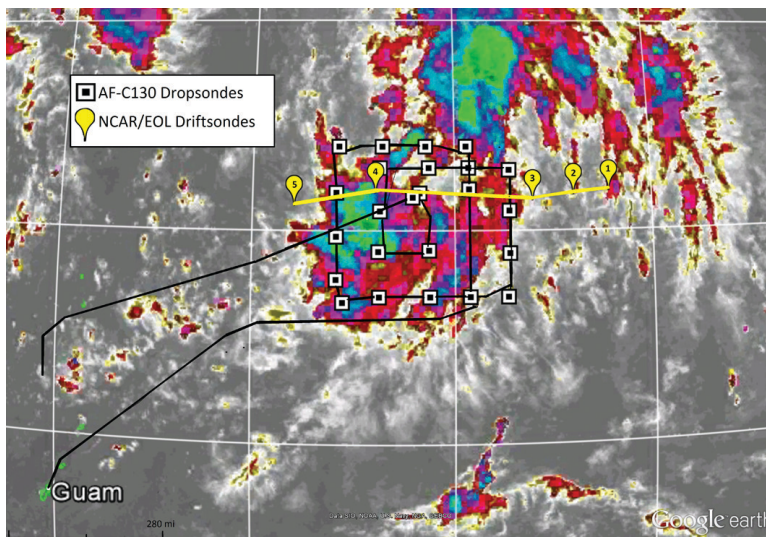

FIG. 9. Infrared satellite image of a tropical disturbance at 0500 UTC 29 Aug 2008 over which the driftsonde (yellow drift track, progressing east to west) was deploying dropsondes (yellow balloon symbols). USAF WC-130J (black flight track) also released dropsondes for this event (black/white squares). Driftsonde releases occurred between 0000 and 0900 UTC, while aircraft releases were between 0000 and 0500 UTC. NRL P-3 aircraft (not shown) also collected data in the environment surrounding this disturbance.

the lower stratosphere around 18 km, circling over Antarctica in the polar vortex. The balloon flotilla formed a regional observatory of the atmosphere. As in the earlier driftsonde experiments, hundreds of soundings were performed on command. The launch campaign took place from the U.S. McMurdo Station, located at 78°S latitude. Nineteen balloons were launched between 8 September and 26 October 2010. The mean flight duration was 69 days, while the longest flight lasted 95 days. Thirteen balloons carried a driftsonde, and six carried other instruments for Concordiasi. The long flight duration of the superpressure balloons used for Concordiasi, months rather than about a week for the previous driftsonde use, was critical to enable the project's science.

To prepare for Concordiasi, the driftsonde system was modified for the much longer duration flights and challenging range of thermal conditions it would encounter. Early in this high-latitude project, the gondolas were in total darkness, and later in the project they transitioned to full sunlight. The software was

⁴ Concordiasi was organized by an international scientific group and supported by the following agencies: Météo-France, CNES, the Institut Polaire Français (IPEV), the Progetto Nazionale Ricerche in Antartide (PNRA), CNRS's Institut national des sciences de l'Univers (INSU), the National Science Foundation (NSF), NCAR, the Concordia consortium, the University of Wyoming, Purdue University, and the University of Colorado. ECMWF also contributed to the project through computer resources and support, and scientific expertise. The two operational polar agencies—PNRA and IPEV—are thanked for their support at Concordia station.

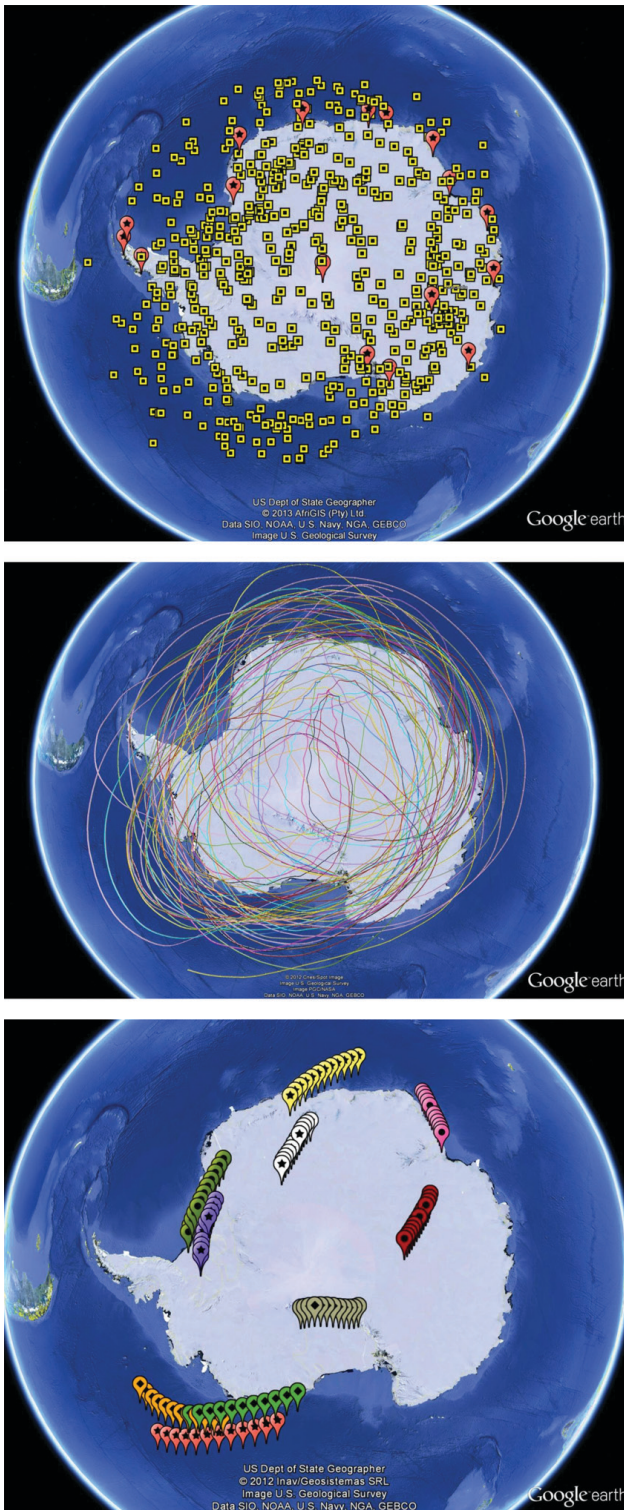

FIG. 10. (top) Locations of all 644 dropsondes (yellow squares) released over Antarctica during Concordiasi and radiosonde stations (red circles) on the Antarctic continent. (middle) Flight tracks of the 13 driftsondes for the duration of the project. (bottom) Tracks of the driftsondes constellation during a single 12-h period on 26 Nov 2010 showing the wide distribution of possible release points.

also enhanced to allow for drops at prescheduled times. Overall, the 13 driftsonde gondolas returned 644 high-quality profiles, with only 14 failed drops. This is a much higher success rate than in either AMMA or T-PARC, and resulted in an excellent spatial distribution of observations both over the Antarctic continent and the surrounding ocean. Figure 10 shows the comprehensive coverage and distribution of drop locations over the full experiment, as well as an example of the coverage of the constellation on a single day.

Many dropsondes were released to coincide with driftsonde overpasses of Concordia station, allowing for comparison of dropsonde and radiosonde profiles, and also to coincide with overpasses of the Meteorological Operation (MetOp) satellite, allowing comparison with data from the Infrared Atmospheric Sounding Interferometer (IASI). IASI is an advanced infrared sounder that has a large impact on NWP systems in general. However, there are some difficulties in its use over polar areas because the extremely cold polar environment makes it more difficult to extract temperature information from infrared spectra and makes it difficult to detect cloud properties. As a consequence, IASI is currently underutilized over Antarctica.

A number of important results have already come from the 2010 Concordiasi dataset, as described in the Concordiasi workshop report (Rabier et al. 2013). Wang et al. (2013) compare sonde profiles with satellite retrievals, using the National Oceanic and Atmospheric Administration (NOAA) Products Validation System (NPROVS) to match Concordiasi dropsonde and radiosonde profiles with profiles from several satellite products. A comparison of temperature profiles shows a cold bias present in all satellite data. The cold bias has a larger magnitude relative to the dropsonde data than the radiosonde for all satellite products except the Constellation Observing System for Meteorology, Ionosphere, and Climate (COSMIC; Fig. 11). The difference between the radiosonde and dropsonde bias can be traced to a larger cold bias over the Antarctic continent than over the coast and ocean, since all radiosonde stations but two are located along the coast (Fig. 10a). The source of this bias remains a topic of investigation. Aside from the bias, and an inability to resolve detailed thermodynamic structures near the surface and tropopause, the satellite retrievals reproduce the temperature profiles reasonably well.

In addition to temperature and humidity profiles, cloud properties such as cloud-top pressure and cloud effective emissivity (emissivity of an equivalent single-layer cloud) can be retrieved from IASI measurements. These retrievals are highly dependent on the quality of temperature and humidity profiles. As reported in Rabier et al. (2013), detection of cloud properties can be improved by using an accurate atmospheric profile provided by the Concordiasi dropsondes rather than the atmospheric model.

Another result from this dataset comes from the use of Concordiasi driftsonde observations in real time at NWP centers. As noted in Rabier et al. (2013), large systematic differences exist between various NWP analyses and forecasts for temperature over Antarctica, and for winds on the surrounding oceans. Comparison between short-range forecasts and the Concordiasi dropsonde data show that models poorly represent near-surface temperature over the Antarctic high terrain. The strong thermal inversions are challenging because numerical models need very good representations of both turbulent exchange processes and snow processes to simulate this extreme atmospheric behavior. The difference between the dropsonde and the model temperatures at the lowest model level is presented in Fig. 12 for the French global model. The

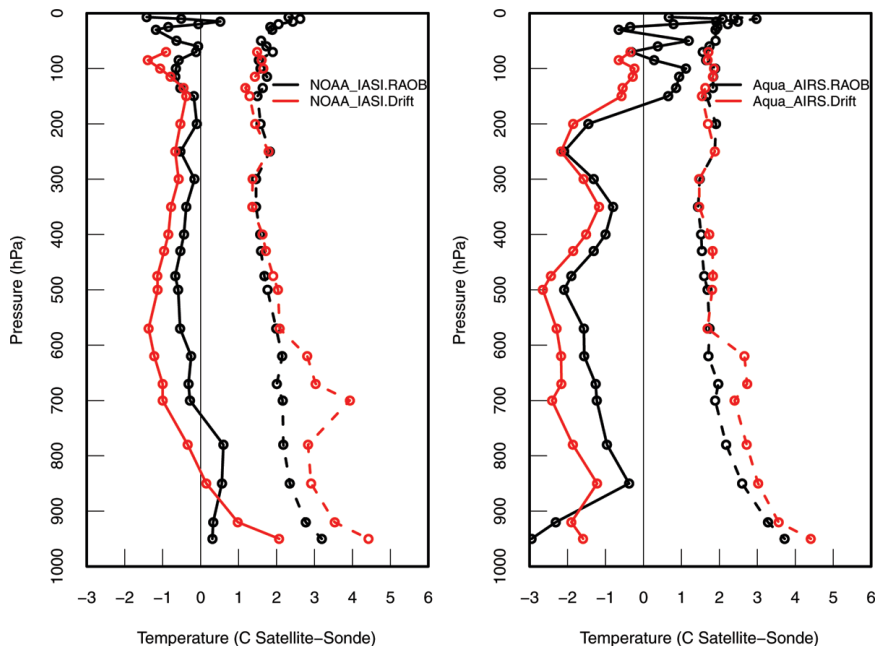

FIG. 11. Mean (solid line) and standard deviation (dashed line) of temperature differences between satellite and dropsonde (red line) and radiosonde (black line) data for (left) NOAA IASI instrument and (right) AIRS products.

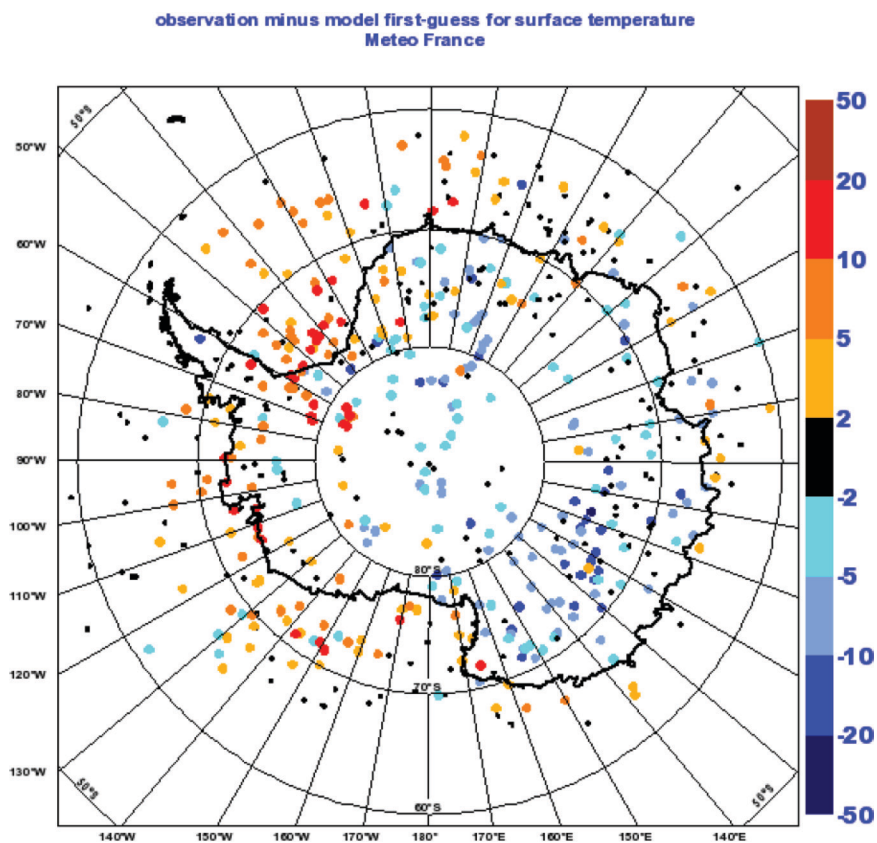

FIG. 12. Difference between the dropsonde and the model temperatures at the lowest model level for the French global model. Blue colors indicate that the dropsonde is colder than the model, and red colors indicate that it is warmer.

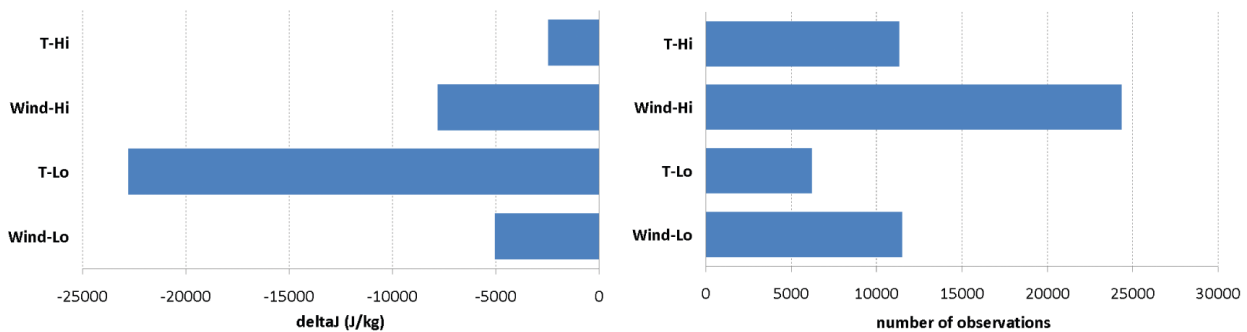

FIG. 13. (left) Total impact of dropsonde temperature and wind is illustrated at high levels (pressure less than 400 hPa) and low levels (pressure greater than 400 hPa) (right) together with the number of observations. Negative values of the impact indicate that the data contribute to reducing the error in the NWP system. For observations, each individual datum on each pressure level is counted; for winds, zonal and meridional components are counted separately. Impact has been measured using adjoint-based sensitivity of the 24-h forecast error with respect to observations. Forecast error has been defined using a dry total energy norm over the polar area (south of 60°S) and from the surface to the top of the model. Linear estimation has been computed using a second-order approximation.

model is too warm over the plateau in Antarctica, and it is too cold over the surrounding sea ice.

The impact of dropsondes on NWP models has also been studied with data denial experiments and advanced data impact diagnostics. Dropsondes have a positive impact on the forecast performance in different models, with an impact of the same order of magnitude as that of radiosondes. Rabier et al. (2013) report that the average error reduction per observation is much larger for dropsondes than for satellite data, and that dropsonde observations have a greater impact when they are closer to the pole. In Fig. 13, the impact of dropsonde temperature and wind profiles is illustrated at high levels (pressure less than 400 hPa) and low levels (pressure greater than 400 hPa), together with the number of observations. Overall, temperature information contributes most at low levels, and wind information contributes more at high levels. However, on a per-observation basis, both wind and temperature have larger impacts at low levels, where there are very few other observations.

These results from driftsonde data in Concordiasi provide insight into improvements to the global observing system that must be achieved to improve NWP over the polar areas. This is important not only to improve forecast performance but also for producing more accurate reanalyses of the atmosphere to document climate change.

CONCLUSIONS. Thanks to the driftsonde system, in situ measurements were obtained in parts of the world that are not accessible by any other means. This has provided invaluable information about model strengths and weaknesses, and about which

observations will be needed in the future to monitor the climate, especially in polar areas. The excellent technical success achieved during Concordiasi demonstrates that driftsonde is now a mature, reliable, and productive observing system. Its strengths include the ability to reach difficult parts of the globe; to collect highly accurate, in situ dropsonde profiles; to reliably release up to 54 dropsondes per system from the lower stratosphere; and to be deployed as a constellation with many driftsondes flying simultaneously.

Like aircraft dropsonde systems, field experiments using driftsondes involve significant cost and require much advance planning. It can take months to understand likely flight paths and obtain permissions to overfly many countries. If a balloon drifts near a region where overflight permissions have not been granted, then it must be cut down. The ability of the driftsonde to observe specific phenomena depends critically upon finding a suitable launch site relative to stratospheric wind patterns. For T-PARC, finding a subtropical Pacific island for which stratospheric wind patterns intersected the climatological tracks of tropical cyclones was surprisingly difficult. In contrast, finding a suitable launch site for AMMA within Africa was more straightforward. Once a launch site is selected, the success of the driftsonde to target a specific event depends on accurate forecasts of both the wind field in the stratosphere and the evolution and movement of the event to be targeted. Despite the ability of driftsondes to intercept tropical cyclones during AMMA and to a lesser extent during T-PARC, reliance upon forecasts with lead times of several days is a disadvantage relative to aircraft dropsonde

deployment. At far longer lead times, the driftsonde behavior from Concordiasi and experience from ballooning campaigns during GARP suggest that the balloons tend to be advected into the confluent, more dynamically active regions of the atmosphere. For many aspects of weather research, this behavior is desirable.

Despite these complexities, scientifically, the driftsondes are well suited to numerous applications, especially because of their ability to operate in otherwise data-sparse regions. In particular, they have unique value for verifying and evaluating NWP models, global reanalysis models, and data assimilation approaches. The measurements are also a valuable resource to validate remote sensors, especially on satellites but also airborne or ground-based remote sensors. Driftsondes also can support process studies in otherwise difficult locations. In AMMA and T-PARC, examples include the effects of the SAL and factors that control the development of a tropical disturbance. There is also a potential role for driftsonde operationally, although costs and forecast impacts of this have not been considered in detail. For example, a concept discussed in the early years of driftsonde was that a series of driftsondes could be released at regular intervals from sites in Asia to provide synoptic data over the Pacific Ocean, or from the East Coast of the United States for regular observations over the Atlantic Ocean. In addition to driftsonde flights, the Concordiasi program included measurements of ozone-related processes, microphysics of stratospheric clouds, and remote sensing using GPS occultation. It showed the potential of combining such diverse flight-level measurements with the vertical profiles from dropsondes to carry out a multidisciplinary experiment that would not be possible with aircraft.

The driftsonde system has been discussed as a possible contributor to future field studies. One is a long-duration stratospheric balloon campaign at the equator intended to study, among other goals, the dynamics of the equatorial middle atmosphere with a focus on the quasi-biennial oscillation, and transport, dehydration, and clouds in the tropical tropopause layer. A second field study suggested driftsondes as one of a synergistic set of tools to study the propagation and effects of orographically generated atmospheric gravity waves from near the surface to the upper atmosphere. Those with interest in using driftsondes in their research are encouraged to contact the lead authors.

ACKNOWLEDGMENTS. Development and field use of the driftsonde system is a joint effort of many people,

institutions, and nations. We thank all who made the development and deployments to AMMA, T-PARC, and Concordiasi successful. We are grateful to Rolf Langland, Mark Bradford, Joe VanAndel, Dean Lauritsen, Chip Owens, Clayton Arendt, and Mary Hanson for contributions to the development.

Melvyn Shapiro is especially acknowledged for his resurrection of the early ideas of the late Vin Lally, which were developed decades before their time. In many regards, this paper is a testament to Vin's creativity.

We are grateful for funding support from the National Science Foundation's Division of Atmospheric and Geospace Sciences and Office of Polar Programs (Grants ATM-0301213, ATM-9732665, ANT-0733007, ANT-1002057, and AGS-0736003), the National Oceanic and Atmospheric Administration (Grant NA17GP1376), the National Science Council of Taiwan (Grants NSC 96-2745-M-002-004, NSC 97-2111-M-002-005, and NSC 97-2111-M-002-016-MY3), the Taiwan Central Weather Bureau (Grant MOTC-CWB-97-6M-01), the Office of Naval Research (Grants N00173-08-1-G007 and N00014-09-WR20008), and the support of the national and international THORPEX project offices. NSF further supported these field projects through their support of the U.S. THORPEX project Office, and the Lower Atmospheric Observing Facilities.

REFERENCES

- Anwender, D., P. Harr, and S. Jones, 2008: Predictability associated with the extratropical transition of tropical cyclones: Case studies. *Mon. Wea. Rev.*, **136**, 3226–3247.
- Braun, S. A., 2010: Reevaluating the role of the Saharan air layer in Atlantic tropical cyclogenesis and evolution. *Mon. Wea. Rev.*, **138**, 2007–2037.
- Chou, K.-H., C.-C. Wu, P.-H. Lin, S. D. Aberson, M. Weissmann, F. Harnisch, and T. Nakazawa, 2011: The impact of dropwindsonde observations on typhoon track forecasts in DOTSTAR and T-PARC. *Mon. Wea. Rev.*, **139**, 1728–1743.
- Drobinski, P., and Coauthors, 2006: Des ballons stratospheriques traquent la mousson Africaine. *Meteorologie*, **55**, 2–3.
- , P. Cocquerez, A. Doerenbecher, T. Hock, C. Lavaysse, D. Parsons, and J. L. Redelsperger, and S. Véné, cited 2013a: Hurricane and monsoon tracking with driftsondes. *Encyclopedia of Sustainability Science and Technology*. [Available online at www.springerreference.com/docs/html/chapterdbid/310833.html.]
- , and Coauthors, 2013b: Driftsonde observations to evaluate numerical weather prediction of the late

- 2006 African monsoon. *J. Appl. Meteor. Climatol.*, **52**, 974–995.
- Hanesiak, J., and Coauthors, 2010: Storm Studies in the Arctic (STAR). *Bull. Amer. Meteor. Soc.*, **91**, 47–68.
- Harnisch, F., and M. Weissmann, 2010: Sensitivity of typhoon forecasts to different subsets of targeted dropsonde observations. *Mon. Wea. Rev.*, **138**, 2664–2680.
- Harr, P. A., D. Anwender, and S. C. Jones, 2008: Predictability associated with the downstream impacts of the extratropical transition (ET) of tropical cyclones: Methodology and a case study of Typhoon Nabi (2005). *Mon. Wea. Rev.*, **136**, 3205–3225.
- Hawkins, J., and C. Velden, 2011: Supporting meteorological field experiment missions and postmission analysis with satellite digital data and products. *Bull. Amer. Meteor. Soc.*, **92**, 1009–1022.
- Kristjánsson, J. E., and Coauthors, 2011: The Norwegian IPY–THORPEX: Polar lows and Arctic fronts during the 2008 Andøya Campaign. *Bull. Amer. Meteor. Soc.*, **92**, 1443–1466.
- Lally, V. E., and R. M. Passi, 1976: Height determination from the carrier balloon dropsonde. *J. Appl. Meteor.*, **15**, 337–345.
- Rabier, F., and Coauthors, 2008: An update on THORPEX-related research in data assimilation and observing strategies. *Nonlinear Processes Geophys.*, **15**, 81–94.
- , and Coauthors, 2010: The Concordiasi project in Antarctica. *Bull. Amer. Meteor. Soc.*, **91**, 69–86.
- , and Coauthors, 2013: The Concordiasi field experiment over Antarctica: First results from innovative atmospheric measurements. *Bull. Amer. Meteor. Soc.*, **94**, ES17–ES20.
- Redelsperger, J. L., C. D. Thorncroft, A. Diedhiou, T. Lebel, D. J. Parker, and J. Polcher, 2006: African Monsoon Multidisciplinary Analysis: An international research project and field campaign. *Bull. Amer. Meteor. Soc.*, **87**, 1739–1746.
- Renfrew, I. A., and Coauthors, 2008: The Greenland Flow Distortion Experiment. *Bull. Amer. Meteor. Soc.*, **89**, 1307–1324.
- Reynolds, C. A., J. D. Doyle, R. M. Hodur, and H. Jin, 2010: Naval Research Laboratory multiscale targeting guidance for T-PARC and TCS-08. *Wea. Forecasting*, **25**, 526–544.
- Shapiro, M. A., and A. J. Thorpe, 2004: The Observing System Research and Predictability Experiment (THORPEX): International science plan, version 3. WMO/TD-1246, WWRP/THORPEX 2, 51 pp.
- Vaisala, cited 2013: Vaisala radiosonde RS92-D data sheet. [Available online at www.vaisala.com/Vaisala%20Documents/Brochures%20and%20Datasheets/RS92-D-Datasheet-B210763EN-B-LoRes.pdf.]
- Wang, J., and Coauthors, 2010: Water vapor variability and comparisons in subtropical Pacific from The Observing System Research and Predictability Experiment-Pacific Asian Regional Campaign (T-PARC) driftsonde, Constellation Observing System for Meteorology, Ionosphere, and Climate (COSMIC), and reanalyses. *J. Geophys. Res.*, **115**, D21108, doi:10.1029/2010JD014494.
- , T. Hock, S. A. Cohn, C. Martin, N. Potts, T. Reale, B. Sun, and F. Tilley, 2013: Unprecedented upper-air dropsonde observations over Antarctica from the 2010 Concordiasi experiment: Validation of satellite-retrieved temperature profiles. *Geophys. Res. Lett.*, **40**, 1231–1236, doi:10.1002/grl.50246.
- Weissmann, M., and Coauthors, 2011: The influence of assimilating dropsonde data on typhoon track and mid-latitude forecasts. *Mon. Wea. Rev.*, **139**, 908–920.
- Wu, C.-C., and Coauthors, 2005: Dropwindsonde Observations for Typhoon Surveillance near the Taiwan Region (DOTSTAR): An overview. *Bull. Amer. Meteor. Soc.*, **86**, 787–790.
- , J.-H. Chen, P.-H. Lin, and K.-S. Chou, 2007a: Targeted observations of tropical cyclones based on the adjoint-derived sensitivity steering vector. *J. Atmos. Sci.*, **64**, 2611–2626.
- , K.-H. Chou, P.-H. Lin, S. D. Aberson, M. S. Peng, and T. Nakazawa, 2007b: The impact of dropwindsonde data on typhoon track forecasts in DOTSTAR. *Wea. Forecasting*, **22**, 1157–1176.
- , and Coauthors, 2009: Intercomparison of targeted observation guidance for tropical cyclones in the northwestern Pacific. *Mon. Wea. Rev.*, **137**, 2471–2492.