



HAL
open science

Sensitivity Analysis of the New Sizing Tool “PISTACHE” for Solar Heating, Cooling and Domestic Hot Water Systems

Hamza Semmari, Olivier Marc Marc, Jean-Philippe Praene, Amandine Le
Denn, François Boudéhenn, Franck Lucas

► To cite this version:

Hamza Semmari, Olivier Marc Marc, Jean-Philippe Praene, Amandine Le Denn, François Boudéhenn, et al.. Sensitivity Analysis of the New Sizing Tool “PISTACHE” for Solar Heating, Cooling and Domestic Hot Water Systems. Energy Procedia, 2014, 2nd International Conference on Solar Heating and Cooling for Buildings and Industry (SHC) Sept 2013 Freiburg, 48, pp.997-1006. 10.1016/j.egypro.2014.02.114 . hal-01153024

HAL Id: hal-01153024

<https://hal.science/hal-01153024>

Submitted on 21 Jun 2018

HAL is a multi-disciplinary open access archive for the deposit and dissemination of scientific research documents, whether they are published or not. The documents may come from teaching and research institutions in France or abroad, or from public or private research centers.

L'archive ouverte pluridisciplinaire **HAL**, est destinée au dépôt et à la diffusion de documents scientifiques de niveau recherche, publiés ou non, émanant des établissements d'enseignement et de recherche français ou étrangers, des laboratoires publics ou privés.



SHC 2013, International Conference on Solar Heating and Cooling for Buildings and Industry
September 23-25, 2013, Freiburg, Germany

Sensitivity analysis of the new sizing tool “PISTACHE” for solar heating, cooling and domestic hot water systems

Hamza Semmari*^a, Olivier Marc^a, Jean-Philippe Praene^a, Amandine Le Denn^b, François Boudéhenn^c, Franck Lucas^a

^a PIMENT, University of la Reunion, 40 Av.de SOWETO, 97410, Saint Pierre, France

^b TECSOL, 105 Av. Alfred Kastler, 66000 Perpignan, France

^c CEA LITEN INES, 50 Av. Du lac Léman, 73377Le Bourget du Lac, France

Abstract

The present paper studies the sensitivity analysis of the new PISTACHE tool's prediction performance and its input parameters. This work is a part of the R&D project MeGaPICS (Method towards Guarantee of Solar Cooling and Heating application – funded by the French National Research Agency). In fact, the PISTACHE tool was developed to provide professionals with a practical tool to design and to estimate the performances of different solar heating and cooling systems. After a short description of the PISTACHE tool, its validation is performed followed by a sensitivity analysis which is conducted using the method of Fourier Amplitude Sensitivity Test (FAST). The obtained results will be displayed and discussed at the end of this paper.

© 2014 The Authors. Published by Elsevier Ltd.

Selection and peer review by the scientific conference committee of SHC 2013 under responsibility of PSE AG

Keywords: solar cooling; guarantee; performance; sensitivity analysis.

1. Introduction

These last years, the electricity consumption is continually increasing in Reunion Island, especially during the summer's months [1]; this consumption is mainly due to the use of conventional air conditioning systems. To reduce

* Corresponding author. Tel.: +262-692-780217.

E-mail address: hamza.semmari@gmail.com

this rate of electrical consumption, solar cooling system presents a good alternative [2]. This kind of solar cooling system allows both to synchronize cooling needs with the solar availability, and to harness an environmentally friendly free inexhaustible energy resource [3]. Moreover, the cooling system (absorption or adsorption chiller) uses environmentally friendly solutions (water/lithium bromide or ammonia/water) as working fluids.

The presented work is a part of the MEGAPICS project, which targets at providing to professionals (designers, planners,...) a simplified new sizing tool, so-called **PISTACHE**, allowing both designing and performance's prediction of Solar Heating Cooling and Domestic Hot Water production (SHC&DHW) systems. This work consists, first, to validate the annual energy balance of PISTACHE tool versus RAFSOL real experimental data [1]. Next, a sensitivity analysis is carried out in order to check the sensitivity of the different performance indicators estimated with the new PISTACHE tool towards the input parameters.

This paper presents, first, the studied configuration in the PISTACHE tool followed by a short description of the selected method for the sensitivity analysis. Finally, the obtained results will be discussed leading to several perspectives expected for the future work.

Nomenclature

COP_{th}	Thermal performance's coefficient of the absorption chiller
η_{CS}	Cold and hot storage efficiency
η_{HS}	Cold and hot storage efficiency
PER	Primary energy ratio
PSU	Useful solar thermal productivity

2. Description of PISTACHE configuration

The PISTACHE tool aims to carried out easy and quick calculation of solar installation for cooling, heating and domestic hot water production. It helps the user to pre-size the installation, to provide energy balances and annual performance indicators [4].

The PISTACHE tool uses an hourly calculation process inducing to monthly and annual energy balances from which annual performance indicators are estimated [4]. Among these performance indicators, three different categories can be notified as follow [5]:

- Thermal efficiency indicators: η_{CS} , η_{HS} and COP_{th}
- Global performance indicator: PER
- Solar performance indicators: PSU

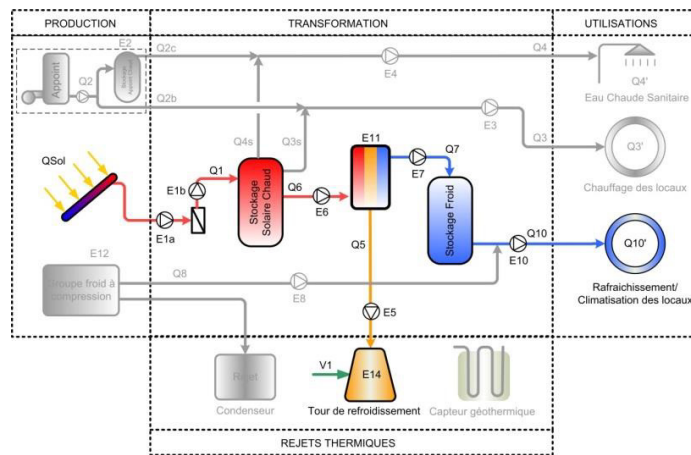

Fig. 1. PISTACHE cooling mode configuration (RAFSOL)

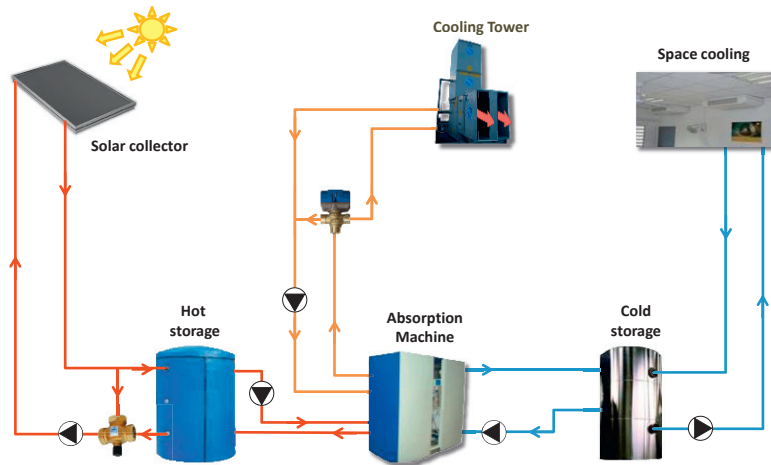

Fig. 2. RAFSOL solar cooling installation

As described in [4] and [6], the PISTACHE tool is mainly composed of a user interface to upload an input file, to fill the parameter and to choose the main component characteristics. Also, it includes the calculation tables, the material databases and a step by step help file.

For this paper, the sensitivity analysis will be implemented only for a PISTACHE cooling mode configuration (Fig. 1), which corresponds by the way to the RAFSOL installation (Fig. 2), using both “PISTACHE format” meteorological and load input file. The user interface designs RAFSOL cooling mode as shown in Fig. 1.

3. PISTACHE model results and validation

A comparative study, between the *annual* energy balance of PISTACHE tool and experimental RAFSOL data, is carried out for the validation of the new sizing tool PISTACHE. This comparative study is restricted only to the energy balances of solar energy supplied to the hot storage (Q1), thermal heat energy supplied to sorption machine (Q6) and thermal cooling energy supplied by the evaporator (Q7).

The Fig. 3.a presents the comparison between PISTACHE results and first season’s RAFSOL data which notify, by the way, important differences between the estimated and the measured annual energy balances for the considered energies (Q1, Q6 and Q7).

To reduce this difference, an identification study has been applied on the following inputs parameters of PISTACHE tool as mentioned in Table.1. The same table resumes also the obtained values of the different parameters after the identification. After that, a new simulation has been launched using now the values of the inputs parameters defined by the identification study. Obtained results are directly compared to the same first season’s RAFSOL data as presented in Fig. 3.b.

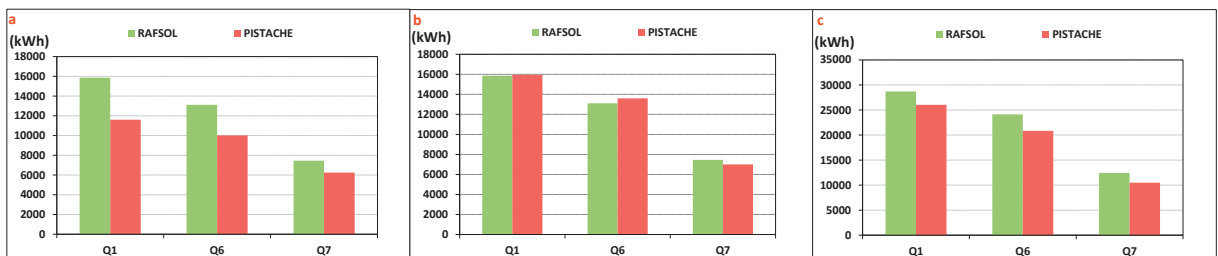

Fig. 3. (a) RAFSOL Vs PISATCHE; (b) RAFSOL Vs PISATCHE identification; (c) RAFSOL Vs PISATCHE validation.

Table 1 Values of the parameters after the identification

Parameters	Initial values	Identified values
T _{amb}	20	28
T _{cool}	17	6
T _{G_MIN}	76	65
T _{HS_MAX}	105	115
a _{CRHS}	3.3	1.47
b _{CRHS}	-0.45	-0.24
a _{CRCS}	3.3	0.84
b _{CRCS}	-0.45	-0.19

We observe from Fig. 3.b that the relative errors between PISTACHE results and RAFSOL experimental data has been strongly reduced respectively from 26.8% to 0.6% for Q1, from 23.5% to 3.7% for Q6 and finally from 16.2% to 6.2 % for Q7. To validate the PISTACHE tool, another simulation has been launched using both the values of the inputs parameters defined by the identification study and the second season's RAFSOL data.

According to last comprising results as shown in Fig.3.c, it can be seen that the PISTACHE model results stay to be credible versus to the real experimental RAFSOL data inducing, thus, to the validation of the PISTACHE tool behavior for a cooling mode configuration corresponding to the RAFSOL installation. However, we observe that relative errors are relatively higher, 9.2% for Q1, 13.6% for Q6 and 15.8% for Q7, because of the operating mode of RAFSOL installation for the second season which was a little different comparing to the operating mode of the first season. In fact, the first season was characterized by an only standard operating mode while several operating scenarios have been accomplished for research purposes during the second season (partial use of solar field, variation of flow rate in the different loops, testing different operational settings, ...).

4. Sensitivity analysis

As defined by Saltelli [7], the purpose of the sensitivity analysis (SA) applied to a given model is to investigate how this model (numerical or otherwise) depends on its input factors. In the present work, the sensitivity analysis method employed is the FAST method (Fourier Amplitude Sensitivity Test) that will allow to show up the influence of the different input factors on the performance of such solar absorption chiller system.

Initially, the FAST method has been proposed by Curkier [8]. This method consists, first, to associate for each input factors (X_i) a proper frequency (ω_i) that should take a prime value (3,5,7...) in order to avoid interferences; and then to vary the input parameters undependably from each other's according to a periodic function defined as follow [9]:

$$X_{i,k} = G_i(\sin(\omega_i \cdot S_k)) \quad \text{with} \quad S_k = \frac{2\pi k}{N} \quad (1)$$

Where:

k=1,...N with N: Number of total simulation

i= 1,...P with P : Input factors

By calculating now the Fourier transformed of the considered variance Y, we can plot the spectral result as presented in Fig. 4.

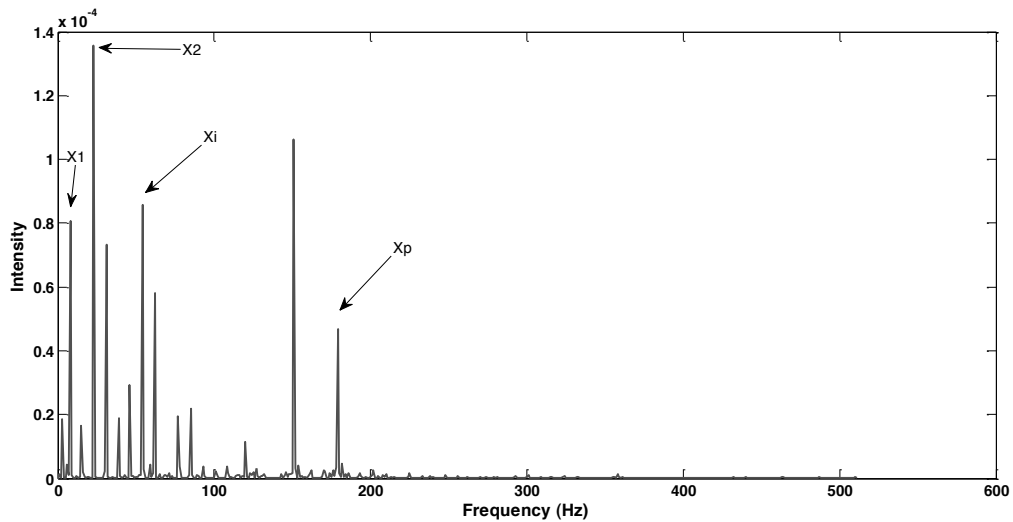

Fig. 4. Y variance's Spectral result issued from FAST method

This Fig. 4 allows to associate easily every peak to its own proper frequency and by induction, to its own inputs factors. In the other hand, the intensity of each peak gives back or quantifies the influence of its corresponding input factors.

To perform now, the sensitivity analysis of the PISTACHE tool's performance indicators towards the input factors, the FAST method has been applied for all input factors that can be seen in Table 2. This table gathers the considered factors, its definitions, its target values, its ranges of variation, its units and the prime frequency assigned to each input factor.

5. Results and discussion

The sensitivity analysis based on FAST method has been applied for the different annual performance indicators. Our discussion for the obtained results will focus exclusively in the studied area which gathers the most intense peaks corresponding at the same time to the most influential input parameters for the following performance indicators:

5.1. Hot storage efficiency (η_{HS}):

The obtained spectrum (Fig. 5) leads to distinguish two kinds of effect defined as:

A. Main effect: Occurred by factors with prime frequency such as:

23 : T_{G_MIN} : minimal temperature of generator

31 : T_{HS_MAX} : maximal temperature of hot storage

B. Secondary effect: due to the interaction of the factors at the origin of the main effect, in this case we notify:

54 (23+31) : superposition of the coupled effect of T_{G_MIN} and T_{HS_MAX}

8 (31-23) : interaction effect of T_{HS_MAX} and T_{G_MIN}

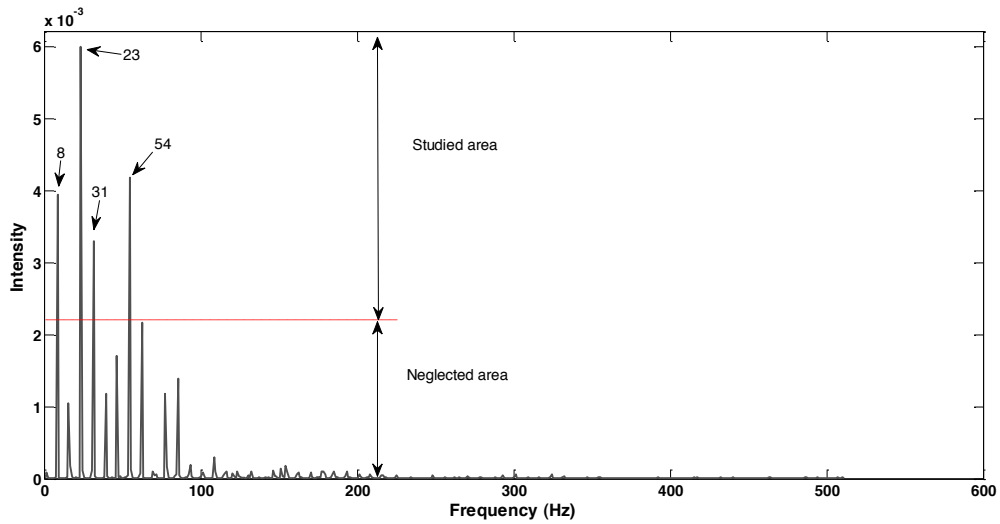

Fig. 5 Fast method applied for hot storage efficiency η_{HS} .

5.2. Cold storage efficiency (η_{CS}):

From the (Fig. 6), the most important peaks correspond to the most influential parameters which are: Reference ambient temperature T_{amb} (3), hot storage's maximal temperature T_{HS_MAX} (31), generator's minimal temperature T_{G_MIN} (23), maximal thermal coefficient of performance COP_0 (151) and then cooling power's maximization coefficient kP_{MAX} (179). However, we note that the cold storage efficiency is also affected by the interaction of both T_{G_MIN} and T_{HS_MAX} (54 and 8).

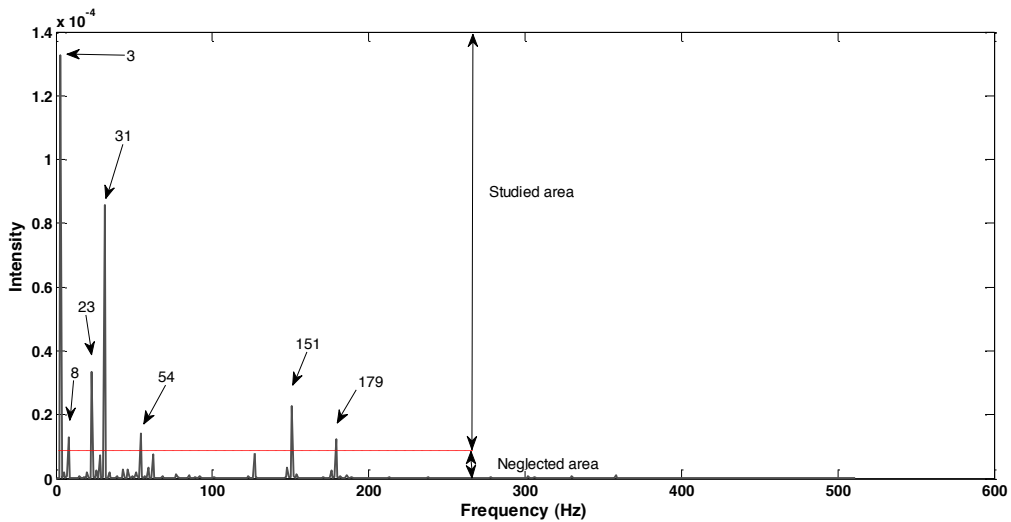

Fig. 6. Fast method applied for cold storage efficiency η_{CS}

5.3. Thermal coefficient of performance (COP_{th})

The calculation of the chiller thermal coefficient for PISTACH tool is based on empirical relation [4], defined as:

$$COP_{th} = a1 \cdot \exp\left(\frac{-\eta_{Carnot}}{b1}\right) + a2 \cdot \exp\left(\frac{-\eta_{Carnot}}{b2}\right) + COP_0 \quad (2)$$

With

η_{Carnot} : Carnot efficiency

$a1, a2, b1, b2$: experimental coefficients obtained from CEA-INES test bench [4]

The Fig. 7 allows to identify the following most influential input factors which are respectively hot storage's maximal temperature T_{HS_MAX} (31), maximal thermal coefficient of performance COP_0 (151) and generator's minimal temperature T_{G_MIN} (23). A second effect influence is observed due to the superposition of the input parameters T_{G_MIN} and T_{HS_MAX} (58 and 8).

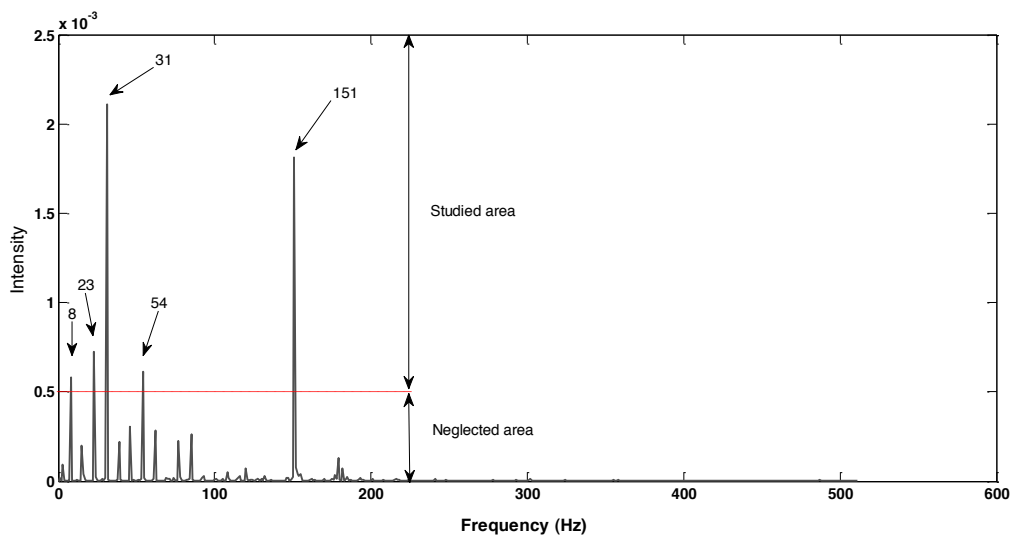

Fig. 7. Fast method applied for thermal coefficient of performance COP_{th} .

5.4. Primary energy ratio (PER):

The sensitivity analysis's result presented in Fig. 8 shows that the primary energy ratio is not only affected by the generator's minimal temperature T_{G_MIN} (23) and the hot storage's maximal temperature T_{HS_MAX} (31) separately but by its interaction (54 and 8) too.

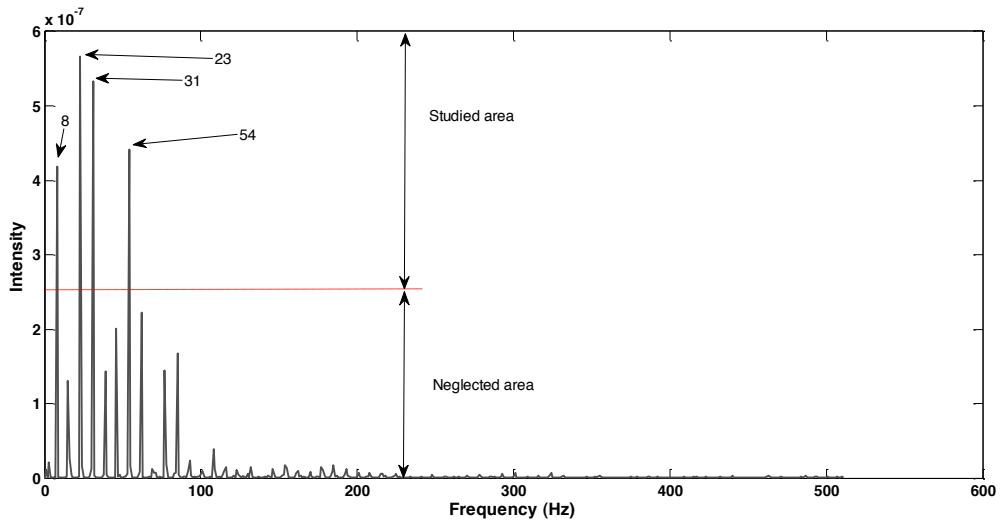

Fig. 8. Fast method applied on primary energy ratio PER.

5.5. Useful solar thermal productivity (PSU)

Depending of the input factors influence’s degree on the PSU indicator highlighted in Fig. 9, the main influential input factors are listed as follow: generator’s minimal temperature T_{G_MIN} (23), maximal thermal coefficient of performance COP_0 (151), hot storage’s maximal temperature T_{HS_MAX} (31) and cooling power’s maximization coefficient kP_{MAX} (179); with a double interaction level effect observed for T_{G_MIN} and T_{HS_MAX} , first degree superposition corresponding to the frequencies 54 (31+23) and 8 (31-23) and second degree superposition related to the frequency 62 (54+8).

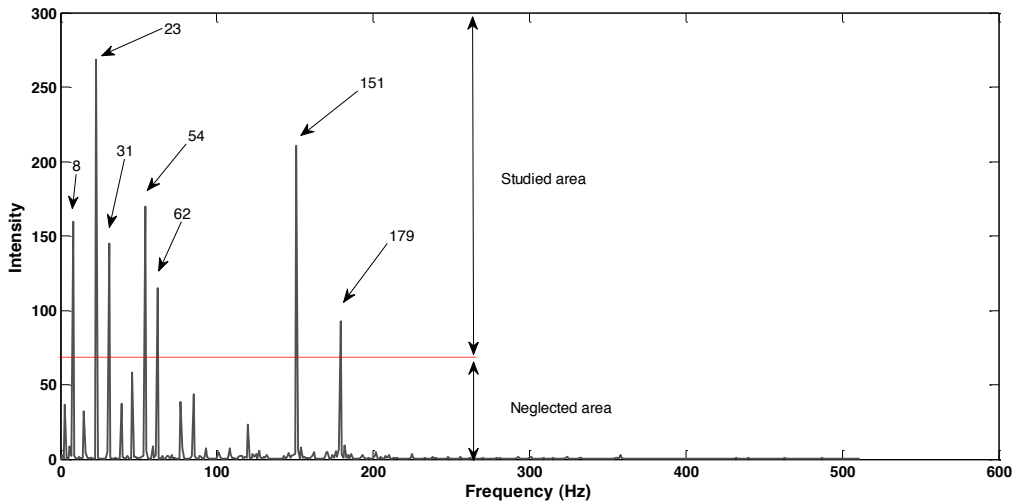

Fig. 9. Fast method applied for the useful solar thermal productivity PSU.

6. Conclusions and perspectives

This presented work has been mainly focused on the validation and the sensitivity analysis of the new sizing tool PISTACHE.

Firstly, parameter's identification study has allowed to the validation of the PISTACHE tool. After identification, the estimated relative errors due to the comparison between PISTACHE results and first season's RAFSOL data has been highly improved (0.57% for Q1, 3.75% for Q6 and 6.16% for Q7). Concerning the validation step, a new simulation has been carried out using both the values of the inputs parameters defined by the identification study and a second season's RAFSOL data. The validation step results have noted a higher values of the relative errors (9.2% for Q1, 13.6% for Q6 and 15.8% for Q7) which are probably due to the different operating mode of the RAFSOL installation for the validation step (second season's RAFSOL data) comparing to the identification step (first season's RAFSOL data). However, we estimate a coherent behaviour of PISTACHE tool and we highly suggest another validation study using several season's RAFSOL data.

Secondly, a sensitivity analysis of the new PISTACHE tool's prediction performance towards its input factors has been presented. This study targeted to point out the most influential input factors on the output performance indicators such as: *thermal efficiency indicators* (η_{CS} , η_{HS} and COP_{th}), *global performance indicator* (PER), *solar performance indicators* (PSU). This sensitivity analysis has been performed using a FAST method. The application of the FAST method for each input factors of PISTACHE tool (37 in number) induced a spectral result for each PISTACHE tool's output indicators of performance. The interpretation of these different spectral results reveals that the performances of the chiller absorption system as defined in PISTACHE tool (Fig. 1) are mainly affected by both the reference ambient temperature (T_{amb}) and the internal parameters of the PISTACHE tool (T_{HS_MAX} , T_{G_MIN} , COP_0 and kP_{MAX}) where the different specifications concerning these parameters are listed hereafter:

- T_{HS_MAX} is a normal operating parameter of installations due to tank's constructive constraints
- T_{amb} reference ambient temperature defined by the user
- T_{G_MIN} and COP_0 are constructor characteristic parameters of chiller systems which should be defined in the same operating conditions for all machines.
- kP_{MAX} is an experimental characteristic parameter of the sorption machine's operating mode. This parameter is also the cooling power's maximization coefficient during starting phase of a sorption machine. It should be, normally, specific for every machine because of the particular transient functioning mode of each machine. Unfortunately, the actual nonexistence of both normalized operating data and standardized test methods for sorption machines hampers strongly the implementation of a simplified modeling method.

Consequently, this sensitivity analysis has allowed to test the operating mode of the PISTACHE tool which presents a coherent behaviour towards the physical nature of the different studied input factors.

Acknowledgements

The authors wish to acknowledge the financial support of the French National Research Agency (ANR) through "Habitat intelligent et solaire photovoltaïque" program (project MEGAPICS n°ANR-09-HABISOL-007), and also all the partners of the project MEGAPICS.

References

- [1] Praene JP, Marc O, Lucas F, Miranville F, Simulation and experimental investigation of solar absorption cooling system in Reunion Island. Applied Energy 88; 2011. p. 831–839.
- [2] Marc O, Praene JP, Bastide A, Lucas F, Modeling and experimental validation of the solar loop for absorption solar cooling system using double-glazed collectors. Applied Thermal Engineering 31, Issues 2-3; February 2011. p. 268-277.
- [3] Ziegler F, Sorption heat pumping technologies: Comparisons and challenges. International Journal of Refrigeration 32; 2009. p. 566-576.
- [4] Le denn A, Boudéhen F, Mugnier D, Papillon P, A simple predesign tool for solar cooling, heating and domestic hot water production systems, Building simulation 2013, August 25-28, Chambéry, France.
- [5] Nowag J, Boudéhen F, Le denn A, Lucas F, Marc O, Radulescu M, Papillon P, Calculation of performance indicators for solar cooling,

heating and domestic hot water system. Energy Procedia n°30; 2012; p. 937-946.

- [6] Le denn A, Boudéhen F, Morgenstern A, Design facilitator : implified design tools for solar heating and cooling systems, OTTI Solar Air-Conditioning 2013, September 25-27, Bad Krozingen, Germany.
- [7] Saltelli A, Andres TH, Homma T, Sensitivity analysis of model output. Performance of the iterated fractional factorial design method. Computational Statistics & Data Analysis 20 ;1995.p. 3876-407.
- [8] Cukier RI, Schaibly JH, Shuler KE, Study of the sensitivity of coupled reaction systems to uncertainties in rate coefficients: Analysis of the approximations. Journal of Chemical Physics 63; 1975.p. 1140-1149
- [9] Letexier B, Marc O , Praene JP, Lucas F, Sensitivity analysis of a solar cooling systems. ASME 2012, July 2-4, Nantes, France.

Appendix A.

Table 2. Input factors of the PISTACHE tool

Factor	Definition	Target value	Range of variation	Unit	Frequency (Hz)
T_{amb}	Reference ambient temperature	20	[10 , 30]	°C	3
T_{DHW}	Domestic hot water temperature	60	[30 , 90]	°C	7
T_{cool}	Ice water departure temperature	9	[7 , 12]	°C	11
T_{heat}	Heating departure temperature	55	[35 , 75]	°C	19
T_{G_MIN}	Generator's minimal temperature	65	[50 , 85]	°C	23
T_{HS_MAX}	Hot storage's maximal temperature	95	[80 , 115]	°C	31
T_{CS_MIN}	Cold storage's minimum temperature	4	[2.5 , 5.5]	°C	43
T_{cool_MIN}	Cooling's minimum temperature	23	[23 , 25]	°C	47
R_{ps}	Heat exchanger efficiency	1	[0.8 , 1]	-	59
T_{coll_DHW}	Collector's temperature for DHW	35	[30 , 35]	°C	67
T_{coll_heat}	Collector's temperature for heating	45	[40 , 50]	°C	71
$T_{coll_DHW\&heat}$	Collector's temperature for heating+DWH	40	[35 , 45]	°C	79
T_{coll_cool}	Collector's temperature for cooling	60	[50 , 70]	°C	127
dT_{cool}	Temperature difference at epevaporator	5	[2.5 , 7.5]	°C	131
$COP_{th,n}$	Nominal thermal coefficient of performance	1	[0.8 , 1]	-	139
COP_0	Maximal thermal coefficient of performance	0.6	[0.35 , 0.63]	-	151
k_P_{Start}	Cooling Power's maximization coefficient (starting phase)	1.1	[1 .05 , 1.3]	-	163
k_P_{MIN}	Cooling power's minimization coefficient (operating phase)	0.5	[0.4 , 0.6]	-	167
k_P_{MAX}	Cooling power's maximization coefficient (operating phase)	1.2	[1 , 1.2]	-	179
a_CR_{HS}	Hot storage tank heat loss time constant coefficient	1.43	[1.14 , 1.7]	-	191
b_CR_{HS}	Hot storage tank heat loss time constant coefficient	-0.42	[-0.5, -0.33]	-	199
a_CR_{CS}	Cold storage tank heat loss time constant coefficient	2.75	[2.2 , 3.3]	-	211
b_CR_{CS}	Cold storage tank heat loss time constant coefficient	-0.44	[-0.53, -0.35]	-	223
$a_CR_{S_DHW}$	DHW storage tank heat loss time constant coefficient	1.43	[1.14 , 1.7]	-	227
$b_CR_{S_DHW}$	DHW storage tank heat loss time constant coefficient	-0.42	[-0.5, -0.33]	-	239
PDC_ta	Head losses of equilibrium valve	0.3	[0.1 , 0.5]	mWC	379
PDC_compt	Head losses of flow meter	0.7	[0.4 , 0.1]	mWC	383
PDC_clap	Head losses of check valve	0.1	[0.1 , 0.3]	mWC	419
PDC_exch	Head losses of heat exchanger	2	[1 , 3]	mWC	431
PDC_coll	Head losses of collectors	1	[1 , 3]	mWC	439
R_pump	Pump efficiency	0.3	[0.3 , 0.5]	-	443
Dis_cm	Distance Collector- sorption chiller	10	[8 ,12]	m	463
Dis_mref	Distance sorption chiller-cooling tower	10	[8 ,12]	m	467
Dis_md	Distance sorption chiller- distribution	10	[8 ,12]	m	479
$aE11_AB$	Electrical consumption absorption chiller coefficient	7.5	[5,10]	-	487
$bE11_AB$	Electrical consumption absorption chiller coefficient	148	[140 , 155]	-	491
albedo	Factor	0.2	[0.16 , 0.24]	-	499