



HAL
open science

Robust EGNOS GEO Ranging with Electric Propulsion Satellite

Hugues Secrétan, Flavien Mercier, Sébastien Trilles, Julien Mancuso, Xavier Bérenguer

► **To cite this version:**

Hugues Secrétan, Flavien Mercier, Sébastien Trilles, Julien Mancuso, Xavier Bérenguer. Robust EGNOS GEO Ranging with Electric Propulsion Satellite. 27th International Technical Meeting of The Satellite Division of the Institute of Navigation (ION GNSS+ 2014), Sep 2014, Tempa, United States. pp. 3323-3330. hal-01141441

HAL Id: hal-01141441

<https://hal.science/hal-01141441>

Submitted on 13 Apr 2015

HAL is a multi-disciplinary open access archive for the deposit and dissemination of scientific research documents, whether they are published or not. The documents may come from teaching and research institutions in France or abroad, or from public or private research centers.

L'archive ouverte pluridisciplinaire **HAL**, est destinée au dépôt et à la diffusion de documents scientifiques de niveau recherche, publiés ou non, émanant des établissements d'enseignement et de recherche français ou étrangers, des laboratoires publics ou privés.



Open Archive TOULOUSE Archive Ouverte (OATAO)

OATAO is an open access repository that collects the work of Toulouse researchers and makes it freely available over the web where possible.

This is an author-deposited version published in : <http://oatao.univ-toulouse.fr/>
Eprints ID : 13800

To cite this version : Secrétan, Hugues and Mercier, Flavien and Trilles, Sébastien and Mancuso, Julien and Bérenguer, Xavier Robust EGNOS GEO Ranging with Electric Propulsion Satellite. (2014) In: 27th International Technical Meeting of The Satellite Division of the Institute of Navigation (ION GNSS+ 2014), 8 September 2014 - 12 September 2014 (Tempa, United States).

Any correspondence concerning this service should be sent to the repository administrator: staff-oatao@listes-diff.inp-toulouse.fr

Robust EGNOS GEO Ranging with Electric Propulsion Satellite

H. Secretan, F. Mercier, *CNES, Toulouse, France*

S. Trilles, J. Mancuso, X. Berenguer, *Thales Alenia Space, Toulouse, France*

1. BIOGRAPHIES

Flavien Mercier is senior expert in the orbit determination team at CNES. He works on the precise orbit determination for altimetry satellites (TOPEX, JASON) since 2001, he is specialist in GPS processing. He is also involved in validations for the EGNOS team. Since 2010, he is participating to the CNES/CLS analysis centre for IGS ('grg' products).

Hugues Secretan is an expert in GNSS, working at CNES in the Navigation System Engineering department since 1995. He has worked in the ESA EGNOS Project Office from 1998 to 2010, as ESTB (EGNOS System Test Bed) Manager, then as SPEED project manager. Since 2010, he has been in charge of the TENOR project activities dealing with new concepts for GNSS system.

Sébastien Trilles is an expert in Navigation, working at Thales Alenia Space since 2011 on EGNOS Project as Algorithm Responsible for EGNOS V2 and as Performance Manager for EGNOS V3. Since 2013, he has been in charge of Algorithm studies with the CNES on Precise Orbit Determination and Time System Reference for EGNOS.

Xavier Berenguer is an expert in GNSS. He works on EGNOS since 2003, with position of EGNOS Performances Manager from 2006 to 2012. Since 2013 he is involved in various System Engineering studies for EGNOS, and is in charge of GEO Ranging introduction for EGNOS V2&V3.

Julien Mancuso is a software development engineer. He joined Thales Alenia Space in 2008 to design and develop some applications linked with space technology. He is involved in AIS satellite constellation simulator on behalf of ESA, satellite image acquisition system and EGNOS algorithm prototypes.

2. ABSTRACT

The main purpose of a Satellite Based Augmentation Systems (SBAS), such as EGNOS or WAAS, is to provide the civil aviation user community with reliable navigation services for different flight phases. To achieve its missions over ECAC area, EGNOS uses two Geostationary Earth Orbit (GEO) satellites for corrections

broadcasting that enhances GPS standard positioning, and allow providing sufficient integrity, accuracy, availability and continuity for commercial aviation needs. Today, one EGNOS GEO platform has electric propulsion (PRN 126) for stations keeping manoeuvres, and in early 2015 the EGNOS GEO PRN 120 will be replaced by a new GEO platform (Astra4B) with electric propulsion also. To use EGNOS GEO as a ranging source, the user needs an accurate GEO pseudo-range modelling based on GEO ephemeris and time synchronisation broadcasted in MT#9 and associated fast corrections.

This paper presents the results of GEO Ranging performances based on an experimentation made in real conditions and real time, using EGNOS SPEED Testbed, and aiming to validate the strategy for GEO orbit/clock determination optimised for electric propulsion manoeuvres plan. The important characteristic is that the manoeuvres have small amplitude and long durations (two burns of 1.5h duration every two days). But a constraint for EGNOS is that they are considered as unknown (beginning of the manoeuvre, direction, amplitude, end of manoeuvre ...), due to operational constraints. The performance objective is to provide a GEO range error better than 2.5 m rms.

The orbit determination algorithm has been defined by CNES, in a first step, with a theoretical performance analysis (covariance analysis), and validated in a second step using real data from EGNOS RIMS on EGNOS GEO PRN 126 satellite (Inmarsat4-F2) and a dedicated orbit determination software [1]. These preliminary studies have shown that it is possible to achieve the required performance using the real EGNOS RIMS measurements but with a specific processing which is not directly usable in the present EGNOS design.

This paper develops the results obtained in a realistic environment.

First, the algorithm has been improved, and applied on real internal data, produced by the SPEED Testbed (smoothed C1 pseudo-ranges, corrected by the ionosphere and troposphere delays, and the receiver clock synchronisation computed by the GPS/Glonass orbit determination module of SPEED). The first results show that it is possible to achieve a performance around 1 m

rms for the User Range Error (residuals of the OD process on the reference stations).

However, a more realistic performance test is to implement the GEO orbit determination algorithms in SPEED to verify that the generated correction messages reflect this performance. This implementation has been developed by TAS, and the complete SPEED SNK PF (equivalent to EGNOS CPF-PS) performance has been verified using the produced EGNOS messages. These new SPEED GEO Ranging experiment results are presented, and the performance achieved so far with respect to the EGNOS requirements and the plan for the implementation in the EGNOS operational system.

3. INTRODUCTION

In Satellite Based Augmentation System (SBAS), the corrections for the users are broadcasted using a geostationary satellite. Also, it is possible to use the geostationary satellite navigation signal for the receiver positioning (Geo Ranging function). This implies to perform an orbit and clock determination for this satellite in the same conditions as for the GPS or Glonass satellites for example.

The current configuration for this orbit determination uses long arcs. Even if the EGNOS ranging is not available at user level, the Geo orbit and clock determination process is running and is based on long arcs (60 hours). This was also the case during the pre-development studies [2]. The arc is recomputed every 30 minutes. When no maneuver is performed, this allows producing a precise estimation of the geo trajectory. This trajectory is used by the clock module, which recomputes in real time the full synchronization of the network and satellites to obtain the rapid corrections message.

An important requirement for EGNOS system is that the manoeuvres parameters (epochs, orientations and durations) can't be implemented in the operational software for safety reasons. For chemical manoeuvres, a detection algorithm was developed in EGNOS V1 for the ground segment, in order to reinitialize the orbit determination (and thus interrupt GEO-Ranging), which is nominally performed using 60 hours arcs. Such an approach works correctly for chemical orbit control systems, because the maneuvers are not frequent, and the interruption for the geo-ranging service is acceptable.

For electric propulsion maneuvers, this approach is not possible, because the maneuvers are too frequent (typically every two days), such frequent interruptions would jeopardize GEO ranging availability performance. In addition, in order to avoid any divergence risk in the orbitography process during electric manoeuvre, it would be necessary to adjust additional parameters to take into account these accelerations in the orbit determination, but the epochs and amplitudes are unknown.

Another approach here is to use short arcs for the geo orbit determination [1] (typically one hour duration). The advantage is that the convergence of the orbit determination process is very fast. Another important advantage is that the short arc may adjust correctly (under certain conditions), even during the maneuvers. However, the difficulty is that the extrapolation quality will be not as good as for a long arc, thus leading to more frequent updates of the orbit, and shorter extrapolation periods.

The geometrical characteristics of the problem (orbit observability, consequences on the user modelling) and the dynamical characteristics (impact of the dynamic mis-modeling during manoeuvres) have been studied in [1]. A complete orbit determination test using real data measured on the EGNOS network has also been performed

The Geo OD algorithm has been slightly modified and implemented in the SPEED platform to verify the preceding results in a complete and representative environment.

Then tests have been performed using the generated EGNOS messages, to compute an estimation of the achieved performance for the Geo Ranging function.

4. MODELING AND ERRORS

In the preceding study [1], we have shown that the orbit determination for the Geo satellite can be efficient for Geo ranging purposes using a least squares algorithm and short arcs (typically 1-2 hours duration). The advantages of this method are a very fast convergence time and a good performance even during low acceleration maneuvers (electric propulsion). The maximal acceleration during manoeuvres and the required performance give the maximum possible arc duration [1].

Here we focus on an efficient implementation of this method in the Speed environment. The main constraints are:

- Use the internal data available: EGNOS iono corrections, smoothed pseudo-range Geo measurements, RIMS SPEED clock synchronization (linear extrapolation).
- Improve the computational time: due to the Geo short arc duration, it is necessary to update the orbit very frequently, every one or two minutes at least. A standard least square procedure will require a lot of additional computations, if the arc overlaps are important between two successive arcs.
- Produce Geo ephemeris compatible with the current implementation in the Speed platform.

In order to simplify the implementation and improve the efficiency, it is interesting to obtain the Geo ephemeris at

each new measurement epoch (every 8 s). Thus the algorithm has been changed to a recursive least squares, with exponential weighting (square root formulation using qr decomposition). The weighting is defined as $\alpha = 1 - \tau/h$ with τ the update sampling (8 seconds), and h corresponding to the duration of the arc. This process is equivalent to an extended Kalman filter, with exponential weighting and no model noise. The covariance at epoch $n + 1$, after extrapolation, but before the measurement processing is divided by α before the update using the measurements at epoch $n + 1$. The value for h used in the experimentations is 3600s.

The second degree polynomials representing the extrapolated orbit are adjusted on the current ephemeris produced by the filter. These polynomials are used for the orbit message generation. They are updated at each epoch (8 seconds sampling). The process which constructs the messages is thus able to use always the best estimated orbit.

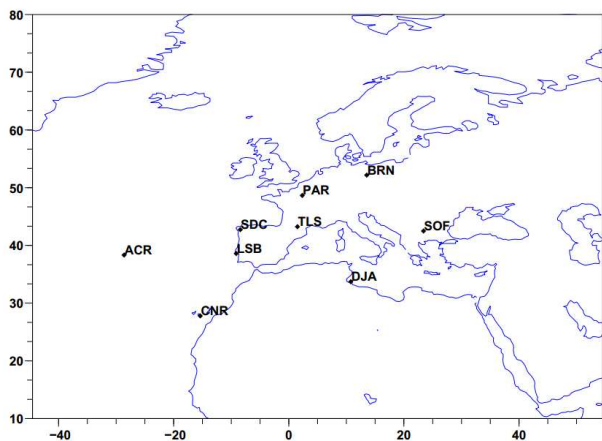

Figure 1: stations used for the orbit determination (Caesium clock except LSB)

There is currently a limitation in the use of the RIMS data for the Geo orbit estimation. This is related to the internal representation of the station synchronisation: the RIMS clock offsets are estimated by the GPS orbit determination process at each epoch (snapshots), and a linear model is adjusted on these data, to allow an extrapolation of this offset. The model is adjusted on 48 h duration (one GPS orbit determination batch). This gives correct performances for Caesium clocks, but is not suited for a good prediction for rubidium clocks.

List of RIMS used for the orbit determination has been limited to the Caesium stations subset (figure 1). The orbit errors will probably degrade the performances for the stations outside this area (see below on the Hartebeesthoek station).

However, the satellite clock offsets (GPS and Geo) will be calculated globally in the SPEED clock module, minimizing the remaining errors (see below §5).

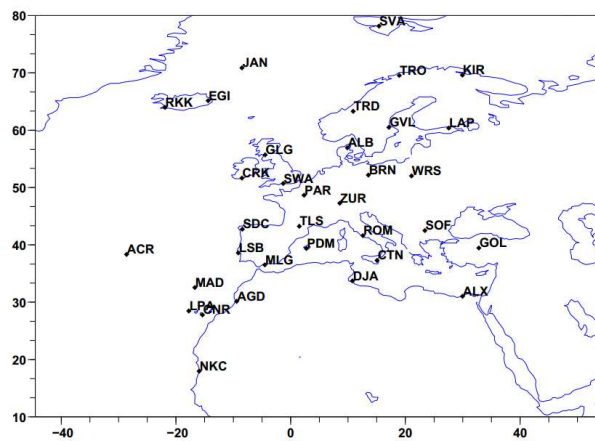

Figure 2: complete EGNOS RIMS network

Figure 3 shows the residuals obtained on the 6-9 January 2012, for the GEO PRN 126, for the European stations used in the orbit determination process (stations with Caesium clocks), and for the Hartebeesthoek station (HBK, South Africa). The first day has been removed (convergence of the GPS OD process).

The station corresponding to the red peaks in the residuals is Toulouse, which has very important multipath characteristics.

The manoeuvres are clearly visible on the HBK residuals: the dynamic model which has no acceleration modelling is not performant enough to achieve a correct orbit over Europe and HBK. Due to the limited and concentrated Caesium stations location over Europe, the filter maintains the performance over Europe, in order to have an orbit with minimal errors on the ECAC. The rms value over Europe is 1.3 m rms.

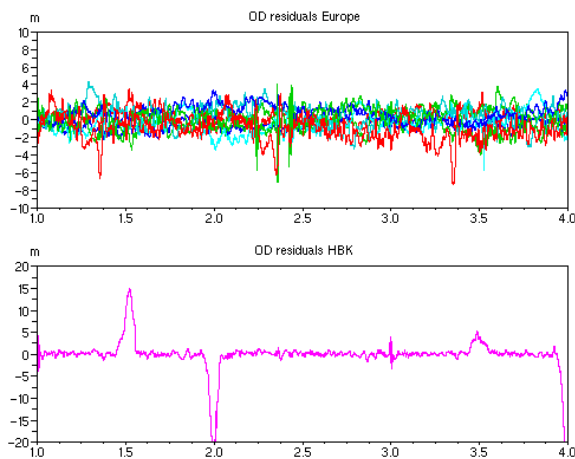

Figure 3: filter residuals for European stations and HBK station, 7-9 January 2012

5. IMPLEMENTATION IN EGNOS TESTBED

Based on the CNES OD algorithm prototype and its technical description, Thales Alenia Space has developed,

within a CNES contract, a stand-alone software solution in C language, called OGEO program that is faithfully representative of the performances reached by the CNES results up to numerical effect. The software OGEO is then integrated into the TAS experimentation and certified platform, SPEED, to assess the performances of the OGEO solution in the context of MOPS message scheduled by EGNOS with synthetic and real data.

SPEED for ‘System Platform for EGNOS Evolutions & Demonstrations’ is an SBAS Operational Test-bed that fully represents EGNOS Performances in terms of accuracy, continuity, availability and integrity for Safety Of Life services.

SPEED is currently used on EGNOS program for system performance engineering, qualification of new releases, monitoring and troubleshooting of deployed EGNOS release. It is also used for HISTB, the experimentation that paves the way for EGNOS V3 aeronautical services, for CNES Experimentations for engineering of new SBAS algorithms as it is the case regarding the GEO-Ranging, and finally for ATB experimentations related to future EGNOS services (mainly maritime and aeronautical ones) over Arctic zone.

The platform SPEED has been designed to facilitate the development and tuning of SBAS algorithms thanks to a hosting structure that enables easy integration of new algorithms function through a standardized interface.

The OGEO module has been integrated in the SPEED navigation kernel that is the core of the platform. This kernel fully matches the EGNOS Central Processing facility (CPF). Integrations tests have also been performed to retrieve exactly the same results reached on stand-alone module.

The interfaces of OGEO module match with the internal interfaces of algorithm function of SPEED, in particular regarding the production of the OGEO ephemeris.

The OGEO module is fed, every 8s, by GEO smoothed measurements corrected by troposphere and ionosphere delay and by the clock synchronization of the station set of reception EGNOS (RIMS). This Stations synchronization is provided as an output of the GPS orbit computation module and is used to predict the behaviour of the clock offset of each RIMS with respect to GPS time. The prediction is modelled by a linear regression performed on a suitable interval of the GPS orbit computation arc (48h duration currently). As already mentioned in §4 this arc duration is correct for Caesium clock but not relevant for Rubidium clock. Because of this limitation Rubidium clock were removed from the GEO orbit and synchronization computation.

The OGEO module computes both the clock and ephemeris of the GEO. The clock offset reflects the gap between the apparent controlled clock at NLES level and

the EGNOS Network Time (ENT). Nevertheless only the GEO ephemeris is used in the EGNOS algorithms functions. Then OGEO module provides to the other modules only the ephemeris each 8s.

The clock offset is computed as part through a dedicated module CLK running with both the ephemeris and the iono-free, tropo-free, slip-free GEO L1 smoothed measurements. The module is responsible of the creation and the maintaining of the ENT, the internal reference time of the CPF. The ENT is a composite clock built with a subset of the RIMS clock. The RIMS synchronization is performed with respect to the ENT. The module is then responsible to the determination of the GEO satellite clock offset and drift from ENT by a least square algorithm once all RIMS clock are synchronized. The GEO clock offset and drift from ENT are separated into three components, a fast component which will be included in fast corrections (MT2-4), the slow component which will be included in GEO navigation message (MT9) and a residual and stable component which will be included into long term correction (MT24/25). Finally the CLK module computes the steering of ENT to the GPS time scale. The steering shall be inferior to 50ns by requirement but, in practical the gap between the two time references is below 3ns. The ENT-GPS offset and drift are used by the module message (MSG) to produce the series of MOPS formatted messages.

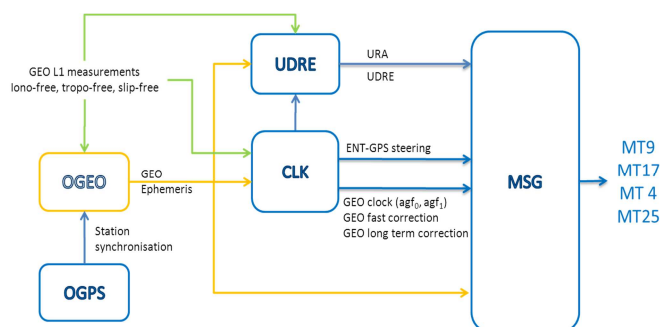

Figure 4: GEO orbit and messages generation processing

The UDRE represent the non-modelled orbit and clock error once applied the GEO navigation and the EGNOS corrections. It is computed by a dedicated module (UDRE) taking into account the GEO L1 smoothed measurements iono-free, tropo-free and slip-free, the GEO ephemeris provided by OGEO and clock provided by CLK.

The GEO-Ranging function is provided by message type:

- 9 (GEO navigation message) containing the GEO ephemeris, clock and URA,
- 17 (GEO almanac) providing information about satellite health and status as well as its rough position,
- 4 (fast correction) containing rapid clock offset correction and UDRE@3.29σ,

- 24/25 (long term correction), providing estimation of slowly varying satellite ephemeris and clock errors.

By design EGNOS compute and broadcast long term correction data for its own GEOs. This is indeed allowed by MOPS even if MOPS does not allow the user equipment to apply the MT24/25 for GEOs belonging to the same service providers, so as required by MOPS the UDRE provided by EGNOS in MT4 is computed without taking into account the long term corrections.

The long term clock correction (MT24/25) contains indeed the difference between the reference times. The first one being the reference time generated by the CPF to steer the apparent GEO clock, the second one being the reference time used to process the GEO measurements to compute the MT9 clock offset and drift. In case the GEO providing corrections is belonging to the same service provider, these long term corrections shall be very close to zero because of the reference time is the same. The only case that could produce non-null corrections is the switch of CPF. Indeed, each CPF, belonging to the same service provider, generates its own reference system time. In consequence the MT24/25 absorbs this difference in case of CPF switch. Nevertheless during CPF switch UDRE (including UDRE of GEO) is inflated to take into account this difference in reference time.

6. PERFORMANCES RESULTS

A. Scenarios of GEO Ranging experiments

Several sets of 4 days of EGNOS RIMS raw data have been replayed with the modified SPEED Testbed. For PRN 126 (electric system propulsion)

- 4 days of raw data from 6 to 9 January 2012,
- 4 days of raw data from 18 to 21 February 2014

For PRN 120 (chemical system propulsion):

- 4 days of raw data from 30 January 2014 to 2 February 2014

For each set of data, the Navigation Overlay Frames messages (MOPS messages) have been generated by SPEED. Then the performances at user level and signal level have been analyzed.

The exponential weighting coefficient for the OD filter corresponds to one hour duration. The update rate of the GEO ephemeris in the MT9 is 80seconds.

B. Analyze of the GEO Residuals

The residuals of the GEO PRN 126, after application of the EGNOS broadcasts corrections (fast corrections and iono corrections) for three different locations (Toulouse, Malaga and Glasgow) are represented on figure 5 below. The amplitude of the residuals is around +/- 4 meters, and the rapid variations are different between the receivers, they are maybe due to the multipath on the GEO pseudo-range measurements. There is a N/S maneuver lasting 1.5h between 10h30 and 12h00. The beginning and end

epochs are represented by the symbols on figure 5. The maneuver is not affecting the residuals, showing the good robustness of the orbit determination algorithm.

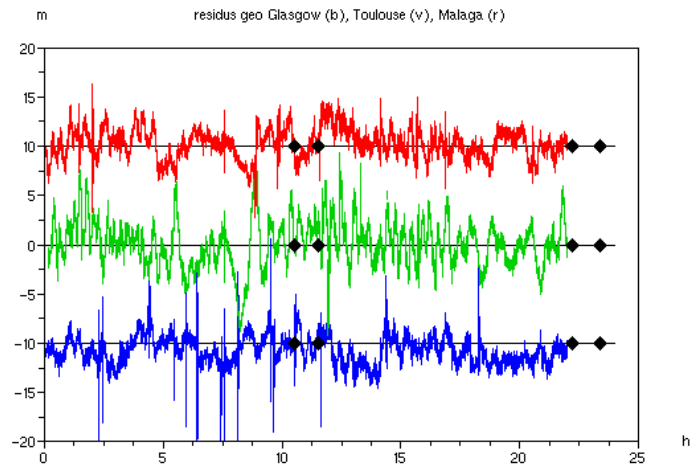

Figure 5: Residuals GEO 126 on 9/01/2012, the symbols correspond to beginning and end of the maneuvers

A comparison of the residuals of PRN 120 on two consecutive days for Toulouse station is represented on figure 6 below (*green curve corresponds to 31st January, plotted with a +10m bias*). The variations are similar on each day; this behavior is probably also due to multipath affecting the raw measurements. We can notice that the period of the oscillations is much larger for GEO 120 then GEO 126, due to the higher inclination of the PRN 120 ($i = 2.7^\circ$), which lead to a faster change of the geometry.

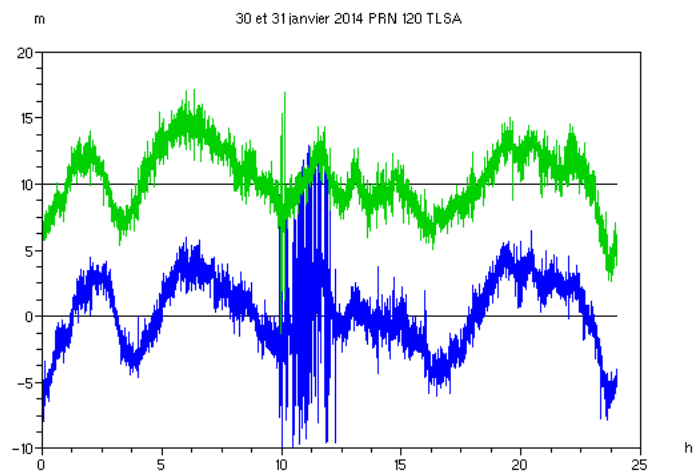

Figure 6: residuals of PRN 120, 30(b) and 31(g) January 2014, Toulouse Station

In order to confirm the origin of this signature, the code and phase of PRN 120 have been compared (see fig. 7 below). On this figure, we observe multipath and iono effects. During the night, the signatures of figures 6 and 7 are identical, showing the multipath effect, while the rest is more affected by the ionospheric delay that was not removed.

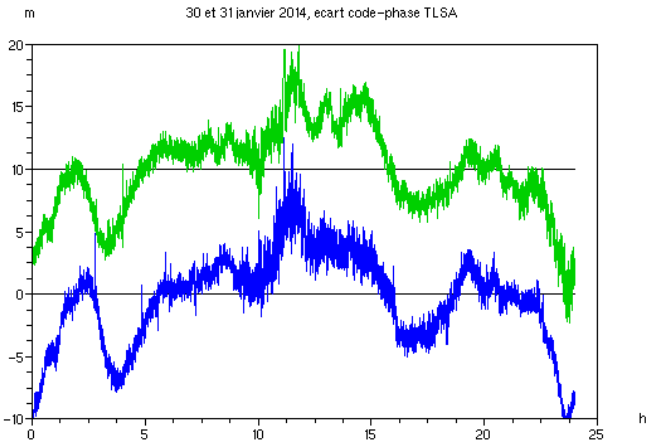

Figure 7: code-phase for PRN 120 in Toulouse, 30 and 31st January 2014

Knowing this, in order to eliminate the multipath, the L1 pseudorange measurements of fig.5 have been smoothed using the phase and a four hours centered sliding window. The resulting GEO residuals are represented on the figure 8 below (Glasgow is blue, Toulouse is green and Malaga is red). The two N/S electric maneuvers are shown around 11h and 23h. The comparison with figure 5 results shows that the rapid variations observed for example on Toulouse station around 5h are due to the station pseudo-range errors.

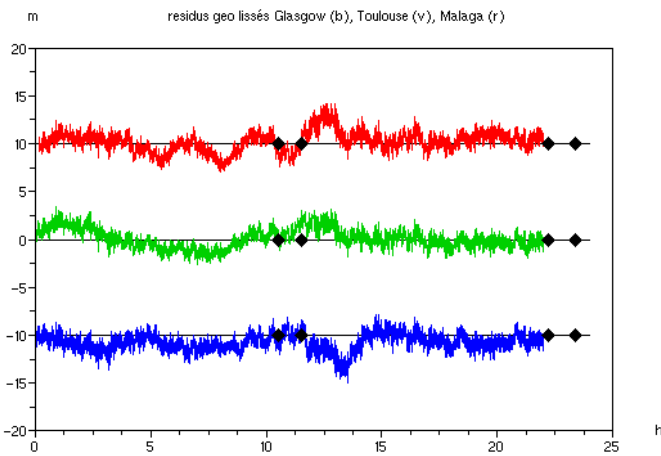

Figure 8: Residuals of GEO 126 on 9/01/2012 with smoothed pseudoranges

The histogram represented on figure 9 below, show a rather “normal” distribution of the residuals.

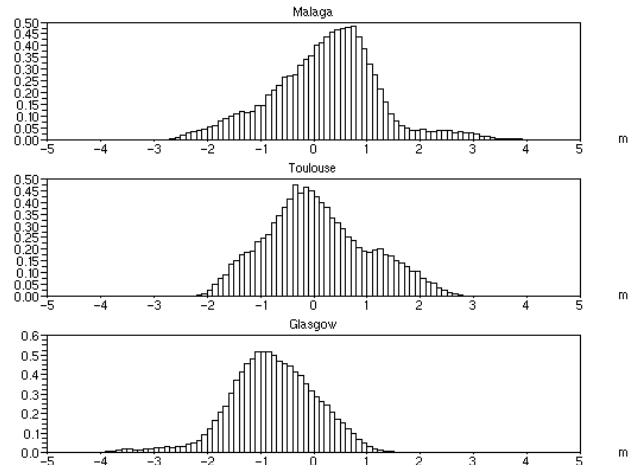

Figure 9: histogram of the residuals

The RMS values of the residuals of fig. 5&8 are:

Stations	unsmoothed	smoothed
Glasgow	1.54	1.13
Toulouse	2.42	0.96
Malaga	1.47	1.03

These RMS values are in the specifications of 2.5m. The RMS value of the GEO residual obtained with smoothed pseudorange can be considered as representative of the UDRE GEO. We realize here the importance of multipath at user-level and then the interest to mitigate this important signal disturbance.

C. Broadcasted Accuracy and integrity

For the GEO 126, clock, UDRE and fast corrections broadcasted in the SBAS messages are presented on figure 10 below; during the manoeuvre it can be seen that the GEO clock offset has increased, the magnitude of the fast corrections are also increasing. The broadcast UDRE value (MT4), here in meter, is stable between 6m and 7.5m with some periods at 15m.

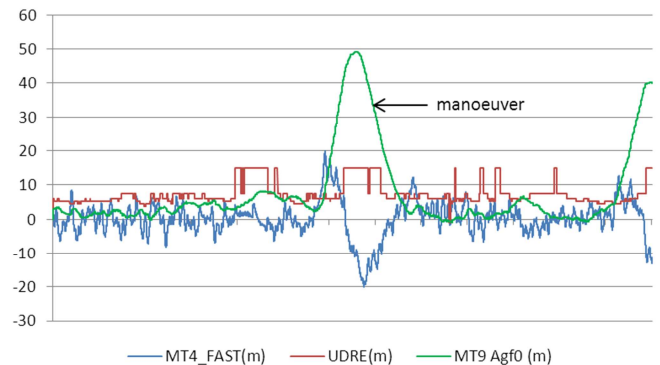

Figure 10: GEO 126 MT4 and MT9 values on 9/01/2012

Protection level (XPL) and accuracy (XPE) have been computed on two different stations, using the SBAS broadcasted messages. The figures 10 and 11 below represent the XPE and XPL with GEO Ranging (blue and

green curves) and without GEO ranging (dark blue and red curve), for Toulouse and Glasgow stations.

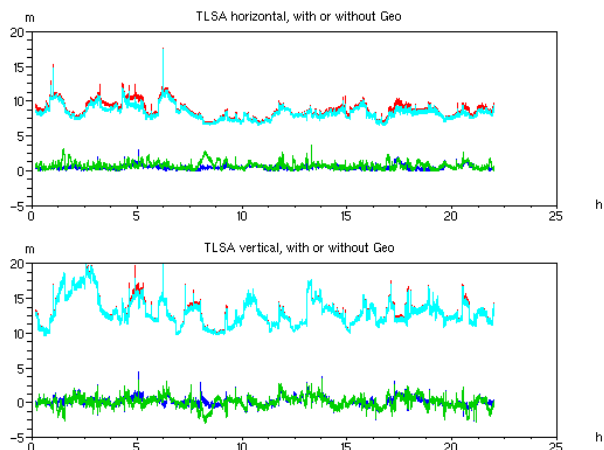

Figure 11: XPE/XPL values for Toulouse station

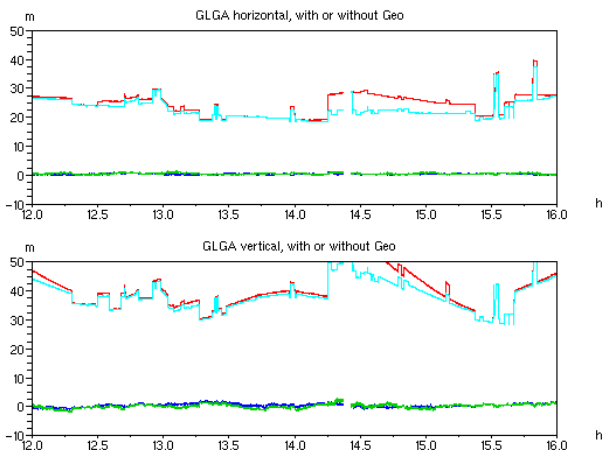

Figure 12: XPE/XPL values for Glasgow station

A small improvement on the protection level can be noticed at Glasgow, which is on the border of the ECAC service area, with the GEO utilization. Fewer satellites are being monitored by EGNOS signal on the ECAC border and therefore the GEO contribution is more important.

D. Service level area over ECAC

The 99% isoline for APV1 service level area over ECAC, with (blue) and without (green) the ranging GEO is presented on figure 13 here after. It can be seen that the increase of the area is significant when the GEO is used in the navigation solution.

On the analyzed period (9 January 2012), performance is more improved in the North than in the South, but it is partially due to excellent APV1 figures for this day: 100% availability already reached without GEO ranging over most of North Africa, rubbing out any improvement which could come from an additional GEO ranging (see figure 15).

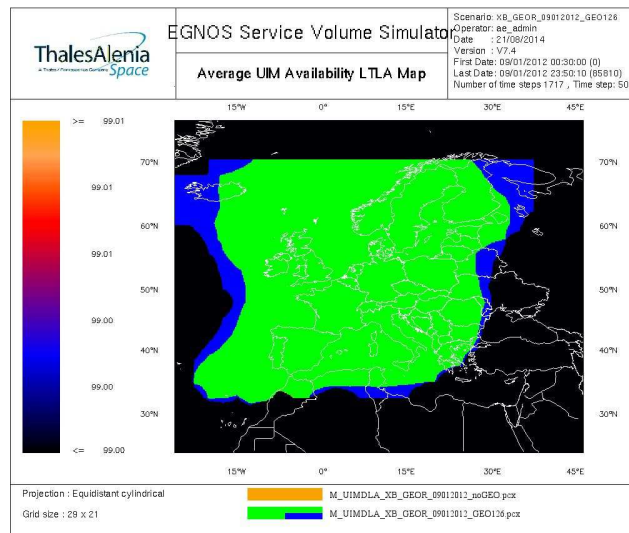

Figure 13: APV1 service area with/without GEO Ranging

APV1 availability percentage increase over the analyzed period is shown in following figure 14:

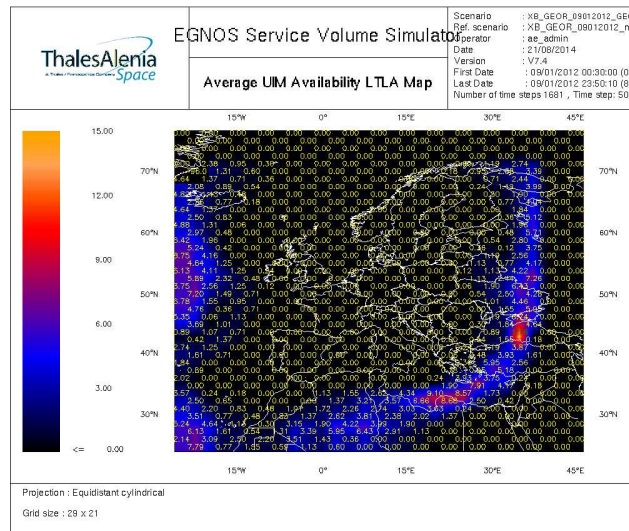

Figure 14: additional APV1 availability percentage provided by GEO126 ranging

At first sight, GEO Ranging benefit could appear as very low on main part of current EGNOS service area (i.e. Europe land masses); this is due to the fact that for the day analyzed, performance was already very good, with most of the service area showing an APV1 availability of 100%, as illustrated on figure 15 hereafter.

However, added value of GEO ranging is also to be found in performance robustness (e.g. in case of unavailability of GPS SV or RIMS stations due to maintenance activities), and future service area extensions.

For these particular aspects, sensibility analyses, to be conducted in coming EGNOS V2.4.2 phase B, will confirm benefit of GEO ranging.

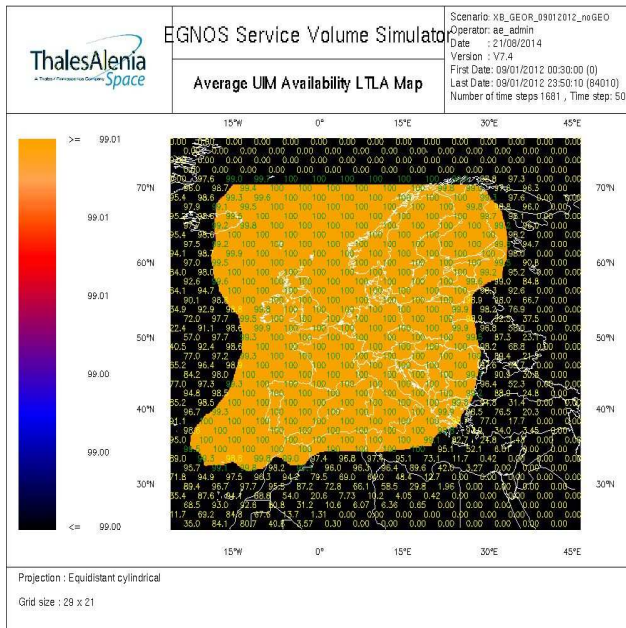

Figure 15: APV1 availability (without GEO Ranging)

7. CONCLUSIONS AND PERSPECTIVES

In conclusion, the method presented here for GEO orbit determination and based on short arc observation (1 hour duration) is convenient for satellites with electric propulsion. The broadcast UDRE value obtained is less than 15m ($UDRE_i \leq 11$), most of the time stable between 6m and 7.5m ($UDRE_i$ 9 and $UDRE_i$ 10), and this even during satellite manoeuvres. In addition, to protect against the GPS-GEO bias of the user receiver (receiver correlator bias) a margin of 0.5m has to be added in the UDRE for a signal bandwidth of 20-30MHz ([3] Appendix T). This method is also applicable with satellite using chemical propulsion for station keeping manoeuvres, and without making modifications.

This study made it possible to observe also the actual level of multipath on the geostationary satellite measurements, which does not interfere with the performance achieved so far.

The network stations used had been limited to stations with Cesium clock. With all stations, the performance will be improved.

For the perspectives, the introduction of the GEO Ranging in EGNOS is under preliminary design development as part of the on-going EGNOS V2.4.2 phase B contract. The EGNOS GEO Ranging preliminary design will be partly based on the reused of the algorithm presented in this paper. In order to effectively measure and demonstrate the achievable GEO ranging performances, some real time end to end experiments with a SBAS satellite will have also to be performed.

8. ACKNOWLEDGMENTS

The authors would like to thanks Norbert Suard, Jean Poumailloux for the fruitful technical discussions and information on EGNOS specifications, Mickael Dall'Orso for the use of SPEED platform, and Thierry Chapuis for the utilization of "SPRING" tool thanks to which we were able to compute the EGNOS mode with GEO Ranging.

9. REFERENCES

- [1] H. Secretan, F. Mercier, D. Pascal, *Robust GEO Ranging with electric propulsion satellite*, ENC 2013 symposium
- [2] *Analysis of the results of the ground segment Euridis*, ERD/NT/R/10939/CNES, 08/07/1998
- [3] *Minimum Operational Performances Standards for Global Positioning System*, RTCA DO-229-D