



HAL
open science

Design and Implementation of a Predictive Control Strategy for Power Management of a Wireless Sensor Network

Olesia Mokrenko, Maria Isabel Vergara Gallego, Warody Lombardi, Suzanne
Leseq, Diego Puschini, Carolina Albea-Sanchez

► **To cite this version:**

Olesia Mokrenko, Maria Isabel Vergara Gallego, Warody Lombardi, Suzanne Leseq, Diego Puschini, et al.
Design and Implementation of a Predictive Control Strategy for Power Management of a Wireless Sensor
Network. IEEE European Control Conference, Jul 2015, Linz, Austria. <hal-01140750>

HAL Id: hal-01140750

<https://hal.science/hal-01140750v1>

Submitted on 9 Apr 2015

HAL is a multi-disciplinary open access archive for the deposit and dissemination of scientific research documents, whether they are published or not. The documents may come from teaching and research institutions in France or abroad, or from public or private research centers.

L'archive ouverte pluridisciplinaire **HAL**, est destinée au dépôt et à la diffusion de documents scientifiques de niveau recherche, publiés ou non, émanant des établissements d'enseignement et de recherche français ou étrangers, des laboratoires publics ou privés.



HAL Authorization

Design and Implementation of a Predictive Control Strategy for Power Management of a Wireless Sensor Network

Olesia Mokrenko¹, Maria Isabel Vergara-Gallego¹, Warody Lombardi¹, Suzanne Lesecq¹, Diego Puschini¹, and Carolina Albea²

Abstract—Technological advances have made wireless sensor nodes cheap and reliable enough to be brought into various application domains. The limited energy capacity of sensor nodes is the key factor that restricts their lifespan. In this paper, a Predictive Control strategy for Dynamic Power Management of a set of wireless sensor nodes is proposed. The control formulation is based on Model Predictive Control with constraints and binary optimization variables, leading to a Mixed Integer Quadratic Programming problem. The control algorithm proposed guarantees services and performances levels with a minimum number of active nodes and/or a minimum load on such components. The strategy is evaluated on a real test-bench with wireless sensor nodes equipped with batteries and harvesting systems. Experimental results show the effectiveness of the control method proposed.

I. INTRODUCTION

Wireless sensor networks (WSNs) consist in a (large) number of sensor nodes (SNs) with sensing, wireless communication and computation capabilities, in order to monitor and/or control the physical world. WSNs have found applications in a wide range of domains, including (among others) structural health monitoring, building automation, military surveillance, and bio-medical health monitoring [1]. Usually, SNs are tiny devices with very limited energy capacity stored in batteries. They may also harvest energy from the environment. These SNs can possess several functioning modes with different capabilities (in terms of e.g. communication and computing) and associated power consumption. Their energy efficiency is a major concern as some application domains advocate for lifespan of at least 10 years without battery replacement [2].

Each SN typically includes four subsystems (SSs) namely, a *sensing SS* with one or several sensors, a *computing SS* that provides intelligence (includes Microcontroller Unit (MCU)) to the SN, a *communication SS* with a radio unit, and a *power supply SS*, which is the source of energy. It possesses a battery and sometimes a harvesting system (see Figure 1).

The network lifespan is defined as the time interval the network is able to perform the sensing function and to transmit data to the sink. Various studies have been conducted to increase the WSN lifespan in different levels and directions. For instance, at the SN level, [2] and [4] propose to switch-off the SN or reduce its power consumption when it no

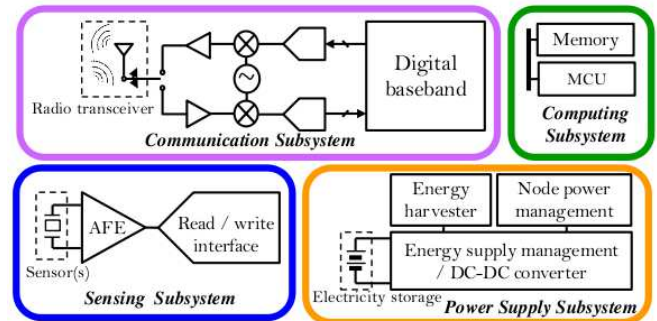

Fig. 1: Functional subsystems of a wireless SN (modified from [3])

longer performs useful tasks, therefore increasing lifespan. Indeed, supplying nodes by the batteries is certainly a major obstacle to a wide public acceptance of WSN because the SN lifespan is not as expected. Moreover, this may influence the reliability of the application (monitoring and/or control) built on top of the WSN. As a consequence, nodes have to be designed with stringent power consumption constraints [1] and equipped, when possible, with energy harvesting sources [5]. However if each SS in the SN is designed to be power efficient, their association does not necessarily lead to a low-power SN. Therefore, a power/energy management policy for the whole SN is mandatory. Note that most of these policies suppose that the sensing SS consumes significantly less energy than the communication SS (especially in transmission mode). However, when “energy-hungry” sensors [6] are embedded, an efficient energy management policy must be implemented to ensure the whole WSN performs the functionality it is supposed to. This global power/energy management policy is certainly a more complex problem than the one dedicated to a single node because, in essence, the WSN is spatially distributed, usually with a clock frequency in each node not (properly) synchronized with the other ones.

Power control in a WSN using multiple-description coding is addressed in [7] and [8]. Their main contribution is to investigate the role of dynamic power control and coding when state estimation is considered. The control objective tries to counteract the channel variability (i.e. ensure Quality of Service (QoS)) and to trade-off battery use for estimation accuracy. The controller is located in a gateway. It decides upon the transmission power level and the coding scheme to be used by each SN. However, satisfying the QoS does not

¹Univ. Grenoble Alpes, F-38000 Grenoble, France and CEA, LETI, MINATEC Campus, F-38054 Grenoble, France {FirstName.LastName}@cea.fr

²CNRS, LAAS, 7 avenue du Colonel Roche, F-31400 Toulouse, France and Univ. of Toulouse, UPS, LAAS, F-31400, Toulouse, France calbea@laas.fr

guarantee that the “mission” [9] is satisfied.

The main goal of this paper is to extend the lifespan of a WSN by reducing the overall energy consumption of the SNs via an appropriate management of the functioning modes of each SN, in order to provide a given functionality, hereafter named *mission*, under performance constraints. The *mission* is expressed as a set of constraints on the different functioning modes of each SN. The power management strategy is applied at the WSN and SN levels. The SNs are equipped with harvesting systems. The control strategy is initially proposed in [10] and extended hereafter to be evaluated on a real test-bench.

In the present work, Model Predictive Control (MPC) is considered as a promising control strategy for power management. It is based on predicting the system trajectories over a receding horizon, while calculating an optimal control policy with respect to a set of constraints [11]. It can be applied to linear Single-Input-Single-Output and Multiple-Input-Multiple-Output systems [12], [13], nonlinear [14] and hybrid [15] systems. This last class of systems can present continuous (and sampled) states (real-set variables), discrete and state-machine states (integer-set variables) and logic rules (binary-set variables) [16]. The optimization involved in this case is known as *Mixed Integer Programming* (MIP) problem.

The paper is organized as follows. Section II is first dedicated to the system modelling. Then the control objectives are provided. The control design is developed in Section III. It is based on Constrained Predictive Control techniques, with bounded states, equality and inequality constraints and binary control values. Section IV implements the proposed control on a real test-bench. Section V summarizes the main results.

Notations: Throughout the paper \mathbb{N}^* denotes the set of natural numbers where $\mathbb{N}^* = \mathbb{N} \setminus \{0\}$. $A \in \mathbb{R}^{d \times l}$ is a matrix of size $d \times l$ with real values. $\mathbf{x} \in \mathbb{R}_+^d$ is a vector of size $d \times 1$ with non-negative real values. $\mathbf{u} \in \{0, 1\}^{dl}$ represents the vector \mathbf{u} of dimension $dl \times 1$ whose elements are the binary (0 or 1) variables. The identity matrix of size $n \times n$ is described by \mathbf{I}_n , and the null matrix of size $n \times n$ is $\mathbf{0}_{n \times n}$.

II. SYSTEM MODELING AND CONTROL OBJECTIVES

Consider a WSN with a single-hop heterogeneous sensor network architecture [17] (see Figure 2). The SNs S_i , $i = 1 : n$, $n \in \mathbb{N}^*$ can only communicate with a centralized controller, called sink, which is responsible for monitoring and control of the overall system. All SNs are functionally equivalent: they are interchangeable but their hardware can differ, e.g. batteries, processors may be unlike. Each SN is powered by a battery and may also be equipped with a harvesting source, e.g. a solar cell. SNs can exhibit different functioning modes M_j , $j = 1 : m$, $m \in \mathbb{N}^*$, which are related to the state (on, sleep, off, etc.) of each SN subsystem, characterized by a known power consumption for a given period of time.

Consider that the energy consumption in the WSN is

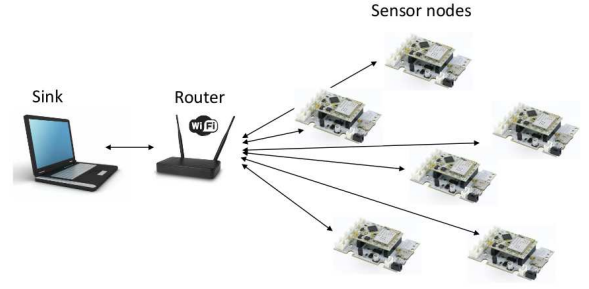

Fig. 2: Hardware architecture

TABLE I: Energy consumption of node S_i , $i = 1 : n$, in the different modes M_j , $j = 1 : m$, over the time period Δ

Sensor node	Mode M_1	Mode M_2	...	Mode M_m	
S_1	b_{11}	b_{12}	...	b_{1m}	$= B_1$
\vdots	\vdots	\vdots	\ddots	\vdots	\vdots
S_n	b_{n1}	b_{n2}	...	b_{nm}	$= B_n$

described by the linear model:

$$\mathbf{x}_{k+1} = A\mathbf{x}_k + B\mathbf{u}_k + E\mathbf{w}_k \quad (1)$$

where $\mathbf{x}_k \in \mathbb{R}_+^n$ is the remaining energy in the battery of the SNs at time k . The state matrix is $A = \mathbf{I}_n \in \mathbb{R}^{n \times n}$. $B\mathbf{u}_k$ represents the energy that will be consumed during the time interval $[k\Delta, (k+1)\Delta]$, where Δ is a time period with which the control is done. $E\mathbf{w}_k$ corresponds to the energy provided by the harvesting source. The initial battery capacity (i.e. at $k = 0$) is denoted \mathbf{x}_0 . Notice that for each node S_i , the energy capacity is constrained:

$$0 \leq x^i \leq X_{max}^i \quad (2)$$

$\mathbf{u}_k = [\mathbf{u}_1^T, \dots, \mathbf{u}_i^T, \dots, \mathbf{u}_n^T]^T \in \{0, 1\}^{nm}$ is the control input. Each sub-vector $\mathbf{u}_i = [u_{i1}, \dots, u_{ij}, \dots, u_{im}]^T$ represents the functioning mode of each S_i , where $u_{ij} \in \{0, 1\}$. As each node S_i has a unique working mode at time k , a set of constraints must be defined:

$$\forall i = 1 : n : \sum_{j=1}^m u_{ij} = 1 \quad (3)$$

The control matrix is $B = \text{diag}[-B_1, \dots, -B_n] \in \mathbb{R}^{n \times nm}$. Each component b_{ij} of B_i represents the amount of energy consumed by S_i working in mode M_j during the time period Δ (see Table I). Note that a switch from one mode to another one has an extra energy cost that is supposed to be integrated in b_{ij} .

The energy recovery element (i.e. harvesting system) $\mathbf{w}_k \in \{0, 1\}^n$ can be seen as a disturbance input that cannot be controlled but may be predicted. Actually, w_i corresponds to the ability for node S_i to harvest energy. 0 (resp. 1) is associated to the state *Off* (resp. *On*) of the harvesting system. $E \in \mathbb{R}^{n \times n}$ is the so-called disturbance matrix:

$$E = \text{diag}[E_{11}, \dots, E_{nn}] \quad (4)$$

where E_{ii} corresponds to the amount of energy harvested by S_i during the period Δ . Note that matrix E is in essence a time-variant matrix in real-life conditions.

Control objectives

In order to define the control objectives for the system, the *mission* is introduced. A *mission* is described by a minimum number $d_j \in \mathbb{N}^*$ of active SNs (corresponds to the appropriate functioning mode(s) M_j), sufficient to provide the requested services and performance levels. d_j may possibly change from time to time. Thus, the *mission* imposes a new set of constraints:

$$\sum_{i=1}^n u_{ij} = d_j \quad (5)$$

Note that hereafter, this functional constraint is supposed to indirectly ensure the desired QoS for the WSN. Therefore, the system to be controlled is not only constrained by (3), meaning that each node S_i is in a unique mode, but also by the set of extra functional constraints (5) that are used to define the *mission*.

III. MODEL PREDICTIVE CONTROL DESIGN

The minimization of the power consumption of (1) can be seen as a Constrained Optimal Control problem that can be described as a Quadratic Programming (QP) problem. Constrained MPC implies the minimization of a cost function based on the predicted system evolution.

Recently, the interest in using MPC for controlling systems that involve a mix of real-valued dynamics and logical rules has arisen [15] [16]. Unfortunately, when this problem is formulated as an optimization one, the resulting description is no longer a QP problem but a Mixed Integer Quadratic Programming (MIQP) problem with two different types of optimization variables, namely, real-valued and binary ones. This makes this latter problem harder to solve when compared to an ordinary QP problem.

It is assumed throughout the rest of the paper that the pair (A, B) in (1) is stabilizable. At each decision time $k\Delta$, the current state (assumed to be available) $\mathbf{x}_k = \mathbf{x}_{k|k}$ is used to define the optimal control sequence $\mathbf{u}^* = [\mathbf{u}_{k|k}^T, \dots, \mathbf{u}_{k+N_p-1|k}^T]^T$ which is the assumed as the minimization problem:

$$\mathbf{u}^* = \arg \min_{\mathbf{u}} \sum_{i=0}^{N_p-1} \mathbf{x}_{k+i|k}^T Q \mathbf{x}_{k+i|k} + \sum_{i=0}^{N_u-1} \mathbf{u}_{k+i|k}^T R \mathbf{u}_{k+i|k}$$

subject to:

$$\begin{cases} \mathbf{x}_{k+i+1|k} = A\mathbf{x}_{k+i|k} + B\mathbf{u}_{k+i|k}, & i = 1, \dots, N_p - 1 \\ \mathbf{u}_{k+i|k} = \mathbf{0}, & i = N_u, N_u + 1, \dots, N_p - 1 \\ \mathbf{u}_{k+i|k} \in \{0, 1\}^{nm} \\ \mathbf{X}_{min} \leq \mathbf{x}_{k+i|k} \leq \mathbf{X}_{max}, & i = 1, \dots, N_p - 1 \end{cases} \quad (6)$$

where $Q = Q^T \geq 0$ and $R = R^T > 0$ are weighting matrices, \mathbf{X}_{min} and \mathbf{X}_{max} are the lower and upper energy

capacity bounds, respectively, and the pair $(Q^{1/2}, A)$ is detectable.

Define an extended vector $\mathbf{x} = [\mathbf{x}_{k+1|k}^T, \dots, \mathbf{x}_{k+N_p|k}^T]^T$ that contains the predicted states involved in the optimization problem (6):

$$\mathbf{x} = \Phi \mathbf{x}_{k|k} + \Gamma \mathbf{u}$$

$$\Phi = \begin{bmatrix} A & & & & \\ A^2 & & & & \\ \vdots & & & & \\ A^{N_p} & & & & \end{bmatrix}, \quad \Gamma = \begin{bmatrix} B & 0 & \dots & 0 \\ AB & B & \dots & 0 \\ \vdots & \vdots & \ddots & \vdots \\ A^{N_p-1} & A^{N_p-2} & \dots & A^{N_p-N_u} \end{bmatrix}$$

Then, the optimisation cost function is rewritten in a matrix form and (6) is described as a MIQP (see e.g. [13]):

$$\arg \min_{\mathbf{u}} \mathbf{u}^T H \mathbf{u} + 2\mathbf{u}^T F \mathbf{x}_{k|k}$$

subject to:
$$\begin{cases} \mathbf{u} \in \{0, 1\}^{nmN_u} \\ \bar{F}_{in_x} \Gamma \mathbf{u} \leq \bar{G}_{in_x} - \bar{F}_{in_x} \Phi \mathbf{x}_{k|k} \\ \bar{F}_{equ} \mathbf{u} = \bar{G}_{equ} \end{cases} \quad (7)$$

where $H = \Gamma^T \bar{Q} \Gamma + \bar{R}$ and $F = \Gamma \bar{Q} \Phi$, $\bar{Q} = \text{diag}[Q, \dots, Q]$, $\bar{R} = \text{diag}[R, \dots, R]$. The inequality and equality constraints (2), (3) and (5) on $\mathbf{x}_{k|k}$ and $\mathbf{u}_{k|k} \forall k$, are fully described by $\bar{F}_{in_x} \in \mathbb{R}^{s \times n}$, $\bar{G}_{in_x} \in \mathbb{R}^s$, $\bar{F}_{equ} \in \mathbb{R}^{p \times r}$ and $\bar{G}_{equ} \in \mathbb{R}^p$, $p = (N_p - N_u)nm$, $r = N_p nm$, $s = N_p q$.

It is worth mentioning that the degrees of freedom of the control design are related to the choice of the weighting matrices Q and R , and the prediction N_p and control $N_u \leq N_p$ horizons.

IV. IMPLEMENTATION

The control strategy described above is now implemented in a real-life test-bench in order to evaluate the proposed power management strategy and assess the efficiency of the controlled system. The hardware and software aspects of the test-bench are first shortly described. Then, implementation issues of the control approach are discussed. Lastly, the experimental results are pursued.

A. Test-bench description

The hardware test-bench considered here, with a sink, a router, and $n = 6$ sensor nodes S_i , is shown in Figure 2. The sink is a laptop equipped for communication with a Wi-Fi card. The router allows data exchanges between the sink and the SNs. The SNs are connected with Flyport WiFi 802.11g modules developed by openPicus [18]. The Flyport WiFi 802.11g module is a programmable system-on-module with integrated WiFi 802.11g connectivity. Its typical current consumption are shown in Table II. The energy battery level of the nodes can be measured. The sensing elements are temperature & humidity sensors DHT-11 [19].

At time k , node S_i can work in a unique mode. In the present case, $m = 3$ functioning modes M_j are defined. This choice is a trade-off between ensuring the system performance and the energy consumption minimization. It is similar to the choice in [20] and [21]. The modes are described as follows (see also Table III):

TABLE II: Current consumption of different components in Flyport WiFi [18]

Module	Current	Remarks
Wi-Fi not connected	39,75 mA	MCU ON and Wi-Fi on but not connected
Wi-Fi connected	162,70 mA	MCU ON and Wi-Fi infrastructure mode connected to an access point
Wi-Fi burst	282,50 mA	RF Burst on data TX
Hibernate mode	28,21 mA	MCU ON and Wi-Fi transceiver OFF
Sleep mode	1,44 mA	MCU OFF and Wi-Fi transceiver OFF

TABLE III: Functioning modes for node S_i

Mode	Processor	Radio	Sensor(s)	Battery monitor
M_1	Active	Tx, Rx	On	On
M_2	Sleep	Off	Off	Off
M_3	Off	Off	Off	Off

- M_1 is the *Active* mode. In this mode, sensing, computing and communication SSs are “duty cycled” (see Figure 3), each SS being off by default and entering a wake-up mode periodically with a sampling period $T_s = 1min$ to sense, process and exchange data with the sink. Note that the duty cycle is itself split in smaller duty cycles, allowing more control of the node energy consumption in the *Active* mode. Figure 4 shows the typical current consumption of the SN working in mode M_1 . The waveform corresponds to a wireless SN application cycle: the node is awake from the sleep state. It collects data and prepares the packets to be transmitted. Then, the packets are sent to the sink.
- M_2 corresponds to the *Standby* mode. The duty cycle of this mode is depicted in Figure 3. In the sleep state, only a small part of the processor is active, corresponding to the Real Time Clock (RTC) Quartz system. The RTC allows to wake up the SN each $T_w = 1h$ to receive the commands from the sink and monitor the battery remaining capacity.
- M_3 is the *Faulty* mode. During the network lifespan, some nodes may become unavailable (due to e.g. physical damage, lack of power resources $X_0^i \setminus X_{max}^i \leq \delta$) or additional nodes might be deployed in the faulty SN state. The SN can exit from this mode when for instance, the battery is recharged by the harvesting system ($X_0^i \setminus X_{max}^i > \delta$) or the physical damages are repaired. δ is defined for each battery and depends on its characteristics.

Mission definition

For this test-bench, $n = 6$ SNs have been deployed in a working office. In order to regulate the air conditioning system, temperature and humidity are sensed through the WSN. During the day, when the office is in use, a good quality of measures can be achieved with 3 SNs. During the night, 1 SN is enough to sense the temperature and humidity in the office unused. Precisely, the *mission* is split in two

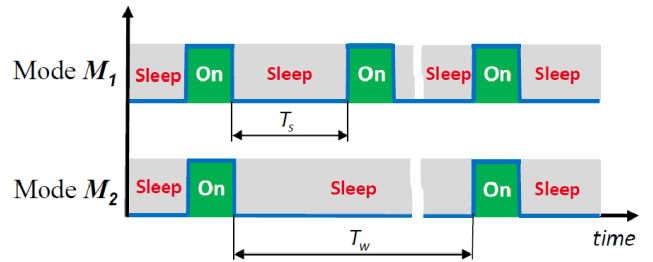

Fig. 3: Duty cycles of M_1 and M_2 modes

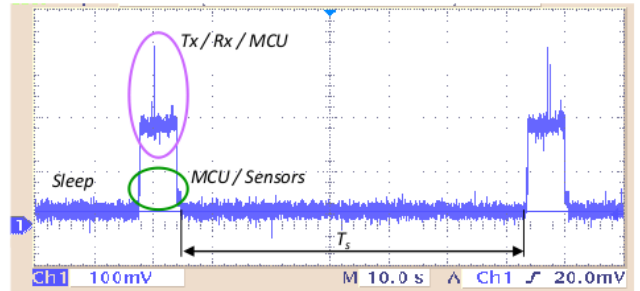

Fig. 4: Waveform of a cycle for our SN working in mode M_1 (current consumption measured with resistance of 1Ω)

phases corresponding respectively to day and night periods of time. Therefore, the constraints that define the *mission* have to be dynamically changed, depending on the time schedule, leading to a *dynamic mission*:

Time period	d_1	Objectives
Day 8am–6pm	3	3 nodes in M_1
Night 6pm–8am	1	1 nodes in M_1

Consider that at time instant k_0 all the SNs of the system are *Active* (in mode M_1). It is necessary to transmit their initial energy battery level and receive the control from sink. Then a sink checks whether that the node batteries have enough energy so that any node S_i can fulfill the *mission* (i.e. being in mode M_1). If this is the case, during the day period, 3 nodes will be placed in mode M_1 while the $n - 3$ others will be placed in M_2 . And during the night period, 1 SN will be placed in mode M_1 and $n - 1$ will be placed in mode M_2 . As soon as the relative battery capacity of a SN is lower than δ or SN has other faulty, this SN will fall in mode M_3 . Then, the control law assigns new modes to the remaining nodes in order to meet the dynamic *mission* while minimizing the energy consumption of the sensor network.

B. Control application

Two control methods can be applied when a sensor falls in mode M_3 . First, a hybrid model can be considered to switch from one model to another when a node mode changes [22]. The second method is based on Fault-tolerant Control (FTC) approaches [23]. In this case, the set of constraints is modified, this second approach is used in the present paper.

For the system (1), $A = \mathbf{I}_6$ while the components of matrix B are calculated from the values given in Table

TABLE IV: Power consumption B_{ij} ($mA \cdot h$) of node S_i in mode M_j

Sensor node	Mode M_1	Mode M_2	Mode M_3
S_1	9.42	1.58	0
S_2	9.88	1.65	0
S_3	9.86	1.63	0
S_4	9.86	1.63	0
S_5	9.70	1.65	0
S_6	8.93	1.55	0

TABLE V: SN battery characteristics and harvesting capability

Sensor node	Battery Type	Nominal Voltage [V]	Battery capacity X_{max}^i [mA·h]	Harvesting availability E_{ii} [mA·h]
S_1	LiPo	3.7	1100	missing
S_2	LiPo	3.7	1100	missing
S_3	LiPo	3.7	1100	270
S_4	LiPo	3.7	950	missing
S_5	LiPo	3.7	950	270
S_6	LiPo	3.7	2300	missing

IV, multiplied by the battery nominal voltage value of the corresponding SN (see Table V where the battery characteristics associated with each node are provided). Note that the numerical values are derived from Table II and lab. measurements. Table V also provides the initial capacity of the batteries associated with each SN. These latter numerical values are obtained from the technical data sheet of Li-polymer rechargeable batteries [24] and solar cells [25].

The weighting matrices Q and R that appear in the definitions of \bar{Q} and \bar{R} in (7) are chosen equal to:

$$Q = \mathbf{0}_{6 \times 6}; \quad R = B^T \times ((Ru^T \times Ru)/2) \times B \quad (8)$$

where

$$Ru = \text{diag} \left[\begin{bmatrix} ru_1 & 0 & 0 \\ 0 & ru_1 & 0 \\ 0 & 0 & ru_1 \end{bmatrix}, \dots, \begin{bmatrix} ru_6 & 0 & 0 \\ 0 & ru_6 & 0 \\ 0 & 0 & ru_6 \end{bmatrix} \right]$$

and $ru_i \triangleq \min\{X_{max}^i/x_{k|k}^i\}$, $x_{k|k}^i \neq 0$. The choice $Q = \mathbf{0}_{6 \times 6}$ lies in the fact that the state dynamics should evolve as slowly as possible [26]. The choice of R implies a trade-off between bigger energy consumption and smaller energy battery level for node penalization. This choice allows to keep the same battery power level in all SNs.

The inequality constraints (2) become:

$$\underbrace{\begin{bmatrix} \mathbf{I}_6 \\ -\mathbf{I}_6 \end{bmatrix}}_{F_{in_x}} \begin{bmatrix} x_1 \\ \vdots \\ x_6 \end{bmatrix} \leq \underbrace{\begin{bmatrix} X_{max}^1 & \dots & X_{max}^6 & 0 & \dots & 0 \end{bmatrix}^T}_{G_{in_x}} \quad (9)$$

while the equality constraints (3) and (5) are defined as:

$$\underbrace{\begin{bmatrix} 1 & 1 & 1 & \dots & 0 \\ \vdots & \ddots & \vdots & & \\ 0 & \dots & 1 & 1 & 1 \end{bmatrix}}_{F_{equ}^1} \begin{bmatrix} u_{1j} \\ \vdots \\ u_{6j} \end{bmatrix} = \underbrace{\begin{bmatrix} 1 \\ \vdots \\ 1 \end{bmatrix}}_{G_{equ}^1} \quad (10)$$

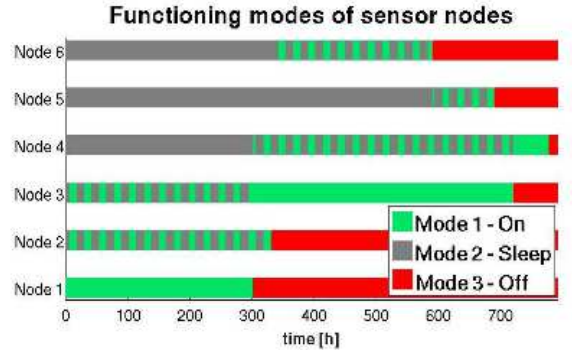

Fig. 5: Functioning modes of sensor nodes vs. time

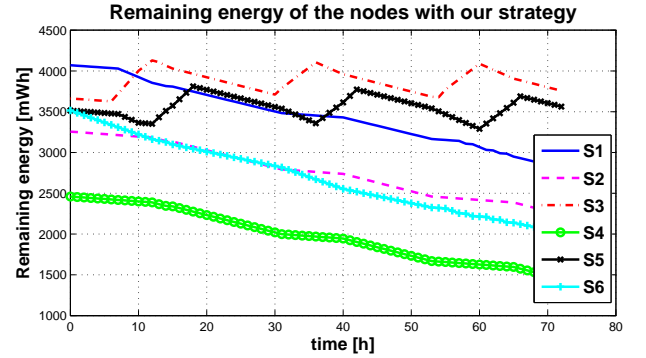

Fig. 6: Energy harvesting availability with harvesting

$$\underbrace{\begin{bmatrix} 1 & 0 & 0 & \dots & 1 & 0 & 0 \\ 0 & 1 & 0 & 0 & 1 & 0 & 0 \\ 0 & 0 & 1 & 0 & 0 & 1 & 0 \end{bmatrix}}_{F_{equ}^2} \begin{bmatrix} u_{1j} \\ \vdots \\ u_{6j} \end{bmatrix} = \underbrace{\begin{bmatrix} a \\ b \\ c \end{bmatrix}}_{G_{equ}^2} \quad (11)$$

where a and b correspond to the number of nodes in modes M_1 and M_2 , respectively. During daytime $a = 3$ and at night $a = 1$, see a mission definition. c corresponds to the number of nodes fallen in mode M_3 with $c = n - a - b$. The other matrices are defined as follows: $F_{equ} = [F_{equ}^1 \ F_{equ}^2]^T$; $G_{equ} = [G_{equ}^1 \ G_{equ}^2]^T$; $\bar{F}_{equ} = \text{diag}[F_{equ}, \dots, F_{equ}]$, $\bar{G}_{equ} = \text{diag}[G_{equ}, \dots, G_{equ}]$, $\bar{F}_{in_x} = \text{diag}[F_{in_x}, \dots, F_{in_x}]$, $\bar{G}_{in_x} = \text{diag}[G_{in_x}, \dots, G_{in_x}]$. The prediction and control horizons are chosen equal to $N_p = 5$, $N_u = 1$ respectively. As the considered system presents slow dynamics, these horizons are enough. The decision period (i.e. the time period when the power control is run) is $\Delta = T_w = 1h$. Thus, the MIQP problem is solved on-line at each decision time $k\Delta$.

The power control of the WSN considered is written in Python. The MIQP problem is solved with PICOS [27] using the Mosek solver [28]. Coordination between the SNs and sink is realized via the LINC coordination environment [29].

C. Experimental Results

The application results are provided in Figure 5 where for each SN, its associated mode imposed by the proposed

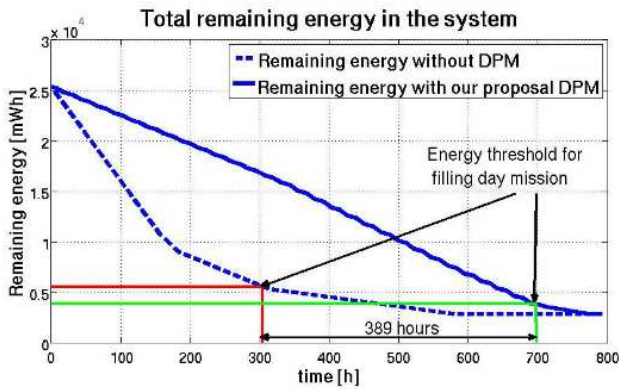

Fig. 7: Total energy evolution comparison (with and without our control strategy)

control strategy can be seen. The simulation lasts only two cycles (2×24 -hour), but it is still enough to see the system evolution. The *mission* can be fulfilled at each time until at least 3 nodes do not have their batteries drained or have not faultily (i.e. a communication problem). The remaining battery energy states are presented in Figure 6. Note that some of the SNs have harvesting system as a solar cell. This explains the increase of the remaining energy level during a day period of time, when the sun is shining. Other harvesting profiles may lead to change the system lifespan and distribution of the *Active* SNs.

Figure 7 illustrates the comparison the total remaining energy in the system with our proposal control strategy and without it, i.e. with use the usual communication scheme. It is when each SN works in mode M_1 . We can see, that the proposed control expands the WSN lifespans by 95% with given harvesting capability of SNs compared to the usual scheme.

V. CONCLUSIONS AND FUTURE RESEARCH

Energy-efficiency is an important issue in WSNs, because battery resources are limited. Mechanisms that preserve the energy resources are highly desirable, as they have a direct impact on the network lifetime.

In this paper, a power consumption control strategy for a WSN has been proposed. The energy in the sensor nodes is modeled using a linear state-space representation. Harvesting capability of the SNs is also taken into account. The WSN has to provide a given functionality (named the *mission*), expressed with a set of constraints. The control problem is defined as a MIQP one that imposes a unique functioning mode to each SN at each decision time. Implementation results in a real test-bench show the efficiency of the proposed control method. Power savings in the SNs, and in the entire WSN, of more than 95% were possible compared to without control algorithm, when all sensor nodes are in *Active* mode.

REFERENCES

[1] Ian F Akyildiz, Weilian Su, Yogesh Sankarasubramaniam, and Erdal Cayirci. Wireless sensor networks: a survey. *Computer networks*, 2002.

[2] Nagendra Prasad Mandru. Optimal power management in wireless sensor networks for enhanced life time. *Journal of Global Research in Computer Science*, 3:73–78, 2012.

[3] Fred Chen, Fabian Lim, Omid Abari, Anantha Chandrakasan, and Vladimir Stojanovic. Energy-aware design of compressed sensing systems for wireless sensors under performance and reliability constraints. *IEEE Transactions on Circuits and Systems I: Regular Papers*, 2013.

[4] Wei Hailong, Shen Yan, and Wei Tuning. Dynamic power management of wireless sensor networks based on grey model. In *Advanced Computer Theory and Engineering (ICACTE), 2010 3rd International Conference on*. IEEE, 2010.

[5] Vinod Sharma, Utpal Mukherji, Vinay Joseph, and Shrey Gupta. Optimal energy management policies for energy harvesting sensor nodes. *Wireless Communications, IEEE Transactions on*, 2010.

[6] Cesare Alippi, Giuseppe Anastasi, Mario Di Francesco, and Manuel Roveri. Energy management in wireless sensor networks with energy-hungry sensors. *Instrumentation & Measurement Magazine, IEEE*, 2009.

[7] Daniel E Quevedo, Jan Ostergaard, and Anders Ahlen. Power control and coding formulation for state estimation with wireless sensors. *Control Systems Technology, IEEE Transactions on*, 2014.

[8] Xue Jun Li, Shao Xuguang and other. Application of model predictive control in wireless sensor networks. In *Infor., Communications and Signal Processing (ICICS) 2011 8th Inter. Conf. on*. IEEE, 2011.

[9] Tom La Porta, Chiara Petrioli, and Dora Spenza. Sensor-mission assignment in wireless sensor networks with energy harvesting. In *Sensor, Mesh and Ad Hoc Communications and Networks (SECON), 2011 8th Annual IEEE Communications Society Conf. on*. IEEE, 2011.

[10] Olesia Mokrenko, Suzanne Lesecq, Warody Lombardi, Diego Puschini, Carolina Albea, and Olivier Debicki. Dynamic power management in a wireless sensor network using predictive control. In *Industrial Electronics Society, IECON 2014-40th Annual Conference of the IEEE*. IEEE, 2014.

[11] David Q Mayne, James B Rawlings, Christopher V Rao, and Pierre OM Scokaert. Constrained model predictive control: Stability and optimality. *Automatica*, 2000.

[12] Eduardo F Camacho and Carlos Bordons Alba. *Model predictive control*. Springer, 2013.

[13] Jan Marian Maciejowski. *Predictive control: with constraints*. Pearson education, 2002.

[14] Frank Allgöwer and Alex Zheng. *Nonlinear model predictive control*. Birkhäuser Basel, 2000.

[15] Alberto Bemporad and Manfred Morari. Predictive control of constrained hybrid systems. In *Nonlinear model predictive control*. Springer, 2000.

[16] Alberto Bemporad and Manfred Morari. Control of systems integrating logic, dynamics, and constraints. *Automatica*, 1999.

[17] Vivek Mhatre and Catherine Rosenberg. Homogeneous vs heterogeneous clustered sensor networks: a comparative study. In *IEEE International Conference on Communications, 2004*. IEEE, 2004.

[18] <http://www.openpicus.com>.

[19] <http://www.aosong.com/en/products/details.asp?id=109>.

[20] Paulo Sérgio Sausen, José Renato de Brito Sousa, Marco Aurélio Spohn, Angelo Perkusich, and Antônio Marcus Nogueira Lima. Dynamic power management with scheduled switching modes. *Computer Communications*, 31, 2008.

[21] Vijay Raghunathan, Saurabh Ganeriwal, and Mani Srivastava. Emerging techniques for long lived wireless sensor networks. *Communications Magazine, IEEE*, 44, 2006.

[22] Jan Lunze and Françoise Lamnabhi-Lagarigue. *Handbook of hybrid systems control: theory, tools, applications*. Cambridge University Press, 2009.

[23] Eduardo F Camacho, Teodoro Alamo, and David Muñoz de la Pena. Fault-tolerant model predictive control. In *Emerging Technologies and Factory Automation (ETFA), 2010 IEEE Conference on*. IEEE, 2010.

[24] <http://www.farnell.com/datasheets/1666650.pdf> and [1666648.pdf](http://www.farnell.com/datasheets/1666648.pdf).

[25] <https://hackspark.fr/fr/1-5w-solar-panel-81x137.html>.

[26] Robert L Williams, Douglas A Lawrence, et al. *Linear state-space control systems*. John Wiley & Sons, 2007.

[27] Picos: A python interface for conic optimization solvers, <http://picos.zib.de>. 2012.

[28] <http://www.mosek.com/>.

[29] Maxime Louvel and François Pacull. Linc: A compact yet powerful coordination environment. In *Coordination Models and Languages*. Springer, 2014.