

Solution de communication CAN over CPL pour la gestion de batteries

Jérémie JOUSSE – 17/04/14



Éclairage public autonome

- Panneaux photovoltaïques ;
- Lanterne à LED avec détecteur de présence ;
- Système de stockage d'énergie ;
- Carte électronique de gestion.



Intégration de la technologie lithium-ion

Canal de communication nécessaire entre l'Energy Management System et les Battery Management Systems

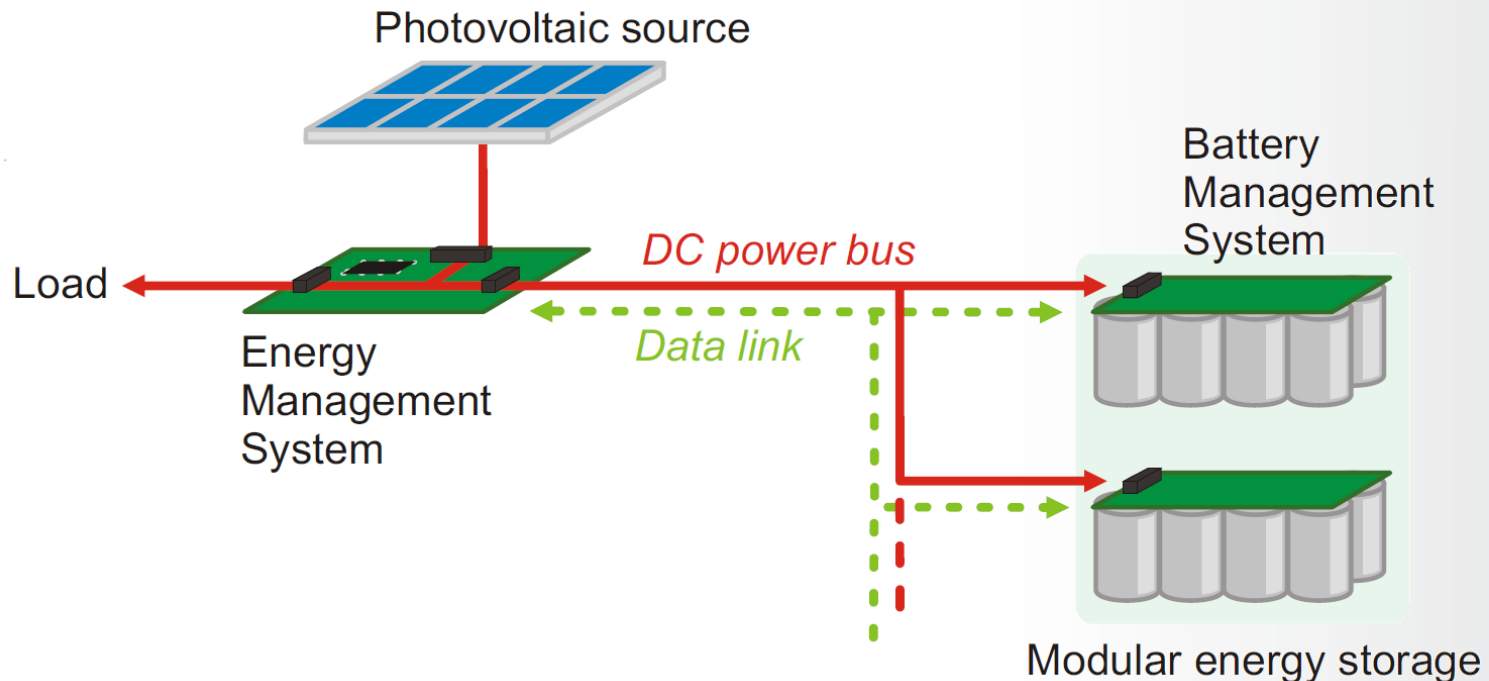

7- Layer OSI

Application
Presentation
Session
Transport
Network
Data Link
Physical

Logical Link Control (LLC) - Acceptance filtering - Overload notification - Recovery management
Medium Access Control (MAC) - Data encapsulation/decapsulation - Frame coding (stuffing/de-stuffing) - Error detection/signaling - Serialization/deserialization
Physical Signaling - Bit encoding/decoding - Bit timing/synchronization
Physical Medium Attachment - Driver/receiver characteristics
Medium Dependent Interface - Connectors/wires

CAN protocol

Defined by	CAN Controller	
	Standard transceiver	PLC modem
ISO11898	Differential pair	PLC medium

PLC-CAN
 innovation

Principe de fonctionnement

- Bus CAN sur paire différentielle :

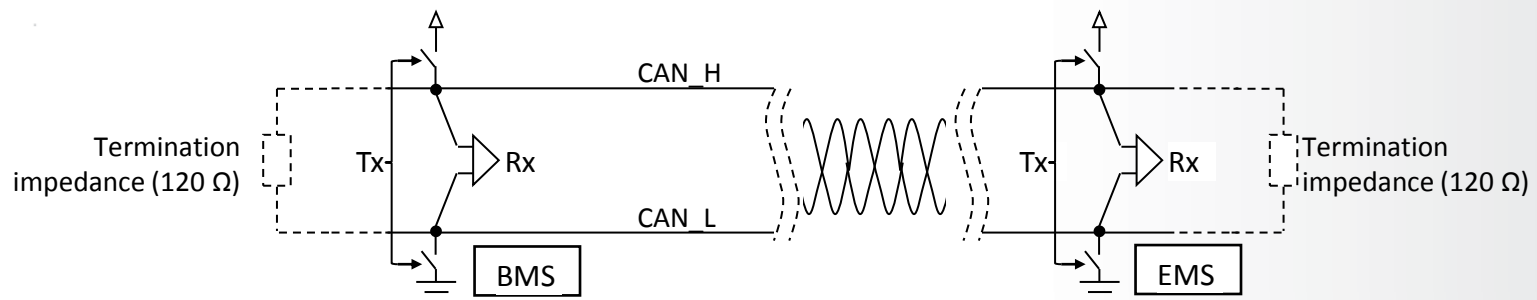

- Solution CAN-CPL proposée :

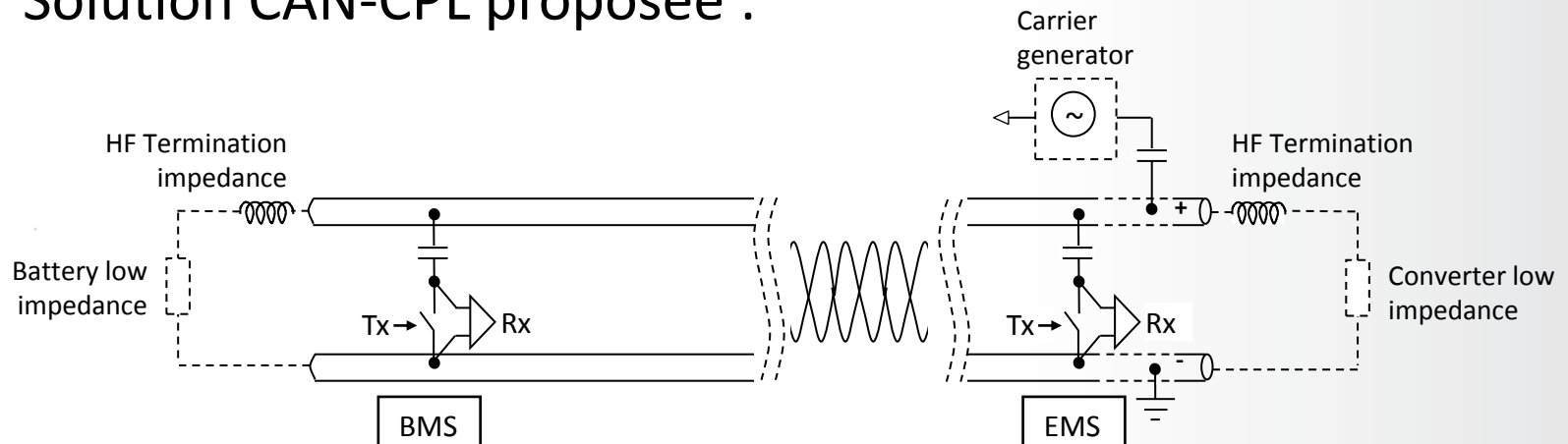

Principe de fonctionnement

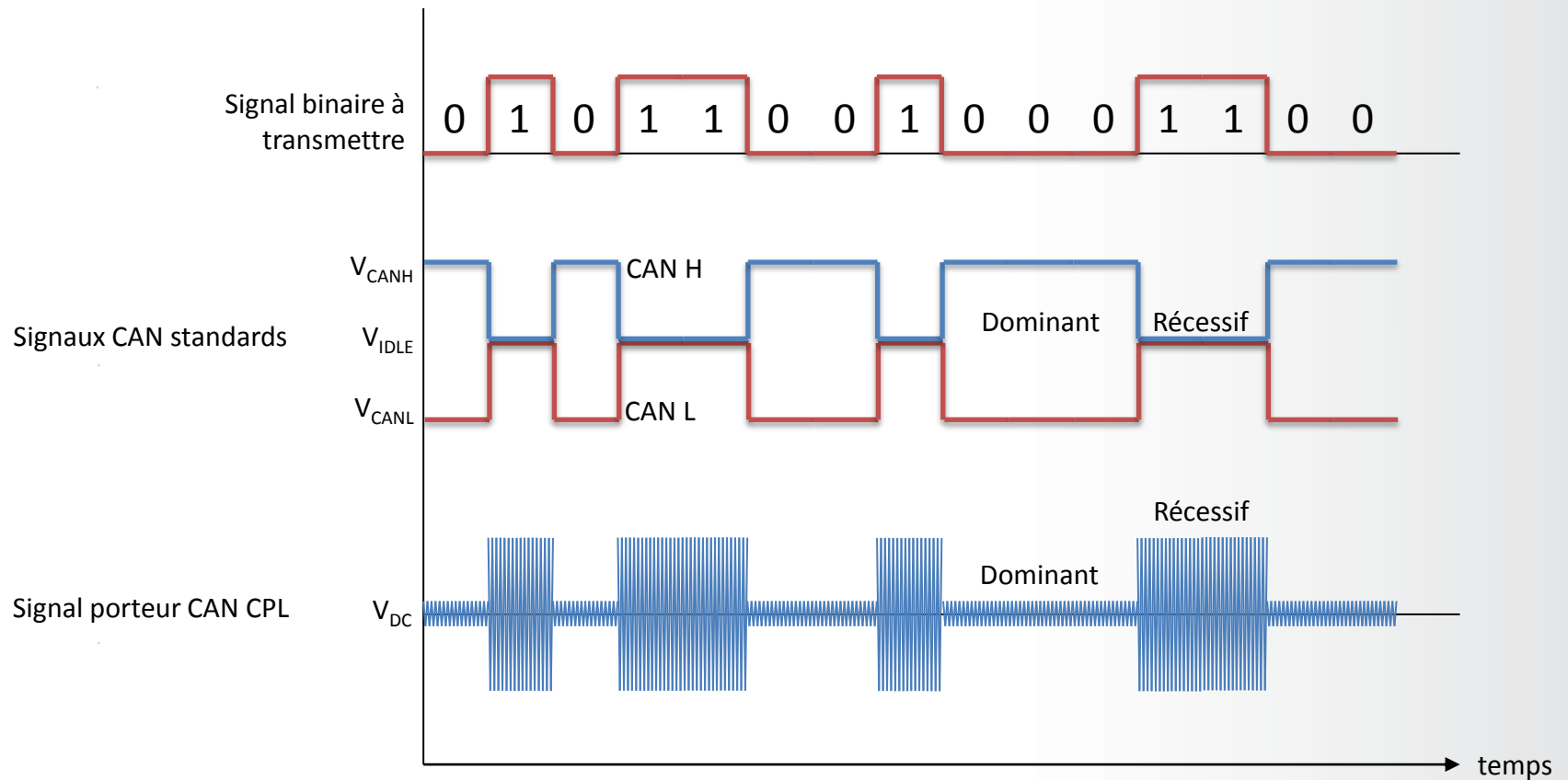

Modélisation du canal de communication

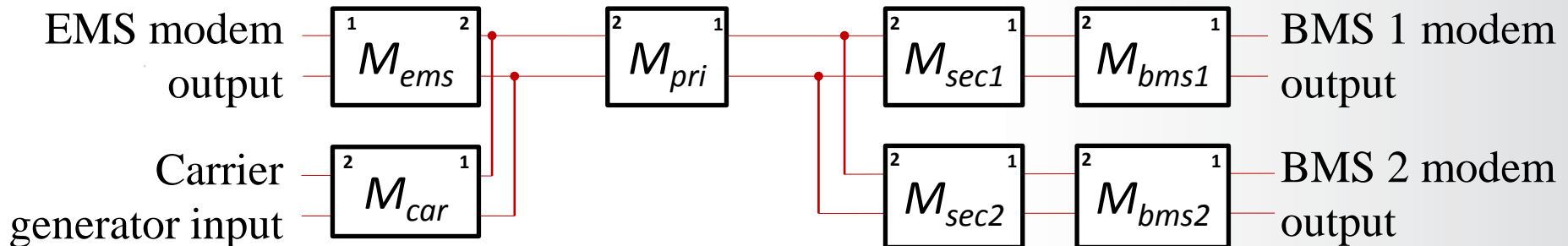
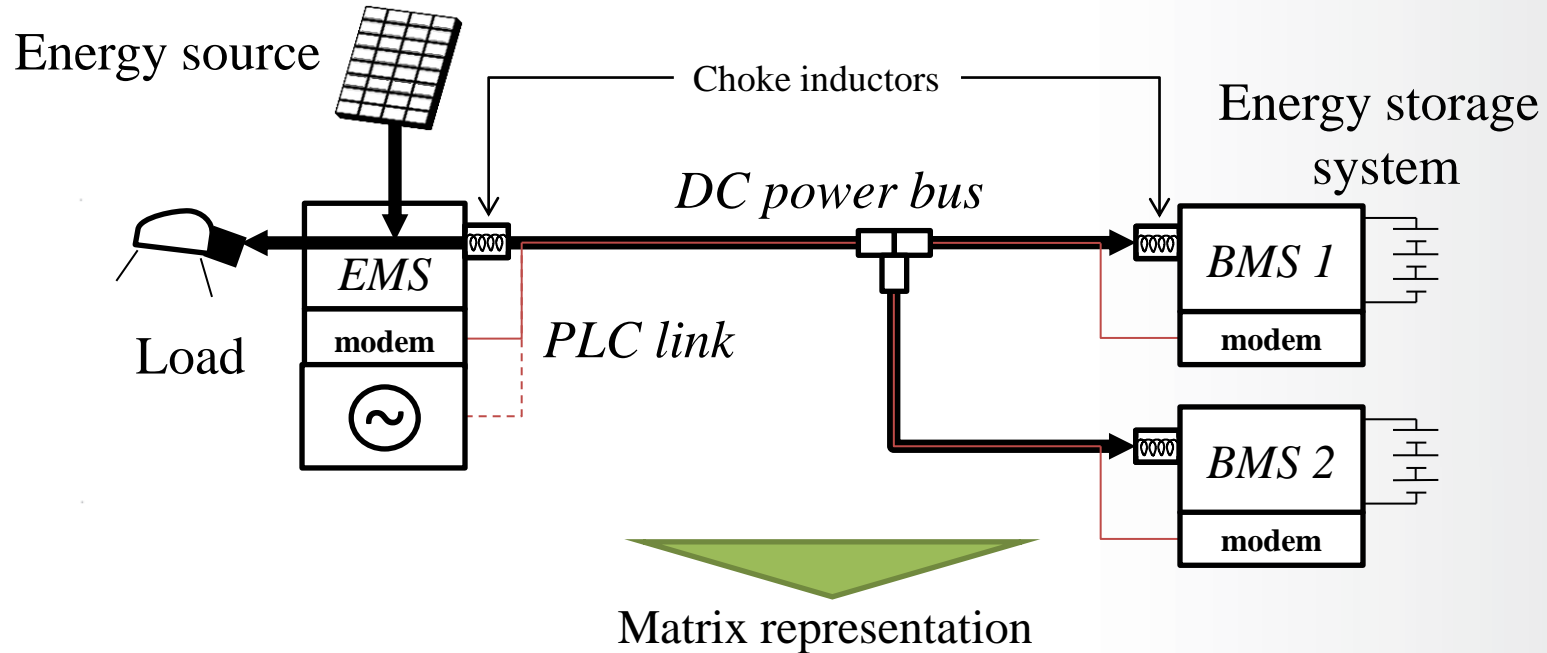

Modélisation du canal de communication

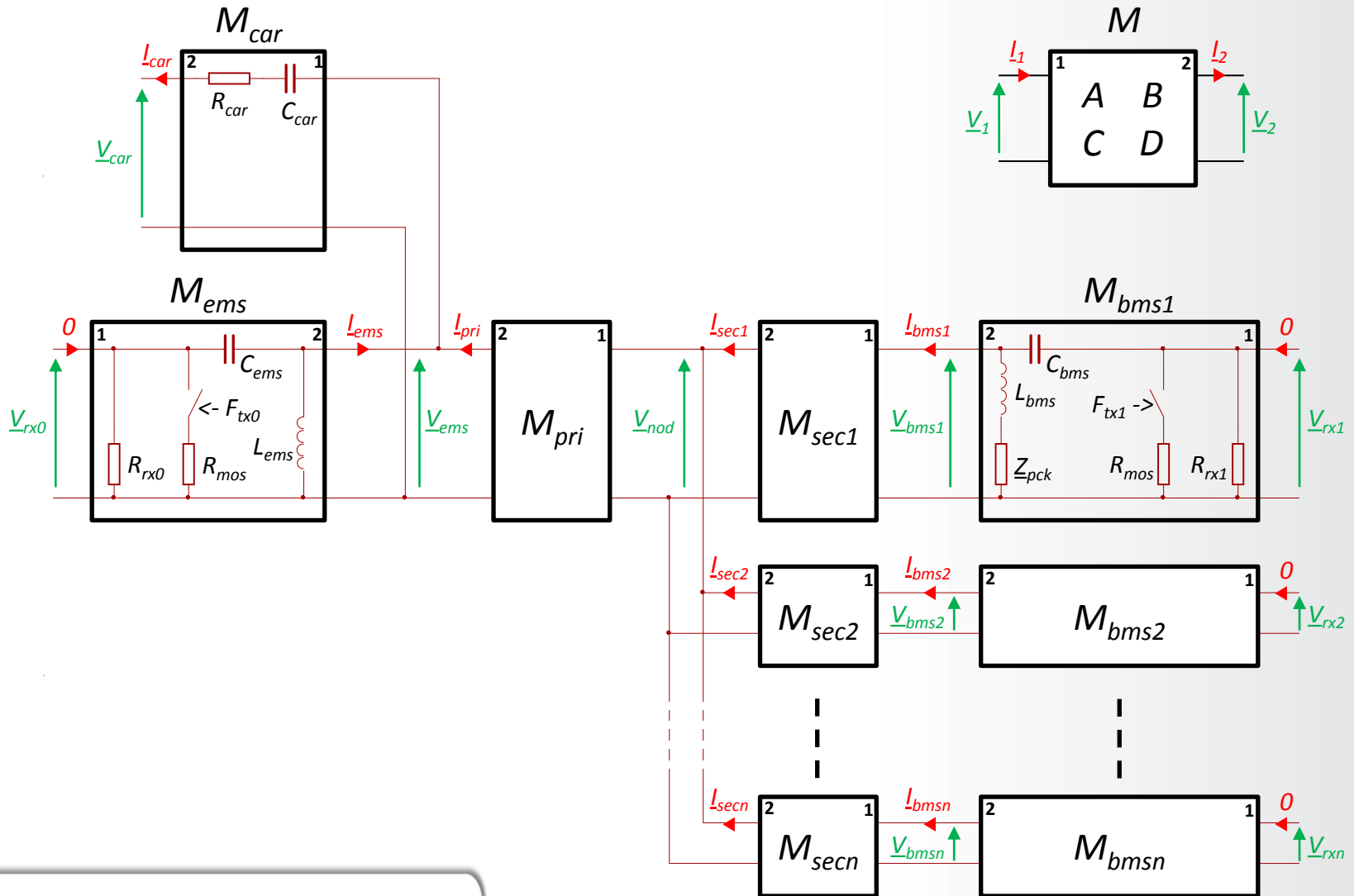

Modélisation du canal de communication

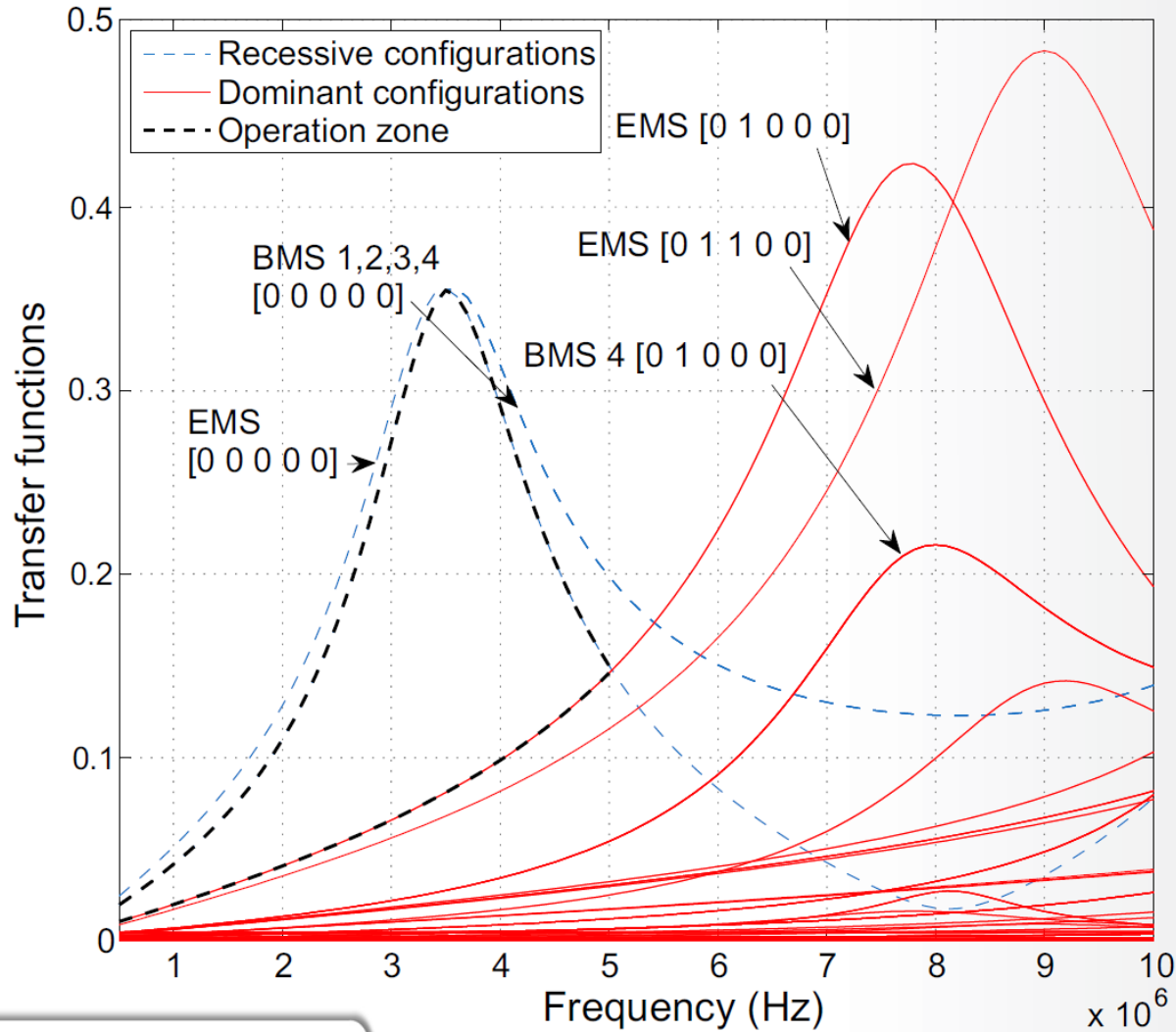

Prototypage et résultats expérimentaux

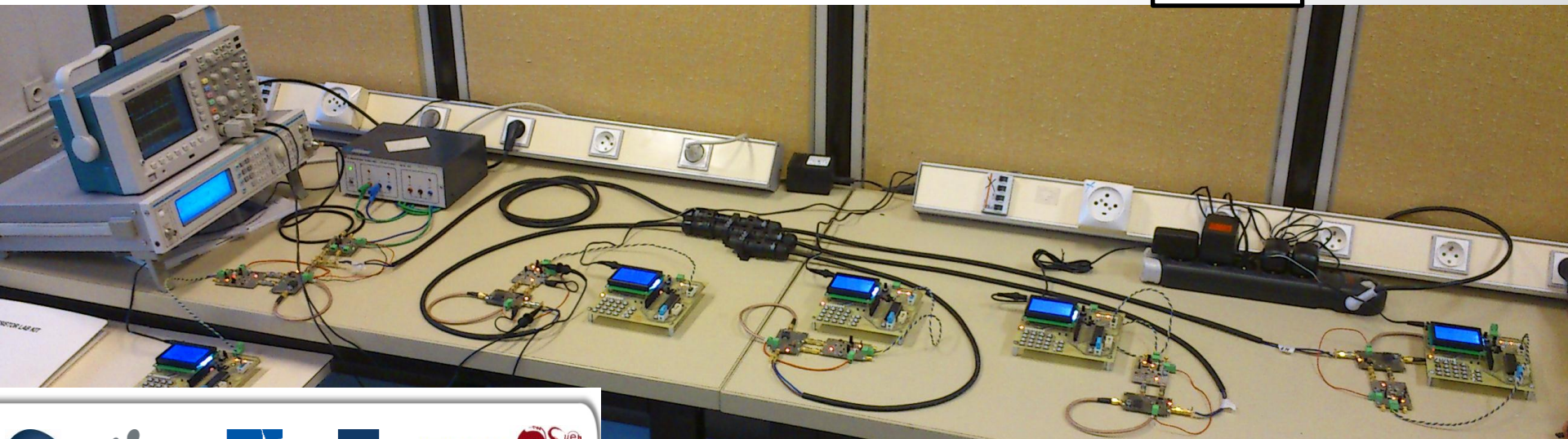
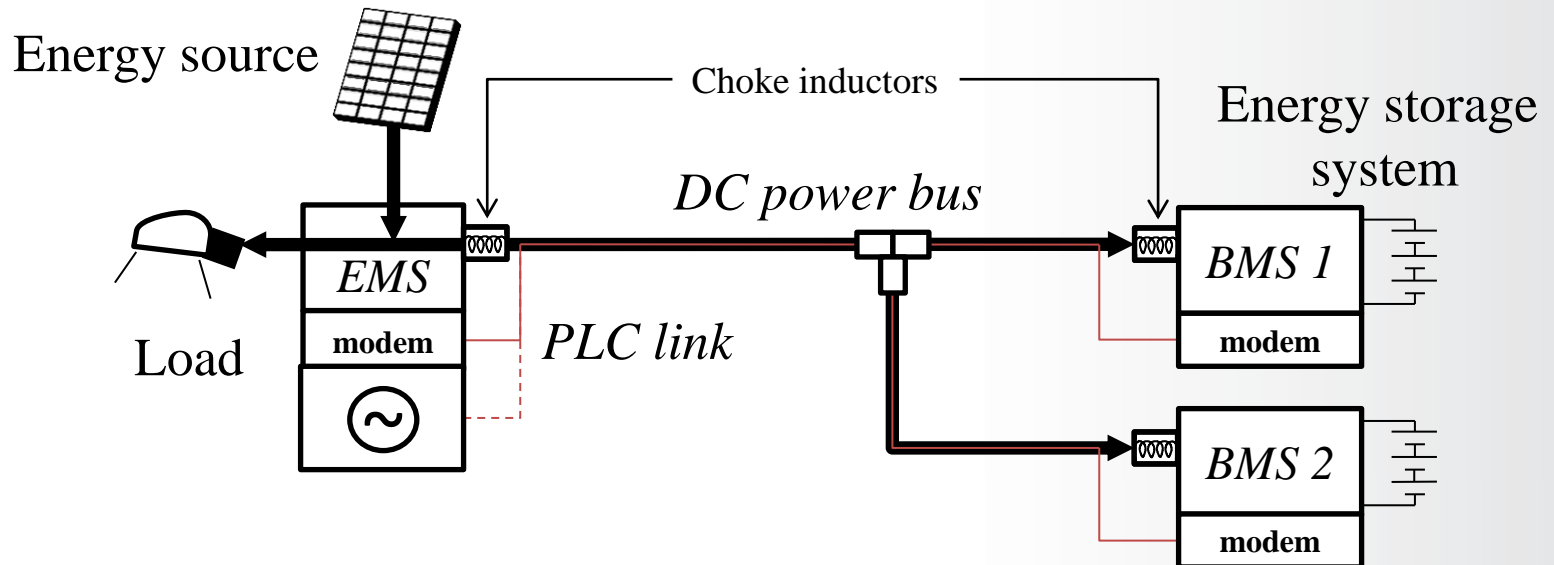

Prototypage et résultats expérimentaux

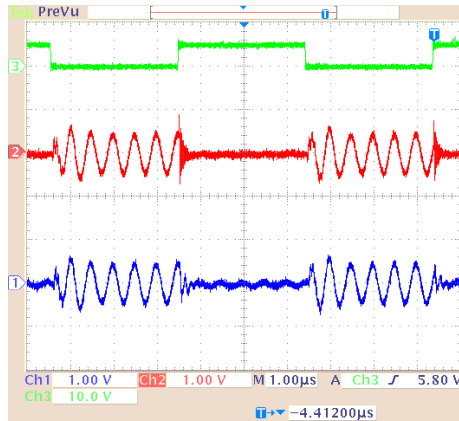

2 MHz

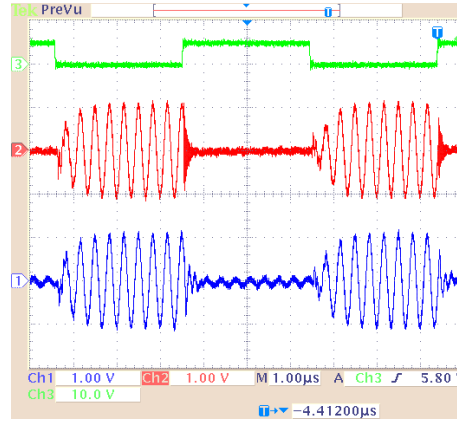

3 MHz

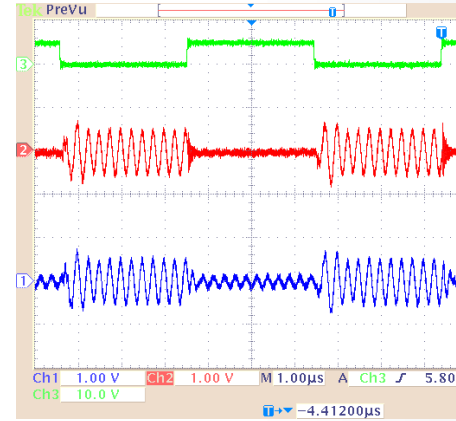

4 MHz

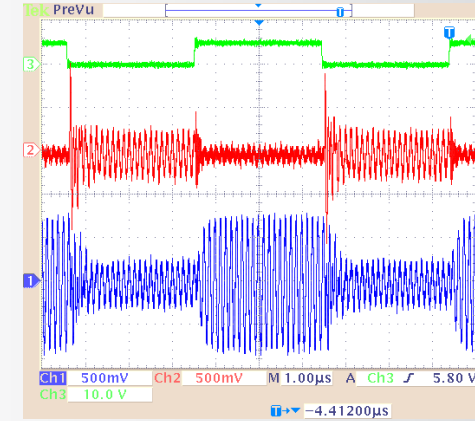

8 MHz

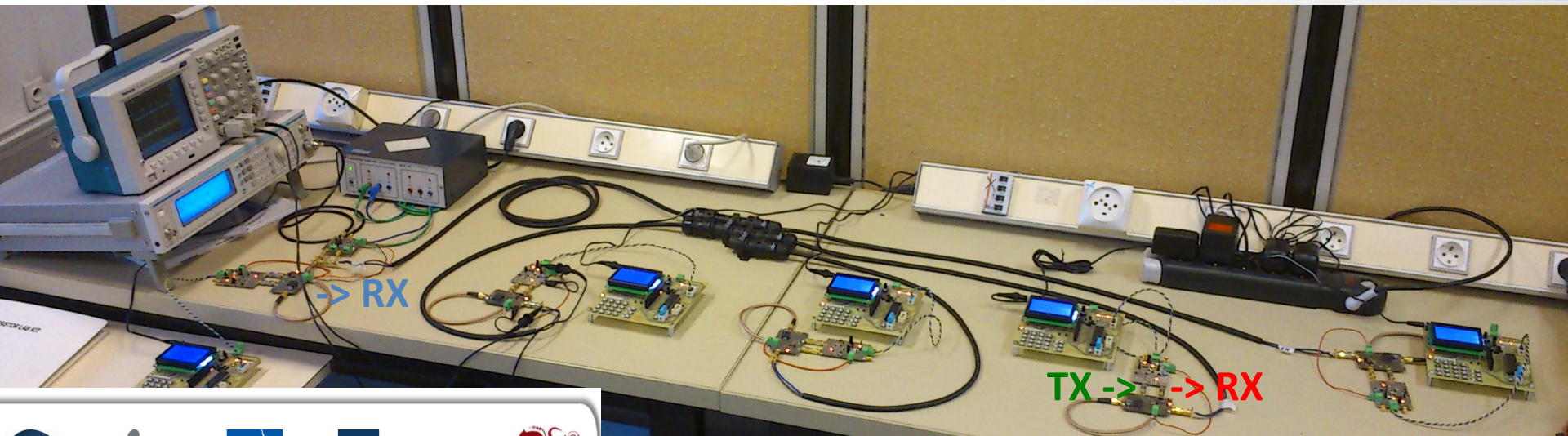

Prototypage et résultats expérimentaux

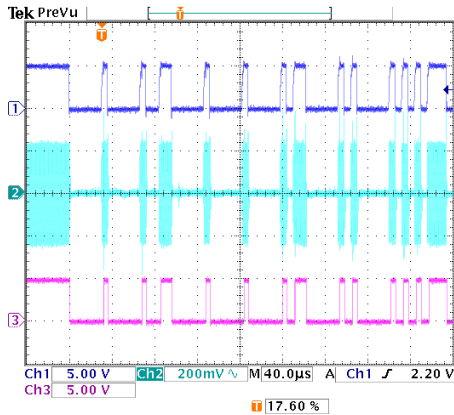

-10 dBm

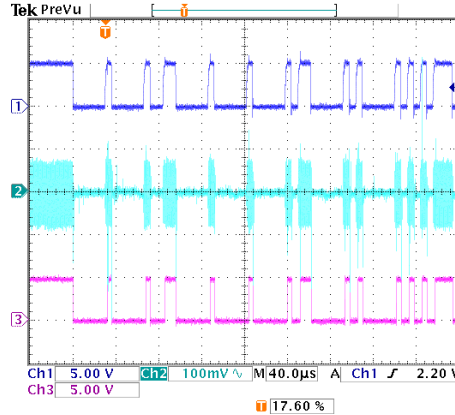

-20 dBm

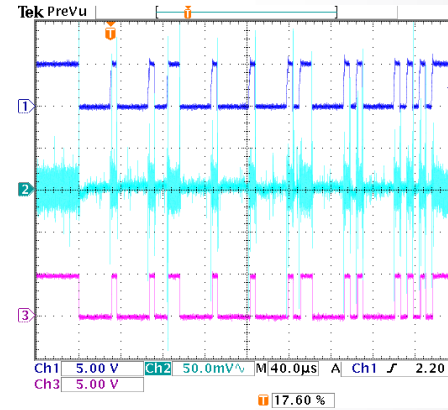

-30 dBm

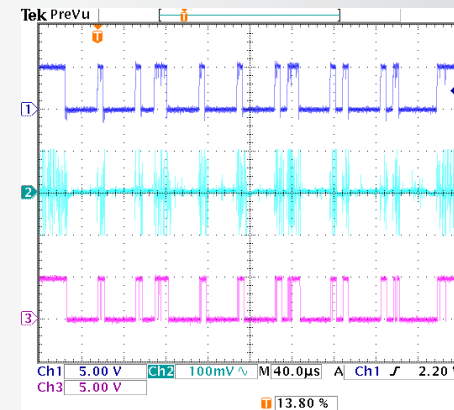

-40 dBm

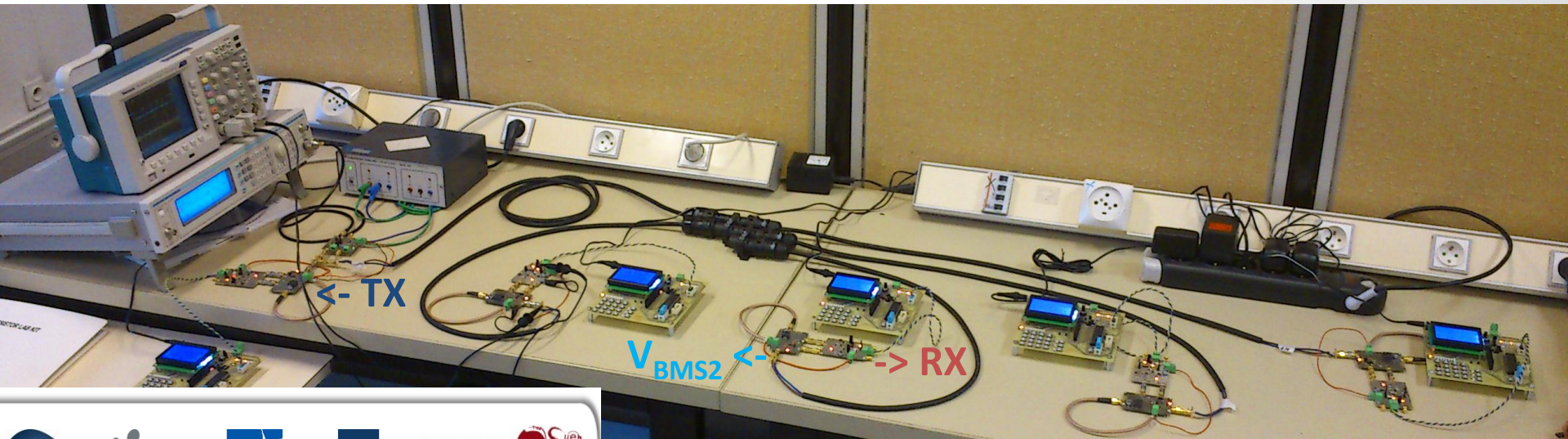

Prototype de BMS intégrant un modem CPL

Carte additionnelle pour EMS avec
générateur de porteuse et modem CPL

Prototype de batterie fonctionnel

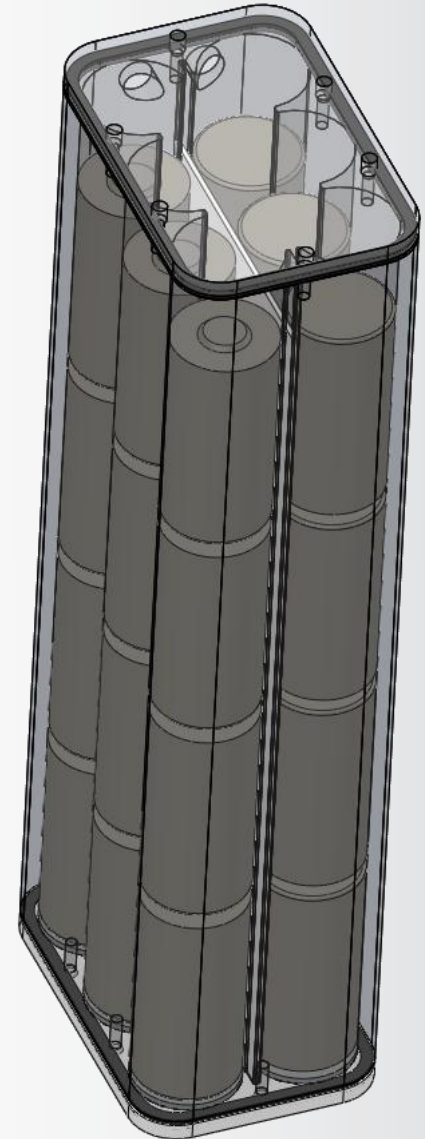

Merci de votre attention

