



HAL
open science

Lipschitz geometry of complex surfaces: analytic invariants and equisingularity

Walter D Neumann, Anne Pichon

► **To cite this version:**

Walter D Neumann, Anne Pichon. Lipschitz geometry of complex surfaces: analytic invariants and equisingularity. 2012. hal-01130560

HAL Id: hal-01130560

<https://hal.science/hal-01130560v1>

Preprint submitted on 12 Mar 2015

HAL is a multi-disciplinary open access archive for the deposit and dissemination of scientific research documents, whether they are published or not. The documents may come from teaching and research institutions in France or abroad, or from public or private research centers.

L'archive ouverte pluridisciplinaire **HAL**, est destinée au dépôt et à la diffusion de documents scientifiques de niveau recherche, publiés ou non, émanant des établissements d'enseignement et de recherche français ou étrangers, des laboratoires publics ou privés.

LIPSCHITZ GEOMETRY OF COMPLEX SURFACES: ANALYTIC INVARIANTS AND EQUISINGULARITY.

WALTER D NEUMANN AND ANNE PICHON

ABSTRACT. We prove that the outer Lipschitz geometry of the germ of a normal complex surface singularity determines a large amount of its analytic structure. In particular, it follows that any analytic family of normal surface singularities with constant Lipschitz geometry is Zariski equisingular. We also prove a strong converse for families of normal complex hypersurface singularities in \mathbb{C}^3 : Zariski equisingularity implies Lipschitz triviality. So for such a family Lipschitz triviality, constant Lipschitz geometry and Zariski equisingularity are equivalent to each other.

1. INTRODUCTION

This paper has two aims. One is to prove the equivalence of Zariski and bilipschitz equisingularity for families of normal complex surface singularities. The other, on which the first partly depends, is to describe which analytic invariants are determined by the Lipschitz geometry of a normal complex surface singularity.

In [1] the richness of the Lipschitz geometry of a normal surface singularity was demonstrated in a classification in terms of discrete invariants associated to a refined JSJ decomposition of the singularity link. That paper addressed the inner metric. The present paper concerns the outer metric, and we show it is even richer.

Equisingularity. The question of defining a good notion of equisingularity of a reduced hypersurface $\mathfrak{X} \subset \mathbb{C}^n$ along a non singular complex subspace $Y \subset \mathfrak{X}$ in a neighbourhood of a point $0 \in \mathfrak{X}$ started in 1965 with two papers of Zariski ([29, 30]). This problem has been extensively studied with different approaches and by many authors such as Zariski himself, Abhyankar, Briançon, Gaffney, Hironaka, Lê, Lejeune-Jalabert, Lipman, Mostowski, Parusiński, Pham, Speder, Teissier, Thom, Trotman, Varchenko, Wahl, Whitney and many others.

One of the central concepts introduced by Zariski is the algebro-geometric equisingularity, called nowadays Zariski equisingularity. The idea is that the equisingularity of \mathfrak{X} along Y is defined inductively on the codimension of Y in \mathfrak{X} by requiring that the reduced discriminant locus of a suitably general projection $p: \mathfrak{X} \rightarrow \mathbb{C}^{n-1}$ be itself equisingular along $p(Y)$. The induction starts by requiring that in codimension one the discriminant locus is nonsingular. (This is essentially Speder's definition in [21]; Zariski later gave a variant in [31], but for surface singularities the variants are equivalent to each other.)

When Y has codimension one in \mathfrak{X} , it is well known that Zariski equisingularity is equivalent to all main notions of equisingularity, such as Whitney conditions for

1991 *Mathematics Subject Classification.* 14B05, 32S25, 32S05, 57M99.

Key words and phrases. bilipschitz, Lipschitz geometry, normal surface singularity, Zariski equisingularity, Lipschitz equisingularity.

the pair $(\mathfrak{X} \setminus Y, Y)$ and topological triviality. However these properties fail to be equivalent in higher codimension: Zariski equisingularity still implies topological triviality ([27, 28]) and Whitney conditions ([21]), but the converse statements are false ([4, 5, 26]) and a global theory of equisingularity is still far from being established. For good surveys of equisingularity questions, see [16, 24].

The first main result of this paper states the equivalence between Zariski equisingularity, constancy of Lipschitz geometry and triviality of Lipschitz geometry in the case Y is the singular locus of \mathfrak{X} and has codimension 2 in \mathfrak{X} . We must say what we mean by “Lipschitz geometry”. If $(X, 0)$ is a germ of a complex variety, then any embedding $\phi: (X, 0) \hookrightarrow (\mathbb{C}^n, 0)$ determines two metrics on $(X, 0)$: the outer metric

$$d_{out}(x_1, x_2) := |\phi(x_1) - \phi(x_2)| \quad (\text{i.e., distance in } \mathbb{C}^n)$$

and the inner metric

$$d_{inn}(x_1, x_2) := \inf\{\text{length}(\phi \circ \gamma) : \gamma \text{ is a rectifiable path in } X \text{ from } x_1 \text{ to } x_2\}.$$

The outer metric determines the inner metric, and up to bilipschitz equivalence both these metrics are independent of the choice of complex embedding. We speak of the (inner or outer) *Lipschitz geometry* of $(X, 0)$ when considering these metrics up to bilipschitz equivalence. If we work up to semi-algebraic bilipschitz equivalence, we speak of the *semi-algebraic Lipschitz geometry*.

As already mentioned, the present paper is devoted to outer Lipschitz geometry. We consider here the case of normal complex surface singularities.

Let $(\mathfrak{X}, 0) \subset (\mathbb{C}^n, 0)$ be a germ of hypersurface at the origin of \mathbb{C}^n with smooth codimension 2 singular set $(Y, 0) \subset (\mathfrak{X}, 0)$.

The germ $(\mathfrak{X}, 0)$ has *constant Lipschitz geometry* along Y if there exists a smooth retraction $r: (\mathfrak{X}, 0) \rightarrow (Y, 0)$ whose fibers are transverse to Y and there is a neighbourhood U of 0 in Y such that for all $y \in U$ there exists a bilipschitz homeomorphism $h_y: (r^{-1}(y), y) \rightarrow (r^{-1}(0) \cap \mathfrak{X}, 0)$.

The germ $(\mathfrak{X}, 0)$ is *Lipschitz trivial* along Y if there exists a germ at 0 of a bilipschitz homeomorphism $\Phi: (\mathfrak{X}, Y) \rightarrow (X, 0) \times Y$ with $\Phi|_Y = id_Y$, where $(X, 0)$ is a normal complex surface germ.

We say $(\mathfrak{X}, 0)$ has constant *semi-algebraic* Lipschitz geometry or is *semi-algebraic* Lipschitz trivial if the maps r and h_y , resp. Φ above are semi-algebraic.

Theorem 1.1. *The following are equivalent:*

- (1) $(\mathfrak{X}, 0)$ is Zariski equisingular along Y ;
- (2) $(\mathfrak{X}, 0)$ has constant Lipschitz geometry along Y ;
- (3) $(\mathfrak{X}, 0)$ has constant semi-algebraic Lipschitz geometry along Y ;
- (4) $(\mathfrak{X}, 0)$ is semi-algebraic Lipschitz trivial along Y

The equivalence between (1) and (4) has been conjectured by Mostowski in a talk for which written notes are available ([17]). He also gave there brief hints to prove the result using his theory of Lipschitz stratifications. Our approach is different and we construct a decomposition of the pair $(\mathfrak{X}, \mathfrak{X} \setminus Y)$ using the theory of carousel decompositions, introduced by Lê in [12], on the family of discriminant curves. In both approaches, polar curves play a central role.

The implications (4) \Rightarrow (3) \Rightarrow (2) are trivial and the implication (2) \Rightarrow (1) will be a consequence of one of our other main results, part (5) of Theorem 1.2 below. The implication (1) \Rightarrow (4) will be proved in the final sections of the paper.

It was known already that the inner Lipschitz geometry is not sufficient to understand Zariski equisingularity. Indeed, the family of hypersurfaces $(X_t, 0) \subset (\mathbb{C}^3, 0)$ with equation $z^3 + tx^4z + x^6 + y^6 = 0$ is not Zariski equisingular (see [6]; at $t = 0$, the discriminant curve has 6 branches, while it has 12 branches when $t \neq 0$). But it follows from [1] that it has constant inner geometry (in fact $(X_t, 0)$ is metrically conical for the inner metric for all t).

Invariants from Lipschitz geometry. The other main results of this paper are stated in the next theorem.

Theorem 1.2. *If $(X, 0)$ is a normal complex surface singularity then the outer Lipschitz geometry on X determines:*

- (1) *the decorated resolution graph of the minimal good resolution of $(X, 0)$ which resolves the basepoints of a general linear system of hyperplane sections¹;*
- (2) *the multiplicity of $(X, 0)$ and the maximal ideal cycle in its resolution;*
- (3) *for a generic hyperplane H , the outer Lipschitz geometry of the curve $(X \cap H, 0)$;*
- (4) *the decorated resolution graph of the minimal good resolution of $(X, 0)$ which resolves the basepoints of the family of polar curves of plane projections²;*
- (5) *the topology of the discriminant curve of a generic plane projection;*
- (6) *the outer Lipschitz geometry of the polar curve of a generic plane projection.*

By “decorated resolution graph” we mean the resolution graph decorated with arrows corresponding to the components of the strict transform of the resolved curve. As a consequence of this theorem, the outer Lipschitz geometry of a hypersurface $(X, 0) \subset (\mathbb{C}^3, 0)$ determines other invariants such as its extended Milnor number $\mu^*(X, 0)$ and the invariants $k(X, 0)$ and $\phi(X, 0)$ (number of vanishing double folds resp. cusp-folds, see [2]).

The analytic invariants determined by the Lipschitz geometry in Theorem 1.2 are of two natures: (1)–(3) are related to the general hyperplane sections and the maximal ideal of $\mathcal{O}_{X,0}$ while (4)–(6) are related to polar curves and the jacobian ideal. The techniques we use for these two sets of invariants differ. We prove (1)–(3) in section 10, building our arguments from the thick-thin decomposition introduced in [1]. The more difficult part is (4)–(6). These polar invariants are determined in Sections 11 and 13 from a geometric decomposition of $(X, 0)$ defined in Sections 8 and 9 which is a sharp refinement of the thick-thin decomposition.

In fact, Item (6) is a straightforward consequence of Item (5). The argument is as follows: by Pham-Teissier [20] (see also Fernandes [9], Neumann-Pichon [19]), the outer Lipschitz geometry of a complex curve in \mathbb{C}^n is determined by the topology of a generic plane projection of this curve. By Teissier [25, page 462 Lemme 1.2.2 ii)], if one takes a generic plane projection $\ell: (X, 0) \rightarrow (\mathbb{C}^2, 0)$, then this projection is generic for its polar curve. Therefore the topology of the discriminant curve determines the outer Lipschitz geometry of the polar curve.

This paper has four parts, of which Parts 1 and 2 (Sections 2 to 9) introduce concepts and techniques that are needed later, Part 3 (Sections 10 to 13) proves Theorem 1.2 and Part 4 (Sections 14 to 20) proves Theorem 1.1.

¹ This is the minimal good resolution which factors through the blow-up of the maximal ideal.

² This is the minimal good resolution which factors through the Nash modification.

Acknowledgments. We are especially grateful to Lev Birbrair for many conversations which have contributed to this work. We are also grateful to Terry Gaffney and Bernard Teissier for useful conversations and to Joseph Lipman for helpful comments. Neumann was supported by NSF grants DMS-0905770 and DMS-1206760. Pichon was supported by ANR-12-JS01-0002-01 SUSI and FP7-Irses 230844 DynEurBraz. We are also grateful for the hospitality and support of the following institutions: Columbia University (P), Institut de Mathématiques de Marseille and Aix Marseille Université (N), Universidad Federal de Ceara (N,P), CIRM recherche en binôme (N,P) and IAS Princeton (N,P).

Part 1: Carrousel and geometry of curves

2. PRELIMINARY: GEOMETRIC PIECES AND RATES

In [1] we defined some metric spaces called A -, B - and D -pieces, which will be used extensively in the present paper. We give here the definition and basic facts about these pieces (see [1, Sections 11 and 13] for more details). First examples will appear in the next section. The pieces are topologically conical, but usually with metrics that make them shrink non-linearly towards the cone point. We will consider these pieces as germs at their cone-points, but for the moment, to simplify notation, we suppress this.

D^2 denotes the standard unit disc in \mathbb{C} , S^1 is its boundary, and I denotes the interval $[0, 1]$.

Definition 2.1 ($A(q, q')$ -pieces). Let q, q' be rational numbers such that $1 \leq q \leq q'$. Let A be the euclidean annulus $\{(\rho, \psi) : 1 \leq \rho \leq 2, 0 \leq \psi \leq 2\pi\}$ in polar coordinates and for $0 < r \leq 1$ let $g_{q, q'}^{(r)}$ be the metric on A :

$$g_{q, q'}^{(r)} := (r^q - r^{q'})^2 d\rho^2 + ((\rho - 1)r^q + (2 - \rho)r^{q'})^2 d\psi^2.$$

So A with this metric is isometric to the euclidean annulus with inner and outer radii $r^{q'}$ and r^q . The metric completion of $(0, 1] \times S^1 \times A$ with the metric

$$dr^2 + r^2 d\theta^2 + g_{q, q'}^{(r)}$$

compactifies it by adding a single point at $r = 0$. We call a metric space which is bilipschitz homeomorphic to this completion an $A(q, q')$ -piece or simply A -piece.

Definition 2.2 ($B(q)$ -pieces). Let F be a compact oriented 2-manifold, $\phi: F \rightarrow F$ an orientation preserving diffeomorphism, and M_ϕ the mapping torus of ϕ , defined as:

$$M_\phi := ([0, 2\pi] \times F) / ((2\pi, x) \sim (0, \phi(x))).$$

Given a rational number $q > 1$, we will define a metric space $B(F, \phi, q)$ which is topologically the cone on the mapping torus M_ϕ .

For each $0 \leq \theta \leq 2\pi$ choose a Riemannian metric g_θ on F , varying smoothly with θ , such that for some small $\delta > 0$:

$$g_\theta = \begin{cases} g_0 & \text{for } \theta \in [0, \delta], \\ \phi^* g_0 & \text{for } \theta \in [2\pi - \delta, 2\pi]. \end{cases}$$

Then for any $r \in (0, 1]$ the metric $r^2 d\theta^2 + r^{2q} g_\theta$ on $[0, 2\pi] \times F$ induces a smooth metric on M_ϕ . Thus

$$dr^2 + r^2 d\theta^2 + r^{2q} g_\theta$$

defines a smooth metric on $(0, 1] \times M_\phi$. The metric completion of $(0, 1] \times M_\phi$ adds a single point at $r = 0$. Denote this completion by $B(F, \phi, q)$. We call a metric space which is bilipschitz homeomorphic to $B(F, \phi, q)$ a $B(q)$ -piece or simply B -piece. A $B(q)$ -piece such that F is a disc and $q \geq 1$ is called a $D(q)$ -piece or simply D -piece.

Definition 2.3 (Conical pieces). Given a compact smooth 3-manifold M , choose a Riemannian metric g on M and consider the metric $dr^2 + r^2g$ on $(0, 1] \times M$. The completion of this adds a point at $r = 0$, giving a *metric cone on M* . We call a metric space which is bilipschitz homeomorphic to a metric cone a *conical piece*. Notice that $B(1)$ - and $A(1, 1)$ -pieces are conical. For short we will call any conical piece a $B(1)$ -piece, even if its 3-dimensional link is not a mapping-torus. (Conical-pieces were called *CM*-pieces in [1].)

The diameter of the image in $B(F, \phi, q)$ of a fiber $F_{r,\theta} = \{r\} \times \{\theta\} \times F$ is $O(r^q)$. Therefore q describes a rate of shrink of the surfaces $F_{r,\theta}$ in $B(F, \phi, q)$ with respect to the distance r to the point at $r = 0$. Similarly, the inner and outer boundary components of any $\{r\} \times \{t\} \times A$ in an $A(q, q')$ have rate of shrink respectively q' and q with respect to r .

Definition 2.4 (Rate). The rational number q is called the *rate* of $B(q)$ or $D(q)$. The rationals q and q' are the two *rates* of $A(q, q')$.

In [1, Section 11] we explain how to glue two A - or B -pieces by an isometry along cone-boundary components having the same rate. Some of these gluings give again A - or B -pieces and then could simplify by some rules as described in [1, Section 13]. We recall here this result, which will be used later in amalgamation processes.

Lemma 2.5. *In this lemma \cong means bilipschitz equivalence and \cup represents gluing along appropriate boundary components by an isometry.*

- (1) $B(D^2, \phi, q) \cong B(D^2, id, q)$; $B(S^1 \times I, \phi, q) \cong B(S^1 \times I, id, q)$.
- (2) $A(q, q') \cup A(q', q'') \cong A(q, q'')$.
- (3) *If F is the result of gluing a surface F' to a disk D^2 along boundary components then $B(F', \phi|_{F'}, q) \cup B(D^2, \phi|_{D^2}, q) \cong B(F, \phi, q)$.*
- (4) $A(q, q') \cup B(D^2, id, q') \cong B(D^2, id, q)$.
- (5) *A union of conical pieces glued along boundary components is a conical piece.* □

3. THE PLAIN CARROUSEL DECOMPOSITION FOR A PLANE CURVE GERM

A *carrousel decomposition* for a reduced curve germ $(C, 0) \subset (\mathbb{C}^2, 0)$ is constructed in two steps. The first one consists in truncating the Puiseux series expansions of the branches of C at suitable exponents and then constructing a decomposition of $(\mathbb{C}^2, 0)$ into A -, B - and D -pieces with respect to the truncated Puiseux series. We call this first decomposition the *unamalgamated carrousel decomposition*. It is the carrousel decomposition used in [1], based on ideas of Lê in [12].

The second step consists in amalgamating certain pieces of the unamalgamated carrousel decomposition using the techniques of Lemma 2.5.

There are two choices in the construction: where we truncate the Puiseux series expansions to form a carrousel decomposition, and how we amalgamate pieces of the carrousel decomposition to form the amalgamated carrousel decomposition. Amalgamated carrousel decompositions will be a key tool in the present paper and

we will in fact use several different ones based on different choices of truncation and amalgamation.

In this section, we will construct an amalgamated carrousel decomposition which we call the *plain carrousel decomposition* of C . We start by constructing the appropriate unamalgamated carrousel decomposition.

The tangent cone of C at 0 is a union $\bigcup_{j=1}^m L^{(j)}$ of lines. For each j we denote the union of components of C which are tangent to $L^{(j)}$ by $C^{(j)}$. We can assume our coordinates (x, y) in \mathbb{C}^2 are chosen so that the y -axis is transverse to each $L^{(j)}$.

We choose $\epsilon_0 > 0$ sufficiently small that the set $\{(x, y) : |x| = \epsilon\}$ is transverse to C for all $\epsilon \leq \epsilon_0$. We define conical sets $V^{(j)}$ of the form

$$V^{(j)} := \{(x, y) : |y - a_1^{(j)}x| \leq \eta|x|, |x| \leq \epsilon_0\} \subset \mathbb{C}^2,$$

where the equation of the line $L^{(j)}$ is $y = a_1^{(j)}x$ and $\eta > 0$ is small enough that the cones are disjoint except at 0. If ϵ_0 is small enough $C^{(j)} \cap \{|x| \leq \epsilon_0\}$ will lie completely in $V^{(j)}$.

There is then an $R > 0$ such that for any $\epsilon \leq \epsilon_0$ the sets $V^{(j)}$ meet the boundary of the “square ball”

$$B_\epsilon := \{(x, y) \in \mathbb{C}^2 : |x| \leq \epsilon, |y| \leq R\epsilon\}$$

only in the part $|x| = \epsilon$ of the boundary. We will use these balls as a system of Milnor balls.

We first define the carrousel decomposition inside each $V^{(j)}$ with respect to the branches of $C^{(j)}$. It will consist of closures of regions between successively smaller neighbourhoods of the successive Puiseux approximations of the branches of $C^{(j)}$. As such, it is finer than the one of [12], which only needed the first Puiseux exponents of the branches of $C^{(j)}$.

We will fix j for the moment and therefore drop the superscripts, so our tangent line L has equation $y = a_1x$. The collection of coefficients and exponents appearing in the following description depends, of course, on $j = 1, \dots, m$.

Truncation. We first truncate the Puiseux series for each component of C at a point where truncation does not affect the topology of C . Then for each pair $\kappa = (f, p_k)$ consisting of a Puiseux polynomial $f = \sum_{i=1}^{k-1} a_i x^{p_i}$ and an exponent p_k for which there is a Puiseux series $y = \sum_{i=1}^k a_i x^{p_i} + \dots$ describing some component of C , we consider all components of C which fit this data. If $a_{k1}, \dots, a_{km_\kappa}$ are the coefficients of x^{p_k} which occur in these Puiseux polynomials we define

$$B_\kappa := \left\{ (x, y) : \alpha_\kappa |x^{p_k}| \leq \left| y - \sum_{i=1}^{k-1} a_i x^{p_i} \right| \leq \beta_\kappa |x^{p_k}| \right. \\ \left. \left| y - \left(\sum_{i=1}^{k-1} a_i x^{p_i} + a_{k,j} x^{p_k} \right) \right| \geq \gamma_\kappa |x^{p_k}| \text{ for } j = 1, \dots, m_\kappa \right\}.$$

Here $\alpha_\kappa, \beta_\kappa, \gamma_\kappa$ are chosen so that $\alpha_\kappa < |a_{kj}| - \gamma_\kappa < |a_{kj}| + \gamma_\kappa < \beta_\kappa$ for each $j = 1, \dots, m_\kappa$. If ϵ is small enough, the sets B_κ will be disjoint for different κ .

It is easy to see that B_κ is a $B(p_k)$ -piece: the intersection $B_\kappa \cap \{x = t\}$ is a finite collection of disks with some smaller disks removed. The diameter of each of them is $O(t^{p_k})$. The closure of the complement in $V = V^{(j)}$ of the union of the B_κ 's is

a union of A - and D -pieces. Finally, $\overline{B_\epsilon \setminus \bigcup V^{(j)}}$ is a $B(1)$ -piece. We have then decomposed each cone $V^{(j)}$ and the whole of B_ϵ as a union of B -, A - and D -pieces.

Definition 3.1 (Carrousel section). A *carrousel section* is the picture of the intersection of a carrousel decomposition with a line $x = t$.

Example 3.2. Figure 1 shows a carrousel section for a curve C having two branches with Puiseux expansions respectively $y = ax^{4/3} + bx^{13/6} + \dots$ and $y = cx^{7/4} + \dots$ truncated after the terms $bx^{13/6}$ and $cx^{7/4}$ respectively. The D -pieces are gray. Note that the intersection of a piece of the decomposition of V with the disk $V \cap \{x = \epsilon\}$ will usually have several components. Note also that the rates in A - and D -pieces are determined by the rates in the neighbouring B -pieces.

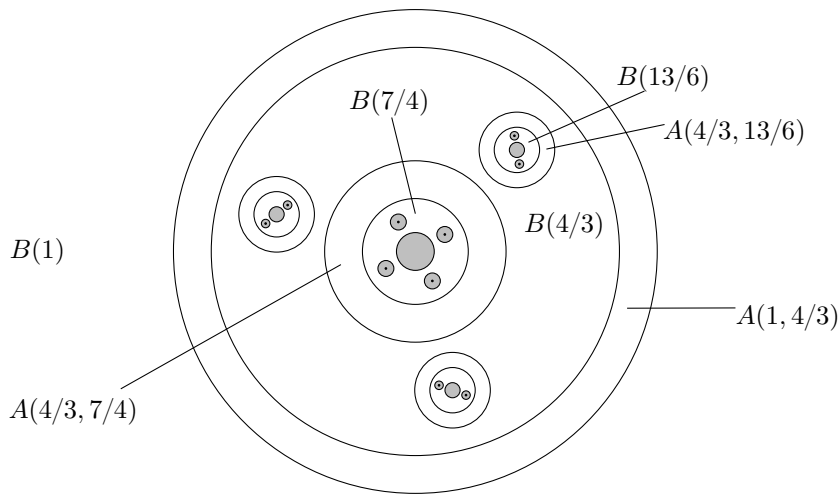

FIGURE 1. Unamalgamated carrousel section for $C = \{y = ax^{4/3} + bx^{13/6} + \dots\} \cup \{y = cx^{7/4} + \dots\}$.

Amalgamation 3.3. For the study of plane curves a much simpler decomposition suffices, which we obtain by amalgamating any D -piece that does not contain part of the curve C with the piece that meets it along its boundary.

Definition 3.4. We call this amalgamated carrousel decomposition the *plain carrousel decomposition* of the curve C . The plain carrousel section for example 3.2 is the result of removing the four small gray disks in Figure 1.

The combinatorics of the plain carrousel section can be encoded by a rooted tree, with vertices corresponding to pieces, edges corresponding to pieces which intersect along a circle, and with rational weights (the rates of the pieces) associated to the nodes of the tree. It is easy to recover a picture of the carrousel section, and hence the embedded topology of the plane curve, from this weighted tree. For a careful description of how to do this in terms of either the Eggers tree or the Eisenbud-Neumann splice diagram of the curve see [19].

Proposition 3.5. *The combinatorics of the plain carrousel section for a plane curve germ C determines the embedded topology of C .* \square

4. LIPSCHITZ GEOMETRY AND TOPOLOGY OF A PLANE CURVE

In [19] we proved the following strong version of a result of Pham and Teissier [20] and Fernandes [9] about plane curve germs.

Proposition 4.1. *The outer Lipschitz geometry of a plane curve germ $(C, 0) \subset (\mathbb{C}^2, 0)$ determines its embedded topology.*

More generally, if $(C, 0) \subset (\mathbb{C}^n, 0)$ is a curve germ and $\ell: \mathbb{C}^n \rightarrow \mathbb{C}^2$ is a generic plane projection then the outer Lipschitz geometry of $(C, 0)$ determines the embedded topology of the plane projection $(\ell(C), 0) \subset (\mathbb{C}^2, 0)$.

What was new in this proposition is that the germ is considered just as a metric space germ up to bilipschitz equivalence, without the analytic restrictions of [20] and [9]. The converse result, that the embedded topology of a plane curve determines the outer Lipschitz geometry, is easier and is proved in [20].

In this section we will briefly recall the proof of Proposition 4.1 since we use the last part of it in Section 10 (proof of Item (3) of Theorem 1.2) and we use a similar technique to the first part of it in Section 13. For more detail see [19].

Proof. The case $n > 2$ of Proposition 4.1 follows immediately from the case $n = 2$ since Pham and Teissier prove in [20] that for a generic plane projection ℓ the restriction $\ell|_C: (C, 0) \rightarrow (\ell(C), 0)$ is bilipschitz for the outer geometry on C . So we assume from now on that $n = 2$, so $(C, 0) \subset (\mathbb{C}^2, 0)$ is a plane curve.

We first describe how to recover the combinatorics of the plain carrousel section of C using the analytic structure and the outer geometry.

We assume, as in the previous section, that the tangent cone of C at 0 is a union of lines transverse to the y -axis. We use again the family of Milnor balls B_ϵ , $\epsilon \leq \epsilon_0$, of the previous section. We put $S_\epsilon = \partial B_\epsilon$. Let μ be the multiplicity of C . The lines $x = t$ for $t \in (0, \epsilon_0]$ intersect C in a finite set of points $p_1(t), \dots, p_\mu(t)$ which depends continuously on t . For each $0 < j < k \leq \mu$ the distance $d(p_j(t), p_k(t))$ has the form $O(t^{q_{jk}})$, where q_{jk} is either an essential Puiseux exponent for a branch of the plane curve C or a coincidence exponent between two branches of C .

Lemma 4.2. *The map $\{(j, k) \mid 1 \leq j < k \leq \mu\} \mapsto q_{jk}$ determines the embedded topology of C .*

Proof. By Proposition 3.5 it suffices to prove that the map $\{(j, k) \mid 1 \leq j < k \leq \mu\} \mapsto q_{jk}$ determines the combinatorics of the plain carrousel section of the curve C .

Let $q_1 > q_2 > \dots > q_s$ be the images of the map $(j, k) \mapsto q_{jk}$. The proof consists in reconstructing a topological version of the carrousel section of C from the innermost pieces to the outermost ones by an inductive process starting with q_1 and ending with q_s .

We start with μ discs $D_1^{(0)}, \dots, D_\mu^{(0)}$, which will be the innermost pieces of the carrousel decomposition. We consider the graph $G^{(1)}$ whose vertices are in bijection with these μ disks and with an edge between vertices v_j and v_k if and only if $q_{jk} = q_1$. Let $G_1^{(1)}, \dots, G_{\nu_1}^{(1)}$ be the connected components of $G^{(1)}$ and denote by $\alpha_m^{(1)}$ the number of vertices of $G_m^{(1)}$. For each $G_m^{(1)}$ with $\alpha_m^{(1)} > 1$ we consider a disc $B_m^{(1)}$ with $\alpha_m^{(1)}$ holes, and we glue the discs $D_j^{(0)}$, $v_j \in \text{vert } G_m^{(1)}$, into the inner boundary components of $B_m^{(1)}$. We call the resulting disc $D_m^{(1)}$. For a $G_m^{(1)}$ with just one vertex, v_{j_m} say, we rename $D_{j_m}^{(0)}$ as $D_m^{(1)}$.

The numbers q_{jk} have the property that $q_{jl} = \min(q_{jk}, q_{kl})$ for any triple j, k, l . So for each distinct m, n the number $q_{j_m k_n}$ does not depend on the choice of vertices v_{j_m} in $G_m^{(1)}$ and v_{k_n} in $G_n^{(1)}$.

We iterate the above process as follows: we consider the graph $G^{(2)}$ whose vertices are in bijection with the connected components $G_1^{(1)}, \dots, G_{\nu_1}^{(1)}$ and with an edge between the vertices $(G_m^{(1)})$ and $(G_n^{(1)})$ if and only if $q_{j_m k_n}$ equals q_2 (with vertices v_{j_m} and v_{k_n} in $G_m^{(1)}$ and $G_n^{(1)}$ respectively). Let $G_1^{(2)}, \dots, G_{\nu_2}^{(2)}$ be the connected components of G_2 . For each $G_m^{(2)}$ let $\alpha_m^{(2)}$ be the number of its vertices. If $\alpha_m^{(2)} > 1$ we take a disc $B_m^{(2)}$ with $\alpha_m^{(2)}$ holes and glue the corresponding disks $D_l^{(1)}$ into these holes. We call the resulting piece $D_m^{(2)}$. If $\alpha_m^{(2)} = 1$ we rename the corresponding $D_m^{(1)}$ disk to $D_m^{(2)}$.

By construction, repeating this process for s steps gives a topological version of the carousel section of the curve C , and hence, by Proposition 3.5, its embedded topology. \square

To complete the proof of Proposition 4.1 we must show that we can find the numbers q_{jk} without using the complex structure, and after a bilipschitz change to the outer metric.

The tangent cone of C at 0 is a union of lines $L^{(i)}$, $i = 1, \dots, m$, transverse to the y -axis. Denote by $C^{(i)}$ the part of C tangent to the line $L^{(i)}$. It suffices to discover the q_{jk} 's belonging to each $C^{(i)}$ independently, since the $C^{(i)}$'s are distinguished by the fact that the distance between any two of them outside a ball of radius ϵ around 0 is $O(\epsilon)$, even after bilipschitz change to the metric. We will therefore assume from now on that the tangent cone of C is a single complex line.

Our points $p_1(t), \dots, p_\mu(t)$ that we used to find the numbers q_{jk} were obtained by intersecting C with the line $x = t$. The arc $p_1(t)$, $t \in [0, \epsilon_0]$ satisfies $d(0, p_1(t)) = O(t)$. Moreover, for any small $\delta > 0$ we can choose ϵ_0 sufficiently small that the other points $p_2(t), \dots, p_\mu(t)$ are always in the transverse disk of radius δt centered at $p_1(t)$ in the plane $x = t$.

Instead of a transverse disk of radius δt , we now use a ball $B(p_1(t), \delta t)$ of radius δt centered at $p_1(t)$. This $B(p_1(t), \delta t)$ intersects C in μ disks $D_1(t), \dots, D_\mu(t)$, and we have $d(D_j(t), D_k(t)) = O(t^{q_{jk}})$, so we still recover the numbers q_{jk} .

We now replace the arc $p_1(t)$ by any continuous arc $p'_1(t)$ on C with the property that $d(0, p'_1(t)) = O(t)$. If δ is sufficiently small, the intersection $B_C(p'_1(t), \delta t) := C \cap B(p'_1(t), \delta t)$ still consists of μ disks $D'_1(t), \dots, D'_\mu(t)$ with $d(D'_j(t), D'_k(t)) = O(t^{q_{jk}})$. So we have gotten rid of the dependence on analytic structure in discovering the topology. But we must consider what a K -bilipschitz change to the metric does.

Such a change may make the components of $B_C(p'_1(t), \delta t)$ disintegrate into many pieces, so we can no longer simply use distance between pieces. To resolve this, we consider both $B'_C(p'_1(t), \delta t)$ and $B'_C(p'_1(t), \frac{\delta}{K^\alpha} t)$ where B' means we are using the modified metric. Then only μ components of $B'_C(p_1(t), \delta t)$ will intersect $B'_C(p_1(t), \frac{\delta}{K^\alpha} t)$. Naming these components $D'_1(t), \dots, D'_\mu(t)$ again, we still have $d(D'_j(t), D'_k(t)) = O(t^{q_{jk}})$ so the q_{jk} are determined as before. \square

We end this section with a remark which introduces a key concept for the proof of Proposition 13.1.

Remark 4.3. Assume first that C is irreducible. Fix $q \in \mathbb{Q}$ and replace in the arguments above the balls $B_C(p_1(t), \delta t)$ of radius δt by balls of radius δt^q . If δ is

big enough then $B_C(p_1(t), \delta t^q)$ consists of η discs $D_1''(t), \dots, D_\eta''(t)$ for some $\eta \leq \mu$ and the rates $q_{j,k}''$ given by $d(D_j''(t), D_k''(t)) = O(t^{q_{j,k}'})$ coincide with the above rates $q_{j,k}$ such that $q_{j,k} \geq q$. These rates determine the carousel sections of C inside pieces of the carousel with rates $\geq q$.

Definition 4.4. We say that the rates $q_{j,k}''$ with $1 \leq j < k \leq \eta$ determine the outer Lipschitz geometry (resp. the carousel section) of C *beyond rate q* .

If C is not irreducible, take p_1 inside a component C_0 of C . Then the rates $q_{j,k}''$ recover the outer Lipschitz geometry beyond q of the union C' of components of C having exponent of coincidence with C_0 greater than or equal to q . If C contains a component which is not in C' , we iterate the process by choosing an arc in it. After iterating this process to catch all the components of C , we say we have determined the outer Lipschitz geometry of the whole C (resp. its carousel section) *beyond rate q* .

If C is the generic projection of a curve $C' \subset \mathbb{C}^n$, we speak of *the outer Lipschitz geometry of C' beyond rate q* .

Part 2: Geometric decompositions of a normal complex surface singularity

5. INTRODUCTION TO GEOMETRIC DECOMPOSITION

Birbrair and the authors proved in [1] the existence and unicity of a decomposition $(X, 0) = (Y, 0) \cup (Z, 0)$ of a normal complex surface singularity $(X, 0)$ into a thick part $(Y, 0)$ and a thin part $(Z, 0)$. The thick part is essentially the metrically conical part of $(X, 0)$ with respect to the inner metric while the thin part shrinks faster than linearly in size as it approaches the origin. The thick-thin decomposition was then refined further by dividing the thin part into A - and B -pieces, giving a classification of the inner Lipschitz geometry in terms of discrete data recording rates and directions of shrink of the refined pieces (see [1, Theorem 1.9]).

This “classifying decomposition” decomposes the 3-manifold link $X^{(\epsilon)} := X \cap S_\epsilon$ of X into Seifert fibered pieces glued along torus boundary components. In general this decomposition is a refinement of JSJ decomposition of the 3-manifold $X^{(\epsilon)}$ (minimal decomposition into Seifert fibered pieces).

In this Part 2 of the paper we refine the decomposition further, in a way that implicitly sees the influence of the outer Lipschitz geometry, by taking the position of polar curves of generic plane projections into account. We call this decomposition the *geometric decomposition* (see Definition 8.5) and write it as

$$(X, 0) = \bigcup_{i=1}^{\nu} (X_{q_i}, 0) \cup \bigcup_{i>j} (A_{q_i, q_j}, 0), \quad q_1 > \dots > q_\nu = 1.$$

Each X_{q_i} is a union of pieces of type $B(q_i)$ and each A_{q_i, q_j} is a (possibly empty) union of $A(q_i, q_j)$ -pieces glued to X_{q_i} and X_{q_j} along boundary components. This refinement may also decompose the thick part by excising from it some D -pieces (which may themselves be further decomposed) which are “thin for the outer metric”.

The importance of the geometric decomposition is that it can be recovered using the outer Lipschitz geometry of $(X, 0)$. We will show this in Part 3 of the paper. We will need two different constructions of the geometric decomposition, one in

terms of a carousel, and one in terms of resolution. The first is done in Sections 6 to 8 and the second in Section 9.

It is worth remarking that the geometric decomposition has a topological description in terms of a relative JSJ decomposition of the link $X^{(\epsilon)}$. Consider the link $K \subset X^{(\epsilon)}$ consisting of the intersection with $X^{(\epsilon)}$ of the polar curves of a generic pair of plane projections $X \rightarrow \mathbb{C}^2$ union a generic pair of hyperplane sections of C . The decomposition of $X^{(\epsilon)}$ as the union of the components of the $X_{q_i}^{(\epsilon)}$'s and the intermediate $A(q_i, q_j)$ -pieces is topologically the relative JSJ decomposition for the pair $(X^{(\epsilon)}, K)$, i.e., the minimal decomposition of $X^{(\epsilon)}$ into Seifert fibered pieces separated by annular pieces such that the components of K are Seifert fibers in the decomposition.

6. POLAR WEDGES

We denote by $\mathbf{G}(k, n)$ the grassmannian of k -dimensional subspaces of \mathbb{C}^n .

Definition 6.1 (Generic linear projection). Let $(X, 0) \subset (\mathbb{C}^n, 0)$ be a normal surface germ. For $\mathcal{D} \in \mathbf{G}(n-2, n)$ let $\ell_{\mathcal{D}}: \mathbb{C}^n \rightarrow \mathbb{C}^2$ be the linear projection $\mathbb{C}^n \rightarrow \mathbb{C}^2$ with kernel \mathcal{D} . Let $\Pi_{\mathcal{D}} \subset X$ be the polar of this projection, i.e., the closure in $(X, 0)$ of the singular locus of the restriction of $\ell_{\mathcal{D}}$ to $X \setminus \{0\}$, and let $\Delta_{\mathcal{D}} = \ell_{\mathcal{D}}(\Pi_{\mathcal{D}})$ be the discriminant curve. There exists an open dense subset $\Omega \subset \mathbf{G}(n-2, n)$ such that $\{(\Pi_{\mathcal{D}}, 0) : \mathcal{D} \in \Omega\}$ forms an equisingular family of curve germs in terms of strong simultaneous resolution and such that the discriminant curves $\Delta_{\mathcal{D}}$ are reduced and no tangent line to $\Pi_{\mathcal{D}}$ at 0 is contained in \mathcal{D} ([14, (2.2.2)] and [25, V. (1.2.2)]). The projection $\ell_{\mathcal{D}}: \mathbb{C}^n \rightarrow \mathbb{C}^2$ is *generic* for $(X, 0)$ if $\mathcal{D} \in \Omega$.

The condition $\Delta_{\mathcal{D}}$ reduced means that any $p \in \Delta_{\mathcal{D}} \setminus \{0\}$ has a neighbourhood U in \mathbb{C}^2 such that one component of $(\ell_{\mathcal{D}|_X})^{-1}(U)$ maps by a two-fold branched cover to U and the other components map bijectively.

Let B_{ϵ} be a Milnor ball for $(X, 0)$ (in Section 8 we will specify a family of Milnor balls). Fix a $\mathcal{D} \in \Omega$ and a component Π_0 of the polar curve of $\ell = \ell_{\mathcal{D}}$. We now recall the main result of [1, Section 3], which defines a suitable region A_0 containing Π_0 in $X \cap B_{\epsilon}$, outside of which ℓ is a local bilipschitz homeomorphism.

Let us consider the branch $\Delta_0 = \ell(\Pi_0)$ of the discriminant curve of ℓ . Let V be a small neighbourhood of \mathcal{D} in Ω . For each \mathcal{D}' in V let $\Pi_{\mathcal{D}', 0}$ be the component of $\Pi_{\mathcal{D}'}$ close to Π_0 . Then the curve $\ell(\Pi_{\mathcal{D}', 0})$ has Puiseux expansion

$$y = \sum_{j \geq 1} a_j(\mathcal{D}') x^{p_j} \in \mathbb{C}\{x^{\frac{1}{N}}\}, \quad \text{with } p_j \in \mathbb{Q}, \quad 1 \leq p_1 < p_2 < \dots$$

where $a_j(\mathcal{D}') \in \mathbb{C}$. Here $N = \text{lcm}_{j \geq 1} \text{denom}(p_j)$, where ‘‘denom’’ means denominator. (In fact, if V is sufficiently small, the family of curves $\ell(\Pi_{\mathcal{D}', 0})$, for $\mathcal{D}' \in V$ is equisingular, see [25, p. 462].)

Definition 6.2 (Wedges and polar rate). Let s be the first exponent p_j for which the coefficient $a_j(\mathcal{D}')$ is non constant, i.e., it depends on $\mathcal{D}' \in V$. For $\alpha > 0$, define

$$B_0 := \{(x, y) : \left| y - \sum_{j \geq 1} a_j x^{p_j} \right| \leq \alpha |x|^s\}.$$

We call B_0 a Δ -wedge (about Δ_0). Let A_0 be the germ of the closure of the connected component of $\ell^{-1}(B_0) \setminus \{0\}$ which contains Π_0 . We call A_0 a *polar*

wedge (about Π_0). We call s a *polar rate* or *the rate of A_0* (resp. B_0). As described in [1], instead of B_0 one can use $B'_0 := \{(x, y) : |y - \sum_{j \geq 1, p_j \leq s} a_j x^{p_j}| \leq \alpha |x|^s\}$, since truncating higher-order terms does not change the bilipschitz geometry.

Clearly B_0 is a $D(s)$ -piece. Moreover:

Proposition 6.3 (Proposition 3.4(2) of [1]). *A polar wedge A_0 with rate s is a $D(s)$ -piece. \square*

The proof in [1] shows that A_0 can be approximated to high order by a set $A'_0 = \bigcup_{|t| \leq \beta} \Pi_{\mathcal{D}_t, 0}$ for some $\beta > 0$, where $t \in \mathbb{C}$, $|t| \leq \beta$ parametrizes a piece of a suitable line through \mathcal{D} in $\mathbf{G}(n-2, n)$. We will need some of the details later, so we describe this here.

We can choose coordinates (z_1, \dots, z_n) in \mathbb{C}^n and (x, y) in \mathbb{C}^2 so that ℓ is the projection $(x, y) = (z_1, z_2)$ and that the family of plane projections $\ell_{\mathcal{D}_t}$ used in [1] is $\ell_{\mathcal{D}_t} : (z_1, \dots, z_n) \rightarrow (z_1, z_2 - tz_3)$.

In [1] it is shown that A'_0 can be parametrized as a union of the curves $\Pi_{\mathcal{D}_t, 0}$ in terms of parameters (u, v) as follows:

$$\begin{aligned} z_1 &= u^N \\ z_2 &= u^N f_{2,0}(u) + v^2 u^{Ns} h_2(u, v) \\ z_j &= u^N f_{j,0}(u) + v u^{Ns} h_j(u, v), \quad j = 3, \dots, n \\ \Pi_{\mathcal{D}_t, 0} &= \{(z_1, \dots, z_n) : v = t\}, \end{aligned}$$

where $h_2(u, v)$ is a unit.

We then have $A_0 = \{(u, v) : |v^2 h_2(u, v)| \leq \alpha\}$, which agrees up to order $> s$ with $A'_0 = \{(u, v) : |v| \leq \beta\}$ with $\beta = \sqrt{\alpha/|h_2(0, 0)|}$.

In [1] it was also pointed out that at least one $h_j(u, v)$ with $j \geq 3$ is a unit, by a modification of the argument of Teissier [25, p. 464, lines 7–11]. We will show this using our explicit choice of coordinates above.

Lemma 6.4. *$h_3(u, v)$ is a unit. More specifically, writing $h_2(u, v) = \sum_{i \geq 0} v^i f_{i+2}(u)$, we have $h_3(u, v) = \sum_{i \geq 0} v^i \frac{i+2}{i+1} f_{i+2}(u)$.*

Proof. Make the change of coordinates $z'_2 := z_2 - tz_3$, so $\ell_{\mathcal{D}_t}$ is the projection to the (z_1, z'_2) -plane. Since $\Pi_{\mathcal{D}_t, 0}$ is given by $v = t$ in our (u, v) coordinates, we change coordinates to (u, w) with $w := v - t$, so that $\Pi_{\mathcal{D}_t, 0}$ has equation $w = 0$. We then know from above that z'_2 must have the form

$$z'_2 = u^N f'_{2,0}(u) + w^2 u^{Ns} h'_2(u, w)$$

with $h'_2(u, w)$ a unit. On the other hand, we rewrite the expressions for z_2, z_3 explicitly as

$$\begin{aligned} z_2 &= u^N f_{2,0}(u) + u^{Ns} \sum_{i \geq 2} v^i f_i(u) \\ z_3 &= u^N f_{3,0}(u) + u^{Ns} \sum_{i \geq 1} v^i g_i(u). \end{aligned}$$

Then direct calculation from

$$\begin{aligned} z_2 &= u^N f_{2,0}(u) + u^{Ns} \sum_{i \geq 2} (w+t)^i f_i(u) \\ z_3 &= u^N f_{3,0}(u) + u^{Ns} \sum_{i \geq 1} (w+t)^i g_i(u) \end{aligned}$$

gives:

$$\begin{aligned} z_2' &= z_2 - tz_3 \\ &= u^N (f_{2,0}(u) - tf_{3,0}(u)) + u^{Ns} \left[\sum_{i \geq 1} t^{i+1} (f_{i+1}(u) - g_i(u)) \right. \\ &\quad \left. + w \sum_{i \geq 1} t^i ((i+1)f_{i+1}(u) - ig_i(u)) \right. \\ &\quad \left. + w^2 (f_2(u) + t(3f_3(u) - g_2(u)) + t^2(6f_4(u) - 3g_3(u))) + \dots \right]. \end{aligned}$$

The part of this expression of degree 1 in w must be zero, so $g_i(u) = \frac{i+1}{i} f_{i+1}(u)$ for each i . Thus

$$\begin{aligned} z_3 &= u^N f_{3,0}(u) + u^{Ns} \sum_{i \geq 1} v^i \frac{i+1}{i} f_{i+1}(u) \\ &= u^N f_{3,0}(u) + vu^{Ns} \sum_{i \geq 0} v^i \frac{i+2}{i+1} f_{i+2}(u), \end{aligned}$$

completing the proof. \square

For $x \in X$, we define the *local bilipschitz constant* $K(x)$ of the projection $\ell_{\mathcal{D}}: X \rightarrow \mathbb{C}^2$ as follows: $K(x)$ is infinite if x belongs to the polar curve $\Pi_{\mathcal{D}}$, and at a point $x \in X \setminus \Pi_{\mathcal{D}}$ it is the reciprocal of the shortest length among images of unit vectors in $T_x X$ under the projection $d\ell_{\mathcal{D}}: T_x X \rightarrow \mathbb{C}^2$.

For $K_0 \geq 1$, set $\mathcal{B}_{K_0} := \{p \in X \cap (B_\epsilon \setminus \{0\}) : K(p) \geq K_0\}$, and let $\mathcal{B}_{K_0}(\Pi_0)$ denote the closure of the connected component of $\mathcal{B}_{K_0} \setminus \{0\}$ which contains $\Pi_0 \setminus \{0\}$. As a consequence of [1, 3.3, 3.4(1)], we obtain that for $K_0 > 1$ sufficiently large, the set \mathcal{B}_{K_0} can be approximated by a polar wedge about Π_0 . Precisely:

Proposition 6.5. *There exist $K_0, K_1 \in \mathbb{R}$ with $1 < K_1 < K_0$ such that*

$$\mathcal{B}_{K_0}(\Pi_0) \subset A_0 \cap B_\epsilon \subset \mathcal{B}_{K_1}(\Pi_0) \quad \square$$

Let us consider again a component Π_0 of Π and a polar wedge A_0 around it, the corresponding component Δ_0 of Δ and Δ -wedge B_0 , and let s be their polar rate. Let γ be an irreducible curve having contact $r \geq s$ with Δ_0 . The following Lemma establishes a relation between r and the geometry of the components of the lifting $\ell^{-1}(\gamma)$ in the polar wedge A_0 about Π_0 . This will be a key argument in Part 4 of the paper (see proof of Lemma 19.3). It will also be used in section 12 to explicitly compute some polar rates.

We choose coordinates in \mathbb{C}^n as before, with $\ell = (z_1, z_2)$ our generic projection. Recall the Puiseux expansion of a component Δ_0 of the discriminant:

$$z_2 = \sum_{i \geq N} a_i z_1^{i/N} \in \mathbb{C}\{z_1^{1/N}\}.$$

Lemma 6.6. *Let $(\gamma, 0)$ be an irreducible germ of curve in $(\mathbb{C}^2, 0)$ with Puiseux expansion:*

$$z_2 = \sum_{i \geq N} a_i z_1^{i/N} + \lambda z_1^r,$$

with $r \geq s$, $rN \in \mathbb{Z}$ and $\lambda \in \mathbb{C}$, $0 < \lambda \ll 1$. Let L'_γ be the intersection of the lifting $L_\gamma = \ell^{-1}(\gamma)$ with a polar wedge A_0 around Π_0 and let ℓ' another generic plane projection for X which is also generic for the curve $\ell^{-1}(\gamma)$. Then the rational number $q(r) := \frac{s+r}{2}$ is determined by the topological type of the curve $\ell'(L'_\gamma)$.

Proof. We first consider the case $r > s$. Using again the parametrization of A'_0 given after the statement of Proposition 6.3, the curve L'_γ has z_2 coordinate satisfying $z_2 = u^N f_{2,0}(u) + v^2 u^{Ns} h_2(u, v) = u^N f_{2,0}(u) + \lambda u^{Nr}$, so $v^2 u^{Ns} h_2(u, v) = \lambda u^{Nr}$. Write $g(u, v) = v^2 h_2(u, v) - \lambda u^{N(r-s)}$. Since $h_2(u, v)$ is a unit, we have $g(0, v) \neq 0$, so we can write v as a Puiseux expansion in terms of u as follows:

(1) If $N(r-s)$ is odd then we have one branch

$$v = \sqrt{\frac{\lambda}{h_2(0,0)}} u^{\frac{N(r-s)}{2}} + \sum_{i > N(r-s)} a_i u^{i/2} \in \mathbb{C}\{u^{1/2}\}.$$

(2) If $N(r-s)$ is even we have two branches

$$v = \pm \sqrt{\frac{\lambda}{h_2(0,0)}} u^{\frac{N(r-s)}{2}} + \sum_{i > \frac{N(r-s)}{2}} b_i^\pm u^i \in \mathbb{C}\{u\}.$$

Inserting into the parametrization of A'_0 we get that L'_γ is given by:

$$\begin{aligned} z_1 &= u^N \\ z_2 &= u^N f_{2,0}(u) + \lambda u^{Nr} \\ z_j &= u^N f_{j,0}(u) + \sqrt{\frac{\lambda}{h_2(0,0)}} h_j(0,0) u^{\frac{N(r+s)}{2}} + h.o., \quad j = 3, \dots, n, \end{aligned}$$

where ‘‘h.o.’’ means higher order terms in u . Notice that L'_γ has one or two branches depending on the parity of $N(r+s)$.

Taking $\ell' = \ell_{\mathcal{D}_t}$ for some t , the curve $\ell'(L'_\gamma)$ is given by (since $r > \frac{r+s}{2}$):

$$\begin{aligned} z_1 &= u^N \\ z'_2 &= u^N (f_{2,0}(u) - t f_{3,0}(u)) - t \sqrt{\frac{\lambda}{h_2(0,0)}} h_j(0,0) u^{\frac{N(r+s)}{2}} + h.o.. \end{aligned}$$

If $N(r+s)$ is odd, then $\ell'(L'_\gamma)$ has one component and $q(r) = \frac{s+r}{2}$ is an essential Puiseux exponent of its Puiseux expansion. Otherwise, $\ell'(L'_\gamma)$ has two components and $q(r)$ is the coincidence exponent between their Puiseux expansions. In both case, $q(r)$ is determined by the topological type of $\ell'(L'_\gamma)$.

Finally if $r = s$ then L'_γ consists to high order of two fibers of the saturation of A_0 by polars, so they have contact $q(r) = s$ with each other. \square

7. INTERMEDIATE AND COMPLETE CARROUSEL DECOMPOSITIONS OF THE DISCRIMINANT CURVE

In this section we define two carousel decompositions of $(\mathbb{C}^2, 0)$ with respect to the discriminant curve Δ of a generic plane projection $\ell: (X, 0) \rightarrow (\mathbb{C}^2, 0)$.

Intermediate carrousel decomposition. This is obtained by truncating the Puiseux series expansions of the branches of Δ as follows: if Δ_0 is a branch of Δ with Puiseux expansion $y = \sum_{i \geq 1} a_i x^{p_i}$ and if $s = p_k$ is the rate of a Δ -wedge about Δ_0 , then we consider the truncated Puiseux series $y = \sum_{i=1}^k a_i x^{p_i}$ and form the carrousel decomposition for these truncations (see the construction in Section 3). We call this the *(unamalgamated) intermediate carrousel decomposition*. Notice that a piece of this carrousel decomposition which contains a branch of Δ is in fact a Δ -wedge and is also a $D(s)$ -piece, where s is the rate of this Δ -wedge.

Using Lemma 2.5, we then amalgamate according to the following rules:

Amalgamation 7.1 (Intermediate carrousel decomposition).

- (1) We amalgamate any Δ -wedge piece with the piece outside it. We call the resulting pieces Δ -pieces,
- (2) We then amalgamate any D -piece which is not a Δ -piece with the piece outside it. This may create new D -pieces and we repeat this amalgamation iteratively until no further amalgamation is possible.

We call the result the *intermediate carrousel decomposition* of Δ .

It may happen that the rate s of the Δ -wedge piece about a branch Δ_0 of Δ is strictly less than the last characteristic exponent of Δ_0 . We give an example in [1]. That is why we call this carrousel decomposition “intermediate”.

Complete carrousel decomposition. This is obtained by truncating each Puiseux series expansion at the first term which has exponent greater than or equal to the polar rate and where truncation does not affect the topology of Δ . By definition, this carrousel decomposition refines the Δ -pieces of the intermediate carrousel decomposition whose rate is less than the last characteristic exponent of the branch of Δ they contain. We then amalgamate iteratively any D -pieces which do not contain components of Δ .

We call the result the *complete carrousel decomposition* of Δ .

The complete carrousel decomposition is a refinement of both the plain and the intermediate carrousel decompositions. In particular, according to Proposition 3.5, its combinatorics determine the topology of the curve Δ . In Section 13, we complete the proof of part (5) of Theorem 1.2 by proving that the outer Lipschitz geometry of $(X, 0)$ determines the combinatorics of a complete carrousel section of Δ .

We close this section with two examples illustrating carrousel sections.

Example 7.2. Let $(X, 0)$ be the D_5 singularity with equation $x^2y + y^4 + z^2 = 0$. The discriminant curve of the generic projection $\ell = (x, y)$ has two branches $y = 0$ and $x^2 + y^3 = 0$, giving us plain carrousel rates of 1 and $3/2$. In Example 12.1, we will compute the corresponding polar rates, which equal 2 and $5/2$ respectively, giving the additional rates which show up in the intermediate and complete carrousel sections. See also Example 9.4.

Figure 2 shows the sections of three different carrousel sections for the discriminant of the generic plane projection of the singularity D_5 : the plain carrousel, the unamalgamated and amalgamated complete carrousel decomposition. Note that in this example the intermediate and complete carrousel decompositions coincide. The Δ -pieces of the intermediate carrousel section are in gray, and the pieces they contain are D -pieces which are in fact Δ -wedge pieces since for both branches of Δ the polar rate is greater than the last characteristic exponent.

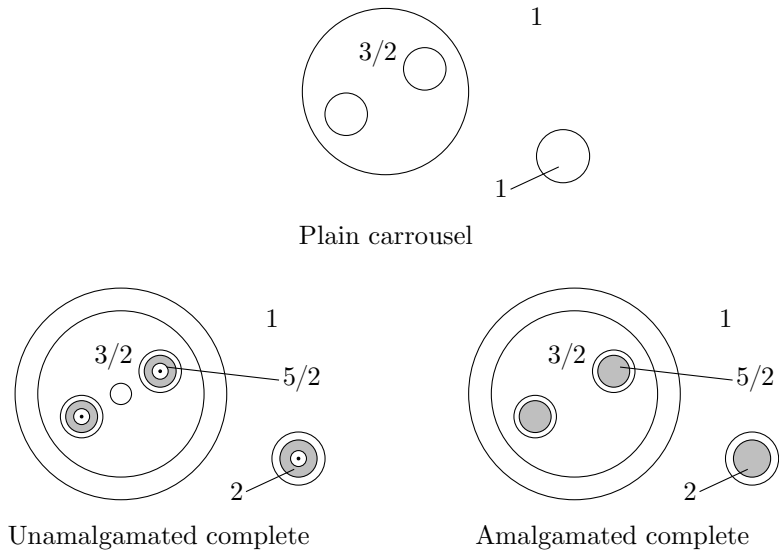

FIGURE 2. Carrousel sections for D_5

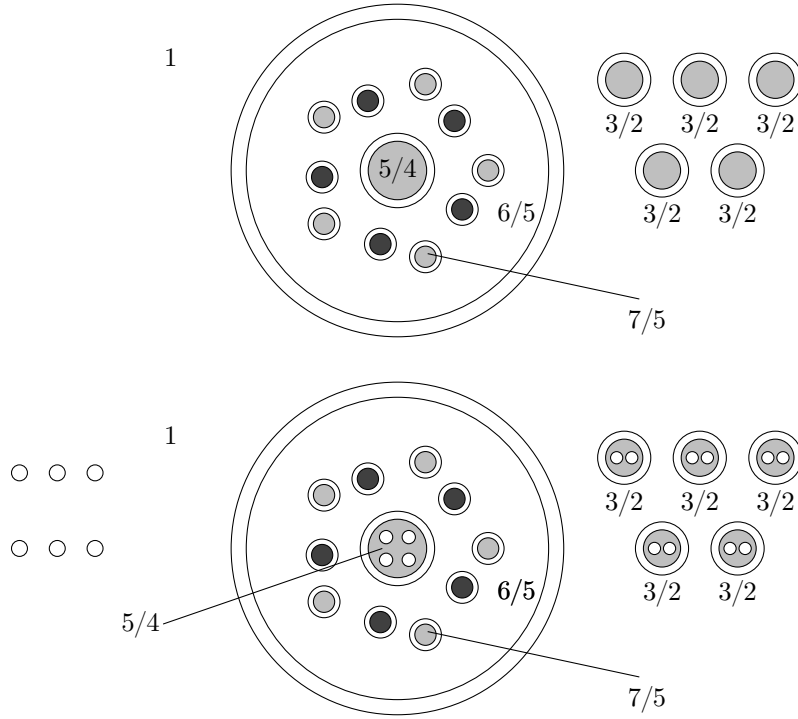

FIGURE 3. Carrousel sections for $(zx^2 + y^3)(x^3 + zy^2) + z^7 = 0$

Example 7.3. Our next example was already partially studied in [1]: the surface singularity $(X, 0)$ with equation $(zx^2 + y^3)(x^3 + zy^2) + z^7 = 0$.

In this case Δ has 14 branches with 12 distinct tangent lines L_1, \dots, L_{12} . Δ decomposes as follows:

- (1) Six branches, each lifting to a component of the polar in one of the two thick parts of X . Their tangent lines L_1, \dots, L_6 move as the linear projection is changed, so their polar rates are 1.
- (2) Five branches, each tangent to one of L_7, \dots, L_{11} , and with $3/2$ as single characteristic Puiseux exponent. So their Puiseux expansions have the form $u = a_i v + b_i v^{3/2} + \dots$. Their polar rates are $3/2$.
- (3) Three branches $\delta, \delta', \delta''$ tangent to the same line L_{12} , each with single characteristic Puiseux exponent, respectively $6/5, 6/5$ and $5/4$. Their Puiseux expansions have the form: $\delta : u = av + bv^{6/5} + \dots$, $\delta' : u = av + b'v^{6/5} + \dots$ and $\delta'' : u = av + b''v^{5/4} + \dots$. Their polar rates are respectively $7/5, 7/5, 5/4$.

The polar rates were given in [1, Example 15.2] except for the two with value $7/5$, whose computation is explained in Section 12. Figure 3 shows the intermediate carrousel section followed by the complete carrousel section. The gray regions in the intermediate carrousel section represent Δ -pieces with rates > 1 (the $B(1)$ -piece is also a Δ -piece).

8. GEOMETRIC DECOMPOSITION OF $(X, 0)$

In this section we describe the geometric decomposition of $(X, 0)$ as a union of semi-algebraic subgerms by starting with the unamalgamated intermediate carrousel decomposition of the discriminant curve of a generic plane projection, lifting it to $(X, 0)$, and then performing an amalgamation of some pieces.

Setup. From now on we assume $(X, 0) \subset (\mathbb{C}^n, 0)$ and our coordinates (z_1, \dots, z_n) in \mathbb{C}^n are chosen so that z_1 and z_2 are generic linear forms and $\ell := (z_1, z_2) : X \rightarrow \mathbb{C}^2$ is a generic linear projection for X . We denote by Π the polar curve of ℓ and by $\Delta = \ell(\Pi)$ its discriminant curve.

Instead of considering a standard ϵ -ball \mathbb{B}_ϵ as Milnor ball for $(X, 0)$, we will use, as in [1], a standard “Milnor tube” associated with the Milnor-Lê fibration for the map $h := z_1|_X : X \rightarrow \mathbb{C}$. Namely, for some sufficiently small ϵ_0 and some $R > 1$ we define for $\epsilon \leq \epsilon_0$:

$$B_\epsilon := \{(z_1, \dots, z_n) : |z_1| \leq \epsilon, |(z_1, \dots, z_n)| \leq R\epsilon\} \quad \text{and} \quad S_\epsilon = \partial B_\epsilon,$$

where ϵ_0 and R are chosen so that for $\epsilon \leq \epsilon_0$:

- (1) $h^{-1}(t)$ intersects the standard sphere $\mathbb{S}_{R\epsilon}$ transversely for $|t| \leq \epsilon$;
- (2) the polar curve Π and its tangent cone meet S_ϵ only in the part $|z_1| = \epsilon$.

The existence of such ϵ_0 and R is proved in [1, Section 4].

For any subgerm $(Y, 0)$ of $(X, 0)$, we write

$$Y^{(\epsilon)} := Y \cap S_\epsilon \subset S_\epsilon.$$

In particular, when Y is semi-algebraic and ϵ is sufficiently small, $Y^{(\epsilon)}$ is the ϵ -link of $(Y, 0)$.

We will now always work inside the Milnor balls B_ϵ just defined.

Definition 8.1. A *component* of a semi-algebraic germ $(A, 0)$ means the closure of a connected component of $(A \cap B_\epsilon) \setminus \{0\}$ for sufficiently small ϵ (i.e., the family of $B_{\epsilon'}$ with $\epsilon' \leq \epsilon$ should be a family of Milnor balls for A).

We lift the unamalgamated intermediate carrousel decomposition of Δ to $(X, 0)$ by ℓ . Any component of the inverse image of a piece of any one of the types $B(q)$, $A(q, q')$ or $D(q)$ is a piece of the same type from the point of view of its inner geometry (see [1] for details). By a “piece” of the decomposition of $(X, 0)$ we will always mean a component of the inverse image of a piece of $(\mathbb{C}^2, 0)$.

Amalgamation 8.2 (Amalgamation in X). We now simplify this decomposition of $(X, 0)$ by amalgamating pieces in the two following steps.

- (1) *Amalgamating polar wedge pieces.* We amalgamate any polar wedge piece with the piece outside it.
- (2) *Amalgamating empty D -pieces.* Whenever a piece of X is a $D(q)$ -piece containing no part of the polar curve (we speak of an *empty* piece) we amalgamate it with the piece which has a common boundary with it. Applying Lemma 2.5, these amalgamations may form new empty D -pieces. We continue this amalgamation iteratively until the only D -pieces contain components of the polar curve. Some $D(1)$ -pieces may be created during this process, and are then amalgamated with $B(1)$ -pieces.

Definition 8.3 (Polar piece). We call *polar pieces* the pieces resulting from these amalgamations which contain parts of the polar. They are all the D - and $A(q, q)$ -pieces and some of the B -pieces.

Remark 8.4. The inverse image of a Δ -wedge B_0 may consist of several pieces. All of them are D -pieces and at least one of them is a polar wedge in the sense of Definition 6.2. In fact a polar piece contains at most one polar wedge over B_0 . The argument is as follows. Assume B_0 is a polar wedge about the component Δ_0 of Δ . Let Π_0 be the component of Π such that $\Delta_0 = \ell(\Pi_0)$ and let N be the polar piece containing it. Assume Π'_0 is another component of Π inside N . According to [1, Section 3], $\Pi \cap N$ consists of equisingular components having pairwise contact s , i.e., $d(\Pi_0 \cap S_\epsilon, \Pi'_0 \cap S_\epsilon) = O(\epsilon^s)$. Since the projection $\ell_\Pi : \Pi \rightarrow \Delta$ is generic ([25, Lemme 1.2.2 ii]), we also have $d(\ell(\Pi_0 \cap S_\epsilon), \ell(\Pi'_0 \cap S_\epsilon)) = O(\epsilon^s)$. Therefore, if B_0 is small enough, we get $B_0 \cap \ell(\Pi'_0) = \{0\}$.

Except for the $B(1)$ -piece, each piece of the decomposition of $(\mathbb{C}^2, 0)$ has one “outer boundary” and some number (possibly zero) of “inner boundaries.” When we lift pieces to $(X, 0)$ we use the same terminology *outer boundary* or *inner boundary* for the boundary components of the component of the lifted pieces.

If q is the rate of some piece of $(X, 0)$ we denote by X_q the union of all pieces of X with this rate q . There is a finite collection of such rates $q_1 > q_2 > \dots > q_\nu$. In fact, $q_\nu = 1$ since $B(1)$ -pieces always exist, and X_1 is the union of the $B(1)$ -pieces. We can write $(X, 0)$ as the union

$$(X, 0) = \bigcup_{i=1}^{\nu} (X_{q_i}, 0) \cup \bigcup_{i>j} (A_{q_i, q_j}, 0),$$

where A_{q_i, q_j} is a union of intermediate $A(q_i, q_j)$ -pieces between X_{q_i} and X_{q_j} and the semi-algebraic sets X_{q_i} and A_{q_i, q_j} are pasted along their boundary components.

Definition 8.5 (Geometric decomposition). This decomposition is what we call the *geometric decomposition of $(X, 0)$* .

Note that the construction of pieces via carrousel involves choices which imply that, even after fixing a generic plane projection, the pieces are only well defined up to adding or removing collars of type $A(q, q)$ at their boundaries.

Definition 8.6 (Equivalence of pieces). We say that two pieces with same rate q are *equivalent*, if they can be made equal by attaching a collar of type $A(q, q)$ at each outer boundary and removing a collar of type $A(q, q)$ at each inner boundary. Similarly, two $A(q, q')$ -pieces are equivalent if they can be made equal by adding $A(q, q)$ collars at their outer boundary and removing $A(q', q')$ collars at their inner boundaries.

The following is immediate from Proposition 9.3 below:

Proposition 8.7. *The geometric decomposition is unique up to equivalence of the pieces.* \square

9. GEOMETRIC DECOMPOSITION THROUGH RESOLUTION

In this section, we describe the geometric decomposition using a suitable resolution of $(X, 0)$. We first need to describe the Nash modification of $(X, 0)$.

Definition 9.1 (Nash modification). Let $\lambda: X \setminus \{0\} \rightarrow \mathbf{G}(2, n)$ be the Gauss map which maps $x \in X \setminus \{0\}$ to the tangent plane $T_x X$. The closure \tilde{X} of the graph of λ in $X \times \mathbf{G}(2, n)$ is a reduced analytic surface. The *Nash modification of $(X, 0)$* is the induced morphism $\nu: \tilde{X} \rightarrow X$.

According to [22, Part III, Theorem 1.2], a resolution of $(X, 0)$ factors through the Nash modification if and only if it has no basepoints for the family of polar curves $\Pi_{\mathcal{D}}$ parametrized by $\mathcal{D} \in \Omega$.

In this section we consider the minimal good resolution $\pi: (\tilde{X}, E) \rightarrow (X, 0)$ with the following three properties:

- (1) it resolves the basepoints of a general linear system of hyperplane sections of $(X, 0)$ (i.e., it factors through the normalized blow-up of the maximal ideal of X);
- (2) it resolves the basepoints of the family of polar curves of generic plane projections (i.e., it factors through the Nash modification of X);
- (3) there are no adjacent nodes in the resolution graph (nodes are defined in Definition 9.2 below).

This resolution is obtained from the minimal good resolution of $(X, 0)$ by blowing up further until the basepoints of the two kinds are resolved and then by blowing up intersection points of exceptional curves corresponding to nodes.

We denote by Γ the dual resolution graph and by E_1, \dots, E_r the exceptional curves in E . We denote by v_k the vertex of Γ corresponding to E_k .

Definition 9.2. An \mathcal{L} -curve is an exceptional curve in $\pi^{-1}(0)$ which intersects the strict transform of a generic hyperplane section. The vertex of Γ representing an \mathcal{L} -curve is an \mathcal{L} -node.

A \mathcal{P} -curve (\mathcal{P} for “polar”) will be an exceptional curve in $\pi^{-1}(0)$ which intersects the strict transform of the polar curve of any generic linear projection. The vertex of Γ representing this curve is a \mathcal{P} -node.

A vertex of Γ is called a *node* if it is an \mathcal{L} - or \mathcal{P} -node or has valency ≥ 3 or represents an exceptional curve of genus > 0 .

A *string* of a resolution graph is a connected subgraph whose vertices have valency 2 and are not nodes, and a *bamboo* is a string attached to a non-node vertex of valency 1.

For each $k = 1, \dots, r$, let $N(E_k)$ be a small closed tubular neighbourhood of E_k and let

$$\mathcal{N}(E_k) = \overline{N(E_k) \setminus \bigcup_{k' \neq k} N(E_{k'})}.$$

For any subgraph Γ' of Γ define:

$$N(\Gamma') := \bigcup_{v_k \in \Gamma'} N(E_k) \quad \text{and} \quad \mathcal{N}(\Gamma') := \overline{N(\Gamma) \setminus \bigcup_{v_k \notin \Gamma'} N(E_k)}.$$

Proposition 9.3. *The pieces of the geometric decomposition of $(X, 0)$ (Definition 8.5) can be described as follows:*

For each node v_i of Γ , let Γ_i be v_i union any attached bamboos. Then, with “equivalence” defined as in Definition 8.6,

- (1) *the $B(1)$ -pieces are equivalent to the sets $\pi(\mathcal{N}(\Gamma_j))$ where v_j is an \mathcal{L} -node;*
- (2) *the polar pieces are equivalent to the sets $\pi(\mathcal{N}(\Gamma_j))$ where v_j is a \mathcal{P} -node;*
- (3) *the remaining $B(q)$ are equivalent to the sets $\pi(\mathcal{N}(\Gamma_j))$ where v_j is a node which is neither an \mathcal{L} -node nor a \mathcal{P} -node;*
- (4) *the $A(q, q')$ -pieces with $q \neq q'$ are equivalent to the $\pi(N(\sigma))$ where σ is a maximal string between two nodes.*

A straightforward consequence of this is that to each node v_j of Γ one can associate the rate q_j of the corresponding piece of the decomposition, and the graph Γ with nodes weighted by their rates determines the geometric decomposition $(X, 0) = \bigcup_{i=1}^r (X_{q_i}, 0) \cup \bigcup_{i>j} (A_{q_i, q_j}, 0)$ up to equivalence, proving the unicity stated in Proposition 8.7.

Before proving Proposition 9.3 we give two examples.

Example 9.4. Let $(X, 0)$ be the D_5 singularity with equation $x^2y + y^4 + z^2 = 0$. Carrousel decompositions for its discriminant Δ are described in Example 7.2.

Let v_1, \dots, v_5 be the vertices of its minimal resolution graph indexed as follows (all Euler weights are -2):

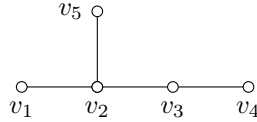

The multiplicities of a generic linear form h are given by the minimum of the compact part of the three divisors (x) , (y) and (z) : $(h \circ \pi) = E_1 + 2E_2 + 2E_3 + E_4 + E_5 + h^*$, where $*$ means strict transform. The minimal resolution resolves a general linear system of hyperplane sections and the strict transform of h is one curve intersecting E_3 . So v_3 is the single \mathcal{L} -node. But as we shall see, this is not yet the resolution which resolves the family of polars.

The total transform by π of the coordinate functions x, y and z are:

$$\begin{aligned} (x \circ \pi) &= 2E_1 + 3E_2 + 2E_3 + E_4 + 2E_5 + x^* \\ (y \circ \pi) &= E_1 + 2E_2 + 2E_3 + 2E_4 + E_5 + y^* \\ (z \circ \pi) &= 2E_1 + 4E_2 + 3E_3 + 2E_4 + 2E_5 + z^* . \end{aligned}$$

Set $f(x, y, z) = x^2y + y^4 + z^2$. The polar curve Π of a generic linear projection $\ell: (X, 0) \rightarrow (\mathbb{C}^2, 0)$ has equation $g = 0$ where g is a generic linear combination of the partial derivatives $f_x = 2xy$, $f_y = x^2 + 4y^3$ and $f_z = 2z$. The multiplicities of g are given by the minimum of the compact part of the three divisors

$$\begin{aligned} (f_x \circ \pi) &= 3E_1 + 5E_2 + 4E_3 + 3E_4 + 3E_5 + f_x^* \\ (f_y \circ \pi) &= 3E_1 + 6E_2 + 4E_3 + 2E_4 + 3E_5 + f_y^* \\ (f_z \circ \pi) &= 2E_1 + 4E_2 + 3E_3 + 2E_4 + 2E_5 + f_z^* . \end{aligned}$$

So the total transform of g is equal to:

$$(g \circ \pi) = 2E_1 + 4E_2 + 3E_3 + 2E_4 + 2E_5 + \Pi^* .$$

In particular, Π is resolved by π and its strict transform Π^* has two components Π_1^* and Π_2^* , which intersect respectively E_2 and E_4 .

Since the multiplicities $m_2(f_x) = 5$, $m_2(f_y) = 4$ and $m_2(z) = 6$ along E_2 are distinct, the family of polar curves of generic plane projections has a basepoint on E_2 . One must blow up once to resolve the basepoint, creating a new exceptional curve E_6 and a new vertex v_6 in the graph. So we obtain two \mathcal{P} -nodes v_4 and v_6 as in the resolution graph below (omitted Euler weights are -2):

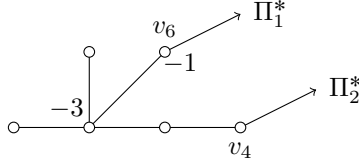

We will compute in Example 12.1 that the two polar rates are $5/2$ and 2 . It follows that the geometric decomposition of X consists of the pieces

$$X_{5/2} = \pi(\mathcal{N}(E_6)), \quad X_2 = \pi(\mathcal{N}(E_4)), \quad X_{3/2} = \pi(\mathcal{N}(E_1 \cup E_2 \cup E_5)) \text{ and } X_1 = \pi(\mathcal{N}(E_3)),$$

plus intermediate A-pieces, and that $X_{5/2}$ and X_2 are the two polar pieces. The geometric decomposition for D_5 is described by Γ with vertices v_i weighted with the corresponding rates q_i :

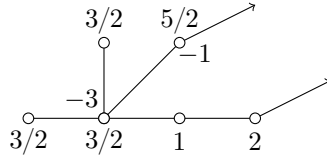

Example 9.5. We return to example 7.3 with equation $(zx^2 + y^3)(x^3 + zy^2) + z^7 = 0$, to clarify how the carrousel described there arise.

We first compute some invariants from the equation. The following picture shows the resolution graph of a general linear system of hyperplane sections. The negative numbers are self-intersection of the exceptional curves while numbers in parentheses are the multiplicities of a generic linear form.

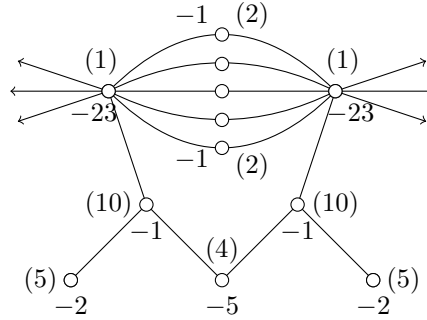

Set $f(x, y, z) = (zx^2 + y^3)(x^3 + zy^2) + z^7$. The multiplicities of the partial derivatives $(m(f_x), m(f_y), m(f_z))$ are given by:

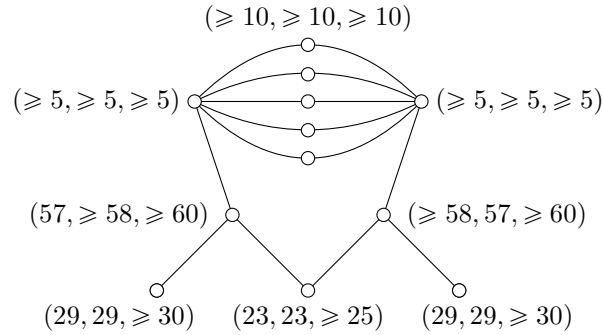

The basepoints of the family of polar curves of generic plane projections are resolved by this resolution and the strict transform of the generic polar curve Π_ℓ is given by the following graph. The multiplicities are those of a generic linear combination $g = af_x + bf_y + cf_z$.

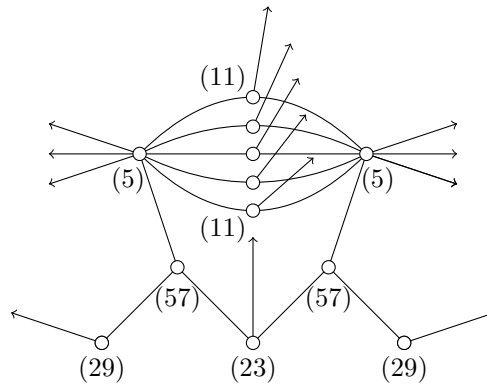

We now indicate on the resolution graph the rate corresponding to each vertex.

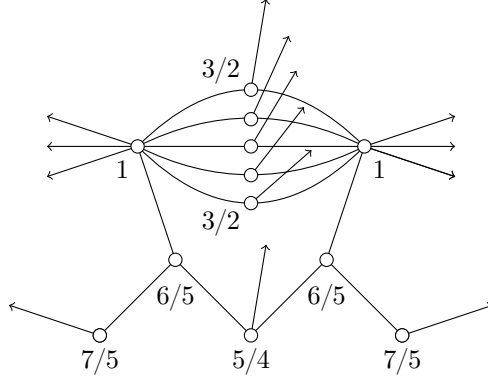

These rates were computed in [1] except for the rates $7/5$ which are explained in Section 12

Proof of Proposition 9.3. Let $\rho: Y \rightarrow \mathbb{C}^2$ be the minimal sequence of blow-ups starting with the blow-up of $0 \in \mathbb{C}^2$ which resolves the basepoints of the family of images $\ell(\Pi_{\mathcal{D}})$ by ℓ of the polar curves of generic plane projections and let Δ be some $\ell(\Pi_{\mathcal{D}})$. We set $\rho^{-1}(0) = \bigcup_{k=1}^m C_k$, where C_1 is the first curve blown up.

Denote by R the dual graph of ρ , so v_1 is its root vertex. We call a Δ -curve an exceptional curve in $\rho^{-1}(0)$ intersecting the strict transform of Δ , and a Δ -node a vertex of R which represents a Δ -curve. We call any vertex of R which is either v_1 or a Δ -node or a vertex with valency ≥ 3 a *node of R* .

If two nodes are adjacent, we blow up the intersection points of the two corresponding curves in order to create a string between them.

Consider the intermediate carousel decomposition of Δ after amalgamation of the Δ -wedge pieces (so we don't amalgamate any other piece here). This carousel decomposition can be described as follows:

- Lemma 9.6.**
- (1) *The $B(1)$ -piece is equivalent to the set $\rho(\mathcal{N}(C_1))$;*
 - (2) *the Δ -pieces are equivalent to the sets $\rho(\mathcal{N}(C_k))$ where v_k is a Δ -node;*
 - (3) *the remaining B -pieces are equivalent to the sets $\rho(\mathcal{N}(C_k))$ where v_k is a node which is neither v_1 nor a Δ -node;*
 - (4) *the empty D -pieces are equivalent to the sets $\rho(\mathcal{N}(\beta))$ where β is a bamboo of R ;*
 - (5) *the A -pieces are equivalent to the sets $\rho(\mathcal{N}(\sigma))$ where σ is a maximal string between two nodes.*

Proof of Lemma 9.6. Let B_κ be a B -piece as defined in section 3:

$$B_\kappa := \left\{ (x, y) : \alpha_\kappa |x^{p_k}| \leq |y - \sum_{i=1}^{k-1} a_i x^{p_i}| \leq \beta_\kappa |x^{p_k}| \right. \\ \left. |y - (\sum_{i=1}^{k-1} a_i x^{p_i} + a_{kj} x^{p_k})| \geq \gamma_\kappa |x^{p_k}| \text{ for } j = 1, \dots, m_\kappa \right\}$$

with $\alpha_\kappa, \beta_\kappa, \gamma_\kappa$ satisfying $\alpha_\kappa < |a_{kj}| - \gamma_\kappa < |a_{kj}| + \gamma_\kappa < \beta_\kappa$ for each $j = 1, \dots, m_\kappa$.

Then B_κ is foliated by the complex curves $C_\lambda, \lambda \in \Lambda$ with Puiseux expansions:

$$y = \sum_{i=1}^{k-1} a_i x^{p_i} + \lambda x^{p_k},$$

where $\Lambda = \{\lambda \in \mathbb{C}; \alpha_\kappa \leq |\lambda| \leq \beta_\kappa \text{ and } |\lambda - a_{kj}| \geq \gamma_\kappa, j = 1, \dots, m_\kappa\}$. The curves C_λ are irreducible and equisingular in terms of strong simultaneous resolution, and $B_\kappa = \rho(\mathcal{N}(C))$ where C is the exceptional component of $\rho^{-1}(0)$ which intersects the strict transforms C_λ^* .

We use again the notations of Section 3. The $B(1)$ -piece is the closure of the cones $V^{(j)}, j = 1, \dots, m$, so it is foliated by the complex lines with equations $y = ax$, where $a \in \mathbb{C}$ is such that $|a_1^{(j)} - a| \geq \eta$ for all $j = 1, \dots, m$. This implies (1) since C_1 is the exceptional curve which intersects the strict transform of those lines.

Recall that a Δ -piece is a B -piece obtained by amalgamating Δ -wedges with a B -piece outside them. By Definition 6.2, a Δ -wedge is foliated by curves $y = \sum_{p_j \leq s} a_j x^{p_j} + ax^s$, which are resolved in family by the resolution ρ , their strict transforms intersecting a Δ -node. This proves (2) and then (3).

(5) and (4) immediately follow from the fact that the A - and D -pieces are the closures of the complement of the B -pieces. \square

We now complete the proof of Proposition 9.3. Let $\pi': X' \rightarrow X$ be the Hirzebruch-Jung resolution of $(X, 0)$ obtained by pulling back the morphism ρ by the cover ℓ and then normalizing and resolving the remaining quasi-ordinary singularities. We denote its dual graph by Γ' . Denote by $\ell': X' \rightarrow Y$ the morphism defined by $\ell \circ \pi' = \rho \circ \ell'$. Denote E'_j the exceptional curve in $\pi'^{-1}(0)$ associated with the vertex v_j of Γ' .

Then π' factors through π and there is a birational morphism $\tilde{\ell}: \tilde{X} \rightarrow Y$ such that $\ell \circ \pi = \rho \circ \tilde{\ell}$. We can adjust the plumbing neighbourhoods $N(E_i)$ of the exceptional curves of $\pi^{-1}(0)$ in such a way that for each vertex v_k of $\rho^{-1}(0)$, $\tilde{\ell}^{-1}(N(C_k))$ is the union of the $N(E_i)$'s such that E_i maps to C_k by $\tilde{\ell}$. In particular, we have the following two correspondences: the inverse image by $\tilde{\ell}$ of a maximal string of exceptional curves in $\rho^{-1}(0)$ is a union of strings of exceptional curves in $\pi^{-1}(0)$; for each node (resp. \mathcal{P} -node, resp. \mathcal{L} -node) v_i of Γ , ℓ maps E_i birationally to a C_k where v_k is a node (resp. Δ -node, resp. the root v_1) of R .

We then obtain that for each node (resp. \mathcal{P} -node, resp. \mathcal{L} -node) v_i of Γ , the set $\pi(\mathcal{N}(E_i))$ is a connected component of $\ell^{-1}(\mathcal{N}(C_k))$ where v_k is a node (resp. a \mathcal{P} -node, resp. the root v_1) of R , and Proposition 9.3 is now a straightforward consequence of Lemma 9.6 \square

Part 3: Analytic invariants from Lipschitz geometry

10. GENERAL HYPERPLANE SECTIONS AND MAXIMAL IDEAL CYCLE

In this section we prove parts (1) to (3) of Theorem 1.2 in the Introduction.

We need some preliminary results about the relationship between thick-thin decomposition and resolution graph and about the usual and metric tangent cones.

We will use the Milnor balls B_ϵ for $(X, 0) \subset (\mathbb{C}^n, 0)$ defined at the beginning of Section 8, which are associated with the choice of a generic linear plane projection $\ell = (z_1, z_2): \mathbb{C}^n \rightarrow \mathbb{C}^2$, and we consider again the generic linear form $h := z_1|_X: X \rightarrow \mathbb{C}$. Recall that we denote by $A^{(\epsilon)} := A \cap S_\epsilon$ (with $S_\epsilon = \partial B_\epsilon$) the link of any semi-algebraic subgerm $(A, 0) \subset (X, 0)$ for ϵ sufficiently small.

Thick-thin decomposition and resolution graph. According to [1], the thick-thin decomposition of $(X, 0)$ is determined up to homeomorphism close to the identity by the inner Lipschitz geometry, and hence by the outer Lipschitz geometry

(specifically, the homeomorphism $\phi: (X, 0) \rightarrow (X, 0)$ satisfies $d(p, \phi(p)) \leq |p|^q$ for some $q > 1$). It is described through resolution as follows. The thick part $(Y, 0)$ is the union of semi-algebraic sets which are in bijection with the \mathcal{L} -nodes of any resolution which resolves the basepoints of a general linear system of hyperplane sections. More precisely, let us consider the minimal good resolution $\pi': (X', E) \rightarrow (X, 0)$ of this type and let Γ be its resolution graph. Let v_1, \dots, v_r be the \mathcal{L} -nodes of Γ . For each $i = 1, \dots, r$ consider the subgraph Γ_i of Γ consisting of the \mathcal{L} -node v_i plus any attached bamboos (ignoring \mathcal{P} -nodes). Then the thick part is given by:

$$(Y, 0) = \bigcup_{i=1}^r (Y_i, 0) \quad \text{where} \quad Y_i = \pi'(N(\Gamma_i)).$$

Let $\Gamma'_1, \dots, \Gamma'_s$ be the connected components of $\Gamma \setminus \bigcup_{i=1}^r \Gamma_i$. Then the thin part is:

$$(Z, 0) = \bigcup_{j=1}^s (Z_j, 0) \quad \text{where} \quad Z_j = \pi'(\mathcal{N}(\Gamma'_j)).$$

We call the links $Y_i^{(\epsilon)}$ and $Z_j^{(\epsilon)}$ *thick and thin zones* respectively.

Inner geometry and \mathcal{L} -nodes. Since the graph Γ_i is star-shaped, the thick zone $Y_i^{(\epsilon)}$ is a Seifert piece in a graph decomposition of the link $X^{(\epsilon)}$. Therefore the inner Lipschitz geometry already tells us a lot about the location of \mathcal{L} -nodes: for a thick zone $Y_i^{(\epsilon)}$ with unique Seifert fibration (i.e., not an S^1 -bundle over a disk or annulus) the corresponding \mathcal{L} -node is determined in any negative definite plumbing graph for the pair $(X^{(\epsilon)}, Y_i^{(\epsilon)})$. However, a thick zone may be a solid torus $D^2 \times S^1$ or toral annulus $I \times S^1 \times S^1$. Such a zone corresponds to a vertex on a chain in the resolution graph (i.e., a subgraph whose vertices have valency 1 or 2 and represent curves of genus 0) and different vertices along the chain correspond to topologically equivalent solid tori or toral annuli in the link $X^{(\epsilon)}$. Thus, in general inner Lipschitz geometry is insufficient to determine the \mathcal{L} -nodes and we need to appeal to the outer metric.

Tangent cones. We will use the Bernig-Lytchak map $\phi: \mathcal{T}_0(X) \rightarrow T_0(X)$ between the metric tangent cone $\mathcal{T}_0(X)$ and the usual tangent cone $T_0(X)$ ([3]). We will need its description as given in [1, Section 9].

The linear form $h: X \rightarrow \mathbb{C}$ restricts to a fibration $\zeta_j: Z_j^{(\epsilon)} \rightarrow \mathbb{S}_\epsilon^1$, and, as described in [1, Theorem 1.7], the components of the fibers have inner diameter $o(\epsilon^q)$ for some $q > 1$. If one scales the inner metric on $X^{(\epsilon)}$ by $\frac{1}{\epsilon}$ then in the Gromov-Hausdorff limit as $\epsilon \rightarrow 0$ the components of the fibers of each thin zone collapse to points, so each thin zone collapses to a circle. On the other hand, the rescaled thick zones are basically stable, except that their boundaries collapse to the circle limits of the rescaled thin zones. The result is the link $\mathcal{T}^{(1)}X$ of the so-called metric tangent cone \mathcal{T}_0X (see [1, Section 9]), decomposed as

$$\mathcal{T}^{(1)}X = \lim_{\epsilon \rightarrow 0}^{GH} \frac{1}{\epsilon} X^{(\epsilon)} = \bigcup \mathcal{T}^{(1)}Y_i,$$

where $\mathcal{T}^{(1)}Y_i = \lim_{\epsilon \rightarrow 0}^{GH} \frac{1}{\epsilon} Y_i^{(\epsilon)}$, and these are glued along circles.

One can also consider $\frac{1}{\epsilon} X^{(\epsilon)}$ as a subset of $S_1 = \partial B_1 \subset \mathbb{C}^n$ and form the Hausdorff limit in S_1 to get the link $T^{(1)}X$ of the usual tangent cone T_0X (this is the same as taking the Gromov-Hausdorff limit for the outer metric). One thus

sees a natural branched covering map $\mathcal{T}^{(1)}X \rightarrow T^{(1)}X$ which extends to a map of cones $\phi: \mathcal{T}_0(X) \rightarrow T_0(X)$ (first described in [3]).

We denote by $T^{(1)}Y_i$ the piece of $T^{(1)}X$ corresponding to Y_i (but note that two different Y_i 's can have the same $T^{(1)}Y_i$).

Proof of (1) of Theorem 1.2. Let L_j be the tangent line to Z_j at 0 and h_j the map $h_j := h|_{\partial(L_j \cap B_\epsilon)}: \partial(L_j \cap B_\epsilon) \xrightarrow{\cong} \mathbb{S}_\epsilon^1$. We can rescale the fibration $h_j^{-1} \circ \zeta_j$ to a fibration $\zeta'_j: \frac{1}{\epsilon}Z_j^{(\epsilon)} \rightarrow \partial(L_j \cap B_1)$, and written in this form ζ'_j moves points distance $o(\epsilon^{q-1})$, so the fibers of ζ'_j are shrinking at this rate. In particular, once ϵ is sufficiently small the outer Lipschitz geometry of $\frac{1}{\epsilon}Z_j^{(\epsilon)}$ determines this fibration up to homotopy, and hence also up to isotopy, since homotopic fibrations of a 3-manifold to S^1 are isotopic (see e.g., [8, p. 34]).

Consider now a rescaled thick piece $M_i = \frac{1}{\epsilon}Y_i^{(\epsilon)}$. The intersection $K_i \subset M_i$ of M_i with the rescaled link of the curve $\{h = 0\} \subset (X, 0)$ is a union of fibers of the Seifert fibration of M_i . The intersection of a Milnor fiber of h with M_i gives a homology between K_i and the union of the curves along which a Milnor fiber meets ∂M_i , and by the previous paragraph these curves are discernible from the outer Lipschitz geometry, so the homology class of K_i in M_i is known. It follows that the number of components of K_i is known and K_i is therefore known up to isotopy, at least in the case that M_i has unique Seifert fibration. If M_i is a toral annulus the argument still works, but if M_i is a solid torus we need a little more care.

If M_i is a solid torus it corresponds to an \mathcal{L} -node which is a vertex of a bamboo. If it is the extremity of this bamboo then the map $\mathcal{T}^{(1)}Y_i \rightarrow T^{(1)}Y_i$ is a covering. Otherwise it is a branched covering branched along its central circle. Both the branching degree p_i and the degree d_i of the map $\mathcal{T}^{(1)}Y_i \rightarrow T^{(1)}Y_i$ are determined by the Lipschitz geometry, so we can compute d_i/p_i , which is the number of times the Milnor fiber meets the central curve of the solid torus M_i . A tubular neighbourhood of this curve meets the Milnor fiber in d_i/p_i disks, and removing it gives us a toral annulus for which we know the intersection of the Milnor fibers with its boundary, so we find the topology of $K_i \subset M_i$ as before.

We have thus shown that the Lipschitz geometry determines the topology of the link $\bigcup K_i$ of the strict transform of h in the link $X^{(\epsilon)}$. Denote $K'_i = K_i$ unless (M_i, K_i) is a knot in a solid torus, i.e., K_i is connected and M_i a solid torus, in which case put $K'_i = 2K_i$ (two parallel copies of K_i). The resolution graph we are seeking represents a minimal negative definite plumbing graph for the pair $(X^{(\epsilon)}, \bigcup K'_i)$, for $(X, 0)$. By [18] such a plumbing graph is uniquely determined by the topology. When decorated with arrows for the K_i only, rather than the K'_i , it gives the desired decorated resolution graph Γ . So Γ is determined by $(X, 0)$ and its Lipschitz geometry. \square

Proof of (2) of Theorem 1.2. Recall that $\pi': X' \rightarrow X$ denotes the minimal good resolution of $(X, 0)$ which resolves a general linear system of hyperplane sections. Denote by h^* the strict transform by π' of the generic linear form h and let $\bigcup_{k=1}^d E_k$ the decomposition of the exceptional divisor $\pi'^{-1}(0)$ into its irreducible components. By point (1) of the theorem, the Lipschitz geometry of $(X, 0)$ determines the resolution graph of π' and also determines $h^* \cdot E_k$ for each k . We therefore recover the total transform $(h) := \sum_{k=1}^d m_k(h)E_k + h^*$ of h (since $E_l \cdot (h) = 0$ for all $l = 1, \dots, d$ and the intersection matrix $(E_k \cdot E_l)$ is negative definite).

In particular, the maximal ideal cycle $\sum_{k=1}^d m_k(h)E_k$ is determined by the geometry, and the multiplicity of $(X, 0)$ also, since it is given by the intersection number $\sum_{k=1}^d m_k(h)E_k \cdot h^*$. \square

Proof of (3) of Theorem 1.2. Let H be the kernel of the generic linear form h and $K = X \cap H$ the hyperplane section. So

$$K \subset \bigcup_{i=1}^r \{\pi'(\mathcal{N}(E_i)) : E_i \text{ an } \mathcal{L}\text{-curve}\}.$$

For $i = 1, \dots, r$ the tangent cone of $K \cap \pi'(\mathcal{N}(E_i))$ at 0 is a union of lines, say $L_{i1} \cup \dots \cup L_{i\alpha_i}$. For $\nu = 1, \dots, \alpha_i$ denote by $K_{i\nu}$ the union of components of K which are tangent to $L_{i\nu}$. Note the curves E_i , $i = 1, \dots, r$ are the result of blowing up the maximal ideal $\mathfrak{m}_{X,0}$ and normalizing. If two of the curves E_i and E_j coincided before normalization, then we will have equalities of the form $L_{i\nu} = L_{j\nu'}$ with $i \neq j$ (whence also $K_{i\nu} = K_{j\nu'}$).

For fixed i and varying ν the curves $K_{i\nu}$ are in an equisingular family and hence have the same outer Lipschitz geometry. We must show that we can recover the outer Lipschitz geometry of $K_{i\nu}$ from the outer Lipschitz geometry of X . The argument is similar to that of the proof of Proposition 4.1. We consider a continuous arc γ_i inside $\pi'(\mathcal{N}(E_i))$ with the property that $d(0, \gamma(t)) = O(t)$. Then for all k sufficiently small, the intersection $X \cap B(\gamma_i(t), kt)$ consists of some number μ_i of 4-balls $D_1^4(t), \dots, D_{\mu_i}^4(t)$ with $d(D_j^4(t), D_k^4(t)) = O(t^{q_{jk}})$ before we change the metric by a bilipschitz homeomorphism. The q_{jk} are determined by the outer Lipschitz geometry of $(X, 0)$ and are still determined after a bilipschitz change of the metric by the same argument as the last part of the proof of 4.1. Moreover, they determine the outer Lipschitz geometry of $K_{i\nu}$, as in Section 4. They also determine the number m_i of components of $K_{i\nu}$ which are in $\pi'(\mathcal{N}(E_i))$.

By the above proof of (2) of Theorem 1.2, the number α_i of $K_{i\nu}$'s for fixed i is $(E_i \cdot h^*)/m_i$, and hence determined by the outer Lipschitz geometry of X . Since different $K_{i\nu}$'s have different tangent lines, the outer geometry of their union is determined, completing the proof. \square

11. DETECTING THE DECOMPOSITION

The aim of this section is to prove that the geometric decomposition $(X, 0) = \bigcup_{i=1}^{\nu} (X_{q_i}, 0) \cup \bigcup_{i>j} (A_{q_i, q_j}, 0)$ introduced in Sections 8 can be recovered up to equivalence (Definition 8.6) using the outer Lipschitz geometry of X . Specifically, we will prove:

Proposition 11.1. *The outer Lipschitz geometry of $(X, 0)$ determines a decomposition $(X, 0) = \bigcup_{i=1}^{\nu} (X'_{q_i}, 0) \cup \bigcup_{i>j} (A'_{q_i, q_j}, 0)$ into semi-algebraic subgerms $(X'_{q_i}, 0)$ and $(A'_{q_i, q_j}, 0)$ glued along their boundaries, where each $\overline{X'_{q_i}} \setminus X_{q_i}$ and $\overline{A'_{q_i, q_j}} \setminus A_{q_i, q_j}$ is a union of collars of type $A(q_i, q_i)$.*

So X'_{q_i} is obtained from X_{q_i} by adding an $A(q_i, q_i)$ collar on each outer boundary component of X_{q_i} and removing one at each inner boundary component, while A'_{q_i, q_j} is obtained from A_{q_i, q_j} by adding an $A(q_i, q_i)$ collar on each outer boundary component of A_{q_i, q_j} and removing an $A(q_j, q_j)$ collar at each inner boundary component.

The proof of Proposition 11.1 consists in discovering the polar pieces in the germ $(X, 0)$ by exploring them with small balls. Let us first introduce notation and sketch this method.

We will use the coordinates and the family of Milnor balls B_ϵ , $0 < \epsilon \leq \epsilon_0$ introduced in Section 8. We always work inside the Milnor ball B_{ϵ_0} and we reduce ϵ_0 when necessary.

Let $q_1 > q_2 > \dots > q_\nu = 1$ be the series of rates for the geometric decomposition of X . In this section we will assume that $\nu > 1$ so $q_1 > 1$.

For $x \in X$ define $\mathcal{B}(x, r)$ to be the component containing x of the intersection $B_r(x) \cap X$, where $B_r(x)$ is the ball of radius r about x in \mathbb{C}^n .

Definition 11.2. For a subset \mathcal{B} of X , define the *abnormality* $\alpha(\mathcal{B})$ of \mathcal{B} to be maximum ratio of inner to outer distance in X for pairs of distinct points in \mathcal{B} .

The idea of abnormality is already used by Henry and Parusiński to prove the existence of moduli in bilipschitz equivalence of map germs (see [11], Section 2).

Definition 11.3. We say a subset of $X \setminus \{0\}$ has *trivial topology* if it is contained in a topological ball which is a subset of $X \setminus \{0\}$. Otherwise, we say the subset has *essential topology*.

11.1. **Sketch.** Our method is based on the fact that a non-polar piece is “asymptotically flat” so abnormality of small balls inside it is close to 1, while a polar piece is “asymptotically curved” (Lemmas 11.5 and 11.8). It consists in detecting the polar pieces using sets $\mathcal{B}(x, a|x|^q)$ as “searchlights”. Figure 4 represents schematically a polar piece (in gray).

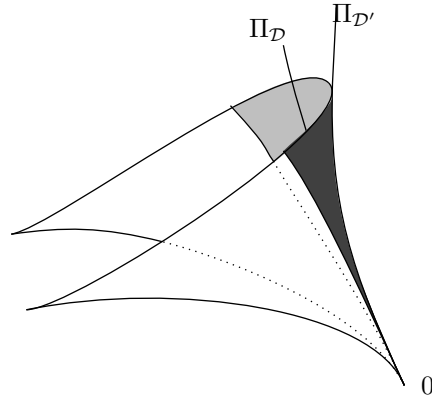

FIGURE 4. A polar piece

In order to get a first flavour of what will happen later, we will now visualize some pieces and some sets $\mathcal{B}(x, a|x|^q)$ by drawing their real slices. We call *real slice* of a real algebraic set $Z \subset \mathbb{C}^n$ the intersection of Z with $\{h = t\} \cap P$ where h is a generic linear form and P a general $(2n - 1)$ -plane in $\mathbb{C}^n \cong \mathbb{R}^{2n}$. We use again the notations of the previous sections: $\ell = (z_1, z_2)$ is a generic plane projection for $(X, 0)$ and $h = z_1|_X$.

We first consider a component $M \subset X_{q_i}$ of the geometric decomposition of $(X, 0)$ which is not a polar piece. We assume that $q_i > 1$ (so $i \in \{1, \dots, \nu - 1\}$) and that

the sheets of the cover $\ell|_X : X \rightarrow \mathbb{C}^2$ inside this zone have pairwise contact $> q_i$, i.e., there exists $q'_i > q_i$ such that for an arc γ_0 in M , all the arcs $\gamma'_0 \neq \gamma_0$ in $\ell^{-1}(\ell(\gamma_0))$ have contact at most q'_i with γ_0 and the contact q'_i is reached for at least one of these arcs.

In Figure 5 the dotted circles represent the boundaries of the real slices of balls $B(x, a|x|^q) \subset \mathbb{C}^n$ for some $x \in M$. The real slices of the corresponding sets $\mathcal{B}(x, a|x|^q) \subset X$ are the thickened arcs.

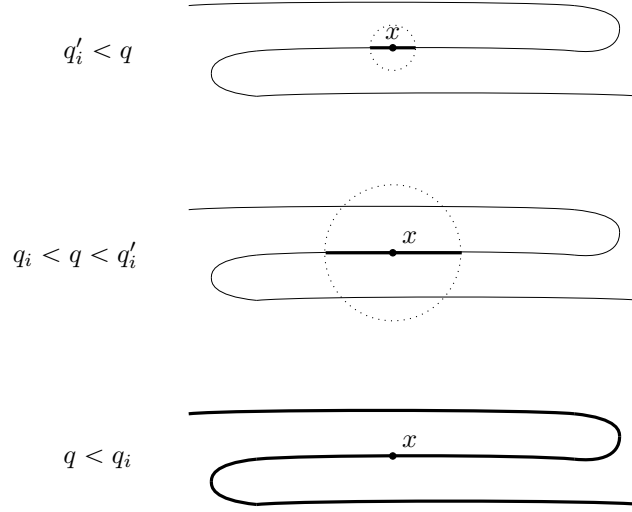

FIGURE 5. Balls through a non polar piece

Next, we consider a polar piece $N \subseteq X_{q_i}$. If $x \in N$ and a is large enough then $\mathcal{B}(x, a|x|^{q_i})$ either has essential topology or high abnormality (or both). Figure 6 represents the real slice of a ball $B(x, a|x|^{q_i})$ with $x \in N$ when $\mathcal{B}(x, a|x|^{q_i})$ has high abnormality. It includes the real slice of N which is the gray arc.

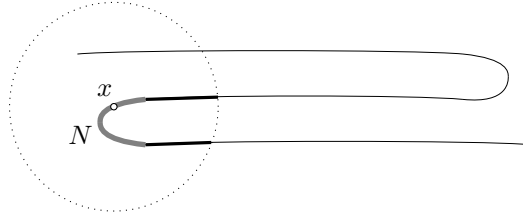

FIGURE 6.

The rest of the section is organized as follows. The aim of Subsections 11.2 and 11.3 is to specify the set $(X'_{q_1}, 0)$ of Proposition 11.1. This will be the first step of an induction carried out in Subsections 11.4 to 11.6 leading to the construction of subgerms $(X'_{q_i}, 0)$ and $(A'_{q_i, q_j}, 0) \subset (X, 0)$ having the properties stated in Proposition 11.1. Finally, the bilipschitz invariance of the germs $(X'_{q_i}, 0)$ and A'_{q_i, q_j} is proved in Subsection 11.7, completing the proof of Proposition 11.1.

11.2. Finding the rate q_1 .

Lemma 11.4. *Let $\ell: X \rightarrow \mathbb{C}^2$ be a general plane projection, and $A \subset X$ a union of polar wedges around the components of the polar curve for ℓ . If $x \in X$ and $r < |x|$ are such that $\mathcal{B}(x, r) \cap A = \emptyset$, then there exists $K > 1$ such that ℓ restricted to $\mathcal{B}(x, \frac{r}{K^2})$ is a K -bilipschitz homeomorphism onto its image. Moreover, $\mathcal{B}(x, \frac{r}{K^2})$ has trivial topology and abnormality $\leq K$.*

Proof. There exists K such that $\ell|_{\overline{X \setminus A}}$ is locally a K -bilipschitz map (see Section 6). Let $B(y, r) \subset \mathbb{C}^2$ denote the ball of radius r about $y \in \mathbb{C}^2$. Then $B(\ell(x), \frac{r}{K}) \subseteq \ell(\mathcal{B}(x, r))$. Let \mathcal{B} be the component of $\ell^{-1}(B(\ell(x), \frac{r}{K}))$ which is contained in $\mathcal{B}(x, r)$. So $\ell|_{\mathcal{B}}$ is a K -bilipschitz homeomorphism of \mathcal{B} onto its image $B(\ell(x), \frac{r}{K})$. Now $\mathcal{B}(x, \frac{r}{K^2}) \subseteq \mathcal{B}$, so $\mathcal{B}(x, \frac{r}{K^2})$ has trivial topology. Moreover, for each pair of points $x', x'' \in \mathcal{B}(x, \frac{r}{K^2})$, we have:

$$d_{\text{inner}}(x', x'') \leq K d_{\mathbb{C}^2}(\ell(x'), \ell(x'')).$$

On the other hand, $d_{\mathbb{C}^2}(\ell(x'), \ell(x'')) \leq d_{\text{outer}}(x', x'')$, so

$$d_{\text{inner}}(x', x'')/d_{\text{outer}}(x', x'') \leq K.$$

Thus $\alpha(\mathcal{B}(x, \frac{r}{K^2})) \leq K$. \square

- Lemma 11.5.** (1) *There exist $a > 0$, $K_1 > 1$ and $\epsilon_0 > 0$ such that for all $x \in X \cap B_{\epsilon_0}$ the set $\mathcal{B}(x, a|x|^{q_1})$ has trivial topology and abnormality at most K_1 .*
- (2) *For all $q > q_1$ and $a > 0$ there exist $K_1 > 1$ and $\epsilon_1 \leq \epsilon_0$ such that for all $x \in X \cap B_{\epsilon_0}$ the set $\mathcal{B}(x, a|x|^q)$ has trivial topology and abnormality at most K_1 .*
- (3) *For all $q < q_1$, $K_2 > 1$ and $a > 0$ there exist $\epsilon_1 \leq \epsilon_0$ such that for all $x \in X_{q_1} \cap B_{\epsilon_1}$ we have either $\alpha(\mathcal{B}(a|x|^q, x)) > K_2$ or $\mathcal{B}(x, a|x|^q)$ has essential topology.*

Before proving the lemma we note the following immediate corollary:

Proposition 11.6 (Finding q_1). *q_1 is the infimum of all q satisfying: There exists $K_1 > 0$ such that for all $a > 0$ there exists $\epsilon_1 > 0$ such that all sets $\mathcal{B}(x, a|x|^q)$ with $x \in X \cap B_{\epsilon_1}$ have trivial topology and abnormality at most K_1 .* \square

Proof of Lemma 11.5 (1) and (2). We just prove (1), since (2) follows immediately from (1), using that $\mathcal{B}(x, a|x|^q) = \mathcal{B}(x, a'|x|^{q_1})$ with $a' = a|x|^{q-q_1}$, which can be made as small as one wants by reducing ϵ_1 .

Let $\ell_{\mathcal{D}_1}: (X, 0) \rightarrow (\mathbb{C}^2, 0)$ and $\ell_{\mathcal{D}_2}: (X, 0) \rightarrow (\mathbb{C}^2, 0)$ be a generic pair of generic plane projections. For $i = 1, 2$ let A_i be a union of polar wedges around the components of the polar curve $\Pi_{\mathcal{D}_i}$.

Note that a polar wedge of rate s about a component Π_0 of the polar is, up to equivalence, the component containing Π_0 of a set of the form $\bigcup_{x \in \Pi_0} \mathcal{B}(x, c|x|^s)$, so we may take our polar wedges to be of this form, and we may choose c and ϵ_0 small enough that none of the polar wedges in A_1 and A_2 intersect each other in $B_{2\epsilon_0} \setminus \{0\}$. Now replace c by $c/4$ in the construction of the polar wedges. Since $q_1 \geq s$ for every polar rate s , for any $x \in (X \cap B_{\epsilon_0}) \setminus \{0\}$ the set $\mathcal{B}(x, c|x|^{q_1})$ is then disjoint from one of A_1 and A_2 . Thus part (1) of the lemma follows from Lemma 11.4, with K_1 chosen such that each restriction $\ell_{\mathcal{D}_i}$ to $(X \setminus A_i) \cap B_{2\epsilon}$ is a local K_1 -bilipschitz homeomorphism, and with $a = \frac{c}{K_1^2}$. \square

Proof of Lemma 11.5 (3). Fix $q < q_1$, $K_2 > 1$ and $a > 0$. We will deal with X_{q_1} component by component, so we assume for simplicity that X_{q_1} consists of a single component (see Definition 8.1).

Assume first that X_{q_1} is not a $D(q_1)$ -piece. Then it is a B -piece and there exist $\epsilon \leq \epsilon_0$ and $K > 1$ such that $X_{q_1} \cap B_\epsilon$ is K -bilipschitz equivalent to a standard model as in Definition 2.2. Let $x \in X_{q_1} \cap B_\epsilon$. If d is the diameter of the fiber F used in constructing the model then $\mathcal{B}(x, 2Kd|x|^{q_1})$ contains a shrunk copy of the fiber F . Then, if ϵ is small enough, $\mathcal{B}(x, a|x|^q)$ also contains a copy of F , since $q < q_1$. In [1] it is proved that F contains closed curves which are not null-homotopic in $X \setminus \{0\}$, so $\mathcal{B}(x, a|x|^q)$ has essential topology.

We now assume X_{q_1} is a $D(q_1)$ -piece. Consider the resolution $\pi: (\tilde{X}, E) \rightarrow (X, 0)$ with dual graph Γ defined in Section 9. We will use again the notations of Section 9. For each irreducible component of E , let $N(E_i)$ be a small closed tubular neighbourhood of E_i . Let Γ' be the subgraph of Γ which consists of the \mathcal{P} -node corresponding to X_{q_1} plus attached bamboos. After adjusting $N(E_i)$ if necessary, one can assume that the strict transform $\overline{\pi^{-1}(X_{q_1} \setminus \{0\})}$ of X_{q_1} by π is the set $\mathcal{N}(\Gamma')$ (see Proposition 9.3).

We set $E' = \bigcup_{v_i \in \Gamma'} E_i$ and $E'' = \overline{E \setminus E'}$.

Let $\hat{\alpha}_q: (X \setminus \{0\}) \times (0, \infty) \rightarrow [1, \infty)$ be the map which sends (x, a) to the abnormality $\alpha(\mathcal{B}(x, a|x|^q))$ and let $\tilde{\alpha}_q: (\tilde{X} \setminus E) \times (0, \infty) \rightarrow [1, \infty)$ be the lifting of $\hat{\alpha}_q$ by π . The intersection $E \cap \overline{\pi^{-1}(X_{q_1} \setminus \{0\})}$ is a compact set inside $E' \setminus E''$, so to prove Lemma 11.5 (3), it suffices to prove that for each $y \in E' \setminus E''$,

$$\lim_{\substack{x \rightarrow y \\ x \in \tilde{X} \setminus E}} \tilde{\alpha}_q(x, a) = \infty.$$

This follows from the following more general Lemma, which will be used again later. \square

Lemma 11.7. *Let N be a polar piece of rate q_i i.e., $N = \pi(\mathcal{N}(E(\Gamma')))$ where Γ' is a subgraph of Γ consisting of a \mathcal{P} -node plus any attached bamboo. Assume that the outer boundary of N is connected. Set $E' = \bigcup_{v_i \in \Gamma'} E_i$ and $E'' = \overline{E \setminus E'}$. Then for all $q < q_i$ and all $y \in E' \setminus E''$,*

$$\lim_{\substack{x \rightarrow y \\ x \in \tilde{X} \setminus E}} \tilde{\alpha}_q(x, a) = \infty.$$

The proof of Lemma 11.7 needs a preparatory Lemma 11.8.

Recall that the resolution π factors through the Nash modification $\nu: \tilde{X} \rightarrow X$. Let $\sigma: \tilde{X} \rightarrow \mathbf{G}(2, n)$ be the map induced by the projection $p_2: \tilde{X} \subset X \times \mathbf{G}(2, n) \rightarrow \mathbf{G}(2, n)$. The map σ is well defined on E and according to [10, Section 2] (see also [22, Part III, Theorem 1.2]), its restriction to E is constant on any connected component of the complement of \mathcal{P} -curves in E . The following lemma about limits of tangent planes follows from this:

Lemma 11.8. (1) *Let Γ' be a maximal connected component of Γ which does not contain any \mathcal{P} -node. There exists $P_{\Gamma'} \in \mathbf{G}(2, n)$ such that $\lim_{t \rightarrow 0} T_{\gamma(t)} X = P_{\Gamma'}$ for any real analytic arc $\gamma: ([0, \epsilon], 0) \rightarrow (\pi(N(\Gamma')), 0)$ with $|\gamma(t)| = O(t)$ and whose strict transform meets $\bigcup_{v \in \Gamma'} E_v$.*

(2) *Let $E_k \subset E$ be a \mathcal{P} -curve and $x \in E_k$ be a smooth point of the exceptional divisor E . There exists a plane $P_x \in \mathbf{G}(2, n)$ such that $\lim_{t \rightarrow 0} T_{\gamma(t)} X = P_x$ for any*

real analytic arc $\gamma: ([0, \epsilon], 0) \rightarrow (\pi(\mathcal{N}(E_k)), 0)$ with $|\gamma(t)| = O(t)$ and whose strict transform meets E at x . \square

Proof of Lemma 11.7. Let $y \in E' \setminus E''$ and let $\gamma: [0, \epsilon] \rightarrow X$ be a real analytic arc inside $N \cap B_\epsilon$ whose strict transform $\tilde{\gamma}$ by π meets E at y and such that $|\gamma(t)| = O(t)$. We then have to prove that

$$\lim_{t \rightarrow 0} \tilde{\alpha}_q(\tilde{\gamma}(t), a) = \infty.$$

Let B be the component of the unamalgamated intermediate carrousel such that the outer boundary of a component B' of $\ell^{-1}(B)$ is the outer boundary of N . Let $N' \subseteq N$ be B' with its polar wedges amalgamated, so that $\ell|_{N'}: N' \rightarrow \ell(N')$ is a branched cover of degree > 1 .

Then $\ell(N)$ has an $A(q'', q_i)$ annulus outside it for some q'' , which we will simply call $A(q'', q_i)$. The lift of $A(q'', q_i)$ by ℓ is a covering space. Denote by $\tilde{A}(q'', q_i)$ the component of this lift that intersects N ; it is connected since the outer boundary of N is connected, and the degree of the covering is > 1 since its inner boundary is the outer boundary of N' .

$\tilde{A}(q'', q_i)$ is contained in a $N(\Gamma')$ where Γ' is a \mathcal{P} -Tjurina component of the resolution graph Γ so we can apply part (1) of Lemma 11.8 to any suitable arc inside it. This will be the key argument later in the proof.

We will prove the lemma for q' with $q'' < q' < q_i$ since it is then certainly true for smaller q' .

Choose p' with $q' < p' < q_i$ and consider the arc $\gamma_0: [0, \epsilon] \rightarrow \mathbb{C}^2$ defined by $\gamma_0 = \ell \circ \gamma$ and the function

$$\gamma_s(t) := \gamma_0(t) + (0, st^{p'}) \quad \text{for } (s, t) \in [0, 1] \times [0, \epsilon].$$

We can think of this as a family, parametrized by s , of arcs $t \mapsto \gamma_s(t)$, or as a family, parametrized by t , of real curves $s \mapsto \gamma_s(t)$. For t sufficiently small $\gamma_1(t)$ lies in $\ell(\mathcal{B}(\gamma(t), a'|\gamma(t)|^q))$ and also lies in the $A(q'', q_i)$ mentioned above. Note that for any s the point $\gamma_s(t)$ is distance $O(t)$ from the origin.

We now take two different continuous lifts $\gamma_s^{(1)}(t)$ and $\gamma_s^{(2)}(t)$ by ℓ of the family of arcs $\gamma_s(t)$, for $0 \leq s \leq 1$, with $\gamma_0^{(1)} = \gamma$ and $\gamma_0^{(2)}$ also in N (possible since the covering degree of $\tilde{A}(q'', q_i) \rightarrow A(q'', q_i)$ is > 1). Since $q < p'$, $\gamma_s^{(1)}(t)$ and $\gamma_s^{(2)}(t)$ lie in $\mathcal{B}(\gamma(t), a'|\gamma(t)|^q)$ for each t, s .

To make notation simpler we set $P_1 = \gamma_1^{(1)}$ and $P_2 = \gamma_1^{(2)}$. Since the points $P_1(t)$ and $P_2(t)$ are on different sheets of the covering of $A(q'', q_i)$, a shortest path between them will have to travel through N , so its length $l_{inn}(t)$ satisfies $l_{inn}(t) = O(t^{p'})$.

We now give a rough estimate of the outer distance $l_{out}(t) = |P_1(t) - P_2(t)|$ which will be sufficient to show $\lim_{t \rightarrow 0} (l_{inn}(t)/l_{out}(t)) = \infty$, completing the proof. For this, we choose p'' with $p' < p'' < q_i$ and consider the arc $p: [0, \epsilon] \rightarrow \mathbb{C}^2$ defined by:

$$p(t) := \gamma_{s_t}(t) = \gamma_0(t) + (0, t^{p''}) \quad \text{with } s_t := t^{p''-p'},$$

and its two liftings $p_1(t) := \gamma_{s_t}^{(1)}(t)$ and $p_2(t) := \gamma_{s_t}^{(2)}(t)$, belonging to the same sheets of the cover ℓ as the arcs P_1 and P_2 . A real slice of the situation is represented in Figure 7.

The points $p_1(t)$ and $p_2(t)$ are inner distance $O(t^{p''})$ apart by the same argument as before, so their outer distance is at most $O(t^{p''})$. By Lemma 11.8 the line from $p(t)$ to $\gamma_1(t)$ lifts to almost straight lines which are almost parallel, from $p_1(t)$ to

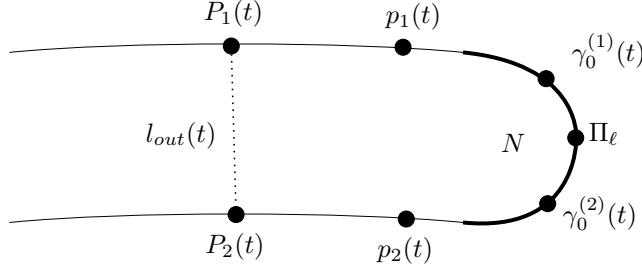

FIGURE 7.

$P_1(t)$ and from $p_2(t)$ to $P_2(t)$ respectively, with degree of parallelism increasing as $t \rightarrow 0$. Thus as we move from the pair $p_i(t)$, $i = 1, 2$ to the pair $P_i(t)$ the distance changes by $f(t)(t^{p'} - t^{p''})$ where $f(t) \rightarrow 0$ as $t \rightarrow 0$. Thus the outer distance $l_{out}(t)$ between the pair is at most $O(t^{p''}) + f(t)(t^{p'} - t^{p''})$. Dividing by $l_{inn}(t) = O(t^{p'})$ gives $l_{out}(t)/l_{inn}(t) = O(f(t))$, so $\lim_{t \rightarrow 0}(l_{out}(t)/l_{inn}(t)) = 0$. Thus $\lim_{t \rightarrow 0}(l_{inn}(t)/l_{out}(t)) = \infty$, completing the proof of Lemma 11.7. \square

11.3. Constructing X'_{q_1} .

Definition 11.9 (q -neighbourhood). Let $(U, 0) \subset (\hat{X}, 0) \subset (X, 0)$ be semi-algebraic sub-germs. A q -neighbourhood of $(U, 0)$ in $(\hat{X}, 0)$ is a germ $(N, 0) \supseteq (U, 0)$ with $N \subseteq \{x \in \hat{X} \mid d(x, U) \leq Kd(x, 0)^q\}$ for some K , using inner metric in $(\hat{X}, 0)$.

For $a > 0$ and $L > 1$, define:

$$Z_{q_1, a, L} := \bigcup \left\{ \mathcal{B}(x, a|x|^{q_1}) : \alpha(\mathcal{B}(x, a|x|^{q_1})) > L \text{ or } \right. \\ \left. \mathcal{B}(x, a|x|^{q_1}) \text{ has essential topology} \right\}$$

Lemma 11.10. For sufficiently large a and L and sufficiently small $\epsilon_1 \leq \epsilon_0$, the set $Z_{q_1, a, L} \cap B_{\epsilon_1}$ is a q_1 -neighbourhood of $X_{q_1} \cap B_{\epsilon_1}$ in $X \cap B_{\epsilon_1}$.

Proof. As before, to simplify notation we assume that $X_{q_1} \setminus \{0\}$ is connected, since otherwise we can argue component by component. The following three steps prove the lemma.

- (1) If X_{q_1} is not a D -piece there exists a_1 sufficiently large and ϵ sufficiently small that for each $a \geq a_1$ and $x \in X_{q_1} \cap B_\epsilon$ the set $\mathcal{B}(x, a|x|^{q_1})$ has essential topology.
- (2) If X_{q_1} is a D -piece then for any $L > 1$ there exists a_1 sufficiently large and ϵ sufficiently small that for each $a \geq a_1$ and $x \in X_{q_1} \cap B_\epsilon$ the set $\mathcal{B}(x, a|x|^{q_1})$ has abnormality $> L$.
- (3) There exists a $K > 0$ such that for all $a > 0$ there exists a q_1 -neighbourhood $Z_{q_1}(a)$ of X_{q_1} and $\epsilon > 0$ such that any set $\mathcal{B}(x, a|x|^{q_1})$ not intersecting $Z_{q_1}(a)$ has trivial topology and abnormality $\leq K$.

Item (1) is the same proof as the first part of the proof of Lemma 11.5 (3).

For Item (2) we use again the resolution $\pi: (\tilde{X}, E) \rightarrow (X, 0)$ with dual graph Γ defined in section 9 and the notations introduced in the proof of Lemma 11.5 (3).

We claim that for each $y \in E_{q_1} \setminus E'$ we have:

$$\lim_{a \rightarrow \infty} \lim_{\substack{x \rightarrow y \\ x \notin E}} \tilde{\alpha}_{q_1}(x, a) = \infty.$$

Indeed, consider a real analytic arc γ in X such that $|\gamma(t)| = O(t)$ and $\tilde{\gamma}(0) = y$. Choose $q_2 < q < q_1$. For each t , set $a(t) = |\gamma(t)|^{q-q_1}$, so we have $\lim_{t \rightarrow 0} a(t) = \infty$. Since $q_2 < q < q_1$, $\mathcal{B}(\gamma(t), |\gamma(t)|^q)$ has trivial topology for all t . By Item (3) of Lemma 11.5 we have that for any $K_2 > 1$ and $a = 1$, there is $\epsilon < \epsilon_0$ such that for each $t \leq \epsilon$, $\alpha(\mathcal{B}(\gamma(t), |\gamma(t)|^q)) \geq K_2$. As $\mathcal{B}(\gamma(t), |\gamma(t)|^q) = \mathcal{B}(\gamma(t), a(t)|\gamma(t)|^{q_1})$, we then obtain

$$\lim_{t \rightarrow 0} \tilde{\alpha}_{q_1}(\tilde{\gamma}(t), a(t)) = \lim_{t \rightarrow 0} \alpha(\mathcal{B}(\gamma(t), a(t)|\gamma(t)|^{q_1})) = \infty.$$

Choose $L > 1$. The set $\mathcal{N}(\Gamma_1)$ intersects E in a compact set inside $E_{q_1} \setminus (E_{q_1} \cap E')$. Therefore, by continuity of $\tilde{\alpha}_{q_1}$, there exists $a_1 > 0$ and $\epsilon > 0$ such that for all $a \geq a_1$ and $x \in (\mathcal{N}(\Gamma_1) \setminus E) \cap \pi^{-1}(B_\epsilon)$ we have $\tilde{\alpha}_{q_1}(x, a) = \alpha(\mathcal{B}(\pi(x), a|\pi(x)|^{q_1})) > L$. This completes the proof of Item (2)

To prove Item (3) we pick ℓ_1, ℓ_2, K and c as in the proof of Lemma 11.5 (1). So with A_1 and A_2 as in that proof, any $\mathcal{B}(x, c|x|^{q_1})$ is disjoint from one of A_1 and A_2 . We choose $\epsilon > 0$ which we may decrease later.

We now choose $a > 0$. Denote by A'_1 and A'_2 the union of components of A_1 and A_2 with rate $< q_1$. Note that the distance between any pair of different components of $A'_1 \cup A'_2$ is at least $O(r^{q_2})$ at distance r from the origin, so after decreasing ϵ if necessary, any $\mathcal{B}(x, aK^2|x|^{q_1})$ which intersects one of A'_1 and A'_2 is disjoint from the other. Thus if $\mathcal{B}(x, aK^2|x|^{q_1})$ is also disjoint from X_{q_1} , then the argument of the proof of Lemma 11.5 (1) shows that $\mathcal{B}(x, a|x|^{q_1})$ has trivial topology and abnormality at most K . Since the union of those $\mathcal{B}(x, aK^2|x|^{q_1})$ which are not disjoint from X_{q_1} is a q_1 -neighbourhood of X_{q_1} , Item (3) is proved. \square

The germ $(X'_{q_1}, 0)$ of Proposition 11.1 will be defined as a smoothing of $Z_{q_1, a, L}$ for L and a sufficiently large. Let us first define what we mean by smoothing.

The outer boundary of X_{q_1} attaches to $A(q', q_1)$ -pieces of the (non-amalgamated) carrousel decomposition with $q' < q_1$, so we can add $A(q_1, q_1)$ collars to the outer boundary of X_{q_1} to obtain a q_1 -neighbourhood of X_{q_1} in X . We use $X_{q_1}^+$ to denote such an enlarged version of X_{q_1} . An arbitrary q_1 -neighbourhood of X_{q_1} in X can be embedded in one of the form $X_{q_1}^+$, and we call the process of replacing X_{q_1} by $X_{q_1}^+$ *smoothing*.

This smoothing process can be applied more generally as follows:

Definition 11.11 (Smoothing). Let $(Y, 0)$ be a subgerm of $(X, 0)$ which is a union of B - and A -pieces lifted from a plane projection of X . So $(Y, 0)$ has (possibly empty) inner and outer boundaries. Assume that the outer boundary components of Y are inner boundary components of $A(q', q)$ -pieces with $q' < q$.

Let W be a q -neighbourhood of Y in $(X, 0)$ and let V be the union of the components of $\overline{W} \setminus Y$ which are inside $A(q', q)$ -pieces attached to the outer boundaries of Y . We call the union $Z = V \cup Y$ an *outer q -neighbourhood* of Y .

We call a *smoothing* of Z any outer q -neighbourhood Z^+ of Z obtained by adding to Y some $A(q, q)$ -pieces to its outer boundaries.

Remark 11.12. The smoothing Z^+ of Z is uniquely determined from Z up to homeomorphism since a q -neighbourhood of the form Z^+ is characterized among all outer q -neighbourhoods of Z by the fact that the links of its outer boundary components are tori and the number of outer boundary components is minimal among outer q -neighbourhoods of Z in X .

Definition of the germ $(X'_{q_1}, \mathbf{0})$. Let $a > 0$ and $L > 1$ sufficiently large as in Lemma 11.10. We define X'_{q_1} as the smoothing

$$X'_{q_1} := Z_{q_1, a, L}^+$$

Since $Z_{q_1, a, L}$ is a q_1 neighbourhood of X_{q_1} inside a Milnor ball B_ϵ , the germ $(X'_{q_1}, \mathbf{0})$ is equivalent to $(X_{q_1}, \mathbf{0})$.

11.4. Discovering q_2 . For $(\widehat{X}, 0)$ a subgerm of $(X, 0)$ we use the notation $N_{q, a}(\widehat{X})$ to mean the union of components of $\{x \in X : d(x, \widehat{X}) \leq a|x|^q\}$ which intersect $\widehat{X} \setminus \{0\}$. Here d refers to outer distance.

We discover q_2 in two steps.

Step 1. We consider $N_{q, 1}(X'_{q_1})^+$ with $q \leq q_1$. If q is close to q_1 this just adds collars to the boundary of X'_{q_1} so it does not change the topology. Now decrease q and let q'_1 be the infimum of q for which the topology $N_{q, 1}(X'_{q_1})^+$ has not changed. Then for $\alpha > 0$ sufficiently small, the topology $N_{q'_1, \alpha}(X'_{q_1})^+$ has also not changed.

Step 2. Using essentially the same argument as we used to discover q_1 (Proposition 11.6) we discover q_2 as follows. q_2 is the infimum of all q with $q'_1 < q < q_1$ such that there exists $K_1 > 0$ such that for all $a > 0$ there exists $\epsilon_1 > 0$ such that all sets $\mathcal{B}(x, a|x|^q)$ with $x \in X \setminus N_{q'_1, \alpha}(X'_{q_1})^+$ have trivial topology and abnormality at most K_1 . If there are no such q we set $q_2 = q'_1$.

11.5. Constructing X'_{q_2} and A'_{q_2, q_1} . We must consider two cases: $q_2 > q'_1$ and $q_2 = q'_1$.

If $q_2 > q'_1$ we follow the construction of Subsection 11.3, but working inside $X \setminus N_{q'_1, \alpha}(X'_{q_1})$. Namely, we define

$$Z_{q_2, a, L} := \bigcup \left\{ \mathcal{B}(x, a|x|^{q_2}) : B(x, a|x|^{q_2}) \cap N_{q'_1, \alpha}(X'_{q_1}) = \emptyset, \text{ and} \right. \\ \left. \alpha(\mathcal{B}(x, a|x|^{q_1})) > L \text{ or } \mathcal{B}(x, a|x|^{q_2}) \text{ has essential topology} \right\}$$

with a and L sufficiently large, and then $X'_{q_2} := Z_{q_2, a, L}^+$ is a q_2 -neighbourhood of X_{q_2} . In this case A'_{q_2, q_1} is empty.

If $q_2 = q'_1$ then there exists α sufficiently small that $N_{q_2, \alpha}(X'_{q_1})^+$ has the same topology as X'_{q_1} and there exists $\beta > 0$ such that for all $a \geq \beta$ the topology of $N_{q_2, a}(X'_{q_1})^+$ is no longer that of X'_{q_1} and increasing a does not change the topology.

Note that $\overline{N_{q_2, \beta}(X'_{q_1})^+} \setminus X'_{q_1}$ consists of at least one piece which is not an $A(q_2, q_1)$ and maybe some $A(q_2, q_1)$ -pieces. We define X''_{q_2} as the union of the components of $\overline{N_{q_2, \beta}(X'_{q_1})^+} \setminus N_{q_2, \alpha}(X'_{q_1})^+$ which are not $A(q_2, q_2)$ -pieces.

This is a first approximation to X'_{q_2} since X_{q_2} may have components which are completely disjoint from X'_{q_2} , i.e., they have empty inner boundary. So we still have to discover such pieces. We again do this by the procedure of Subsection 11.3, working now inside $X \setminus N_{q, a}(X'_{q_1})$ with q slightly smaller than q_2 (see also Step 2 of Subsection 11.4). We denote by X'''_{q_2} the union of the pieces discovered in this way. Then $X'_{q_2} := X''_{q_2} \cup X'''_{q_2}$ is equivalent to X_{q_2} .

Now $\overline{N_{q_2, \alpha}^+} \setminus X'_{q_1}$ consists of $A(q_2, q_1)$ -pieces. We define A'_{q_2, q_1} to be the union of these $A(q_2, q_1)$ -pieces which intersect $N_{q_2, \alpha}^+$.

11.6. Constructing X'_{q_i} and A'_{q_i, q_j} for $i > 2$. We now assume we have already done the construction for smaller i . Let $X^{(i-1)}$ be the union of all X'_{q_j} with $j \leq i-1$ and all $A(q_j, q_k)$ -pieces connecting an X'_{q_j} with X'_{q_k} with $k < j \leq i-1$.

We now use the same arguments as in the construction for $i = 2$, using $X^{(i-1)}$ in place of X'_{q_1} in the discovery of q_i and construction of the sets X'_{q_i} and A'_{q_i, q_j} .

This iterative procedure ends when the procedure for discovery of q_i fails, in which case $q_i = 1$ and $i = \nu$. We then define $X'_{q_\nu} = X'_1$ as the closure of the complement of the result of gluing a piece of type $A(1, q_j)$ on each outer boundary of $X^{(\nu-1)}$.

This completes the construction from the outer metric of the decomposition of $(X, 0)$ in Proposition 11.1. Finally, we will show that the decomposition can still be recovered after a bilipschitz change to the metric.

11.7. Bilipschitz invariance of the germs $(X'_{q_i}, 0)$.

Proposition 11.13. *Let $(X, 0) \subset (\mathbb{C}^n, 0)$ and $(X', 0) \subset (\mathbb{C}^{n'}, 0)$ be two germs of normal complex surfaces endowed with their outer metrics. Assume that there is a bilipschitz map $\Phi: (X, 0) \rightarrow (X', 0)$. Then the inductive process described in Subsections 11.2 to 11.6 leads to the same sequence of rates q_i for both $(X, 0)$ and $(X', 0)$ and for $a > 0$ and $L > 1$ sufficiently large, the corresponding sequences of subgerms $Z_{q_i, aL}$ in X and $Z'_{q_i, a, L}$ in X' have the property that $\Phi(Z_{q_i, a, L}^+)$ and $Z_{q_i, a, L}^+$ are equivalent.*

Proof. Let K be the bilipschitz constant of Φ in a fixed neighbourhood V of the origin. The proof follows from the following three observations.

- (1). Given $x \in V$, $a > 0$ and $q \geq 1$, there exists $a' > 0$ such that

$$\Phi(\mathcal{B}(x, a|x|^q)) \subset \mathcal{B}(\Phi(x), a'|\Phi(x)|^q).$$

Indeed, $\Phi(\mathcal{B}(x, a|x|^q)) \subset \mathcal{B}(\Phi(x), aK|x|^q) \subset \mathcal{B}(\Phi(x), aK^{q+1}|\Phi(x)|^q)$. So any $a' \geq aK^{q+1}$ works.

- (2). Let N be a subset of V . Then the abnormality of $\Phi(N)$ is controlled by that of N :

$$\frac{1}{K^2}\alpha(N) \leq \alpha(\Phi(N)) \leq K^2\alpha(N).$$

- (3). Let $(U, 0) \subset (\hat{X}, 0) \subset (X, 0)$ be semi-algebraic sub-germs. If $(N, 0)$ is a q -neighbourhood of $(U, 0)$ in $(\hat{X}, 0)$ then $(\Phi(N), 0)$ is a q -neighbourhood of $(\Phi(U), 0)$ in $(\Phi(\hat{X}), 0)$. \square

12. EXPLICIT COMPUTATION OF POLAR RATES

The argument of the proof of Lemma 11.7 enables one to compute the rate of a polar piece in simple examples such as the following. Assume $(X, 0)$ is a hypersurface with equation $z^2 = f(x, y)$ where f is reduced. The projection $\ell = (x, y)$ is generic and its discriminant curve Δ has equation $f(x, y) = 0$. Consider a branch Δ_0 of Δ which lifts to a polar piece N in X . We consider the Puiseux expansion of Δ_0 :

$$y = \sum_{i \geq 1} a_i x^{q_i} \in \mathbb{C}\{x^{1/m}\}.$$

The polar rate s of N is the minimal $r \in \frac{1}{m}\mathbb{N}$ such that for any small λ , the curve $\gamma: y = \sum_{i \geq 1} a_i x^{qi} + \lambda x^r$ is in $\ell(N)$. In order to compute s , we set $r' = rm$ and we parametrize γ as:

$$x = w^m, \quad y = \sum_{i \geq 1} a_i w^{mqi} + w^{r'}.$$

Replacing in the equation of X , and approximating by elimination of the monomials with higher order in w , we obtain $z^2 \sim aw^{r'+b'}$ for some $a \neq 0$ and some positive integer b' . We then have an outer distance of $O(x^{\frac{r+b}{2}})$ between the two sheets of the cover ℓ , where $b = \frac{b'}{m}$. So the optimal s such that the curve γ is in $\ell(N)$ is given by $\frac{s+b}{2} = s$, i.e., $s = b$.

Example 12.1. We apply this to the singularity D_5 with equation $z^2 = -(x^2y + y^4)$ (see Example 9.4). The discriminant curve of $\ell = (x, y)$ has equation $y(x^2 + y^3) = 0$. For the polar piece $\pi(\mathcal{N}(E_6))$, which projects on a neighbourhood of the cusp $\delta_2 = \{x^2 + y^3 = 0\}$, we use $y = w^2$, $x = iw^3 + w^{r'}$, so $z^2 \sim -2iw^{5+r'}$, so $b' = 5$ and this polar piece has rate $s = 5/2$. Similarly one computes that the polar piece $\pi(\mathcal{N}(E_4))$, which projects on a neighbourhood of $\delta_1 = \{y = 0\}$, has rate 2.

Notice that in the above computation, we have recovered the relation $q(r) = \frac{r+s}{2}$ established for $r \geq s$ in the proof of Lemma 6.6. In fact, combining Lemma 6.6 and Lemma 11.7, we can compute polar rates in a more general setting, as we explain now, using e.g., Maple.

Let Y be a polar piece in $(X, 0)$ which is a $D(s)$ -piece. Let q be the rate of the B -piece outside it, so there is an intermediate $A(q, s)$ -piece A between them. Assume we know the rate q . Let Π_0 be a component of Π inside Y and let $\Delta_0 = \ell(\Pi_0)$. Consider a Puiseux expansion of Δ_0 as before and an irreducible curve γ with Puiseux expansion

$$y = \sum_{i \geq 1} a_i x^{qi} + ax^r.$$

having contact $r > q$ with Δ_0 . Let $L_\gamma = \ell^{-1}(\gamma)$ and let $\ell': X \rightarrow \mathbb{C}^2$ be a generic plane projection of $(X, 0)$ which is also generic for L_γ . Let L'_γ be the intersection of L_γ with $Y \cup A$. Let $q(r)$ be the greatest characteristic exponent of the curve $\ell'(L'_\gamma)$. Given r one can compute $q(r)$ from the equations of X .

If $q < r < s$, then, according to Lemma 11.7, $q(r) > r$. If $r \geq s$, then, according to Lemma 6.6, $q(r) \leq s$. Therefore, testing the inequality $q(r) > r$, one can choose an r_0 big enough so that $q(r_0) \leq r_0$, i.e., $r_0 \geq s$. Now, we have $q(r_0) = \frac{r_0+s}{2}$ (again by Lemma 6.6). Therefore $s = 2q(r_0) + r_0$.

Example 12.2. This method gives rise to the polar rate $s = \frac{7}{5}$ claimed in Example 7.3, using a Maple computation.

13. CARROUSEL DECOMPOSITION FROM LIPSCHITZ GEOMETRY

The aim of this section is to complete the proof of Theorem 1.2. We will first prove that the outer Lipschitz geometry determines the sections of the complete carousel decomposition of the discriminant curve Δ of a generic plane projection of $(X, 0)$.

Let $\ell = (z_1, z_2): X \rightarrow \mathbb{C}^2$ be the generic plane projection and $h = z_1|_X$ the generic linear form chosen in Section 10. We denote by $F(t) := h^{-1}(t)$ the Milnor fibre of h for $t \in (0, \epsilon]$.

Proposition 13.1. *The outer Lipschitz geometry of $(X, 0)$ determines:*

- (1) *the combinatorics of the complete carrousel section of Δ .*
- (2) *the number of components of the polar curve Π in each B - or D -piece of $(X, 0)$.*

The proof will need the following lemma:

Lemma 13.2. *Let $i \in \{1, \dots, \nu - 1\}$ and let N_1 and N_2 be two components of X_{q_i} . Then N_1 and N_2 are equivalent to N'_1 and N'_2 (Definition 8.6) for which $\ell(N'_1)$ and $\ell(N'_2)$ have the same outer boundaries if and only if the outer distance $d(N_1 \cap S_\epsilon, N_2 \cap S_\epsilon)$ is $O(\epsilon^q)$ with $q \geq q_i$.*

Proof. Suppose that the outer distance $d(N_1 \cap S_\epsilon, N_2 \cap S_\epsilon)$ is $O(\epsilon^q)$ with $q \geq q_i$. For q' with $q_{i+1} < q' < q_i$, let N''_1 and N''_2 be N_1 and N_2 union $A(q', q_i)$ -pieces added on their outer boundaries. Since ℓ is a linear projection, $d(\ell(x), \ell(y)) \leq d(x, y)$ for any $x, y \in \mathbb{C}^n$. Therefore $d(\ell(N_1 \cap S_\epsilon), \ell(N_2 \cap S_\epsilon))$ is $O(\epsilon^{q'})$ with $q \leq q''$. Assume $\ell(N'_1)$ and $\ell(N'_2)$ cannot have equal outer boundaries. Then the same holds for $\ell(N''_1)$ and $\ell(N''_2)$, and since $\ell(N'_1)$ and $\ell(N'_2)$ are subgerms in \mathbb{C}^2 with $A(q', q_i)$ -pieces at their outer boundaries, we obtain that $d(\ell(N''_1 \cap S_\epsilon), \ell(N''_2 \cap S_\epsilon))$ is $O(\epsilon^{q_0})$ with $q_0 \leq q'$. Finally, $q'' \leq q_0$, as $d(\ell(N''_1 \cap S_\epsilon), \ell(N''_2 \cap S_\epsilon)) \leq d(\ell(N_1 \cap S_\epsilon), \ell(N_2 \cap S_\epsilon))$. Summarizing:

$$q \leq q'' \leq q_0 \leq q' < q_i \leq q,$$

which is a contradiction.

Assume N_1 and N_2 are equivalent to N'_1 and N'_2 such that $\ell(N'_1)$ and $\ell(N'_2)$ have the same outer boundary. Let C be a complex curve inside $\ell(N'_1) \cap \ell(N'_2)$. Let C_1 and C_2 be two components of the complex curve $\ell^{-1}(C) \subset X$ such that $C_1 \subset N'_1$ and $C_2 \subset N'_2$. Let $\ell_{\mathcal{D}} \neq \ell$ be a generic plane projection for X which is generic for the curve $C_1 \cup C_2$. There is a $B(q_i)$ -piece B of the carrousel decomposition of the discriminant curve $\Delta_{\mathcal{D}}$ such that for each $q'' > q_i$, the outer boundaries of $\ell_{\mathcal{D}}(N'_1)$ and $\ell_{\mathcal{D}}(N'_2)$ project inside B union an $A(q'', q_i)$ piece $A_{q''}$ added to its outer boundary. Let q' be the coincidence exponent between $\ell'(C_1)$ and $\ell'(C_2)$. The inclusions $\ell_{\mathcal{D}}(C_1) \cup \ell_{\mathcal{D}}(C_2) \subset \ell_{\mathcal{D}}(N'_1) \cup \ell_{\mathcal{D}}(N'_2) \subset B \cup A_{q''}$ for all $q'' > q_i$ implies $q' \geq q_i$. Moreover, we have $q \geq q'$, as the projection $\ell_{\mathcal{D}}$ is generic for $C_1 \cup C_2$. Therefore $q \geq q_i$. \square

Proof of Proposition 13.1. By Proposition 11.1 we may assume that we have recovered the pieces X_{q_i} of X for $i = 1, \dots, \nu$ and the intermediate A -pieces up to equivalence (Definition 8.6).

We will recover the carrousel sections by an inductive procedure on the rates q_i starting with q_1 . We define AX_{q_i} to be

$$AX_{q_i} := X_{q_i} \cup \bigcup_{k < i} A_{q_i, q_k}.$$

We first recover the pieces of $\ell(AX_{q_1} \cap F(\epsilon))$ and inside them, the section of the complete carrousel of Δ beyond rate q_1 (Definition 4.4). Then we glue to some of their outer boundaries the pieces corresponding to $\ell((AX_{q_1} \cup AX_{q_2}) \cap F(\epsilon)) \setminus \ell(AX_{q_1} \cap F(\epsilon))$, and inside them, we determine the complete carrousel beyond q_2 , and so on. At each step, the outer Lipschitz geometry will determine the shape of the new pieces we have to glue, how they are glued, and inside them, the complete carrousel section beyond the corresponding rate.

For any $i < \nu$ we will denote by AX'_{q_i} the result of adding $A(q', q_i)$ -pieces to all components of the outer boundary $\partial_0 AX_{q_i}$ of AX_{q_i} for some q' with $q_{i+1} < q' < q_i$. We can assume that the added A -pieces are chosen so that the map ℓ maps each by a covering map to an $A(q', q_i)$ piece in \mathbb{C}^2 . We will denote by $\partial_0 AX'_{q_i}$ the outer boundary of AX'_{q_i} , so it is a horn-shaped cone on a family of tori with rate q' . We denote

$$F_{q_i}(t) := F(t) \cap AX_{q_i}, \quad F'_{q_i}(t) := F(t) \cap AX'_{q_i},$$

and their outer boundaries by

$$\partial_0 F_{q_i}(t) = F(t) \cap \partial_0 AX_{q_i}, \quad \partial_0 F'_{q_i}(t) = F(t) \cap \partial_0 AX'_{q_i}.$$

A straightforward consequence of Item (1) of Theorem 1.2 is that the outer Lipschitz geometry determines the isotopy class of the Milnor fibre $F(t)$ and how the Milnor fiber lies in a neighbourhood of the exceptional divisor of the resolution described there. In particular it determines the isotopy class of the intersections $F_{q_i}(t) = F(t) \cap AX_{q_i}$ for $i < \nu$ and $t \in (0, \epsilon]$.

Set $B_{q_1} = \ell(AX_{q_1})$ and $B_{q_1}(\epsilon) := \ell(F_{q_1}(\epsilon))$, so $B_{q_1}(\epsilon)$ consists of the innermost disks of the intermediate carousel section of Δ . Notice that $B_{q_1}(\epsilon)$ is the union of all the sections of the complete carousel beyond rate q_1 . Consider the restriction $\ell: F_{q_1}(\epsilon) \rightarrow B_{q_1}(\epsilon)$. We want to show that this branched cover can be seen in terms of the outer Lipschitz geometry of a neighbourhood of AX_{q_1} . Since $B_{q_1}(\epsilon)$ is a union of disks, the same is true for $B'_{q_1}(\epsilon) := \ell(F'_{q_1}(\epsilon))$.

Consider a component $F_{q_1,0}(t)$ of $F_{q_1}(t)$ and let $AX_{q_1,0}$ be the component of AX_{q_1} such that $F_{q_1,0}(t) \subseteq F(t) \cap AX_{q_1,0}$. Consider a continuous arc $p: [0, \epsilon] \rightarrow \partial_0 AX_{q_1,0}$ such that $p(t) \in \partial_0 F_{q_1,0}(t)$ for $t \in (0, \epsilon]$. According to Lemma 13.2, if δ is big enough then for all t small enough a component of $F_{q_1}(t)$ maps to the component $B_{q_1,0}(t) := \ell(F_{q_1,0}(t))$ of $B_{q_1}(t)$ if and only if it intersects the ball $B(p(t), \delta t^{q_1})$.

If there is a component of $F_{q_1}(t)$ which does not map on $B_{q_1,0}(t)$, we iterate the process until we have determined the number of discs in $B_{q_1}(t)$ and how ℓ maps the components of $F_{q_1}(t)$ onto them.

Using similar arcs on the outer boundaries of the components of $\overline{AX'_{q_1} \setminus AX_{q_1}}$, we obtain by the same argument that the outer Lipschitz geometry determines the degree of the restriction of ℓ on each annular component of $\overline{F'_{q_1}(t) \setminus F_{q_1}(t)}$, and then, the degree of ℓ restricted to each component of $\partial_0 F'_{q_1}(t)$, resp. $\partial_0 F_{q_1}(t)$ (alternatively, this follows from the proof of Lemma 11.7).

We hence obtain the degree n of $\ell|_{F_{q_1,0}(t)}: F_{q_1,0}(t) \rightarrow B_{q_1,0}(t)$. We wish to determine the number β of branch points of this map. Since the cover is general, the inverse image by $\ell|_{F_{q_1,0}(t)}$ of a branch point consists of $n - 1$ points in $F_{q_1,0}(t)$ and the Hurwitz formula applied to $\ell|_{F_{q_1,0}(t)}$ gives:

$$\beta = n - \chi(F_{q_1,0}(t)).$$

We now determine the number of components of the polar inside the component $AX_{q_1,0}$ of AX_{q_1} which contains $F_{q_1,0}(t)$. We use a similar argument as in the proof of Proposition 4.1, taking account of Remark 4.3.

We restrict again to a connected component $F_{q_1,0}(t)$ of $F_{q_1}(t)$ and use again the arc $p(t)$ in $\partial_0 AX_{q_1,0}$. There is a $\mu > 0$ such that for all $q > q_1$ sufficiently close to q_1 the ball $B(p(t), t^q)$ intersects $\ell^{-1}(\ell(F'_{q_1,0}(t)))$ in μ discs $D_1(t), \dots, D_\mu(t)$ for all small t . For each j, k with $1 \leq j < k \leq \mu$, let q_{jk} be defined by $d(D_j(t), D_k(t)) = O(t^{q_{jk}})$. Let $A \subset \{1, \dots, \mu\}$ be the set of indices of discs $D_j(t)$ such that $D_j(t) \subset$

$AX'_{q_1,0} \cap F(t)$. The outermost piece of $AX_{q_1,0}$ before amalgamation is a union of equisingular curves $\Pi_{\mathcal{D}} \cap AX_{q_1,0}$ with \mathcal{D} generic and each curve $\Pi_{\mathcal{D}} \cap AX_{q_1,0}$ consists of equisingular components having pairwise contact q_1 (see Section 6). Therefore the collection of rates $q_{j,k}$ indexed by $j, k \in A$ reflects the outer Lipschitz geometry beyond rate q (Definition 4.4) of each irreducible component $\Pi_{\mathcal{D},0}$ of $\Pi_{\mathcal{D}} \cap AX_{q_1,0}$. In particular, it determines the number r of points in the intersection $\Pi_{\mathcal{D},0} \cap F(\epsilon)$. Then $\Pi \cap AX_{q_1,0}$ consists of $\frac{\beta}{r}$ equisingular irreducible curves with pairwise contact q_1 and such that each component has the outer Lipschitz geometry of $\Pi_{\mathcal{D},0}$.

To complete the initial step of our induction, we will now recover the section of the complete carrousel of Δ beyond rate q_1 , i.e., inside each component of $B_{q_1}(\epsilon)$. As we have just seen, the collection of rates $q_{j,k}$ indexed by $j, k \in A$ determines the number of components of the polar inside each component $AX_{q_1,0}$ of AX_{q_1} and their outer geometry. Since the projection $\ell = \ell_{\mathcal{D}}$ is a generic projection for its polar curve $\Pi = \Pi_{\mathcal{D}}$ [25, Lemme 1.2.2 ii)], we have then showed that the outer Lipschitz geometry recovers the outer Lipschitz geometry of $\ell(\Pi)$ beyond rate q_1 inside $B_{q_1,0}$, or equivalently, the section of the complete carrousel of the discriminant curve $\Delta = \ell(\Pi)$ inside $B_{q_1,0}(\epsilon)$.

Doing this for each component $B_{q_1,0}(\epsilon)$ of $B_{q_1}(\epsilon)$ we then reconstruct the complete carrousel section of Δ beyond rate q_1 .

This completes the initial step of our induction.

Overlapping and nesting. In the next steps $i \geq 2$, we give special attention to the following two phenomena. It can happen that $\ell(AX_{q_i})$ contains connected components of some $\ell(AX_{q_j})$ for $j < i$. We say that AX_{q_i} *overlaps* AX_{q_j} . This phenomenon is illustrated further in Example 13.4 where the thick part AX_1 overlaps the components of a thin part. When $i > 2$ a new phenomenon that we call *nesting* may occur (which is why we treat first the step $i = 2$ and then the following steps $i > 2$): it could happen that AX_{q_i} for some $k' < k < i$ has common boundary components with both AX_{q_k} and $AX_{q_{k'}}$, and some of these components of AX_{q_k} overlap some of those of $AX_{q_{k'}}$. The image by ℓ of some outer boundary components of $AX_{q_{k'}}$ will then be nested in some outer boundary components of AX_{q_k} . Such a nesting occurs in Example 13.5.

We now consider $F_{q_2}(\epsilon)$. As before, we know from the outer Lipschitz metric for $F'_{q_2}(\epsilon)$ how the outer boundary $\partial_0 F_{q_2}(\epsilon)$ covers its image. We will focus first on a single component $F_{q_2,0}(\epsilon)$ of $F_{q_2}(\epsilon)$. The map $\ell|_{F_{q_2,0}(\epsilon)}: F_{q_2,0}(\epsilon) \rightarrow \ell(F_{q_2,0}(\epsilon))$ is a covering map in a neighbourhood of its outer boundary, whose degree, m say, is determined from the outer Lipschitz geometry. The image $\partial_0 \ell(F_{q_2,0}(\epsilon))$ of the outer boundary is a circle which bounds a disk $B_{q_2,0}(\epsilon)$ in the plane $\{z_1 = \epsilon\}$. The image $\ell(F_{q_2,0}(\epsilon))$ is this $B_{q_2,0}(\epsilon)$, possibly with some smaller disks removed, depending on whether and how AX_{q_2} overlaps AX_{q_1} . The image of the inner boundaries of $F_{q_2,0}(\epsilon)$ will consist of disjoint circles inside $B_{q_2,0}(\epsilon)$ of size proportional to ϵ^{q_1} . Consider the components of $F_{q_1}(\epsilon)$ which fit into the inner boundary components of $F_{q_2,0}(\epsilon)$. Their images form a collection of disjoint disks $B_{q_1,1}(\epsilon), \dots, B_{q_1,s}(\epsilon)$. For each j denote by $F_{q_1,j}(\epsilon)$ the union of the components of $F_{q_1}(\epsilon)$ which meet $F_{q_2,0}(\epsilon)$ and map to $B_{q_1,j}(\epsilon)$ by ℓ . By the first step of the induction we know the degree m_j of the map $\partial_0 F_{q_1,j}(\epsilon) \rightarrow \partial_0 B_{q_1,j}(\epsilon)$. This degree may be less than m , in which case $\ell^{-1}(B_{q_1,j}(\epsilon)) \cap F_{q_2,0}(\epsilon)$ must consist of $m - m_j$ disks. Thus, after removing $\sum_j (m - m_j)$ disks from $F_{q_2,0}(\epsilon)$, we have a subset $\hat{F}_{q_2,0}(\epsilon)$ of $F_{q_2,0}(\epsilon)$

which maps to $\overline{B_{q_2,0}(\epsilon) \setminus \bigcup_{j=1}^s B_{q_1,j}(\epsilon)}$ by a branched covering. Moreover, the branch points of the branched cover $\hat{F}_{q_2,0}(\epsilon) \rightarrow \overline{B_{q_2,0}(\epsilon) \setminus \bigcup_{j=1}^s B_{q_1,j}(\epsilon)}$ are the intersection points of $F_{q_2,0}(\epsilon)$ with the polar Π . We again apply the Hurwitz formula to discover the number of these branch points: it is $m(1-s) - \chi(\hat{F}_{q_2,0}(\epsilon)) = m(1-s) - \chi(F_{q_2,0}(\epsilon)) + \sum_{j=1}^s (m - m_j)$.

Then we use balls along arcs as before to find the number of branches of the polar in each component of AX_{q_2} , and since outer Lipschitz geometry tells us which components of $F_{q_2}(\epsilon)$ lie over which components of $\ell(F_{q_2}(\epsilon))$, we recover how many components of the discriminant meet each component of $\ell(F_{q_2}(\epsilon))$.

Different components $F_{q_2,0}(\epsilon)$ of $F_{q_2}(\epsilon)$ may correspond to the same $B_{q_2,0}(\epsilon)$, but as already described, this is detected using outer Lipschitz geometry (Lemma 13.2). We write $B_{q_2}(\epsilon)$ for the union of the disks $B_{q_2,0}(\epsilon)$ as we run through the components of F_{q_2} . The resulting embedding of B_{q_1} in B_{q_2} is the next approximation to the carrousel decomposition. Moreover, by the same procedure as in the initial step, we determine the complete carrousel section of Δ beyond rate q_2 , i.e., within $B_{q_2} = \ell(AX_{q_1} \cup AX_{q_2})$.

Iterating this procedure for $F_{q_i}(\epsilon)$ with $2 < i < \nu$, we now take into account the possible occurrence of nesting. We again focus on one component $F_{q_i,0}(\epsilon)$ of $F_{q_i}(\epsilon)$, whose image will be a disk $B_{q_i,0}(\epsilon)$ possibly with some subdisks removed. The images of the inner boundaries of $F_{q_i,0}(\epsilon)$ will be circles in $B_{q_i,0}(\epsilon)$ of rates q_k with $k < i$. It can now occur that pairs of such circles are nested in each other, with a q_k circle inside the $q_{k'}$ one with $k < k' < i$. Consider an outermost circle S of these nested families of such circles and the disk $\tilde{B}_0(\epsilon)$ which it bounds, and a component $\tilde{F}_0(\epsilon)$ of $\ell^{-1}(\tilde{B}_0(\epsilon)) \cap F_{q_i,0}(\epsilon)$ which has an inner boundary component nested inside S . The map $\tilde{F}_0(\epsilon) \rightarrow \tilde{B}_0(\epsilon)$ given by the restricting ℓ has no branch points, so it is a local homeomorphism away from its boundary, and the argument of Lemma 11.7 implies that its sheets are very close together at its outer boundary. It can thus be picked out using the outer Lipschitz metric. We remove all such pieces from $F_{q_i,0}(\epsilon)$ and call the result $F_{q_i}^*(\epsilon)$. The situation is now similar to the case $i = 2$ so we re-use some symbols; if S_j , $j = 1, \dots, s$ are the outer nested circles in $B_{q_i,0}(\epsilon)$, m_j the degree of ℓ on the part of the inner boundary of $F_{q_i}^*(\epsilon)$ which lies over S_j , and m is the degree of ℓ on the outer boundary of $F_{q_i}^*(\epsilon)$, then we again get that the number of intersection points of Π with $F_{q_i,0}(\epsilon)$ is $m(1-s) - \chi(\hat{F}_{q_i}^*(\epsilon)) = m(1-s) - \chi(F_{q_i}^*(\epsilon)) + \sum_{j=1}^s (m - m_j)$. Since $\chi(F_{q_i}^*(\epsilon))$ is computed as the difference of $\chi(F_{q_i,0}(\epsilon))$ and the sum of Euler characteristics of the pieces of the form $\tilde{F}_0(\epsilon)$ that were removed from $F_{q_i,0}(\epsilon)$, the number of intersection points is determined by the geometry.

In this way we iteratively build up for $i = 1, \dots, \nu - 1$ the picture of the complete carrousel section for Δ beyond rate q_i while finding the number of components of the polar in each component of AX_{q_i} and therefore the number of components of the discriminant in the pieces of the carrousel decomposition.

Finally for a component $AX_{1,0}$ of $AX_{q_\nu} = AX_1$ the degree of the map to $\ell(AX_{1,0})$ can be discovered by the same ball procedure as before; alternatively it is the multiplicity of the maximal ideal cycle at the corresponding \mathcal{L} -node, which was determined in Item (2) of Theorem 1.2. The same Euler characteristic calculation as before gives the number of components of the polar in each piece, and the ball

procedure as before determines the complete carrousel section of Δ beyond rate $q_\nu = 1$, i.e., the complete carrousel section. \square

Completion of proof of Theorem 1.2. Parts (1) to (3) of Theorem 1.2 were proved in Section 10 and part (5) is proved above (Proposition 13.1). (5) \Rightarrow (6) is proved in the Introduction, so we must just prove part (4).

We consider the decomposition of the link $X^{(\epsilon)}$ as the union of the Seifert fibered manifolds $X_{q_i}^{(\epsilon)}$ and show first that we know the Seifert fibration for each $X_{q_i}^{(\epsilon)}$. Indeed, the Seifert fibration for a component of a $X_{q_i}^{(\epsilon)}$ is unique up to isotopy unless that component is the link of a D - or A -piece. Moreover, on any torus connecting two pieces $X_{q_i}^{(\epsilon)}$ and $X_{q_j}^{(\epsilon)}$ we know the relative slopes of the Seifert fibrations, since this is given by the rates q_i and q_j . So if there are pieces of the decomposition into Seifert fibered pieces where the Seifert fibration is unique up to isotopy, the Seifert fibration is determined for all pieces. This fails only if the link $X^{(\epsilon)}$ is a lens space or torus bundle over S^1 , in which case $(X, 0)$ is a cyclic quotient singularity or a cusp singularity. These are taut, so the theorem is trivial for them.

We have shown that the outer Lipschitz geometry determines the decomposition of $(X, 0)$ as the union of subgerms $(X_{q_i}, 0)$ and intermediate A -pieces as well as the number of components of the polar curve in each piece. The link L of the polar curve is a union of Seifert fibers in the links of some of the pieces, so we know the topology of the polar curve. By taking two parallel copies of L (we will call it $2L$), as in the proof of (1) of Theorem 1.2, we fix the Seifert fibrations and can therefore recover the dual graph Γ we are seeking as the minimal negative definite plumbing diagram for the pair $(X^{(\epsilon)}, 2L)$. Since we know the number of components of the polar curve in each piece, the proof is complete. \square

Example 13.3. Let us show how the procedures described in Section 11 and in proof of (1) of Proposition 13.1 work for the singularity D_5 , i.e., recover the decomposition $X = X_{5/2} \cup X_2 \cup X_{3/2} \cup X_1$ plus intermediate A -pieces, and the complete carrousel sections of the discriminant curve Δ . It starts by considering high q , and then, by decreasing gradually q , one reconstructs the sequence $X_{q_1}, \dots, X_{q_\nu}$ up to equivalence as described in Proposition 11.1, using the procedure of Section 11. At each step we will do the following:

- (1) On the left in the figures below we draw the dual resolution graph with black vertices corresponding to the piece X_{q_i} just discovered, while the vertices corresponding to the previous steps are in gray, and the remaining ones in white. We weight each vertex by the corresponding rate q_i .
- (2) We describe the cover $\ell: F_{q_i} \rightarrow B_{q_i}$ and B_{q_i} and on the right we draw the new pieces of the carrousel section. To simplify the figures (but not the data), we will rather draw the sections of the AX_{q_i} -pieces. The Δ -pieces are in gray. We add arrows on the graph corresponding to the strict transform of the corresponding branches of the polar.

We now carry out these steps. We use the indexing v_1, \dots, v_6 of the vertices of Γ introduced in Example 9.4.

- The characterization of Proposition 11.6 leads to $q_1 = 5/2$. We get $X_{5/2} = \pi(\mathcal{N}(E_6))$ up to collars. Using the multiplicities of the generic linear form (determined by (2) of Theorem 1.2) we obtain that $F_{5/2} = F \cap \pi(\mathcal{N}(E_6))$

consists of two discs. Then $B_{5/2} = \ell(F_{5/2})$ also consists of two discs. By the Hurwitz formula, each of them contains one branch point of ℓ .

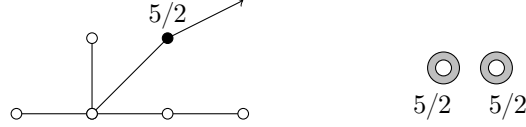

- $q_2 = 2$ is the next rate appearing, and $X_2 = \pi(\mathcal{N}(E_4))$. F_2 is a disk as well as B_2 . Then it creates another carousel section disk. There is one branching point inside B_2 .

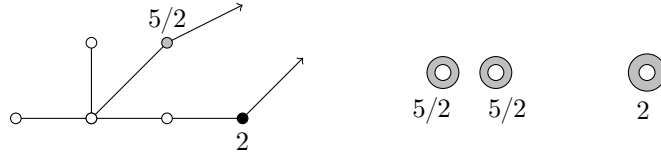

- Next is $q_3 = 3/2$. $F_{3/2}$ is a sphere with 4 holes. Two of the boundary circles are common boundary with F_1 , the two others map on the same circle $\partial B_{5/2}$. A simple observation of the multiplicities of the generic linear form shows that there $X_{3/2}$ does not overlap $X_{5/2}$ so $B_{3/2} = \ell(F_{3/2})$ is connected with one outer boundary component and inner boundary glued to $B_{5/2}$.

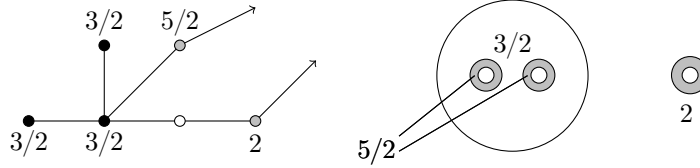

- Last is $q_4 = 1$, which corresponds to the thick piece.

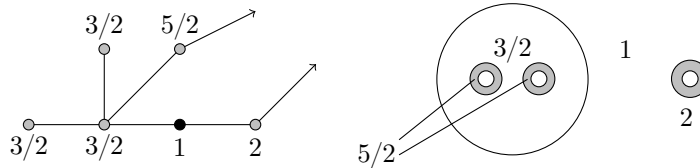

We read in the carousel section the topology of the discriminant curve Δ from this carousel sections: one smooth branch and one transversal cusp with Puiseux exponent $3/2$.

Example 13.4. We now describe how one would reconstruct the decomposition $X = \bigcup X_{q_i}$ plus intermediate A-pieces and the carousel section from the outer Lipschitz geometry for Example 7.3 (see also Example 9.5). The sequence of rates q_i appears in the following order:

$$q_1 = 7/5, q_2 = 3/2, q_3 = 5/4, q_4 = 6/5, q_5 = 1.$$

Overlapping. The inverse image by ℓ of the carousel section of $\ell(X_{5/4})$ consists of two annuli (according to the multiplicities of the generic linear form) and each of them double-covers the disk image. Then the restriction of ℓ to $X_{5/4}$ has degree 4 while the total degree of the cover $\ell|_X$ is 6. Therefore either $X_{6/5}$ or X_1 overlaps $X_{5/4}$. Moreover, the restriction of ℓ to $X_{6/5}$ also has degree 4 according to the multiplicity 10 at the corresponding vertices. Therefore X_1 overlaps $X_{5/4}$.

We now show step by step the construction of the carousel section. Here again we represent the sections of the AX_{q_i} -pieces rather than that of the X_{q_i} and intermediate annular pieces.

- $q_1 = 7/5$. $X_{7/5}$ consists of two polar pieces. We represent the two Δ -pieces with two different gray colors in the carousel section.



- $q_2 = 3/2$



- $q_3 = 5/4$



- $q_4 = 6/5$ and $q_5 = 1$

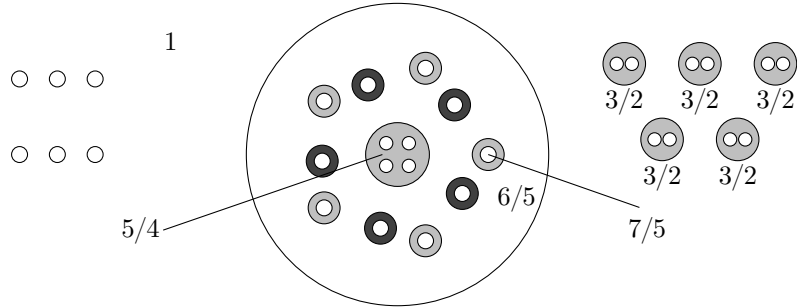

This completes the recovery of the carousel decomposition of Example 7.3.

Our final example is an example of the phenomenon of nesting described in the proof of Proposition 13.1.

Example 13.5. Consider the hypersurface singularity in $(\mathbb{C}^3, 0)$ with equation $z^2 - f(x, y) = 0$ where $f(x, y) = 0$ is the equation of a plane curve having two branches Δ_1 and Δ_2 with Puiseux expansions respectively: $y = x^{3/2} + x^{7/4}$ and $y = x^{3/2} + x^{9/4}$ i.e., the discriminant of $\ell = (x, y)$ is $\Delta = \Delta_1 \cup \Delta_2$. Then $X_{3/2}$ has two neighbour zones $X_{7/4}$ and $X_{9/4}$ and the inner boundary components of $\ell(X_{3/2})$ with rates $9/4$ are nested inside that of rate $7/4$. The carousel section of AX_{q_i} -pieces is given by the following picture.

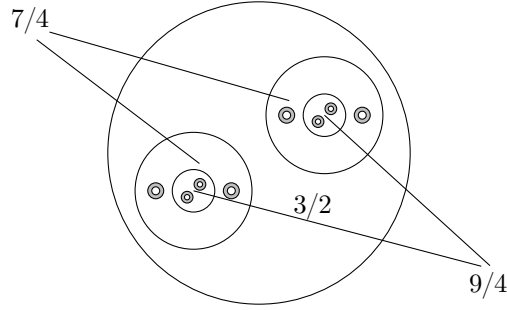

Part 4: Zariski equisingularity implies semi-algebraic Lipschitz triviality

14. EQUISINGULARITY

In this section, we define Zariski equisingularity as in Speder [21] and we specify it in codimension 2. For a family of hypersurface germs in $(\mathbb{C}^3, 0)$ with isolated singularities, the definition is equivalent to the last definition of equisingularity stated by Zariski in [31] using equidimensionality type. We also define Lipschitz triviality in this codimension and we fix notations for the rest of the paper.

Definition 14.1. Let $(\mathfrak{X}, 0) \subset (\mathbb{C}^n, 0)$ be a reduced hypersurface germ and $(Y, 0) \subset (\mathfrak{X}, 0)$ a nonsingular germ. \mathfrak{X} is *Zariski equisingular* along Y near 0 if for a generic linear projection $\mathcal{L}: \mathbb{C}^n \rightarrow \mathbb{C}^{n-1}$ for the pair (\mathfrak{X}, Y) at 0, the branch locus $\Delta \subset \mathbb{C}^{n-1}$ of the restriction $\mathcal{L}|_{\mathfrak{X}}: \mathfrak{X} \rightarrow \mathbb{C}^{n-1}$ is equisingular along $\mathcal{L}(Y)$ near 0 (in particular, $(\mathcal{L}(Y), 0) \subset (\Delta, 0)$). When Y has codimension one in \mathfrak{X} , Zariski equisingularity means that Δ is nonsingular.

The notion of a generic linear projection is defined in [21, definition 4].

When Y has codimension one in \mathfrak{X} , Zariski equisingularity is equivalent to Whitney conditions for the pair $(\mathfrak{X} \setminus Y, Y)$ and also to topological triviality of \mathfrak{X} along Y .

From now on we consider the case where $(Y, 0)$ is the singular locus of \mathfrak{X} and Y has codimension 2 in \mathfrak{X} (i.e., dimension $n - 3$). Then any slice of \mathfrak{X} by a smooth 3-space transversal to Y is a normal surface singularity. If \mathcal{L} is a generic projection for (\mathfrak{X}, Y) at 0 and H a hyperplane through $y \in Y$ close to 0 which contains the line $\ker \mathcal{L}$, then the restriction of \mathcal{L} to $H \cap \mathfrak{X}$ is a generic projection of the normal surface germ $(H \cap \mathfrak{X}, 0)$ in the sense of Definition 6.1.

We have the following characterization of Zariski equisingularity for families of isolated singularities in $(\mathbb{C}^3, 0)$ which will be used throughout the rest of the paper:

Proposition 14.2. *Let $(\mathfrak{X}, 0) \subset (\mathbb{C}^n, 0)$ be a reduced hypersurface germ at the origin of \mathbb{C}^n with 2-codimension smooth singular locus $(Y, 0)$. Then \mathfrak{X} is Zariski equisingular along Y near 0 if for a generic linear projection $\mathcal{L}: \mathbb{C}^n \rightarrow \mathbb{C}^{n-1}$, the branch locus $\Delta \subset \mathbb{C}^{n-1}$ of $\mathcal{L}|_{\mathfrak{X}}: \mathfrak{X} \rightarrow \mathbb{C}^{n-1}$ is topologically equisingular along $\mathcal{L}(Y)$ near 0. \square*

Remark 14.3. In [31], Zariski introduced an alternative definition of equisingularity based on the concept of dimensionality. The definition is also by induction on the codimension and involves the discriminant locus of successive projections. At each step, a number called dimensionality is defined by induction, and it is the

same for “almost all” projections. This defines a notion of genericity for such projections. The definition says \mathfrak{X} is *equisingular* along Y if the dimensionality equals 1 at the last step of the induction i.e., when Y has codimension 1 in \mathfrak{X} . This is equivalent to saying that the family of discriminants is equisingular as a family of curves. For details see [31] or [13]. In [2], Briançon and Henry proved that when Y has codimension 2 in \mathfrak{X} , i.e., for a family of complex hypersurfaces in \mathbb{C}^3 , the dimensionality can be computed using only linear projections. As a consequence, in codimension 2, Zariski equisingularity as defined in 14.1 coincides with Zariski’s equisingularity concept using dimensionality.

Definition 14.4. (1) $(\mathfrak{X}, 0)$ has constant (semi-algebraic) Lipschitz geometry along Y if there exists a smooth (semi-algebraic) retraction $r: (\mathfrak{X}, 0) \rightarrow (Y, 0)$ whose fibers are transverse to Y and a neighbourhood U of 0 in Y such that for all $y \in U$, there exists a (semi-algebraic) bilipschitz homeomorphism $h_y: (r^{-1}(y), y) \rightarrow (r^{-1}(0) \cap \mathfrak{X}, 0)$.

(2) The germ $(\mathfrak{X}, 0)$ is (semi-algebraic) Lipschitz trivial along Y if there exists a germ at 0 of a (semi-algebraic) bilipschitz homeomorphism $\Phi: (\mathfrak{X}, Y) \rightarrow (X, 0) \times Y$ with $\Phi|_Y = id_Y$, where $(X, 0)$ is a normal complex surface germ.

The aim of this last part is to prove Theorem 1.1 stated in the introduction:

Theorem. *The following are equivalent:*

- (1) $(\mathfrak{X}, 0)$ is Zariski equisingular along Y ;
- (2) $(\mathfrak{X}, 0)$ has constant Lipschitz geometry along Y ;
- (3) $(\mathfrak{X}, 0)$ has constant semi-algebraic Lipschitz geometry along Y ;
- (4) $(\mathfrak{X}, 0)$ is semi-algebraic Lipschitz trivial along Y

The implications (4) \Rightarrow (3) and (3) \Rightarrow (2) are trivial. (2) \Rightarrow (1) is an easy consequence of part (5) of Theorem 1.2:

Proof of (2) \Rightarrow (1). Assume $(\mathfrak{X}, 0)$ has constant semi-algebraic Lipschitz geometry along Y . Let $\mathcal{L}: \mathbb{C}^n \rightarrow \mathbb{C}^{n-1}$ be a generic linear projection for \mathfrak{X} . Let $r: \mathcal{L}(\mathfrak{X}) \rightarrow \mathcal{L}(Y)$ be a smooth semi-algebraic retraction whose fibers are transversal to $\mathcal{L}(Y)$. Its lift by \mathcal{L} is a retraction $\tilde{r}: \mathfrak{X} \rightarrow Y$ whose fibers are transversal to Y . For any $t \in Y$ sufficiently close to 0, $X_t = (\tilde{r})^{-1}(t)$ is semi-algebraically bilipschitz equivalent to $X_0 = (\tilde{r})^{-1}(0)$. Then, according to part (5) of Theorem 1.2, the discriminants Δ_t of the restrictions $\mathcal{L}|_{X_t}$ have same embedded topology. This proves that \mathfrak{X} is Zariski is equisingular along Y . \square

The last sections of the paper are devoted to the proof of (1) \Rightarrow (4).

Notations. Assume \mathfrak{X} is Zariski equisingular along Y at 0. Since Zariski equisingularity is a stable property under analytic isomorphism $(\mathbb{C}^n, 0) \rightarrow (\mathbb{C}^n, 0)$, we will assume without loss of generality that $Y = \{0\} \times \mathbb{C}^{n-3} \subset \mathbb{C}^3 \times \mathbb{C}^{n-3} = \mathbb{C}^n$ where 0 is the origin in \mathbb{C}^3 . We will denote by (\underline{x}, t) the coordinates in $\mathbb{C}^3 \times \mathbb{C}^{n-3}$, with $\underline{x} = (x, y, z) \in \mathbb{C}^3$ and $t \in \mathbb{C}^{n-3}$. For each t , we set $X_t = \mathfrak{X} \cap (\mathbb{C}^3 \times \{t\})$ and consider \mathfrak{X} as the $n-3$ -parameter family of isolated hypersurface singularities $(X_t, (0, t)) \subset (\mathbb{C}^3 \times \{t\}, (0, t))$. For simplicity, we will write $(X_t, 0)$ for $(X_t, (0, t))$.

Let $\mathcal{L}: \mathbb{C}^n \rightarrow \mathbb{C}^{n-1}$ be a generic linear projection for \mathfrak{X} . We choose the coordinates (\underline{x}, t) in $\mathbb{C}^3 \times \mathbb{C}^{n-3}$ so that \mathcal{L} is given by $\mathcal{L}(x, y, z, t) = (x, y, t)$. For each t , the restriction $\mathcal{L}|_{\mathbb{C}^3 \times \{t\}}: \mathbb{C}^3 \times \{t\} \rightarrow \mathbb{C}^2 \times \{t\}$ is a generic linear projection for X_t .

We denote by $\Pi_t \subset X_t$ the polar curve of the restriction $\mathcal{L}|_{X_t} : X_t \rightarrow \mathbb{C}^2 \times \{t\}$ and by Δ_t its discriminant curve $\Delta_t = \mathcal{L}(\Pi_t)$.

Throughout Part 4, we will use the Milnor balls defined as follows. By Speder [21], Zariski equisingularity implies Whitney conditions. Therefore one can choose a constant size $\epsilon > 0$ for Milnor balls of the $(X_t, 0)$ as t varies in some small ball D_δ about $0 \in \mathbb{C}^{n-3}$ and the same is true for the family of discriminants Δ_t . So we can actually use a “rectangular” Milnor ball as introduced in Section 8:

$$B_\epsilon^6 = \{(x, y, z) : |x| \leq \epsilon, |(y, z)| \leq R\epsilon\},$$

and its projection

$$B_\epsilon^4 = \{(x, y) : |x| \leq \epsilon, |y| \leq R\epsilon\},$$

where R and ϵ_0 are chosen so that for $\epsilon \leq \epsilon_0$ and t in a small ball D_δ ,

- (1) $B_\epsilon^6 \times \{t\}$ is a Milnor ball for $(X_t, 0)$;
- (2) for each α such that $|\alpha| \leq \epsilon$, $h_t^{-1}(\alpha)$ intersects the standard sphere $\mathbb{S}_{R\epsilon}^6$ transversely, where h_t denotes the restriction $h_t = x|_{X_t}$;
- (3) the curve Π_t and its tangent cone $T_0\Pi_t$ meet $\partial B_\epsilon^6 \times \{t\}$ only in the part $|x| = \epsilon$.

15. PROOF OUTLINE THAT ZARISKI IMPLIES BILIPSCHITZ EQUISINGULARITY

We start by outlining the proof that Zariski equisingularity implies semi-algebraic Lipschitz triviality. We assume therefore that we have a Zariski equisingular family \mathfrak{X} as above.

We choose $B_\epsilon^6 \subset \mathbb{C}^3$ and $D_\delta \subset \mathbb{C}^{n-3}$ as in the previous section. We want to construct a semi-algebraic bilipschitz homeomorphism $\Phi : \mathfrak{X} \cap (B_\epsilon^6 \times D_\delta) \rightarrow (X_0 \times \mathbb{C}^{n-3}) \cap (B_\epsilon^6 \times D_\delta)$ which preserves the t -parameter. Our homeomorphism will be a piecewise diffeomorphism.

In Section 8 we used a carousel decomposition of B_ϵ^4 for the discriminant curve Δ_0 of the generic linear projection $\mathcal{L}|_{X_0} : X_0 \rightarrow B_\epsilon^4$ and we lifted it to obtain the geometric decomposition of $(X, 0)$ (Definition 8.5). Here, we will consider this construction for each $\mathcal{L}|_{X_t} : X_t \rightarrow B_\epsilon^4 \times \{t\}$.

Next, we construct a semi-algebraic bilipschitz map $\phi : B_\epsilon^4 \times D_\delta \rightarrow B_\epsilon^4 \times D_\delta$ which restricts for each t to a map $\phi_t : B_\epsilon^4 \times \{t\} \rightarrow B_\epsilon^4 \times \{t\}$ which takes the carousel decomposition of B_ϵ^4 for X_t to the corresponding carousel decomposition for X_0 . We also arrange that ϕ_t preserves a foliation of B_ϵ^4 adapted to the carousel decompositions. A first approximation to the desired map $\Phi : \mathfrak{X} \cap (B_\epsilon^6 \times D_\delta) \rightarrow (X_0 \times \mathbb{C}^{n-3}) \cap (B_\epsilon^6 \times D_\delta)$ is then obtained by simply lifting the map ϕ via the branched covers \mathcal{L} and $\mathcal{L}|_{X_0} \times id_{D_\delta}$:

$$\begin{array}{ccc} \mathfrak{X} \cap (B_\epsilon^6 \times D_\delta) & \xrightarrow{\Phi} & (X_0 \cap B_\epsilon^6) \times D_\delta \\ \mathcal{L} \downarrow & & \mathcal{L}|_{X_0} \times id_{D_\delta} \downarrow \\ B_\epsilon^4 \times D_\delta & \xrightarrow{\phi} & B_\epsilon^4 \times D_\delta \end{array}$$

Now, fix t in D_δ . For $\underline{x} \in X_t \cap B_\epsilon^6$, denote by $K(\underline{x}, t)$ the local bilipschitz constant of the projection $\mathcal{L}|_{X_t} : X_t \rightarrow B_\epsilon^4 \times \{t\}$ (see Section 6). Let us fix a large $K_0 > 0$ and consider the set $\mathcal{B}_{K_0, t} = \{\underline{x} \in X_t \cap (B_\epsilon^6 \times D_\delta) : K(\underline{x}, t) \geq K_0\}$.

We then show that Φ is bilipschitz for the inner metric except possibly in the zone $C_{K_0} = \bigcup_{t \in D_\delta} \mathcal{B}_{K_0, t}$, where the bilipschitz constant for the linear projection \mathcal{L} becomes large. This is all done in Section 16.

Using the approximation Proposition 6.5 of $\mathcal{B}_{K_0,t}$ by polar wedges, we then prove that Φ can be adjusted if necessary to be bilipschitz on C_{K_0} .

The construction just explained is based on the key Lemma 19.3 which states constancy of the polar rates of the components of $(\Delta_t, 0)$ as t varies. The proof of this lemma is based on the use of families of plane curves $(\gamma_t, 0)$ such that $(\Delta_t \cup \gamma_t, 0)$ has constant topological type as t varies, and their *liftings* by \mathcal{L} , *spreadings* and *projected liftings* defined in Section 17. The key argument is the *restriction formula* of Teissier [23] that we recall in section 18. Similar techniques were used by Casas-Alvero in [7] in his study of equisingularity of inverse images of plane curves by an analytic morphism $(\mathbb{C}^2, 0) \rightarrow (\mathbb{C}^2, 0)$.

Once Φ is inner bilipschitz, we must show that the outer Lipschitz geometry is also preserved. This is done in Section 19 using again families of plane curves $(\gamma_t, 0)$ as just defined and the restriction formula. Namely we prove the invariance of bilipschitz type of the liftings by \mathcal{L} of such families, which enables one to test invariance of the outer Lipschitz geometry.

The pieces of the proof are finally put together in Section 20.

16. FOLIATED CARROUSEL DECOMPOSITION

We use again the notations of Section 14. In this section, we construct a self-map $\phi: B_\epsilon^4 \times D_\delta \rightarrow B_\epsilon^4 \times D_\delta$ of the image of the generic linear projection which removes the dependence on t of the carousel decompositions and we introduce a foliation of the carrousel by 1-dimensional complex leaves which will be preserved by ϕ . We first present a parametrized version of the carousel construction of section 3 for any choice of truncation of the Puiseux series expansions of Δ .

Carousel depending on the parameter t . By assumption, the family of discriminants Δ_t is an equisingular family of plane curves. It follows that the family of tangent cones $T_0\Delta_t$ is also equisingular. For each t , $T_0\Delta_t$ is a union of tangent lines $L_t^{(1)}, \dots, L_t^{(m)}$ and these are distinct lines for each t . Moreover the union $\Delta_t^{(j)} \subset \Delta_t$ of components of Δ_t which are tangent to $L_t^{(j)}$ is also equisingular.

In Section 3 we described carousel decompositions when there is no parameter t . They now decompose a conical neighbourhood of each line $L_t^{(j)}$. These conical neighbourhoods are as follows. Let the equation of the j -th line be $y = a_1^{(j)}(t)x$. We choose a small enough $\eta > 0$ and $\delta > 0$ such that cones

$$V_t^{(j)} := \{(x, y) : |y - a_1^{(j)}(t)x| \leq \eta|x|, |x| \leq \epsilon\} \subset \mathbb{C}_t^2$$

are disjoint for all $t \in D_\delta$, and then shrink ϵ if necessary so $\Delta_t^{(j)} \cap \{|x| \leq \epsilon\}$ will lie completely in $V_t^{(j)}$ for all t .

We now describe how a carousel decomposition is modified to the parametrized case. We fix $j = 1$ for the moment and therefore drop the superscripts, so our tangent line L has equation $y = a_1(t)x$.

We first choose a truncation of the Puiseux series for each component of Δ_t . Then for each pair $\kappa = (f, p_k)$ consisting of a Puiseux polynomial $f = \sum_{i=1}^{k-1} a_i(t)x^{p_i}$ and an exponent p_k for which there is a Puiseux series $y = \sum_{i=1}^k a_i(t)x^{p_i} + \dots$ describing some component of Δ_t , we consider all components of Δ_t which fit this data. If $a_{k1}(t), \dots, a_{km_\kappa}(t)$ are the coefficients of x^{p_k} which occur in these Puiseux

polynomials we define

$$B_{\kappa,t} := \left\{ (x, y) : \alpha_{\kappa} |x^{p_k}| \leq |y - \sum_{i=1}^{k-1} a_i(t)x^{p_i}| \leq \beta_{\kappa} |x^{p_k}|, \right. \\ \left. |y - \left(\sum_{i=1}^{k-1} a_i(t)x^{p_i} + a_{k_j}(t)x^{p_k} \right)| \geq \gamma_{\kappa} |x^{p_k}| \text{ for } j = 1, \dots, m_{\kappa} \right\}.$$

Again, $\alpha_{\kappa}, \beta_{\kappa}, \gamma_{\kappa}$ are chosen so that $\alpha_{\kappa} < |a_{k_j}(t)| - \gamma_{\kappa} < |a_{k_j}(t)| + \gamma_{\kappa} < \beta_{\kappa}$ for each $j = 1, \dots, m_{\kappa}$ and all small t . If ϵ is small enough, the sets $B_{\kappa,t}$ will be disjoint for different κ . The closure of the complement in V_t of the union of the $B_{\kappa,t}$'s is a union of A - and D -pieces.

Foliated carrousel. We now refine our carrousel decomposition by adding a piecewise smooth foliation of V_t by complex curves compatible with the carrousel. We do this as follows:

A piece $B_{\kappa,t}$ as above is foliated with closed leaves given by curves of the form

$$C_{\alpha} := \{ (x, y) : y = \sum_{i=1}^{k-1} a_i(t)x^{p_i} + \alpha x^{p_k} \}$$

for $\alpha \in \mathbb{C}$ satisfying $\alpha_{\kappa} \leq |\alpha| \leq \beta_{\kappa}$ and $|a_{k_j}(t) - \alpha| \geq \gamma_{\kappa}$ for $j = 1, \dots, m_{\kappa}$ and all small t . We foliate D -pieces similarly, including the pieces which correspond to Δ -wedges about Δ_t .

An A -piece has the form

$$A = \{ (x, y) : \beta_1 |x^{p_{k+1}}| \leq |y - \left(\sum_{i=1}^k a_i(t)x^{p_i} \right)| \leq \beta_0 |x^{p_k}| \},$$

where $a_k(t)$ may be 0, $p_{k+1} > p_k$ and β_0, β_1 are > 0 . We foliate with leaves the immersed curves of the following form

$$C_{r,\theta} := \{ (x, y) : y = \sum_{i=1}^k a_i(t)x^{p_i} + \beta(r)e^{i\theta}x^r \}$$

with $p_k \leq r \leq p_{k+1}$, $\theta \in \mathbb{R}$ and $\beta(r) = \beta_1 + \frac{p_{k+1}-r}{p_{k+1}-p_k}(\beta_0 - \beta_1)$. Note that these leaves may not be closed; for irrational r the topological closure is homeomorphic to the cone on a torus.

Definition 16.1. We call a carrousel decomposition equipped with such a foliation by curves a *foliated carrousel decomposition*.

Trivialization of the family of foliated carrousels. We set

$$V := \bigcup_{t \in D_{\delta}} V_t \times \{t\}.$$

Proposition 16.2. *If δ is sufficiently small, there exists a semi-algebraic bilipschitz map $\phi_V : V \rightarrow V_0 \times D_{\delta}$ such that:*

- (1) ϕ_V preserves the x and t -coordinates,
- (2) for each $t \in D_{\delta}$, ϕ_V preserves the foliated carrousel decomposition of V_t i.e., it maps the carrousel decomposition of V_t to that of V_0 , preserving the respective foliations.
- (3) ϕ_V maps complex lines to complex lines on the portion $|x| < \epsilon$ of ∂V .

Proof. We first construct the map on the slice $V \cap \{x = \epsilon\}$. We start by extending the identity map $V_0 \cap \{x = \epsilon\} \rightarrow V_0 \cap \{x = \epsilon\}$ to a family of piecewise smooth maps $V_t \cap \{x = \epsilon\} \rightarrow V_0 \cap \{x = \epsilon\}$ which map carrousel sections to carrousel sections.

For fixed t we are looking at a carrousel section $V_t \cap \{x = \epsilon\}$ as exemplified in Figure 1. The various regions are bounded by circles. Each disk or annulus in $V_t \cap \{x = \epsilon\}$ is isometric to its counterpart in $V_0 \cap \{x = \epsilon\}$ so we map it by a translation. To extend over a piece of the form $B_{\kappa,t} \cap \{x = \epsilon\}$ we will subdivide $B_{\kappa,t}$ further. Assume first, for simplicity, that the coefficients $a_{k1}(t), \dots, a_{km_\kappa}(t)$ in the description of $B_{\kappa,t}$ satisfy $|a_{k1}(t)| < |a_{k2}(t)| < \dots < |a_{km_\kappa}(t)|$ for small t . For each $j = 1, \dots, m_\kappa$ we define

$$B_{\kappa j,t} := \left\{ (x, y) : \alpha'_\kappa |a_{kj}(t)| |x|^{p_k} \leq |y - \sum_{i=1}^{k-1} a_i(t) x^{p_i}| \leq \beta'_\kappa |a_{kj}(t)| |x|^{p_k}, \right. \\ \left. |y - (\sum_{i=1}^{k-1} a_i(t) x^{p_i} + a_{kj}(t) x^{p_k})| \geq \gamma'_\kappa |a_{kj}(t)| |x|^{p_k} \right\},$$

with $\alpha'_\kappa < |1 - \gamma'_\kappa| < |1 + \gamma'_\kappa|$, $\beta'_\kappa |a_{kj}(t)| < \alpha'_\kappa |a_{k,j+1}|$ for $j = 1, \dots, m_\kappa - 1$, $\gamma'_\kappa |a_{kj}(t)| \leq \gamma_\kappa$, $\alpha_\kappa < \alpha'_\kappa |a_{k1}(t)| < \beta'_\kappa |a_{km_\kappa}(t)| < \beta_\kappa$. This subdivides $B_{\kappa,t}$ into pieces $B_{\kappa j,t}$ with $A(p_k, p_k)$ -pieces between each $B_{\kappa j,t}$ and $B_{\kappa j+1,t}$ and between the $B_{\kappa j,t}$'s and the boundary components of $B_{\kappa,t}$. We can map $B_{\kappa j,t} \cap \{x = \epsilon\}$ to $B_{\kappa j,0} \cap \{x = \epsilon\}$ by a translation by $(\sum_{i=1}^{k-1} a_i(0) \epsilon^{p_i} - \sum_{i=1}^{k-1} a_i(t) \epsilon^{p_i})$ followed by a similarity which multiplies by $a_{kj}(0)/a_{kj}(t)$ centered at $\sum_{i=1}^{k-1} a_i(0) \epsilon^{p_i}$. We map the annuli of $\overline{B_{\kappa,0}} \setminus \bigcup \overline{B_{\kappa j,0}} \cap \{x = \epsilon\}$ to the corresponding annuli of $\overline{B_{\kappa,t}} \setminus \bigcup \overline{B_{\kappa j,t}} \cap \{x = \epsilon\}$ by maps which agree with the already constructed maps on their boundaries and which extend over each annulus by a ‘‘twist map’’ of the form in polar coordinates: $(r, \theta) \mapsto (ar + b, \theta + cr + d)$ for some a, b, c, d .

We assumed above that the $|a_{kj}(t)|$ are pairwise unequal, but if $|a_{kj}(t)| = |a_{kj'}(t)|$ as t varies, then $a_{kj}(t)/a_{kj'}(t)$ is a complex analytic function of t with values in the unit circle, so it must be constant. So in this situation we use a single $B_{\kappa j}$ piece for all j' with $|a_{kj}(t)| = |a_{kj'}(t)|$ and the construction still works.

This defines our map ϕ_V on $\{x = \epsilon\} \times D_\delta$ for δ sufficiently small, and the requirement that ϕ_V preserve x -coordinate and foliation extends it uniquely to all of $V \times D_\delta$.

The map ϕ_V is constructed to be semi-algebraic, and it remains to prove that it is bilipschitz. It is bilipschitz on $(V \cap \{|x| = \epsilon\}) \times D_\delta$ since it is piecewise smooth on a compact set. Depending what leaf of the foliation one is on, in a section $|x| = \epsilon'$ with $0 < \epsilon' \leq \epsilon$, a neighbourhood of a point \mathbf{p} scales from a neighbourhood of a point \mathbf{p}' with $|x| = \epsilon$ by a factor of $(\epsilon'/\epsilon)^r$ in the y -direction (and 1 in the x direction) as one moves in along a leaf, and the same for $\phi_V(\mathbf{p})$. So to high order the local bilipschitz constant of ϕ_V at \mathbf{p} is the same as for \mathbf{p}' and hence bounded. Thus the bilipschitz constant is globally bounded on $(V \setminus \{0\}) \times D_\delta$, and hence on $V \times D_\delta$. \square

The V of the above proposition was any one of the m sets $V^{(i)} := \bigcup_{t \in D_\delta} V_t^{(i)}$, so the proposition extends ϕ to all these sets. We extend the carrousel foliation on the union of these sets to all of $B_\epsilon^4 \times \{t\}$ by foliating the complement of the union of $V_t^{(i)}$'s by complex lines. We denote B_ϵ^4 with this carrousel decomposition and foliation structure by $B_{\epsilon,t}$. We finally extend ϕ to the whole of $\bigcup_{t \in D_\delta} B_{\epsilon,t}$ by a

diffeomorphism which takes the complex lines of the foliation linearly to complex lines of the foliation on $B_{\epsilon,0} \times D_\delta$, preserving the x coordinate. The resulting map remains obviously semi-algebraic and bilipschitz.

We then have shown:

Proposition 16.3. *There exists a map $\phi: \bigcup_{t \in D_\delta} B_{\epsilon,t} \rightarrow B_{\epsilon,0} \times D_\delta$ which is semi-algebraic and bilipschitz and such that each $\phi_t: B_{\epsilon,t} \rightarrow B_{\epsilon,0} \times \{t\}$ preserves the carousel decompositions and foliations.* \square

17. LIFTINGS AND SPREADINGS

Let $(X,0) \subset (\mathbb{C}^3,0)$ be an isolated hypersurface singularity and let $\ell: \mathbb{C}^3 \rightarrow \mathbb{C}^2$ be a generic linear projection for $(X,0)$. Consider an irreducible plane curve $(\gamma,0) \subset (\mathbb{C}^2,0)$.

Definition 17.1. The *lifting* of γ is the curve

$$L_\gamma := (\ell|_X)^{-1}(\gamma).$$

Let $\ell': \mathbb{C}^3 \rightarrow \mathbb{C}^2$ be another generic linear projection for $(X,0)$ which is also generic for L_γ . We call the plane curve

$$P_\gamma = \ell'(L_\gamma)$$

a *projected lifting* of γ .

Notice that the topological type of $(P_\gamma,0)$ does not depend on the choice of ℓ' .

Let us choose the coordinates (x,y,z) of \mathbb{C}^3 in such a way that $\ell = (x,y)$ and γ is tangent to the x -axis. We consider a Puiseux expansion of γ :

$$\begin{aligned} x(w) &= w^q \\ y(w) &= a_1 w^{q_1} + a_2 w^{q_2} + \dots + a_{n-1} w^{q_{n-1}} + a_n w^{q_n} + \dots \end{aligned}$$

Let $F(x,y,z) = 0$ be an equation for $X \subset \mathbb{C}^3$.

Definition 17.2. We call the plane curve $(F_\gamma,0) \subset (\mathbb{C}^2,0)$ with equation

$$F(x(w), y(w), z) = 0$$

a *spreading* of the lifting L_γ .

Notice that the topological type of $(F_\gamma,0)$ does not depend on the choice of the parametrization.

Lemma 17.3. *The topological types of the spreading $(F_\gamma,0)$ and of the projected lifting $(P_\gamma,0)$ determine each other.*

Proof. Assume that the coordinates of \mathbb{C}^3 are chosen in such a way that $\ell' = (x,z)$. Then $P_\gamma = \rho(F_\gamma)$ where $\rho: \mathbb{C}^2 \rightarrow \mathbb{C}^2$ denotes the morphism $\rho(w,z) = (w^q, z)$, which is a cyclic q -fold cover branched on the line $w = 0$. Thus P_γ determines F_γ . The link of $P_\gamma \cup \{z\text{-axis}\}$ consists of an iterated torus link braided around an axis and it has a \mathbb{Z}/q -action fixing the axis. Such a \mathbb{Z}/q -action is unique up to isotopy. Thus the link of F_γ can be recovered from the link of P_γ by quotienting by this \mathbb{Z}/q -action. \square

18. RESTRICTION FORMULA

In this section, we apply the restriction formula to compute the Milnor number of a spreading F_γ . Let us first recall the formula.

Proposition 18.1. ([23, 1.2]) *Let $(Y, 0) \subset (\mathbb{C}^{n+1}, 0)$ be a germ of hypersurface with isolated singularity, let H be a hyperplane of \mathbb{C}^{n+1} such that $H \cap Y$ has isolated singularity. Assume that (z_0, \dots, z_n) is a system of coordinates of \mathbb{C}^{n+1} such that H is given by $z_0 = 0$. Let $\text{proj}: (Y, 0) \rightarrow (\mathbb{C}, 0)$ be the restriction of the function z_0 . Then*

$$m_H = \mu(Y) + \mu(Y \cap H),$$

where $\mu(Y)$ and $\mu(Y \cap H)$ denote the Milnor numbers respectively of $(Y, 0) \subset (\mathbb{C}^{n+1}, 0)$ and $(Y \cap H, 0) \subset (H, 0)$, and where m_H is the multiplicity of the origin 0 as the discriminant of the morphism proj . \square

The multiplicity m_H is defined as follows ([23]). Assume that an equation of $(Y, 0)$ is $f(z_0, z_1, \dots, z_n) = 0$ and let $(\Gamma, 0)$ be the curve in $(\mathbb{C}^{n+1}, 0)$ defined by $\frac{\partial f}{\partial z_1} = \dots = \frac{\partial f}{\partial z_n} = 0$. Then $m_H = (Y, \Gamma)_0$, the intersection at the origin of the two germs $(Y, 0)$ and $(\Gamma, 0)$.

Remark 18.2. Applying this when $n = 1$, i.e., in the case of a plane curve $(Y, 0) \subset (\mathbb{C}^2, 0)$, we obtain:

$$m_H = \mu(Y) + \text{mult}(Y) - 1,$$

where $\text{mult}(Y)$ denotes the multiplicity of $(Y, 0)$.

Proposition 18.3. *Let $(X, 0) \subset (\mathbb{C}^3, 0)$ be an isolated hypersurface singularity. Let $\ell: \mathbb{C}^3 \rightarrow \mathbb{C}^2$ be a generic linear projection for $(X, 0)$ and let $(\gamma, 0) \subset (\mathbb{C}^2, 0)$ be an irreducible plane curve which is not a branch of the discriminant curve of $\ell|_X$. The Milnor number at 0 of the spreading $(F_\gamma, 0)$ can be computed in terms of the following data:*

- (1) *the multiplicity of the surface $(X, 0)$;*
- (2) *the topological type of the triple (X, Π, L_γ) where $(\Pi, 0) \subset (X, 0)$ denotes the polar curve of $\ell|_X$.*

Proof. Choose coordinates in \mathbb{C}^3 such that $\ell = (x, y)$, and consider a Puiseux expansion of γ as in Section 17. Applying the restriction formula 18.1 to the projection $\text{proj}: (F_\gamma, 0) \rightarrow (\mathbb{C}, 0)$ defined as the restriction of the function w , we obtain:

$$\mu(F_\gamma) = (F_\gamma, \Gamma)_0 - \text{mult}(F_\gamma) + 1,$$

where $(\Gamma, 0)$ has equation

$$\frac{\partial F}{\partial z}(x(w), y(w), z) = 0.$$

We have easily: $\text{mult}(F_\gamma) = \text{mult}(X, 0)$.

Moreover, the polar curve Π is the set $\{(x, y, z) \in X : \frac{\partial F}{\partial z}(x, y, z) = 0\}$. Since the map $\theta: F_\gamma \rightarrow L_\gamma$ defined by $\theta(w, z) = (x(w), y(w), z)$ is a bijection, the intersection multiplicity $(F_\gamma, \Gamma)_0$ in \mathbb{C}^2 equals the intersection multiplicity at 0 on the surface $(X, 0)$ of the two curves L_γ and Π . \square

19. CONSTANCY OF PROJECTED LIFTINGS AND OF POLAR RATES

We use again the notations of Section 15 and we consider a Zariski equisingular family $(X_t, 0)$ of 2-dimensional complex hypersurfaces.

Proposition 19.1. *The following data is constant through the family $(X_t, 0)$:*

- (1) *the multiplicity of the surface $(X_t, 0)$,*
- (2) *the topological type of the pair (X_t, Π_t) .*

Proof. (1) follows (in all codimension) from the chain of implications: Zariski equisingularity \Rightarrow Whitney conditions (Speder [21]) $\Rightarrow \mu^*$ -constancy (e.g., [6]; see also [27] in codimension 2). (2) follows immediately since (X_t, Π_t) is a continuous family of branched covers of \mathbb{C}^2 of constant covering degree and with constant topology of the branch locus. \square

Corollary 19.2. *Consider a family of irreducible plane curves $(\gamma_t, 0) \subset (\mathbb{C}^2, 0)$ such that γ_t is not a branch of Δ_t and the topological type of $(\gamma_t \cup \Delta_t, 0)$ is constant as t varies. Let $\mathcal{L}': \mathbb{C}^3 \times \mathbb{C}^{n-3} \rightarrow \mathbb{C}^2 \times \mathbb{C}^{n-3}$ be a generic linear projection for $(\mathfrak{X}, 0)$ which is also generic for the family of liftings $(L_{\gamma_t})_t$. Then the family of projected liftings $P_{\gamma_t} = \mathcal{L}'(L_{\gamma_t})$ has constant topological type.* \square

Proof. According to Propositions 18.3 and 19.1, the Milnor number $\mu(F_{\gamma_t})$ is constant. The result follows by the Lê-Ramanujan theorem for a family of plane curves ([15]) and Lemma 17.3. \square

Let us now consider a branch $(\Delta'_t)_t$ of the family of discriminant curves $(\Delta_t)_t$. For each t , let $s(\Delta'_t)$ denote the contact exponent of Δ'_t .

Lemma 19.3. *The polar rate $s(\Delta'_t)$ does not depend on $t \in D_\delta$.*

Proof. Let $r \in \frac{1}{N}\mathbb{N}$ and $\lambda \in \mathbb{C}^*$ and let $(\gamma_t, 0) \subset (\mathbb{C}^2, 0)$ be the family of irreducible curves defined by

$$y = \sum_{i \geq N} a_i(t)x^{i/N} + \lambda x^r,$$

where $y = \sum_{i \geq N} a_i(t)x^{i/N}$ is a Puiseux expansion of Δ'_t . Since $r \in \frac{1}{N}\mathbb{N}$, the curves $(\Delta_t \cup \gamma_t, 0)$ have constant topological type as t varies. Then, by Corollary 19.2, the projected liftings P_{γ_t} have constant topological type. Taking r big enough to be sure that the curve γ_t is in a Δ -wedge about Δ'_t . Let P'_{γ_t} be the union of components of P_{γ_t} which are in a polar wedge about Π'_t . Then the family $(P'_{\gamma_t})_t$ also has constant topological type. By Lemma 6.6, this implies the constancy of the rates $q_t(r) = \frac{s(\Delta'_t) + r}{2}$. Obviously $q_t(s(\Delta'_t)) = s(\Delta'_t)$ and $q_t(r) < r$ for each $r > s(\Delta'_t)$. Since $q_t(r)$ is constant through the family, the inequality $q_t(r) < r$ holds for each t or for none. This proves the constancy of the polar rate $s(\Delta'_t)$ as t varies in D_δ . \square

20. PROOF THAT ZARISKI EQUISINGULARITY IMPLIES LIPSCHITZ TRIVIALITY

We use the notations of Sections 14 and 15. For t fixed in D_δ and $K_0 > 0$ sufficiently large, recall (Section 15) that $\mathcal{B}_{K_0, t}$ denotes the neighbourhood of Π_t in X_t where the local bilipschitz constant $K(\underline{x}, t)$ of $\mathcal{L}|_{X_t}$ is bigger than K_0 .

The aim of this section is to complete the proof that Zariski equisingularity implies Lipschitz triviality.

According to Lemma 19.3, the polar rate of each branch of $(\Delta_t, 0)$ is constant as t varies. Then, we can consider the carrousel decomposition for $(\Delta_t, 0)$ obtained by truncated the Puiseux expansion of each branch at the first term which has exponent greater or equal to the corresponding polar rate and where truncation does not affect the topology of $(\Delta_t, 0)$. In other words, we consider the complete carrousel decomposition for $(\Delta_t, 0)$ as defined in Section 7, obtaining a carrousel decomposition depending on the parameter t , as introduced in Section 16. In particular, each component of $(\Delta_t, 0)$ is contained in a D -piece which is a Δ -wedge about it.

We consider the corresponding foliated carrousel as described in Section 16 and we denote by $B_{\epsilon, t}$ the ball $B^4 \times \{t\}$ equipped with this foliated carrousel. Then, we consider a trivialization of this family of carrousel as in Propositions 16.2 and 16.3. The following result is a corollary of Proposition 16.3:

Lemma 20.1. *There exists a commutative diagram*

$$\begin{array}{ccc} (\mathfrak{X}, 0) \cap (\mathbb{C}^3 \times D_\delta) & \xrightarrow{\Phi} & (X_0, 0) \times D_\delta \\ \mathcal{L}|_{\mathfrak{X}} \downarrow & & \mathcal{L}|_{X_0} \times id \downarrow \\ (\mathbb{C}^2, 0) \times D_\delta & \xrightarrow{\phi} & (\mathbb{C}^2, 0) \times D_\delta \end{array}$$

such that ϕ is the map of the above proposition and Φ is semi-algebraic, and inner bilipschitz except possibly in the set $C_{K_0} := \bigcup_{t \in D_\delta} \mathcal{B}_{K_0, t}$.

Proof. Φ is simply the lift of ϕ over the branched cover $\mathcal{L}|_{\mathfrak{X}}$. The map $\mathcal{L}|_{\mathfrak{X}}$ is a local diffeomorphism with Lipschitz constant bounded above by K_0 outside C_{K_0} so Φ has Lipschitz coefficient bounded by K_0^2 times the Lipschitz bound for ϕ outside C_{K_0} . The semi-algebraicity of Φ is because ϕ , $\mathcal{L}|_{\mathfrak{X}}$ and $\mathcal{L}|_{X_0} \times id$ are semi-algebraic. \square

We will show that the map Φ of Lemma 20.1 is bilipschitz with respect to the outer metric after modifying it as necessary within the set C_{K_0} .

Proof. We first make the modification in $\mathcal{B}_{K_0, 0}$. Recall that according to Proposition 6.5, $\mathcal{B}_{K_0, t}$ can be approximated for each t by a polar wedge about Π_t , and then its image $\mathcal{N}_{K_0, t} = \mathcal{L}|_{X_t}(\mathcal{B}_{K_0, t})$ can be approximated by a Δ -wedge about the polar curve Δ_t , i.e., by a union of D -pieces of the foliated carrousel decomposition $B_{\epsilon, t}$.

Let $\mathcal{N}'_{K_0, 0}$ be one of these D -pieces, and let q be its rate. By [1, Lemma 12.1.3], any component $\mathcal{B}'_{K_0, 0}$ of $\mathcal{B}_{K_0, 0}$ over $\mathcal{N}'_{K_0, 0}$ is also a $D(q)$ -piece in X_0 .

By Proposition 16.3, the inverse image under the map ϕ_t of $\mathcal{N}'_{K_0, 0}$ is $\mathcal{N}'_{K_0, t}$. Then the inverse image under the lifting Φ_t of $\mathcal{B}'_{K_0, 0} \subset X_0$ will be the polar wedge $\mathcal{B}'_{K_0, t}$ in X_t with the same polar rate. So we can adjust Φ_t as necessary in this zone to be a bilipschitz equivalence for the inner metric and to remain semi-algebraic.

We can thus assume now that Φ is semi-algebraic and bilipschitz for the inner metric, with Lipschitz bound K say. We will now show it is also bilipschitz for the outer metric.

We first consider a pair of points $\underline{p}_1, \underline{p}_2$ of $X_t \cap B_\epsilon^6$ which lie over the same point $\underline{p} \in B_{\epsilon, t}$ (we will say they are ‘‘vertically aligned’’). We may assume, by moving them slightly if necessary, that \underline{p} is on a closed curve γ of our foliation of $B_{\epsilon, t}$ with

Puiseux expansion

$$\begin{aligned} x(w) &= w^q \\ y(w) &= a_1 w^{q_1} + a_2 w^{q_2} + \dots + a_{n-1} w^{q_{n-1}} + a_n w^{q_n} + \dots \end{aligned}$$

Let \mathcal{L}' be a different generic linear projection as in Corollary 19.2. If $w = w_0$ is the parameter of the point $\mathbf{p} \in \gamma$, consider the arc $C(s) = (x(sw_0), y(sw_0))$, $s \in [0, 1]$ and lift it to X_t to obtain a pair of arcs $\mathbf{p}_1(s), \mathbf{p}_2(s)$, $s \in [0, 1]$ with $\mathbf{p}_1(1) = \mathbf{p}_1$ and $\mathbf{p}_2(1) = \mathbf{p}_2$. We assume that the distance $d(\mathbf{p}_1(s), \mathbf{p}_2(s))$ shrinks faster than linearly as $s \rightarrow 0$, since otherwise the pair is uninteresting from the point of view of bilipschitz geometry.

Note that the distance $d(\mathbf{p}_1(s), \mathbf{p}_2(s))$ is a multiple $kd(\mathcal{L}'(\mathbf{p}_1(s)), \mathcal{L}'(\mathbf{p}_2(s)))$ (with k depending only on the projections \mathcal{L} and \mathcal{L}'). Now $d(\mathcal{L}'(\mathbf{p}_1(s)), \mathcal{L}'(\mathbf{p}_2(s)))$ is to high order $s^r d(\mathcal{L}'(\mathbf{p}_1(1)), \mathcal{L}'(\mathbf{p}_2(1)))$ for some rational $r > 1$. Moreover, by Corollary 19.2, if we consider the corresponding picture in X_0 , starting with $\Phi(\mathbf{p}_1)$ and $\Phi(\mathbf{p}_2)$ we get the same situation with the same exponent r . So to high order we see that $d(\Phi(\mathbf{p}_1(s)), \Phi(\mathbf{p}_2(s)))/d(\mathbf{p}_1(s), \mathbf{p}_2(s))$ is constant.

There is certainly an overall bound on the factor by which Φ scales distance between vertically aligned points \mathbf{p}_1 and \mathbf{p}_2 so long as we restrict ourselves to the compact complement in $\mathfrak{X} \cap (B_\epsilon^6 \times D_\delta)$ of an open neighbourhood of $\{0\} \times D_\delta$. The above argument then shows that this bound continues to hold as we move towards 0. Thus Φ distorts distance by at most a constant factor for all vertically aligned pairs of points.

Finally, consider any two points $\mathbf{p}_1, \mathbf{p}_2 \in X_0 \cap B_\epsilon^6$ and their images $\mathbf{q}_1, \mathbf{q}_2$ in \mathbb{C}^2 . We will assume for the moment that neither \mathbf{p}_1 or \mathbf{p}_2 is in a Δ -wedge. The outer distance between \mathbf{p}_1 and \mathbf{p}_2 is the length of the straight segment joining them. Let γ be the image of this segment, so γ connects \mathbf{q}_1 to \mathbf{q}_2 . If γ intersects the Δ -wedge, we can modify it to a curve avoiding the Δ -wedge which has length less than π times the original length of γ . Lift γ to a curve γ' starting at \mathbf{p}_1 . Then γ' ends at a point \mathbf{p}'_2 which is vertically aligned with \mathbf{p}_2 . Let γ'' be the curve obtained by appending the vertical segment $\mathbf{p}'_2 \mathbf{p}_2$ to γ' . We then have:

$$\text{len}(\mathbf{p}_1 \mathbf{p}_2) \leq \text{len}(\gamma''),$$

where len denotes length. On the other hand, $\text{len}(\gamma') \leq K_0 \text{len}(\gamma)$, and as γ is the projection of the segment $\mathbf{p}_1 \mathbf{p}_2$, we have $\text{len}(\gamma) \leq \text{len}(\mathbf{p}_1 \mathbf{p}_2)$, so $\text{len}(\gamma') \leq K_0 \text{len}(\mathbf{p}_1 \mathbf{p}_2)$. If we join the segment $\mathbf{p}_1 \mathbf{p}_2$ to γ' at \mathbf{p}_1 we get a curve from \mathbf{p}_2 to \mathbf{p}'_2 , so $\text{len}(\mathbf{p}'_2 \mathbf{p}_2) \leq (1 + \pi K_0) \text{len}(\mathbf{p}_1 \mathbf{p}_2)$ and as $\text{len}(\gamma'') = \text{len}(\gamma') + \text{len}(\mathbf{p}'_2 \mathbf{p}_2)$, we then obtain :

$$\text{len}(\gamma'') \leq (1 + 2K_0\pi) \text{len}(\mathbf{p}_1 \mathbf{p}_2).$$

We have thus shown that up to a bounded constant the outer distance between two points can be achieved by following a path in X followed by a vertical segment.

We have proved this under the assumption that we do not start or end in the polar wedge. Now, take two other projections \mathcal{L}' and \mathcal{L}'' such that for K_0 is sufficiently large, the polar wedges of the restrictions of \mathcal{L} , \mathcal{L}' and \mathcal{L}'' to X_0 with constant K_0 are pairwise disjoint outside the origin. Then if \mathbf{p}_1 and \mathbf{p}_2 are any two points in $X_0 \cap B_\epsilon^6$, they are outside the polar wedge for at least one of \mathcal{L} , \mathcal{L}' or \mathcal{L}'' and we conclude as before.

The same argument applies to $X_0 \times D_\delta$. Now paths in \mathfrak{X} are modified by at most a bounded factor by Φ since Φ is inner bilipschitz, while vertical segments are

also modified by at most a bounded factor by the previous argument. Thus outer metric is modified by at most a bounded factor. \square

REFERENCES

- [1] Lev Birbrair, Walter D Neumann and Anne Pichon, The thick-thin decomposition and the bilipschitz classification of normal surface singularities, *Acta Math.* **212** (2014), 199–256.
- [2] Joël Briançon and Jean-Pierre Henry, Équisingularité générique des familles de surfaces à singularités isolées, *Bull. Soc. Math. France* **108** (1980), 260–284.
- [3] Andreas Bernig and Alexander Lytchak, Tangent spaces and Gromov-Hausdorff limits of subanalytic spaces, *J. Reine Angew. Math.* **608** (2007), 1–15.
- [4] Joël Briançon and Jean-Paul Speder, La trivialité topologique n’implique pas les conditions de Whitney, *C.R. Acad. Sc. Paris*, **280** (1975), 365–367.
- [5] Joël Briançon and Jean-Paul Speder, Familles équisingulières de surfaces à singularité isolée, *C.R. Acad. Sc. Paris*, t.280, 1975, 1013–1016.
- [6] Joël Briançon and Jean-Paul Speder, Les conditions de Whitney impliquent $\mu^{(*)}$ constant, *Annales de l’Inst. Fourier*, tome 26, 2 (1976), 153–163.
- [7] Eduardo Casas-Alvero, Discriminant of a morphism and inverse images of plane curve singularities, *Math. Proc. Camb. Phil. Soc.* (2003), **135**, 385–394.
- [8] David Eisenbud and Walter D Neumann, *Three dimensional link theory and invariants of plane curves singularities*, *Annals of Mathematics Studies* 110, Princeton University Press, 1985.
- [9] Alexandre Fernandes, Topological equivalence of complex curves and bi-Lipschitz maps, *Michigan Math. J.* **51** (2003), 593–606.
- [10] Gérard Gonzalez-Springberg, Résolution de Nash des points doubles rationnels, *Ann. Inst. Fourier, Grenoble* **32** (1982), 111–178.
- [11] Jean-Pierre Henry and Adam Parusiński, Existence for moduli for bi-Lipschitz equivalence of analytic functions, *Compositio Math.*, **136** (2003), 217–235.
- [12] Lê Dũng Tráng, The geometry of the monodromy theorem. C. P. Ramanujam—a tribute, *Tata Inst. Fund. Res. Studies in Math.*, **8** (Springer, Berlin-New York, 1978), 157–173.
- [13] Joseph Lipman, Equisingularity and simultaneous resolution of singularities, *Resolution of singularities (Obergrugl, 1997)*, *Progr. Math.*, **181** (Birkhäuser, Basel, 2000), 485–505.
- [14] Lê Dũng Tráng and Bernard Teissier, Variétés polaires locales et classes de Chern des variétés singulières, *Ann. Math.*, 2nd Ser. **114** (3) (1981), 457–491.
- [15] Lê Dũng Tráng and C.P. Ramanujam, The invariance of Milnor’s number implies the invariance of the topological type, *Amer. J. Math.* **98** (1976), 67–78.
- [16] Joseph Lipman and Bernard Teissier, Zariski’s papers on equisingularity, in *The unreal life of Oscar Zariski* by Carol Parikh, Springer, 1991, 171–179.
- [17] Tadeusz Mostowski, Lipschitz equisingularity problems (Several topics in singularity theory), Departmental Bulletin Paper (Kyoto University, 2003) 73–113, <http://hdl.handle.net/2433/43241>
- [18] Walter D Neumann, A calculus for plumbing applied to the topology of complex surface singularities and degenerating complex curves, *Trans. Amer. Math. Soc.* **268** (1981), 299–343.
- [19] Walter D Neumann and Anne Pichon, Lipschitz geometry of complex curves, to appear in *Journal of Singularities*, <http://arxiv.org/abs/1302.1138>
- [20] Frédéric Pham and Bernard Teissier, Fractions Lipschitziennes d’une algèbre analytique complexe et saturation de Zariski. Prépublications École Polytechnique No. M17.0669 (1969).
- [21] Jean-Paul Speder, Équisingularité et conditions de Whitney, *Amer. J. Math.* **97** (1975) 571–588.
- [22] Mark Spivakovsky, Sandwiched singularities and desingularization of surfaces by normalized Nash transformations, *Ann. Math.* **131** (1990), 411–491.
- [23] Bernard Teissier, Cycles évanescents, sections planes et conditions de Whitney, *Astérisque* **7-8** (SMF 1973).
- [24] Bernard Teissier, Introduction to equisingularity problems, *Proc. of Symposia in pure Mathematics*, Vol. 29 (1975), 593–632.

- [25] Bernard Teissier, Variétés polaires II. Multiplicités polaires, sections planes, et conditions de Whitney, *Algebraic geometry (La Rábida, 1981)* 314–491, Lecture Notes in Math. **961** (Springer, Berlin, 1982).
- [26] René Thom, Ensembles et morphismes stratifiés, *Bull. Amer. Math. Soc.*, **75** (1969), 240–284.
- [27] Alexander Varchenko, The relations between topological and algebro-geometric equisingularities according to Zariski, *Functional Anal. Appl.* **7** (1973), 87–90.
- [28] Alexander Varchenko, Algebro-geometrical equisingularity and local topological classification of smooth mapping, *Proc. Internat. Congress of Mathematicians, Vancouver 1974*, Vol. 1, 427–431.
- [29] Oscar Zariski, Some open questions in the theory of singularities, *Bull. of the Amer. Math. Soc.*, **77** (1971), 481–491.
- [30] Oscar Zariski, The elusive concept of equisingularity and related questions, *Johns Hopkins Centennial Lectures (supplement to the American Journal of Mathematics)* (1977), 9–22.
- [31] Oscar Zariski, Foundations of a general theory of equisingularity on r -dimensional algebroid and algebraic varieties, of embedding dimension $r + 1$, *Amer. J. of Math*, Vol. **101** (1979), 453–514.

DEPARTMENT OF MATHEMATICS, BARNARD COLLEGE, COLUMBIA UNIVERSITY, 2009 BROADWAY
MC4424, NEW YORK, NY 10027, USA

E-mail address: `neumann@math.columbia.edu`

AIX MARSEILLE UNIVERSITÉ, CNRS, CENTRALE MARSEILLE, I2M, UMR 7373, 13453 MAR-
SEILLE, FRANCE

E-mail address: `anne.pichon@univ-amu.fr`