



HAL
open science

Comparison of five integrative samplers in laboratory for the monitoring of indicator and dioxin-like polychlorinated biphenyls in water

R. Jacquet, Cecile Miega, F. Smedes, C. Tixier, J. Tronczynski, Anne Togola, Catherine Berho, I. Valor, J. Llorca, B. Barillon, et al.

► To cite this version:

R. Jacquet, Cecile Miega, F. Smedes, C. Tixier, J. Tronczynski, et al.. Comparison of five integrative samplers in laboratory for the monitoring of indicator and dioxin-like polychlorinated biphenyls in water. *Chemosphere*, 2014, 98, pp.18-27. <10.1016/j.chemosphere.2013.09.011>. <hal-01122587>

HAL Id: hal-01122587

<https://hal.science/hal-01122587v1>

Submitted on 4 Mar 2015

HAL is a multi-disciplinary open access archive for the deposit and dissemination of scientific research documents, whether they are published or not. The documents may come from teaching and research institutions in France or abroad, or from public or private research centers.

L'archive ouverte pluridisciplinaire **HAL**, est destinée au dépôt et à la diffusion de documents scientifiques de niveau recherche, publiés ou non, émanant des établissements d'enseignement et de recherche français ou étrangers, des laboratoires publics ou privés.



HAL Authorization

1 **Title**

2 Comparison of five integrative samplers in laboratory for the monitoring of indicator and
3 dioxin-like polychlorinated biphenyls in water

4 **Authors**

5 Romain Jacquet^a, Cécile Miège^{a*}, Foppe Smedes^{b,c}, Céline Tixier^d, Jacek Tronczynski^d,
6 Anne Togola^e, Catherine Berho^e, Ignacio Valor^f, Julio Llorca^f, Bruno Barillon^g, P
7 Marchand^h, Marina Coquery^a

8

9 **Affiliations**

10 ^aIrstea, U.R. MALY, 5 rue de la Doua, CS70077, 69626 Villeurbanne Cedex, France

11 ^bDeltares, PO Box 85467, 3508AL, Utrecht, The Netherlands.

12 ^cMasaryk University, RECETOX, Kamenice 126/3, 625 00 Brno, Czech Republic.

13 ^dIfremer, RBE-BE-LBCO, rue de l'île d'Yeu, 44311 Nantes Cedex 3, France.

14 ^eBRGM, Monitoring and Analysis Division, 3 avenue Claude Guillemin, 45060 Orléans, France.

15 ^fLABAQUA, c/ Dracma 16-18, Poligono Industrial Las Atalayas, 03114 Alicante, Spain.

16 ^gSuez Environnement CIRSEE, 38 rue du Président Wilson, 78230 Le Peck, France.

17 ^hLUNAM University, ONIRIS, LABERCA, Atlanpôle -La Chantrerie, BP 50707, Nantes, 44307,
18 France.

19

20 *Corresponding author and coordinator of the Eclipse project: Cécile Miège

21 E-mail address: cecile.miege@irstea.fr

22 Tel: +33-472-208-744

23 Fax: +33-478-477-875

24

25 **Abstract**

26 This study aimed at evaluating and comparing five integrative samplers for the
27 monitoring of indicator and dioxin-like polychlorinated biphenyls (PCBs) in water: semi-
28 permeable membrane device (SPMD), silicone rubber, low-density polyethylene (LDPE)
29 strip, Chemcatcher and a continuous-flow integrative sampler (CFIS). These samplers
30 were spiked with performance reference compounds (PRCs) and then simultaneously
31 exposed under constant agitation and temperature in a 200 L stainless steel tank for
32 periods ranging from one day to three months. A constant PCB concentration of about 1
33 ng/L was achieved by immersing a large amount of silicone rubber sheets (“dosing
34 sheets”) spiked with the target PCBs. The uptake of PCBs in the five samplers showed
35 overall good repeatability and their accumulation was linear with time. The samplers
36 SPMD, silicone rubber and LDPE strip were the most promising in terms of achieving low
37 limits of quantification. Time-weighted average (TWA) concentrations of PCBs in water
38 were estimated from uptake of PCBs using the sampling rates calculated from the release
39 of PRCs. Except for Chemcatcher, a good agreement was found between the different
40 samplers and TWA concentrations ranged between 0.4 and 2.8 times the nominal water
41 concentration. Finally, the influence of calculation methods (sampler-water partition
42 coefficients, selected PRCs, models) on final TWA concentrations was studied.

43

44 **Keywords**

45 Integrative samplers, polychlorinated biphenyls, water monitoring, time weighted average
46 concentration, modeling.

47

48 **1. Introduction**

49 Like many other hydrophobic organic contaminants, polychlorinated biphenyls
50 (PCBs) have toxic effects on living organisms, including human beings (Carpenter, 2006).
51 In aquatic environments, PCBs are principally adsorbed on particulate matter due to their
52 hydrophobicity ($\log K_{OW} > 4.5$); hence, their concentration in the dissolved phase is
53 therefore very low, typically in the ng/L to pg/L range. Monitoring such low concentrations
54 with traditional bottle (or grab) sampling is challenging and requires sophisticated
55 analytical methods such as isotopic dilution mass spectrometry. Furthermore, grab
56 sampling only provides a snapshot of the contaminant concentration at a particular time
57 without taking temporal variations into account.

58 Since two decades, several integrative sampling devices have been developed for
59 the monitoring of organic contaminants in aquatic environments (Greenwood *et al.* 2009,
60 Söderström *et al.* 2009, Lohmann *et al.* 2012). These samplers enable the improvement of
61 limits of quantification (LOQ) by accumulation and concentration of contaminants over
62 long-term exposure. Moreover, when they are used in the integrative phase of uptake (i.e.
63 integrative samplers), time-weighted average (TWA) concentrations over the exposure
64 period can be calculated, leading to a better representativeness of measurements.

65 Several integrative samplers, at different stages of development, are now available
66 for monitoring non-polar organic contaminants. The semi-permeable membrane device
67 (SPMD) is one of the most comprehensively studied integrative sampler; it consists of a
68 low-density polyethylene (LDPE) lay-flat tubing filled with a small quantity of triolein. It was
69 designed to sequester and concentrate freely dissolved organic contaminants with $\log K_{OW}$
70 ranging from three to eight and has already been extensively used for the monitoring of
71 PCBs in water (Huckins *et al.* 2006). Next to biphasic sampling devices like SPMD, single-
72 phase integrative samplers, such as LDPE strip and silicone rubber (SR), are gaining
73 interest due to simpler modelling of contaminant transport processes and easier sample

74 processing. Numerous studies have shown the suitability of LDPE strips for the monitoring
75 of hydrophobic organic contaminants, such as polyaromatic hydrocarbons (PAHs) or PCBs
76 in various water bodies (Booij *et al.* 2003, Carls *et al.* 2004, Adams *et al.* 2007, Anderson
77 *et al.* 2008). Silicone rubber was also found to be a suitable alternative to SPMD for the
78 monitoring of hydrophobic contaminants (Rusina 2007). Indeed, SR sheets have been
79 successfully used for the monitoring of PAHs and PCBs from 2002 in The Netherlands
80 (Smedes 2007). Chemcatcher can house different combinations of receiving phases and
81 membranes as appropriate for polar or non-polar contaminants monitoring (Greenwood *et*
82 *al.* 2007). The first non-polar version of Chemcatcher, made of a C18 Empore disk and a
83 LDPE membrane, aimed at sampling contaminants with $\log K_{OW}$ greater than three
84 (Kingston *et al.* 2000). A recent optimization of the sampler, by adding a small volume of
85 octanol between the receiving phase and the membrane, was proposed to decrease the
86 internal sampler resistance to mass transfer of hydrophobic compounds with $\log K_{OW}$
87 above five (Vrana *et al.* 2005). Chemcatcher has already been used during field
88 campaigns for the monitoring of PAH and organochlorine pesticides (Vrana *et al.* 2010).
89 Finally, developed since 2008, CFIS (Continuous Integrative Flow Sampler) is a new
90 active (i.e. using a pump) sampler designed for the determination of TWA concentrations
91 of organic compounds in water (Llorca *et al.* 2009). Briefly, CFIS is a fully immersible
92 device consisting of a small peristaltic pump powered by batteries and producing a
93 constant water flow through the glass cell containing a PDMS sorbent. The main
94 advantage of CFIS is that sampling rates are unaffected by water turbulence or velocity
95 and thus, the use of performance reference compounds (PRCs) is not required. It has
96 already been used for the monitoring of PAH and organochlorine pesticides in wastewater
97 treatment plant effluent (Llorca *et al.* 2009).

98 Over the past 20 years, a variety of models has been developed to better describe
99 the transfer kinetics of hydrophobic contaminants into integrative samplers (Booij *et al.*

100 2007). Whatever the integrative sampler and model considered, the calculation of TWA
101 concentrations of contaminants in water from amounts accumulated in the sampler
102 requires the knowledge of sampling rate (R_s) and sampler-water partition coefficient (K_{SW})
103 for each compound. Sampling rates are determined by laboratory calibration under
104 controlled exposure conditions. *In situ* R_s calibration is needed to take into account
105 differences between laboratory vs. *in situ* exposure conditions (i.e. flow velocity, biofouling
106 or temperature); it is achieved by the use of internal surrogates (performance reference
107 compounds, PRCs), spiked in samplers prior to exposure (Huckins *et al.* 2002). K_{SW} can
108 be determined experimentally (Smedes *et al.* 2009 for LDPE and SR) or estimated via
109 empirical relationships as a function of $\log K_{OW}$ (Huckins *et al.* 2006 for SPMD, Vrana *et al.*
110 2006 for Chemcatcher, Booij *et al.* 2003, Adams *et al.* 2007 and Lohmann and Muir 2010
111 for LDPE). Concerning CFIS, that is an “active” sampler, the use of PRC and K_{SW} is not
112 necessary. Indeed, a pump enables to control the water flow during exposure and the
113 temperature effect is known by previous calibration in laboratory (from 5°C to 35°C). By
114 this way, R_s estimated in laboratory for each PCB is corrected according to the average
115 temperature encountered during *in situ* exposure, to be directly used for the determination
116 of TWA concentrations (Llorca *et al.* 2009).

117 Very few intercomparison exercises on integrative samplers have been performed
118 until now. Allan *et al.* (2009) or Miège *et al.* (2012) tested *in situ* the performance of
119 several PSs (including non-polar Chemcatcher, LDPE, membrane enclosed sorptive
120 coating - MESCO, SR and SPMD) for the monitoring of hydrophobic compounds (among
121 PAHs, PCBs or organochlorine pesticides) in the river Meuse (The Netherlands) (Allan *et al.*
122 2009) or the river Rhône (France) (Miège *et al.* 2012) respectively. Although different
123 integrative samplers and methods of calculation were used, relatively consistent TWA
124 concentrations were obtained (variation by a factor up to two). Allan *et al.* (2010)
125 compared under laboratory conditions the performances of six different integrative

126 samplers (non-polar Chemcatcher, SPMD, silicone rod and strip and two modified versions
127 of MESCO), exposed in a flow-through calibration system with Meuse river water spiked
128 with PAHs, PCBs and organochlorine pesticides (concentrations ranging from 20 to 700
129 ng/L). This laboratory experiment only lasting five days showed that the mass of
130 contaminant absorbed normalized to the sampler surface area was comparable if uptake
131 was controlled by diffusion through the water boundary layer.

132 In the context of the ECLIPSE project (2009-2011)¹, we have studied five integrative
133 samplers that well represent the various types used nowadays for PCBs in term of
134 receiving phase and configuration (dimensions, holders): SPMD, SR, LDPE strip,
135 Chemcatcher (apolar version) and CFIS. After PRC spiking or not, samplers were exposed
136 under constant agitation and temperature in water contaminated with 19 indicator and
137 dioxin-like PCBs for periods ranging from one day to three months. A constant PCB
138 concentration of about 1 ng/L was achieved by immersing a large amount of spiked
139 silicone rubber sheets (Rusina *et al.* 2010). Using these five samplers allows comparing
140 different strategies for integrative sampling: passive vs. active (with pump) sampling, use
141 of PRC or not, use of different models and equations to assess TWA concentration. By
142 exposing these five integrative samplers into the same experimental calibration system, a
143 first objective was to compare their performances in accumulating PCBs (uptake,
144 repeatability and linearity). Moreover, since there is no detailed guideline on integrative
145 sampling, a second objective was to compare different methods of calculation of TWA
146 concentrations (models, partition coefficients values and selected PRCs).

147

148 **2. Materials and methods**

149 *2.1. Integrative samplers*

¹ Echantillons Intégratifs pour la mesure de PCB dans la phase dissoute de milieux aqueux, 2009-2011, coord. Irstea (C. Miège), funded by the French Axelera cluster

150 The main characteristics of the studied integrative samplers as well as the PRCs
151 tested and main steps of their processing are summarized in Table 1. Further details on
152 their characteristics, pretreatment and analysis are given in Supplementary data (S1).

153

154 *2.2. Target molecules*

155 The exposure of samplers was performed with 19 PCBs: PCB 18, indicator PCBs
156 (PCB 28, 52, 101, 118, 138, 153 and 180) and dioxin-like PCBs (PCB 77, 81, 105, 114,
157 118, 123, 126, 156, 157, 167, 169 and 189). All these PCBs were purchased from Cil
158 Cluzeau (Courbevoie, France) and delivered in a custom-made solution used to spike the
159 silicone rubber sheets (referred as “dosing sheets“ hereafter).

160

161 *2.3. Exposure device and strategy*

162 The exposure device was custom-made (PIC, Olivet, France) and consisted of a
163 tank (height = 120 cm, diameter = 47 cm), a stirrer and six holders; all these pieces being
164 made of stainless steel to minimize adsorption. A scheme of the exposure device is
165 presented in Supplementary data (S2). The tank was filled with 200 L of tap water agitated
166 with a stirrer (height = 100 cm, width = 18 cm) set in motion by an electronic engine
167 (Heidolph RZR 2102 control Z; VWR, Fontenay-sous-Bois, France). Rotation speed was
168 set at 33 rpm to obtain a water velocity of about 5 cm/sec near the samplers exposed in
169 the tank. To regulate water temperature, the exposure tank was placed in a 300 L
170 polyethylene tank (CVC series, Manutan, Gonesse, France) and water was cooled by an
171 aquarium chiller (Teco TR20, Europrix, Lens, France). The exposure tank contained six
172 holders (height = 100 cm, width = 20 cm) set along the wall. Two holders were used to
173 support the dosing sheets and the four other holders were used to fix four types of
174 integrative samplers: SPMD, SR, LDPE strip and Chemcatcher. Each holder had four

175 positions enabling the simultaneous exposure of four samplers at different depths. CFIS
176 were installed outside the tank but were exposed to the tank water by use of glass tubes.

177 PCBs were dosed to the tank water by immersing a large amount of dosing sheets
178 (Rusina *et al.* 2010). This allowed for maintaining a constant concentration of about 1 ng/L
179 of each studied PCB throughout the experiment. Dosing sheets were first mounted in the
180 exposure device and the tank was filled with tap water. Then, the exposure system was
181 allowed to equilibrate under agitation and temperature regulation during two days, after
182 which water was renewed. This step allowed for cleaning the system and eliminating
183 traces of methanol that might have remained in the dosing sheets from spiking. After
184 another two days of equilibration, samplers were deployed in the tank.

185 Exposures in the water tank lasted up to three months. SPMD, SR and LDPE strips
186 were exposed during 1, 3, 7, 14, 21, 28 (in triplicate), 56 and 91 days. Chemcatcher and
187 CFIS were exposed during 3, 7, 14 (in triplicate), 21, 28 and 56 days. Before and after
188 exposure, samplers were stored at -20°C .

189 Temperature of the tank water was recorded every 6 h over the whole exposure
190 duration. During the first month, water (1 L) was sampled weekly for determination of pH,
191 conductivity and dissolved organic carbon (DOC) concentration. During the last two
192 months, these measurements were performed every two weeks. The concentrations of
193 PCBs in water were calculated from their concentration in dosing sheets (Rusina *et al.*,
194 2010) and using their PDMS – water partition coefficients (Smedes *et al.* 2009). Dosing
195 sheets were sampled every two weeks by cutting six small pieces at different depths in the
196 tank obtaining a total amount of about 1 g of material. Further details about the preparation
197 and analysis of dosing sheets are given in Supplementary data (S1).

198

199 2.4. Quality controls

200 2.4.1 Interlaboratory assay

201 In order to assess the interlaboratory variability in PCB analysis, a standard solution
202 was prepared and sent for analysis by each of the five laboratories involved in this study
203 with its own analytical method. This solution contained the 19 studied PCBs at
204 concentrations ranging from 50 to 130 µg/L and was conditioned in amber glass vials prior
205 to shipment. A good agreement was found between laboratories since the relative
206 standard deviations (RSD) on measured concentrations ranged from 3 to 13 % depending
207 on the congeners.

208

209 *2.4.2. Blank samplers*

210 After their preparation, several samplers were kept as procedural blanks in order to
211 evaluate any possible contamination during fabrication, spiking, storage, processing and
212 analysis. These procedural blanks were stored at -20°C until processing. Other samplers
213 were used as “field” blanks and exposed to the ambient air during the handling of deployed
214 samplers to take account for any possible contamination during deployment and retrieval.
215 These “field” blanks were stored at -20°C until processing. No contamination by PCB was
216 measured in procedural and field blanks.

217 At last, for each type of sampler (except CFIS), a blank sampler (not spiked with
218 PRC) was exposed in the tank during the whole exposure duration in order to assess any
219 possible contamination with PRC between samplers. Only low amounts of rapidly
220 releasing PRC were observed representing less than 4 % of the concentration in these
221 exposed spiked samplers.

222

223 *2.5. Calculations*

224 Several models have been developed to describe the transfer of hydrophobic
225 contaminants into the various available integrative samplers and to calculate the TWA
226 concentrations in water from the accumulated amounts in the samplers (Booij *et al.* 2007).

227 In this work, for SPMD, SR, LDPE strip and Chemcatcher, TWA concentrations of
228 PCBs in water were calculated from the following equation (Huckins *et al.* 2006):

$$229 \quad C_w = \frac{N}{V_s K_{sw} \left(1 - \exp \left(- \frac{R_s t}{V_s K_{sw}} \right) \right)} \quad (1)$$

230 where C_w is the TWA concentration of PCB in water (ng/L), N is the mass of PCB
231 accumulated in sampler (ng), V_s is the volume of sampler (L), K_{sw} is the sampler-water
232 partition coefficient of PCB (L/L), R_s is the sampling rate of PCB (L/day) and t is the
233 exposure duration (day). For SR and LDPE, V_s is replaced by M_s , the mass of sampler
234 (kg), and K_{sw} is expressed in L/kg.

235 For CFIS, TWA concentrations of PCBs were calculated from the following
236 equation, which is a simplification of equation 1 for the sampling during the linear uptake
237 phase (Huckins *et al.* 2006):

$$238 \quad C_w = \frac{N}{R_s t} \quad (2)$$

239 More details on calculations of TWA concentrations of PCBs in water for each
240 sampler are given in Table 2 and Supplementary data (S3).

241

242 3. Results and discussion

243 3.1. Exposure conditions

244 During the three months exposure, water temperature remained constant ($22.6^\circ\text{C} \pm$
245 0.1°C) and pH only slightly varied (7.5 ± 0.2). In contrast, water conductivity slightly
246 decreased from 380 to 310 $\mu\text{S}/\text{cm}$ and DOC concentration showed an increase from
247 around 1.5 to 5 mg/L (Supplementary data, S4). These variations of conductivity and DOC
248 could be explained by the development of biofouling in the tank since no biocide was
249 added. Another possible source of DOC could be the release of the octanol used in the
250 Chemcatchers. The concentrations of the 19 PCBs in dosing sheets remained stable (RSD

251 between 3 and 11 %, n=7) and derived water concentrations ranged from 0.37 ng/L (PCB
252 189) to 3.80 ng/L (PCB 114), with a mean value of 1.29 ng/L. The exposure conditions
253 were therefore considered as constant during the whole experiment.

254

255 3.2. Comparison of uptake curves and PRC candidates

256 To compare the uptake of the five studied integrative samplers, this uptake was
257 normalized to a surface area of 100 cm² (N_A). Plotting N_A versus time showed that the
258 uptake rate (slope) ranged within a factor five as depicted in Figure 1A for PCB 81 (4 Cl
259 atoms), PCB 114 (5 Cl atoms), PCB 138 (6 Cl atoms) and PCB 180 (7 Cl atoms). With
260 exception of PCB 81 (approaching equilibrium for LDPE), the N_A for SPMD and LDPE
261 were quite similar, whereas SR was showing considerable higher uptake than SPMD. This
262 could have been caused by the fact that SPMD and LDPE were both similarly fixed on a
263 spider holder perpendicular to the flow, whereas SR was fixed in parallel with the flow
264 (S2). The overall lower N_A for Chemcatcher is likely connected to the “beaker” shape
265 configuration creating a longer diffusion path between sampler and bulk water. For CFIS,
266 the N_A was not expected to be comparable as this sampler has its own flow regime; but by
267 chance, this N_A was at the same level as that of the passive samplers. Remarkable is that
268 CFIS showed the highest N_A (PCB 138 and 180) as well as the lowest (PCBs 81 and 114).
269 It seems that for CFIS, the N_A for indicator PCBs were markedly higher than for dioxin-like
270 PCBs, a phenomenon that was not observed for the other samplers.

271 Although, the N_A of most PCBs were linear with time for the whole exposure
272 duration; there were some outliers, indicated by (a) in Figure 1. Indeed, the N_A for SPMD
273 exposed for 91 days was similar to that at 56 days, and that even occurred for the most
274 hydrophobic PCBs that could possibly have obtained equilibrium. The low N_A of the
275 SPMD at 91 days exposure however coincides with a reduced release of PRCs, as shown
276 in Figure 1B for PCB 29. It is not clear whether the lower exchange for the SPMD

277 exposed during 91 days is caused by observed biofouling or different mounting position of
278 the spider holder giving a different flow regime. Anyway, these observations underline the
279 importance of PRC application. Figure 1B shows the release curves of some PRC
280 candidates spiked in samplers prior to exposure. PRCs were selected according to the
281 criteria reported in Table 2. The release rates of PRCs were used to calculate the TWA
282 concentrations of PCBs in section 3.4.1.

283 For LDPE strip, PCBs 18, 28 and 52 reached the equilibrium phase of uptake within
284 the 91 days of exposure and PCBs 77, 81 and 101 were in the curvilinear uptake phase,
285 as was PCB 18 in SPMD. With the exception of these less hydrophobic congeners, N_A in
286 LDPE strip, as well as in SR, Chemcatcher and CFIS, increased during the three months
287 of exposure with an overall good linearity. Linear uptake phase durations of all PCBs are
288 given in Supplementary data for SPMD, SR and LDPE strip (S5).

289

290 3.3. Discussion on sampling rates

291 When N_A is divided by $(t \times C_W)$, a R_{SA} ($L \cdot d^{-1} \cdot 100 \text{ cm}^{-2}$) is obtained for the
292 compounds in linear kinetic phase (cf. equation 2). Figure 2 allows comparing the R_{SA} of
293 the different compounds and between the five samplers. It is important to note that R_{SA} for
294 SPMD, SR and LDPE are close with an average RSD of 21 % whereas that value
295 increases to 43 % when data of all samplers are considered. PCBs approaching
296 equilibrium (grey bars) were not included.

297 Figure 2 is based on the 28 days exposures for SPMD, SR and LDPE, and on the
298 14 days exposures for Chemcatcher and CFIS, because these exposures were performed
299 in triplicate and allowed an evaluation of the uptake repeatability (error bars in Figure 2).
300 Overall, repeatability of R_{SA} was very satisfying, with a mean value of RSD (combining all
301 the 19 PCBs) lower than 14 % (9 % for SPMD, 5 % for SR, 7 % for LDPE, 9 % for

302 Chemcatcher and 14 % for CFIS). This variability was only slightly higher than that
303 observed in the dosing sheets over time.

304 Despite the differences in materials (membranes, sequestering phases) and
305 configurations, SPMD, SR, LDPE strip and Chemcatcher exhibited similar patterns of R_{SA}
306 contrary to CFIS. Ignoring the compounds that were approaching equilibrium (PCB 18,
307 PCB 28 and PCB 52), the RSD of the R_{SA} ratios between two samplers (1 ratio per PCB,
308 $n=16$ to 19) can be used as a measurement for agreement between patterns. This
309 revealed that the pattern ratio between SPMD and SR showed a RSD of 10 % (average
310 ratio of 0.7) and excellent agreement. For both SPMD-LDPE and SR-LDPE, the RSD of
311 the pattern ratio was 16 %, with average ratios of 0.9 and 1.2 respectively. This larger
312 RSD for LDPE was due to relatively higher uptakes of PCBs 77, 81, 126 and 169, i.e. of
313 non-ortho substituted PCBs. For SPMD-Chemcatcher and SPMD-CFIS, the pattern
314 agreement was much lower with RSD of 40 % and 50 % and average ratios of 2.1 and 1.2,
315 respectively. For SPMD-Chemcatcher, leaving PCB 189 out reduced the RSD of the
316 pattern ratio to 23 %. The different level of R_{SA} for the CFIS sampler can be explained by
317 the different flow regime in the cell (outside the tank) compared to that inside the tank, but
318 we cannot explain the much higher R_{SA} of the indicator PCBs compared to those of the
319 dioxin-like PCBs. The RSD of pattern ratios for the membrane samplers were consistent
320 and only about a factor two higher than the repeatability of R_{SA} for each triplicate samplers;
321 this indicates that uptake processes of the different compounds were similar for SPMD, SR
322 and LDPE.

323 Between compounds, R_{SA} values were quite scattered (20 to 50 % RSD). To
324 explain this scatter between compounds, the origin of C_W should be considered. The
325 calculation of R_{SA} in the evaluation above was actually done according to:

326

$$R_{SA} = \frac{N_A}{t C_W} = \frac{N_A K_{SW}}{t C_{Dose}} \quad (3)$$

328

329 where C_{Dose} is the concentration in the sheets dosing the water phase. Equation 3 clearly
330 shows that R_{SA} is proportional to K_{SW} and any uncertainty in the K_{SW} is included in C_W and,
331 subsequently in the value of R_{SA} . The K_{SW} has a considerable uncertainty (Difilippo and
332 Eganhouse 2010) and can easily be in the same range as the between compound
333 variation of 32, 31 and 41 % observed for SPMD, SR and LDPE respectively. The K_{SW}
334 uncertainty can also explain why the expected decrease of R_{SA} with increasing
335 hydrophobicity (and M_w) (Booij *et al.* 2003, Huckins *et al.* 2006 Rusina *et al.* 2010) is not
336 visible.

337

338 3.4. Evaluation of TWA concentrations

339 3.4.1. Comparison of TWA concentrations

340 The TWA concentrations of PCBs in water were calculated from PCB uptake and PRC
341 release (except for CFIS) measured for triplicate samplers exposed during 14 days for
342 Chemcatcher and CFIS and during 28 days for SPMD, SR and LDPE strip. The
343 calculations of TWA concentrations were first carried out as indicated by the developer of
344 the sampling system as listed in Table 2 and Supplementary data (S3). For Chemcatcher,
345 the model used for calculations was stated to be only applicable for compounds with
346 $\log K_{OW}$ ranging from 3.7 to 6.8 (Vrana *et al.* 2007) but was applied also for more
347 hydrophobic PCBs. For SPMD, LDPE strip and Chemcatcher, TWA concentrations of
348 PCBs in water were calculated using only PRCs whose dissipation was between 20 and
349 80 % in order to prevent quantification problems due to insignificant release or
350 concentrations close to LOQ. In contrast, all PRCs spiked in SR were used (Booij and
351 Smedes, 2010). PRC-based sampling rates for SPMD, SR and LDPE strip are given in
352 Supplementary data (S6). Required $\log K_{SW}$ for SR and LDPE strip were available in the

353 literature, mostly experimentally determined and modeled for six of the dioxin-like PCBs
354 (Smedes *et al.* 2009). For SPMD and Chemcatcher, $\log K_{SW}$ were determined from
355 empirical relationships as a function of $\log K_{OW}$ (Huckins *et al.* 2006, Vrana *et al.* 2006). For
356 CFIS, with no PRC used, TWA concentrations of indicator PCBs were computed with R_S
357 previously determined in laboratory calibration experiments (Llorca *et al.* 2009). Sampling
358 rates of dioxin-like PCBs were extrapolated from R_S of indicator PCBs having the same
359 number of chlorine atoms.

360 For Chemcatcher, repeatability between triplicate samplers was satisfying (12-22
361 %) but TWA concentrations of PCBs in water were up to 12 times higher than the average
362 of the four other samplers, suggesting that the use of the model (Vrana *et al.* 2006, 2007)
363 for hydrophobic compounds was not applicable for PCBs. Chemcatcher results were
364 therefore not included in the comparison between samplers.

365 Figure 3 shows the ratios of the TWA concentrations of PCBs calculated from the
366 four samplers and the nominal concentrations of PCBs in water derived from
367 concentrations in dosing sheets. Overall, concentrations computed from the four samplers
368 were reasonably close. The highest difference was observed for PCB 153 with a factor of
369 eight between the lowest calculated concentration (0.5 ng/L for LDPE strip) and the
370 highest (4.0 ng/L for CFIS). For SPMD, calculated TWA concentrations of the 19 PCBs
371 were between 0.8 and 2.1 times (average 1.5) the nominal concentrations in water.
372 Repeatability between triplicate samplers was between 8 and 26 % (average 15 %). The
373 same tendency was observed for SR, with calculated TWA concentrations between 1.5
374 and 2.8 times (average of 2.1) higher than the nominal concentrations in water, and with
375 RSD for triplicate samplers between 10 and 27 % (average 18 %). In contrast, for LDPE
376 strip, TWA concentrations were found between 0.4 and 1.2 times (average of 0.7) the
377 nominal concentrations in water with RSD between 7 and 22 % (average 13 %). Finally,
378 for CFIS, TWA concentrations were between 0.5 and 5.0 times (average 1.5) the nominal

379 concentrations in water and RSD between 2 and 80 % (average 21 %). For CFIS, PCBs
380 180 and 153 were mainly responsible for high mean RSD and TWA concentration, as
381 illustrated in Figure 3.

382 In summary, except for Chemcatcher, TWA concentrations of PCBs computed from
383 the different samplers were in agreement with concentrations in water calculated from
384 dosing sheets and good repeatability was found. These results are very satisfying
385 considering that they were obtained from different samplers, processed in different
386 laboratories and obtained with different calculations methods (i.e. different models,
387 different selection criteria of PRCs and $\log K_{SW}$ either experimentally determined or
388 extrapolated from empirical relationship function of $\log K_{OW}$).

389

390 3.4.2. Influence of the data treatment method (PRC and K_{SW}) for SPMD, SR and LDPE 391 strips

392 The method of calculation (the model used, the selection and the use of PRCs, the
393 choice of the partition coefficients) influences the TWA concentration results for a given
394 sampler. In order to observe the influence of these parameters, TWA concentrations for
395 the 28 days exposures were calculated again for SPMD, SR and LDPE with alternative
396 methods.

397 For SPMD, initial $\log K_{SW}$ used in part 3.4.1., obtained from the empirical model of
398 Huckins *et al.* (2006), was replaced by new $\log K_{SW}$ according to Booij and Smedes (2011).
399 For SPMD and LDPE, we also tested to use all the PRCs spiked (see Table 1), following
400 the method of Booij and Smedes (2010). At the opposite, for SR, instead of using all the
401 PRCs, we considered only PRCs whose release after 28 days were between 20 and 80 %;
402 three PRCs (i.e. PCBs 2, 3 and 10) were then retained. TWA concentration from SR were
403 then calculated with PCBs 2, 3 and 10 and were found similar (RSD < 7 %), we only
404 present results obtained with PCB 10 because of a smaller RSD.

405 The ratios of the TWA concentrations on the concentrations of PCBs in water
406 calculated from dosing sheets are illustrated in Figure 4. For SPMD, in spite of using a
407 different relation for $\log K_{SW}$, the differences on TWA concentrations were relatively small
408 (slight decrease with K_{sw} from Booij and Smedes, 2011). Indeed, the relation mainly
409 affects the more hydrophobic PCBs but not the PRCs (low hydrophobic PCBs).
410 Consequently, the sampling rate used to calculate C_w for the more hydrophobic PCBs is
411 slightly affected. Besides, the use of all the PRCs spiked in SPMD, instead of only one,
412 resulted in a very slight increase of TWA concentrations. For SR, the change in PRC used
413 induced a slight decrease of the TWA concentrations. Indeed, by using only one PRC,
414 these concentrations were between 1.1 and 2.1 times higher than the concentrations in
415 water (with an average of 1.6), instead of 2.1 found with all PRCs. For LDPE, the use of all
416 PRCs instead of only one resulted in slight increase of TWA concentrations.

417 Note that the variations in PRC choice above are for illustration. We recommend
418 using all PRCs for R_s estimation as no information is lost and uncertainties in $\log K_{SW}$ of the
419 PRC may be averaged out. However uncertainty in $\log K_{SW}$ remains an issue also for target
420 compounds. Measurement of accurate $\log K_{SW}$ is very difficult, experimental $\log K_{SW}$ values
421 are scarce and can be considerably scattered (Difilippo and Eganhouse, 2010). Models
422 predicting the $\log K_{SW}$ from $\log K_{OW}$ can have typical uncertainties ranging from 0.13-0.36
423 log unit (factor 1.4-2.4) (Booij and Smedes 2010). Moreover, the selection of other $\log K_{OW}$
424 sources than those used for creating the predictive relations, may contribute to further
425 variability. Considering the above, the results reported here for the three membrane
426 samplers with a general variation of about a factor two are very satisfying, as they were
427 based on $\log K_{SW}$ either experimentally determined or from an empirical relationship with
428 $\log K_{OW}$, different calculations models, different selection criteria of PRCs, and obtained
429 from different samplers, processed in different laboratories.

430

431 **4. Conclusions**

432 The designed calibration system for the simultaneous exposure of the five
433 integrative samplers enabled to maintain sufficiently constant exposure conditions up to
434 three months and PCB uptake in samplers showed overall good linearity with time and
435 repeatability. The three membrane samplers (SR, LDPE and SPMD) are efficient to
436 accumulate large amounts of PCBs and have great potential for low LOQ when used in
437 water monitoring programs. TWA concentrations of PCBs in water calculated from the
438 different samplers were in good agreement, except for Chemcatcher whose model for
439 hydrophobic compounds (Vrana *et al.*, 2006, 2007) was not proven to be suitable for PCBs
440 in this study. For the four other samplers, despite the variety of materials, geometries and
441 calculation methods, TWA concentrations were generally between 0.5 and 3 times the
442 nominal water concentrations calculated from dosing sheets, which is quite satisfying in
443 the domain of ultra-trace (ng/L level) micropollutants analysis in aquatic environments.

444 At last, it must be underlined that TWA concentrations in water can be calculated
445 through the use of various models, PRCs and $\log K_{SW}$ values. For the transfer of these
446 sampling tools to water basin managers, it is therefore of crucial importance that protocols
447 detail the calculation methods. Moreover, any results on TWA concentration (from the
448 literature or *in situ* monitoring programs) should be accompanied with detailed information
449 on calculation method used (i.e. model and equations, PRCs and $\log K_{SW}$ values).

450 Intercomparison exercises on sampling and processing, but also the determination
451 of partition coefficients K_{SW} , should enable to progress on the knowledge and
452 harmonization of practices for the use of integrative sampling, especially for priority
453 chemical monitoring and regulatory programs in compliance with the Water Framework
454 Directive and the Marine Strategy Framework Directive. To be noted that the challenge of
455 PRC strategy is even more crucial for integrative samplers used for hydrophilic
456 compounds (i.e. POCIS, polar Chemcatcher, ...), since very few PRC candidates have

457 been found up to date. Further outputs of the ECLIPSE project should follow dealing on
458 the application and comparison of these five integrative samplers *in situ*.

459

460 **Acknowledgments**

461 The ECLIPSE project is part of the French PCB Axelera project, supported by the
462 “Chemistry and environment French competitive” cluster
463 from Lyon and Rhône-Alpes (<http://www.axelera.org/en/>). We thank Nadège Bely
464 (IFREMER) and Henry Beeltje (TNO - Organisation for Applied Scientific Research, The
465 Netherlands) for technical assistance. The authors thank an unknown reviewer for his
466 constructive comments which helped us to significantly improve the quality of this paper.

467

468 **Supplementary data**

469 Supplementary data associated with this article can be found in the online version.

470

471 **References**

472 Adams, R.G., Lohmann, R., Fernandez, L.A., Macfarlane, J.K., Gschwend, P.M., 2007.
473 Polyethylene devices: passive samplers for measuring dissolved hydrophobic organic
474 compounds in aquatic environments. *Environ. Sci. Technol.* 41, 1317-1323.

475

476 Allan, I.J., Booij, K., Paschke, A., Vrana, B., Mills, G.A., Greenwood, R., 2009. Field
477 performance of seven passive sampling devices for monitoring of hydrophobic substances.
478 *Environ. Sci. Technol.* 43, 5383-5390.

479

480 Allan, I.J., Booij, K., Paschke, A., Vrana, B., Mills, G.A., Greenwood, R., 2010. Short-term
481 exposure testing of six different passive samplers for the monitoring of hydrophobic
482 contaminants in water. *J. Environ. Monit.* 12, 696-703.

483

484 Anderson, K.A., Sethajintanin, D., Sower, G., Quarles, L., 2008. Field trial and modeling of
485 uptake rates of *in situ* lipid-free polyethylene membrane passive sampler. Environ. Sci.
486 Technol. 42, 4486-4493.

487

488 Booij, K., Hofmans, H.E., Fischer, C.V., van Weerlee, E.M., 2003. Temperature dependent
489 uptake rates of non-polar organic compounds by semi-permeable membrane devices and
490 low-density polyethylene membranes. Environ. Sci. Technol. 37, 361-366.

491

492 Booij, K., Vrana, B., Huckins, J.N., 2007. Theory, modeling and calibration of passive
493 samplers used in water monitoring, in: Greenwood, R., Mills, G., Vrana, B. (Eds), Passive
494 sampling techniques in environmental monitoring, Elsevier, Amsterdam, pp. 141-169.

495

496 Booij, K, Smedes, F, 2010. An Improved Method for Estimating *in Situ* Sampling Rates of
497 Nonpolar Passive Samplers. Environ. Sci. Technol. 44(17), 6789-6794

498

499 Booij, K, Smedes, F, 2011. Correction to An Improved Method for Estimating *in Situ*
500 Sampling Rates of Nonpolar Passive Samplers. Environ. Sci. Technol. 45, 10288-10288

501 Carls, M.G., Holland, L.G., Short, J.W., Heintz, R.A., Rice, S.D., 2004. Monitoring
502 polynuclear aromatic hydrocarbons in aqueous environments with passive low-density
503 polyethylene membrane devices. Environ. Toxicol. Chem. 23, 1416-1424.

504

505 Carpenter, D.O., 2006. Polychlorinated biphenyls (PCBs): Routes of exposure and effects
506 on human health. Rev. Environ. Health 21, 1-23.

507

508 Difilippo, E.L., Eganhouse, R.P., 2010. Assessment of PDMS-water partition coefficients:
509 Implications for passive environmental sampling of hydrophobic organic compounds.
510 Environ. Sci. Technol. 44, 6917-6925.

511

512 Greenwood, R., Mills, G.A., Vrana, B., Allan, I.J., Aguilar-Martinez, R., Morrison, G., 2007.
513 Monitoring of priority pollutants in water using Chemcatcher passive sampling devices, in:
514 Greenwood, R., Mills, G., Vrana, B. (Eds), Passive sampling techniques in environmental
515 monitoring, Elsevier, Amsterdam, pp. 199-229.

516

517 Greenwood R., Mills G.A., Vrana B., 2009. Potential applications of passive sampling for
518 monitoring non-polar industrial pollutants in the aqueous environment in support of
519 REACH. J. Chrom. A, 1216, 631-639.

520

521 Huckins, J.N., Petty, J.D., Lebo, J.A., Fernanda, V.A., Booij, K., Alvarez, D.A., Cranor,
522 W.L., Clark, R.C., Mogensen, B.B., 2002. Development of the permeability/performance
523 reference compound approach for *in situ* calibration of semi-permeable membrane
524 devices. Environ. Sci. Technol. 36, 85-91.

525

526 Huckins, J.N., Petty, J.D., Booij, K., 2006. Monitors of organic chemicals in the
527 environment. Springer, New-York.

528

529

530 Kingston, J.K., Greenwood, R., Mills, G.A., Morrison, G.M., Persson, B.L., 2000.
531 Development of a novel passive sampling system for the time-averaged measurement of a
532 range of organic pollutants in aquatic environments. J. Environ. Monit. 2, 487-495.

533

534 Lohmann, R., Booij, K., Smedes, F., Vrana, B., 2012. Use of passive sampling devices for
535 monitoring and compliance checking of POP concentrations in water: Environ. Sci. Pollut.
536 Res. 19, 1885-1895.

537

- 538 Lohmann, R., Muir, D., 2010. Global Aquatic Passive Sampling (AQUAGAPS): using
539 passive samplers to monitor POPs in the waters of the world. *Environ. Sci. Technol.* 44,
540 860–864.
- 541
- 542 Llorca, J., Gutiérrez, C., Capilla, E., Tortajada, R., Sanjuán, L., Fuentes, A., Valor, I., 2009.
543 Constantly stirred sorbent and continuous flow integrative sampler. New integrative
544 samplers for the time weighted average water monitoring. *J. Chromatogr. A* 1216, 5783–
545 5792.
- 546
- 547 Miège, C., Mazzella, N., Schiavone, S., Dabrin, A., Berho, C., Ghestem, J.-P., Gonzalez,
548 C., Gonzalez, J.-L., Lalere, B., Lardy-Fontan, S., Lepot, B., Munaron, D., Tixier, C.,
549 Togola, A., Coquery M. 2012. An in situ intercomparison exercise on passive samplers for
550 monitoring metals, polycyclic aromatic hydrocarbons and pesticides in surface waters.
551 *Trends in Analytical Chemistry*, 36, 128-143.
- 552
- 553 Rusina, T.P., Smedes, F., Klanova, J., Booij, K., Holoubek, I., 2007. Polymer selection for
554 passive sampling: a comparison of critical properties. *Chemosphere* 68, 1344–1351.
- 555
- 556 Rusina, T.P., Smedes, F., Koblizkova, M., Klanova, J., 2010. Calibration of silicone rubber
557 passive samplers: experimental and modeled relations between sampling rate and
558 compound properties. *Environ. Sci. Technol.* 44, 362-367.
- 559
- 560 Smedes, F., 2007. Monitoring of chlorinated biphenyls and polycyclic aromatic
561 hydrocarbons by passive sampling in concert with deployed mussels, in: Greenwood, R.,
562 Mills, G., Vrana, B. (Eds), *Passive sampling techniques in environmental monitoring*.
563 Elsevier, Amsterdam, pp. 407-448.

564

565 Smedes, F., Geertsma, R.W., Van der Zande, T., Booij, K., 2009. Polymer-water partition
566 coefficients of hydrophobic compounds for passive sampling: application of cosolvent
567 models for validation. *Environ. Sci. Technol.* 43, 7047–7054.

568

569 Söderström, H., Lindberg R.H., Fick J., 2009. Strategies for monitoring the emerging polar
570 organic contaminants in water with emphasis on integrative passive sampling. *J. Chrom.*
571 *A*, 1216, 623-630.

572

573 Vrana, B., Mills, G.A., Greenwood, R., Knutsson, J., Svenssone, K., Morrison, G., 2005.
574 Performance optimisation of a passive sampler for monitoring hydrophobic organic
575 pollutants in water. *J. Environ. Monit.* 7, 612-620.

576

577 Vrana, B., Mills, G.A., Dominiak, E., Greenwood, R., 2006. Calibration of the Chemcatcher
578 passive sampler for the monitoring of priority organic pollutants in water. *Environ. Pollut.*
579 142, 333-343.

580

581 Vrana, B., Mills, G.A., Kotterman, M., Leonards, P., Booij, K., Greenwood, R., 2007.
582 Modelling and field application of the Chemcatcher passive sampler calibration data for the
583 monitoring of hydrophobic organic pollutants in water. *Environ. Pollut.* 145, 895-904.

584

585 Vrana, B., Mills, G.A., Leonards, P.E.G., Kotterman, M., Weideborg, M., Hajslova, J.,
586 Kocourek, V., Tomaniova, M., Pulkrabova, J., Suchanova, M., Hajkova, K., Herve, S.,
587 Ahkola, H., Greenwood, R., 2010. Field performance of the Chemcatcher passive sampler
588 for monitoring hydrophobic organic pollutants in surface water. *J. Environ. Monit.* 12, 863-
589 872.

590

591 **Figures**

592 **Fig. 1.** Surface area normalized uptake (N_A) plotted versus time (panel A) for PCB 81 (4 Cl
593 atoms), PCB 114 (5 Cl atoms), PCB 138 (6 Cl atoms) and PCB 180 (7 Cl atoms) in the five
594 integrative samplers. Uptake was normalized to a membrane surface area of 100 cm².
595 Panel B shows release curves of some selected PRCs.

596 (a) data not used for curve fitting

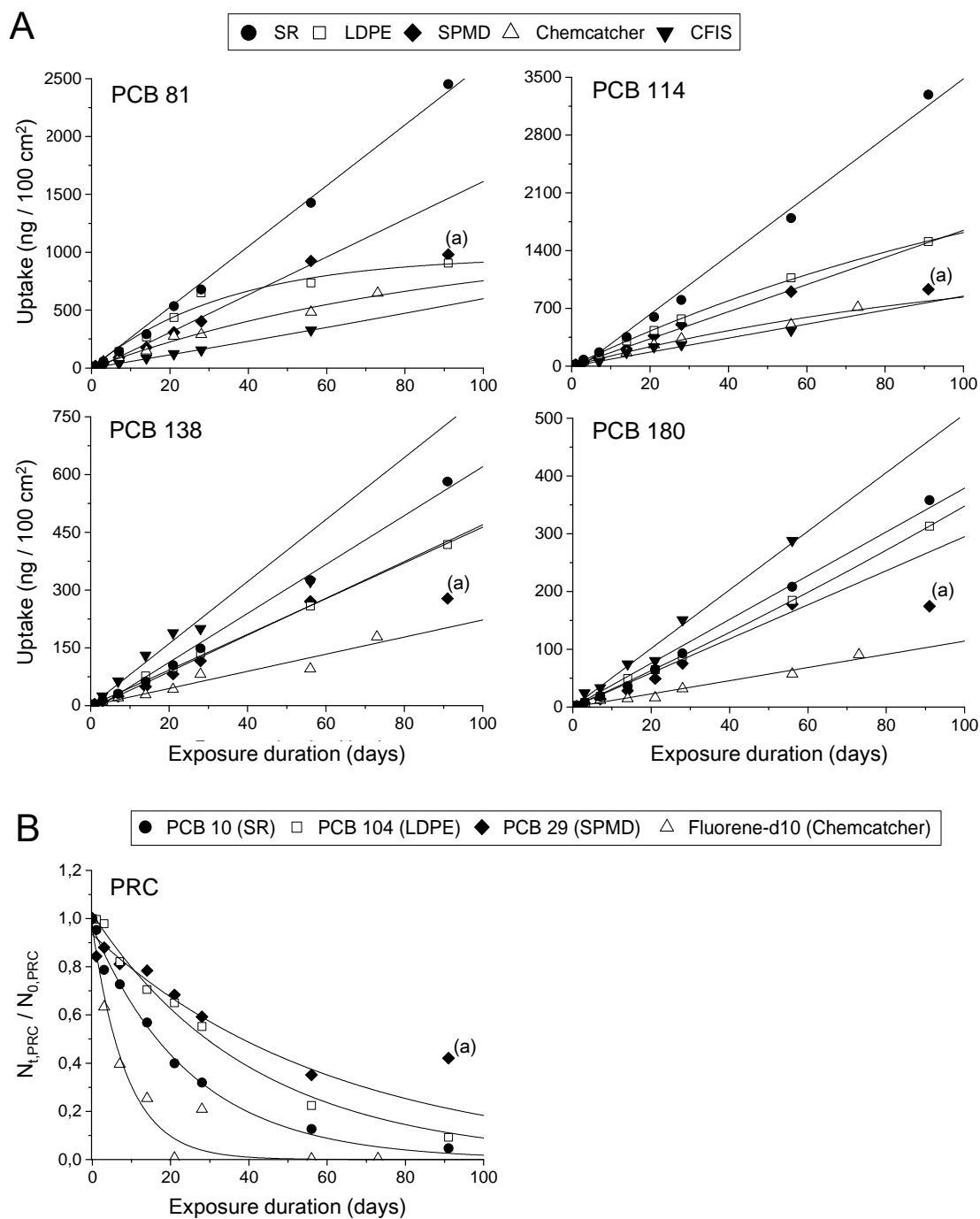

597

598

599 **Fig. 2.** Surface area normalized sampling rates (R_{SA} , $L \cdot d^{-1} \cdot 100 \text{ cm}^{-2}$) of PCBs in the five
 600 integrative samplers. Error bars represent the standard deviations ($n=3$). R_{SA} was
 601 normalized to a membrane surface area of 100 cm^2 . PCB congeners are on the x-axis.
 602 PCBs approaching equilibrium are represented with grey bars.
 603 PCB 157 could not be quantified in SPMD because of co-eluting peaks (ND).
 604
 605

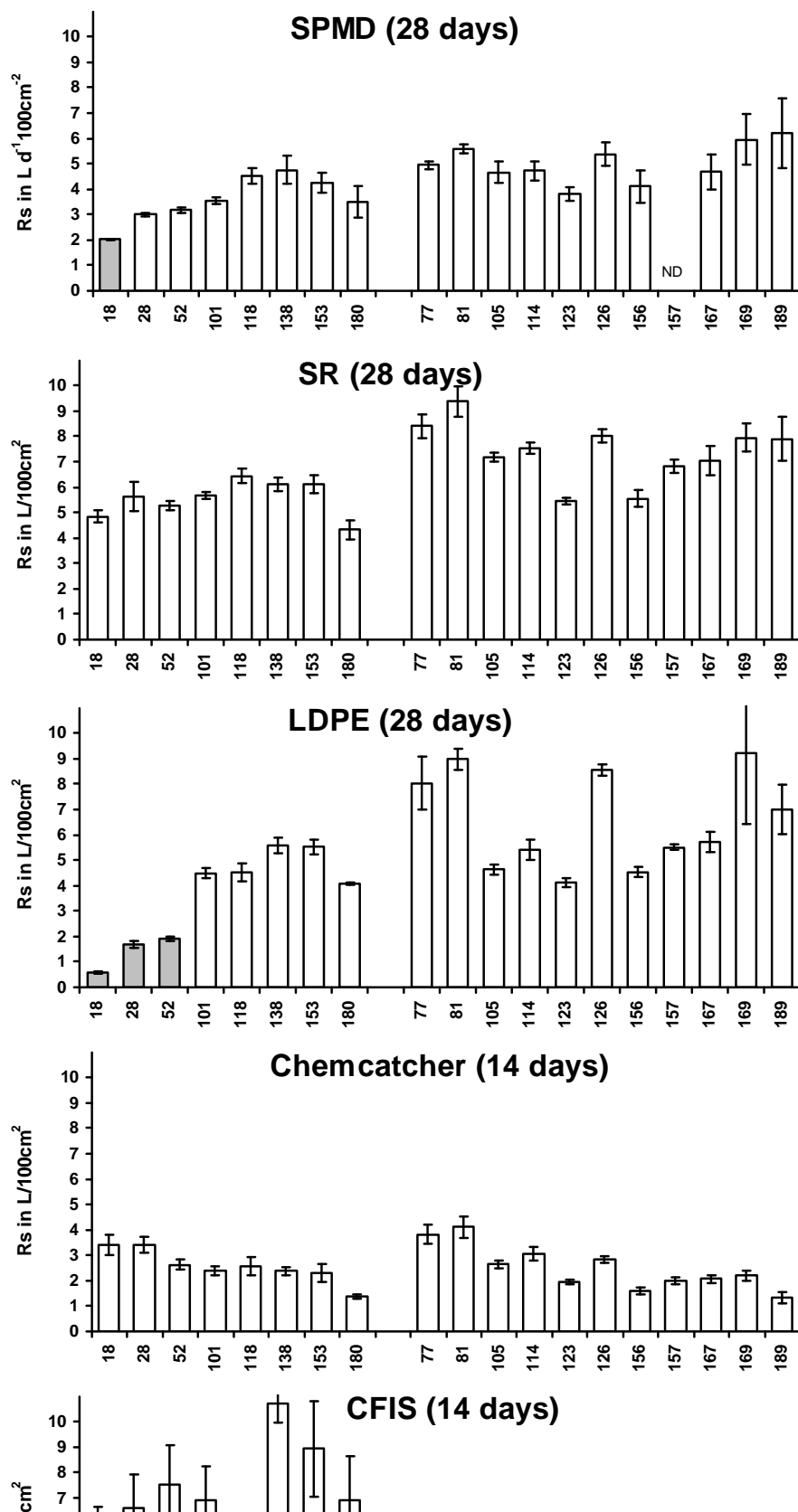

606 **Fig. 3.** Ratios of the time-weighted average (TWA) concentrations of PCBs calculated from
607 integrative samplers on the PCB water concentrations calculated from dosing sheets. The
608 TWA concentrations were calculated as indicated in Table 2. PCB congeners are on the x-
609 axis.

610

611

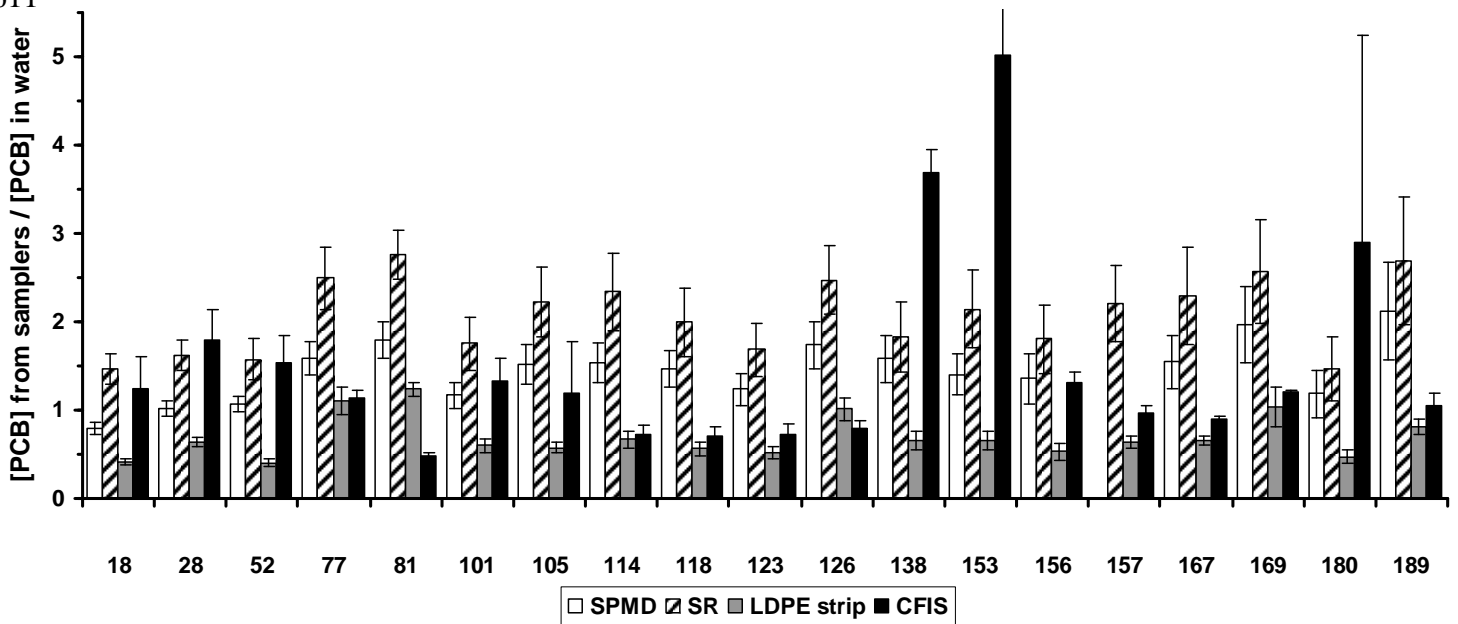

612 **Fig. 4.** Ratios of the time-weighted average (TWA) concentrations of PCBs calculated from
 613 integrative samplers on the concentrations of PCBs in water. The TWA concentrations
 614 were calculated as indicated in Table 2 (reference method) and by changing SPMD-water
 615 partition coefficient values (for SPMD) and selection criteria of PRCs (for SPMD, SR and
 616 LDPE strip). PCB congeners are on the x-axis.
 617 ND: not determined (PCB 157 could not be quantified in SPMD because of co-eluting peaks).

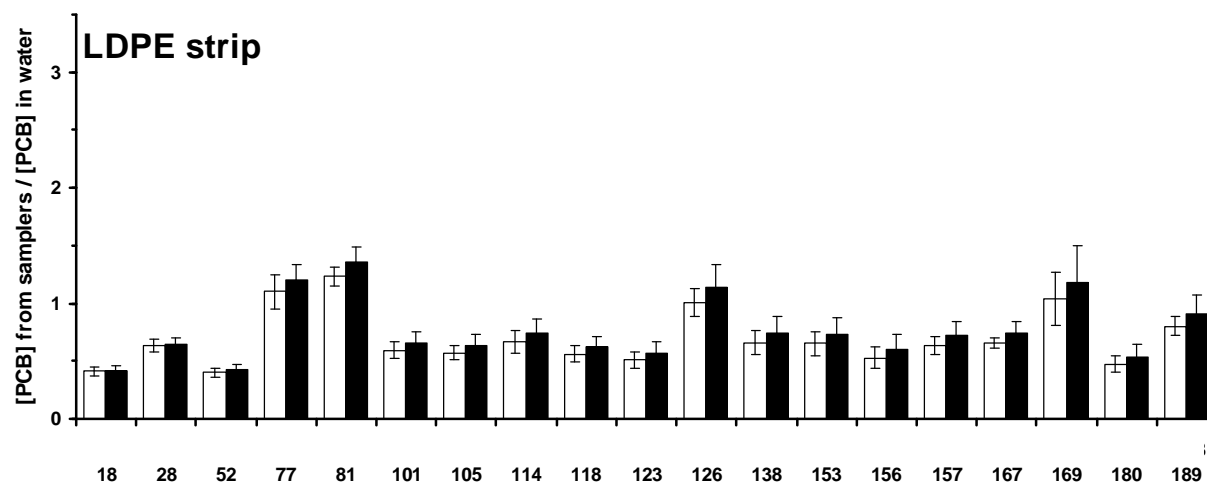
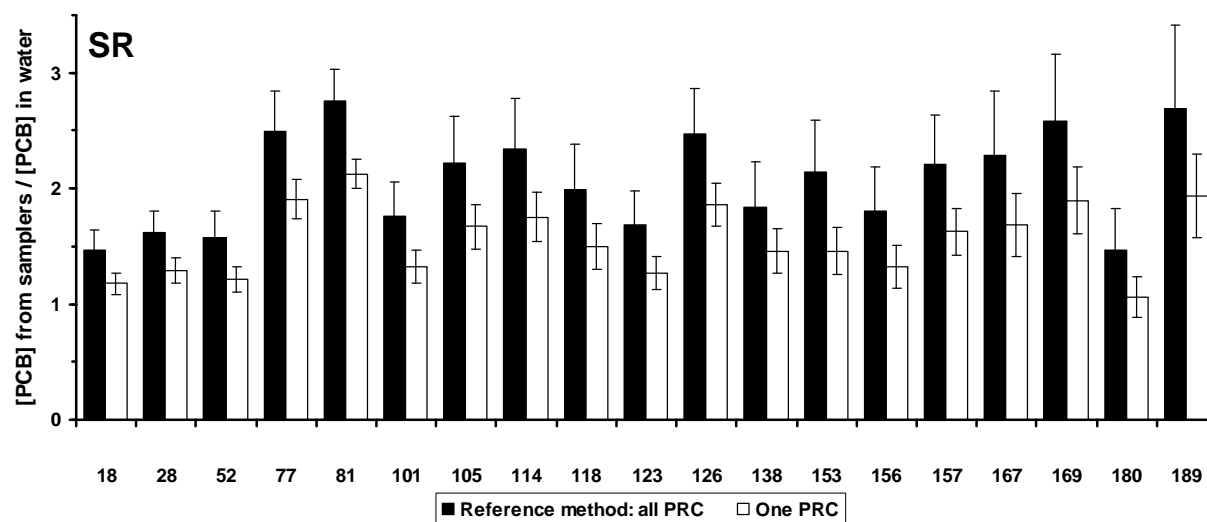
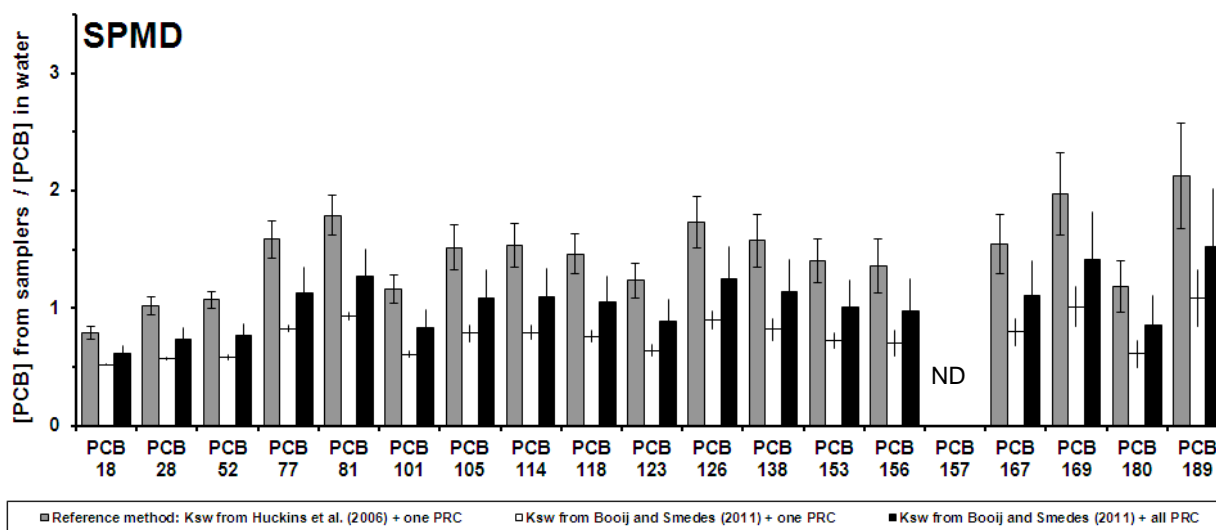

620 **Table 1.** Main characteristics and processing steps of the five integrative samplers

	SPMD ^a	SR ^b	LDPE strip ^c	Chemcatcher ^d	CFIS ^e
Suppliers	Exposmeter	Altec Products Limited	Brentwood plastics	University of Portsmouth	LABAQUA
Receiving phase (membrane ^f , solid or liquid phase)	LDPE + Triolein	PDMS	LDPE	LDPE + C18 Empore disk + 450 µL of n-octanol	PDMS
Surface area (cm ²)	457	138	100	17	8
Weight (g)	4.5	4.1	0.39	0.62	0.144
Total volume (cm ³)	4.95	3.4	0.425	0.6	0.147
PRC spiking method	Syringe injection of isooctane solution	Soaking in water / methanol solutions	Soaking in water / methanol solutions	Percolation of aqueous solution	No PRC
PRC ^g	PCB 3, 10, 14, 29, 37, 55, 78, 104, 155, 166, 201, 204	Bip-d10, PCB 1, 2, 3, 10, 14, 21, 30, 50, 55, 78, 104, 145, 204	PCB 10, 14, 29, 104, 112, 204	Bip-d10, Ace-d10, Flu-d10, Phe-d10, Pyr-d10, B[a]a-d12	/
Extraction	Dialysis in cyclohexane	Soxhlet with methanol	Soaking in cyclohexane	Ultrasonic bath in acetone and ethyl acetate / isooctane	Thermodesorption
Analytical surrogate	PCB 34, 119, 141, 209	¹³ C labeled indicator PCB, PCB 143	PCB 30, 198, 209, TCN ^h	None	Flu-d10, Chry-d12
Purification	Florisil	None	Silica and alumina	None	None
Analytical technique	GC-ECD	GC-MS	GC-ECD for PCB _i GC-HRMS for PCB _{dl}	GC-MS	GC-MS
Chromatographic column	Restek RTX-PCB and RTX-5	Alltech AT-5MS	Agilent DB-5 and SGE HT8 for PCB _i SGE HT8 for PCB _{dl}	Varian CP-Sil 8 CB	Teknokroma TRB-5ms

^a SPMD: semipermeable membrane device, membrane length = 91.4 cm, width = 2.5 cm, thickness = 70-95 µm ; triolein volume = 1 ml, weight = 0.915 g.

^b SR: silicone rubber, length = 12.5 cm, width = 5.5 cm, thickness = 500 μm .

^c LDPE strip: low-density polyethylene strip, length = 20 cm, width = 2.5 cm, thickness = 80 μm .

^d Chemcatcher: non-polar version, membrane diameter = 4.7 cm, thickness = 40 μm ; C18 Empore disk diameter = 4.7 cm, volume = 0.6 mL (i.e. 0.45 mL octanol + 0.15 mL C18).

^e CFIS: continuous flow integrative sampler, 90 PDMS pieces with length = 2 mm, width = 2 mm, thickness = 400 μm or 3 Twisters® with length = 2 cm, diameter = 2 mm.

^f LDPE: low density polyethylene, PDMS: polydimethylsiloxane.

^g PRCs: performance reference compounds, Bip: biphenyl, Ace: acenaphthene, Flu: fluorene, Phe: phenanthrene, Pyr: pyrene, B[a]a: benzo[a]anthracene.

^h TCN: 1,2,3,4-tetrachloronaphthalene

621 **Table 2.** Strategies (models, criteria to select PRCs and methods to evaluate $\log K_{SW}$)
 622 used for the calculation of TWA concentrations of PCBs in water for each integrative
 623 sampler.

	Model	Criteria to select PRC	Methods to evaluate $\log K_{SW}$
SPMD	Huckins et al. 2006 (water boundary layer - controlled uptake model)	PCB, used when dissipation was between 20% and 80%	empirical relationship function of $\log K_{OW}$ [Huckins et al. 2006]
SR	Rusina et al. 2010 (water boundary layer - controlled uptake model)	PCB, all used with unweighted nonlinear least-squares regression [Booij and Smedes 2010]	measured and modeled [Smedes et al. 2009]
LDPE strip	Huckins et al. 2006 (water boundary layer - controlled uptake model)	PCB, used when dissipation was between 20% and 80%	measured and modeled [Smedes et al. 2009]
Chemcatcher	Vrana et al. 2007 (applicable for compounds with $3.7 < \log K_{OW} < 6.8$)	PAH, used when dissipation was between 20% and 95%	empirical relationship function of $\log K_{OW}$ [Vrana et al. 2006]
CFIS	none, use of predetermined R_S for PCB_i and extrapolated R_S for PCB_{dl}	none, not required	none, not required

624

625

626

627

628 **Supplementary data** (available online)

629 S1. Additional information about materials and methods

630 S2. Scheme of the exposure device

631 S3. Detailed calculations of TWA concentrations of PCBs in water

632 S4. Results of the physicochemical analysis of water sampled during exposure

633 S5. PRC-based linear uptake phase durations of PCBs

634 S6. PRC-based sampling rates of PCBs

635

636

637 S1. Additional information about materials and methods

638

639 S1.1. SPMD

640 SPMD were purchased from Exposmeter (Tavelsjö, Sweden) and had the
641 standard configuration, as defined by Huckins et al. (2006): an area-to-volume ratio
642 of about 460 cm²/ml of triolein (purity ≥ 95%), an approximate lipid-to-membrane
643 mass ratio of 0.25 and a 70-95 µm wall thickness.

644 Prior to their exposure, SPMD were spiked with several PRC (Table 1). The
645 membrane was perforated at one end and 25 µl of isooctane containing 4 mg/L of
646 each PRC was injected with a 50 µl syringe. Membrane was then heat-sealed and
647 SPMD were stored in air tight cans at -20°C until exposure.

648 After exposure and retrieval, SPMD were stored in air tight cans at -20°C until
649 processing. Prior to extraction, mounting loops were cut and SPMD membranes were
650 cleaned with Milli-Q water, wiped with paper and measured to determine their exact
651 surface area. Recovery of accumulated PCBs was carried out by dialysis in 125 ml of
652 cyclohexane at 15°C during 24h in darkness. This operation was repeated one time.
653 Dialysis was performed at 15°C in order to reduce the amount of co-extracted
654 material (Meadows et al. 1993). Both dialysates were combined and after addition of
655 internal surrogates (100 ng of PCBs 34, 119, 141 and 209), the solvent was
656 evaporated to 1 ml. Then, extracts were diluted (100 µl completed to 1 ml with
657 cyclohexane) and purified on disposable Florisil cartridges (6 ml, 1 g) conditioned
658 with 10 ml of cyclohexane. Extracts were loaded on the cartridges and allowed to
659 soak during 5 min after which elution was performed with 10 ml of
660 cyclohexane/methylene chloride 95/5 (v/v). After evaporation under nitrogen with 10
661 µl of n-dodecane, used as keeper, extracts were reconstituted in 1 ml of isooctane

662 containing 10 µg/L of 2,4,5,6-tetrachloro-m-xylene (TCX) and octachloronaphtalene
663 (OCN), used as internal standards.

664 Analysis of SPMD extracts were performed with a Varian (Les Ulis, France)
665 3800 GC-ECD using two chromatographic columns purchased from Restek (Lisses,
666 France), a RTX-PCB column (30 m x 0.25 mm x 0.25 µm) and a RTX-5 column (30
667 m x 0.25 mm x 0.25 µm). Both columns were equipped with 10 m of uncoated guard-
668 columns. PCB 157 could not be quantified because of co-eluting peaks on both
669 columns. All results were corrected for recovery of internal surrogates.

670

671 *S1.2. Silicone rubber (SR)*

672 Silicone rubber sheets of 60 x 60 cm and 0.5 mm thickness were purchased
673 from Altec Products Limited (Cornwall, UK). From this large sheets sampler were
674 prepared by cutting them at a size of 12.5x5.5 cm and were soxhlet extracted with
675 ethylacetate for 100 h prior to use.

676 To measure of the exchange rate through the release of PRC, 27 exposure
677 sheets were spiked with PRC (Table 1). Spiking was done by soaking the sheets in
678 methanol containing the PRC and followed by adding portions of water to gradually
679 increase the water content (Smedes and Booij, 2012). The procedure is similar to
680 that for the dosing sheets, but starting with 300 ml of methanol. Time periods and
681 methanol percentages were equal to the procedure described for dosing sheets
682 (S1.6). After spiking, the sheets were washed with Milli-Q water, individually packed
683 in diffusion closed glass jars numbered from 1 to 27 and stored at -20°C when not
684 exposed in the tank. After thawing, sheets were carefully wiped dry with a tissue
685 before exposure.

686 Prior to analysis of the bulk samples, a one day exposure sheet was analyzed
687 to allow estimation of appropriate dilutions ensuring later extracts to fit the calibration
688 curve. Prior to extraction, each sheet was spiked with internal surrogates: 1000 ng of
689 PCB 143 and up to 28 days exposure, 10 ng of ¹³C labeled indicator PCB were
690 added. One and three days exposures, that were performed four and two times,
691 respectively, were considered as single exposures and extracted together. Exposed
692 and unexposed sheets were soxhlet extracted by 120 ml of methanol for 16 hours.
693 Extracts were Kuderna-Danish evaporated until 2 ml and 20 ml of hexane were
694 added. By Kuderna-Danish evaporation, the methanol was azeotropically removed
695 and consequently the extract was transferred to hexane. Hexane extracts were
696 further concentrated to 1 ml using a gentle stream of nitrogen for short exposures
697 and gradually diluted for longer exposures, up to 15 ml of hexane for a 90 d
698 exposure. To each extract TCN was added to obtain a concentration at 100 ng/ml.

699 Extracts were analysed on an Agilent (Palo Alto, CA, USA) HP 6890 Series
700 GC-MS with an Agilent HP 5973N mass selective detector. The column was an
701 Alltech AT-5MS (30 m x 0.25 mm x 0.25 µm) from Grace (Deerfield, IL, USA).
702 Selected Ion Monitoring (SIM) mode was applied for quantification using appropriate
703 masses and two masses were monitored for each PCB. All calculations were done
704 based on TCN as an internal standard.

705

706 *S1.3. LDPE strips*

707 LDPE strips were prepared from additive-free LDPE lay-flat tubing purchased
708 from Brentwood plastics (MO, USA). Single layered strips were obtained by cutting
709 sections of the tubing twice along the side edges. A mounting loop was prepared at
710 each extremity of the strips and removed before the whole analytical treatment.

711 Prior to use, LDPE strips were pre-extracted twice by soaking in cyclohexane
712 overnight and then spiked with six PRC (Table 1) following the method described by
713 Booij et al. (2002). Briefly, LDPE strips were soaked overnight in a PRC solution in
714 methanol/water 80/20 (v/v). Spiked strips were stored at -20°C until exposure.

715 After exposure, LDPE strips were kept in the dark at -20°C until further
716 treatment. The mounting loops were removed and strips were rinsed with Milli-Q
717 water. Strips were then extracted twice by soaking overnight in cyclohexane.
718 Surrogate standards (PCBs 30, 198, 209 and TCN) were spiked into cyclohexane at
719 the beginning of the extraction. After extraction, strips were removed from
720 cyclohexane and allowed to dry for weight determination. The combined cyclohexane
721 extract was concentrated to 4 ml and an aliquot of 200µl was taken for dioxin-like
722 PCB analysis. The exact volume was controlled gravimetrically by weighting both
723 extracts. The analytical protocols for cleanup and analysis of indicator PCBs and
724 PRCs have been described previously (Johansson et al. 2006). Briefly, the clean-up
725 and fractionation of all extracts were made by adsorption chromatography on a two
726 layer silica/alumina column. The first fraction eluted with hexane was analysed for
727 PCB by GC-ECD according to the procedure described earlier (Johansson et al.
728 2006). For dioxin-like PCB analysis, separation of coplanar (non-ortho) PCB from
729 non-planar PCB was achieved on an activated mixture of Florisil/Carbopack C/Celite
730 545.

731 Analysis of LDPE extracts for indicator PCBs were performed with a Varian
732 (Les Ulis, France) 3800 GC fitted with two electron capture detector and two columns
733 of different polarities: a DB-5 column (60 m x 0.25 mm x 0.25 µm) from Agilent (Palo
734 Alto, CA, USA) and a HT8 column (50 m x 0.25 mm x 0.25 µm) from SGE Europe Ltd
735 (Milton Keynes, UK). All PCB congeners were quantified on both columns and the

736 reported result was chosen for each non-coeluting congener on the appropriate
737 column. Dioxin-like PCB analysis were conducted at LABERCA laboratory (Nantes,
738 France) according the method of Costera et al. (2006). Separation of coplanar (non-
739 ortho) PCBs from non-planar PCBs was achieved on an activated mixture of
740 Florisil/Carbopack C/Celite 545. Analyses were performed by GC-HRMS (gas
741 chromatograph (HP-7890) from Hewlett Packard -Palo Alto, CA, USA; mass
742 spectrometer (JMS-800D) from Jeol - Japan) equipped with a a HT8-PCB capillary
743 column (60 m x 0.25 mm x 0.25 μ m) from SGE Analytical Science (Australia).

744

745 *S1.4. Chemcatcher*

746 Chemcatchers were purchased from the University of Portsmouth and were
747 prepared according to their own protocol (University of Portsmouth, 2009).

748 Before use, C18 Empore disks were soaked in methanol overnight in a clean
749 glass beaker. Then, they were placed on a 47 mm diameter disk vacuum manifold
750 platform and 50 ml of methanol were slowly passed through the disks, followed by
751 150 ml of ultrapure water. Then 250 ml of water spiked with 300 μ l of PRC (Table 1)
752 standard solution at 2 μ g/ml in methanol was filtered through the disks. The Empore
753 disks were then dried under vacuum during 30 min and put on the sampler PTFE
754 supports. Then, 1 ml of 45% (v/v) n-octanol in methanol was applied evenly to the
755 surface of each C18 Empore disk. The resulting volume of n-octanol was 450 μ l. The
756 LDPE membranes (pre-cleaned by soaking in n-hexane during 24h and dried) were
757 put on the top and any air bubbles were smoothed away from between the two layers
758 by gently pressing the top surface of the membrane using a clean paper tissue. The
759 PTFE supporting disks were placed in the sampler bodies and fixed in place to form

760 a watertight seal between the membrane and the top section of the sampler (Vrana
761 et al. 2005; Vrana et al. 2006). Chemcatchers were stored at -20°C until exposure.

762 After exposure, samplers were rinsed with ultrapure water, carefully
763 disassembled and LDPE membranes were removed and rinsed with acetone. PCBs
764 were extracted from the Empore disks with 5 min of ultrasonic bath in acetone
765 followed by 5 min in ethyl acetate/2,2,4-trimethylpentane 50/50 (v/v). The disks were
766 then removed and the solvent extracts, combined with the LDPE membrane rinsates,
767 were filtered through a drying cartridge containing sodium sulfate. Extracts were
768 reduced under nitrogen at 450 µl and transferred to 2 ml vials prior to analysis with a
769 solution of chrysene-d12 (internal standard) in n-octanol. The final volume was
770 adjusted to 500 µl with n-octanol (University of Portsmouth, 2009; Vrana et al. 2005).

771 Sampler extracts were analysed with a Varian (Les Ulis, France) 240 GC-
772 MS/MS system using a Varian CP-SIL 8 CB (50 m x 0.25 mm x 0.25 µm) capillary
773 column equipped with a guard-column.

774

775 *S1.5. CFIS*

776 The CFIS device was developed by Labaqua and was prepared with PDMS
777 pieces or PDMS in Twister[®] format from Gerstel (Mülheim an der Ruhr, Germany).
778 The PDMS pieces were obtained by cutting a PDMS tubing in pieces of 2 x 2 mm.
779 Every device contains 90 PDMS pieces or 3 Twisters[®]. Prior to use, Twisters[®] were
780 conditioned in an empty thermodesorption tube at 300°C for 4 h with an helium flow
781 of 75 ml/min.

782 After exposure, the Twisters[®] or PDMS pieces were removed from the CFIS,
783 gently dried with a paper tissue and finally introduced in glass desorption tubes.

784 Analysis were performed by thermodesorption-GC-MS using an Agilent (Palo
785 Alto, CA, USA) 6890 GC - 5973 MS system equipped with a Gerstel thermal
786 desorption unit TDS-2 and connected to a Gerstel programmed-temperature
787 vaporization (PTV) injector CIS-4 Plus by a heated transfer line. Analysis were
788 carried out using an TRB-5ms column (30 m x 0.25 mm x 0.25 μ m) from Teknokroma
789 (Barcelona, Spain).

790

791 *S1.6. Dosing sheets*

792 Silicone rubber sheets of 60 x 60 cm purchased from Altec Products Limited
793 (Cornwall, UK) were cut in pieces of 5 x 15 cm and four holes were pinched in the 4-
794 12 cm middle part. A total of 1.1 kg of dosing sheets, corresponding to a surface area
795 of around 3.5 m², were prepared this way. Prior to use, sheets were soxhlet extracted
796 with ethylacetate for one week and subsequently, the ethylacetate was extracted
797 from the sheets by two times 4 h with 2 L of methanol. Then the dosing sheets were
798 immersed in 1.6 L of methanol and the custom-made spiking solution obtained from
799 CIL Cluzeau (Courbevoie, France) was added. This solution contained PCB 18 (0.34
800 mg), PCB 28 (0.60 mg), PCB 52 (0.9 mg), PCB 77 (2.2 mg), PCB 81 (3.3 mg), PCB
801 101 (2.28 mg), PCB 105 (2.6 mg), PCB 114 (9.6 mg), PCB 118 (2.6 mg), PCB 123
802 (2.7 mg), PCB 126 (3 mg), PCB 138 (6 mg), PCB 153 (5 mg), PCB 156 (5 mg), PCB
803 157 (7 mg), PCB 167 (8 mg), PCB 169 (10 mg), PCB 180 (10 mg), PCB 189 (7 mg)
804 in 5 ml of ethylacetate. After 6 h of shaking, water was added to obtain a 90%
805 methanol solution that was shaken for 32 h. Dilution with water was continued by
806 10% steps as follows: 36 h at 80%, 48 h at 70%, 56 h at 60% and 80 h at 50%
807 methanol. Then the water/methanol mixture was discarded and sheets were washed

808 once with milli-Q water. Two quality control samples were taken just after spiking and
809 another one after the mounting of dosing sheets in the tank.

810 Before analysis, samples of dosing sheets were stored in glass jars at -20°C .
811 For each analysis, about 1 g of dosing sheet was extracted with 50 ml of methanol in
812 a glass jar with an aluminum foil lined lid shaken overnight at 100 rpm. Prior to
813 extraction, 1000 ng of PCB 143 was added as an internal surrogate. The extraction
814 was repeated and the combined extract was Kuderna Danish evaporated to about 2
815 ml followed by addition of 20 ml of hexane and Kuderna Danish evaporation was
816 repeated. The obtained hexane extract was transferred to a 15 ml vial and brought to
817 10 ml on weight basis. From the extract, 1 ml (on weight basis) was transferred to a
818 vial and 100 ng of TCN (1,2,3,4-tetrachloronaphtalene) were added. Further, a
819 dilution was made by measuring 100 μl into a vial with 100 ng of TCN and adding
820 hexane to 1 ml. Extracts were analysed as described for silicone rubber exposure
821 sheets (S1.2).

822

823 S2. Scheme and pictures of the exposure device (height = 120 cm, diameter = 47
824 cm).

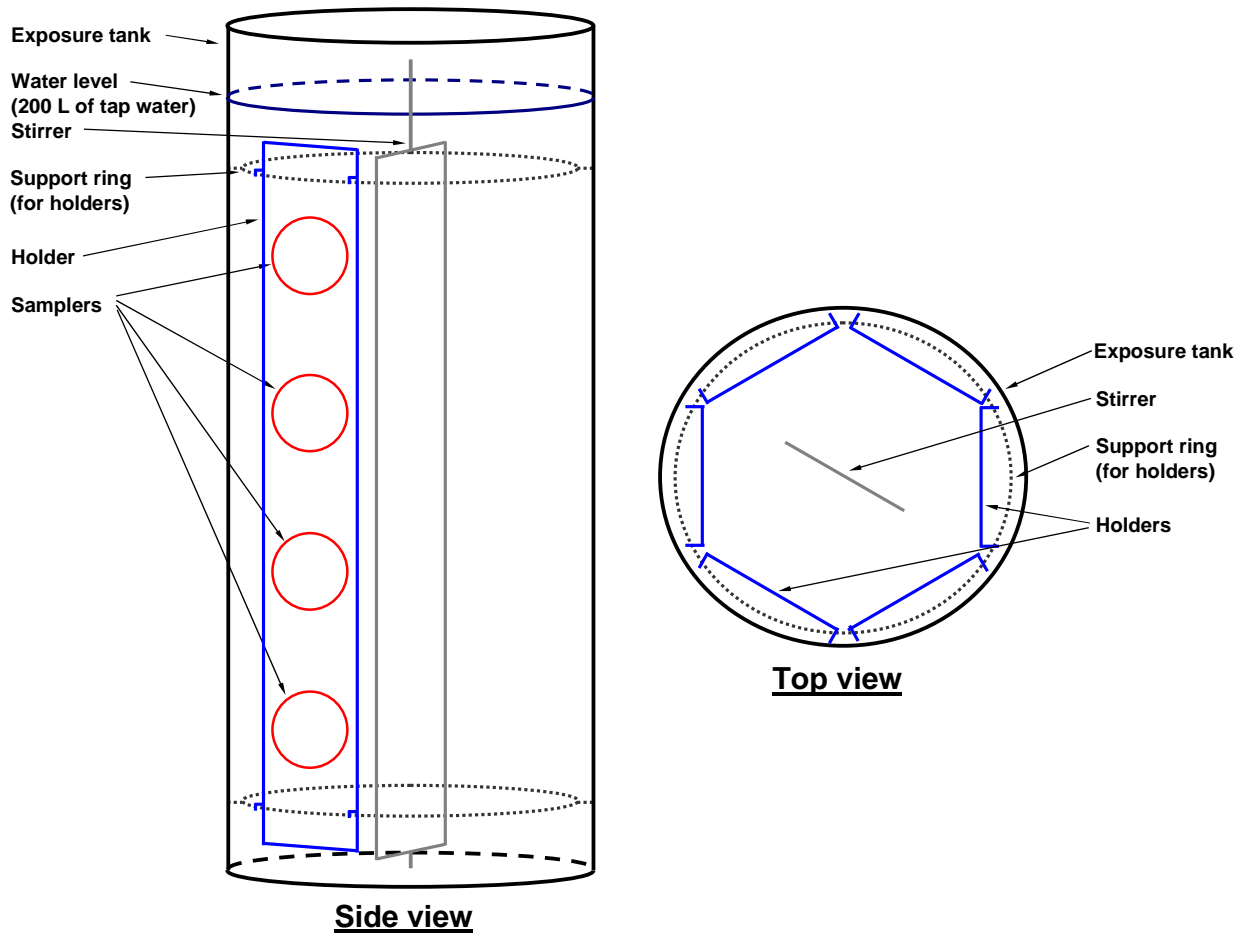

825

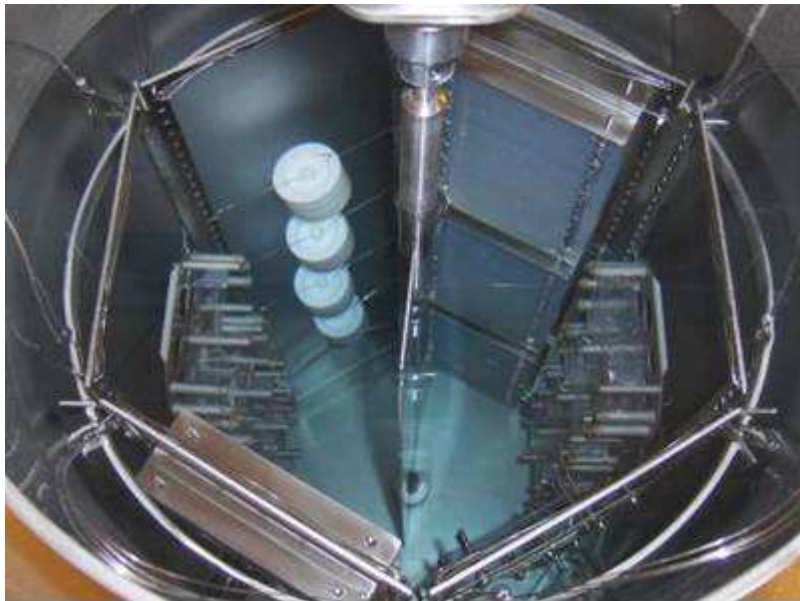

826

827 **Top view**

828
829
830
831
832
833
834
835
836
837
838

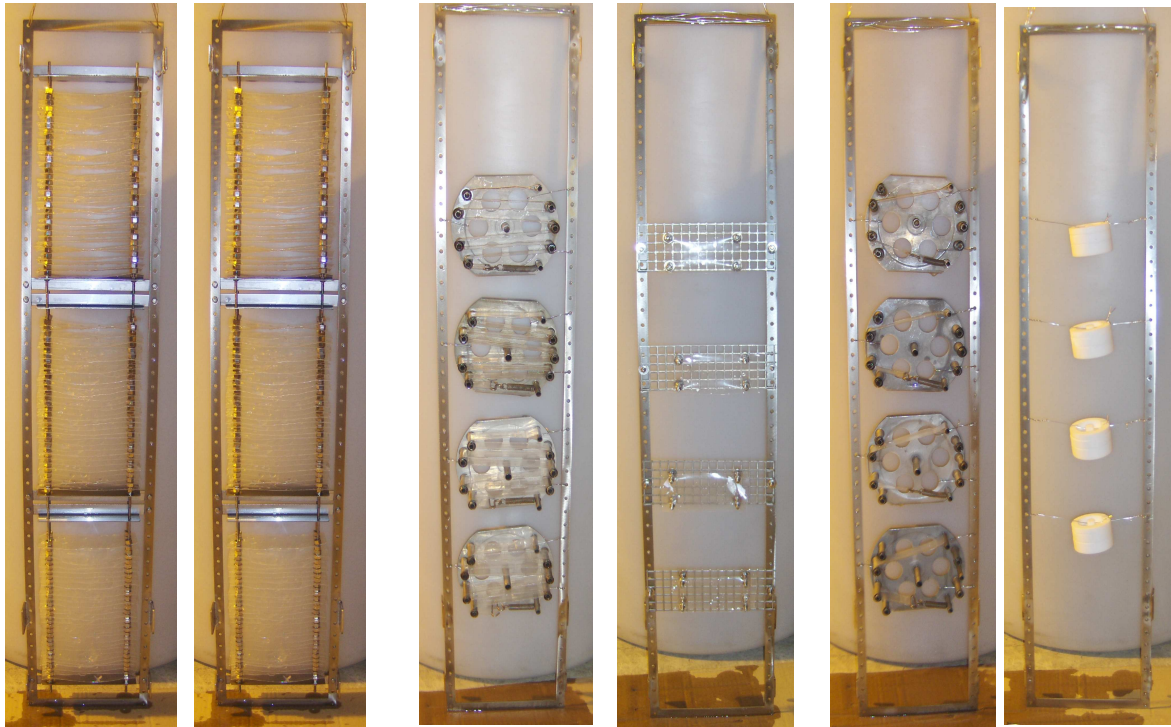

839 **The six holders with passive samplers (from the left to the right : 2 dosing sheets as**
840 **source of contamination, 1 SPMD, 1 SR, 1 LDPE, 1 Chemcatcher)**
841



842
843 **CFIS outside the tank**

844
845

846 S3. Detailed calculations of TWA concentrations of PCBs in water

847

848 $N_{t,i}$: amount of compound i accumulated in the sampler at time t

849 V_s : volume of sampler

850 V_i : molecular volume of compound i

851 M_s : mass of the sampler

852 $K_{ow,i}$: octanol-water partition coefficient of compound i

853 A_s : surface area of the sampler

854 MW_i : molecular weight of compound i

855

856 S3.1. SPMD

857

858 1. Calculation of PRC release rate constant, $k_{e,PRC}$ (day^{-1}):

859
$$k_{e,PRC} = -\frac{\ln(N_{t,PRC}/N_{0,PRC})}{t}$$

860

861 2. Calculation of SPMD-water partition coefficient, $K_{sw,i}$ [Huckins et al. 2006]:

862
$$\log K_{sw,i} = -2.61 + 2.321 \log K_{ow,i} - 0.1618(\log K_{ow,i})^2$$

863

864 3. Calculation of PRC sampling rate, $R_{S,PRC}$ ($\text{L}\cdot\text{day}^{-1}$):

865
$$R_{S,PRC} = V_s K_{sw,PRC} k_{e,PRC}$$

866

867 4. Calculation of analyte i sampling rate, $R_{S,i}$ ($\text{L}\cdot\text{day}^{-1}$):

868
$$R_{S,i} = R_{S,PRC} \left(\frac{V_{PRC}}{V_i} \right)^{0.39}$$

869

870 5. Calculation of analyte time-weighted average concentration in water, $C_{w,i}$ (ng/L):

871
$$C_{w,i} = \frac{N_{t,i}}{V_S K_{sw,i} \left(1 - \exp \left(- \frac{R_{S,i} t}{V_S K_{sw,i}} \right) \right)}$$

872

873 6. Calculation of analyte linear uptake phase duration, $t_{1/2,i}$ (day):

874
$$t_{1/2,i} = \frac{\ln 2 V_S K_{sw,i}}{R_{S,i}} = \frac{\ln 2}{k_{e,i}}$$

875

876

877 **S3.2. SR**

878

879 1. Estimation of F through nonlinear regression by fitting the measured release of

880 PRC with modeled data as a function of K_{pw} and $MW^{0.47}$. [Booij and Smedes, 2010]

881
$$\frac{N_{t,PRC}}{N_{0,PRC}} = \exp \left(- \frac{A_S MW_{PRC}^{-0.47} F t}{M_S K_{PW}} \right)$$

882

883 2. Calculation of analyte time-weighted average concentration in water, $C_{w,i}$ (ng/L):

884
$$C_{w,i} = \frac{N_{t,i}}{M_S K_{PW} \left(1 - \exp \left(- \frac{A_S MW_i^{-0.47} F t}{M_S K_{PW}} \right) \right)}$$

885

886 3. Calculation of analyte linear uptake phase duration, $t_{1/2,i}$ (day):

887
$$t_{1/2,i} = \frac{\ln 2 M_S K_{PW,i}}{A_S MW^{-0.47} F} = \frac{\ln 2}{k_{e,i}}$$

888

889

890 S3.3. LDPE

891

892 1. Calculation of PRC release rate constant, $k_{e,PRC}$ (day^{-1}):

893
$$k_{e,PRC} = -\frac{\ln(N_{t,PRC}/N_{0,PRC})}{t}$$

894

895 2. Calculation of LDPE-water partition coefficient, $K_{PW,i}$ [Smedes et al. 2009]:

896
$$\log K_{PW,i} = 0.0141 MW_i + 0.90 MPF_i + 1.06 \quad (+0.21 \text{ for tetra-ortho substituted PCB})$$

897 (with $MPF = \frac{\text{number of (meta + para)chlorine atoms}}{\text{total number of chlorine atoms}}$, meta-para chlorine fraction)

898

899 3. Calculation of PRC sampling rate, $R_{S,PRC}$ ($\text{L}\cdot\text{day}^{-1}$):

900
$$R_{S,PRC} = M_S K_{PW,PRC} k_{e,PRC}$$

901

902 4. Calculation of analyte i sampling rate, $R_{S,i}$ ($\text{L}\cdot\text{day}^{-1}$):

903
$$R_{S,i} = R_{S,PRC} \left(\frac{V_{PRC}}{V_i} \right)^{0.39}$$

904

905 5. Calculation of analyte time-weighted average concentration in water, $C_{W,i}$ (ng/L):

906
$$C_{W,i} = \frac{N_{t,i}}{M_S K_{PW,i} \left(1 - \exp \left(-\frac{R_{S,i} t}{M_S K_{PW,i}} \right) \right)}$$

907

908 6. Calculation of analyte linear uptake phase duration, $t_{1/2,i}$ (day):

909
$$t_{1/2,i} = \frac{\ln 2 M_S K_{PW,i}}{R_{S,i}} = \frac{\ln 2}{k_{e,i}}$$

910

911

912 S3.4. Chemcatcher

913

914 1. Calculation of PRC release rate constant, $k_{e,PRC}$ (day^{-1}):

915
$$k_{e,PRC} = -\frac{\ln(N_{t,PRC}/N_{0,PRC})}{t}$$

916

917 2. Calculation of Chemcatcher-water partition coefficient, $K_{DW,i}$ [Vrana 2006]:

918
$$\log K_{DW,i} = 1.382 \log K_{OW,i} - 1.77$$

919

920 3. Calculation of PRC sampling rate, $R_{S,PRC}$ ($\text{L}\cdot\text{day}^{-1}$):

921
$$R_{S,PRC} = V_S K_{DW,PRC} k_{e,PRC}$$

922

923 4. Calculation of analyte sampling rate, $R_{S,i}$ ($\text{L}\cdot\text{day}^{-1}$) [Vrana 2007]:

924
$$\log R_{S,i} = P_i + 22.755 \log K_{OW,i} - 4.061 (\log K_{OW,i})^2 + 0.2318 (\log K_{OW,i})^3$$

925 P_i : a factor taking into account environmental conditions and determined from R_S of

926 PRC [$P_i = \log R_{S,PRC} - 22.775 \log K_{OW,PRC} + 4.061 (\log K_{OW,PRC})^2 - 0.2318 (\log$

927 $K_{OW,PRC})^3$]

928

929 5. Calculation of analyte time-weighted average concentration in water, $C_{W,i}$ (ng/L):

930
$$C_{w,i} = \frac{N_{t,i}}{V_S K_{DW,i} \left(1 - \exp \left(- \frac{R_{S,i} t}{V_S K_{DW,i}} \right) \right)}$$

931

932 6. Calculation of analyte linear uptake phase duration, $t_{1/2,i}$ (day):

933
$$t_{1/2,i} = \frac{\ln 2 V_S K_{DW,i}}{R_{S,i}} = \frac{\ln 2}{k_{e,i}}$$

934

935

936 S3.5. CFIS

937

938 1. Calculation of analyte time-weighted average concentration in water, $C_{w,i}$ (ng/L):

939
$$C_w = \frac{N_{t,i}}{R_{S,i} t}$$

940

941 2. Calculation of analyte linear uptake phase duration, $t_{1/2,i}$ (day):

942
$$t_{1/2,i} = \frac{\ln 2 V_S K_{SW,i}}{R_{S,i}} = \frac{\ln 2}{k_{e,i}}$$

943

944 S4. Results of the physicochemical analysis of water sampled during exposure

945

Day	Temperature (°C)	pH	Conductivity (µS/cm)	DOC ^a (mg/L)
D0	22.61	7.7	380	1.50
D3	22.61	7.3	380	1.20
D7	22.61	7.8	375	1.90
D17	22.61	7.5	375	1.35
D21	22.63	7.5	380	1.80
D28	22.60	7.7	375	3.25
D42	22.60	7.2	355	4.50
D56	22.59	7.0	325	5.15
D70	22.65	7.5	320	5.15
D91	22.65	7.6	310	4,70

946 ^a DOC: dissolved organic carbon

947

948

949 S5. PRC-based linear uptake phase durations of PCBs (days)

950

	Log K _{OW} ^a	SPMD	SR	LDPE strip
PCB 18	5.24	27	43	3
PCB 28	5.67	46	84	5
PCB 52	5.84	57	159	12
PCB 77	6.36	86	318	34
PCB 81	6.36	86	318	34
PCB 101	6.38	90	473	47
PCB 105	6.65	103	661	70
PCB 114	6.65	103	610	70
PCB 118	6.74	106	653	70
PCB 123	6.74	106	610	70
PCB 126	6.89	110	819	107
PCB 138	6.83	112	1306	170
PCB 153	6.92	114	1459	170
PCB 156	7.18	117	1305	239
PCB 157	7.18	117	1649	239
PCB 167	7.27	116	1649	239
PCB 169	7.42	114	2108	338
PCB 180	7.36	118	2437	589
PCB 189	7.71	108	4395	795

951 ^a values from Hawker and Connell (1988)

952

953 S6. PRC-based sampling rates of PCBs (L/day/100cm²)

954

	Log K _{OW} ^a	SPMD	SR	LDPE strip
PCB 18	5.24	3.6 ± 0.3	4.2 ± 0.7	10.0 ± 1.2
PCB 28	5.67	3.6 ± 0.3	4.2 ± 0.7	10.0 ± 1.2
PCB 52	5.84	3.5 ± 0.3	4.0 ± 0.6	9.6 ± 1.2
PCB 77	6.36	3.5 ± 0.3	4.0 ± 0.6	9.6 ± 1.2
PCB 81	6.36	3.5 ± 0.3	4.0 ± 0.6	9.6 ± 1.2
PCB 101	6.38	3.4 ± 0.3	3.8 ± 0.6	9.4 ± 1.2
PCB 105	6.65	3.4 ± 0.3	3.8 ± 0.6	9.4 ± 1.2
PCB 114	6.65	3.4 ± 0.3	3.8 ± 0.6	9.4 ± 1.2
PCB 118	6.74	3.4 ± 0.3	3.8 ± 0.6	9.4 ± 1.2
PCB 123	6.74	3.4 ± 0.3	3.8 ± 0.6	9.4 ± 1.2
PCB 126	6.89	3.4 ± 0.3	3.8 ± 0.6	9.4 ± 1.2
PCB 138	6.83	3.3 ± 0.3	3.6 ± 0.6	9.1 ± 1.2
PCB 153	6.92	3.3 ± 0.3	3.6 ± 0.6	9.1 ± 1.2
PCB 156	7.18	3.3 ± 0.3	3.6 ± 0.6	9.1 ± 1.2
PCB 157	7.18	3.3 ± 0.3	3.6 ± 0.6	9.1 ± 1.2
PCB 167	7.27	3.3 ± 0.3	3.6 ± 0.6	9.1 ± 1.2
PCB 169	7.42	3.3 ± 0.3	3.6 ± 0.6	9.1 ± 1.2
PCB 180	7.36	3.2 ± 0.3	3.4 ± 0.6	8.9 ± 1.2
PCB 189	7.71	3.2 ± 0.3	3.4 ± 0.6	8.9 ± 1.2

^a values from Hawker and Connell (1988)

955

956

957 **References**

- 958 Costera, A. , Feidt, C., Marchand, P., Le Bizec, B., Rychen, G. 2006. PCDD/F and
959 PCB transfer to milk in goats exposed to long-term intake of contaminated hay.
960 Chemosphere 64, 650-657.
- 961
- 962 Booij, K., Smedes, F., van Weerlee, E.M., 2002. Spiking of performance reference
963 compounds in low density polyethylene and silicone passive water samplers.
964 Chemosphere 46, 1157-1161.
- 965
- 966 Booij, K, Smedes, F, 2010. An Improved Method for Estimating in Situ Sampling
967 Rates of Nonpolar Passive Samplers. Environ. Sci. Technol. 44(17), 6789-6794.
- 968
- 969 Hawker, D.W., Connell, D.W., 1988. Octanol water partition-coefficients of
970 polychlorinated biphenyl congeners. Environ. Sci. Technol. 22, 382-387.
- 971
- 972 Huckins, J.N., Petty, J.D., Booij, K., 2006. Monitors of organic chemicals in the
973 environment. Springer, New-York.
- 974
- 975 Johansson, I., Heas-Moisan, K., Guiot, N., Munschy, C., Tronczynski, J., 2006.
976 Polybrominated diphenyl ethers (PBDEs) in mussels from selected French coastal
977 sites: 1981-2003. Chemosphere 64, 296-305.
- 978
- 979 Meadows, J., Tillitt, D., Hickins, J., Schroeder, D., 1993. Large-scale dialysis of
980 sample lipids using a semi-permeable membrane device. Chemosphere 26, 1993-
981 2006.

982

983 Smedes, F., Geertsma, R.W., Van der Zande, T., Booij, K., 2009. Polymer-water
984 partition coefficients of hydrophobic compounds for passive sampling: application of
985 cosolvent models for validation. *Environ. Sci. Technol.* 43, 7047–7054.

986

987 Smedes, F., and Booij, K., 2012. Guidelines for passive sampling of hydrophobic
988 contaminants in water using silicone rubber samplers. *ICES Techniques in Marine*
989 *Environmental Sciences No. 52.* 20 pp.

990

991 University of Portsmouth, 2009. The non-polar Chemcatcher® sampling device -
992 Handling protocol.

993

994 Vrana, B., Mills, G.A., Greenwood, R., Knutsson, J., Svenssone, K., Morrison, G.,
995 2005. Performance optimisation of a passive sampler for monitoring hydrophobic
996 organic pollutants in water. *J. Environ. Monit.* 7, 612-620.

997

998 Vrana, B., Mills, G.A., Dominiak, E., Greenwood, R., 2006. Calibration of the
999 Chemcatcher passive sampler for the monitoring of priority organic pollutants in
1000 water. *Environ. Pollut.* 142, 333-343.

1001

1002 Vrana, B., Mills, G.A., Kotterman, M., Leonards, P., Booij, K., Greenwood, R., 2007.
1003 Modelling and field application of the Chemcatcher passive sampler calibration data
1004 for the monitoring of hydrophobic organic pollutants in water. *Environ. Pollut.* 145,
1005 895-904.