



HAL
open science

SOC Needs for optimal active or passive Li-ion balancing techniques

Xavier Pichon, Alexandre Collet, Delphine Riu, Jean-Christophe Crébier

► **To cite this version:**

Xavier Pichon, Alexandre Collet, Delphine Riu, Jean-Christophe Crébier. SOC Needs for optimal active or passive Li-ion balancing techniques. MEA2015 (More Electric Aircraft), Feb 2015, Toulouse, France. hal-01120994

HAL Id: hal-01120994

<https://hal.science/hal-01120994>

Submitted on 2 Mar 2015

HAL is a multi-disciplinary open access archive for the deposit and dissemination of scientific research documents, whether they are published or not. The documents may come from teaching and research institutions in France or abroad, or from public or private research centers.

L'archive ouverte pluridisciplinaire **HAL**, est destinée au dépôt et à la diffusion de documents scientifiques de niveau recherche, publiés ou non, émanant des établissements d'enseignement et de recherche français ou étrangers, des laboratoires publics ou privés.

Xavier Pichon (1, 2), Alexandre Collet (2), Delphine Riu (1), Jean Christophe Créber (1)

1: Univ. Grenoble Alpes, G2Elab, F-38000 Grenoble, France, firstname.lastname@g2elab.grenoble-inp.fr

1: CNRS, G2Elab, F-38000 Grenoble, France

2: FREEMENS SAS, Grenoble, France, firstname.lastname@freemens.fr

Battery Management Systems

Battery management systems (BMS) are used in batteries with series connected cells to ensure the **battery safety**, the **optimization of the battery answer** to any power requests and the **access to reliable data on the battery state**.

One of the most critical point to complete these functionalities is the accuracy of the implemented indicators used to estimate the battery state.

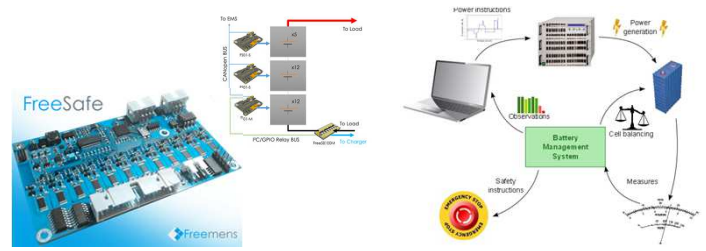

Cells disparities

Battery indicators such the *State Of Charge* (SOC) or *State Of Health* (SOH) are usually expressed at battery level for cells with homogeneous behaviors [1]. However this assumption is invalid when the cells present disparities in their initial characteristics and especially under aging conditions [2].

Example 1: increased risk of cell overcharge

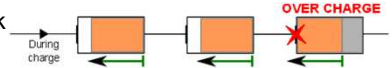

Example 2: charges transfer for State Of Charge equalization

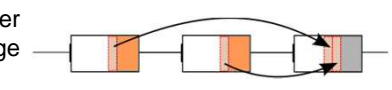

Legend: Capacity loss (grey), Stored charges (orange), Transferred charges (dotted orange), Charges stored during charge (green arrow)

Effective maximum capacity Q_{max_bat} and SOC_{bat}

Q_{cell} denotes the present charge amount stored in the cells, Q_{max} and Q_{max_cell} the initial and the present maximum charge amounts that the cells can store and I_{cell} the current in the cells.

$$SOH_{cell} = \frac{Q_{max_cell}}{Q_{max}} \quad SOC_{cell}(t) = \frac{Q_{cell}(t)}{Q_{max_cell}}$$

1st case study Cells with the same SOH

$$\begin{cases} Q_{max_bat} = Q_{max} * SOH * (1 - \max(\Delta SOC)) \\ SOC_{bat}(t) = \min_{1 \leq i \leq N} (SOC_{cell_i}(t)) * \frac{1}{1 - \max(\Delta SOC)} \end{cases}$$

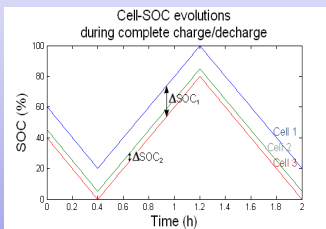

2nd case study

Cells with the SOH_{cell} disparities

$$\begin{cases} Q_{max_bat} = \min_{1 \leq i \leq N} (Q_{cell_i}(t)) + \min_{1 \leq i \leq N} (Q_{max_cell_i} - Q_{cell_i}(t)) \\ SOC_{bat}(t) = \frac{\min_{1 \leq i \leq N} (Q_{cell_i}(t))}{Q_{max_bat}} \\ Q_{max_bat} = Q_{max} * \left[\min_{1 \leq i \leq N} (SOH_{cell_i} * SOC_{cell_i}(t)) + \min_{1 \leq i \leq N} (SOH_{cell_i} * (1 - SOC_{cell_i}(t))) \right] \\ SOC_{bat}(t) = \frac{Q_{max} * \min_{1 \leq i \leq N} (SOH_{cell_i} * SOC_{cell_i}(t))}{Q_{max_bat}} \end{cases}$$

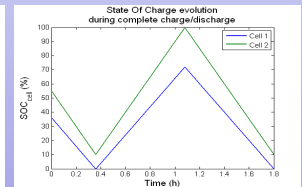
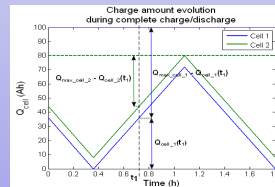

3rd case study With uncertainties on SOC estimations

$$\begin{cases} Q_{max_bat}(t) = Q_{max} * \left[\min_{1 \leq i \leq N} (SOH_{cell_i} * SOC_{bot_cell_i}(t)) + \min_{1 \leq i \leq N} (SOH_{cell_i} * (1 - SOC_{up_cell_i}(t))) \right] \\ SOC_{bat}(t) = \frac{Q_{max} * \min_{1 \leq i \leq N} (SOH_{cell_i} * SOC_{bot_cell_i}(t))}{Q_{max_bat}(t)} \end{cases}$$

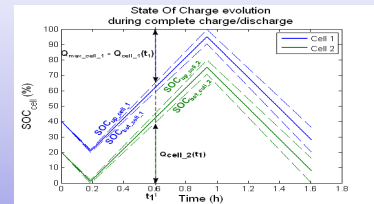

Implementation

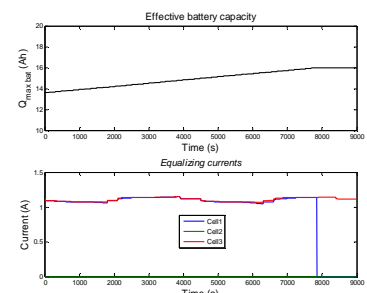
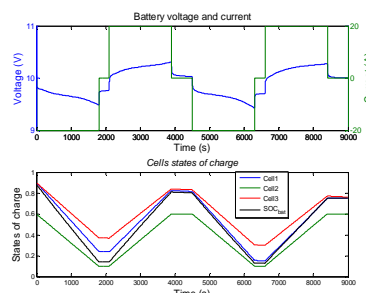
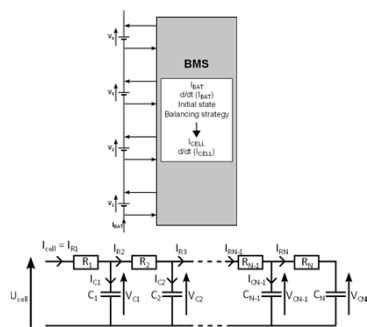

Simulation results – Behaviour of a battery composed of 3 cells Of 20Ah and with passive balancing

$$SOH_{cell_1} = 80\% \quad SOH_{cell_2} = SOH_{cell_3} = 100\%$$

