



HAL
open science

Desorption-induced shear failure of coal bed seams during gas depletion

D.N. Espinoza, Jean-Michel Pereira, Matthieu Vandamme, Patrick Dangla, S.
Vidal-Gilbert

► **To cite this version:**

D.N. Espinoza, Jean-Michel Pereira, Matthieu Vandamme, Patrick Dangla, S. Vidal-Gilbert.
Desorption-induced shear failure of coal bed seams during gas depletion. *International Journal of
Coal Geology*, 2015, 137, pp.142-151. 10.1016/j.coal.2014.10.016 . hal-01118564

HAL Id: hal-01118564

<https://hal.science/hal-01118564v1>

Submitted on 10 May 2019

HAL is a multi-disciplinary open access archive for the deposit and dissemination of scientific research documents, whether they are published or not. The documents may come from teaching and research institutions in France or abroad, or from public or private research centers.

L'archive ouverte pluridisciplinaire **HAL**, est destinée au dépôt et à la diffusion de documents scientifiques de niveau recherche, publiés ou non, émanant des établissements d'enseignement et de recherche français ou étrangers, des laboratoires publics ou privés.

1
2
3
4
5
6
7
8
9
10
11
12
13
14
15
16
17
18
19
20
21
22
23
24
25
26
27
28
29
30
31
32
33
34
35
36
37
38
39
40
41
42
43
44
45
46
47
48
49
50
51
52
53
54
55
56
57
58
59
60
61
62
63
64
65

Desorption-induced shear failure of coal bed seams during gas depletion

D. N. Espinoza^{a,b}, J. -M. Pereira^a, M. Vandamme^a, P. Dangla^a, S. Vidal-Gilbert^c

^a*Université Paris-Est, Laboratoire Navier, (UMR 8205), ENPC, CNRS, IFSTTAR*

^b*The University of Texas at Austin, Department of Petroleum and Geosystems Engineering*

^c*Total S.A., Unconventional Gas Resources*

Abstract

The recovery of natural gas from coal bed seams is usually accompanied by a significant increase of permeability induced by coal matrix shrinkage and stress relaxation upon gas desorption. This advantageous increase in permeability may be impaired sometimes by mechanical failure of the reservoir rock and ensuing production of coal fines. Near-wellbore stress concentration and reduction of lateral stresses are known to promote shear failure during depletion in oil and gas reservoir formations. Yet, conventional analyses have shown limited success in predicting coal failure, since other chemo-physical mechanisms may be responsible in enhancing the conditions towards mechanical failure in the coal bed reservoir rock. We show a set of triaxial experiments involving gas desorption from coal cores under zero-lateral strain condition (radial stress measured and controlled) and constant total vertical stress meant to simulate the stress path during production far from the wellbore. CO₂ is used a surrogate fluid for CH₄. The experimental data indicates that desorption can significantly help reduce lateral stress (and

1
2
3
4
5
6
7
8
9 increasing deviatoric stress) until shear failure occurs. The results suggest
10 that depletion-induced shear failure is much more likely to occur in coal
11 seams than in conventional non-sorbing reservoir rocks. The adsorption-
12 mechanical coupling turns out to be a key phenomenon in the process. Nu-
13 merical simulations at the representative elementary volume scale adopting
14 a double-porosity poromechanical model support the experimental findings
15 and permit calculating a critical gas pressure for shear failure to happen.
16 This emergent phenomenon is comparable to the outcome of other situations
17 such as mineral dissolution or thermal contraction, where shrinkage relaxes
18 lateral stress and acts as an intensifying driver for promoting shear failure
19 within the reservoir rock. Coupled numerical simulation is needed to include
20 near-wellbore effects and validate our findings with actual field observations.
21 A thorough understanding of the coupled response of coal seams is necessary
22 to enhance reservoir management and mitigate the effects of coal failure on
23 fines production.
24
25
26
27
28
29
30
31
32
33
34
35
36

37 *Keywords:* fines production, CBM, adsorption, swelling, nanoporosity,
38 faulting, chemo-mechanical coupling
39
40
41

42 43 **1. Introduction**

44
45
46
47
48
49
50
51
52
53
54
55
56
57
58
59
60
61
62
63
64
65

2 Currently, natural gas accounts for roughly 20% of the World's energy
supply (IEA, 2013). Coal bed methane constitutes an important domestic
source of natural gas in several countries, namely Australia, USA, Canada
and China (EIA, 2013). Moreover, production of coal bed methane is ex-
pected to increase throughout the world in the near future as more reservoirs
are discovered and new technology enables enhanced production.

1
2
3
4
5
6
7
8
9
10
11
12
13
14
15
16
17
18
19
20
21
22
23
24
25
26
27
28
29
30
31
32
33
34
35
36
37
38
39
40
41
42
43
44
45
46
47
48
49
50
51
52
53
54
55
56
57
58
59
60
61
62
63
64
65

8 Various characteristics make coal beds a unique geomaterial, showing
9 poromechanical properties notably different from other reservoir rocks. First,
10 coal seams are naturally fractured reservoirs. Diagenetic processes lead to
11 opening mode fractures predominantly oriented perpendicularly to the bed-
12 ding plane, called cleats (Laubach et al., 1998). Cleats compose most of the
13 macroporosity, where fluid flow occurs by advection (Mazumder et al., 2006;
14 Pan and Connell, 2007). Second, the coal solid skeleton is constituted by a
15 microporous disordered organic continuum, termed coal matrix. Micropores
16 and mesopores sized in the order of 10^{-9} to 10^{-8} m compose the coal mi-
17 croporosity. The coal matrix is capable of adsorbing various gases, including
18 carbon dioxide CO_2 , methane CH_4 , and nitrogen N_2 ; adsorption leads to
19 coal matrix volumetric swelling in the order of a few percents (Reucroft and
20 Sethuraman, 1987; Ceglarska-Stefanska and Czaplinski, 1993; Levine, 1996;
21 Mazumder et al., 2006; Pan and Connell, 2007; Pini, 2009). Conversely,
22 desorption leads to coal matrix shrinkage.

23 Bottom-hole depressurization induces gas production from fractures and
24 desorption from the coal matrix during the production phase. Desorption-
25 induced shrinkage has an important effect on coal seam permeability (Palmer
26 and Mansoori, 1998; Pan and Connell, 2012). Shrinkage favors the opening
27 of open-mode fractures with a concomitant increase in permeability. How-
28 ever, large increases in permeability during depletion have sometimes been
29 observed to be followed by a sudden drop of permeability (Figure 1), usually
30 accompanied by the production of coal fines (Moore et al., 2011; Okotie and
31 Moore, 2010). One cause of fines production (also responsible for sand pro-
32 duction in conventional reservoir) is increased stress anisotropy and shearing

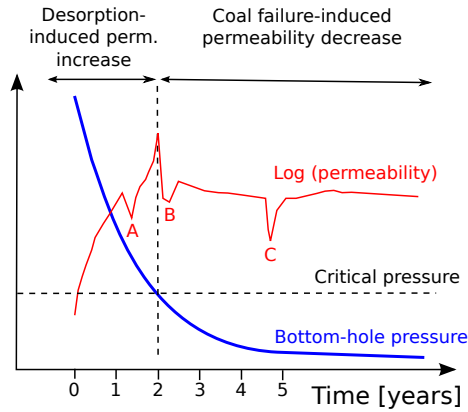

Figure 1: Schematic signature of reservoir response and coal failure during depletion as a function of time: bottom-hole pressure and permeability signals. Notice that sudden permeability reductions (indicated A, B and C) take place as bottom-hole pressure is reduced. The permeability drops are associated with coal failure events. The last permeability drop (C) is recovered after wellbore clean-up operations only. Adapted from field experimental data by Moore et al. (2011).

around uncased wells or perforations due to loss of radial support.

Reservoir depletion is known to induce changes in effective stresses in the reservoir rock far from the wellbore, that can sometimes lead to shear failure and fault reactivation within the reservoir. Depletion promotes zero-lateral strain loading condition in laterally extensive reservoirs (condition commonly known as uniaxial strain/compression in Petroleum Engineering and Structural Geology or oedometric condition in Geotechnical Engineering— Figure 2). The change in stresses upon depletion in conventional reservoirs is well predicted by poroelasticity, shear-failure (induced normal faulting), or a combination of both (Teufel et al., 1991; Segall and Fitzgerald, 1998; Gouly, 2003). Under zero-lateral strain condition, the ratio between the change of total lateral (horizontal) stress $\Delta\sigma_h$ and the change of reservoir pressure Δp

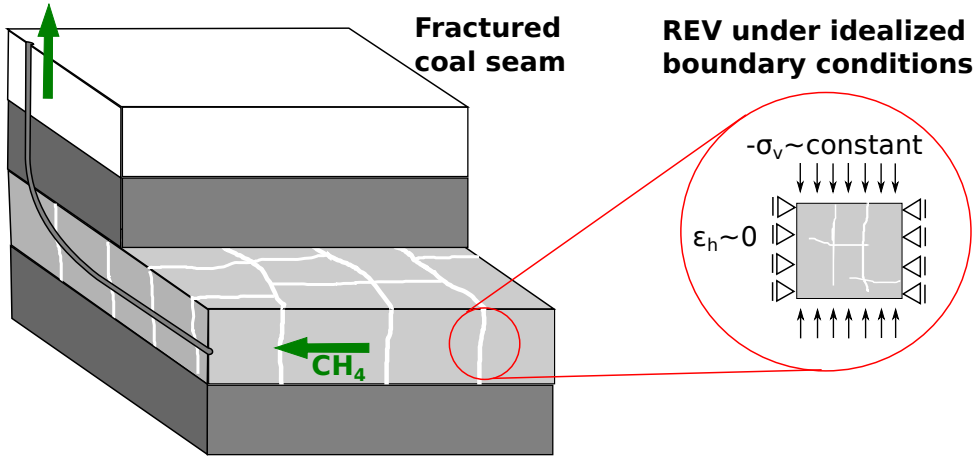

Figure 2: Schematic representation of a coal seam intercepted by a horizontal well and of a representative elementary volume (REV) far from near-wellbore effects. Laterally extensive coal seams follow zero-lateral strain compression far from the wellbore.

is equal to $\Delta\sigma_h/\Delta p = 2/3$ for a poroelastic response with Poisson's ratio $\nu = 0.25$ and Biot's coefficient $\alpha = 1$ or for shear failure with friction coefficient $\mu = 0.58$. Recent experimental work shows a reduction of 9.4 MPa of lateral stress upon drawdown of CH_4 gas pressure from 6.2 to 0.3 MPa while keeping zero-lateral (radial) strain condition in a cylindrical coal core (Mitra et al., 2012). This result indicates a ratio $\Delta\sigma_h/\Delta p \sim 1.57$. Theoretical $\Delta\sigma_h/\Delta p$ values predicted by poroelasticity cannot be higher than 1 for any combination of Poisson's ratio and Biot's coefficient in conventional rocks (Zoback, 2013), which suggests that conventional poroelasticity cannot fully explain the behavior of coal seams.

Given the double porosity of coal seams (micro and macroporosity described previously) and the well known adsorption-induced swelling of the coal matrix, the change in lateral stress in coal seams upon depletion is expected to have some particularities with respect to conventional reservoirs.

1
2
3
4
5
6
7
8
9
59 Recent work from the authors aims at predicting adsorption-induced strains
10 and stresses in coal seams within a poromechanical framework including rig-
11 orously adsorption phenomena (Brochard et al., 2012; Nikoosokhan et al.,
12 2012, 2014; Espinoza et al., 2013, 2014). Our experimental and modeling re-
13 sults indicate that adsorption can generate significant stresses in the order of
14 tens of MPa at typical reservoir pressures. Hence, it should not be surprising
15 that desorption at zero-lateral strain can significantly affect the reduction
16 of lateral stress during depletion at a $\Delta\sigma_h/\Delta p$ rate much greater than the
17 one due solely to poroelastic effects in macropores predicted by conventional
18 poroelasticity.
19

20
21
22
23
24
25
26
27
28 The objective of this study is to assess the reduction of lateral stresses in
29 coal seams during depletion and gas desorption by replicating the depletion
30 pressure-stress path in the laboratory using CO₂ as a surrogate fluid for
31 CH₄. We aim at understanding the underlying phenomena which lead to coal
32 failure and production of coal fines at the scale of a representative elementary
33 volume far from near-wellbore effects.
34
35
36
37
38
39
40

41 **2. Materials and Methods**

42 *2.1. Coal characterization and triaxial testing*

43
44
45
46 We test coal originary from South Africa (Vitrinite reflectance 0.57% – sub-
47 bituminous A/high volatile C bituminous by ASTM D 388). A set of cores
48 38 mm diameter and 2:1 slenderness drilled perpendicularly to the bedding
49 plane serve as experimental specimens. The bulk density of cores ranges
50 from 1318 to 1356 kg/m³. The specimen Helium porosity varies from 11-to-
51 13%. Core testing takes place in a triaxial cell connected to syringe pumps
52
53
54
55
56
57
58
59
60
61
62
63
64
65

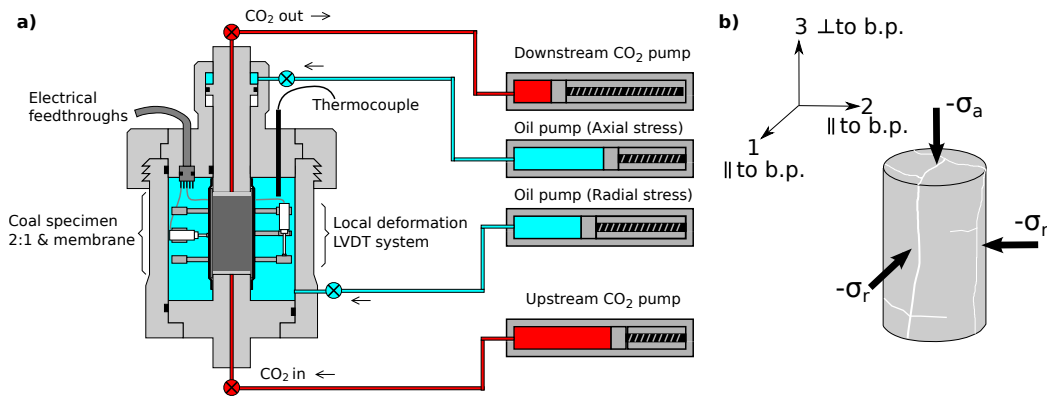

Figure 3: a) Experimental triaxial device; main characteristics include: maximum radial stress 40 MPa, maximum axial stress 60 MPa, measurement of local strains through LVDTs, temperature control and ability to handle pressurized pore-fluids. b) Orientation of the specimen respect to the bedding plane (b.p.).

to control stresses and pore-fluid pressure. The system is able to (1) measure specimen axial and radial deformations and (2) control independently axial and radial stresses to apply isotropic or anisotropic state of stresses (including zero-lateral strain condition). Figure 3 shows a schematic representation of the triaxial cell and its main features.

2.2. Determination of shear strength

We tested the shear strength of coal cores in dry conditions (without adsorbed gas) under unconfined and confined triaxial conditions. The triaxial cell imposes a deviatoric loading by applying a change in axial strain with time at a given constant confinement. The axial strain rate is fixed to a constant value equal to $3 \cdot 10^{-4} \text{ min}^{-1}$. Rigorously, the shear strength should be tested with sorbed gas, as sorption may reduce shear strength (See section 4.1 Fluid-specific effects).

1
2
3
4
5
6
7
8
9
96 *2.3. Desorption test procedure*

10
11 We aim at simulating in the laboratory the pressure-stress path of a
12
13 98 block of coal subjected to depressurization and depletion. Hence, the follow-
14
15 99 ing pressure-stress path is required: (1) recreation of in-situ initial state of
16
17 100 stresses and seam pressure (requires adsorbed gas in thermodynamical equi-
18
19 101 librium with gas in the cleats), (2) imposition of a pressure drawdown to
20
21 102 extract gas from the fractures and coal micropores, with simultaneous ad-
22
23 103 justment of lateral stresses to keep zero-lateral strain condition, while the
24
25 104 total vertical stress remains constant (constant overburden – see Figure 2).

26
27 105 The experimental procedure to achieve the pressure-stress path described
28
29 106 above consists of the following steps:

- 30
31 107 1. Increase confining stresses 1 to 2 MPa above the objective fluid injec-
32
33 108 tion pressure p_{ci} at which the core will be exposed. The resulting low
34
35 109 effective stress will facilitate quick advective gas flow through fractures
36
37 110 (since fracture permeability is highly sensitive to effective stress) and
38
39 111 reduce equilibration time in the next step.
- 40
41 112 2. Inject CO₂ at constant confining stress, let the specimen swell and equi-
42
43 113 librate for ~ 7 days. Swelling strains help us evaluate thermodynamical
44
45 114 equilibrium, such that when they reach steady-state values we consider
46
47 115 equilibrium has been attained.
- 48
49 116 3. Increase effective stresses to the initial stress conditions representing
50
51 117 the current in-situ stresses in the formation. Let the specimen equi-
52
53 118 brate again for at least 1 day.
- 54
55 119 4. Apply a drawdown pressure by imposing constant pressures at the two
56
57 120 loading caps $p_{DS} < p_{US} < p_{ci}$ (p_{DS} : pressure downstream, p_{US} : pres-

1
2
3
4
5
6
7
8
9
10 sure upstream).

11 5. The pressure drawdown induces axial and radial deformations. The
12 radial deformation is canceled periodically (to keep variations smaller
13 than $\Delta\varepsilon_r < 3 \cdot 10^{-4}$) by reducing the total radial stress in order to
14 maintain near zero-lateral strain condition. No action is taken on the
15 axial direction, so that total axial stress remains constant.
16
17
18
19
20

21 All tests are performed under stress, pressure, and temperature relevant
22 to in-situ coal bed conditions. Instead of CH_4 , we utilize CO_2 as the pore
23 fluid. The applicability of our CO_2 laboratory results to CH_4 desorption are
24 discussed in Section 4.1.
25
26
27
28
29

30 **3. Experimental results**

31 *3.1. Dry testing – Shear failure envelope*

32
33 Table 1 lists all shear strength experiments. Figure 4 shows an exam-
34 ple of a coal core failed under simple compression. Specimens V4, V5, and
35 V6 were tested under unconfined conditions while specimens V7 and V9
36 were tested under confined triaxial conditions. Figure 5 shows the sum-
37 mary of shear strength results with Mohr circles at failure. The shear
38 strength increased non-linearly with added confining stress. The friction
39 angle estimated from the orientation of shear fractures in failed specimens
40 is $\phi \sim 40^\circ$ to 50° . The best-fitting parameters for the Hoek-Brown criterion
41 $\sigma'_1 = \sigma'_3 + \sigma'_{UCS} \sqrt{m\sigma'_3/\sigma'_{UCS} + s}$ in terms of Terzaghi's effective stress defined
42 as $\sigma' = -(\sigma + p_c)$ are $s=1$, $\sigma'_{UCS}=22.05$ MPa and $m= 38.4$. Pressure p_c is
43 zero an all experiments listed in Table 1.
44
45
46
47
48
49
50
51
52
53
54
55
56
57
58
59
60
61
62
63
64
65

1
2
3
4
5
6
7
8
9
10
11
12
13
14
15
16
17
18
19
20
21
22
23
24
25
26
27
28
29
30
31
32
33
34
35
36
37
38
39
40
41
42
43
44
45
46
47
48
49
50
51
52
53
54
55
56
57
58
59
60
61
62
63
64
65

Table 1: List of shear strength experiments on dry specimens. (*) Acquisition error – stress signal lost.

Specimen	Terzaghi's effective radial stress σ'_r [MPa]	Terzaghi's effective axial stress σ'_a [MPa]
V4	0.0	>17*
V5	0.0	20.7
V6	0.0	22.2
V7	3.0	55.0
V9	1.5	48.0

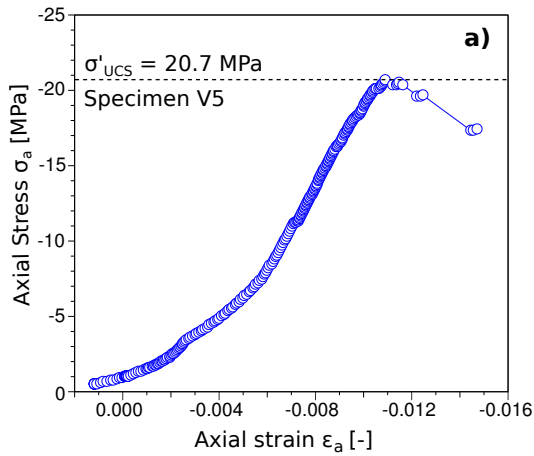

Coal failed under simple compression

Figure 4: Unconfined compression test: a) stress-strain curve, and b) picture of sheared coal as extruded out from the testing sleeve; fragments are ordered from left to right according to their size.

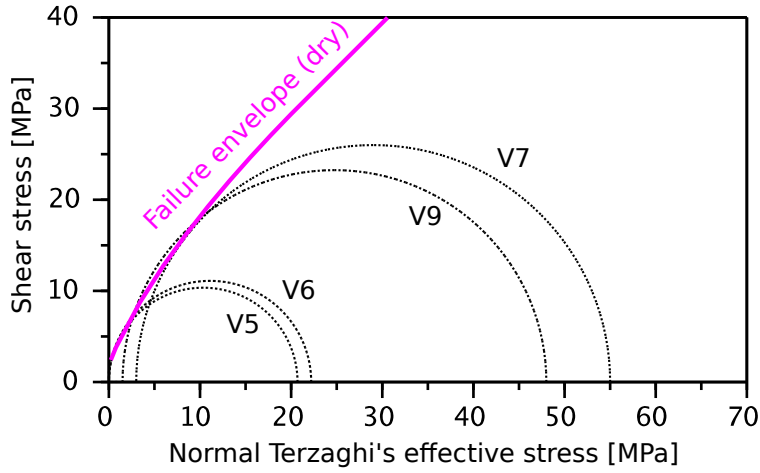

Figure 5: Summary of triaxial shear tests with Mohr circles at failure. The pink line represents the Hoek-Brown fitted shear failure envelope of dry specimens.

144 *3.2. CO₂ testing – Desorption-induced shear failure*

145 Table 2 lists the initial (subindex *i*) and final conditions (subindex *f*) of
 146 all desorption experiments performed. The experiments are carried out at
 147 $39 \pm 1^\circ\text{C}$. Seven days of exposing the coal core to CO_2 are quite likely enough
 148 to allow significant sorption, because in this time frame the measured swelling
 149 strains reached steady state values in the order of 2 to 3% attributable only to
 150 adsorption. Figure 6 shows the experimental time history of specimen V2b
 151 upon desorption. Depressurization starts at 0.112 days, moment at which
 152 the pressure of the loading cap downstream is regulated to $p_{DS} = 1$ MPa.
 153 Five minutes later, the pressure at the loading cap upstream is regulated to
 154 $p_{US} = 1.5$ MPa. Notice that at this time the fluid pressure in the cleats is
 155 likely to be higher than the pressure regulated at loading caps. 15 minutes
 156 after having regulated the pressure at the loading cap upstream, the pressure
 157 at the loading cap downstream is regulated one more time to $p_{DS} = 0.5$ MPa.

Table 2: List of CO₂ zero-lateral strain desorption experiments: initial and final pressure-stress conditions.

Specimen	Initial conditions			Final conditions		
	p_{ci} [MPa]	σ_{ri} [MPa]	σ_{ai} [MPa]	p_{cf} [MPa]	σ_{rf} [MPa]	Failure [Y/N]
V2a	10.0	-21.0	-22.0	1.0	-2.0	N
V3a	5.0	-6.0	-10.0	0.5	-0.6	N
V2b	10.0	-15.0	-30.0	1.5-0.5	-2.0	Y
V3b	10.0	-15.0	-30.0	1.0	-3.0	Y

This experiment shows that the result of depressurization and desorption at zero-lateral strain is a reduction of 13 MPa of radial stress. Failure (at constant total vertical stress) manifests itself through the measured variables as a rapid homogenization of the pressures upstream and downstream (shear fractures form) and a rapid change of strains in axial (contraction) and radial (expansion) directions. The radial strain is not controllable anymore after the onset of failure.

Figure 7 shows the experimental data from Figure 6 plotted independently of time. Figure 7-a shows the change of strain as a function of total radial stress. Radial strain ε_r remains nearly constant till the onset of failure. Figure 7-b shows the change of total stresses as a function of the mean CO₂ pressure upstream and downstream. Figure 7-c shows the effective stress path of the apex of the Mohr circle. Recall that p_c is not homogeneous through the specimen and its average value is unknown shortly after depressurization. Terzaghi's effective stress is computed with an average value of CO₂ pressure: $\sigma'_r = -[\sigma_r + (p_{US} + p_{DS})/2]$ and $\sigma'_a = -[\sigma_a + (p_{US} + p_{DS})/2]$. The increase

1
2
3
4
5
6
7
8
9
10
11
12
13
14
15
16
17
18
19
20
21
22
23
24
25
26
27
28
29
30
31
32
33
34
35
36
37
38
39
40
41
42
43
44
45
46
47
48
49
50
51
52
53
54
55
56
57
58
59
60
61
62
63
64
65

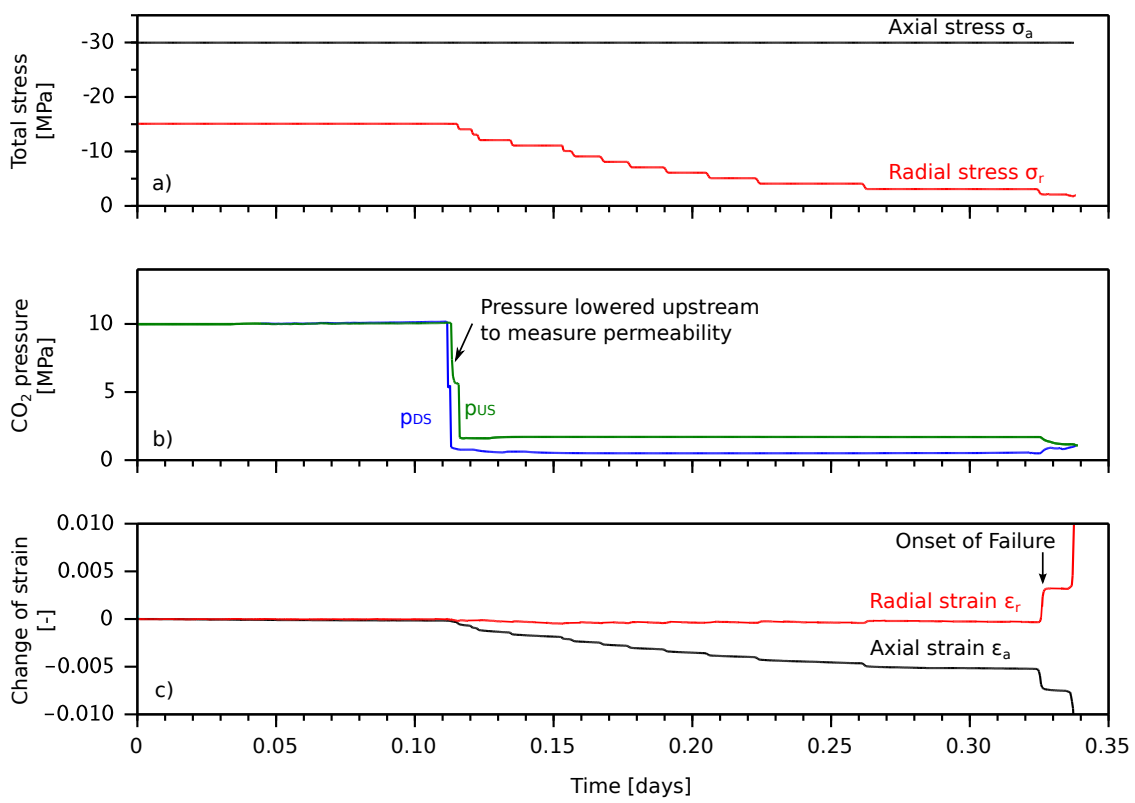

Figure 6: Time history of experiment V2b: a) total stresses, b) fluid pressure measured at upstream and downstream loading caps (a pressure gradient is applied to measure permeability), and c) change of strain respect to equilibrium initial conditions.

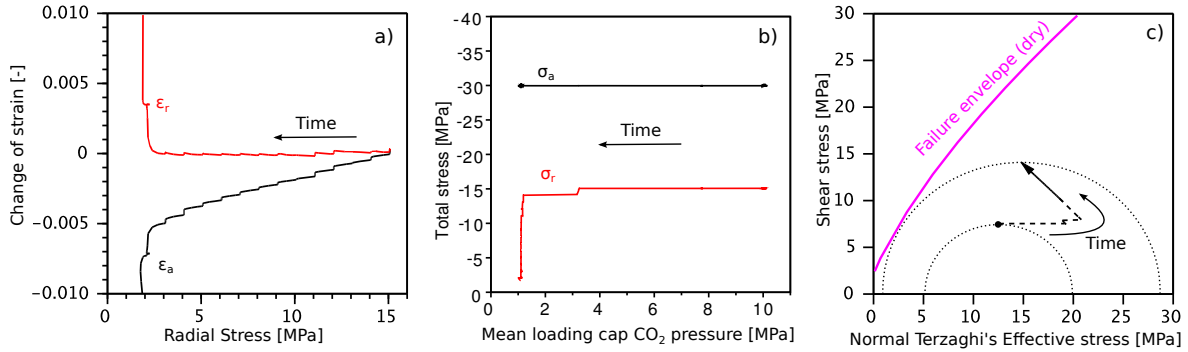

Figure 7: Experimental data from experiment V2b: a) deformation as a function of radial stress, b) path of total stresses as a function of the mean CO_2 pressure upstream and downstream $(p_{US} + p_{DS})/2$, and c) path of the apex of the Terzaghi's effective stress Mohr circle (the pressure in the cleats p_c is not well approximated by the average loading cap pressures right after depressurization – plotted as dashed lines).

in deviatoric stress is clearly manifested by an increase in the radius of the Mohr circle. Specimen V2b fails upon desorption at a state of stress which nearly touches the failure envelope fitted for coal cores from the same seam without CO_2 .

Figure 8 shows post-testing X-ray computed tomography images of specimen V2b. The images confirm pervasive shear failure all over the specimen. Many fractures seem to be initiated at pre-existing fractures and continue through lamination layers.

Experiment V3b showed a response to desorption similar to that of specimen V2b. Shear failure occurred by gradual but steady increase in axial strain, much less abruptly than in experiment V2b. Experiments V2a and V3a experienced desorption-induced reduction of lateral stress but did not achieve shear failure. Notice that experiment V3a reaches nearly zero Terzaghi's effective radial stress. At this point, the radial confining pressure (ra-

1
2
3
4
5
6
7
8
9
10
11
12
13
14
15
16
17
18
19
20
21
22
23
24
25
26
27
28
29
30
31
32
33
34
35
36
37
38
39
40
41
42
43
44
45
46
47
48
49
50
51
52
53
54
55
56
57
58
59
60
61
62
63
64
65

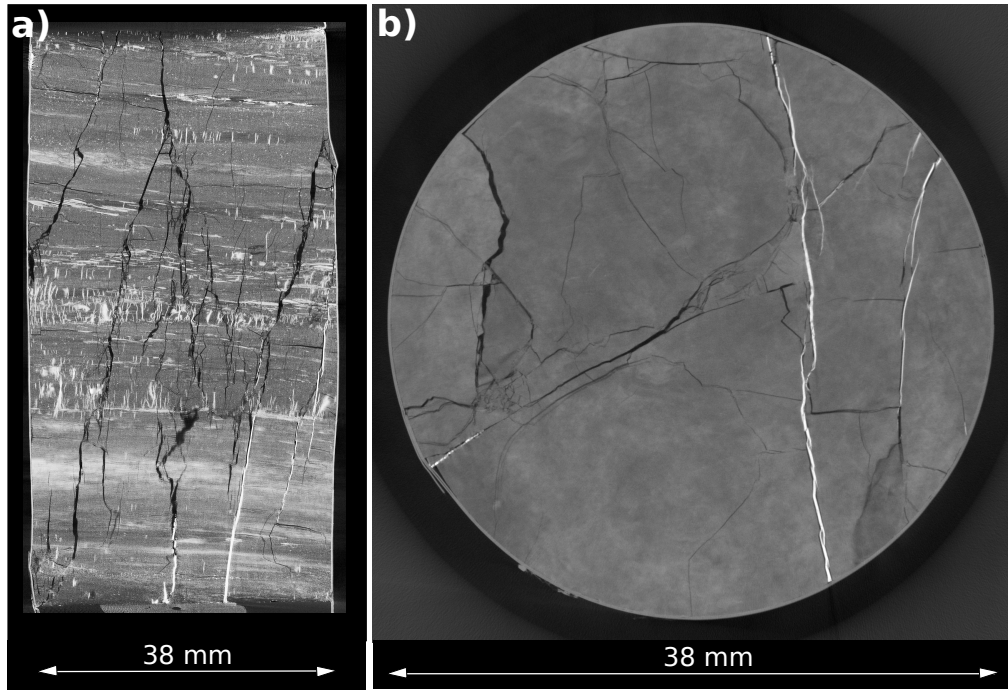

Figure 8: Coal specimen V2b after desorption-induced shear failure imaged by X-ray computed tomography at Laboratoire Navier (navier.enpc.fr/Microtomographe): a) vertical cross section and b) horizontal cross section. Intense white regions represent calcite-filled fractures. Diffuse white regions indicate higher clay-content lamination layers. Dark black stands for voids and empty fractures. Resolution: 25 μm . Note: the specimen is still contained by confining membrane at the time of X-ray imaging.

1
2
3
4
5
6
7
8
9
10 188 dial stress) cannot be reduced to compensate shrinkage because otherwise
11 189 the pore-fluid would escape into the confining fluid. Thus, zero-lateral strain
12
13 190 condition cannot be held anymore after this point and the specimen contin-
14
15 191 ues to desorb shrinking in all directions. Similarly, shear failure does not
16
17 192 indicate the end of desorption. Cores from experiments V2b and V3b likely
18
19 193 continued to desorb and shrink after shear failure.
20
21

22 194 **4. Discussion**

23 24 25 195 *4.1. Fluid-specific effects and scale effects*

26
27 196 The underlying physical mechanisms and geomechanical consequences are
28
29 197 expected to be qualitatively similar with CH₄ and CO₂. Nonetheless, two
30
31 198 points must be considered to project our experimental results to CBM ap-
32
33 199 plications.

34
35 200 First, CO₂ adsorption-induced strains are nearly two to three times as
36
37 201 high as the ones induced by CH₄ adsorption at the same bulk fluid pressure
38
39 202 (Chikatamarla et al., 2009; Pini, 2009; Pan and Connell, 2011). Independent
40
41 203 gravimetric sorption measurements on crushed coal from the same formation
42
43 204 as the one tested here show that the maximum excess sorption of CO₂ is
44
45 205 1.4 mmol/g, about twice as high as the maximum excess sorption of CH₄
46
47 206 (experiments performed by BGC-Analytik UG). Hence, our laboratory ex-
48
49 207 perimental results present a scenario considerably more likely to induce shear
50
51 208 failure by desorption as it would be the case using CH₄.

52 209 Second, various studies indicate changes in geomechanical parameters
53
54 210 with CO₂ sorption, including reduction of Young's modulus (Masoudian
55
56 211 et al., 2013, 2014; Hol et al., 2014), reduction of unconfined compression
57
58

1
2
3
4
5
6
7
8
9
212 strength (Czaplinski and Holda, 1982), enhanced creep (Hagin and Zoback,
10
213 2010) and microfracturing (Hol et al., 2012) when coal is exposed to CO₂
11
12
13
214 sorption. Although CO₂ may affect the coal matrix in ways that CH₄ may
14
15
215 not, our results show little affect of CO₂ sorption on the shear strength of
16
17
216 coal cores with natural fractures compared to dry coal. Similarly to coal
18
19
217 cores, the shear strength of the coal seam will be dominated by pre-existing
20
21
218 planes of weakness.

219 *4.2. Failure mechanism*

220 Let us evaluate the state of stresses of a representative elementary vol-
221
222 ume (REV) of a coal seam through its effective stress Mohr circle. Terzaghi's
223
224 effective stress (defined as $\sigma' = -(\sigma + p_c)$) is used since in this section we
225
226 at evaluating failure rather than deformation (Boutéca and Guéguen, 1999).
227
228 Figure 9 shows a series of steps that illustrate the proposed failure mecha-
229
230 nism. These steps are summarized as follows:

- 231
232 1. Assume the original conditions correspond to a normal faulting regime
233
234 such that the absolute value of total vertical stress σ_V is higher than
235
236 the maximum σ_{Hmax} and minimum horizontal stresses σ_{hmin} ($|\sigma_V| >$
237
238 $|\sigma_{Hmax}| > |\sigma_{hmin}|$) and that the effective stress anisotropy ratio σ'_V/σ'_h
239
240 is below the critical value for promoting shear failure (where horizontal
241
242 stresses are assumed to be the same $\sigma_h = \sigma_{Hmax} = \sigma_{hmin}$ for the sake
243
244 of simplicity).
- 245
246 2. Under zero-lateral strain condition, a fluid pressure reduction in the
247
248 fractures increases effective stresses σ'_V and σ'_h . According to linear
249
250 isotropic poroelasticity, the increases in Terzaghi's effective stress are

$\Delta\sigma'_V = -\Delta p_c$ and $\Delta\sigma'_h = [(1 - 2\nu)(1 - \nu)^{-1}\alpha - 1]\Delta p_c$, with α the Biot coefficient, ν the Poisson's ratio, and $\Delta p_c < 0$ the reservoir change in pressure due to depletion. Thus, the shear stress $(\sigma'_V - \sigma'_h)/2$ increases by $-\alpha(1 - 2\nu)[2(1 - \nu)]^{-1}\Delta p_c$ and the average stress $(\sigma'_V + \sigma'_h)/2$ increases by $\{\alpha(1 - 2\nu)[2(1 - \nu)]^{-1} - 1\}\Delta p_c$ upon reservoir depletion.

3. Desorption induces coal matrix shrinkage, which, given the zero-lateral strain condition, upscales as a reduction of compressive effective lateral stress $\Delta\sigma'_h$. If desorption takes place at constant gas pressure in the fractures, i.e., desorbed gas is quickly drained compared with desorption times, then the effective vertical stress remains constant, so that, only the lateral effective stress changes.
4. The lateral stress reduction induced by desorption increases stress anisotropy until a situation in which coal shear failure may occur, depending on the coal shear strength and initial pressure-stress conditions.

Our experiments (see Figure 7-c) show that the above proposed mechanism is quite likely to explain the stress path observed experimentally and the stress path that a coal seam in the field would go through upon depletion. Step 2 (poroelastic shrinkage) could not be measured in the laboratory because the CO₂ pressures upstream and downstream are regulated early to facilitate rapid desorption and set with a pressure gradient of about 1 MPa. The upper bound for fracture-induced poroelastic increase in maximum shear stress is $-\alpha(1 - 2\nu)[2(1 - \nu)]^{-1}\Delta p_c$. Consider $\nu = 0.3$ and $\alpha = 1$, the change in shear stress of specimen V2b upon depressurization of the cleat system ($\Delta p_c = 9$ MPa) should be at most ~ 2.6 MPa. Figure 7-c shows an increase of maximum shear stress of about 14 MPa, about five times higher than the

Stress path of coal seam REV far from the near-wellbore effects

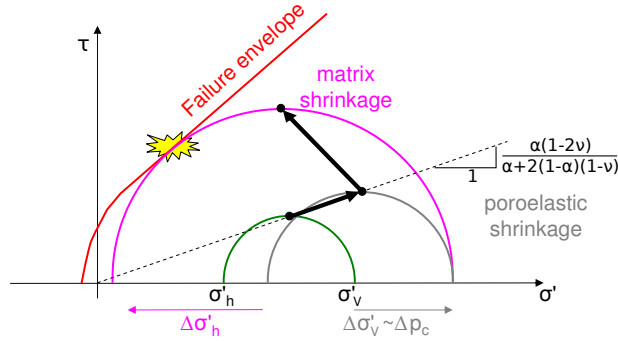

- 1 – Original normal faulting conditions $\sigma'_v > \sigma'_h$
- 2 – Rapid depressurization $\Delta\sigma'_v \sim \Delta p_c$; $\Delta\sigma'_h \sim [\alpha(1-2\nu)(1-\nu)^{-1}-1] \Delta p_c$
- 3 – Slow desorption $\Delta\sigma'_h < 0$ at $\epsilon_h \sim 0$
- 4 – Shear failure

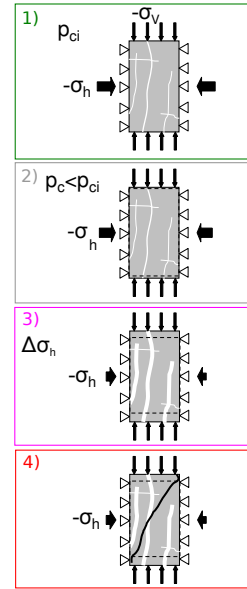

Figure 9: Mechanism for desorption-induced shear failure of coal seams in terms of effective stresses: 2-D Mohr circle representation and stress path.

value expected for poroelastic shrinkage, supporting the fact that desorption played a role decreasing the absolute value of radial stress. The absolute value of total radial stress measured in all experiments showed a clear and steady reduction at constant upstream/downstream pressure (CO_2 is drained as it desorbs - see Table 2). The resulting stress path (at constant fluid pressure) is a movement of the apex of the Mohr circle in direction up-left, which can only be explained by shrinkage of the solid skeleton, in this case driven by desorption-mechanical coupling.

4.3. Reservoir space analysis

The stress path of the coal reservoir can also be analyzed in terms of total stresses (see Figure 10). First, reservoir depletion under zero-lateral strain induces a poroelastic reduction of the absolute value of total lateral

1
2
3
4
5
6
7
8
9
10 273 stress equal to $\Delta\sigma_h = A\Delta p_c$ where $A = -\alpha(1 - 2\nu)/(1 - \nu)$ (positive when
11 274 compression stresses are assumed positive – Segall and Fitzgerald (1998)).
12
13 275 Next, desorption-induced shrinkage manifests itself as a decrease of lateral
14
15 276 stress at constant fluid pressure in fractures (assuming that desorbed gas
16
17 277 quickly drains through the fractures). The actual path (a combination of
18
19 278 both phenomena) would depend on the rate of transfer of fluid from the
20
21 279 matrix to the fractures, the permeability of fractures, and the distance of
22
23 280 the coal block to the wellbore. The likelihood to achieve failure depends on
24
25 281 the initial stress conditions, the initial pore pressure, the amount of sorbed
26
27 282 fluid, the drawdown pressure, and the adsorptive-mechanical properties of
28
29 283 the coal matrix. As regards initial stress conditions, coal seams in a normal
30
31 284 faulting environment would be more prone to shear failure by reduction of
32
33 285 lateral stresses than in a reverse or strike-slip faulting environment. Figure
34
35 286 10 highlights the fact that horizontal stresses can decrease significantly more
36
37 287 in sorbing rocks than in non-sorbing rocks subjected to depletion.

38 39 288 *4.4. Application to field conditions and impact of coal failure on seam per-* 40 41 289 *meability*

42
43 290 The experimental and modeling results presented in this study are valid
44
45 291 for zero-lateral strain condition with constant total vertical stress. Further
46
47 292 validation is needed in areas where boundary conditions are different, such
48
49 293 as near the wellbore, near hydraulic fractures if any, in the flanks of the
50
51 294 reservoir, and whenever stress overarching develops in the caprock. For ex-
52
53 295 ample, wellbore direction respect to the principal stresses would affect the
54
55 296 state of stresses near wellbore. Casing and perforations if any would also
56
57 297 modify the state of stresses near the wellbore. A coupled numerical solver is

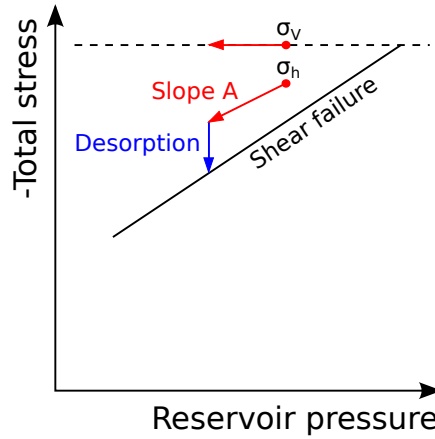

Figure 10: Reservoir space analysis of desorption-induced shear failure in coal seams subjected to depletion.

needed to analyze full scale well production and match modeling predictions to observations in the field at specific sites.

Shear failure in coal seams is not detrimental to permeability per se. For example, induced shear failure within chalk reservoirs in the North Sea is thought to be responsible for keeping high reservoir permeability in spite of significant matrix porosity reduction (Teufel et al., 1991). What is detrimental for permeability is the production of fines during shearing and the loss of hydraulic head due to fines clogging in originally clean fractures. Hence, reservoir management can be aimed at (1) managing fines by casing wellbores or screening the fines, or (2) finding the maximum drawdown pressure for which the coal seam does not fail in shear. Alternative (2) requires a poromechanical model which can capture the reduction of lateral stress induced by desorption (see Section 5).

In addition to CH_4 depletion, CO_2 injection may also induce coal shear failure (Palmer, 2008). In the context of the experimental evidence presented

1
2
3
4
5
6
7
8
9
10
11
12
13
14
15
16
17
18
19
20
21
22
23
24
25
26
27
28
29
30
31
32
33
34
35
36
37
38
39
40
41
42
43
44
45
46
47
48
49
50
51
52
53
54
55
56
57
58
59
60
61
62
63
64
65

313 here, this could be explained by an excessive increase of lateral stress induced
314 by adsorption which could lead to failure in reverse faulting stress regime
315 within the coal seam.

316 *4.5. Other chemo-thermo-mechanical couplings leading to lateral stress re-*
317 *laxation and induced shear failure*

318 Natural and anthropogenic lateral stress relaxation phenomena have been
319 observed in various cases. First, polygonal faults form in the absence of tec-
320 tonic stresses and are believed to originate from the volumetric contraction
321 of sedimentary layers; the mechanism of contraction has been linked to wa-
322 ter expulsion from the pore space upon overburden loading and thermal
323 contraction (Cartwright and Lonergan, 1996). Recent findings show that
324 mineral dissolution during rock diagenesis can contribute to a relaxation of
325 lateral stress in sedimentary basins (Shin et al., 2010). Second, cold water
326 injection in hot reservoirs causes thermal contraction. Thermal contraction
327 contributes to decrease lateral stresses. Evidence from enhanced geothermal
328 energy recovery sites shows significant induced seismicity caused by a com-
329 bination of rock cooling and reduction of effective stress with ensuing shear
330 slip of optimally oriented fractures (Majer et al., 2007). Sharp temperature
331 gradients may even induce open mode fractures and rock spalling (Dikken
332 and Niko, 1987).

333 **5. Geomechanical modeling**

334 Section 3 presents experimental evidence indicating that desorption under
335 zero-lateral strain condition leads to reduction of lateral stress, increased
336 stress anisotropy, and eventually to shear failure. Here we show a numerical

1
2
3
4
5
6
7
8
9
337 simulation of the experiment V2b (Figures 6 and 7) using a double porosity
10
338 poromechanical model with coal core and matrix parameters measured for
11
12 the same coal by Espinoza et al. (2014). We add an additional numerical
13
339 simulation of what would be expected for the same coal core subjected to
14
15
340 simulation of what would be expected for the same coal core subjected to
16
17
341 CH₄ desorption. The shear strength of “dry” coal measured in Section 3.1 is
18
19
342 used as an upper bound of the shear strength of coal that would be expected
20
21
343 for coal saturated with gas.

22 23 24 344 *5.1. Theoretical modeling*

25
345 We have developed a double porosity poromechanical model for trans-
26
27
346 verse isotropic coal seams (Nikoosokhan et al., 2012; Espinoza et al., 2014).
28
29
347 This model is based on the embedment of an adsorptive-mechanical model
30
31
348 of the coal matrix (which develops adsorption stresses s^a) into a larger frac-
32
33
349 tured poroelastic medium (the coal seam – with stiffness moduli C_{ij} and Biot
34
35
350 coefficients α_h and α_V relevant to transverse isotropy). Total seam horizon-
36
37
351 tal stress σ_h and vertical stress σ_V are affected by the strain tensor $\underline{\underline{\epsilon}}$, the
38
39
352 pore pressure in the cleats p_c , and the adsorption-strain coupling through the
40
41
353 adsorption stress s^a weighed by the Biot coefficients. The following applies
42
43
354 when horizontal stresses are the same in both directions.

$$44
45
46 \begin{cases} \sigma_h &= (C_{11} + C_{12})\epsilon_h + C_{13}\epsilon_V - \alpha_h p_c - (1 - \alpha_h)s^a(p_m) \\ \sigma_V &= 2C_{13}\epsilon_h + C_{33}\epsilon_V - \alpha_V p_c - (1 - \alpha_V)s^a(p_m) \end{cases} \quad (1)$$

47
48
49
50
355 The adsorption stress $s^a(p_m)$ developed by the coal matrix depends on
51
52
356 the amount of adsorbed fluid in the coal matrix $n_m(p_m, \epsilon_m)$ and swelling
53
54
357 properties of the coal matrix as follows,
55
56
57
58
59
60
61
62
63
64
65

$$s^a(p_m) = \int_0^{p_m} \left. \frac{\partial n_m}{\partial \epsilon_m} \right|_{p_m} \bar{V}_b(p_m) dp_m \quad (2)$$

where the thermodynamical pressure p_m is the pressure of the bulk fluid at the same chemical potential of the adsorbed phase in the coal matrix. $\bar{V}_b(p_m)$ is the molar volume of the fluid phase in bulk conditions. The amount of adsorption in the coal matrix n_m depends on fluid thermodynamical pressure p_m as well as on the coal matrix strain ϵ_m (Brochard et al., 2012). A first order approximation permits expressing this amount as

$$n_m(p_m, \epsilon_m) = n_{m0}(p_m) [1 + c(p_m)\epsilon_m] \quad (3)$$

where $n_{m0}(p_m)$ is the adsorption isotherm at zero volumetric strain, here approximated as a Langmuir type isotherm on pressure $n_{m0}(p_m) = n_0^{max}[p_m/(p_m + p_{L0})]$, and $c(p_m)$ is the adsorption-strain coupling coefficient. The coal seam poroelastic coefficients relate to initial cleat macroporosity ϕ_{c0} and the bulk modulus of the coal matrix K_m through micromechanical equations shown elsewhere (Espinoza et al., 2014).

The pressure p_m at the coal matrix can be different from the fracture cleat pressure p_c if the coal matrix and the seam are not in thermodynamical equilibrium. Reservoir depletion implies a change of fluid pressure in fractures Δp_c (fracture drainage) and a change in the coal matrix thermodynamical equilibrium pressure Δp_m (desorption). Under zero-lateral strain condition, the changes of lateral stresses and vertical strain are the following (Equation 1):

$$\begin{cases} \Delta\sigma_h &= \left(\frac{C_{13}}{C_{33}}\alpha_V - \alpha_h \right) \Delta p_c + \left[\frac{C_{13}}{C_{33}}(1 - \alpha_V) - (1 - \alpha_h) \right] \frac{ds^a(p_m)}{dp_m} \Delta p_m \\ \Delta\varepsilon_V &= \frac{1}{C_{33}}\alpha_V \Delta p_c + \frac{1}{C_{33}}(1 - \alpha_V) \frac{ds^a(p_m)}{dp_m} \Delta p_m \end{cases} \quad (4)$$

377 where

$$\begin{cases} \frac{C_{13}}{C_{33}} &= \frac{E\nu_3}{E_3(1-\nu)} \\ \frac{1}{C_{33}} &= \frac{1-\nu-2(E/E_3)\nu_3^2}{E_3(1-\nu)} \end{cases} \quad (5)$$

378 in terms of Young's modulus parallel to the bedding plane E , Poisson's ratio
 379 in the bedding plane ν , Young's modulus perpendicular to the bedding plane
 380 E_3 and Poisson's ratio in planes perpendicular to the bedding plane ν_3 .

381 Notice that both σ_h and ε_V depend on variations of the fluid pressure in
 382 the cleats Δp_c (conventional poroelastic path) and variations of fluid pressure
 383 in the coal matrix Δp_m (desorption path).

384 5.2. Model parameters

385 Previous work from the authors measured the adsorptive-mechanical prop-
 386 erties of the coal cores tested in this study (Espinoza et al., 2014). Table 3
 387 summarizes the best fitting parameters of the fully coupled double-porosity
 388 transverse isotropic poroelastic model introduced above.

389 5.3. Numerical simulation of CO_2 desorption experiment at zero-lateral strain 390 condition

391 Let us simulate experiment V2b shown in Figures 6 and 7. The experi-
 392 ment follows the loading path summarized in Table 4.

393 Event (4) depletion-desorption is decomposed into the variation of pres-
 394 sure in the cleats Δp_c and then coal matrix desorption Δp_m . Figure 11

1
2
3
4
5
6
7
8
9
10
11
12
13
14
15
16
17
18
19
20
21
22
23
24
25
26
27
28
29
30
31
32
33
34
35
36
37
38
39
40
41
42
43
44
45
46
47
48
49
50
51
52
53
54
55
56
57
58
59
60
61
62
63
64
65

Table 3: Parameters of poroelastic model for coal cores with dual porosity, i.e., cleat and coal matrix porosity.

Core scale	Matrix scale
$E = 2736$ MPa	$K_m = 5000$ MPa
$E_3 = 2551$ MPa	$n_0^{max} = 2.4$ mol/L (CO ₂)
$\nu = 0.267$	$p_{L0} = 1.6$ MPa (CO ₂)
$\nu_3 = 0.267$	$c = 11$ (CO ₂)
$\phi_{c0} = 0.08$	

Table 4: Desorption experimental pressure-stress path and boundary conditions for experiments V2b.

Event	Axial stress σ_r	Radial stress σ_a	Fluid pressure p_c
1) Dry loading to isotropic state of stress	0 to -12 MPa (Prescribed)	0 to -12 MPa (Prescribed)	None
2) CO ₂ injection and adsorption at constant confining stress	-12 MPa (Prescribed)	-12 MPa (Prescribed)	0 to 10 MPa (Prescribed)
3) Increase of stress anisotropy to the initial state of stress	-12 to -30 MPa (Prescribed)	-12 to -15 MPa (Prescribed)	10 MPa (Prescribed)
4) Depletion-desorption	-30 MPa (Prescribed)	variable to maintain $\Delta\varepsilon_r = 0$	10 to 1 MPa (Prescribed)

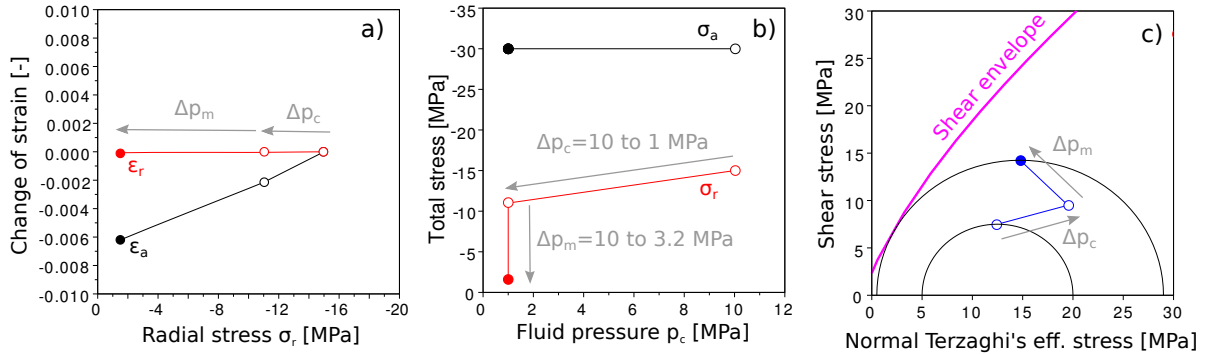

Figure 11: Numerical simulation of coal core depletion-desorption of CO₂ under zero-lateral strain condition. (a) Change of strains. (b) Total stresses. (c) Terzaghi's effective stress Mohr circle.

395 shows the numerical simulation results starting from event (4). Deformation
 396 is taken as a reference equal to zero at the beginning of event (4).

397 The pressure drawdown promotes gas drainage from fractures and gas
 398 desorption from the coal matrix. The poroelastic response of fractures is
 399 proportional to $\Delta p_c = -9$ MPa and promotes a shortening of the specimen
 400 $\Delta \epsilon_a = -0.002$, reduction of total radial stress $\Delta \sigma_r = -4$ MPa, and movement
 401 of the apex of the effective stress Mohr circle in up-right direction with a
 402 decrease of the maximum ratio of shear to normal effective stress. The effect
 403 of desorption is proportional to Δp_m . As p_m decreases, the specimen shortens
 404 further in vertical direction, radial stress becomes less compressive, and the
 405 apex of the effective stress Mohr circle moves in up-left direction. In Figure
 406 11, p_m varies from 10 MPa to 3.2 MPa. The thermodynamic pressure of the
 407 coal matrix cannot go lower because the core fails in shear at $p_m = 3.2$ MPa.
 408 Hence, the modeling results suggest that experiment V2b shown in Section
 409 3 would have failed for any drawdown pressure lower than ~ 3.2 MPa using

1
2
3
4
5
6
7
8
9
410 CO₂.

411 We simulate the loading path followed upon depressurization for all des-
412 orption experiments in zero-lateral strain condition. The simulation is based
413 on the initial stress and pressure conditions shown in Table 2 assuming that
414 cleat depressurization occurs first Δp_c and desorption follows Δp_m . The final
415 simulation pressure-stress point is chosen to be the point at which effective
416 stresses reach the Hoek-Brown criterion (Experiment V2a,V2b, and V3b) or
417 the point at which Terzaghi's radial effective stress becomes zero $\sigma_r + p_c = 0$
418 (Experiment V3a). The latter condition reflects the fact that the radial con-
419 fining pressure (radial stress) cannot be set lower than the fluid pressure
420 experimentally because the fluid would escape into the confining fluid.

421 Table 5 summarizes the values of cleat pressure, radial stress and thermo-
422 dynamic pressure in the coal matrix at the final pressure-stress simulation
423 point. The simulation predicts shear failure for experiment V2a as opposed
424 to what is observed experimentally, although the difference between p_{mf} and
425 p_{cf} is small suggesting that the model was not too far from predicting the
426 right value. Experiment V3a starts with a low axial stress, thus it is not
427 expected to fail even if lateral stress goes to zero, however, numerical sim-
428 ulation help calculate the reduction in lateral stress to near zero effective
429 lateral stress as observed experimentally. The model does predict the shear
430 failure of experiments V2b and V3b. Furthermore, the numerical simula-
431 tion suggests that these experiments were ended (because of shear failure)
432 significantly before achieving thermodynamical equilibrium $p_{mf} > p_{cf}$.

Table 5: List of simulated CO₂ zero-lateral strain desorption experiments: final pressure-stress conditions. Initial conditions are described in Table 2.

Simulated Experiment	Final pressure in cleats p_{cf} [MPa]	Predicted radial radial stress at the end of the test σ_{rf} [MPa]	Predicted coal matrix fluid pressure at the end of the test p_{mf} [MPa]	Hoek-Brown criterion achieved? Shear failure [Y/N]
V2a	1.0	-1.0	1.6	Y
V3a	0.5	-0.5	3.5	N
V2b	1.0	-1.5	3.2	Y
V3b	1.0	-1.5	3.2	Y

5.4. Numerical simulation of analogous desorption experiment with CH₄

Let us now simulate what the response of an analogous experiment using CH₄ would be. We roughly assume that coal would swell about a third as much with CH₄ compared to CO₂ at the same fluid pressure (see Section 4.1). Hence, we approximate the parameters of the coal matrix with $n_0^{max} = 1.2$ mol/L and $c = 6$. The simulation follows the path stipulated in Table 4 and the results are shown in Figure 12. Clearly there is less pronounced reduction of radial stress due to desorption in this case compared to the case with CO₂ desorption. As expected, the fracture poroelastic response is exactly the same in both cases.

The model predicts that shear failure does not occur with CH₄ given the initial pressure-stress conditions, even though p_m reaches the drawdown pressure $p_m = p_c = 1$ MPa. Field scale seams have negligible unconfined compression strength, hence, the friction strength of fractures could be chal-

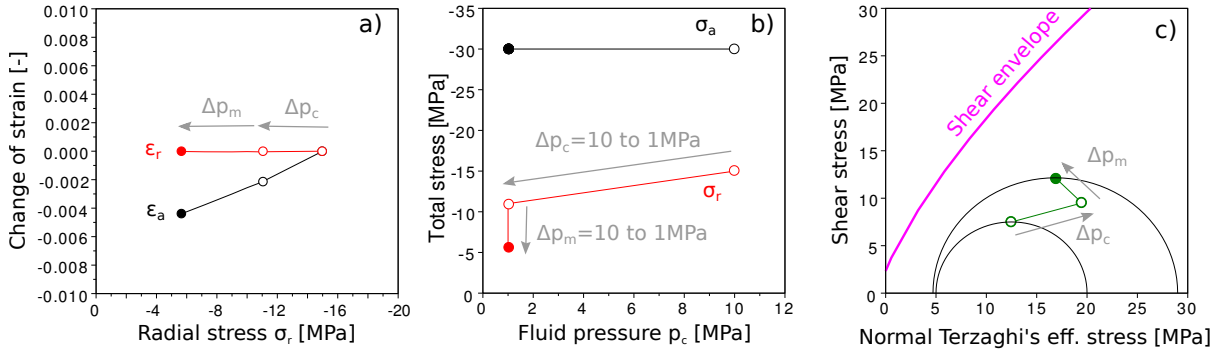

Figure 12: Numerical simulation of coal core depletion-desorption of CH₄ under zero-lateral strain condition. (a) Change of strains. (b) Total stresses. (c) Terzaghi's effective stress Mohr circle.

lenged by change of stresses induced by desorption. Even with CH₄, the increase of stress anisotropy and movement of the apex of the Mohr circle in up-left direction may induce state of stress with ratio of shear stress to effective normal stress high enough to promote shear failure of existent fractures and fines production.

6. Conclusions

Deep coal beds have unique transport and mechanical properties, and hence, they require particular completion and production strategies. Desorption-induced coal shrinkage is advantageous because it increases permeability upon depletion. Yet, extensive coal mechanical failure and fracture plugging with fines has sometimes been observed after steep increases of permeability. It is known that near-wellbore stress concentration and fracture poroelastic response help increase stress anisotropy in the reservoir rock upon depletion and may favor shear failure. Far from the wellbore, the coal seam is

1
2
3
4
5
6
7
8
9
10 461 expected to follow compression under zero-lateral strain and constant total
11 462 vertical stress. At this condition, we show through triaxial experiments that
12
13 463 reduction of lateral stress induced by the shrinkage of the coal matrix during
14
15 464 gas desorption can significantly favor coal shear failure far from the well-
16
17 465 bore. Performed tests show a clear increase of stress anisotropy induced by
18
19 466 desorption, in some cases leading to shear failure.

20
21 467 The stress path under zero-lateral strain condition depends on variations
22
23 468 of pore pressure in the coal cleats and on variations of stresses caused by gas
24
25 469 desorption from the coal matrix. In general, two parts of the stress path can
26
27 470 be recognized: (1) conventional stress path characterized by the poroelastic
28
29 471 coefficient $\alpha(1 - 2\nu)/(1 - \nu)$ and induced by variation of the fluid pressure
30
31 472 in the cleats p_c , and (2) desorption-induced decrease in lateral stress defined
32
33 473 by the adsorptive-mechanical properties of the coal matrix and promoted by
34
35 474 a variation of adsorption stress in the coal matrix. The steep slope of the
36
37 475 desorption-induced path can reach the failure envelope and promote shearing
38
39 476 sooner than would happen for a conventional non-adsorptive reservoir rock.

40 477 Coal failure can be predicted by knowing the original state of stresses,
41
42 478 coal shear failure envelope, and the mechanical-adsorptive properties of the
43
44 479 coal. We developed a model that links all these variables and showed its
45
46 480 application to match laboratory experiments. Coupled numerical simula-
47
48 481 tion considering more realistic boundary conditions and completion details
49
50 482 is needed to validate our findings to specific field observations. To the best of
51
52 483 our knowledge, this is the first model that offers a consistent analysis on the
53
54 484 depletion of coal seams and ensuing failure, incorporating explicitly a stress
55
56 485 path solely due to desorption.

1
2
3
4
5
6
7
8
9
486 **Acknowledgements**

10
11
487 This work was supported by Total S.A. The technical support provided
12
13
488 by E. De Laure and his team at Laboratoire Navier-CERMES is greatly
14
15
489 appreciated. We are thankful to N. Lenoir for providing the X-ray images
16
17
490 and to S. Hol and an anonymous reviewer for insightful comments that helped
18
19
491 improving this manuscript.
20
21
22

23
24
492 **7. Symbols**

25
26
27
28
29
30
31
32
33
34
35
36
37
38
39
40
41
42
43
44
45
46
47
48
49
50

α	Biot coefficient [-]
ε	Strain [-]
ϕ_c	Macroporosity [-]
μ	Friction coefficient [-]
ν	Poisson's ratio [-]
σ	Total stress [Pa]
493 σ'	Effective stress [Pa]
τ	Shear stress [Pa]
A	Poroelastic depletion slope [-]
C_{ij}	Stiffness tensor coefficient [-]
E	Young's modulus [E]
p_m	Thermodynamical pressure of the coal matrix [Pa]
p_c	Pressure in cleats [Pa]

51
52
53
494 **References**

54
55
495 Boutéca, M., Guéguen, Y., 1999. Mechanical properties of rocks: pore pres-
56
57
496 sure and scale effects. Oil & Gas Science and Technology Rev. IFP 54,
58
59
60
61
62
63
64
65

- 1
2
3
4
5
6
7
8
9
497 703–714.
- 10
11
12 498 Brochard, L., Vandamme, M., Pellenq, R.J.M., 2012. Poromechanics of mi-
13
14 499 croporous media. *Journal of the Mechanics and Physics of Solids* 60, 606–
15
16 500 622.
- 17
18 501 Cartwright, J.A., Lonergan, L., 1996. Volumetric contraction during the com-
19
20 502 paction of mudrocks: a mechanism for the development of regional-scale
21
22 503 polygonal fault systems. *Basin Research* 8, 183–193. doi:10.1046/j.1365-
23
24 504 2117.1996.01536.x.
- 25
26 505 Ceglarska-Stefanska, G., Czaplinski, A., 1993. Correlation between sorption
27
28 506 and dilatometric processes in hard coals. *Fuel* 72, 413–417.
- 29
30
31 507 Chikatamarla, L., Bustin, R., Cui, X., 2009. CO2 sequestration into coalbeds:
32
33 508 insights from laboratory experiments and numerical modeling, in: Grobe,
34
35 509 M., Pashin, J.C., Dodge, R.L. (Eds.), *Carbon dioxide sequestration in*
36
37 510 *geological media - State of the science: AAPG Studies in Geology* 59, pp.
38
39 511 457–474.
- 40
41 512 Czaplinski, A., Holda, S., 1982. Changes in mechanical properties of coal
42
43 513 due to sorption of carbon dioxide vapour. *Fuel* 61, 1281–1282.
- 44
45
46 514 Dikken, B., Niko, H., 1987. Waterflood-induced fractures: a simulation
47
48 515 study of their propagation and effects on waterflood sweep efficiency,
49
50 516 in: *Proceedings of Offshore Europe*, Society of Petroleum Engineers.
51
52 517 doi:10.2118/16551-MS.
- 53
54 518 EIA, 2013. *International Energy Outlook 2013 - Report number: DOE/EIA-*
55
56 519 *0484(2013)*. Technical Report.

- 1
2
3
4
5
6
7
8
9
520 Espinoza, D.N., Vandamme, M., Dangla, P., Pereira, J.M., Vidal-Gilbert, S.,
11 2013. A transverse isotropic model for microporous solids - Application
12 to coal matrix adsorption and swelling. *Journal of Geophysical Research -*
13 *Solid Earth* 118, 6113–6123.
14
15
16
17
18 524 Espinoza, D.N., Vandamme, M., Pereira, J.M., Dangla, P., Vidal-Gilbert, S.,
19 2014. Measurement and modeling of adsorptive-poromechanical proper-
20 ties of bituminous coal cores exposed to CO₂: adsorption, swelling strains,
21 swelling stresses and impact on fracture permeability. *International Jour-*
22 *nal of Coal Geology* doi:10.1016/j.coal.2014.09.010.
23
24
25
26
27
28 529 Goult, N.R., 2003. Reservoir stress path during depletion of Norwegian chalk
29 oilfields. *Petroleum Geoscience* 9, 233–241. doi:10.1144/1354-079302-545.
30
31
32
33 531 Hagin, P., Zoback, M.D., 2010. Laboratory studies of the compressibility
34 and permeability of low-rank coal samples from the Powder River Basin,
35 Wyoming, USA, in: ARMA 10-170.
36
37
38
39 534 Hol, S., Gensterblum, Y., Massarotto, P., 2014. Sorption and changes in
40 bulk modulus of coal experimental evidence and governing mechanisms
41 for CBM and ECBM applications. *International Journal of Coal Geology*
42 128-129, 119–133. doi:10.1016/j.coal.2014.04.010.
43
44
45
46
47
48 538 Hol, S., Spiers, C.J., Peach, C.J., 2012. Microfracturing of coal due to inter-
49 action with CO₂ under unconfined conditions. *Fuel* 97, 569–584.
50
51
52
53 540 IEA, 2013. Key world energy statistics 2013. Technical Report.
54
55
56 541 Laubach, S.E., Marrett, R.A., Olson, J.E., Scott, A.R., 1998. Characteristics

- 1
2
3
4
5
6
7
8
9
10 542 and origins of coal cleat: A review. *International Journal of Coal Geology*
11 543 35, 175–207.
- 12
13
14 544 Levine, J.R., 1996. Model study of the influence of matrix shrinkage on
15 absolute permeability of coal bed reservoirs. Geological Society, London,
16 Special Publications 109, 197–212. doi:10.1144/gsl.sp.1996.109.01.14.
17
18 546
- 19
20 547 Majer, E.L., Baria, R., Stark, M., Oates, S., Bommer, J., Smith,
21 B., Asanuma, H., 2007. Induced seismicity associated with
22 Enhanced Geothermal Systems. *Geothermics* 36, 185–222.
23
24 549 doi:10.1016/j.geothermics.2007.03.003.
25
26 550
- 27
28 551 Masoudian, M., Airey, D., El-Zein, A., 2013. A chemo-poro-mechanical
29 model for sequestration of carbon dioxide in coalbeds. *Geotechnique* 63,
30
31 552 235–243.
32
33
- 34
35 554 Masoudian, M.S., Airey, D.W., El-Zein, A., 2014. Experimental investiga-
36 tions on the effect of CO₂ on mechanics of coal. *International Journal of*
37
38 555 *Coal Geology* 128-129, 12–23. doi:10.1016/j.coal.2014.04.001.
39
40 556
- 41 557 Mazumder, S., Karnik, A., Wolf, K.H., 2006. Swelling of coal in response to
42 CO₂ sequestration for ECBM and its effect on fracture permeability. *SPE*
43
44 558 *Journal* 11, 390–398.
45
46 559
- 47
48 560 Mitra, A., Harpalani, S., Liu, S., 2012. Laboratory measurement and model-
49 ing of coal permeability with continued methane production: Part 1 Lab-
50
51 561 oratory results. *Fuel* 94, 110–116. doi:10.1016/j.fuel.2011.10.052.
52
53 562
- 54 563 Moore, R.L., Loftin, D., Palmer, I., 2011. History matching and permeability
55 increases of mature coalbed methane wells in San Juan Basin, in: *SPE Asia*
56
57 564

- 1
2
3
4
5
6
7
8
9
565 Pacific Oil and Gas Conference and Exhibition, 20-22 September, Jakarta,
10
566 Indonesia.
- 11
12
13
567 Nikoosokhan, S., Vandamme, M., Dangla, P., 2012. A poromechanical model
14
568 for coal seams injected with carbon dioxide: from an isotherm of adsorption
15
16
17
569 to a swelling of the reservoir. *Oil & Gas Science and Technology Rev. IFP*,
18
19
570 *Energies nouvelles* 67, 777–786.
- 20
21
22
571 Nikoosokhan, S., Vandamme, M., Dangla, P., 2014. A poromechanical
23
572 model for coal seams saturated with binary mixtures of CH₄ and
24
25
573 CO₂. *Journal of the Mechanics and Physics of Solids* 71, 97–111.
26
27
574 doi:10.1016/j.jmps.2014.07.002.
- 28
29
30
575 Okotie, V.U., Moore, R.L., 2010. Well Production challenges and solutions
31
32
576 in a mature, very low-pressure coalbed methane reservoir, in: *Canadian*
33
34
577 *Unconventional Resources and International Petroleum Conference*, 19-21
35
36
578 October, Calgary, Alberta, Canada.
- 37
38
39
579 Palmer, I., 2008. Failure during CO₂ injection in the field, in: *Coal-seq VI*,
40
41
580 April 10-11, Houston, Texas.
- 42
43
44
581 Palmer, I., Mansoori, J., 1998. How permeability depends on stress and pore
45
46
582 pressure in coalbeds: A new model. *Evaluation* , 539–544.
- 47
48
49
583 Pan, Z., Connell, L.D., 2011. Modelling of anisotropic coal swelling and
50
584 its impact on permeability behaviour for primary and enhanced coalbed
51
52
585 methane recovery. *International Journal of Coal Geology* 85, 257–267.
53
54
586 doi:10.1016/j.coal.2010.12.003.
- 55
56
57
58
59
60
61
62
63
64
65

- 1
2
3
4
5
6
7
8
9
587 Pan, Z., Connell, L.D., 2012. Modelling permeability for coal reservoirs: A
10 review of analytical models and testing data. *International Journal of Coal*
11 *Geology* 92, 1–44. doi:10.1016/j.coal.2011.12.009.
12
13
14
15
16
590 Pan, Z.J., Connell, L.D., 2007. A theoretical model for gas adsorption-
17 induced coal swelling. *International Journal of Coal Geology* 69, 243–252.
18
19
20
592 Pini, R., 2009. Enhanced coal bed methane recovery finalized to carbon
21 dioxide storage. Ph.D. thesis. ETH Zurich.
22
23
24
25
594 Reucroft, P.J., Sethuraman, A.R., 1987. Effect of pressure on carbon dioxide
26 induced coal swelling. *Energy Fuels* 1, 72–75.
27
28
29
30
596 Segall, P., Fitzgerald, S.D., 1998. A note on induced stress changes in hy-
31 drocarbon and geothermal reservoirs. *Tectonophysics* 289, 117–128.
32
33
34
598 Shin, H., Santamarina, J.C., Cartwright, J.A., 2010. Displacement field in
35 contraction-driven faults. *Journal of Geophysical Research* 115.
36
37
38
39
600 Teufel, L.W., Rhett, D.W., Farrell, H.E., 1991. Effect of reservoir deple-
40 tion and pore pressure drawdown on in situ stress and deformation in
41 the Ekofisk field, North Sea, in: *Rock Mechanics as a Multidisciplinary*
42 *Science*, Roegiers (ed), pp. 63–72.
43
44
45
46
47
604 Zoback, M.D., 2013. *Reservoir geomechanics*. Cambridge University Press,
48
49
605 New York.