



HAL
open science

Sequential management of optimally-designed thermal storage tanks for multi-energy district boilers

Mouchira Labidi, Julien Eynard, Olivier Faugerox, Stéphane Grieu

► To cite this version:

Mouchira Labidi, Julien Eynard, Olivier Faugerox, Stéphane Grieu. Sequential management of optimally-designed thermal storage tanks for multi-energy district boilers. *Applied Thermal Engineering*, 2014, 73 (1), pp.253-266. 10.1016/j.applthermaleng.2014.07.038 . hal-01118300

HAL Id: hal-01118300

<https://hal.science/hal-01118300v1>

Submitted on 18 Feb 2015

HAL is a multi-disciplinary open access archive for the deposit and dissemination of scientific research documents, whether they are published or not. The documents may come from teaching and research institutions in France or abroad, or from public or private research centers.

L'archive ouverte pluridisciplinaire **HAL**, est destinée au dépôt et à la diffusion de documents scientifiques de niveau recherche, publiés ou non, émanant des établissements d'enseignement et de recherche français ou étrangers, des laboratoires publics ou privés.

Sequential management of optimally-designed thermal storage tanks for multi-energy district boilers

Mouchira Labidi^{a,b}, Julien Eynard^{b,c}, Olivier Faugoux^{b,c}, Stéphane Grieu^{b,c,*}

^a*Cylergie, Cofely GDF-Suez Research and Development Centre, 18 Avenue Tony Garnier, 69007 Lyon, France*

^b*PROMES-CNRS, Rambla de la Thermodynamique, Tecnosud, 66100 Perpignan, France*

^c*University of Perpignan Via Domitia, 52 Avenue Paul Alduy, 66860 Perpignan, France*

Abstract

As part of the second phase of the OptiEnR research project, the present work focuses on optimizing multi-energy district boilers by adding thermal storage tanks to the plants. First, both a parametric study and a simulation-based evaluation of the thermal losses are carried out in order to design the hot water tanks. Next, a sequential management approach, based on the power demand and the characteristics of the biomass unit(s), is defined with the aim of improving efficiency. Energy and economic criteria are proposed and evaluated in order to highlight the configurations that meet needs and expectations. The way thermal energy storage impacts on the boiler units dynamics is evaluated in simulation. Finally, the proposed approach has been applied to two multi-energy district boilers equipped with one and two biomass units, respectively. The plants are managed by Cofely GDF-Suez, our industrial partner in the project. The results highlight the ability of a hot water tank (when it is optimally designed and managed) to improve the operation of a multi-energy district boiler and realize significant economic savings. As a key point, the excess of energy produced by the biomass unit(s) during low-demand periods can be stored and released when demand is high, instead of engaging a gas boiler.

Keywords: Multi-energy district boiler, biomass boiler, gas boiler, thermal energy storage, heat network, optimal design, sequential management strategy, energy efficiency, economic analysis.

1. Introduction

In 2010, the final residential energy consumption accounted for about 26% of the total energy consumption in the European Union of 27 member states (EU-27). In addition, the final residential gas consumption increased by around 52% between 1990 and 2010. So, residential energy consumption is one of the fastest growing areas of energy use, in particular in developed countries. The residential sector plays therefore a significant role in energy efficiency programs and policies. Little of the energy efficiency potential in this sector has been captured, due to characteristics of markets, technologies, and end users that inhibit rational choices in building construction and appliance purchase and use [1]. Appliances and equipment include domestic and district boilers for thermal energy distribution [2]. Using biomass materials, such as wood, in residential (as well as in industrial) heating [3] can significantly reduce the reliance on fossil fuels and limit CO₂ emissions [4]. The EU-27 commission's recent report on the sustainability of biomass affirmed that the most type of biomass for heating and power applications can reduce such emissions by 55 to 98%. Several techno-economic analysis show that biomass is also cheaper than many fossil fuels commonly used for heating, mainly gas

and oil. In [5], Lauri et al. assessed the economic potential of substituting wood for coal in large scale heat and power production. Furthermore, government financial incentives could improve the economic performance of heating using biomass. Today this potential is only being realized at a slow pace in Europe. As a result, ambitious and flexible strategies are needed in order to increase the use of such an energy resource in the residential sector [6].

Another key point in the search for energy efficiency is Thermal Energy Storage (TES). TES is an attractive technology which can facilitate energy savings and reduce environmental impact. TES systems can be installed as either centralized or distributed devices. They improve the energy efficiency of industrial or residential processes by storing waste or by-product heat or renewable heat when it is available and supplying it by demand. TES systems can also help to improve efficiency in district heating plants, especially in case of badly-sized heat-generating systems. Tanaka et al. [7] showed that a seasonal storage system can decrease the energy consumption by about 26% in a District Heating and Cooling (DHC) plant. As another interesting work, Smith et al. [8] highlighted the benefits of storing thermal energy, in combination with CHP (Combined Heat and Power) technology. In 2011, Verda and Colella [9] estimated the effects of thermal energy storage on both the primary energy consumption and cash flows in district heating networks. Gustafsson and Karlsson [10] showed how a thermal storage system can be used

*Corresponding author

Email address: stephane.grieu@promes.cnrs.fr (Stéphane Grieu)

in a CHP plant for decreasing both the district heating demand and the electricity consumption. In [11], the way CHP plants can be optimally designed is discussed and a parametric analysis approach is proposed. Taljan et al. [12] as well as Martinez-Lera et al. [13] also discussed about the design of thermal storage tanks for CHP systems. In [14], the feasibility of CHP plants with thermal storage in the German spot market is analyzed. All these works share the same conclusion: by adding a thermal storage system, CHP plants gain in flexibility and may achieve improved economic results, if managed properly. Adding a seasonal heat storage to solar heating systems is also a topic addressed by many research works. First, Heller [15] made in 2000 a survey of 15 years of research and development activities in the field of solar heating plants and thermal energy storage technologies in Denmark. Kozai et al. [16] studied the thermal performance of a solar green house equipped with a water thermal storage tank. In 2008, Ucar and Inally [17] showed that a solar heating system with seasonal storage can be used in building heating efficiently. A case study dealing with such a system (a central solar heating plant with seasonal heat storage) is discussed in [18]. Finally, Rodríguez-Hidalgo et al. highlighted in [19] that size, for thermal storage applications, impacts solar plants performance in a significant way.

Taking a look at the state of the art about the design of thermal storage tanks, one can highlight different approaches. Usually, from an industrial point of view, engineers consider simplistic rules. Australian engineers go for 50 liters per kW of fuel boiler power while, in the United Kingdom, engineers tend to consider 10 to 20 liters per kW of fuel boiler power [20]. This approach allow an approximative size for a given thermal storage tank to be found but design is of course not optimal. Another commonly used approach consists in minimizing the necessary thermal capacity using a segmental integral method based on the load graph of a plant [21, 22]. In addition, when there are several boiler units in a district plant, a load assignment program can be used to define an operating scheme or mode for such plant. A few decades ago, George et al. [23] and Kirchmayer [24] developed both the principle of optimal load assignment and the theory of coordination of incremental fuel costs. These approaches do not take often into account the demand profiles and the equipments characteristics. Furthermore, they were only applied to a case study. Other researchers have developed more complex approaches based on optimization routines or specific simulation softwares to design thermal storage tanks. In particular, Lozano et al. [25] proposed in 2010 an optimization model, based on Mixed Integer Linear Programming (MILP), in order to determine the preliminary design of CHP systems with thermal energy storage. In [26], Rubio-Maya et al. proposed a sequential optimization procedure for polygeneration units. As another interesting approach, Rong et al. [27] proposed a Lagrangian relaxation based algorithm for trigeneration planning with energy storage. Such an approach is based on a deflected sub-gradient op-

timization method. In 2008, Fragaki et al. [28] used the energyPRO software for modelling energy systems, in particular CHP plants, and sizing thermal stores. In [29], the same tool has been used to develop investment and operation strategies for almost all small CHP plants in Denmark. These approaches are directed even more toward a common point: the optimal size of a thermal storage tank can be found (or reached) but an extensive calculation is often needed. Of course, the inadequate design of thermal storage tanks can lead to several difficulties and limitations. In 2001, Palmer et al. highlighted that badly-sized thermal storage tanks combined with oversized biomass systems tend to reduce energy efficiency in a significant way [30]. An oversized tank is a non-profitable financial investment while an undersized one cannot be efficient (as a result, improvement of performance is low). On the other hand, an optimally-designed thermal storage tank has enormous potential to improve effectiveness in using thermal equipment and economic large-scale substitution.

Considering TES for multi-energy district boilers, which is a rational and efficient solution to provide heat and hot water to buildings, is an innovative approach. Such an approach can demonstrate its effectiveness as an alternative way to maximize the profits from wood exploitation and thus reduce the use of fossil energy. In multi-energy district boilers equipped with thermal storage systems, a part of the energy produced by the combustion of wood can be stored when demand is lower than production and released later to meet needs during peak load periods (instead of consuming fossil energy). Thus, this kind of system, based on thermal stratification [31, 32], is more than just a hot water cylinder and, if it is properly managed, it enables biomass boilers to meet a greater proportion of the annual power requirements. It is also likely to offer protection to the boilers and improve the overall efficiency of a plant. In France, this concept is still under development and the main question that arises is how the optimal design of a thermal storage tank, for a given multi-energy district boiler, can be defined? In addition, in what way the whole system (i.e. the boiler units and the tank) can be managed efficiently? The design of a thermal storage system as well as its optimal management using a predictive controller has been studied for a particular case (a multi-energy district boiler situated in northwest France) during the first phase of the OptiEnR research project (2007-2010), on the basis of the annual consumption of fossil energy [33, 34, 35]. We demonstrated, thanks to the tank we designed and the accurate forecasting of power demand (we used a wavelet-based multi-resolution analysis and feedforward artificial neural networks) [36], that the consumption of gas can be partially balanced by the release of the thermal energy previously stored. The second phase of the project (2011-2014) aims first at generalizing the design approach, considering representative collective boilers and evaluating the thermal losses. It also deals with proposing an easy-to-adapt management strategy based on both the power demand and the characteristics of the

biomass boiler(s). We decided for a sequential approach. Finally, the paper is organized as follows: in the next section (i.e. section 2), a stratified tank model, adapted from the “turbulent mixing model” [37, 38], is presented. Its resolution allows the water temperature for each of the tank layers to be accurately estimated. This section of the paper is also about the proposed design methodology, based on a complete parametric analysis. In the third section, a sequential management approach for multi-energy district boilers (equipped or not with hot water tanks) and based on three operation modes is presented. Then, energy and economic criteria are proposed as performance indicators (section 4). Next, both the design methodology and the sequential management approach are applied in simulation to two case studies (sections 5 and 6). We considered two plants situated in southwest and northwest France equipped with one and two biomass boilers, respectively. These multi-energy district boilers are managed by french company Cofely GDF-Suez, our industrial partner in the project. For each plant, we highlighted an optimal configuration, on the basis of both the characteristics of the biomass unit(s) and the power demand. The key results are summarized in section 7. The paper ends with a conclusion and outlook on further work (section 8).

2. Design methodology

2.1. Overview

In multi-energy district boilers, biomass units (characterized by a minimum and a maximum power denoted P_{WB}^{min} and P_{WB}^{max} , respectively) are usually designed (sized) in order to meet the major part of the power demand but are not able to cover the peak loads [39]. As a result, auxiliary gas boilers are switched on in order to cope with the power demand during the coldest periods of the year, in case of maintenance activities or if such a demand is lower than the minimum biomass power (P_{WB}^{min}). As stated above, the main purpose of the present work is to improve operation and, as a result, performance, first by adding optimally-designed thermal storage tanks to multi-energy district boilers and, secondly, by managing these tanks adequately. So, the proposed design methodology is based on three different steps. First, for a given plant managed by Cofely GDF-Suez, a range of possible tank sizes is defined, according to both the availability of space on site and economic considerations. The effect on performance of thermal insulation is also evaluated using the mathematical model of the stratification process we developed (section 2.2). Then, the sequential management approach we developed (depicted in section 3) is applied to the considered plant. Finally, an economic and energy evaluation is carried out in order to highlight the optimal design of the tank and explore the feasibility of the proposed scheme for investment purposes. At each time step of the simulation (one hour), the biomass power, the gas power and the amount of energy stored in the tank or released are determined in order to highlight the dynamics of the plant.

2.2. Thermal stratification modelling

In order to investigate the main factors leading to thermal losses, a model describing the thermal stratification process that takes place in the hot water tank has been developed. In particular, we investigated the way both the ratio of Height to Diameter (H/D) and the characteristics of the insulating material impact on thermal losses in static mode (in this mode, no water is flowing through the tank). Unlike simplistic models in which temperature is supposed to be uniform throughout the volume of the tank, the proposed discrete space model, adapted from the “turbulent mixing model” [37, 38], takes into account the existing temperature gradient. The storage tank is divided into N equal volume layers. When thermal energy is stored (Eq. 1, 2, 3 and 4), hot water is allowed to enter by the top of the tank and is assumed to mix with the m first top layers. $T_{i,k}$ is the temperature of the i^{th} layer of water, T_k^{amb} is the ambient temperature and T_k^{in} is the inlet fluid temperature, at time index k . N is the number of layers, m is the number of layers directly affected by T_k^{in} , V is the volume of a layer of water while ΔV is the volume of fluid passing through the tank during one sampling time. $i = 1$ is the index of the layer located at the bottom of the tank and $i = N$ is the index of the top layer:

$$T_{i,k+1} = \left(\frac{1}{\alpha_1}\right) \cdot \left[\left(V - \frac{\Delta V}{m}\right) \cdot T_{i,k} + \frac{\Delta V}{m} \cdot T_k^{in} + \beta_1 \cdot T_k^{amb} \right] + \gamma \cdot (T_{i+1,k} - T_{i,k}), \text{ for } i = 1 \text{ (bottom layer)} \quad (1)$$

$$T_{i,k+1} = \left(\frac{1}{\alpha}\right) \cdot \left[\left(V - \frac{\Delta V}{m}\right) \cdot T_{i,k} + \frac{\Delta V}{m} \cdot T_k^{in} + \beta \cdot T_k^{amb} \right] + \gamma \cdot (T_{i-1,k} - 2T_{i,k} + T_{i+1,k}), \text{ for } 1 < i \leq m \quad (2)$$

$$T_{i,k+1} = \left(\frac{1}{\alpha}\right) \cdot \left[(V - \Delta V) \cdot T_{i,k} + \Delta V \cdot T_{i-1,k} + \beta \cdot T_k^{amb} \right] + \gamma \cdot (T_{i-1,k} - 2T_{i,k} + T_{i+1,k}), \text{ for } m < i < N \quad (3)$$

$$T_{i,k+1} = \left(\frac{1}{\alpha_N}\right) \cdot \left[(V - \Delta V) \cdot T_{i,k} + \Delta V \cdot T_{i-1,k} + \beta_N \cdot T_k^{amb} \right] + \gamma \cdot (T_{i-1,k} - T_{i,k}), \text{ for } i = N \text{ (top layer)} \quad (4)$$

In discharging (release) mode (Eq. 5, 6, 7 and 8), the process described above is reversed. So, cold water is allowed to enter by the bottom of the tank and is assumed to mix with the m first bottom layers. Heat loss by conduction through the walls, heat loss by convection with the ambient air, conduction between layers as well as inlet and outlet thermal mixing are taken into account. The model resolution allows the temperature of the water in each layer of the tank to be calculated:

$$T_{i,k+1} = \left(\frac{1}{\alpha_1}\right) \cdot \left[(V - \Delta V) \cdot T_{i,k} + \Delta V \cdot T_{i+1,k} + \beta_1 \cdot T_k^{amb} \right] + \gamma \cdot (T_{i+1,k} - T_{i,k}), \text{ for } i = 1 \text{ (bottom layer)} \quad (5)$$

$$T_{i,k+1} = \left(\frac{1}{\alpha}\right) \cdot \left[\left(V - \frac{\Delta V}{m} \right) \cdot T_{i,k} + \frac{\Delta V}{m} \cdot T_k^{in} + \beta \cdot T_k^{amb} \right] + \gamma \cdot (T_{i-1,k} - 2T_{i,k} + T_{i+1,k}), \text{ for } N - m < i < m \quad (6)$$

$$T_{i,k+1} = \left(\frac{1}{\alpha}\right) \cdot \left[\left(V - \Delta V \right) \cdot T_{i,k} + \Delta V \cdot T_{k+1,i} + \beta \cdot T_k^{amb} \right] + \gamma \cdot (T_{i-1,k} - 2T_{i,k} + T_{i+1,k}), \text{ for } 1 < i \leq N - m \quad (7)$$

$$T_{i,k+1} = \left(\frac{1}{\alpha_N}\right) \cdot \left[\left(V - \frac{\Delta V}{m} \right) \cdot T_{i,k} + \frac{\Delta V}{m} \cdot T_k^{in} + \beta_N \cdot T_k^{amb} \right] + \gamma \cdot (T_{i-1,k} - T_{i,k}), \text{ for } i = N \text{ (top layer)} \quad (8)$$

α (Eq. 9), β (Eq. 10), α_1 ($i = 1$), α_N ($i = N$) (Eq. 11), β_1 ($i = 1$), β_N ($i = N$) (Eq. 12) and γ (Eq. 13) are coefficients related to heat loss and conductive heat exchanges between the layers of water in the storage tank, respectively. Because of homogeneous conditions inside the tank, $\alpha_1 = \alpha_N$ and $\beta_1 = \beta_N$. U is the overall heat transfer coefficient (Eq. 14), S is the surface of a layer of water (m^2) (Eq. 15):

$$\alpha = \beta + V \quad (9)$$

$$\beta = \frac{U \cdot P}{\rho \cdot C_p} \cdot T_E \cdot \Delta Z \quad (10)$$

$$\alpha_1 = \alpha_N = \beta_N + V \quad (11)$$

$$\beta_1 = \beta_N = \beta + \frac{U \cdot S}{\rho \cdot C_p \cdot T_E} \quad (12)$$

$$\gamma = \frac{\lambda_f \cdot T_E}{\rho \cdot C_p \cdot \Delta Z^2} \quad (13)$$

$$U = \left(\frac{1}{h_{amb}} + \frac{\Delta_{ins}}{\lambda_{ins}} + \frac{\Delta_{int}}{\lambda_{int}} + \frac{\Delta_{ext}}{\lambda_{ext}} + \frac{1}{h_f} \right)^{-1} \quad (14)$$

$$S = \pi \cdot t \cdot r^2 \quad (15)$$

with T_E the sampling time (s), ΔZ the height of a layer of water (m), P the perimeter of the tank (m), r the radius of the tank (m), C_p the specific heat of water ($\text{kJ} \cdot \text{kg}^{-1} \cdot \text{K}^{-1}$), ρ the density of water ($\text{kg} \cdot \text{m}^{-3}$), λ_f the thermal conductivity of water ($\text{W} \cdot \text{m}^{-1} \cdot \text{K}^{-1}$), h_f the heat transfer coefficient of water ($\text{W} \cdot \text{m}^{-2} \cdot \text{K}^{-1}$), h_{amb} the heat transfer coefficient of ambient air ($\text{W} \cdot \text{m}^{-2} \cdot \text{K}^{-1}$), λ_{ins} the insulating material thermal conductivity ($\text{W} \cdot \text{m}^{-1} \cdot \text{K}^{-1}$), Δ_{ins} the insulating material thickness (m), λ_{int} the internal material thermal conductivity ($\text{W} \cdot \text{m}^{-1} \cdot \text{K}^{-1}$), Δ_{int} the internal material thickness (m), λ_{ext} the external material thermal conductivity ($\text{W} \cdot \text{m}^{-1} \cdot \text{K}^{-1}$), and Δ_{ext} the external material thickness (m).

3. Sequential management approach

3.1. Operation modes

Multi-energy district boilers are equipped with one (WB1) or two (WB1/WB2) biomass units, depending on the power demand, and two (GB1/GB2) gas units (Fig. 1).

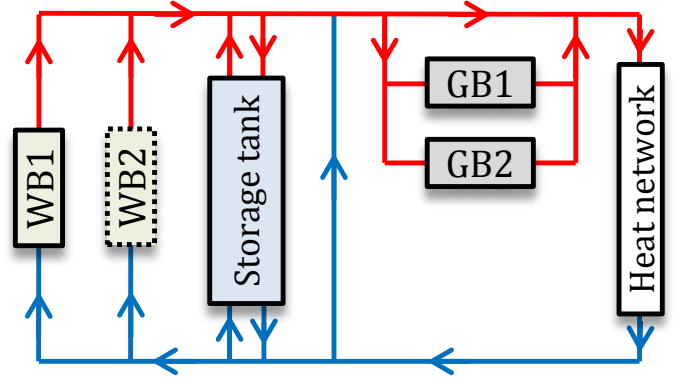

Figure 1: Synoptic of a plant equipped with one (WB1) or two biomass boilers (WB1/WB2), two gas boilers (GB1/GB2), and a thermal storage tank. The plant is connected to a local heat network for thermal energy distribution.

GB1 is an auxiliary boiler while GB2 is switched on in case of malfunction or during maintenance phases only. Usually, the biomass power is modulated between P_{WB}^{min} and P_{WB}^{max} in order to meet the power demand. When such a demand is lower than P_{WB}^{min} , the biomass boiler(s) is/are switched off and GB1 is used. During the coldest periods of winter, the biomass and gas units operate jointly. In this case, the biomass boilers available operate at maximum power. Whatever the number of biomass units, we propose to operate a multi-energy district boiler equipped with an optimally-designed thermal storage tank according to the following approach. This management strategy is based on three operation modes. As stated above in the paper, its main objective is to improve plant operation and reduce the consumption of gas. The way it is applied, on the basis of the number of biomass units available, is detailed in sections 3.2 and 3.3:

Operation mode 1. When the power demand is high (in particular during the coldest months of winter), instead of modulating the biomass power, all the (biomass) units available operate at maximum power to meet requirements and charge the tank. Once the power demand is upper than P_{WB}^{max} , the stored energy is released. In this way, the auxiliary gas unit is only switched on when the tank is empty and the power demand still exceeds P_{WB}^{max} .

Operation mode 2. This second operation mode is for a moderate power demand. When $P_{net} < P_{WB}^{max}$, due to the variability in the demand, the biomass boiler (or one of the two biomass units installed at the plant) operates at minimum power (or higher) and the excess of energy produced is stored in order to be used later. If two biomass boilers are available, both can also operate at minimum power. In this way, these units operate continuously and the number of on/off transitions is reduced. As a consequence, fossil energy can be saved.

Operation mode 3. For some periods of the year (in particular during the hottest months of summer), most of the buildings connected to a heat network do not need

to be heated and, as a consequence, only domestic hot water is required (low-demand periods). Instead of using the auxiliary gas unit to meet low power requirements (biomass boilers are usually oversized), the biomass unit (or the smallest boiler in case of two units being installed at the plant) and the thermal storage system can be operated as follows: first, the biomass unit runs at minimum power, what allows both the power demand to be met and the tank to be charged. Once the thermal storage system is completely filled with hot water, the boiler is shut down and the stored energy is released to afford domestic hot water. The boiler is switched on again when the tank is empty. Such a mode prevents the use of gas and favors the use of renewable energy during low-demand periods.

3.2. Multi-energy district boiler equipped with a single biomass unit (WB1)

Fig. 2 and Table 1 depicts the state diagram used to manage a multi-energy district boiler equipped with a single biomass unit (WB1), on the basis of the three operation modes described above. We consider the plant to be completed (or not) by an optimally-designed thermal storage tank. Each orange circle (Fig. 2) is for a specific state, each arrow is for a transition from a state to another. In Table 1, ES is for Energy Storage: $ES = 0$ is

Without thermal storage tank

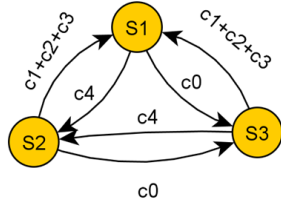

With thermal storage tank

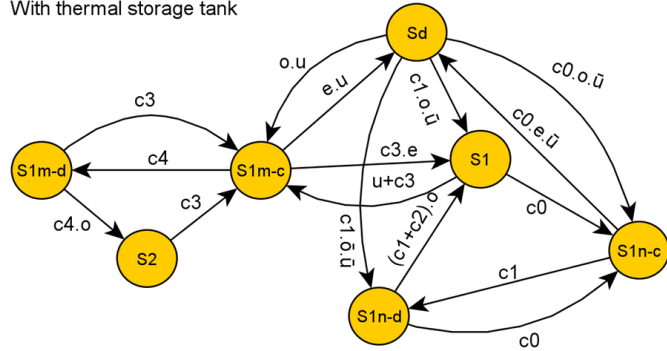

Figure 2: State diagram for the management of a multi-energy district boiler equipped with a single biomass unit (WB1). The plant is completed (bottom) or not (up) by a thermal storage tank.

for static mode (in this case, no water is flowing through the tank), $ES = 1$ is for storage mode (i.e., hot water that comes from the biomass unit is injected at the top of the tank and cold water flows out at the bottom), and $ES = -1$ is for discharging (release) mode (i.e., cold water back from the heat network is injected at the bottom of the tank and pushes away the hot water which flows out at the top and is sent to the network). Without thermal storage tank (Fig. 2 (up)), the plant can be managed

using a diagram composed of three states only (S_1 , S_2 , and S_3). Basically, the biomass power is modulated between P_{WB1}^{min} and P_{WB1}^{max} to meet requirements (S_1). When the power demand is lower than P_{min} , the biomass boiler (WB1) is switched off and the auxiliary gas boiler (GB1) is used (S_3). During peak load periods, the power demand is shared between WB1 (the boiler operates at maximum power) and GB1 (S_2). The main goal in adding a thermal storage tank to the plant is to remove S_3 and avoid switching to S_2 . Changes in power demand and storage content (E_{cum}) lead to switching from an operation mode to another (section 3.1). As one can see in Fig. 2 (down), managing the plant equipped with a tank requires a total of seven states in the diagram. S_{1m-c} is for WB1 operating at maximum power in order to meet requirements and the tank being charged during low-demand periods. S_{1m-d} is for WB1 operating at maximum power and energy being released from the tank, when P_{net} exceeds P_{WB1}^{max} (GB1 is not switched on anymore). S_{1n-c} and S_{1n-d} are for WB1 operating at minimum power and the tank being charged (S_{1n-c}) or releasing hot water (S_{1n-d}), for a power demand of high variability but lower than P_{WB1}^{max} . Finally, S_d is for the connexion with the heat network.

Table 1: Sequential management of a multi-energy district boiler equipped with a single biomass unit (WB1).

State	Actions
S_1	$P_{WB1} = P_{net}, P_{GB1} = 0, ES = 0$
S_2	$P_{WB1} = P_{WB1}^{max}, P_{GB1} = P_{net} - P_{WB1}^{max}, ES = 0$
S_3	$P_{WB1} = 0, P_{GB1} = P_{net}, ES = 0$
S_{1m-c}	$P_{WB1} = P_{WB1}^{max}, ES = 1$
S_{1m-d}	$P_{WB1} = P_{WB1}^{max}, ES = -1$
S_{1n-c}	$P_{WB1} = P_{WB1}^{min}, ES = 1$
S_{1n-d}	$P_{WB1} = P_{WB1}^{min}, ES = -1$
S_d	$P_{WB1} = 0, ES = -1$
Transition	Condition
c_0	$P_{net} < P_{WB1}^{min}$
c_1	$P_{WB1}^{min} \leq P_{net} < th_1$
c_2	$th_1 \leq P_{net} < th_2$
c_3	$th_2 \leq P_{net} \leq P_{WB1}^{max}$
c_4	$P_{net} > P_{WB1}^{max}$
o	$E_{cum} = 0$
e	$E_{cum} = E_{max} = \rho \cdot C_p \cdot V_t \cdot \Delta T$
u	Low-demand period

3.3. Multi-energy district boiler equipped with two biomass units (WB1 and WB2)

Fig. 3 and Table 2 depicts the state diagram used to manage a multi-energy district boiler equipped with two biomass units (WB1 and WB2), on the basis of the three operation modes described above. Again, we consider the plant to be completed (or not) by an optimally-designed thermal storage tank. As stated above, each orange circle (Fig. 3) is for a specific state, each arrow is for a transition from a state to another. Without thermal storage system, the plant can be managed using the five-state diagram depicted by Fig. 3 (up). Usually, in multi-energy

Without thermal storage tank

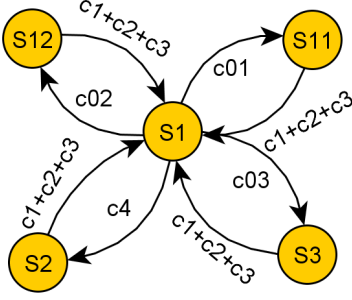

With thermal storage tank

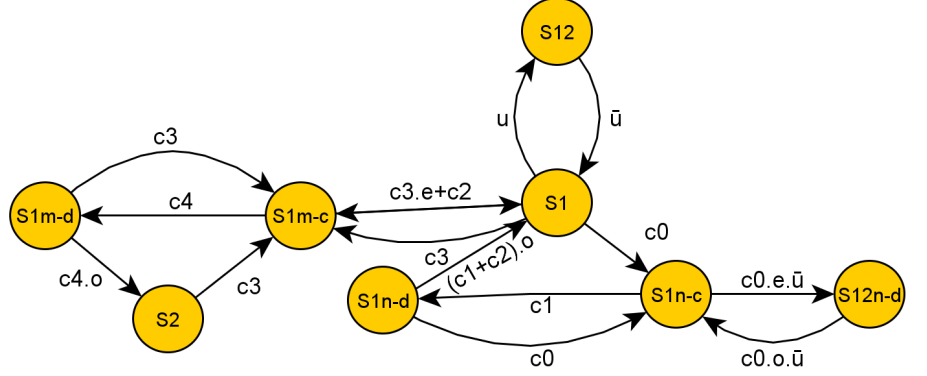

Figure 3: Sequential management of a multi-energy district boiler equipped with two biomass units (WB1 and WB2). In addition, the plant is equipped (right) or not (left) with a thermal storage system.

Table 2: Sequential management of a multi-energy district boiler equipped with two biomass units (WB1 and WB2).

State	Action
S_1	$P_{WB1} + P_{WB2} = P_{net}, P_{GB1} = 0, ES = 0$
S_2	$P_{WB1} = P_{WB1}^{max}, P_{WB2} = P_{WB2}^{max}, P_{GB} = P_{net} - (P_{WB1}^{max} + P_{WB2}^{max}), ES = 0$
S_3	$P_{WB1} = 0, P_{WB2} = 0, P_{GB} = P_{net}, ES = 0$
S_{11}	$P_{WB1} = P_{net}, P_{WB2} = 0, P_{GB} = 0, ES = 0$
S_{12}	$P_{WB1} = 0, P_{WB2} = P_{net}, P_{GB} = 0, ES = 0$
S_{1m-c}	$P_{WB1} = P_{WB1}^{max}, P_{WB2} = P_{WB2}^{max}, ES = 1$
S_{1m-d}	$P_{WB1} = P_{WB1}^{max}, P_{WB2} = P_{WB2}^{max}, ES = -1$
S_{1n-c}	$P_{WB1} = P_{WB1}^{min}, P_{WB2} = P_{WB2}^{min}, ES = 1$
S_{1n-d}	$P_{WB1} = P_{WB1}^{min}, P_{WB2} = P_{WB2}^{min}, ES = -1$
S_{12n-d}	$P_{WB1} = 0, P_{WB2} = P_{WB2}^{min}, ES = -1$
Transition	Condition
c_0	$P_{net} \leq P_{WB1}^{min} + P_{WB2}^{min}$
c_1	$P_{WB1}^{min} + P_{WB2}^{min} < P_{net} \leq th_1$
c_2	$th_1 < P_{net} \leq th_2$
c_{01}	$P_{WB2}^{max} \leq P_{net} < P_{WB1}^{min} + P_{WB2}^{min}$
c_{02}	$P_{WB1}^{min} \leq P_{net} < P_{WB2}^{max}$
c_3	$th_2 < P_{net} \leq P_{WB1}^{max} + P_{WB2}^{max}$
c_4	$P_{net} > P_{WB1}^{max} + P_{WB2}^{max}$
o	$E_{cum} = 0$
e	$E_{cum} = E_{max} = \rho \cdot C_p \cdot V_t \cdot \Delta T$
u	Low-demand period

district boilers equipped with two biomass units (WB1 and WB2), these units operate together or alternatively, in some cases in combination with GB1, in order to satisfy the power demand, as described by states S_1 , S_2 , S_3 , S_{11} , and S_{12} (Fig. 3 (up)). Of course, the main objective in adding a tank to the plant is again to limit the use of GB1. As one can see in Fig. 3 (down), managing the plant equipped with a tank increases the number of states in the diagram to eight. S_{1m-c} is for WB1 and WB2 operating at maximum power in order to meet the

power demand and charge the tank (low-demand periods). S_{1m-d} (P_{net} exceeds $P_{WB1}^{max} + P_{WB2}^{max}$) is for WB1 and WB2 operating at maximum power and the stored energy being released. S_{1n-c} and S_{1n-d} are for WB1 and WB2 operating at minimum power and the tank being charged (S_{1n-c}) or releasing hot water (S_{1n-d}), for a power demand of high variability but lower than $P_{WB1}^{max} + P_{WB2}^{max}$. In this way, a continuous operation of boiler units is ensured. Finally, (S_{12}) is for the smallest of the two biomass boilers operating to meet the power demand during summer time.

4. Energy and economic evaluation

Energy and economic criteria are proposed as performance indicators. Using these criteria, one can highlight the impact of thermal energy storage on a multi-energy district boiler operation. One can ascertain the adequate size of the tank by optimizing one of the proposed criteria. As a key point, and to address the question of optimal capacity, what is expected from this system has to be highlighted. As stated above in the paper, the main purpose of thermal energy storage is to decrease the consumption of gas while ensuring the contractual wood coverage rate (C_{wood-c}). Usually, C_{wood-c} is equal to 92%. The wood and gas coverage rates (C_{wood} and C_{gas}) are defined from E_{wood} and E_{gas} , the annual thermal energy produced by the combustion of wood and gas, respectively (Eq. (16)):

$$C_{wood} = \frac{E_{wood}}{E_{wood} + E_{gas}}, \quad C_{gas} = \frac{E_{gas}}{E_{wood} + E_{gas}} \quad (16)$$

Thermal energy storage gains its meaning from the difference in price between wood and gas. So, Ec is defined as the annual economic gain related to the use of a thermal storage tank in a multi-energy district boiler (Eq. (17)). Ec_{gas} , given by Eq. (18), is the decrease in gas consumption while Ov_{wood} , given by Eq. (19), is the increase in wood consumption due to thermal energy storage. UP_{wood} and UP_{gas} are the prices per kWh of wood and gas, respectively. As mentioned above, E_{wood} and E_{gas} are the annual thermal energy produced by the combustion of wood and gas. V_t is the volume of the tank (Eq. (18) and (19)):

$$Ec = Ec_{gas} \times UP_{gas} - Ov_{wood} \times UP_{wood} \quad (17)$$

$$Ec_{gas} = E_{gas}(V_t = 0 \text{ m}^3) - E_{gas}(V_t) \quad (18)$$

$$Ov_{wood} = E_{wood}(V_t) - E_{wood}(V_t = 0 \text{ m}^3) \quad (19)$$

In order to put in perspective the economic benefits of energy savings, the PayBack Period (PBP) is evaluated. The PBP is the length of time required to recover the cost of the investment related to the thermal storage tank installation. It is calculated from Cs , which deals with an estimation of the costs related to thermal energy storage (based on prices given by Schmidt et al. [40]), and Ec (Eq. (20)):

$$PBP = \frac{Cs}{Ec} \quad (20)$$

In addition, the economic gain G is calculated from PBP , Ec , and D_{op} . D_{op} is the operating period and includes the effective operating time and all types of idle time, whether caused by maintenance and repair or organizational reasons. G is expressed by Eq. (21):

$$G = (D_{op} - PBP) \times Ec \quad (21)$$

According to all of these considerations, the thermal storage tank leading to the most important economic gain

and allowing the contractual wood coverage rate to be met is highlighted as the optimal design. It should also be noted that new buildings connected to the heat network, future building expansions, as well as evolution in the price of energy are factors to be taken into account in order to evaluate accurately the limitations of the selected storage tank. Finally, the optimization problem can be formulated as follows by Eq. (22):

$$\max_{V_t} (G) \text{ with } \begin{cases} V_t \in [V_t^{min}; V_t^{max}] \\ C_{wood}(V_t) \geq C_{wood-c} \end{cases} \quad (22)$$

5. Case study 1 - A southwest France multi-energy district boiler

This section focuses on the first case study we considered. Both the design methodology (section 2) and sequential management strategy (section 3) are applied to a multi-energy district boiler situated in the southwest of France, in the Midi-Pyrénées region. The plant is equipped with a sole biomass unit.

5.1. Plant overview

Midi-Pyrénées is a region located in the southwest of France and renowned for its warm and pleasant climate throughout the year. The region boasts oceanic, Mediterranean as well as continental weather influences. As a result, variability in the climate is high. With the Pyrénées mountains to its south, the Massif Central to the north, Midi-Pyrénées climate and weather are influenced from both sides. Thus temperatures can be high during summer (average temperature is about 20°C) and quite low during winter (average temperature is about 6°C). There are also mild spring and autumn months. The considered plant is composed of three heat generators. The first generator (WB1) is a biomass boiler whose minimum power (P_{WB1}^{min}) is 1.35 MW. Its maximum power (P_{WB1}^{max}) is 5.4 MW. This unit is designed to ensure the basic production of thermal energy. Since it cannot be operated beyond P_{WB1}^{min} or P_{WB1}^{max} , a 3.5 MW gas boiler (GB1) operates jointly with it during peak demand periods or alone when the power demand is lower than P_{WB1}^{min} . A 6.5 MW gas boiler (GB2) is switched on in case of malfunction or during maintenance phases only.

5.2. Operation modes

On the basis of both the power demand (Fig. 4) and the characteristics of the boiler units provided by the plant operator (our industrial partner Cofely GDF-Suez), the management strategy discussed in section 3.2 (Fig. 2) can be applied to this multi-energy district boiler with $th_1 = 2.7$ MW and $th_2 = 4.05$ MW (Table 1). So, two operation modes can be considered. During winter and mid-season periods (i.e. from January to May (1-15), October (16-31), November, and December), one can observe that

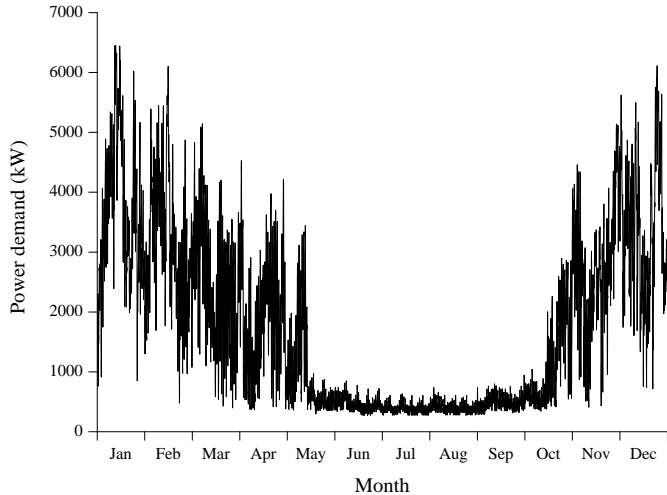

Figure 4: Evolution in time of power demand (first case study).

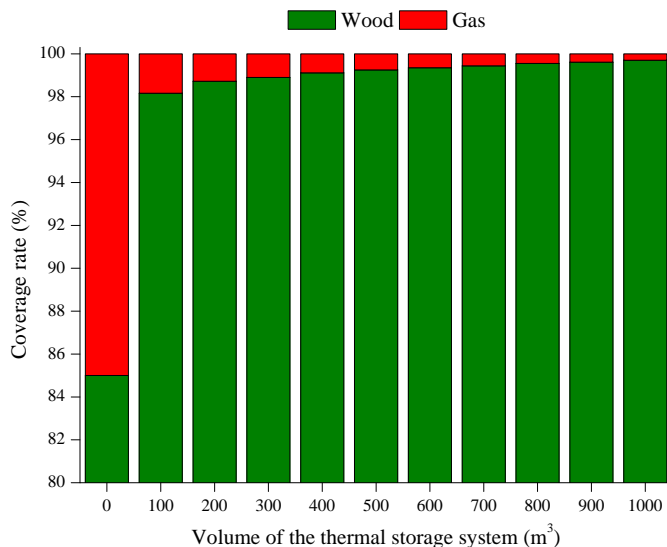

Figure 5: Impact of thermal energy storage on the wood and gas coverage rates.

variability in the power demand is high. Sometimes, such a demand is lower than the minimum power of the biomass boiler (i.e. 1.35 MW) while it can exceed at times its maximum power (i.e. 5.4 MW). During summer time (i.e. from May, 15 to October, 15), the power demand stabilizes at a value lower than 1 MW.

First, let us consider the plant without thermal storage tank. During winter and mid-season periods (first operation mode), the biomass power is modulated between 1.35 MW and 5.4 MW (state S_1) to meet the demand. When requirements are out of this power range, GB1 is turned on (states S_2 and S_3). During these periods, the energy consumption of gaz is evaluated at 0.720 MWh, what represents 4.67% of the annual demand in energy. During summer time, the biomass boiler (WB1) is not used and 10.64% of the annual demand in energy is satisfied by GB1 (state S_3). A thermal storage tank can be considered in or-

der to reduce the annual consumption of gas (estimated at 2.36 MWh, what represents 15.32% of the annual demand in energy). By storing and releasing thermal energy, one can delay or even prevent the use of the gas boiler (states S_{1m-c} , S_{1m-d} , S_{1n-c} , S_{1n-d} , S_d) (Fig. 2).

5.3. Design of the tank and evaluation of performance

A thermal storage system whose size can vary from 0 to 1000 m³ has been considered for the plant. Performance is evaluated thanks to the proposed energy and economic criteria. Fig. 5 shows how wood and gas coverage rates evolve according to the volume of the tank. First, one can highlight that the biomass boiler is sized to ensure around 85% of the annual power demand. When adding to the plant a 100 m³ thermal storage tank, the wood coverage rate increases by 13% and reaches 98%. Beyond 100 m³, the volume of the tank impacts on the wood coverage rate in an insignificant way: if the volume of the tank increases 10 times, this rate increases only by 1.5%. This is without any doubt the consequence of the limited quantity of energy available to be stored.

Let us now investigate the economic impact of the proposed investment. Table 3 shows that the global economic gain (over the operating period) is maximized when considering a 200 m³ thermal storage system. Savings are due to the reduction in gas consumption while additional costs are due to the increase in wood consumption. Regarding both the shape and the insulation of the tank, the objective is to define its geometrical parameters (its Height (H) and Diameter (D)) and choose the most adequate insulating material in order to cope with the thermal losses, especially during the cooling down phase. To this end, the stratification model presented in section 2 has been used to simulate the evolution over time of water temperature inside the tank and evaluate the thermal losses. First, we considered a 200 m³ thermal storage tank not insulated at all and initially filled with hot water at a temperature of 105°C. The tank is not used during 24 hours (i.e. 1440 minutes). Ambient temperature (T_{amb}) is supposed to be equal to 0°C and unchanged through the day. Fig. 6 highlights the way the ratio H/D affects the thermal losses. As one can see, by choosing for the tank a height equal to its diameter ($H/D = 1$), the average temperature of water is decreased by 44°C at the end of the day. Thus, such a temperature is 16°C higher than when considering a ratio H/D equal to 5. So, we designed the tank as follows: $V_t = 200 \text{ m}^3$, $h_{op} = 6.33 \text{ m}$ and $r_{op} = 3.17 \text{ m}$.

Once both the optimal volume and shape of the thermal storage tank are determined, the adequate insulation has to be defined. Fig. 7 shows the impact of both the insulating material used and its thickness on the thermal losses. If one sets as an objective to lose no more than 1°C per day, one has the choice between a 100 mm layer of rockwool, a 50 mm layer of rigid polyurethane foam or a 150 mm layer of foam glass granulate. A definitive choice based on market prices can then be made.

Table 3: Economic evaluation of thermal energy storage. Savings are due to the reduction in gas consumption while additional costs are due to the increase in wood consumption.

Volume (m^3)	Savings (k€)	Additional costs (k€)	Annual economic gain (k€)	Global economic gain (k€)
100	83.1	38.5	44.6	1020.6
200	86.6	38.3	48.3	1109.5
300	87.7	38.4	49.3	1038.9
400	89.1	38.7	50.7	1029.5
500	89.9	38.9	50.9	993.5
600	90.5	39.1	51.4	964.3
700	91.1	39.5	51.6	929.7
800	91.7	39.4	52.3	911.9
900	92.1	39.7	52.4	879.6
1000	92.7	39.9	52.7	865.7

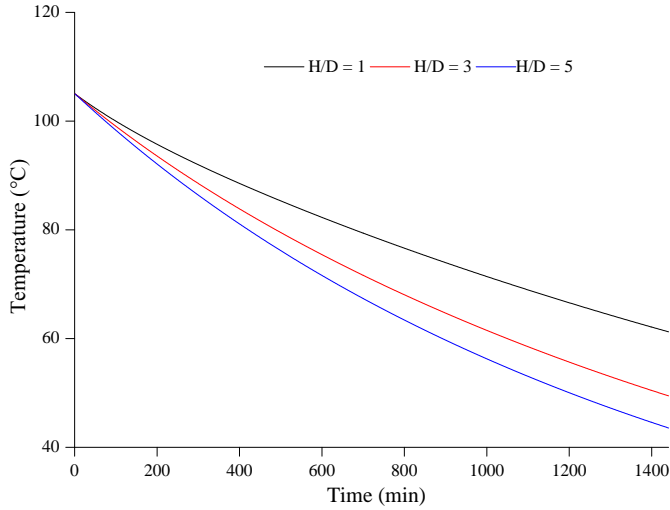

Figure 6: Impact of the ratio of Height to Diameter (H/D) on the average temperature of water, for a non-insulated tank of $200 m^3$ (static mode). Initially, the tank is filled with hot water at a temperature of $105^\circ C$.

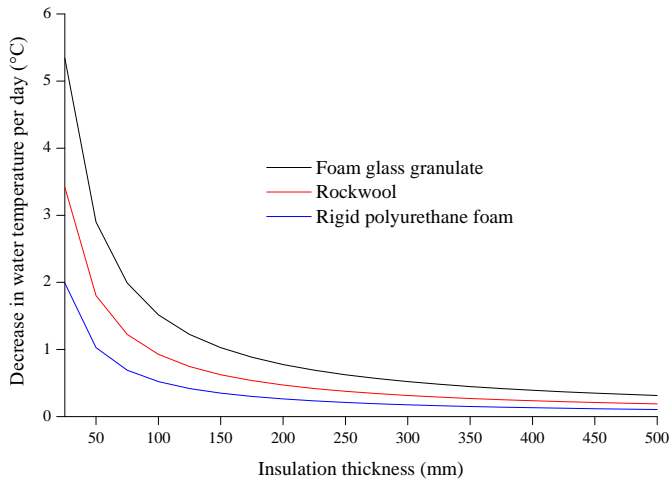

Figure 7: Impact of the insulating material used (on the basis of its thickness) on the average temperature of water (criterion is the decrease in temperature per day), for a tank of $200 m^3$.

Taking as a reference the considered multi-energy district boiler without thermal energy storage, the tank we designed allows $48.3 k\text{€}$ to be saved annually. The cost of the investment is about $98 k\text{€}$ and, as a result, it can be recovered in two years only. In addition, over the 25-year operating period, the global economic gain amounts to $1109.5 k\text{€}$. Based on this assessment, one can confirm that adding to the plant a $200 m^3$ thermal storage tank is commercially viable. However, an increase in the demand and/or in energy prices has to be taken into account in order to complete the analysis. Regarding the ability of a $200 m^3$ thermal storage tank to cope with an eventual increase in the demand, one can observe that the wood coverage rate remains higher than 90% (usually, the contractual wood coverage rate is 92%) in case of an increase in the demand that does not exceed 40% (Fig. 8). In addition, an annual increase in wood and gas prices of 1 and 2% respectively leads to a global economic gain of $1514.13 k\text{€}$ over the 25-year operating period of the plant. Fig. 9 and Fig. 10 show its behavior during the first week of January and the third week of May, respectively, with or without thermal storage system added to the plant. During the first period (operation mode 1), the maximum power demand is 6.45 MW , what means that GB1 will be used to cope with such a demand if the plant is not equipped with a thermal storage system. The minimum power demand is 0.27 MW and GB1 will also be used instead of WB1 which is unable to meet a demand when it is lower than 1.35 MW . In opposition, when considering a $200 m^3$ storage system, GB1 is no more used during peak or low demand periods and the WB1 operates continuously. So, with such a configuration, the biomass boiler operates much more time at its maximum power. As a result, efficiency increases over the year because biomass boilers are generally more effective when operating at maximum power [41]. During the second period (operation mode 2), the maximum power demand is 0.760 MW , what means that only GB1 can operate in order to meet power requirements. The biomass boiler, operating at its minimum power and combined with a $200 m^3$ thermal storage tank, can replace the gas boiler

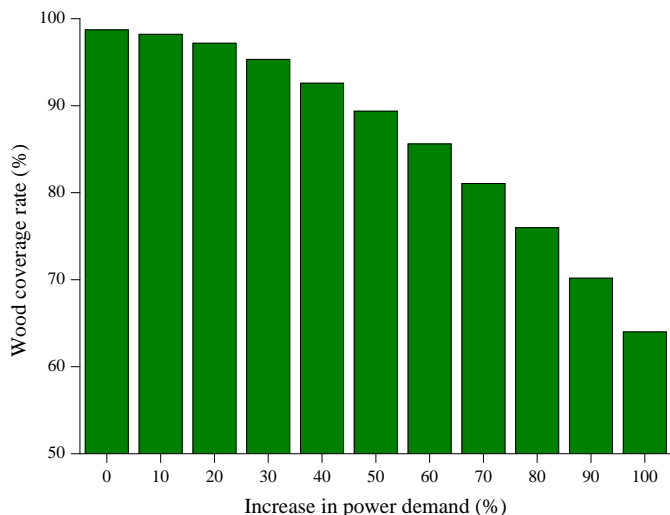

Figure 8: Impact of an increase in power demand (%) on the wood coverage rate. The plant is equipped with a 200 m^3 thermal storage tank, managed using the sequential approach.

and thus the amount of fossil energy consumed can be reduced. One can also observe that the storage system has a two-phase dynamics (charging and release) and each one is about half a day. During the charging phase, the excess of thermal energy produced by WB1 is stored and once the tank is full, the biomass unit is shut down and the demand is satisfied by releasing the stored energy. WB1 operates at 25% of its maximum power during half a day. Usually, biomass boilers are designed in order to operate at more than 20% of their maximum power. Below this threshold, performance deteriorates and smoke emissions can be higher than what is legally allowed.

6. Case study 2 - A northwest France multi-energy district boiler

This section focuses on the second case study we considered. Both the design methodology (section 2) and the sequential management strategy (section 3) are applied to a multi-energy district boiler situated in the northwest of France, in the Lower Normandy region. The plant is equipped with two biomass units

6.1. Plant overview

Lower Normandy is a region located in the northwest of France. Its climate is oceanic. Generally, winters tend to be cold and crisp while summers are warm and relatively dry. In winter, average temperature is 3.6°C . In summer, it is about 17°C . The region receives rainfall throughout the year and the coastal areas are often subject to high winds. The considered multi-energy district boiler is composed of four heat generators: two biomass units (WB1/WB2) and two gas units (GB1/GB2). The minimum power (P_{WB1}^{min}) of WB1 is 2.16 MW. Its maximum power (P_{WB1}^{max}) is 7.2 MW. The second biomass unit

has a minimum power (P_{WB2}^{min}) of 0.75 MW and a maximum power (P_{WB2}^{max}) of 2.5 MW. WB1 and WB2 are designed to ensure the basic production of thermal energy. The 3.5 MW gas unit (GB1) operates jointly with the two biomass units during peak demand periods. Finally, the 6.5 MW gas unit (GB2) is switched on in case of malfunction or during maintenance phases only.

6.2. Operation modes

On the basis of both the power demand (Fig. 11) and the characteristics of the boiler units provided by the plant operator (our industrial partner Cofely GDF-Suez), the management strategy discussed in section 3.2 (Fig. 2) can be applied to this multi-energy district boiler with $th_1 = 4.66\text{ MW}$ and $th_2 = 6\text{ MW}$ (Table 1). So, three operation modes can be considered. When the power demand is high (in particular during the coldest months of winter), it can be met by the two biomass units (WB1 and WB2) often operating at maximum power and, in necessary, the 9700 kW gas boiler (GB1). With a tank added to the plant, the stored energy is managed and released to meet high power requirements, what allows the consumption of gas to be reduced. During summer, the power demand is very low (but generally higher than P_{WB2}^{min} , i.e. 750 kW) and the plant operates only to supply domestic hot water.

During low-demand periods, WB1 and WB2 operate at maximum power and the excess of energy produced is stored for being released later, when the demand increases (S_{1m-c} , S_{1m-d}). In this case, GB1 is only switched on when the storage tank is empty and the demand still exceeds the amount of energy produced by the two biomass units (c_4 and o). The thermal storage system is used to prevent the biomass units to stop running.

During mid-season periods, variability in the power demand is high but lower than it is during the coldest periods of the year. As a result, without thermal energy storage, GB1 is not used and the two biomass units are frequently switched on and off so that production can meet demand. This leads to transient behavior that may have a negative impact on the boilers lifetime and efficiency. That is why, adding to the plant a thermal storage tank, one can operate WB1 and WB2 at minimum power instead of shut them down and the excess of energy produced is stored for being released later, when the demand increases (S_{1n-c} , S_{1n-d}). Thermal energy storage allows performance and reliability to be improved by smoothing the production of thermal energy.

6.3. Design of the tank and evaluation of performance

A thermal storage system whose volume (V_t) varies from 0 to 4000 m^3 has been considered for the plant. Performance is evaluated thanks to the proposed energy and economic criteria (section 4). Fig. 12 shows how wood (C_{wood}) and gas (C_{gas}) coverage rates evolve according to the volume of the tank. First, one can highlight that the biomass units are sized to ensure 92.7% of the annual power demand. So, the adequate sizing of these two

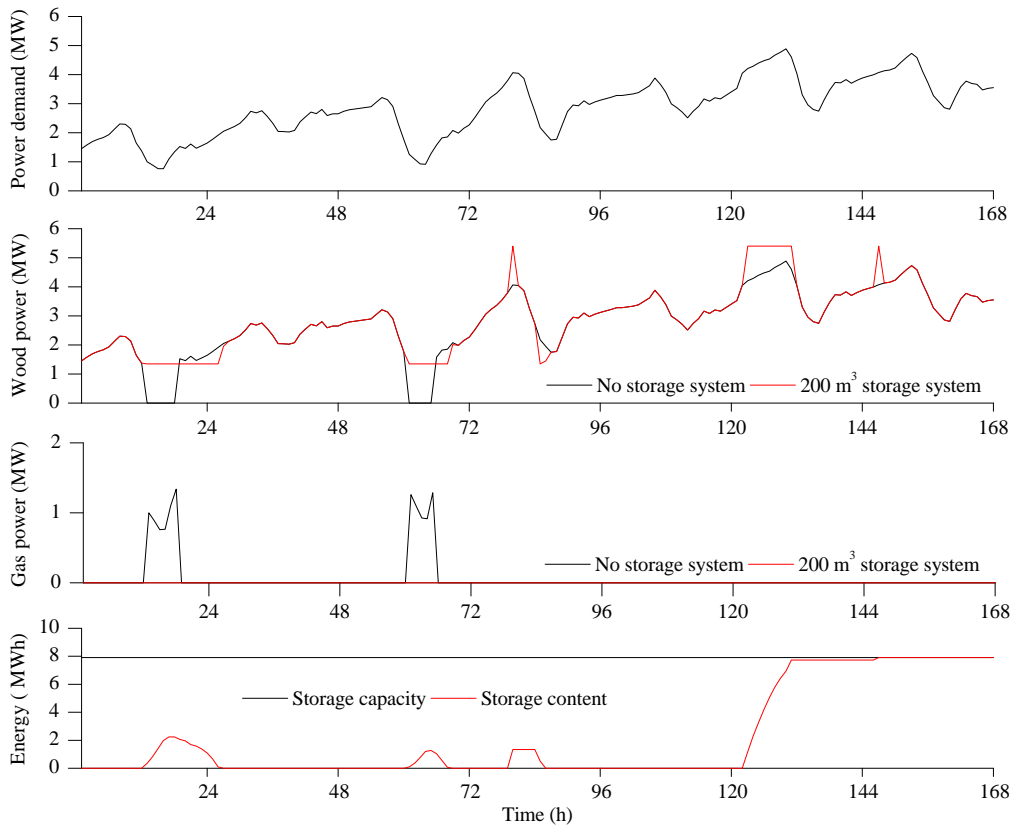

Figure 9: Plant operation during seven days of January (southwest France district boiler).

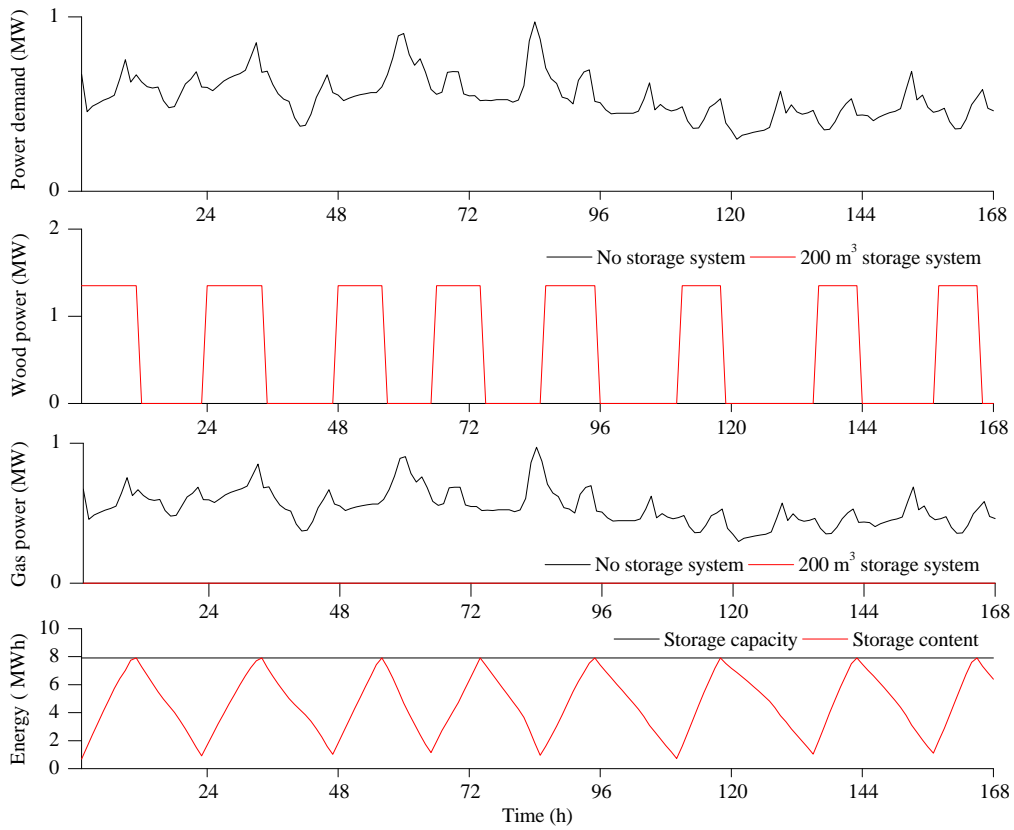

Figure 10: Plant operation during seven days of May (southwest France district boiler).

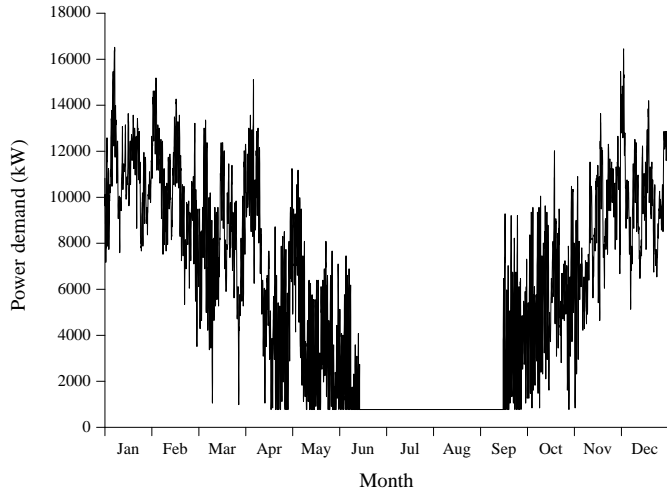

Figure 11: Evolution in time of power demand (second case study).

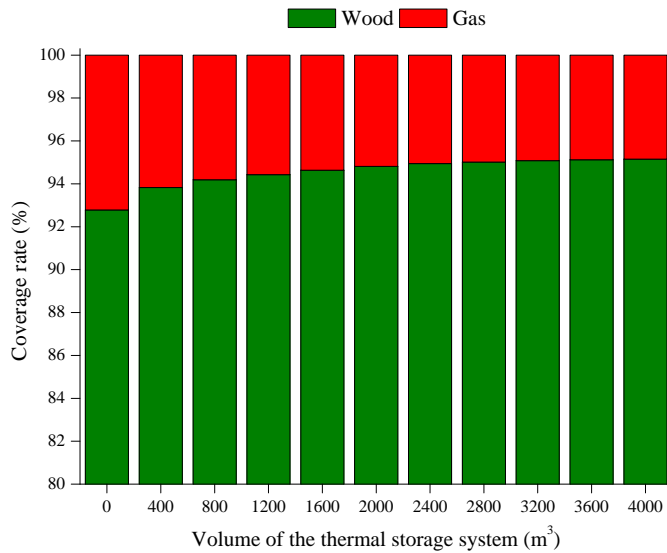

Figure 12: Impact of thermal energy storage on the wood and gas coverage rates.

heat generators allows the contractual wood coverage rate (C_{wood-c}) to be satisfied, on the basis of the actual power demand. When adding a storage system to the plant, the wood coverage rate increases with its volume and reaches about 95% (for a tank of 4000 m^3). Due to the limited amount of energy which can be stored in the tank added to the plant, the wood coverage rate cannot be higher. Let us now investigate the economic impact of the proposed investment. First, Table 4 shows an increase in the annual economic gain (E_c) with the volume of the storage system. For a tank of 4000 m^3 , E_c is equal to 21 k€ . However, one can note that beyond 2500 m^3 , this impact is less than significant. The global economic gain (over the 24-year operating period) is maximized when considering a 1500 m^3 tank. As a result, 1500 m^3 is the optimal volume. Savings are due to the reduction in the consumption of gas while additional costs are due to the increase in the

consumption of wood. Regarding both the shape and the insulation of the tank, the objective is to define its geometrical parameters (its Height (H) and Diameter (D)) and choose the most adequate insulating material in order to cope with the thermal losses. To this end, we used again the stratification model presented in section 2 in order to simulate the evolution over time of water temperature inside the tank and evaluate the thermal losses.

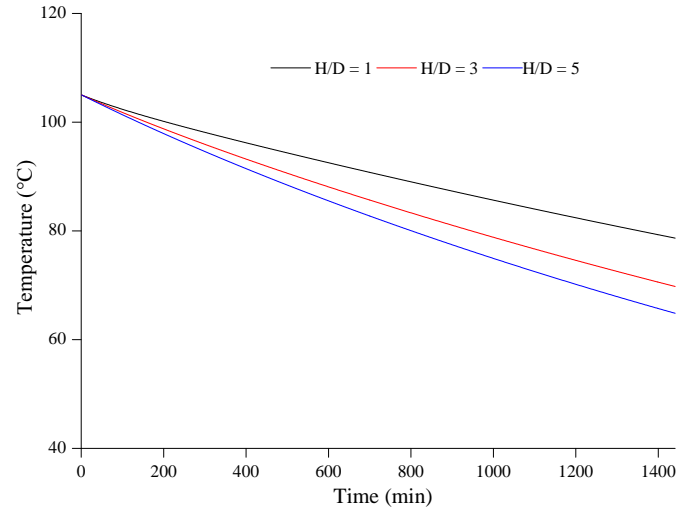

Figure 13: Impact of the ratio of Height to Diameter (H/D) on the average temperature of water, for a non-insulated tank of 1500 m^3 (static mode). Initially, the tank is filled with hot water at a temperature of 105°C .

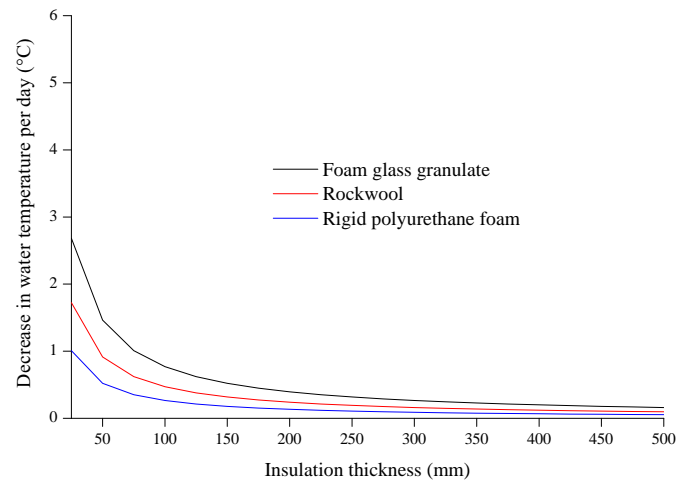

Figure 14: Impact of the insulating material used (on the basis of its thickness) on the average temperature of water (criterion is the decrease in temperature per day), for a tank of 1500 m^3 .

First, we considered a 1500 m^3 thermal storage tank not insulated at all and initially filled with hot water at a temperature of 105°C . The tank is not used during 24 hours (i.e. 1440 minutes). Ambient temperature (T_{amb}) is supposed to be equal to 0°C and unchanged through the day. Fig. 13 highlights the way the ratio H/D affects the thermal losses. As one can see, by choosing for the tank a

Table 4: Economic evaluation of thermal energy storage. Savings are due to the reduction in gas consumption while additional costs are due to the increase in wood consumption.

Volume (m^3)	Savings (k€)	Additional costs (k€)	Annual economic gain (k€)	Global economic gain (k€)
100	8.7	3.8	4.9	70
200	14.4	6.9	7.5	80.8
300	18.6	8.9	9.7	90
400	21.8	10.6	11.2	148.8
500	24.3	11.9	12.4	162.7
600	26.3	12.9	13.4	176.2
700	27.9	13.7	14.2	178.9
800	29.4	14.5	14.9	192
900	31.1	15.2	15.9	198.9
1000	32.3	15.9	16.4	210.8
1500	37.9	19.3	18.6	220.6
2000	42.4	22.3	20.1	203.5
2500	45.6	24.6	21	216.5
3000	47.2	26.3	20.9	201.5
3500	48.5	27.8	20.7	181.6
4000	49.2	28.2	21	185.3

height equal to its diameter ($H/D = 1$), the average temperature of water is decreased by 26.3°C at the end of the day. Thus, such a temperature is 8.5°C higher than when considering a ratio H/D equal to 5. So, we designed the tank as follows: $V_t = 1500\text{ m}^3$, $h_{op} = 12.4\text{ m}$ and $r_{op} = 6.2\text{ m}$. Once both the optimal volume and shape of the thermal storage tank are determined, the adequate insulation has to be defined. Fig. 14 shows the impact of both the insulating material used and its thickness on the thermal losses. If one sets again as an objective to lose no more than 1°C per day, one has the choice between a 50 mm layer of rock-wool, a 25 mm layer of rigid polyurethane foam or a 75 mm layer of foam glass granulate. A definitive choice based on market prices can then be made.

Taking as a reference the considered plant without thermal energy storage, the tank we designed and managed allows 18.6 k€ to be saved annually. The cost of the investment is about 225 k€ and, as a result, the global economic gain amounts to 220.6 k€ over the 24-year operating period of the district boiler. Based on this assessment, one can confirm that adding to the plant a 1500 m^3 thermal storage tank is commercially viable but the payback period is 12 years (2 years only for the first case study) and its impact on performance is moderate. However, an increase in the demand and/or in energy prices has to be taken into account in order to complete the analysis. Regarding the ability of the tank to cope with an eventual increase in the power demand, one can observe that the contractual wood coverage rate is no longer ensured in case of an increase of more than 5% (Fig. 15). In addition, in case of an annual increase in the prices of wood and gas of 1% and 2% respectively, the global economic gain would reach 404.9 k€ over the 24-year operating period of the plant. Fig. 16

shows its behavior during the first week of January, with or without thermal storage system added to the plant. Due to the characteristics of the boiler units, thermal energy storage does not impact the behavior of the plant during the hottest months of the year. During the first week of January, the power demand ranges between 7.17 MW and 16.52 MW and the plant operates according to operation mode 1. As one can see in Fig. 16, the biomass units (WB1 and WB2) operate at maximum power all the time when the plant is equipped with a well-designed and managed tank. Consequently, wood is burned in a more efficient way, with lower smoke emissions. GB1 is only switched on during peak demand periods, if the tank is empty. So, interesting energy savings can be achieved thanks to thermal energy storage, even though its impact is limited by the design of the biomass units. Finally, one can observe that due to the limited amount of energy available to be stored during the considered week of January, the tank is never completely full.

6.4. On/off transitions

Table 5 shows that adding to the plant a well-designed and managed thermal storage system allows the number of on/off transitions for the two biomass units (WB1/WB2) to be significantly reduced, in particular during the mid-season period (from April to June and from September to October) and, as a result, lifetime to be preserved. As an example, these transitions are reduced during May by 90% (from 44 to 4) and 98% (from 80 to 2) for WB1 and WB2, respectively (operation mode 2). In October, the biomass units are never shut down. Over the whole year and for both biomass units, the total number of on/off transitions is reduced by 93.6%, from 426 to 27. Let us remember

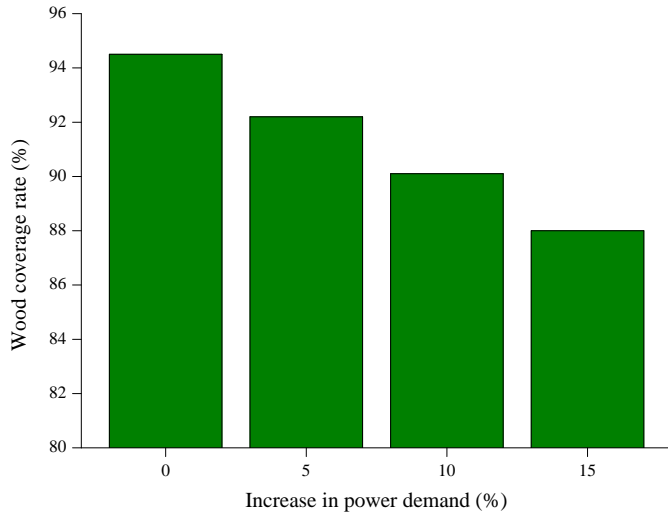

Figure 15: Impact of an increase in power demand (%) on the wood coverage rate. The plant is equipped with a 1500 m^3 thermal storage tank, managed using the sequential approach.

that operation mode 2 allows the excess of thermal energy produced during low-demand periods to be stored into the hot water tank and released when the demand is higher than the minimum power of the biomass units.

Table 5: Number of on/off transitions for the biomass units, with or without thermal storage tank added to the plant and managed using the sequential approach.

Month	WB1/WB2 ($V_t = 0\text{ m}^3$)	WB1/WB2 ($V_t = 1500\text{ m}^3$)
January	0/0	0/0
February	0/0	0/0
March	4/6	4/0
April	24/40	0/0
May	44/80	4/2
June	25/46	9/6
July	0/0	0/0
August	0/0	0/0
September	27/42	2/0
October	28/54	0/0
November	0/6	0/0
December	0/0	0/0

7. Synthesis

Table 6 summarizes the simulation results, for both case studies. First, one can remark that there is a strong connexion between the characteristics of the biomass units, the power demand, and the design of the tanks. Thermal energy storage is an effective solution for multi-energy district boilers, in particular when the biomass units provide less than 90% of the annual power demand. The first case study (a southwest France district boiler) points out that

with a relatively small tank (volume is 200 m^3), significant economic profits can be achieved. As stated above, adding such a storage system to the plant allows the wood coverage rate to be increased in a significant way, from 85% to more than 98%. Over the 25-year operating period, the global economic gain amounts to $1109.5\text{ k}\text{€}$. The second case study (a northwest France district boiler) highlights that thermal energy storage is less advantageous in case of well-designed biomass units. Indeed, adding a 1500 m^3 tank to the plant allows the wood coverage rate to be increased by 1.9 points only, from 92.7% to 94.6%. In addition, the payback period is 12 years while it is only 2 years for the first case study. Over the 24-year operating period, the global economic gain amounts to $220.6\text{ k}\text{€}$.

8. Conclusion

The present work focuses on optimizing multi-energy district boilers connected to heat networks by adding thermal storage tanks to the plants. In this sense, a feasibility study allowed the potential of thermal energy storage to be evaluated. First, a design methodology based on both a parametric analysis and an evaluation of the thermal losses has been proposed. Next, we defined a sequential operation strategy in order to manage the plants equipped with hot water tanks efficiently, on the basis of the power demand and the characteristics of the biomass unit(s). We evaluated energy and economic indicators in order to highlight the configurations that meet needs and expectations.

The proposed approach has been applied to two multi-energy district boilers equipped with one and two biomass units, respectively. These plants are managed by Cofely GDF-Suez, our industrial partner in the OptiEnR project. As a key point, the impact of thermal energy storage is highly related with both the technical characteristics of a plant and the power demand. The results highlight the ability of a hot water tank (when it is optimally designed and managed) to improve operation and realize significant economic savings. The excess of energy produced by the biomass unit(s) during low-demand periods can be stored and released later, instead of engaging a gas boiler. In addition, biomass units are important thermal masses and need to be cooled down upon shutdown. As a consequence, water takes time to be heated and thermal storage tanks can be used as buffer systems.

The next phase in the project will focus on improving the management approach by developing a model predictive controller. In this sense, a short-term forecast methodology based on a multi-resolution analysis and feedforward artificial neural networks is being investigated.

Acknowledgment

The authors are very grateful to Christophe Pascual and Anne-Sonia Provent (from Cylergie, the research and development centre of Cofely GDF-Suez) for their help and support.

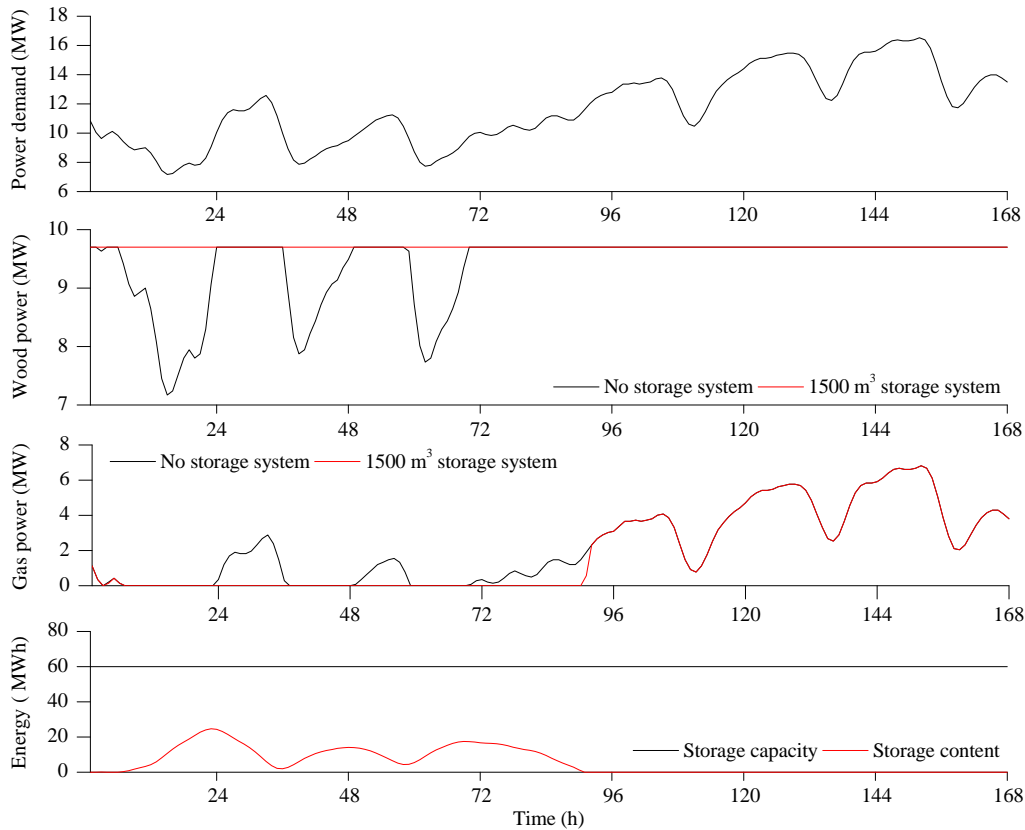

Figure 16: Plant operation during the first seven days of January (northwest France district boiler).

Table 6: Overall results.

Case study	1	2
Location	Southwest France	Northwest France
Operating period	25 years	24 years
Annual heat demand	16 MWh	60 MWh
Volume of the tank	200 m ³	1500 m ³
Height of the tank	6.33 m	12.4 m
Radius of the tank	3.17 m	6.2 m
Investment	98 k€	225 k€
Wood coverage rate without thermal energy storage	85%	92.7%
Wood coverage rate with thermal energy storage	98.7%	94.6%
Annual economic gain	48.3 k€	18.6 k€
PayBack Period (PBP)	2 years	12 years
Global economic gain	1109.5 k€	220.6 k€

References

- [1] P. Bertoldi, B. Hirl, N. Labanca, Energy Efficiency Status Report 2012, Electricity Consumption and Efficiency Trends in the EU-27, Tech. rep., Joint Research Center, Institute for Energy and Transport (2012).
- [2] J. Chau, T. Sowlati, S. Sokhansanj, F. Preto, S. Melin, X. Bi, Techno-economic analysis of wood biomass boilers for the greenhouse industry, Applied Energy 86 (3) (2009) 364–371.
- [3] O. Eriksson, G. Finnveden, T. Ekvall, A. Björklund, Life cycle assessment of fuels for district heating: A comparison of waste incineration, biomass- and natural gas combustion, Energy Policy 35 (2) (2007) 1346–1362.
- [4] L. Kitzing, C. Mitchell, P. E. Morthorst, Renewable energy policies in Europe: Converging or diverging?, Energy Policy 51 (2012) 192–201.
- [5] P. Lauri, A. M. I. Kallio, U. A. Schneider, Price of CO₂ emissions and use of wood in Europe, Forest Policy and Economics 15 (2012) 123–131.
- [6] C. Klessmann, A. Held, M. Rathmann, M. Ragwitz, Status and perspectives of renewable energy policy and deployment in the European Union. What is needed to reach the 2020 targets?, Energy Policy 39 (12) (2011) 7637–7657.
- [7] H. Tanaka, T. Tomita, M. Okumiya, Feasibility study of a district energy system with seasonal water thermal storage, Solar Energy 69 (6) (2000) 535–547.

- [8] A. D. Smith, P. J. Mago, N. Fumo, Benefits of thermal energy storage option combined with CHP system for different commercial building types, *Sustainable Energy Technologies and Assessments* 1 (2013) 3–12.
- [9] V. Verda, F. Colella, Primary energy savings through thermal storage in district heating networks, *Energy* 36 (7) (2011) 4278–4286.
- [10] S.-I. Gustafsson, B. G. Karlsson, Heat accumulators in CHP networks, *Energy Conversion and Management* 33 (12) (1992) 1051–1061.
- [11] K. Kavvadias, A. Tosios, Z. Maroulis, Design of a combined heating, cooling and power system: Sizing, operation strategy selection and parametric analysis, *Energy Conversion and Management* 51 (4) (2010) 833–845.
- [12] G. Taljan, G. Verbic, M. Pantos, M. Sakulin, L. Fickert, Optimal sizing of biomass-fired Organic Rankine Cycle CHP system with heat storage, *Renewable Energy* 41 (2012) 29–38.
- [13] S. Martinez-Lera, J. Ballester, J. Martinez-Lera, Analysis and sizing of thermal energy storage in combined heating, cooling and power plants for buildings, *Applied Energy* 106 (2013) 127–142.
- [14] G. Streckienė, V. Martinaitis, A. N. Andersen, J. Katz, Feasibility of CHP-plants with thermal stores in the German spot market, *Applied Energy* 86 (11) (2009) 2308–2316.
- [15] A. Heller, 15 Years of R&D in central solar heating in Denmark, *Solar Energy* 69 (6) (2000) 437–447.
- [16] T. Kozai, K. Shida, I. Watanabe, Thermal performance of a solar greenhouse with water tanks for heat storage and heat exchange, *Journal of Agricultural Engineering Research* 33 (2) (1986) 141–153.
- [17] A. Ucar, M. Inalli, Thermal and economic comparisons of solar heating systems with seasonal storage used in building heating, *Renewable Energy* 33 (12) (2008) 2532–2539.
- [18] D. Bauer, R. Marx, J. Nußbicker-Lux, F. Ochs, W. Heidemann, H. Müller-Steinhagen, German central solar heating plants with seasonal heat storage, *Solar Energy* 84 (4) (2010) 612–623.
- [19] M. Rodríguez-Hidalgo, P. Rodríguez-Aumente, A. Lecuona, M. Legrand, R. Ventas, Domestic hot water consumption vs. solar thermal energy storage: The optimum size of the storage tank, *Applied Energy* 97 (2012) 897–906.
- [20] Creative Environmental Networks, BioRegional and SEWF, Biomass for London: Wood Fuel Guide, London Energy Partnership, c/o Greater London Authority, City Hall, The Queen’s Walk, London SE1 2AA, 2009.
- [21] M. Cao, J. Cao, Optimal design of thermal-energy stores for boiler plants, *Applied Energy* 83 (1) (2006) 55–68.
- [22] J. Cao, Optimization of thermal storage based on load graph of thermal energy system, *International Journal of Thermodynamics* 3 (2) (2000) 91–97.
- [23] E. E. George, H. W. Page, J. B. Ward, Co-ordination of Fuel Cost and Transmission Loss by Use of the Network Analyzer to Determine Plant Loading Schedules, *American Institute of Electrical Engineers, Transactions of the* 68 (2) (1949) 1152–1163.
- [24] L. Kirchmayer, *Economic operation of power systems*, John Wiley & Sons, Inc, New York, 1958.
- [25] M. A. Lozano, J. C. Ramos, L. M. Serra, Cost optimization of the design of CHCP (combined heat, cooling and power) systems under legal constraints, *Energy* 35 (2) (2010) 794–805.
- [26] C. Rubio-Maya, J. Uche, A. Martínez, Sequential optimization of a polygeneration plant, *Energy Conversion and Management* 52 (8 - 9) (2011) 2861–2869.
- [27] A. Rong, R. Lahdelma, P. B. Luh, Lagrangian relaxation based algorithm for trigeneration planning with storages, *European Journal of Operational Research* 188 (1) (2008) 240 – 257.
- [28] A. Fragaki, A. N. Andersen, D. Toke, Exploration of economical sizing of gas engine and thermal store for combined heat and power plants in the UK, *Energy* 33 (11) (2008) 1659–1670.
- [29] H. Lund, A. Andersen, Optimal designs of small CHP plants in a market with fluctuating electricity prices, *Energy Conversion and Management* 46 (6) (2005) 893–904.
- [30] D. Palmer, I. Tubby, G. Hogan, W. Rolls, Biomass heating: a guide to medium scale wood chip and wood pellet systems, Biomass Energy Centre, Forest Research, Farnham, 2011.
- [31] Y. Han, R. Wang, Y. Dai, Thermal stratification within the water tank, *Renewable and Sustainable Energy Reviews* 13 (5) (2009) 1014–1026.
- [32] R. M. Dickinson, C. A. Cruickshank, S. J. Harrison, Charge and discharge strategies for a multi-tank thermal energy storage, *Applied Energy* (2012) In Press, Corrected Proof, Available online 20 December 2012.
- [33] J. Eynard, Gestion optimale de l’énergie dans un procédé multi-source pour le chauffage de bâtiments, Ph.D. thesis, University of Perpignan Via Domitia, ELIAUS laboratory (October 2010).
- [34] J. Eynard, S. Grieu, M. Polit, Modular approach for modeling a multi-energy district boiler, *Applied Mathematical Modelling* 35 (8) (2011) 3926–3957.
- [35] J. Eynard, S. Grieu, M. Polit, Predictive control and thermal energy storage for optimizing a multi-energy district boiler, *Journal of Process Control* 22 (7) (2012) 1246–1255.
- [36] J. Eynard, S. Grieu, M. Polit, Wavelet-based multi-resolution analysis and artificial neural networks for forecasting temperature and thermal power consumption, *Engineering Applications of Artificial Intelligence* 24 (3) (2011) 501–516.
- [37] N. Al-Najem, M. El-Refae, A numerical study for the prediction of turbulent mixing factor in thermal storage tanks, *Applied Thermal Engineering* 17 (12) (1997) 1173 – 1181.
- [38] N. Altuntop, M. Arslan, V. Ozceyhan, M. Kanoglu, Effect of obstacles on thermal stratification in hot water storage tanks, *Applied Thermal Engineering* 25 (1415) (2005) 2285 – 2298.
- [39] I. Vallios, T. Tsoutsos, G. Papadakis, Design of biomass district heating systems, *Biomass and Bioenergy* 33 (4) (2009) 659–678.
- [40] T. Schmidt, D. Mangold, H. Müller-Steinhagen, Central solar heating plants with seasonal storage in Germany, *Solar Energy* 76 (1 - 3) (2004) 165–174.
- [41] A. Carr, P. Kellett, X. Dubuisson, B. Happold, Procurement Guidelines For Wood Biomass Heating, Sustainable Energy Ireland, Renewable Energy Information Office, 2005.