



**HAL**  
open science

# OmGOGAT-disruption in the ericoid mycorrhizal fungus *Oidiodendron maius* induces reorganization of the N pathway and reduces tolerance to heavy-metals

H R Khouja, S Daghino, S Abbà, F Boutaraa, M Chalot, D Blaudez, E  
Martino, S Perotto

## ► To cite this version:

H R Khouja, S Daghino, S Abbà, F Boutaraa, M Chalot, et al.. OmGOGAT-disruption in the ericoid mycorrhizal fungus *Oidiodendron maius* induces reorganization of the N pathway and reduces tolerance to heavy-metals. *Fungal Genetics and Biology*, 2014, 71, pp.1-8. 10.1016/j.fgb.2014.08.003 . hal-01114970

**HAL Id: hal-01114970**

**<https://hal.science/hal-01114970>**

Submitted on 7 Mar 2024

**HAL** is a multi-disciplinary open access archive for the deposit and dissemination of scientific research documents, whether they are published or not. The documents may come from teaching and research institutions in France or abroad, or from public or private research centers.

L'archive ouverte pluridisciplinaire **HAL**, est destinée au dépôt et à la diffusion de documents scientifiques de niveau recherche, publiés ou non, émanant des établissements d'enseignement et de recherche français ou étrangers, des laboratoires publics ou privés.

AperTO - Archivio Istituzionale Open Access dell'Università di Torino

**OmGOGAT-disruption in the ericoid mycorrhizal fungus *Oidiodendron maius* induces reorganization of the N pathway and reduces tolerance to heavy-metals**

**This is the author's manuscript**

*Original Citation:*

*Availability:*

This version is available <http://hdl.handle.net/2318/149024> since 2016-08-05T09:57:45Z

*Published version:*

DOI:10.1016/j.fgb.2014.08.003

*Terms of use:*

Open Access

Anyone can freely access the full text of works made available as "Open Access". Works made available under a Creative Commons license can be used according to the terms and conditions of said license. Use of all other works requires consent of the right holder (author or publisher) if not exempted from copyright protection by the applicable law.

(Article begins on next page)



## UNIVERSITÀ DEGLI STUDI DI TORINO

This Accepted Author Manuscript (AAM) is copyrighted and published by Elsevier. It is posted here by agreement between Elsevier and the University of Turin. Changes resulting from the publishing process - such as editing, corrections, structural formatting, and other quality control mechanisms - may not be reflected in this version of the text. The definitive version of the text was subsequently published in *Fungal Genetics and Biology*, vol. 71, 2014, [doi:10.1016/j.fgb.2014.08.003](https://doi.org/10.1016/j.fgb.2014.08.003)

You may download, copy and otherwise use the AAM for non-commercial purposes provided that your license is limited by the following restrictions:

- (1) You may use this AAM for non-commercial purposes only under the terms of the CC-BY-NC-ND license.
- (2) The integrity of the work and identification of the author, copyright owner, and publisher must be preserved in any copy.
- (3) You must attribute this AAM in the following format: Creative Commons BY-NC-ND license (<http://creativecommons.org/licenses/by-nc-nd/4.0/deed.en>), [+ *Digital Object Identifier link to the published journal article on Elsevier's ScienceDirect® platform*] [doi:10.1016/j.fgb.2014.08.003](https://doi.org/10.1016/j.fgb.2014.08.003)

***OmGOGAT*-disruption in the ericoid mycorrhizal fungus *Oidiodendron maius* induces reorganization of the N pathway and reduces tolerance to heavy-metals**

H.R. Khouja<sup>a, b, 1</sup>, S. Daghino<sup>a, 1</sup>, S. Abbà<sup>c, 1</sup>, F. Boutaraa<sup>b</sup>, M. Chalot<sup>b, d</sup>, D. Blaudez<sup>b, e</sup>, E. Martino<sup>a</sup>, S. Perotto<sup>a</sup>

<sup>a</sup> Department of Life Sciences and Systems Biology, University of Torino, Viale Mattioli 25, 10125 Torino, Italy

<sup>b</sup> Université de Lorraine, UMR-1136 Interactions Arbres Microorganismes, Faculté des Sciences et Technologies, BP 70239, F-54506 Vandoeuvre-lès-Nancy, France

<sup>c</sup> IPSP – Istituto per la Protezione Sostenibile delle Piante CNR, Strada delle Cacce 73, I-10135 Torino, Italy

<sup>d</sup> Laboratoire Chrono-Environnement, UMR 6249, Université de Franche-Comté, Pôle Universitaire du Pays de Montbéliard, 4 Place Tharradin, BP 71427, 25 211 Montbéliard, France

<sup>e</sup> Laboratoire Interdisciplinaire des Environnements Continentaux, UMR 7360 CNRS-Université de Lorraine, Faculté des Sciences et Technologies, Bld des Aiguillettes, BP 70239, 54506 Vandoeuvre-les-Nancy, France

<sup>1</sup> H.R.K., S.D. and S.A. contributed equally to the work.

Received 13 June 2014, Accepted 7 August 2014, Available online 14 August 2014

doi:10.1016/j.fgb.2014.08.003

---

**Highlights**

- We investigated relationships of nitrogen metabolism with response to heavy metals.
- A *OmGOGAT*-deletion mutant was found to be sensitive to heavy metals.
- *OmGOGAT* mutant showed reduced GS activity and up-regulation of the GDH pathway.
- Glutamine partially rescued the *OmGOGAT* deletion phenotype upon zinc exposure.

---

**Abstract**

Mycorrhizal fungi are key mediators of soil-to-plant movement of mineral nutrients, including essential and non-essential metals. In soil conditions that facilitate mobilization of metal ions, potentially toxic metals can interfere with nitrogen metabolism in both plants and microorganisms. Less is known about possible relationships between nitrogen metabolism and responses to heavy metals. Aim of this study was to investigate this aspect in the ericoid mycorrhizal fungus *Oidiodendron maius* strain Zn, a metal tolerant ascomycete. Growth of *O. maius* Zn on zinc and cadmium containing media was significantly affected by the nitrogen source. Screening of a library of *O. maius* Zn random genetic transformants for sensitivity to heavy metals (zinc and cadmium) and oxidative stress (menadione) yielded a mutant strain that carried a partial deletion of the glutamate synthase (NADH-GOGAT EC 1.4.1.14) gene and its adjacent gene, the *APC15* subunit of the anaphase promoting complex. Comparison of WT and *OmGOGAT*-*OmAPC15* mutant strains indicated an impaired N-metabolism and altered stress tolerance, and assays on

the *OmAPC15*-recomplemented strains ascribed the observed phenotypes to the deletion in the *OmGOGAT* gene. *OmGOGAT* disruption modified the nitrogen pathway, with a strong reduction of the associated glutamine synthetase (GS, EC 6.3.1.2) activity and an up-regulation of the alternative NADP-glutamate dehydrogenase (NADP-GDH, EC 1.4.1.4) pathway for glutamate biosynthesis. Unless they were supplemented with glutamine, *O. maius* Zn transformants lacking *OmGOGAT* were very sensitive to zinc. These results highlight the importance of nitrogen metabolism not only for nitrogen assimilation and transformation, but also for stress tolerance. For mycorrhizal fungi, such as *O. maius*, this may bear consequences not only to the fungus, but also to the host plant.

## Keywords

Nitrogen metabolism; Heavy metal tolerance; Mycorrhizal fungi; Insertional mutagenesis; Glutamate synthase; Glutamine synthetase

---

## 1. Introduction

Nitrogen is the macronutrient that most often limits plant growth and productivity ([Kłobus et al., 2002](#)). Plants can obtain nitrogen directly from the soil solution, or through symbiotic interactions with microbes. Whereas a limited number of plant taxa associate with nitrogen-fixing bacteria, most plants rely on symbiotic mycorrhizal fungi for N acquisition ([Hobbie and Högberg, 2012](#)). Mycorrhizal fungi are considered as key mediators of soil-to-plant N movement because they act at the interface between plants and soil, provide plants with access to both inorganic and organic N forms and influence N availability by competing against free-living saprotrophic fungi and bacteria ([Hobbie and Högberg, 2012](#)).

Among mycorrhizal fungi, ericoid fungi form specific endomycorrhiza (ericoid mycorrhiza, ERM) with plants in the Ericaceae ([Perotto et al., 2012](#)), which colonize soils characterized by slow litter decomposition and mineralization processes. In these ecosystems, essential nutrients such as N and P are found almost exclusively as organic forms ([Read and Perez-Moreno, 2003](#)), and the dominant plant species are highly dependent on their mycorrhizal symbionts for nutrient supply. In addition, low pH and anaerobic soil conditions facilitate mobilization of heavy metal ions, which are toxic above threshold concentrations ([Meharg and Cairney, 2000](#)). [Bradley et al., 1981](#) and [Bradley et al., 1982](#) first demonstrated the importance of ERM fungi in the increased resistance of *Calluna vulgaris* to heavy metals, and other authors later described metal tolerance in fungal isolates from sites with different pollution. In particular, ERM plants in association with members of the “*Rhizoscyphus ericae* aggregate” can survive in arsenate-rich sites ([Sharples et al., 2000](#)) and arsenate resistant *R. ericae* strains have been isolated from *C. vulgaris* growing in As/Cu-contaminated mine soils ([Sharples et al., 2001](#)).

Heavy metals, in particular cadmium, have been reported to interfere with nitrogen metabolism in plants and microorganisms ([Boussama et al., 1999](#) and [Kłobus et al., 2002](#)). For example, nitrogen fixation and primary ammonia assimilation decreased in soybean nodules during Cd treatments ([Balestrasse et al., 2003](#)). Plant enzymes involved in nitrogen metabolism are differently affected by Cd ([Chugh et al., 1992](#), [DalCorso et al., 2008](#), [Petrovic et al., 1990](#) and [Singh and Matthews, 1994](#)). For example, cadmium induced in *Lycopersicon esculentum* a significant inhibition of several enzymatic activities related to nitrogen assimilation, while increasing NADH-glutamate synthase and NADH-glutamate dehydrogenase ([Chaffei et al., 2004](#)). On the other hand, some amino acids can play a significant role in metal chelation and tolerance in plants ([Hall, 2002](#) and [Sharma and Dietz, 2006](#)). Unlike plants and nitrogen-fixing bacteria,

information on the interactions between heavy metals and nitrogen uptake and/or metabolism is scanty for fungi, especially mycorrhizal fungi ( [Blaudez et al., 2000](#)).

The aim of this study was to investigate possible relationships between nitrogen metabolism and responses to heavy metals and oxidative stress in the ericoid mycorrhizal fungus *Oidiodendron maius*, an ascomycete belonging to the Leotiomycetes ( [Chambers et al., 2000](#), [Hambleton et al., 1998](#) and [Perotto et al., 1996](#)). In particular, we used *O. maius* Zn, a metal tolerant strain isolated from a metal-contaminated soil and previously characterized ( [Martino et al., 2000](#), [Martino et al., 2002](#) and [Martino et al., 2003](#)). We show that growth of *O. maius* Zn on heavy metals (Zn and Cd) supplemented media is significantly affected by the nitrogen source.

*O. maius* Zn can be easily grown *in vitro* and genetic tools (e.g. genetic transformation and genome sequencing) have been recently developed to make it a model system for endomycorrhizal fungi ( [Martino et al., 2007](#) and [Abbà et al., 2009](#)). We generated random genetic transformants of *O. maius* Zn by insertional mutagenesis. Screening of this mutant library for sensitivity to heavy metals (Zn and Cd) and oxidative stress (menadione) yielded a mutant strain that carried a partial deletion of the glutamate synthase (*GOGAT*) gene, a key enzyme in nitrogen metabolism, and its adjacent gene, the subunit *APC15* of the anaphase promoting complex (APC/C). Phenotypic comparison (i.e. growth and enzymatic activities) between the WT and the mutant strain indicated that *OmGOGAT-OmAPC15* disruption impaired N-metabolism and altered stress tolerance. Assays on two *OmAPC15*-recomplemented strains ascribed the observed phenotypes to the deletion in the *OmGOGAT* gene. Implications of the *OmGOGAT*-disruption on the reorganization of the nitrogen pathway and on the sensitivity to heavy-metals and oxidative stress are discussed.

## 2. Materials and methods

### 2.1. Fungal isolate and growth media

The fungal isolate investigated in this work is *O. maius* Zn. This strain was isolated from the roots of *Vaccinium myrtillus* growing in the Niepolomice Forest (25 km northeast of Krakow, Poland). This experimental area was treated with 5000 tons/km<sup>2</sup> of dust containing high concentrations of zinc, cadmium and aluminium ( [Martino et al., 2000](#)). This strain is deposited as strain CLM1381 in the Mycotheca Universitatis Taurinensis (MUT), a fungal collection at the Department of Life Sciences and Systems Biology, University of Turin (Italy).

Fungi were grown in both solid (1% agar) and liquid Czapek-glucose mineral medium containing 35 mM NaNO<sub>3</sub>, 5.7 mM K<sub>2</sub>HPO<sub>4</sub> \* 3H<sub>2</sub>O, 2 mM MgSO<sub>4</sub> \* 7H<sub>2</sub>O, 6.7 mM KCl, 36 μM FeSO<sub>4</sub> \* 7H<sub>2</sub>O, 20 mM MES hydrate and 2% (w/v) glucose (all reagents from Sigma). When required, both solid and liquid medium were supplemented with either zinc (as ZnSO<sub>4</sub> \* 7H<sub>2</sub>O, Fluka, 99% purity), cadmium (as 3CdSO<sub>4</sub> \* 8H<sub>2</sub>O, Sigma, 98% purity) or menadione sodium bisulfite (95% purity, Sigma). The solid medium (pH 5.6), was amended with zinc, cadmium and menadione at a final concentration of 15 mM, 0.3 mM and 0.75 mM, respectively, while concentrations in the liquid medium (pH 4) were 10 mM, 0.1 mM and 0.5 mM respectively. All the growth experiments were performed with three replicates per strain per growth condition.

### 2.2. Fungal growth on different nitrogen sources

To measure fungal growth and/or enzymatic activity of both wild type and mutants strains in the presence of different nitrogen sources, solid Czapek-glucose (see Section [2.1](#)) medium (pH 5.6) was supplemented

with nitrogen at a final concentration of 0.49 g/l in different forms: sodium nitrate (NaNO<sub>3</sub>), ammonium sulfate [(NH<sub>4</sub>)<sub>2</sub>SO<sub>4</sub>], ammonium tartrate (C<sub>4</sub>H<sub>6</sub>O<sub>6</sub> \* 2NH<sub>3</sub>), l-glutamine (C<sub>5</sub>H<sub>10</sub>N<sub>2</sub>O<sub>3</sub>), Na-glutamate (C<sub>5</sub>H<sub>8</sub>NNaO<sub>4</sub> \* H<sub>2</sub>O). The required amount of l-glutamine and Na-glutamate was dissolved in an aliquot of the MES solution, filter-sterilized and added aseptically to the autoclaved medium.

Prior to inoculation, sterile cellophane membranes were placed aseptically on the agar surface to provide a convenient means of removing the mycelium from the plate. The membranes were first boiled for 15 min in 10 mM EDTA (disodium salt, dihydrate, Sigma), rinsed and then autoclaved in ddH<sub>2</sub>O. Plates were inoculated with 5 mm fungal plugs. Fungal colonies (3 replicates/treatment) were removed after 30 days by peeling them from the cellophane membranes.

### 2.3. Mutant generation

A mutant collection of the strain *O. maius* Zn was previously obtained through *Agrobacterium*-mediated random insertional mutagenesis (Abbà, unpublished). A modified pCAMBIA0380 plasmid (Cambia, Canberra, Australia), named pCAMBIA0380-hyg and carrying a hygromycin-resistance cassette, was introduced into *A. tumefaciens* LB1100 which was used to transform the un-germinated conidia of the wild type strain according to the protocol described by [Martino et al. \(2007\)](#).

The same protocol was used to obtain the *OmApc15*-recomplemented strains. To construct the vector for *OmApc15* recombination, a fragment of approximately 2.5 kb containing the *OmApc15* ORF, promoter and terminator regions was cloned into the *Apa1/Pst1* digested pCAMBIA0380-ble carrying a phleomycin resistance cassette. Conidia of the *OmGOGAT/OmApc15*-disrupted strain were transformed with *A. tumefaciens* LB1100 carrying this vector. After transformation, a small portion of each transformant was boiled for 15 min in 20 µl Tris-HCl 10 mM pH 8.2, vortexed for 1 min, and 2 µl were directly used for PCR amplification. Two sets of primers were used. The first set (5'-AATCTCAACACAACCGCACA-3'/5'-CCATCTGACTGCTCCCTTGA-3') was designed to amplify the inserted gene (*OmApc15*). The second set (5'-GCATGACGTTATTTATGAGATGGG-3' and 5'-CCATCTGACTGCTCCCTTGA-3') was designed on the hygromycin-resistance gene to check that the original mutation was still maintained.

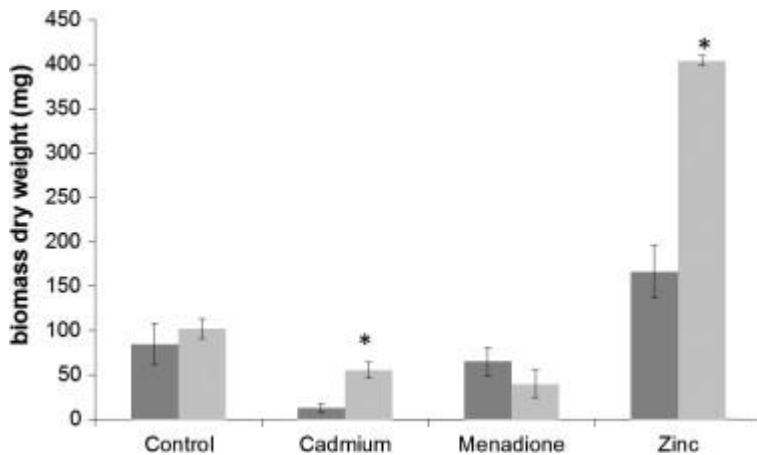
### 2.4. Southern blot

The number of T-DNA insertions in the genome was checked by southern hybridization. The genomic DNA of the WT and the mutants strains, extracted from mycelium grown for 30 days in liquid Czapek-2% glucose medium, was digested with *BglII* restriction enzyme and size-fractionated on 1% (w/v) agarose gel. The southern blot was probed with a fragment of the hygromycin-resistance gene (786 bp, primers: 5'-ATCTGTAGGGCGTCCAAATATC-3' and 5'-CCTGCCTGAAACCGAACTGC-3') with a chemiluminescent detection system (ECL direct DNA labeling and detection system; GE Healthcare, Chalfont St. Giles, U.K.), following the manufacturer's protocol. The number of insertions of the *OmApc15* gene in the genome of the recomplemented strains was checked using the same procedure, with a 1058 bp probe amplified with the same set of primers used for the PCR amplification (see Section [2.3](#)).

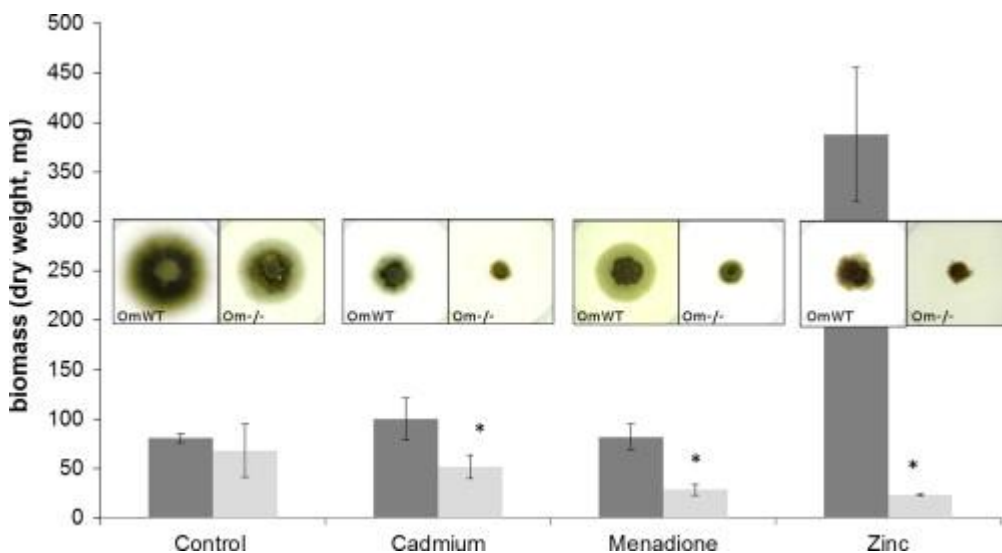
### 2.5. Identification of the mutated gene

Random *O. maius* Zn mutants were screened for their ability to grow on solid medium supplemented with zinc, cadmium or menadione, as described in the previous paragraph. A mutant showing high sensitivity to all the stressing conditions was selected and the mutated gene was identified by using the Thermal Asymmetric Interlaced PCR (TAIL-PCR) method. This method is reported to be a powerful tool for the recovery of DNA fragments adjacent to known sequences ([Liu and Huang, 1998](#)). The two arbitrary

degenerate primers AD1 and AD2 ( Liu and Whittier, 1995) were used in combination with specific primers ( Table 1S) designed on the nucleotide sequence of the pCAMBIA0380 vector, which was used for the transformation. Cycling conditions for TAIL-PCR were performed with some modifications ( Table 2S) of those described by Liu and Whittier (1995). The site of the random insertion was further verified by PCR and sequencing with specific primers designed on *OmGOGAT*, *OmAPC15*, and the hygromycin-resistance cassette borders. To check the WT sequences we also designed primers on the non-coding region between the two genes. The primers position is shown in Fig. 3a (arrows): b; d; e: 5'-CAGTGTGGGGTTCTGTGAA-3'; f: 5'-AATCTCAACACAACCGCACA-3'; g: 5'-GCATGACGTTATTTATGAGATGGG-3'; h: 5'-GCCCAACATGGTGGCCTA-3').

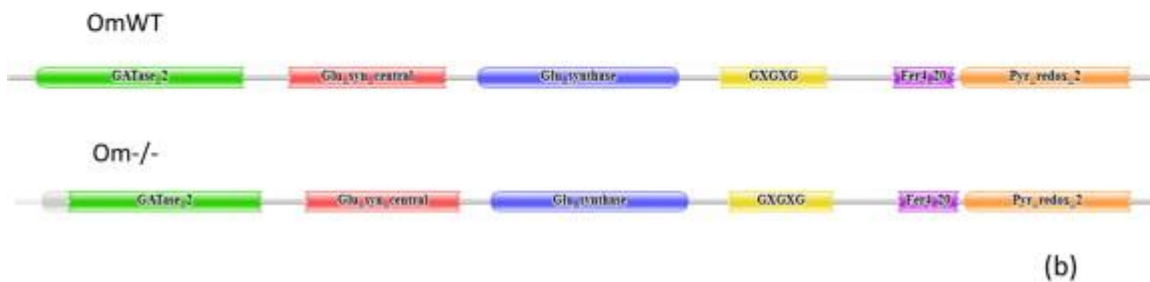
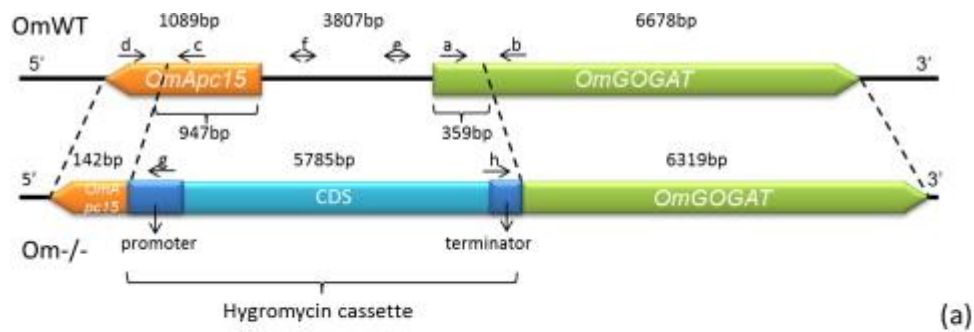


**Fig. 1.** Mycelial growth of the *O. maius* Zn wild type strain, in media supplied with either NaNO<sub>3</sub> (dark gray bars) or glutamine (light gray bars), without (control) or with toxic substances (CdSO<sub>4</sub> 0.1 mM; menadione 0.5 mM, ZnSO<sub>4</sub> 10 mM). The bars represent the average of three replicates, with standard deviation. \* Indicates significant differences between glutamine-supplied samples and the corresponding NaNO<sub>3</sub>-supplied samples.



**Fig. 2.** Stress tolerance of the wild type (dark gray bars, *OmWT*) and the mutant strain (light gray bars, *Om<sup>-/-</sup>*). The two fungal strains were grown both on liquid (bars) and on solid (inset images) media. Liquid media were supplemented or not (control) with 0.1 mM CdSO<sub>4</sub>, 0.5 mM of menadione or 10 mM ZnSO<sub>4</sub>. The bars represent the average of three replicates, with standard deviation. \* Indicates significant differences between the *OmWT* and *Om<sup>-/-</sup>* strains. Solid media were supplemented or not (control) with 0.3 mM CdSO<sub>4</sub>, 0.75 mM of menadione or 15 mM ZnSO<sub>4</sub> and pictures were taken after 30 days of growth.





**Fig. 3.** (a) Map of the insertion site of the hygromycin cassette in the genome of the *OmGOGAT/OmApc15*-disrupted *O. maius* strain. Arrows indicate the position of the primers used for sequencing the site and for RT-PCR analysis (b) GOGAT domain composition according to a Pfam analysis. GATase = Glutamine amidotransferases class-II domain; Glu\_syn\_central = Glutamate synthase central domain; Glu\_synthase = Conserved region in glutamate synthase; GXGXG = glycine-rich structural domain; Fer4\_20 = Dihydropyrimidine dehydrogenase domain II, 4Fe-4S cluster; Pyr\_redox = Pyridine nucleotide-disulfide oxidoreductase.

## 2.6. Semi-quantitative RT-PCR

Total RNA was extracted from WT, *OmGOGAT/OmApc15*-disrupted strain and *OmAPC15*-recomplemented mycelia grown on solid Czapek-glucose medium supplemented with  $\text{NaNO}_3$  as nitrogen source (see Section 2.1). The mycelia were collected, frozen in liquid nitrogen, mechanically ground and RNA was extracted in Tris-HCl extraction buffer (Tris-HCl 100 mM pH 8, NaCl 100 mM, Na-EDTA 20 mM, PVP 0.1%, Na-laurylsarcosine 1% in DEPC-treated  $\text{H}_2\text{O}$ ), followed by phenol (Roti-Phenol, Roth) extraction, phenol:chloroform:isoamyl alcohol (25:24:1) extraction, chloroform extraction, isopropanol 30' precipitation ( $-80^\circ\text{C}$ ), resuspension in DEPC-treated water and over-night precipitation in LiCl 6M ( $4^\circ\text{C}$  on ice). Finally, RNA was pelleted by centrifugation, rinsed with 70% ethanol, air dried on ice and resuspended in DEPC-treated  $\text{H}_2\text{O}$ .

Semi-quantitative RT-PCR was performed on the *OmGOGAT* transcript (5'-AGACAAACCCAGATTGACGCC-3'/5'-CTCATCGGGCTTGAAGAACA-3', respectively a and b arrows in Fig. 3a), *OmApc15* transcript (5'-GAGGACGATGGTGGGGATAG-3'/5'-CCATCTGACTGCTCCCTTGA-3', respectively c and d arrows in Fig. 3a) and the *OmActin* transcript (5'-CCCATTGAGCACGGTGTCTGT-3'/5'-GAGCTTCTCCTTGATGTCGC-3') using the OneStep kit (Qiagen).

## 2.7. Enzyme activity assays

Wild type, mutant and recomplemented strains were grown on solid Czapek-glucose medium containing  $\text{NaNO}_3$  or L-Glutamine. Fungal colonies (3 replicates/treatment) were removed after 30 days by peeling the biomass from the cellophane membranes. Mycelia were then frozen at  $-80^\circ\text{C}$ . Enzymatic assays were performed according to Brun et al. (1992). Proteins were extracted from about 200 mg of mycelium, with the addition of 10% (w/w) of polyvinylpyrrolidone and 1 ml of a cold extraction buffer consisting of 50 mM Tris-HCl (pH 7.6), 5 mM  $\text{MgSO}_4$ , 2 mM  $\text{Na}_2\text{EDTA}$ , 20% (v/v) glycerol, 2% (w/v) polyvinylpyrrolidone

and 14 mM 2-mercaptoethanol. Extracts were centrifuged at 14,000 rpm for 15 min at 4 °C, and protein content, GS and GDH activities were assessed in the supernatants. Soluble protein content was assayed by a modification of the [Bradford method \(1976\)](#). Absorbance was measured at 595 nm. GS activity was determined by a modification of the transferase assay of [Shapiro and Stadtman \(1970\)](#). The reaction mixture contained 10 mM Tris–HCl (pH 7.2), 125 mM L-glutamine, 30 mM NH<sub>2</sub>OH, 20 mM KH<sub>2</sub>AsO<sub>4</sub>, 4 mM EDTA, 20 mM MgSO<sub>4</sub>, 0.5 mM ADP and 200 µl of the enzymatic extract. Absorbance was measured at 540 nm. NADP-GDH activity was measured by following NADPH oxidation at 340 nm. The reaction mixture was made of 100 mM potassium phosphate buffer, 122 mM ammonium phosphate, 8.7 mM 2-oxoglutarate, 156 µM NADPH and 100–150 µl of the enzymatic extract.

### 2.8. Statistical analyses

Statistical analyses were performed either by T-test with Bonferroni correction (significant differences  $P < 0.05$  are indicated by an asterisk) or by ANOVA with Tukey as post hoc test (significant differences  $P < 0.05$  are indicated by different letters, Latin or Greek).

## 3. Results

### 3.1. Different nitrogen sources influence growth of *O. maius* Zn exposed to heavy metals

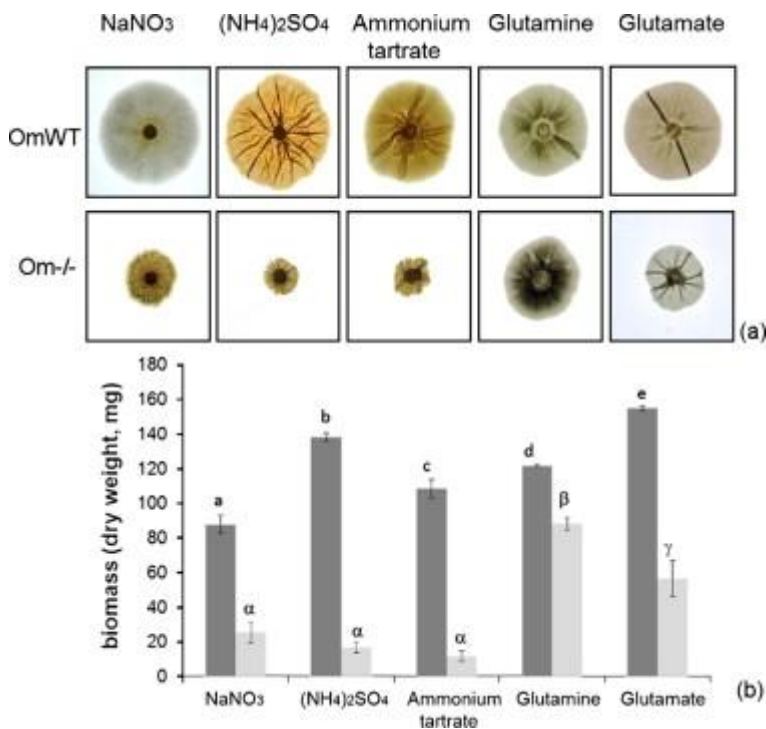
The biomass dry weight of *O. maius* Zn grown in liquid control medium and in media amended with cadmium, menadione or zinc, with either NaNO<sub>3</sub> or glutamine as nitrogen source, is shown in [Fig. 1](#). Mycelia grown on control media were not significantly different on the two nitrogen sources, whereas mycelia grown in the presence of both cadmium and zinc showed a significantly higher biomass on glutamine ([Fig. 1](#)). Overall, growth of *O. maius* Zn on these two metals was very different, confirming the phenotype already observed on NaNO<sub>3</sub> ([Vallino et al., 2011](#)). Growth of *O. maius* Zn on menadione, a reagent causing oxidative stress, was not significantly different on the two nitrogen sources ([Fig. 1](#)). This result indicates a generic positive effect of glutamine on mycelial growth, especially in response to zinc.

### 3.2. Identification of a GOGAT-deletion mutant within a library screened for heavy metal sensitivity

A collection of mutants of *O. maius* Zn was generated by random insertional mutagenesis with *Agrobacterium tumefaciens* (Abbà, unpublished), using the pCAMBIA0380-hyg plasmid. Transformants were individually screened on plate assays for sensitivity to heavy metals (zinc and cadmium) and oxidative stress (menadione). One of the mutants showed a high sensitivity to all the stressing conditions ([Fig. 2](#)). On control medium, the mutant showed a slight reduction of radial growth with respect to the WT ([Fig. 2](#)), but mycelial growth became remarkably reduced when grown on toxic substances ([Fig. 2](#)). This transformant was found to carry a single integration of the hygromycin cassette ([Fig. 1S](#)) that simultaneously caused the deletion of 359 bp at the 5' of glutamate synthase gene (*OmGOGAT*) and the deletion of 947 bp at the 5' of its adjacent gene, *OmApc15*. Deletion of the two genes and of the sequences flanking the hygromycin cassette were double-checked by PCR and sequencing ([Fig. 3a](#)). On *OmGOGAT*, the deletion caused the complete removal of the *OmGOGAT* promoter region and the disruption of the Glutamine amidotransferases class-II domain, which is known to catalyze the glutamine hydrolysis and the subsequent transfer of the ammonia group to a specific substrate ([Figs. 3b and 3S; Vanoni and Curti, 1999](#)).

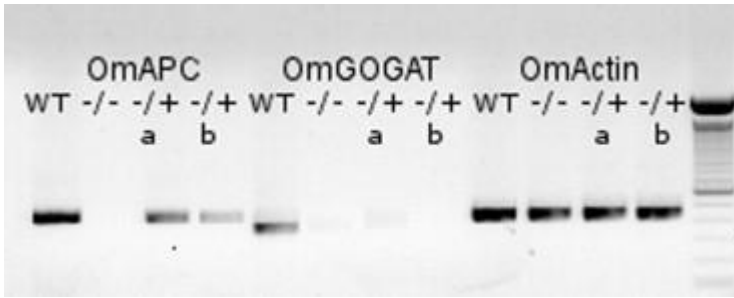
Given the importance of glutamate synthase in nitrogen metabolism, the *OmGOGAT/OmApc15*-disrupted mutant, hereafter called *Om*–/–, was tested on different nitrogen sources. When compared to the WT ([Fig.](#)

4), growth of *Om*<sup>-/-</sup> on solid media was always reduced, especially on inorganic nitrogen sources (nitrate and ammonium). The highest biomass production was induced by glutamine ( Fig. 4).



**Fig. 4.** (a) Mycelium radial growth of the wild type (*Om*WT) and the *OmGOGAT/OmApc15*-disrupted strain (*Om*<sup>-/-</sup>) on solid Czapek-glucose medium containing 0.49 g/l of the following N sources: NaNO<sub>3</sub>, (NH<sub>4</sub>)<sub>2</sub>SO<sub>4</sub>, NH<sub>4</sub> tartrate, glutamine, or glutamate. (b) Mycelium biomass dry weight of the *Om*WT (dark gray bars) and the *Om*<sup>-/-</sup> (light gray bars) strains. Prior to inoculation, sterile cellophane membranes were placed aseptically on the agar surface. Fungal colonies (3 replicates/treatment) were removed after 30 days by peeling the biomass from the cellophane membranes, and biomasses were recorded. The bars represent the average of three replicates, with standard deviation. Latin letters indicate *Om*WT and Greek letters indicate *Om*<sup>-/-</sup> strain.

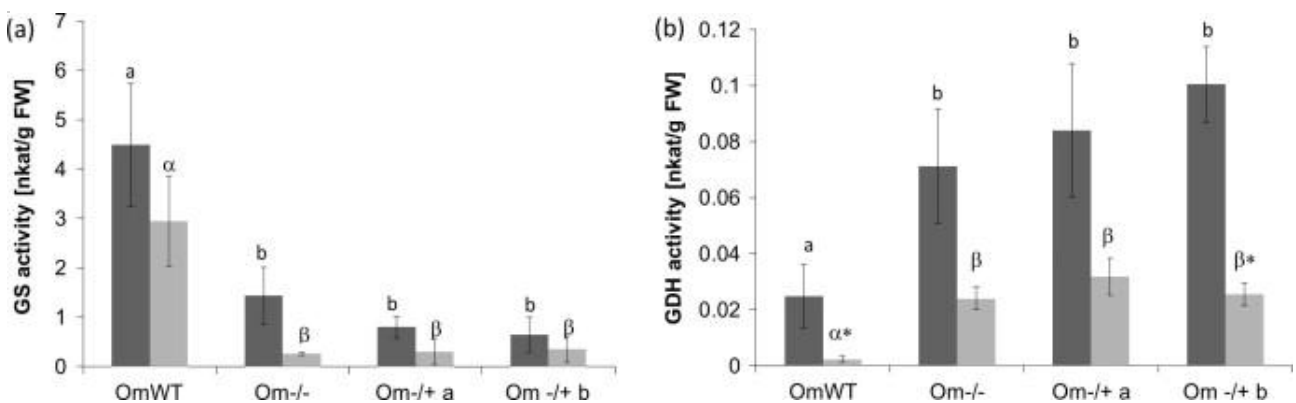
We could not recombine the *OmGOGAT* gene, likely because of its large size (Cogoni et al., 1995 and Romero et al., 2000). In order to emphasize only the effects of the *OmGOGAT* partial deletion on N-metabolism and heavy metal tolerance of *O. maius* Zn, a re-complementation experiment was performed to restore the integrity of the *OmApc15* gene in the *OmGOGAT/OmApc15*-disrupted strain. Two recomplemented strains were used in the subsequent analyses, called *Om*<sup>-/+a</sup> and *Om*<sup>-/+b</sup>. The southern blot analysis confirmed that the *OmApc15* gene was present in a single copy in the WT and in the two recomplemented strains ( Fig. 2Sa). A semi-quantitative RT-PCR was performed to identify the *OmAPC15* and *OmGOGAT* transcripts in the WT, in the *Om*<sup>-/-</sup> mutant and in the two recomplemented strains *Om*<sup>-/+a</sup> and *Om*<sup>-/+b</sup> grown on media supplemented with NaNO<sub>3</sub>. The results showed that both genes are expressed in the WT, while they are not expressed in the *Om*<sup>-/-</sup> mutant. Re-complementation of the *Om*<sup>-/-</sup> mutant with the *OmAPC15* gene rescued its expression in both the recomplemented strains ( Fig. 5).



**Fig. 5.** Semi-quantitative RT-PCR on RNA extracted from mycelia grown on media supplemented with  $\text{NaNO}_3$  as nitrogen source for 30 days, on *OmAPC15*, *OmGOGAT* and *OmActin* genes. WT = wild type strain;  $-/-$  = *OmGOGAT/OmApc15*-disrupted strain;  $-/+a$  and  $-/+b$  *OmAPC15*-recomplemented strains.

### 3.3. *OmGOGAT*-disruption is responsible for the reorganization of N metabolism

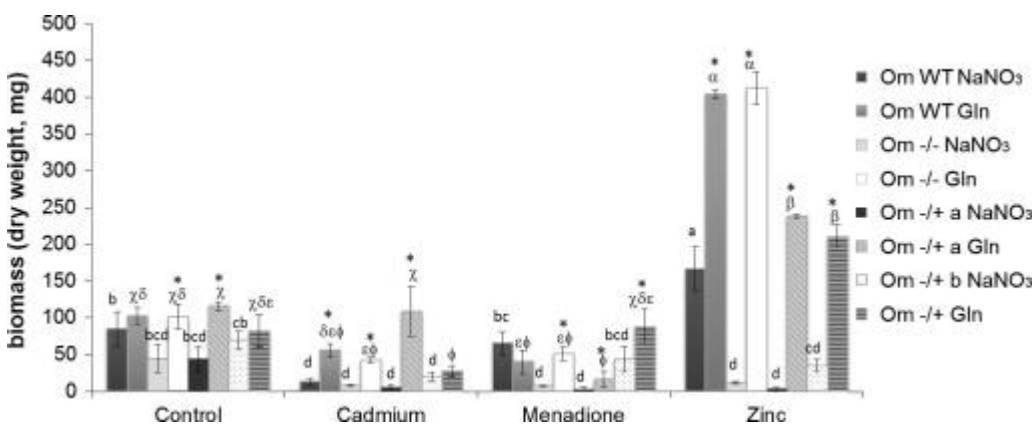
Some fungi can synthesize glutamate either through the NADP-dependent glutamate dehydrogenase (NADP-GDH), or through the combined action of glutamine synthetase (GS) and GOGAT (Inokuchi et al., 2002 and Marzluf, 1997). We therefore tested whether GS and GDH activities were altered in the WT, in the *Om-/-* mutant, and in the two recomplemented strains. Mycelia were grown in the presence of either  $\text{NaNO}_3$  or glutamine as nitrogen source. In the WT, GS activity was not significantly different on media containing  $\text{NaNO}_3$  and glutamine (Fig. 6a). By contrast, GS activity in the *Om-/-* mutant and in the recomplemented strains *Om-/+a* and *Om-/+b* was similar in all growth conditions tested, and always lower than GS activity in the WT (Fig. 6a). GDH activity in the *Om-/-* mutant and in the recomplemented strains *Om-/+a* and *Om-/+b* was, instead, always higher when compared to GDH activity in the WT (Fig. 6b). These results suggest that lack of the *OmGOGAT* gene leads to a reduction in the activity of the associated GS, and increases the alternative pathway for glutamate biosynthesis. They also demonstrate that *OmAPC15* has no effect on these enzyme activities, and *OmGOGAT* disruption is responsible for the changes observed in the N pathway.



**Fig. 6.** (a) Glutamine synthetase (GS) (nkat g<sup>-1</sup> biomass fresh weight) and (b) NADP-glutamate dehydrogenase (GDH) (nkat g<sup>-1</sup> biomass fresh weight) specific activities. *OmWT* = wild type strain; *Om-/-* = *OmGOGAT/OmApc15*-disrupted strain; *Om-/+a* and *Om-/+b* *OmAPC15*-recomplemented strains. The four strains were grown on solid Czapek-glucose medium supplemented with  $\text{NaNO}_3$  (dark gray bars) or glutamine (Gln, light gray bars). Bars represent the average of three replicates, with standard deviation. Latin letters indicate  $\text{NaNO}_3$ -supplied samples and Greek letters indicate Gln-supplied samples. \* Indicates significant differences between Gln-supplied samples and the corresponding  $\text{NaNO}_3$ -supplied samples.

### 3.4. Disruption of the *OmGOGAT* gene increases sensitivity to zinc on some nitrogen sources

The results shown in [Fig. 1](#) indicate that nitrogen source and metabolism influence sensitivity to heavy metals in the *O. maius* Zn WT. To evaluate the effects of *OmGOGAT* disruption on the sensitivity to heavy metals (cadmium and zinc) and oxidative stress, we inoculated the WT, the *Om*<sup>-/-</sup> mutant and the recomplemented strains *Om*<sup>-/+a</sup> and *Om*<sup>-/+b</sup> in liquid media amended with cadmium, menadione or zinc, with either NaNO<sub>3</sub> or glutamine as nitrogen source. [Fig. 7](#) reports the biomass dry weight of mycelia grown with and without (control) toxic substances. No significant differences were recorded among the four fungal strains in control medium, neither on NaNO<sub>3</sub> nor on glutamine. Cd strongly reduced the fungal biomass of all strains grown on nitrate. Significantly higher biomass was obtained on glutamine ([Fig. 7](#)), with the exception of one recomplemented strain (*Om*<sup>-/+b</sup>). As compared with the WT, menadione caused a significant biomass reduction in the *Om*<sup>-/-</sup> mutant and the recomplemented *Om*<sup>-/+a</sup> strain grown on nitrate. This reduction was not statistically significant for the other recomplemented strain. In contrast to the WT, glutamine significantly increased biomass production in all mutant strains, as compared to nitrate ([Fig. 7](#)). Zinc strongly affected the growth of the mutant and the recomplemented strains on NaNO<sub>3</sub>, suggesting a connection between the *OmGOGAT* function and tolerance of *O. maius* to Zn. Similarly to the WT, all mutant mycelia supplied with glutamine grew much better in the presence of zinc.



**Fig. 7.** Mycelial growth in media without (control) or with toxic substances (CdSO<sub>4</sub> 0.1 mM; menadione 0.5 mM, ZnSO<sub>4</sub> 10 mM). The media were supplied with either NaNO<sub>3</sub> or glutamine (Gln) as indicated by the legend. *Om*WT = wild type strain; *Om*<sup>-/-</sup> = *OmGOGAT/OmApc15*-disrupted strain; *Om*<sup>-/+a</sup> and *Om*<sup>-/+b</sup> *OmAPC15*-recomplemented strains. The bars represent the average of three replicates, with standard deviation. Latin letters indicate NaNO<sub>3</sub>-supplied samples and Greek letters indicate Gln-supplied samples. \* Indicates significant differences between Gln-supplied samples and the corresponding NaNO<sub>3</sub>-supplied samples.

Thus, supplied glutamine incremented growth especially when the *OmGOGAT* was deleted. Growth of the *Om*<sup>-/-</sup> mutant and the recomplemented strains *Om*<sup>-/+a</sup> and *Om*<sup>-/+b</sup> was significantly increased by glutamine in all the conditions tested, with only two exceptions concerning the same recomplemented strain *Om*<sup>-/+b</sup>.

## 4. Discussion

### 4.1. Nitrogen assimilation in *O. maius* Zn

The assimilation of ammonia into glutamate and glutamine plays a crucial role in nitrogen metabolism of all organisms. Certain fungi synthesize glutamate either through NADP-GDH, or through the combined action of GS/GOGAT ([Botton and Dell, 1994](#), [Inokuchi et al., 2002](#) and [Marzluf, 1997](#)). [Morel et al. \(2006\)](#) distinguished two groups of fungi. Group I includes fungi with both NADP-GDH and GS activities

(GDH<sup>+</sup> fungi), whereas Group II show no detectable NADP-GDH activity and use GS as the unique pathway for ammonium assimilation (GDH<sup>-</sup> fungi). *O. maius* possesses both enzyme activities and therefore belongs to GDH<sup>+</sup> fungi, which also include *Hebeloma cylindrosporum*, *Cenococcum geophilum*, *Tuber borchii* and *Laccaria bicolor*, with a GS activity significantly higher when compared to the NADP-GDH activity.

The increased activity of NADP-GDH in all the *OmGOGAT*-deleted strains, as compared to the WT, together with the ability of the *Om-/-* mutant to grow on the different nitrogen sources, suggests that nitrogen can cycle through the NADP-GDH pathway in the absence of GOGAT activity. [Macheda et al. \(1999\)](#) highlighted the crucial role of NADP-GDH to rescue the growth of *Aspergillus nidulans* mutants disrupted in the *gltA* (encoding GOGAT) in the presence of ammonium as nitrogen source. In this species, the inactivation of both GOGAT and NADP-GDH activities induced a complete inhibition of fungal growth on ammonium or on nitrogen sources metabolized via ammonium ([Macheda et al., 1999](#)). These data point to a critical role of NADP-GDH in partially rescuing growth defects induced by *OmGOGAT* disruption in *O. maius* Zn mutants. However, we cannot exclude the presence of a third pathway for glutamate biosynthesis, as observed in *S. cerevisiae* ([Avendano et al., 1997](#)). Further analysis by inactivation of the NADP-GDH activity could clarify this hypothesis. *OmGOGAT* disruption led to a reduction of GS activity both on NaNO<sub>3</sub> and on glutamine, suggesting that the GS/GOGAT cycle was blocked. GS is a key metabolic enzyme that synthesizes glutamine from glutamate, leading to the entrance of organic nitrogen in cellular metabolic pathways such as the biosynthesis of amino acids, nucleic acids and complex polysaccharides. GS in plants is finely post-transcriptionally regulated ([Cox and Nelson, 2008](#)) and responds to nitrogen availability in the medium, to the type of available nitrogen source and to abiotic and biotic stress ([Bernard and Habash, 2009](#)).

The reduced growth of the *Om-/-* mutant on the inorganic nitrogen sources tested (nitrate and ammonium) could be explained by the accumulation of glutamate due to the reduced GS activity. In fact, loss of the ability to recycle glutamate into glutamine may result in increased glutamate levels, leading to toxic effects within cells ([Margelis et al., 2001](#)).

#### 4.2. Nitrogen metabolism and stress tolerance in *O. maius* Zn

Nitrogen metabolism is required for biosynthesis of amino acids and proteins, which are involved in nearly all processes in living organisms ([Forde and Clarkson, 1999](#)). It is interesting that the *Om-/-* mutant was selected during a screening aimed to identify stress sensitive random-mutants of the metal tolerant fungus *O. maius* Zn.

[Sharma and Dietz \(2006\)](#) demonstrated the significance of several nitrogen containing metabolites in plant response and acclimation to heavy metals. Amino acids, oligopeptides and polyamines can perform a variety of protective functions, like metal ion chelation, antioxidant defence, protection of macromolecules, and possibly signalling. Thus, nitrogen metabolism might be central to the plant response to heavy metals. On the other hand, considerable effects of metals and the related oxidative stress on nitrogen metabolism have been reported. [Boussama et al. \(1999\)](#) showed an inhibitory effect of Cd on the enzymes involved in nitrate reduction (nitrate/nitrite reductase) and amino acid biosynthesis in *Zea mays* seedlings. [Sutter et al. \(2002\)](#) investigated the potential toxicity of the heavy metals Cd, Pb and Zn by assessing their effects on N metabolism of the aquatic biomonitor moss *Fontinalis antipyretica* ([Bruns et al., 2001](#)). They showed that Cd inhibits nitrate assimilation and amino acid biosynthesis in *F. antipyretica*.



In plants and microorganisms, chelating proteins such as ferritins and metallothioneins, glutathion-derived peptides as well as membrane transporters participate in excess metal storage and detoxification. Low molecular weight organic molecules, mainly organic acids and amino acids and their derivatives, also play an important role in metal homeostasis ([Briat and Lebrun, 1999](#)).

When these systems are overloaded, oxidative stress defense mechanisms are activated.

Living cells possess several mechanisms for maintenance of the redox homeostasis, by a range of non-enzymatic and enzymatic defense systems including molecular scavengers (i.e., glutathione, thioredoxin, and glutaredoxin) and detoxifying enzymes (catalase, superoxide dismutase, and peroxidase) ([Briat and Lebrun, 1999](#) and [Hradilová et al., 2010](#)).

The *Om*<sup>-/-</sup> mutant was shown to have very low GS activity. A number of studies report the involvement of glutamine and GS enzyme activity in the tolerance mechanisms to oxidative stress induced by metals in plants ([Bhatia et al., 2005](#), [Hradilová et al., 2010](#), [Ker and Charest, 2010](#), [Kieffer et al., 2008](#), [Krämer et al., 2000](#), [Rana et al., 2008](#), [Sarry et al., 2006](#), [Sun et al., 2007](#), [Tuomainen et al., 2006](#) and [Wang et al., 2008](#)). Glutamine synthetase was found to be up-regulated by Cd in several plant species ([Kieffer et al., 2008](#), [Rana et al., 2008](#), [Sarry et al., 2006](#) and [Wang et al., 2008](#)), and was positively correlated with Cd tolerance in the hyperaccumulator *Thlaspi caerulescens* ([Tuomainen et al., 2006](#)). Glutamine/glutamate metabolism also mediates glutathione biosynthesis ([Li et al., 1993](#) and [Matés et al., 2002](#)). A possible role of glutathione is to reduce the concentration of free metal ions in the cell and prevent an increase in the production of reactive oxygen species under heavy metal stress ([Xu et al., 2009](#)). The low GS activity in the *OmGOGAT*-deleted strains could then affect the biosynthesis of glutathione, and this observation could therefore partly explain the high sensitivity of the mutants to zinc, cadmium and menadione and the selection of the *Om*<sup>-/-</sup> mutant in the random-mutant screening. Exogenously supplied glutamine could compensate the defect of glutamine biosynthesis and improve growth of the mutant strains, but also increased biomass in the WT. The beneficial effect of glutamine on all strains was particularly evident when mycelia were exposed to zinc. This suggests the involvement of glutamine in the zinc tolerance mechanisms, as reported for plants ([Rossini Oliva et al., 2012](#)). Accumulation of glutamine seems to be an important mechanism for Cd tolerance also in flax ([Hradilová et al., 2010](#)).

In conclusion, the present study demonstrates that there is interplay between nitrogen metabolism and sensitivity to some environmental stresses in *O. maius* Zn. We took advantage of the discovery of a *GOGAT*-deleted strain to get some insights in the *O. maius* Zn nitrogen metabolism. We found that *OmGOGAT* disruption modifies the nitrogen pathway and up-regulates the alternative NADP-GDH pathway. Despite this up-regulation, *O. maius* Zn mutants lacking *OmGOGAT* were found to be very sensitive to zinc unless they were supplemented with glutamine. Thus, the data presented highlight the importance of nitrogen metabolism not only for N assimilation and transformation, but also for other metabolic pathways. For mycorrhizal fungi, such as *O. maius*, this may bear consequences not only to the fungus, but also to the host plant.

## Acknowledgments

H.R.K. was supported by a PhD Fellowship by Italian MIUR and by the Vinci programme. We acknowledge financial support from local funding of University of Turin, the ANR Eumetatox ([06-BLAN-0088](#)), the Biofintree ([ANR-10-INTB-1703-01](#)) projects and from the Ministère de l'Enseignement Supérieur et de la Recherche.

## Appendix A. Supplementary material

**Table 1S.** Primers used for the TAIL-PCR

Feature	Primer name	Primer sequence (5'-3')
Arbitrary degenerate primers	AD1	GTNCGASWCANAWGTT
	AD2	WGTGNAGWANCANAGA
Nested specific primers used in the upstream TAIL-PCR	5P1	CCTGTTGCCGGTCTTGCGATGA
	5P2	GCATGACGTTATTTATGAGATGGG
	5P3	TAGATCGGGAATTAACACTATCAGTG
Nested specific primers used in the downstream TAIL-PCR	3P1	CATCATCAAGGCACCCCG
	3P2	CCTATGCCACCGCCGATCAG
	3P3	GCCTCCTCTAAGCTTGGCTG

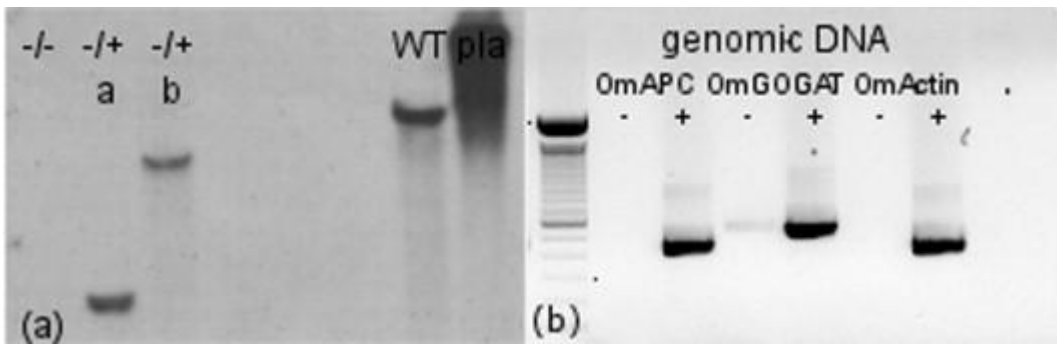
**Table 2S.** Cycling conditions used for TAIL-PCR

Primary reaction			Secondary reaction			Tertiary reaction		
Step	Temperature (°C)	Time (min:s)	Step	Temperature (°C)	Time (min:s)	Step	Temperature (°C)	Time (min:s)
1	92	2:00	1	98	0:30	1	98	0:30
2	98	0:30	2	98	0:10	2	98	0:10
3	98	0:10	3	63	1:00	3	44	1:00
4	63	1:00	4	72	2:00	4	72	2:00
5	72	2:00	5	98	0:10	5	Go to step 2	35 times
6	Go to step 3	5 times	6	63	1:00	6	72	5:00
7	98	0:10	7	72	2:00	7	End	
8	30	3:00	8	98	0:10	8		
9	72	2:00	9	44	1:00	9		
10	98	0:10	10	72	2:00	10		
11	44	1:00	11	Go to step 2	10 times	11		
12	72	2:00	12	72	5:00	12		
13	Go to step 10	10 times	13	End				
14	98	0:10						
15	63	1:00						
16	72	2:00						
17	98	0:10						
18	63	1:00						
19	72	2:00						
20	98	0:10						
21	44	1:00						
22	72	2:00						
23	Go to step 14	12 times						
24	72	5:00						
25	End							





**Supplementary Fig. 1S.** Southern blot analysis: genomic DNA probed with hygromycin amplified PCR product. -/-: genomic DNA from the *O. maius* Zn mutant; WT: genomic DNA from the *O. maius* Zn wild type strain.



**Supplementary Fig. 2S.** (a) Southern blot analysis: genomic DNA probed with OmApc15 PCR product; WT = wild type strain; -/- = *OmGOGAT/OmApc15*-disrupted strain; -/+a and -/+b *OmAPC15*-recomplemented strains; pla = pCAMBIA-ble-OmApc15 (b) control PCR on OmWT genomic DNA - = no DNA; + = with DNA.

1

```

AACCTCCGCGCATTCCACCCGCGCGCTGCTCTCCGCGCGATTCACGATTCAGAGGGCTCTGATGGCCGTC
M A A
TGCAGCTGCATGACGACGACGACGACGACGACGACGACGACGACGACGACGACGACGACGACGACGACG
L D F D D R R Q T Q T I D A E N Q P Y H P Y E Y Q A
CGACGACGACGACGACGACGACGACGACGACGACGACGACGACGACGACGACGACGACGACGACGACG
G N E S W A C A L P V K Q
CGCTCTCTTCGCAAACTACTACTGAGCTGCTCGAGCGCTCTGATGACGCTCATGCGGCTCATGCGAGG
C L Y D P S L K E D A
TGTGCTGCGGATTTGCTGCTGCTGCTGCTGCTGCTGCTGCTGCTGCTGCTGCTGCTGCTGCTGCTGCTG
C C V C P A C
GCGCTCTTAAAGCGGCAAGCGAGCTGAAATGCTGCTGCTGCTGCTGCTGCTGCTGCTGCTGCTGCTGCTG
T G K C K A S E C T I V S I
CAGCGCTACTGCTGCGCTCTCTAGCAGCGAAAGCTCTCTCTGAAATGACGCGATCGGGCGCGCTGGCG
A R R L L C N M T R C A Y
CTCGGATGCGCGAGATGCGCGCGCGCGCGCGCGCGCGCGCGCGCGCGCGCGCGCGCGCGCGCGCGCGCG
C A R D C C D C A C V M T E I P H K Y P P V V K X
TTTGAGCGCGACGATGATGCTACTGCGCGCGCGCGCGCGCGCGCGCGCGCGCGCGCGCGCGCGCGCGCG
S P F T P D I V P P P P P P P P P P P P P P P P P P P P P P P P P P P P P P P P P P
CGAGTGCAGCGACGCTCTGAGGAGTGCAGGAGCGAGTGCAGGAGTGCAGGAGTGCAGGAGTGCAGGAGTGC
D E S T L D R E K R Q L D R I A E R L C L R
GCTGGCTGGCGAGCGCGCGCGCGCGCGCGCGCGCGCGCGCGCGCGCGCGCGCGCGCGCGCGCGCGCGCG
C K W R A P P K D A T L L C P P A A S E R P P
ATGCTGCGACGCTGCTGCTGCTGCTGCTGCTGCTGCTGCTGCTGCTGCTGCTGCTGCTGCTGCTGCTG
L C D P P P V I L S A V I L S E C H A P D T D
AGCGTCTGATGACGATCTCTGCGAGGCGACTCTAGCTGCTGGCGCGCGCGCGCGCGCGCGCGCGCGCG
H F D E R P F E R Q L Y V L L R K X A T T I
CTGCGAGGAGCTGCTGCTGCTGCTGCTGCTGCTGCTGCTGCTGCTGCTGCTGCTGCTGCTGCTGCTG
C G N M P Y L C E L S H K N I V Y K C Q L A I
CTGCGGATGACGATCTCTGCTGCTGCTGCTGCTGCTGCTGCTGCTGCTGCTGCTGCTGCTGCTGCTGCTG
G V Y G V T P Y G L V N A D S E A S P A L Y
CGGCTCTGCGACGACCTCTGCTGCTGCTGCTGCTGCTGCTGCTGCTGCTGCTGCTGCTGCTGCTGCTGCT
H P S T N T Y P L S M D R A Q D L L K W A A H N
TATGCTGCTGCTGCTGCTGCTGCTGCTGCTGCTGCTGCTGCTGCTGCTGCTGCTGCTGCTGCTGCTG
T A S I R
GCTGGCGAGCGACGCTGCTGCTGCTGCTGCTGCTGCTGCTGCTGCTGCTGCTGCTGCTGCTGCTGCTG
P C H K X N N P A S E R C Y N D C S D S P D S
CTGAGGATGCTGCTGCTGCTGCTGCTGCTGCTGCTGCTGCTGCTGCTGCTGCTGCTGCTGCTGCTG
K N L Y P I V R Q C C S D S A A P D N V L
TCTGCACTCAATGCTGCTGCTGCTGCTGCTGCTGCTGCTGCTGCTGCTGCTGCTGCTGCTGCTGCTG
L T T H C V L L D L P H A V N L M V P R A N C
CAAGCTGCTGCTGCTGCTGCTGCTGCTGCTGCTGCTGCTGCTGCTGCTGCTGCTGCTGCTGCTGCTG
A A K H D L K A A P P P V E W A A C C G S P H
CGAGCGCGCGCTGCTGCTGCTGCTGCTGCTGCTGCTGCTGCTGCTGCTGCTGCTGCTGCTGCTGCTG
P A L P P P A D G R Y C C A N L D R N C L
CTGCGAGTACTGCTGCTGCTGCTGCTGCTGCTGCTGCTGCTGCTGCTGCTGCTGCTGCTGCTGCTG
P C H Y Y V M D D D Q I I C A E V C T I Q V
TCTGAGCGCGCTGCTGCTGCTGCTGCTGCTGCTGCTGCTGCTGCTGCTGCTGCTGCTGCTGCTGCTG
P E R V V L K C R L Q P C K M L L V D T L A C
CGATGCTGCTGCTGCTGCTGCTGCTGCTGCTGCTGCTGCTGCTGCTGCTGCTGCTGCTGCTGCTG
R I I D D S E L K N T V A N R H D P K A W L E
ATGAGCTGATGAGCGTCCCAAGTGCATGAGGAGCTCAAGCGTGAAGCGCTCTCTGCTGATTTAGCTCCAA
N E L I S L P K V H E E L T A E G S L D L A P K

```

2

```

GCGGATGGGCTGCTATCCAGAGGATCCGATGCTGCAAGCTTTCGATATTCGTTGACAGGTAGC
P D A A A I Q E D A L L A P D S P P O V
CTGCTGCTGCTGCTGCTGCTGCTGCTGCTGCTGCTGCTGCTGCTGCTGCTGCTGCTGCTGCTGCTG
L L A P M A S E R K R A L L G C N D A P P
CATGCTGCGCAGAGCGCTGCTGCTGCTGCTGCTGCTGCTGCTGCTGCTGCTGCTGCTGCTGCTGCTGCT
C C A A A P P P L L Y P P P P D L P A Q V T N
TCCGATGCTGCTGCTGCTGCTGCTGCTGCTGCTGCTGCTGCTGCTGCTGCTGCTGCTGCTGCTGCTG
L I D F I R E A I Y M E L E C T V C P D G N
CTGAGTGGCTGCTGCTGCTGCTGCTGCTGCTGCTGCTGCTGCTGCTGCTGCTGCTGCTGCTGCTG
E M D S S Q C D B L L P P P P P P P P P P P P P P P P P P P P P P P P P P P P P P
AGCGCTTAAAGATATCAGTGGCTGCTGCTGCTGCTGCTGCTGCTGCTGCTGCTGCTGCTGCTGCTGCTG
H A L R N I S R L L H S F W G I V L I D L T P P
GTCGAGGCTATTCAGGCTATATCAAGCCTTGAATTCATCTGCGAACGAGCGACTGCTGCTGCTGCTG
E R D I Q D T I R E H D P P P C H D A S P A
AACCGCGACAGATCATCTGCTGCTGCTGCTGCTGCTGCTGCTGCTGCTGCTGCTGCTGCTGCTGCTGCT
L P D R I I L L D D A T A T S A D V P P V P A
TTCGCTGGGCTGCTGCTGCTGCTGCTGCTGCTGCTGCTGCTGCTGCTGCTGCTGCTGCTGCTGCTG
A C G M Y H R R L L Y R H R P P P A A L L Y
GACTGGGAGCGAGAGTTCATCAGATGCTGCTGCTGCTGCTGCTGCTGCTGCTGCTGCTGCTGCTGCTG
A R A R R V R H M C V L L C T G A D U G I
TACTGCTATGAGTGCATCTGAGGCTCAAGCTGAGGCTGCTGCTGCTGCTGCTGCTGCTGCTGCTGCTG
L A N E C L L E D H R H G D L V R P P P P
TCTCATCGGACCTACAGTACTCTGCGGATGGGCTGCTGCTGCTGCTGCTGCTGCTGCTGCTGCTGCTG
L I R N Y R Y S A D C G I L L V M C K X C I
CGACTGGGCTTACAGGCGCGAAATCTTGGCGCTTAGGCTTACGACGACTGCGACGACTGCTGCTGCTG
D A S F E C A G I L S A G V D T V V D R
TCTCTAAGCGCGCTGCTGCTGCTGCTGCTGCTGCTGCTGCTGCTGCTGCTGCTGCTGCTGCTGCTGCTG
C P K C T A T R I K C I T P E L I A E D A P R
TCCAGAGGCGGCTGCTGCTGCTGCTGCTGCTGCTGCTGCTGCTGCTGCTGCTGCTGCTGCTGCTGCTG
P H E K G P P S E R Y T V S I P G L A E S G E Y H
CTGAGAGTGGGAGAGCGACATCAAGCGCGCTGCTGCTGCTGCTGCTGCTGCTGCTGCTGCTGCTGCTG
M R D C G E P H I N D P V V S I A N I Q D A V E
AACAAGAGCGAGCTGCTGCTGCTGCTGCTGCTGCTGCTGCTGCTGCTGCTGCTGCTGCTGCTGCTGCTG
E N D E C V E A V S I S E E Q I K B C T I
GCGCTGCTGCTGCTGCTGCTGCTGCTGCTGCTGCTGCTGCTGCTGCTGCTGCTGCTGCTGCTGCTG
R C L L D F K P D E S T P V P V G E P W T E
AATCGTGGCGGCTGCTGCTGCTGCTGCTGCTGCTGCTGCTGCTGCTGCTGCTGCTGCTGCTGCTGCTG
I V E P F C T C A M S Y C S I S M E H S T P
GCGCGCTGCTGCTGCTGCTGCTGCTGCTGCTGCTGCTGCTGCTGCTGCTGCTGCTGCTGCTGCTGCTG
A V A M N E L C C K S N T C E C C E D P P R E
ACAAGTGGGAGAGCGAGTGCATGCTGCTGCTGCTGCTGCTGCTGCTGCTGCTGCTGCTGCTGCTGCTG
E R M A N G D T M R S A I K Q V A S C R F C V T
CTCGACTGCTGCTGCTGCTGCTGCTGCTGCTGCTGCTGCTGCTGCTGCTGCTGCTGCTGCTGCTGCTG
S M Y L A D S D R L Q I K M A Q C A K P C E C
GCGAGCTGCTGCTGCTGCTGCTGCTGCTGCTGCTGCTGCTGCTGCTGCTGCTGCTGCTGCTGCTGCTG
C E L P C H K V S K S I A R T R H S T C V C
TGCCTGCTGCTGCTGCTGCTGCTGCTGCTGCTGCTGCTGCTGCTGCTGCTGCTGCTGCTGCTGCTG
L I S P P P H D I Y S I E D L K Q L I Y D L K
ATCGTCAATCGCGCTGCTGCTGCTGCTGCTGCTGCTGCTGCTGCTGCTGCTGCTGCTGCTGCTGCTGCTG
C E N P R S R S V S K L V S E T C V C I V A E
GCTGCTGCTGCTGCTGCTGCTGCTGCTGCTGCTGCTGCTGCTGCTGCTGCTGCTGCTGCTGCTGCTG
C Y A K A K A D H I L I S C H D C T C A S P R

```

3

```

CGAGCTGATCACTGCTGCTGCTGCTGCTGCTGCTGCTGCTGCTGCTGCTGCTGCTGCTGCTGCTGCTG
T C I R Y A C L P P P P L L C A S T H Q T I V L Y
CAATCACTGCTGCTGCTGCTGCTGCTGCTGCTGCTGCTGCTGCTGCTGCTGCTGCTGCTGCTGCTG
N D L R C R V V V Q T D C Q L R T C R D V A I
GCGCTGCTGCTGCTGCTGCTGCTGCTGCTGCTGCTGCTGCTGCTGCTGCTGCTGCTGCTGCTGCTG
A C L L C A Z E R W C P A T T P L I A R G C I N
TGGAGTGCAGCGACGCTGCTGCTGCTGCTGCTGCTGCTGCTGCTGCTGCTGCTGCTGCTGCTGCTGCTG
M R K C H L N S C P V C I A T Q D P R L R K K F
CGAAGTACCGCTGAGCGCTGCTGCTGCTGCTGCTGCTGCTGCTGCTGCTGCTGCTGCTGCTGCTGCTGCTG
G C T P E R H V I M P P Y I A N E L R A I M A
AACTGGCTTADGACATTAAGATGATGCTGCTGCTGCTGCTGCTGCTGCTGCTGCTGCTGCTGCTGCTG
K L C P P T I N E R M V G C H A R A L R V R E D L
GGAAGAGAGCGCGCGCGCGCGCGCGCGCGCGCGCGCGCGCGCGCGCGCGCGCGCGCGCGCGCGCGCG
R T N K T A N I D L S L I L T P A H K L R P P V
TCTAGCTTCAAGCTTGAAGCAGATCATGCTGCTGCTGCTGCTGCTGCTGCTGCTGCTGCTGCTGCTGCTG
A T P N V R K Q D H R L Y V R L D N K L I S E
GCGAGTGCATGCTGCTGCTGCTGCTGCTGCTGCTGCTGCTGCTGCTGCTGCTGCTGCTGCTGCTGCTG
A E L T L D K E L P E R I E C D I V H T D R A
TGGAGCATCTGCTGCTGCTGCTGCTGCTGCTGCTGCTGCTGCTGCTGCTGCTGCTGCTGCTGCTGCTG
M C T S L S Y Q V S K R Y C E A C L P M D T V H
CTTAAATATCAAAGCTGCTGCTGCTGCTGCTGCTGCTGCTGCTGCTGCTGCTGCTGCTGCTGCTGCTGCTG
V N I K G S A C Q S P G A P L A P G I T L E L
GAAGTGCATGCTGCTGCTGCTGCTGCTGCTGCTGCTGCTGCTGCTGCTGCTGCTGCTGCTGCTGCTG
E C D A N D Y V G K C L S C G R L I I Y P P H
CAGCTGCTTTCAGGCTGATGAGAGCTTATGCTGCTGCTGCTGCTGCTGCTGCTGCTGCTGCTGCTGCTG
A A V P K A D E N S V I V G N V C L Y G A T S G Y
CCTCTGCTGCTGCTGCTGCTGCTGCTGCTGCTGCTGCTGCTGCTGCTGCTGCTGCTGCTGCTGCTG
Y P P R C V A A H R P A V R N S C A T A V V E
GCTGCTGCTGCTGCTGCTGCTGCTGCTGCTGCTGCTGCTGCTGCTGCTGCTGCTGCTGCTGCTGCTG
S V C D H C C E Y M T C G R V L L L C D T G Y
ACTTTCGCTGCTGCTGCTGCTGCTGCTGCTGCTGCTGCTGCTGCTGCTGCTGCTGCTGCTGCTGCTG
N P A A C M E C C I A Y I L D L H H T P M E K I
GAAAGGAGATGCTGCTGCTGCTGCTGCTGCTGCTGCTGCTGCTGCTGCTGCTGCTGCTGCTGCTGCTG
N P E R M V R V S C I D D D A S I A P V R C L I
GAGGACATCATGCTGCTGCTGCTGCTGCTGCTGCTGCTGCTGCTGCTGCTGCTGCTGCTGCTGCTGCTG
E D H H Y T G S E L A A H I L L D P N R A L
CTGACTTTCAGGCTGCTGCTGCTGCTGCTGCTGCTGCTGCTGCTGCTGCTGCTGCTGCTGCTGCTGCTG
S H P V K V L P V D Y K R V L E E R A A K A A E
AGCGAGAGAGCTGCTGCTGCTGCTGCTGCTGCTGCTGCTGCTGCTGCTGCTGCTGCTGCTGCTGCTGCTG
A K R A E P Q I P L P L P T P V R E L V E K E
TCTAAGAGAGAGCTGCTGCTGCTGCTGCTGCTGCTGCTGCTGCTGCTGCTGCTGCTGCTGCTGCTGCTG
S K E K H A K K S D L Q D I E S T V G D A S V
AGAAAAAGCGCTGCTGCTGCTGCTGCTGCTGCTGCTGCTGCTGCTGCTGCTGCTGCTGCTGCTGCTGCTG
E K R R S L V L D K T K C F M K Y Q R R S E K Y
CGCTGCTGCTGCTGCTGCTGCTGCTGCTGCTGCTGCTGCTGCTGCTGCTGCTGCTGCTGCTGCTGCTG
R S A K T R E D W A R L S K R L D R D L R
TACCAGCTGCTGCTGCTGCTGCTGCTGCTGCTGCTGCTGCTGCTGCTGCTGCTGCTGCTGCTGCTGCTG
Q A A R C M D C C V P P C Q S D T C C P I S
ACTCATCGCTGCTGCTGCTGCTGCTGCTGCTGCTGCTGCTGCTGCTGCTGCTGCTGCTGCTGCTGCTG
N I P K W N L I P Q N Q W R D A L N R L L Y
GACCAACACTTCTGCTGCTGCTGCTGCTGCTGCTGCTGCTGCTGCTGCTGCTGCTGCTGCTGCTGCTGCTG
P N N P P R P F T C T G V C P A P C S G A C V L G

```

4

```

ATCAAGAGATCGCGCTGCTGCTGCTGCTGCTGCTGCTGCTGCTGCTGCTGCTGCTGCTGCTGCTGCTGCTG
L N R P P P Y C I F S I S C A I D R C P P P C G
CGATGCTGCTGCTGCTGCTGCTGCTGCTGCTGCTGCTGCTGCTGCTGCTGCTGCTGCTGCTGCTGCTG
W M V P Q P P K V R T C K K Y A V G S C P A E
TCTGCTGCTGCTGCTGCTGCTGCTGCTGCTGCTGCTGCTGCTGCTGCTGCTGCTGCTGCTGCTGCTG
A C A D D Q L N K A C H R A D R Y T V R E A D R A
GCTGCTGCTGCTGCTGCTGCTGCTGCTGCTGCTGCTGCTGCTGCTGCTGCTGCTGCTGCTGCTGCTG
C G L L M Y C I P N M K L D K I V K R R T P
TCTGCTGCTGCTGCTGCTGCTGCTGCTGCTGCTGCTGCTGCTGCTGCTGCTGCTGCTGCTGCTGCTG
P M A A R C I A P K C C V T Y G R S D A I Q L I D
GAAAGCGAGATGAGCGCTGCTGCTGCTGCTGCTGCTGCTGCTGCTGCTGCTGCTGCTGCTGCTGCTGCTG
A Q N D A V V I A T C A T V A R D L P I K N
GCGAGCTGCTGCTGCTGCTGCTGCTGCTGCTGCTGCTGCTGCTGCTGCTGCTGCTGCTGCTGCTGCTG
N L D D I H F A M Q P L R H T K S L I D
AGCTGAGAGCGCGCTGCTGCTGCTGCTGCTGCTGCTGCTGCTGCTGCTGCTGCTGCTGCTGCTGCTGCTG
E L L T D G G Y I S A K C R E D V V V T G C G V Y
TAACTGCTGCTGCTGCTGCTGCTGCTGCTGCTGCTGCTGCTGCTGCTGCTGCTGCTGCTGCTGCTGCTG
N D C I C T S V R H C A K E V T N P P L L P P C
CCTCGAAGAGCGCGCGCGCGCGCGCGCGCGCGCGCGCGCGCGCGCGCGCGCGCGCGCGCGCGCGCGCG
P P H E R A S D N P P Q W P R I Y R V D Y C
ACAAGAGTCAAGAGCGAGTGCAGGAGCGAGTGCAGGAGCGAGTGCAGGAGCGAGTGCAGGAGCGAGTGC
H T E V K G H M C K D P R E Y C V M E R P V Y
TGAAGCGAGCGAGTGCAGGAGCGAGTGCAGGAGCGAGTGCAGGAGCGAGTGCAGGAGCGAGTGCAGGAG
D C T C K V R C I N T I F V R W T E S A T G C
TGGATATGAAGAGTGCAGGAGCGAGTGCAGGAGCGAGTGCAGGAGCGAGTGCAGGAGCGAGTGCAGGAG
H K R V D G C D P P P P A D L L L E H N
TCTAGGCGCTGAGGAGCGAGTGCAGGAGCGAGTGCAGGAGCGAGTGCAGGAGCGAGTGCAGGAGCGAGTGC
P L C P R C R V L G D R I E K D C R K N I K T
GCTGCTGCTGCTGCTGCTGCTGCTGCTGCTGCTGCTGCTGCTGCTGCTGCTGCTGCTGCTGCTGCTG
P C K Y H T N V E C T F A A C C R Y Q S L
ATTGCTGCTGCTGCTGCTGCTGCTGCTGCTGCTGCTGCTGCTGCTGCTGCTGCTGCTGCTGCTGCTG
I V W
TAAAGAGAGCGAGTGCAGGAGCGAGTGCAGGAGCGAGTGCAGGAGCGAGTGCAGGAGCGAGTGCAGGAG
I N R C R Q S A R E V D L Y E L E K P T
CGCGAGCTGCTGCTGCTGCTGCTGCTGCTGCTGCTGCTGCTGCTGCTGCTGCTGCTGCTGCTGCTGCTG
G C I V L L S A Q E I L C V A A S T I P Q V V
GTTGCTGCTGCTGCTGCTGCTGCTGCTGCTGCTGCTGCTGCTGCTGCTGCTGCTGCTGCTGCTGCTG
V A A A T *

```

**Supplementary Fig. 3S** *OmGOGAT* nucleotide and deduced amino acid sequences. The deleted part following the hygromycin cassette insertion is in gray. The GOGAT domains identified by Pfam are highlighted: Glutamine amidotransferases class-II domain in green; Glutamate synthase central domain in red; Conserved region in glutamate synthase in blue; glycine-rich structural domain in yellow; Dihydropyrimidine dehydrogenase domain II, 4Fe-4S cluster in purple; Pyridine nucleotide-disulfide oxidoreductase in light blue.

## References

- S. Abbà, H.R. Khouja, E. Martino, D.B. Archer, S. Perotto. SOD1-Targeted gene disruption in the ericoid mycorrhizal fungus *Oidiodendron maius* reduces conidiation and the capacity for mycorrhization. *Mol. Plant Microbe Int.*, 22 (2009), pp. 1412–1421
- A. Avendano, A. Deluna, H. Olivera, L. Valenzuela, A. Gonzalez. GDH3 encodes a glutamate dehydrogenase isozyme, a previously unrecognized route for glutamate biosynthesis in *Saccharomyces cerevisiae*. *J. Bacteriol.*, 179 (1997), pp. 5594–5597
- K.B. Balestrasse, M.P. Benavides, S.M. Gallego, M.L. Tomaro. Effect of cadmium stress on nitrogen metabolism in nodules and roots of soybean plants. *Func. Plant Biol.*, 30 (2003), pp. 57–64
- S.M. Bernard, D.Z. Habash. The importance of cytosolic glutamine synthetase in nitrogen assimilation and recycling. *New Phytol.*, 182 (2009), pp. 608–620
- N.P. Bhatia, K.B. Walsh, A.J.M. Baker. Detection and quantification of ligands involved in nickel detoxification in a herbaceous Ni hyperaccumulator *Stackhousia tryonii* Bailey. *J. Exp. Bot.*, 56 (2005), pp. 1343–1349
- D. Blaudez, B. Botton, M. Chalot. Cadmium uptake and subcellular compartmentation in the ectomycorrhizal fungus *Paxillus involutus*. *Microbiology*, 146 (2000), pp. 1109–1117
- B. Botton, B. Dell. Glutamate dehydrogenase and aspartate aminotransferase expression in eucalypt ectomycorrhizas. *New Phytol.*, 126 (1994), pp. 249–257
- N. Boussama, O. Ouariti, A. Suzuki, M.H. Ghorbal. Cd-stress on nitrogen assimilation. *J. Plant Physiol.*, 155 (1999), pp. 310–317
- M.M. Bradford. A rapid and sensitive method for the quantitation of microgram quantities of protein utilizing the principle of protein-dye binding. *Anal. Biochem.*, 72 (1976), pp. 248–254
- R. Bradley, A.J. Burt, D.J. Read. Mycorrhizal infection and resistance to heavy metal toxicity in *Calluna vulgaris*. *Nature*, 292 (1981), pp. 335–337
- R. Bradley, A.J. Burt, D.J. Read. The biology of mycorrhiza in the Ericaceae. *New Phytol.*, 91 (1982), pp. 197–209
- J.F. Briat, M. Lebrun. Plant response to metal toxicity. *CR Acad Sci III*, 322 (1999), pp. 43–54
- A. Brun, M. Chalot, B. Botton, F. Martin. Purification and characterization of glutamine synthetase and NADP-glutamate dehydrogenase from the ectomycorrhizal fungus *Laccaria laccata*. *Plant Physiol.*, 99 (1992), pp. 938–944
- I. Bruns, K. Sutter, S. Menge, D. Neumann, G.-J. Krauss. Cadmium lets increase the glutathione pool in bryophytes. *J. Plant Physiol.*, 158 (2001), pp. 79–89
- C. Chaffei, K. Pageau, A. Suzuki, H. Gouia, M.H. Ghorbel, C. Masclaux-Daubresse. Cadmium toxicity induced changes in nitrogen management in *Lycopersicon esculentum* leading to a metabolic safeguard through an amino acid storage strategy. *Plant Cell Physiol.*, 45 (2004), pp. 1681–1693
- S.M. Chambers, G. Liu, J.W.G. Cairney. ITS rDNA sequence comparison of ericoid mycorrhizal endophytes from *Woolfsia pungens*. *Mycol. Res.*, 104 (2000), pp. 168–174
- L.K. Chugh, V.K. Gupta, S.K. Sawhney. Effect of cadmium on enzymes of nitrogen metabolism in pea seedlings. *Phytochemistry*, 31 (1992), pp. 395–400

- C. Cogoni, L. Valenzuela, D. González-Halphen, H. Olivera, G. Macino, P. Ballario, A. González. *Saccharomyces cerevisiae* has a single glutamate synthase gene coding for a plant-like high-molecular-weight polypeptide. *J. Bacteriol.*, 177 (1995), pp. 792–798
- M.M. Cox, D.L. Nelson A. Katherine, R. Rossignol, J. Britch, P. Shriner, P. McCaffrey, E. Geller, B. Moscateli (Eds.), *Lehninger Principles of Biochemistry* (5th ed), W.H. Freeman and Company, New York (2008)
- G. DalCorso, S. Farinati, S. Maistri, A. Furini. How plants cope with cadmium: staking all on metabolism and gene expression. *J. Integr. Plant Biol.*, 50 (2008), pp. 1268–1280
- B.G. Forde, D.T. Clarkson. Nitrate and ammonium nutrition of plants: physiological and molecular perspectives. *Adv. Bot. Res.*, 30 (1999), pp. 1–90
- J.L. Hall. Cellular mechanisms for heavy metal detoxification and tolerance. *J. Exp. Bot.*, 53 (2002), pp. 1–11
- S. Hambleton, K.E. Egger, R.S. Currah. The genus *Oidiodendron*: species delimitation and phylogenetic relationships based on nuclear ribosomal DNA analysis. *Mycologia*, 90 (1998), pp. 854–868
- E.A. Hobbie, P. Högborg. Nitrogen isotopes link mycorrhizal fungi and plants to nitrogen dynamics. *New Phytol.*, 196 (2012), pp. 367–382
- J. Hradilová, P. Řehulka, H. Řehulková, M. Vrbová, M. Griga, B. Brzobohatý. Comparative analysis of proteomic changes in contrasting flax cultivars upon cadmium exposure. *Electrophoresis*, 31 (2010), pp. 421–431
- R. Inokuchi, K.I. Kuma, T. Miyata, M. Okada. Nitrogen assimilating enzymes in land plants and algae: phylogenetic and physiological perspectives. *Physiol. Plant.*, 116 (2002), pp. 1–11
- K. Ker, C. Charest. Nickel remediation by AM-colonized sunflower. *Mycorrhiza*, 20 (2010), pp. 399–406
- P. Kieffer, J. Dommès, L. Hoffmann, J.-F. Hausman, J. Renaut. Quantitative changes in protein expression of cadmium-exposed poplar plants. *Proteomics*, 8 (2008), pp. 2514–2530
- Kłobus, G., Burzyński, M., Buczek, J., 2002. Heavy metals and nitrogen metabolism. In: *Physiology and Biochemistry of Metal Toxicity and Tolerance in Plants*, pp. 325–355.
- U. Krämer, I.J. Pickering, R.C. Prince, I. Raskin, D.E. Salt. Subcellular localization and speciation of nickel in hyperaccumulator and non-hyperaccumulator *Thlaspi* species. *Plant Physiol.*, 122 (2000), pp. 1343–1353
- M.-G. Li, R. Villemur, P.J. Hussey, C.D. Silflow, J.S. Gant, D.P. Snustad. Differential expression of six glutamine synthetase genes in *Zea mays*. *Plant Mol. Biol.*, 23 (1993), pp. 401–407
- Y.G. Liu, N. Huang. Efficient amplification of insert end sequences from bacterial artificial chromosome clones by thermal asymmetric interlaced PCR. *Plant Mol. Biol. Rep.*, 16 (1998), pp. 175–181
- Y.G. Liu, R.F. Whittier. Thermal asymmetric interlaced PCR: automatable amplification and sequencing of insert end fragments from P1 and YAC clones for chromosome walking. *Genomics*, 25 (1995), pp. 674–681
- M.L. Macheda, M.J. Hynes, M.A. Davis. The *Aspergillus nidulans* *gltA* gene encoding glutamate synthase is required for ammonium assimilation in the absence of NADP-glutamate dehydrogenase. *Curr. Genet.*, 34 (1999), pp. 467–471
- S. Margelis, C. D'Souza, A.J. Small, M.J. Hynes, T.H. Adams, M.A. Davis. Role of glutamine synthetase in nitrogen metabolite repression in *Aspergillus nidulans*. *J. Bacteriol.*, 183 (2001), pp. 5826–5833

- E. Martino, K. Turnau, M. Girlanda, P. Bonfante, S. Perotto. Ericoid mycorrhizal fungi from heavy metal polluted soils: their identification and growth in the presence of zinc ions. *Mycol. Res.*, 104 (2000), pp. 338–344
- E. Martino, B. Franco, G. Piccoli, V. Stocchi, S. Perotto. Influence of zinc ions on protein secretion in a heavy metal tolerant strain of the ericoid mycorrhizal fungus *Oidiodendron maius*. *Mol. Cell. Biochem.*, 231 (2002), pp. 179–185
- E. Martino, S. Perotto, R. Parsons, G.M. Gadd. Solubilization of insoluble inorganic zinc compounds by ericoid mycorrhizal fungi derived from heavy metal polluted sites. *Soil Biol. Biochem.*, 35 (2003), pp. 133–141
- E. Martino, C. Murat, M. Vallino, A. Bena, S. Perotto, P. Spanu. Imaging mycorrhizal fungal transformants that express GFP during ericoid endosymbiosis. *Curr. Genet.*, 52 (2007), pp. 65–75
- G.A. Marzluf. Genetic regulation of nitrogen metabolism in the fungi. *Microbiol. Mol. Biol. Rev.*, 61 (1997), pp. 17–32
- J.M. Matés, C.P. Gómez, G.N. Castro, M. Asenjo, J. Márquez. Glutamine and its relationship with intracellular redox status, oxidative stress and cell proliferation/death. *Int. J. Biochem. Cell Biol.*, 34 (2002), pp. 439–558
- A.A. Meharg, J.W.G. Cairney. Co-evolution of mycorrhizal symbionts and their hosts to metal-contaminated environments. *Adv. Ecol. Res.*, 30 (2000), pp. 69–112
- M. Morel, M. Buée, M. Chalot, A. Brun. NADP-dependent glutamate dehydrogenase: a dispensable function in ectomycorrhizal fungi. *New Phytol.*, 169 (2006), pp. 179–190
- S. Perotto, E. Actis-Perino, J. Perugini, P. Bonfante. Molecular diversity of fungi from ericoid mycorrhizal roots. *Mol. Ecol.*, 5 (1996), pp. 123–131
- S. Perotto, E. Martino, S. Abbà, M. Vallino. Genetic diversity and functional aspects of ericoid mycorrhizal fungi. B. Hock (Ed.), *The Mycota, IX: Fungal Associations* (2nd ed.), Springer, Berlin (2012), pp. 255–285
- N. Petrovic, R. Kastori, I. Rajcan. The effect of cadmium on nitrate reductase activity in sugar beet (*Beta vulgaris*). M.L. van Beusichem (Ed.), *Plant Nutrition-Physiology and Applications*, Kluwer Academic Publishers, Dordrecht (1990), pp. 107–109
- N.K. Rana, P. Mohanpuria, S.K. Yadav. Cloning and characterization of a cytosolic glutamine synthetase from *Camellia sinensis* (L.) O. Kuntze that is upregulated by ABA, SA, and H<sub>2</sub>O<sub>2</sub>. *Mol. Biotechnol.*, 39 (2008), pp. 49–56
- D.J. Read, J. Perez-Moreno. Mycorrhizas and nutrient cycling in ecosystems – a journey towards relevance? *New Phytol.*, 157 (2003), pp. 475–492
- M. Romero, S. Guzmán-León, C. Aranda, D. González-Halphen, L. Valenzuela, A. González. Pathways for glutamate biosynthesis in the yeast *Kluyveromyces lactis*. *Microbiology*, 146 (2000), pp. 239–245
- S. Rossini Oliva, M.D. Mingorance, E.O. Leidi. Tolerance to high Zn in the metallophyte *Erica andevalensis* Cabezudo & Rivera. *Ecotoxicology*, 21 (2012), pp. 2012–2021
- J.-E. Sarry, L. Kuhn, P. Le Lay, J. Garin, J. Bourguignon. Dynamics of *Arabidopsis thaliana* soluble proteome in response to different nutrient culture conditions. *Electrophoresis*, 27 (2006), pp. 495–507
- B.M. Shapiro, E.R. Stadtman. Glutamine synthetase. *Methods Enzymol.*, 17 (1970), pp. 910–922

- S.S. Sharma, K.-J. Dietz. The significance of amino acids and amino acid-derived molecules in plant responses and adaptation to heavy metal stress. *J. Exp. Bot.*, 57 (2006), pp. 711–726
- J.M. Sharples, A.A. Meharg, S.M. Chambers, J.W.G. Cairney. Mechanism of arsenate resistance in the ericoid mycorrhizal fungus *Hymenoscyphus ericae*. *Plant Physiol.*, 124 (2000), pp. 1327–1334
- J.M. Sharples, A.A. Meharg, S.M. Chambers, J.W.G. Cairney. Arsenate resistance in the ericoid mycorrhizal fungus *Hymenoscyphus ericae*. *New Phytol.*, 151 (2001), pp. 265–270
- B.K. Singh, B.F. Matthews. Molecular regulation of amino acid biosynthesis in plants. *Amino Acids*, 7 (1994), pp. 165–174
- R.L. Sun, Q.X. Zhou, F.H. Sun, C.X. Jin. Antioxidative defense and proline/phytochelatin accumulation in a newly discovered Cd hyperaccumulator, *Solanum nigrum* L. *Environ. Exp. Bot.*, 60 (2007), pp. 468–476
- K. Sutter, K. Jung, G.-J. Krauss. Effects of heavy metals on the nitrogen metabolism of the aquatic moss *Fontinalis antipyretica* L. ex Hedw. A <sup>15</sup>N tracer study. *Environ. Sci. Pollut. Res.*, 9 (2002), pp. 417–421
- M.H. Tuomainen, N. Nunan, S.J. Lehesranta, A.I. Tervahauta, V.H. Hassinen, H. Schat, K.M. Koistinen, S. Auriola, J. McNicol, S.O. Kärenlampi. Multivariate analysis of protein profiles of metal hyperaccumulator *Thlaspi caerulescens* accessions. *Proteomics*, 6 (2006), pp. 3696–3706
- M. Vallino, E. Zampieri, C. Murat, M. Girlanda, S. Picarella, M. Pitet, E. Portis, E. Martino, S. Perotto. Specific regions in the *Sod1* locus of the ericoid mycorrhizal fungus *Oidiodendron maius* from metal enriched soils show different sequence polymorphism. *FEMS Microbiol. Ecol.*, 75 (2011), pp. 321–331
- M.A. Vanoni, B. Curti. Glutamate synthase: a complex iron-sulfur flavoprotein. *Cell. Mol. Life Sci.*, 55 (1999), pp. 617–638
- L. Wang, Z. Qixing, D. Lingling, S. Yuebing. Effect of cadmium toxicity on nitrogen metabolism in leaves of *Solanum nigrum* L. as a newly found cadmium hyperaccumulator. *J. Hazard. Mater.*, 154 (2008), pp. 818–825
- J. Xu, H.X. Yin, X. Li. Protective effects of proline against cadmium toxicity in micropropagated hyperaccumulator, *Solanum nigrum* L. *Plant Cell Rep.*, 28 (2009), pp. 325–333