



HAL
open science

Some refined Finite volume methods for elliptic problems with corner singularities

Karim Djadel, Serge Nicaise, Jalel Tabka

► **To cite this version:**

Karim Djadel, Serge Nicaise, Jalel Tabka. Some refined Finite volume methods for elliptic problems with corner singularities. *International Journal on Finite Volumes*, 2003, 1 (1), pp.1-33. hal-01114785

HAL Id: hal-01114785

<https://hal.science/hal-01114785>

Submitted on 6 Mar 2015

HAL is a multi-disciplinary open access archive for the deposit and dissemination of scientific research documents, whether they are published or not. The documents may come from teaching and research institutions in France or abroad, or from public or private research centers.

L'archive ouverte pluridisciplinaire **HAL**, est destinée au dépôt et à la diffusion de documents scientifiques de niveau recherche, publiés ou non, émanant des établissements d'enseignement et de recherche français ou étrangers, des laboratoires publics ou privés.

Some refined finite volume methods for elliptic problems with corner singularities

Karim Djadel, Serge Nicaise and Jalel Tabka

Université des Sciences et Techniques de Lille,
Laboratoire de Mathématiques Appliquées,
59655 Villeeneuve d'Ascq cedex, France,
karim.djadel@univ-valenciennes.fr

and

Université de Valenciennes et du Hainaut Cambrésis,
MACS, ISTV,
F-59313 - Valenciennes Cedex 9, France,
e-mail: snicaise,jalel.tabka@univ-valenciennes.fr

Abstract

It is well known that the solution of the Laplace equation in a non convex polygonal domain of \mathbb{R}^2 has a singular behaviour near non convex corners. Consequently we investigate three refined finite volume methods (cell-center, conforming finite volume-element and non conforming finite volume-element) to approximate the solution of such a problem and restore optimal orders of convergence as for smooth solutions. Numerical tests are presented and confirm the theoretical rates of convergence.

Key words: *singularities, mesh refinement, cell-center method, conforming and non conforming finite volume-element methods.*

MOS subject classification: 65N30, 65N15,65N50

1 Introduction

Let Ω be an open subset of \mathbb{R}^2 with a polygonal boundary Γ consisting in a finite union of linear segments $\Gamma_j, j = 1, \dots, N$. Without loss of generality we may assume that the corner $\Gamma_1 \cap \Gamma_N$ is situated at the origin O and that $\Gamma_1 \subset (Ox)$. We further assume that the interior angle at the other corners is $< \pi$. Let us denote by ω the interior opening between Γ_1 and Γ_N (see Figure 1).

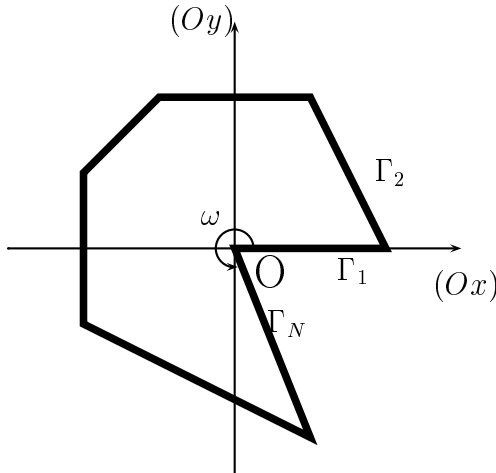

Figure 1: The domain Ω

We consider the standard elliptic problem: For $f \in L^2(\Omega)$ let $u \in H_0^1(\Omega)$ be the variational solution of

$$(1) \quad \begin{cases} -\Delta u &= f & \text{in } \Omega, \\ u &= 0 & \text{on } \Gamma. \end{cases}$$

It is well known that in the case $\omega \in]\pi, 2\pi[$ (i.e. Ω is non convex), the solution of (1) presents a corner singularity at O [18]. More precisely, if we introduce the weighted Sobolev space

$$H^{2,\beta}(\Omega) := \{v \in H^1(\Omega) \mid |v|_{2,\beta,\Omega}^2 := \sum_{|\alpha|=2} \int_{\Omega} |r^\beta D^\alpha v|^2 dx < +\infty\},$$

where $r := r(x) = d(x, O), x \in \Omega$ and $\beta \geq 0$, then the solution $u \in H_0^1(\Omega)$ of (1) belongs to $H^{2,\beta}(\Omega)$, for $1 - \frac{\pi}{\omega} < \beta < \frac{1}{2}$, while $u \notin H^2(\Omega)$ in the non convex case (for more details see for instance [18]). Moreover we have the estimate

$$(2) \quad |u|_{2,\beta,\Omega} \lesssim \|f\|_{0,\Omega},$$

where $a \lesssim b$ means here and below that there exists a positive constant C independent of a and b (and of the meshsize of the triangulation) such that $a \leq C b$.

In the case of a non convex domain Ω , different refined finite element methods have been considered to compensate the effect of the singularities (see [28, 26, 18, 14, 3]). To our knowledge this point of view is mainly not considered for finite volume methods (see [21]), while they are widely used in the approximation of practical problems from Physics and Mechanics [7, 25, 16]. Our goal is then to discretize the problem (1) by some refined finite volume methods. The first one is the so-called “cell-center” method based on a mechanical approach (see [16, 21, 17, 27]). We secondly consider two finite volume-element methods (called also box methods), methods which are combinations of the finite element methods and of the finite volume methods (see [4, 19, 6, 8, 9]). In both cases we establish optimal rates of convergence if the meshes are appropriately refined near nonconvex corners of the domain. Our method actually combines the standard error analysis of finite volume schemes approximating smooth solutions with the error analysis for finite element methods for nonsmooth solutions.

In the whole paper the spaces $H^s(\Omega)$, with any nonnegative integer s , are the standard Sobolev spaces in Ω with norm $\|\cdot\|_{s,\Omega}$ and semi-norm $|\cdot|_{s,\Omega}$. The space $H_0^1(\Omega)$ is defined, as usual, by $H_0^1(\Omega) := \{v \in H^1(\Omega)/v = 0 \text{ on } \Gamma\}$. $L^p(\Omega)$, $p > 1$, are the usual Lebesgue spaces with norm $\|\cdot\|_{0,p,\Omega}$ (as usual we drop the index p for $p = 2$). In the sequel the symbol $|\cdot|$ will denote either the Euclidean norm in \mathbb{R}^n ($n = 1$ or 2), or the Euclidean matrix norm, or the length of a line segment or finally the area of a plane region.

The schedule of the paper is as follows: In section 2 we describe the so-called “cell-center” method and show that appropriate refinement conditions on the admissible meshes lead to optimal order of convergence as in the smooth case. Section 3 is devoted to the analysis of the conforming finite volume-element method. In that case we prove optimal order of convergence in the H^1 -norm using a trace theorem in weighted Sobolev spaces and appropriate refinement conditions on the primal meshes. Under some additional conditions on f and on the dual meshes, we further obtain a double order of convergence in the L^2 - norm using a duality argument. The same strategy is adopted in section 4 for the nonconforming finite volume-element method. We finish the paper by some numerical tests which confirm that the use of refined meshes improves significantly the order of convergence.

2 The “cell-center” method

We start with the notion of *admissible mesh* (in the sense of “cell-center” finite volume method), this definition is motivated by the consistency of our discretization scheme.

Definition 2.1 *An admissible mesh of Ω , denoted by τ is a given triplet $(\mathcal{V}, \mathcal{P}, \mathcal{E})$ where*

- a. \mathcal{V} is a finite set of convex open polygons of Ω , called control volumes,
- b. \mathcal{P} denotes a set of points of Ω such that each control volume contains exactly **one and only one point** of \mathcal{P} ,
- c. \mathcal{E} represents the set of edges of the control volumes,

with the following properties:

1. $\cup_{K \in \mathcal{V}} \overline{K} = \overline{\Omega}$.
2. For all control volumes K and L , $\overline{K} \cap \overline{L}$ is either empty, either a point, or a full edge of K and L .
3. Let $x_K, x_L \in \mathcal{P}$, with $x_K \in K, x_L \in L$ and $K, L \in \mathcal{V}$. If $\overline{K} \cap \overline{L} =: \sigma \in \mathcal{E}$, then the segment $[x_K x_L]$ is orthogonal to σ (see Figure 2).
4. If $\sigma \in \mathcal{E}$, if there exists $K \in \mathcal{V}$ such that $\sigma \subset \partial\Omega \cap \partial K$ and if we denote by $D_{K,\sigma}$ the half-line with origin x_K and perpendicular to σ , then $D_{K,\sigma} \cap \sigma =: \{y_\sigma\} \neq \emptyset$.

Finally we define the mesh size of τ , denoted by h , as

$$h := \max_{K \in \mathcal{V}} \text{diam}(K).$$

2.1 The numerical scheme

Let us fix an admissible mesh τ and denote by $\{u_K\}_{K \in \mathcal{V}}$ the unknowns of the problem (u_K being the approximation of $u(x_K)$, for $K \in \mathcal{V}$).

We are now ready to formulate the approximation of problem (1) in the “cell-center” sense. Integrating (1) on a control volume K and using the divergence formula, we arrive at

$$(3) \quad - \sum_{\sigma \in \mathcal{E}_K} \int_{\sigma} \nabla u \cdot n_{K,\sigma} ds = \int_K f(x) dx, \forall K \in \mathcal{V},$$

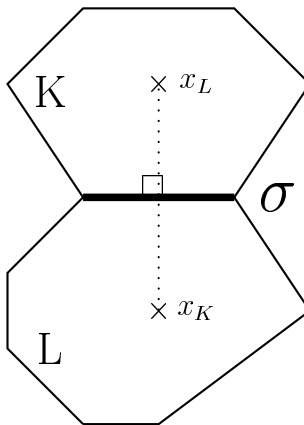

Figure 2: Example of common edge σ

where \mathcal{E}_K is the set of edges of K and $n_{K,\sigma}$ is the unit outward normal vector to K along σ .

The expressions $\nabla u \cdot n_{K,\sigma}$ are now approximated using finite differences and the principle of conservation of flux (see [16]). These successive approximations lead to the following system:

$$(4) \quad - \sum_{\sigma \in \mathcal{E}_K} F_{K,\sigma} = \int_K f(x) dx, \forall K \in \mathcal{V},$$

where

$$F_{K,\sigma} := \begin{cases} |\sigma| \frac{u_L - u_K}{d(x_K, x_L)} & \text{if } \sigma = \overline{K} \cap \overline{L}, \\ |\sigma| \frac{-u_K}{d(x_K, y_\sigma)} & \text{if } \sigma \subset \overline{K} \cap \partial\Omega. \end{cases}$$

We recall that this system is well defined as proved for instance in [16]:

Proposition 2.2 *Let τ be an admissible mesh of Ω . Then the system (4) admits a unique solution $(u_K)_{K \in \mathcal{V}}$.*

2.2 The error estimate

In order to get an optimal error estimate between the exact solution and its approximation, as for finite element methods [28], we require some refinement conditions on the meshes.

Definition 2.3 An admissible mesh τ of Ω is called a β -refined admissible mesh, with $\beta \in [0, 1)$ if there exists $\xi > 0$ such that for all $K \in \mathcal{V}$:

- (H1) $h_K \leq \xi d(x_K, \sigma), \forall \sigma \in \mathcal{E}_K,$
(H2) $h_K \leq \xi h^{\frac{1}{1-\beta}},$ if $O \in \partial K$,
(H3) $h_K \leq \xi h \inf_{x \in K} r(x)^\beta,$ if $O \notin \partial K$.

Combining the arguments of [16] and those of [28] we can prove the following error estimate:

Theorem 2.4 Let τ be a β -refined admissible mesh of Ω with $1 - \frac{\pi}{\omega} < \beta < \frac{1}{2}$, let $(u_K)_{K \in \mathcal{V}}$ be the solution of (4) and $u \in H_0^1(\Omega) \cap H^{2,\beta}(\Omega)$ be the solution of (1). Let us introduce the function $e_\tau : \Omega \rightarrow \mathbb{R} : x \rightarrow e_\tau(x)$, where

$$e_\tau(x) = \begin{cases} e_K = u(x_K) - u_K & \text{if } x \in K, K \in \mathcal{V}, \\ 0 & \text{else.} \end{cases}$$

Then it holds:

$$(5) \quad \|e_\tau\|_{0,\Omega} \lesssim h|u|_{2,\beta,\Omega}.$$

Proof: Remark first that from Lemma 8.4.1.2 of [18] the space $H^{2,\beta}(\Omega)$ is continuously embedded into $C^0(\overline{\Omega})$ if $\beta < 1$. This allows to give a meaning to $u(x_K)$ for our solution u of (1).

For any $K \in \mathcal{V}, \sigma \in \mathcal{E}_K$ let us set

$$\nu_{K,\sigma} := \{(1-t)x_K + tx/x \in \sigma, t \in [0, 1]\},$$

and define

$$\begin{aligned} \nu_\sigma &:= \begin{cases} \nu_{K,\sigma} \cup \nu_{L,\sigma} & \text{if } \sigma = \overline{K} \cap \overline{L}, \\ \nu_{K,\sigma} & \text{if } \sigma = \partial K \cap \partial\Omega, \end{cases} \\ R_{K,\sigma} &:= \begin{cases} \frac{u(x_L) - u(x_K)}{d_\sigma} - \frac{1}{|\sigma|} \int_\sigma \nabla u \cdot n_{K,\sigma} ds & \text{if } \sigma = \overline{K} \cap \overline{L}, \\ \frac{-u(x_K)}{d_\sigma} - \frac{1}{|\sigma|} \int_\sigma \nabla u \cdot n_{K,\sigma} ds & \text{if } \sigma = \partial K \cap \partial\Omega, \end{cases} \\ d_\sigma &:= \begin{cases} d(x_K, x_L) & \text{if } \sigma = \overline{K} \cap \overline{L}, \\ d(x_K, \partial\Omega) & \text{if } \sigma = \partial K \cap \partial\Omega. \end{cases} \end{aligned}$$

The key step is to show that for all $K \in \mathcal{V}, \sigma \in \mathcal{E}_K$ we have

$$(6) \quad |R_{K,\sigma}| \lesssim \frac{h}{(|\sigma|d_\sigma)^{\frac{1}{2}}} |u|_{2,\beta,\nu_\sigma}.$$

Indeed if we assume that (6) holds then the estimate (5) follows in a quite standard way: Introduce the mesh depending norm [16]:

$$\|v\|_\tau^2 := \sum_{\sigma \in \mathcal{E}} \frac{|\sigma|}{d_\sigma} |D_\sigma v|^2,$$

where $D_\sigma v := v_L - v_K$ if $\sigma \in \mathcal{E} \cap \Omega$, and $D_\sigma v := -v_K$ if $\sigma \in \mathcal{E} \cap \Gamma$.

Let us now show that

$$(7) \quad \|e_\tau\|_\tau \lesssim h|u|_{2,\beta,\Omega}.$$

Indeed the arguments of Theorem 3.3 of [16] yield

$$\|e_\tau\|_\tau^2 \leq \sum_{K \in \mathcal{V}} \sum_{\sigma \in \mathcal{E}_K} |\sigma| |R_{K,\sigma}| |e_K|.$$

Consequently by Cauchy-Schwarz's inequality we obtain

$$\|e_\tau\|_\tau^2 \leq \|e_\tau\|_\tau \left(\sum_{\sigma \in \mathcal{E}} |\sigma| d_\sigma R_\sigma^2 \right)^{\frac{1}{2}},$$

where for all $K \in \mathcal{V}, \sigma \in \mathcal{E}_K, R_\sigma := |R_{K,\sigma}|$. The estimate (6) in the above one shows (7).

The requested estimate (5) then follows from (7) and the so-called discrete Poincaré's inequality (which is valid for a non convex domain Ω , see Lemma 3.1 of [16]):

$$(8) \quad \|e_\tau\|_{0,\Omega} \leq \text{diam}(\Omega) \|e_\tau\|_\tau.$$

It then remains to establish the estimate (6): First we remark that it suffices to show (6) for $u \in C^2(\overline{\Omega})$, since it is proved in Theorem 3.2.2 of [29] that $C^\infty(\overline{\Omega})$ is dense in $W_2^2(\Omega, r^\beta)$, where the space $W_2^2(\Omega, r^\beta)$ is defined by

$$W_2^2(\Omega, r^\beta) := \{v \in \mathcal{D}'(\Omega) : r^\beta D^\alpha v \in L^2(\Omega), \forall |\alpha| \leq 2\},$$

equipped with its natural norm and since we have the obvious embedding

$$H^{2,\beta}(\Omega) \hookrightarrow W_2^2(\Omega, r^\beta).$$

We now distinguish the following cases:

First case: $\sigma = \overline{K} \cap \overline{L}$ with some $K, L \in \mathcal{V}$ (i.e. σ is an interior edge).

Using a local coordinate system, without loss of generality we may assume that $\sigma = \{a\} \times \sigma'$, where σ' is a segment of the y -axis, and that $x_K := (a - \alpha, b)^T$, $x_L := (a + \gamma, b)^T$ with $b \in \sigma'$ and $\alpha, \gamma > 0$ (see Figure 3).

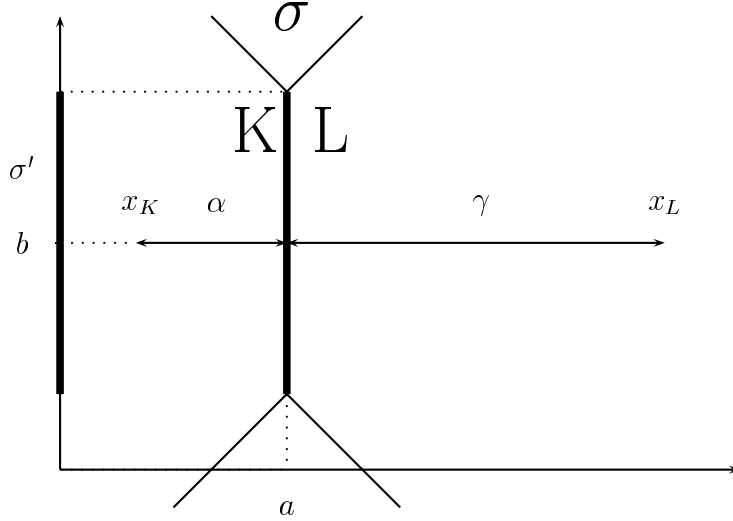

Figure 3: Illustration of the first case

Using a Taylor expansion of u with an integral remainder, for any $x \in \sigma$, we may write

$$u(x_M) - u(x) = \nabla u(x) \cdot (x_M - x) + \int_0^1 (x_M - x)^t H(u)(tx + (1-t)x_M)(x_M - x)tdt,$$

for $M = K$ or L , where $H(u)$ is the Hessian matrix of u . Subtracting the above identities, remarking that $x_L - x_K = n_{K,\sigma}d_\sigma$, and integrating on σ , we arrive at

$$(9) \quad R_{K,\sigma} \leq B_{K,\sigma} + B_{L,\sigma},$$

where we have set

$$B_{K,\sigma} := \frac{1}{|\sigma|d_\sigma} \int_\sigma \int_0^1 |H(u)(tx + (1-t)x_K)| |x_K - x|^2 tdt dx.$$

Using cartesian coordinates z in the above definition (as $dz := dx dy = t \alpha dt dx$) and remarking that $|x_K - x| \leq h_K$, for all $x \in \sigma$, we deduce that

$$(10) \quad B_{K,\sigma} \leq \frac{h_K^2}{|\sigma| d_\sigma \alpha} \int_{\nu_{K,\sigma}} |H(u)(z)| dz.$$

Applying Cauchy-Schwarz's inequality we arrive at

$$(11) \quad B_{K,\sigma} \leq \frac{h_K^2}{|\sigma| d_\sigma \alpha} \left(\int_{\nu_{K,\sigma}} r^{-2\beta} dz \right)^{\frac{1}{2}} |u|_{2,\beta,\nu_{K,\sigma}}.$$

The estimation of the above integral requires to distinguish the case when $O \in \partial K$ or not.

If $O \notin \partial K$, then the assumption (H3) allows to write

$$\int_{\nu_{K,\sigma}} r^{-2\beta} dz \leq \frac{\xi^2 h^2}{h_K^2} \int_{\nu_{K,\sigma}} \inf_{x \in K} r(x)^{2\beta} r(z)^{-2\beta} dz.$$

As $\nu_{K,\sigma} \subset K$ we get

$$\int_{\nu_{K,\sigma}} r^{-2\beta} dz \leq \frac{\xi^2 h^2}{h_K^2} \int_{\nu_{K,\sigma}} r^{-2\beta} r^{2\beta} dz \leq \frac{\xi^2 h^2}{h_K^2} |\nu_{K,\sigma}|.$$

Since $|\nu_{K,\sigma}| = \frac{\alpha|\sigma|}{2}$ we deduce that

$$(12) \quad \int_{\nu_{K,\sigma}} r^{-2\beta} dz \leq C(\xi) \alpha |\sigma| \frac{h^2}{h_K^2},$$

for some positive constant $C(\xi)$ (depending only on ξ).

If $O \in \partial K$, then a direct calculation yields

$$(13) \quad \int_{\nu_{K,\sigma}} r^{-2\beta} dz \leq C_1(\xi, \beta) |\sigma| \alpha h_K^{-2\beta},$$

where $C_1(\xi, \beta) := \frac{1}{(1-2\beta)\xi^{2\beta}}$. Since the assumption (H2) yields $h_K^{-\beta} \leq \xi^{1-\beta} \frac{h}{h_K}$, this estimate in the above one shows that (12) still holds in this second case.

Inserting the estimate (12) in (11) we have obtained

$$(14) \quad B_{K,\sigma} \lesssim \frac{h}{(|\sigma| d_\sigma)^{\frac{1}{2}}} |u|_{2,\beta,\nu_{K,\sigma}},$$

since $d_\sigma = d(x_K, x_L) \geq \alpha \geq \frac{1}{\xi} h_K$, due to the assumption (H1).

Since a similar estimate holds for $B_{L,\sigma}$, the estimates (9) and (14) lead to (6).

Second case: $\sigma = \partial K \cap \partial\Omega$ for some $K \in \mathcal{V}$. As in the first case we may assume that $\sigma := \{a\} \times \sigma'$, for some segment σ' of the y -axis and $x_K := (a - 2\alpha, b)^T$, for some $b \in \sigma'$ and $\alpha > 0$ (see Figure 4). We further introduce $\tilde{\sigma} = \{\frac{1}{2}x_K + \frac{1}{2}x/x \in \sigma\}$ and set

$$I_\sigma := \frac{1}{|\sigma|} \int_\sigma \nabla u \cdot n_{K,\sigma} ds, I_{\tilde{\sigma}} := \frac{1}{|\tilde{\sigma}|} \int_{\tilde{\sigma}} \nabla u \cdot n_{K,\tilde{\sigma}} ds.$$

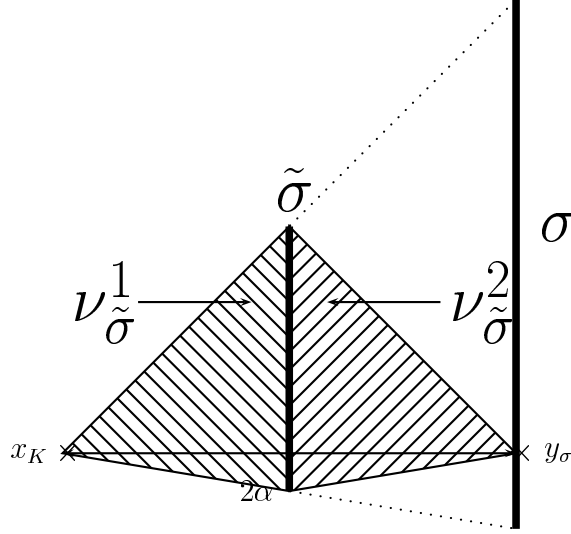

Figure 4:

Setting $R_{K,\tilde{\sigma}} := \frac{-u(x_K)}{2\alpha} - I_{\tilde{\sigma}}$ we remark that

$$(15) \quad R_{K,\sigma} \leq R_{K,\tilde{\sigma}} + |I_\sigma - I_{\tilde{\sigma}}|.$$

So it remains to estimate the two above terms. For the first one we argue as in the first case replacing σ by $\tilde{\sigma}$. This allows to obtain

$$R_{K,\tilde{\sigma}} \lesssim \frac{h_K}{|\tilde{\sigma}|\alpha} \left(\int_{\nu \frac{1}{\tilde{\sigma}}} |H(u)(z)| dz + \int_{\nu \frac{2}{\tilde{\sigma}}} |H(u)(z)| dz \right),$$

where we have set $\nu_{\tilde{\sigma}}^1 := \{(1-t)x_K + t\tilde{x}/\tilde{x} \in \tilde{\sigma}, t \in [0, 1]\}$, and $\nu_{\tilde{\sigma}}^2 := \{(1-t)y_\sigma + t\tilde{x}/\tilde{\alpha} \in \tilde{\sigma}, t \in [0, 1]\}$.

Furthermore using a Taylor expansion of order 1 of $\nabla u \cdot n_{K,\sigma}(\cdot)$ on σ , and making a change of variables, we have

$$(16) \quad |I_\sigma - I_{\tilde{\sigma}}| \lesssim \frac{h_K}{|\sigma|^\alpha} \int_{E_\sigma} |H(u)(z)| dz,$$

where $E_\sigma := \{(1-t)x_K + tx/x \in \sigma, t \in [\frac{1}{2}, 1]\}$.

At this stage using similar arguments as in the first case one easily shows that (since $\nu_{\tilde{\sigma}}^1 \cup \nu_{\tilde{\sigma}}^2 \subset \nu_{K,\sigma}$ and $E_\sigma \subset \nu_{K,\sigma}$)

$$\begin{aligned} R_{K,\tilde{\sigma}} &\lesssim \frac{h}{(|\sigma|d_\sigma)^{\frac{1}{2}}} |u|_{2,\beta,\nu_{K,\sigma}}, \\ |I_\sigma - I_{\tilde{\sigma}}| &\lesssim \frac{h}{(|\sigma|d_\sigma)^{\frac{1}{2}}} |u|_{2,\beta,\nu_{K,\sigma}}. \end{aligned}$$

In conclusion, these estimates into (15) show that (6) still holds in this second case. ■

Remark 2.5 Under some restrictive hypotheses on the mesh τ , (5) may be proved combining the results from [5] and [15]. Indeed, the results from [5] show that the system (4) may be obtained using a mixed formulation of (1). On the other hand, for non convex domains, optimal error estimates for the mixed approximation of (1) on refined meshes are obtained in [15]. Our results are also in accordance with those from [21], obtained for particular meshes τ .

Remark 2.6 Our method may be adapted to the study of singularly perturbed reaction diffusion problems for which the use of anisotropic meshes (i.e. which do not satisfy the assumption (H1)) is appropriate. Such meshes were used in [2, 3] for the discretization of the above mentioned problem using standard FEM (see also [24] for the use of a finite volume method).

3 The conforming finite volume-element method

As usual this method uses a triangulation of Ω which is the *primal mesh*, this one allowing to build a set of boxes, called the *dual mesh* (these boxes playing the rule of the control volumes for the "cell-center" finite volume method, see Definition 2.1). We then approximate the solution u of (1) in a conforming finite element space

based on the primal mesh but using a discretization of an integral formulation of the problem on the boxes of the dual mesh. Note that the principle of conservation of flux on the primal mesh is implicitly satisfied.

The primal mesh is a regular triangulation of Ω in Ciarlet's sense [11] (see below). We now call $E_h(K)$, resp. $Z_h(K)$, the set of edges, resp. vertices, of $K \in T_h$; and then set $E_h := \bigcup_{K \in T_h} E_h(K)$, $Z_h := \bigcup_{K \in T_h} Z_h(K)$. We further set $Z_h^{in} := Z_h \cap \Omega$ as the set of interior vertices of the triangulation. The dual mesh is now build as follows: consider z_K an arbitrary interior point of $K \in T_h$ and for $e \in E_h(K)$, we set m_e the midpoint of e . For $K \in T_h$ and $z \in Z_h(K)$, we clearly have $z := \bar{e} \cap \bar{l}$, with $e, l \in E_h(K)$; with these notation we set $b_{z,K} := Conv[z_K, z, m_e, m_l]$. The box associated with $z \in Z_h$ is then defined by $b_z := \bigcup_{\{K \in T_h : z \in Z_h(K)\}} b_{z,K}$ (see Figure 5) and the set of boxes, or control volumes, is $B_h := \{b_z : z \in Z_h\}$.

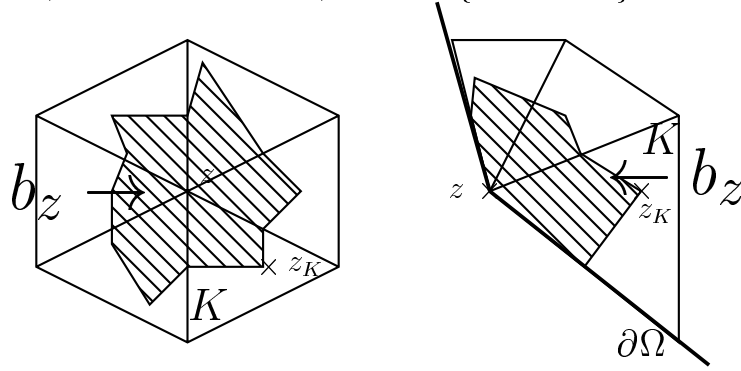

Figure 5: Example of boxes b_z

We further define

$$X_h^0 := \{v \in H_0^1(\Omega) / v|_K \in \mathbb{P}_1(K), \forall K \in T_h\}.$$

For $z \in Z_h^{in}$, we introduce χ_z as the standard hat function related to z , i.e., $\chi_z \in X_h^0$ and satisfies $\chi_z(z) = 1$ and $\chi_z(z') = 0$, for all $z' \in Z_h \setminus \{z\}$, while $\bar{\chi}_z$ is the characteristic function of the box b_z . Finally for $v \in X_h^0$ that may be written $v := \sum_{z \in Z_h^{in}} v(z)\chi_z$,

we may associate the unique piecewise constant function $\bar{v} := \sum_{z \in Z_h^{in}} v(z)\bar{\chi}_z$ and conversely.

3.1 The discretization

Integrating (1) on a box b_z and using the divergence formula, we have

$$(17) \quad - \int_{\partial b_z} \frac{\partial u}{\partial n_z} ds = \int_{b_z} f(x) dx, \forall z \in Z_h,$$

where n_z is the unit outward normal vector along ∂b_z . The approximation of (1) in the conforming finite volume-element method sense is to find $u_{BC} \in X_h^0$ satisfying

$$(18) \quad - \int_{\partial b_z} \frac{\partial u_{BC}}{\partial n_z} ds = \int_{b_z} f(x) dx, \forall z \in Z_h^{in}.$$

Proposition 3.1 ([4]) *Consider a regular triangulation T_h of Ω and a corresponding set of boxes B_h built above. Then the system (18) admits a unique solution $u_{BC} \in X_h^0$.*

Remark 3.2 Setting

$$a : X_h^0 \times X_h^0 \rightarrow \mathbb{R} : (v, w) \mapsto \int_{\Omega} \nabla v \cdot \nabla w dx,$$

by Lemma 3 of [4] we know that (18) is equivalent to

$$a(u_{BC}, \chi_z) = (f, \bar{\chi}_z)_{\Omega}, \forall z \in Z_h^{in}.$$

This means that the system (18) is reduced to the system $AU = \bar{F}$, where $U := (u_{BC,z})_{z \in Z_h^{in}}$, $\bar{F} := (\int_{b_z} f dx)_{z \in Z_h^{in}}$ and $u_{BC} = \sum_{z \in Z_h^{in}} u_{BC,z} \chi_z$. In comparison with the linear system $AU = F$ obtained by the discretization of (1) using the standard FEM based on X_h^0 , only the right-hand side has changed.

3.2 The error estimates

As before the singular behaviour of the solution u of (1) near O requires refinement of the meshes near this point O , we then introduce the following hypotheses (compare with (H1) to (H3)): There exists $\xi > 0$ independent of h such that

$$(H1') \quad \forall K \in T_h, 1 \leq \frac{h_K}{\rho_K} \leq \xi, \text{ which means that } T_h \text{ is a regular mesh in Ciarlet's sense [11],}$$

$$(H2') \quad \forall K \in T_h, h_K \leq \xi h^{1-\beta}, \text{ if } O \in K,$$

$$(H3') \quad \forall K \in T_h, h_K \leq \xi h \inf_{x \in K} r^{\beta}(x), \text{ if } O \notin K.$$

Remark 3.3 The condition (H1') will allow to obtain appropriate trace inequalities; it is also equivalent to the minimal angle condition [11]. The conditions (H2') and (H3') are refinement conditions. Meshes fulfilling the conditions (H1') to (H3') are easily built and are used to restore optimal order of convergence for standard FEM [28, 18, 14, 3].

We start with a trace inequality in the weighted Sobolev space

$$H^{1,\beta}(\Omega) := \{v \in L^2(\Omega) / r^\beta \nabla u \in L^2(\Omega)^2\},$$

equipped with its natural norm.

Lemma 3.4 *Let T_h be a triangulation of Ω satisfying the condition (H1') and let $\beta \in [0, \frac{1}{2}[$. Fix $K \in T_h$ and σ an arbitrary segment included into K (see Figure 6). Then for all $v \in H^{1,\beta}(\Omega)$, we have*

$$(19) \quad \int_{\sigma} v^2 ds \lesssim \frac{\|v\|_{0,K}^2}{h_K} + h_K |v|_{1,K}^2, \text{ if } O \notin K,$$

$$(20) \quad \int_{\sigma} v^2 ds \lesssim \frac{\|v\|_{0,K}^2}{h_K} + h_K^{1-2\beta} |v|_{1,\beta,K}^2, \text{ if } O \in K.$$

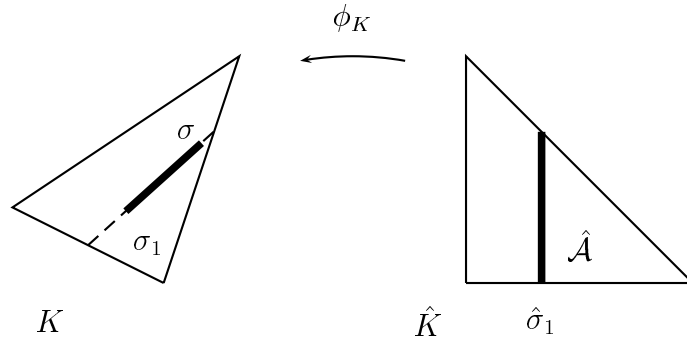

Figure 6: A triangle K and $\sigma \subset K$ and their transformation to the reference element

Proof: The estimate (19) is a particular case of (20) for $\beta = 0$, so we focus our attention to the estimate (20). We use a standard scaling argument and then prove

first (20) on the reference triangle \hat{K} of vertices $(0, 0)$, $(1, 0)$ and $(0, 1)$. On \hat{K} one has

$$(21) \quad \|\hat{v}\|_{0,\partial\hat{K}}^2 \lesssim \|\hat{v}\|_{0,\hat{K}}^2 + |\hat{v}|_{1,\beta,\hat{K}}^2, \forall \hat{v} \in H^{1,\beta}(\hat{K}),$$

where $H^{1,\beta}(\hat{K})$ is defined as before with $\hat{r}(\hat{x}) = |\hat{x}|$ is the distance to $(0, 0)$. Indeed by Hölder's inequality (see for instance Lemma 8.4.1.2 of [18]) we have

$$(22) \quad H^{1,\beta}(\hat{K}) \hookrightarrow W^{1,p}(\hat{K}), \forall p < \frac{2}{1+\beta},$$

while a standard trace theorem (see for instance Theorem 3 in appendix [IM] of [20]) yields

$$W^{1,p}(\hat{K}) \hookrightarrow L^2(\partial\hat{K}), \forall p \geq \frac{4}{3}.$$

By composition we get

$$H^{1,\beta}(\hat{K}) \hookrightarrow L^2(\partial\hat{K}), \text{ for any } \beta < \frac{1}{2},$$

which proves (21).

We now extend $\hat{\sigma}$ to obtain a second segment $\hat{\sigma}_1$ such that the extremities of $\hat{\sigma}_1$ belong to the boundary of \hat{K} .

Denote by $\hat{\mathcal{A}}$ a triangle included into \hat{K} and such that $\hat{\sigma}_1 \subset \partial\hat{\mathcal{A}}$. By Green's formula on the triangle $\hat{\mathcal{A}}$ we have

$$\int_{\partial\hat{\mathcal{A}}} \hat{v}^2 \hat{n}_i d\hat{s} = \int_{\hat{\mathcal{A}}} \frac{\partial \hat{v}^2}{\partial \hat{x}_i} d\hat{x}, \forall i = 1, 2.$$

Multiplying this identity by $\hat{n}_i|_{\hat{\sigma}_1}$ and summing the result on $i = 1, 2$, we get

$$(23) \quad \begin{aligned} \int_{\hat{\sigma}_1} \hat{v}^2 d\hat{s} &\leq 2 \int_{\partial\hat{\mathcal{A}} \setminus \hat{\sigma}_1} \hat{v}^2 d\hat{s} + 4 \int_{\hat{\mathcal{A}}} |\hat{v}| |\nabla \hat{v}| d\hat{x} \\ &\leq 2 \int_{\partial\hat{K}} \hat{v}^2 d\hat{s} + 4 \int_{\hat{K}} |\hat{v}| |\nabla \hat{v}| d\hat{x}. \end{aligned}$$

Hölder's inequality and the well known embedding (see [18])

$$W^{1,p}(\hat{K}) \hookrightarrow L^q(\hat{K}), \forall p \geq \frac{4}{3}, \text{ with } \frac{1}{p} + \frac{1}{q} = 1,$$

lead to

$$\int_{\hat{K}} |\hat{v}| |\nabla \hat{v}| d\hat{x} \leq \|\hat{v}\|_{0,q,\hat{K}} \|\nabla \hat{v}\|_{0,p,\hat{K}} \lesssim \|\hat{v}\|_{1,p,\hat{K}}^2.$$

Combined with (22) we obtain

$$\int_{\hat{K}} |\hat{v}| |\nabla \hat{v}| d\hat{x} \lesssim \|\hat{v}\|_{1,\beta,\hat{K}}^2.$$

This estimate and the estimate (21) in (23) show that

$$\int_{\hat{\sigma}} \hat{v}^2 d\hat{s} \lesssim \|v\|_{0,\hat{K}}^2 + |v|_{1,\beta,\hat{K}}^2.$$

We conclude using the change of variables:

$$\Phi_K : \hat{K} \rightarrow K : \hat{x} \rightarrow x = B_K \hat{x} + b_K,$$

where the matrix B_K satisfies $|B_K| \sim h_K$ due to the assumption (H1') and using the fact that the length of the segment σ is clearly less than h_K . ■

Lemma 3.5 *Let T_h be a triangulation of Ω satisfying the condition (H1') and let $\beta \in [0, \frac{1}{2}[$. Fix $K \in T_h$ and σ an arbitrary segment included into K . Then for all $v \in H^{2,\beta}(\Omega)$, we have*

$$(24) \quad \left| \int_{\sigma} \frac{\partial v}{\partial n} ds \right|^2 \lesssim |v|_{1,K}^2 + h_K^2 |v|_{2,K}^2, \text{ if } O \notin K,$$

$$(25) \quad \left| \int_{\sigma} \frac{\partial v}{\partial n} ds \right|^2 \lesssim |v|_{1,K}^2 + h_K^{2-2\beta} |v|_{2,\beta,K}^2, \text{ if } O \in K.$$

Proof: By Cauchy-Schwarz's inequality we have

$$(26) \quad \left| \int_{\sigma} \frac{\partial v}{\partial n} ds \right|^2 \lesssim h_K \int_{\sigma} |\nabla v|^2 ds,$$

and we conclude thanks to the estimates (19) or (20). ■

Combining this Lemma and some arguments from [4, 9] and from [28], we can prove the following error estimates.

Theorem 3.6 *Let $u \in H_0^1(\Omega) \cap H^{2,\beta}(\Omega)$, with $\beta \in]1 - \frac{\pi}{\omega}, \frac{1}{2}[$, (resp. $u_{BC} \in X_h^0$) be the unique solution of (1) (resp. (18)). Then under the assumptions (H1') to (H3'), we have*

$$(27) \quad \|u - u_{BC}\|_{1,\Omega} \lesssim h|u|_{2,\beta,\Omega} \lesssim h|f|_{0,\Omega}.$$

Proof: Let us set

$$a' : H_0^1(\Omega) \cap H^{2,\beta}(\Omega) \times H_0^1(\Omega) \cap H^{2,\beta}(\Omega) \rightarrow \mathbb{R} : (v, w) \mapsto - \sum_{z \in Z_h^{in}} w(z) \int_{\partial b_z} \frac{\partial v}{\partial n_z} ds.$$

Then (17) and (18) imply the orthogonality relation

$$a'(u - u_{BC}, v) = 0, \forall v \in X_h^0.$$

Consequently it holds

$$(28) \quad a'(u - w, v) = a'(u_{BC} - w, v), \forall v, w \in X_h^0.$$

Applying Lemma 3 of [4] to this right-hand side (see Remark 3.2) we then get

$$a'(u - w, v) = a(u_{BC} - w, v), \forall v, w \in X_h^0.$$

As $u_{BC} - w \in X_h^0$ for $w \in X_h^0$, we conclude that

$$\sup_{v \in X_h^0, v \neq 0} \frac{a'(u - w, v)}{|v|_{1,\Omega}} \geq |u_{BC} - w|_{1,\Omega}, \forall w \in X_h^0.$$

By Poincaré-Friedrichs' inequality we arrive at

$$(29) \quad \|u_{BC} - w\|_{1,\Omega} \lesssim \sup_{v \in X_h^0, v \neq 0} \frac{a'(u - w, v)}{|v|_{1,\Omega}}.$$

It then remains to estimate the above right-hand side. Let us fix $v, w \in X_h^0$. We first recall that

$$a'(u - w, v) = - \sum_{z \in Z_h^{in}} v(z) \int_{\partial b_z} \frac{\partial(u - w)}{\partial n_z} ds.$$

Applying successively Cauchy-Schwarz's inequality and Lemma 1 of [4] to this right-hand side, we obtain

$$(30) \quad |a'(u - w, v)| \lesssim |v|_{1,\Omega} \left(\sum_{K \in T_h} \sum_{s,p \in Z_h(K)} \left| \int_{\partial b_s \cap \partial b_p} \frac{\partial(u - w)}{\partial n} ds \right|^2 \right)^{\frac{1}{2}}.$$

Applying now Lemma 3.5 we get

$$|a'(u - w, v)| \lesssim |v|_{1,\Omega} \left(|u - w|_{1,\Omega}^2 + \sum_{K \in T_h, O \notin K} h_K^2 |u|_{2,K}^2 + \sum_{K \in T_h, O \in K} h_K^{2-2\beta} |u|_{2,\beta,K}^2 \right)^{\frac{1}{2}}.$$

Making use of the refinement conditions (H2') and (H3'), we obtain

$$(31) \quad |a'(u - w, v)| \lesssim |v|_{1,\Omega} \left(|u - w|_{1,\Omega}^2 + h^2 |u|_{2,\beta,\Omega}^2 \right)^{\frac{1}{2}}, \forall v, w \in X_h^0.$$

Combining the estimates (29), (31) and taking $w := Iu \in X_h^0$, the Lagrange interpolant of u at the nodes of the triangulation T_h , we arrive at

$$(32) \quad \|u_{BC} - Iu\|_{1,\Omega} \lesssim \|u - Iu\|_{1,\Omega} + h|u|_{2,\beta,\Omega}.$$

This estimate and the well known error estimate (see [28] or Theorem 8.4.1.6 of [18])

$$(33) \quad \|u - Iu\|_{1,\Omega} \lesssim h |u|_{2,\beta,\Omega},$$

lead to (27) with the help of the triangular inequality. \blacksquare

Using an Aubin-Nitsche's trick we now establish a quadratic convergence rate for $\|u - u_{BC}\|_{0,\Omega}$ under some supplementary hypotheses on the meshes and on f .

Theorem 3.7 *Let the assumptions of Theorem 3.6 be satisfied. Assume furthermore that for all $K \in T_h$, z_K is the barycenter of K and that $f \in H^1(\Omega)$. Then it holds*

$$(34) \quad \|u - u_{BC}\|_{0,\Omega} \lesssim h^2 \|f\|_{1,\Omega}.$$

Proof: Consider the auxiliary (dual) problem: Let $\phi \in H_0^1(\Omega)$ be the unique solution of

$$(35) \quad \begin{cases} -\Delta \phi = u - u_{BC} \text{ in } \Omega, \\ \phi = 0 \text{ on } \partial\Omega. \end{cases}$$

Then by the results from section 1 we know that $\phi \in H^{2,\beta}(\Omega)$ with β as before, with the estimate

$$(36) \quad |\phi|_{2,\beta,\Omega} + |\phi|_{1,\Omega} \lesssim \|u - u_{BC}\|_{0,\Omega}.$$

By the weak formulation of (35) we may write (since $u - u_{BC}$ belongs to $H_0^1(\Omega)$)

$$(37) \quad \begin{aligned} \|u - u_{BC}\|_{0,\Omega}^2 &= \int_{\Omega} \nabla(u - u_{BC}) \cdot \nabla \phi \, dx \\ &= a(u - u_{BC}, \phi - v) + a(u - u_{BC}, v), \forall v \in X_h^0. \end{aligned}$$

We are then reduced to estimate the two terms of the right-hand side of (37): For the first term we simply apply Cauchy-Schwarz's inequality to write

$$(38) \quad |a(u - u_{BC}, \phi - v)| \leq |u - u_{BC}|_{1,\Omega} |\phi - v|_{1,\Omega}, \forall v \in X_h^0.$$

For the second term we remark that

$$a(u - u_{BC}, v) = a(u, v) - a(u_{BC}, v).$$

By the weak formulation of problem (1) we clearly have

$$a(u, v) = (f, v)_\Omega.$$

While by Lemma 3 of [4] we have (see Remark 3.2)

$$a(u_{BC}, v) = (f, \bar{v})_\Omega.$$

Alltogether we arrive at

$$(39) \quad a(u - u_{BC}, v) = (f, v - \bar{v})_\Omega.$$

Note that

$$(f, v - \bar{v})_\Omega = \sum_{K \in T_h} (f, v - Q(v))_K,$$

where $Q(v)|_K := \sum_{z \in Z_h(K)} v(z) \bar{\chi}_z|_K$, for all $K \in T_h$. Therefore, setting $f_K := \frac{1}{|K|} \int_K f dx$, the mean value of f on $K \in T_h$, the above identity may be transformed into

$$(40) \quad (f, v - \bar{v})_\Omega = \sum_{K \in T_h} (f - f_K, v - Q(v))_K + \sum_{K \in T_h} (f_K, v - Q(v))_K.$$

For all $K \in T_h$, Cauchy-Schwarz's inequality and the Bramble-Hilbert Lemma ([11]) lead to

$$|(f - f_K, v - Q(v))_K| \leq \|f - f_K\|_{0,K} \|v - Q(v)\|_{0,K} \lesssim h_K^2 |f|_{1,K} |v|_{1,K}.$$

On the other hand one has

$$\begin{aligned} (f_K, v - Q(v))_K &= f_K \left(\int_K v dx - \int_K Q(v) dx \right) \\ &= f_K \left(\int_K v dx - \frac{|K|}{3} \sum_{z \in Z_h(K)} v(z) \right) = 0, \end{aligned}$$

since z_K is the barycenter of K and since the quadrature rule $\frac{|K|}{3} \sum_{z \in Z_h(K)} v(z)$ is exact on \mathbb{P}_1 .

These results in (40) yield

$$|(f, v - \bar{v})_\Omega| \lesssim h^2 |f|_{1,\Omega} |v|_{1,\Omega}.$$

Inserting this estimate in (39) we have shown that

$$(41) \quad |a(u - u_{BC}, v)| \lesssim h^2 |f|_{1,\Omega} |v|_{1,\Omega}.$$

At this stage we come back to (37) and use the estimates (38) and (41) to get for all $v \in X_h^0$:

$$(42) \quad \|u - u_{BC}\|_{0,\Omega}^2 \lesssim |u - u_{BC}|_{1,\Omega} |\phi - v|_{1,\Omega} + h^2 |f|_{1,\Omega} (|v - \phi|_{1,\Omega} + |\phi|_{1,\Omega}).$$

We now take $v := I\phi$ and by (33) and (27) we obtain

$$\|u - u_{BC}\|_{0,\Omega}^2 \lesssim h^2 |f|_{0,\Omega} |\phi|_{2,\beta,\Omega} + h^2 |f|_{1,\Omega} (|\phi|_{1,\Omega} + |\phi|_{2,\beta,\Omega}).$$

We conclude by using (36). ■

Remark 3.8 Analogously one can prove for quasi-uniform meshes (i.e. $\beta = 0$) the slow orders of convergence

$$\begin{aligned} \|u - u_{BC}\|_{1,\Omega} &\lesssim h^{\frac{\pi}{\omega} - \varepsilon} \|f\|_{0,\Omega}, \\ \|u - u_{BC}\|_{0,\Omega} &\lesssim h^{\frac{2\pi}{\omega} - 2\varepsilon} \|f\|_{1,\Omega}, \end{aligned}$$

for any $\varepsilon > 0$. This is confirmed by the results presented in [10].

Remark 3.9 In Theorem 3.7, the assumption on the points z_K to be the barycenter of K is essential to obtain a rate of convergence of order 2 as shown in [22].

Remark 3.10 Our finite volume-element method may be used for the approximation of singularly perturbed reaction-diffusion problems using anisotropic meshes. In that case adapting the proof of Theorems 3.6 and 3.7 and using the results from [1, 2] one can obtain some error estimates but which seem to be less interesting than those obtained by the conforming finite element method.

4 The nonconforming finite volume-element method

The general idea of the method is similar to the one of the previous section except that we approximate the solution u of (1) in the \mathbb{P}_1 non conforming finite element space (see [12, 8]).

As before the primal mesh consists in a regular triangulation T_h of Ω . With the same notation as in the previous section, the dual mesh is built as follows: consider an arbitrary interior point z_K of $K \in T_h$, then for $e \in E_h(K) \cap E_h(L)$, the box associated with e is defined by $b_e := \bigcup_{x \in e} \text{Conv}[z_K, z_L, x]$ (see Figure 7). The set of boxes is simply $B_h := \{b_e : e \in E_h\}$. For any edge e we denote by m_e the midpoint of e .

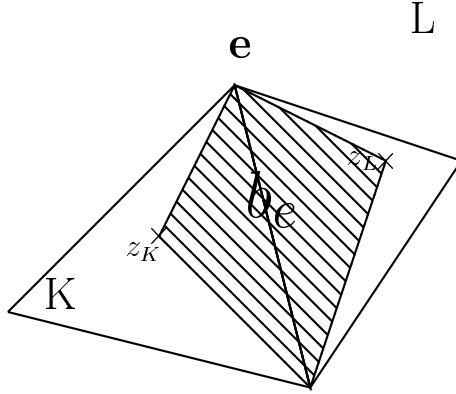

Figure 7: An example of a box b_e

Let us set $E_h^{int} = \{e \in E_h / e \subset \Omega\}$ the set of interior edges of T_h and by $E_h^{ext} = \{e \in E_h / e \subset \partial\Omega\}$ the set of exterior edges of T_h . We further introduce the Crouzeix-Raviart finite element space:

$$S_h^0 := \{v_h \in L^2(\Omega) / \begin{aligned} &v_{h|K} \in \mathbb{P}_1(K), \forall K \in T_h, \\ &v_{h|K}(m_e) = v_{h|L}(m_e), \forall e \in E_h^{int}, K, L \in T_h : e = K \cap L, \\ &\text{and } v_h(m_e) = 0, \forall e \in E_h^{ext} \}. \end{aligned}$$

Since S_h^0 is not included into $H_0^1(\Omega)$, the space S_h^0 is equipped with the norm $\|\cdot\|_{1,h} := \left(\sum_{K \in T_h} \|\cdot\|_{1,K}^2 \right)^{\frac{1}{2}}$.

4.1 The discretization

Integrating (1) on a box b_e and using the divergence formula, we have for all $e \in E_h$

$$(43) \quad - \int_{\partial b_e} \frac{\partial u}{\partial n_e} ds = \int_{b_e} f(x) dx,$$

where n_e means the outward normal vector along ∂b_e .

By analogy with the previous section, the approximation of (1) in the nonconforming finite volume-element method sense is then to find $u_{BN} \in S_h^0$ satisfying

$$(44) \quad - \int_{\partial b_e} \frac{\partial u_{BN}}{\partial n_e} ds = \int_{b_e} f(x) dx, \quad \forall e \in E_h^{int}.$$

Proposition 4.1 ([8]) *Consider a regular triangulation T_h of Ω and a corresponding set of boxes B_h . Then the system (44) admits a unique solution $u_{BN} \in S_h^0$.*

4.2 The error estimates

As before using Lemma 3.5 and adapting the arguments from [8] and from [28], we can prove the following error estimate.

Theorem 4.2 *Let $u \in H_0^1(\Omega) \cap H^{2,\beta}(\Omega)$, with $\beta \in]1 - \frac{\pi}{\omega}, \frac{1}{2}[$, (resp. $u_{BN} \in S_h^0$) be the unique solution of (1) (resp. (44)). Then under the assumptions (H1') to (H3'), we have*

$$(45) \quad \|u - u_{BN}\|_{1,h} \lesssim h|u|_{2,\beta,\Omega} \lesssim h\|f\|_{0,\Omega}.$$

Proof: Setting

$$\begin{aligned} a_h(v, w) &:= \sum_{K \in T_h} \int_K \nabla v \cdot \nabla w dx, \\ \bar{a}(v, w) &:= - \sum_{e \in E_h^{in}} w(m_e) \int_{\partial b_e} \frac{\partial v}{\partial n_e} ds, \end{aligned}$$

and taking into account (43) and (44), the next orthogonality relation holds:

$$\bar{a}(u - u_{BN}, v) = 0, \quad \forall v \in S_h^0.$$

This identity and Lemma 3.2 of [8] yield

$$(46) \quad a_h(u_{BN} - w, v) = \bar{a}(u_{BN} - w, v) = \bar{a}(u - w, v), \quad \forall v, w \in S_h^0.$$

This allows to conclude

$$(47) \quad \|u_{BN} - w\|_{1,h} \leq \sup_{v \in S_h^0, v \neq 0} \frac{a_h(u_{BN} - w, v)}{\|v\|_{1,h}} \leq \sup_{v \in S_h^0, v \neq 0} \frac{\bar{a}(u - w, v)}{\|v\|_{1,h}}, \quad \forall w \in S_h^0.$$

Using Cauchy-Schwarz's inequality and Lemma 3.5 of [8] (see the estimate (3.26) of [8]) we get

$$(48) \quad \|u_{BN} - w\|_{1,h} \leq \left(\sum_{K \in T_h} \sum_{e, l \in E_h(K)} \left| \int_{\partial b_e \cap \partial b_l} \frac{\partial(u-w)}{\partial n_e} ds \right|^2 \right)^{\frac{1}{2}}, \quad \forall w \in S_h^0.$$

This right-hand side is now estimated using Lemma 3.5 to obtain

$$\begin{aligned} \|u_{BN} - w\|_{1,h} &\leq \left(\sum_{K \in T_h, O \in K} (|u - w|_{1,K}^2 + h_K^{2-2\beta} |u|_{2,\beta,K}^2) \right. \\ &\quad \left. + \sum_{K \in T_h, O \notin K} (|u - w|_{1,K}^2 + h_K^2 |u|_{2,K}^2) \right)^{\frac{1}{2}}, \forall w \in S_h^0. \end{aligned}$$

Using the refinement rules (H2') and (H3') we arrive at

$$\|u_{BN} - w\|_{1,h} \lesssim h|u|_{2,\beta,\Omega} + \|u - w\|_{1,h}, \forall w \in S_h^0,$$

and by the triangular inequality we conclude

$$(49) \quad \|u_{BN} - u\|_{1,h} \lesssim h|u|_{2,\beta,\Omega} + \|u - w\|_{1,h}, \forall w \in S_h^0.$$

Now we take $w = I_{CR}u$, the Crouzeix-Raviart interpolant of u which satisfies, thanks to Theorem 3.7 of [14], the error estimate

$$(50) \quad \|u - I_{CR}u\|_{1,h} \lesssim h|u|_{2,\beta,\Omega}.$$

The estimates (49) and (50) lead to the conclusion. \blacksquare

For the estimation of the L^2 -norm we first prove the following error estimates.

Lemma 4.3 *Let T_h be a triangulation of Ω satisfying the condition (H1') and let $\beta \in [0, \frac{1}{2}]$. Fix $K \in T_h$ such that $O \in K$ and e an arbitrary edge of K . Then for all $v \in H^{1,\beta}(\Omega)$*

$$(51) \quad \|v - \mathcal{M}_e^0 v\|_{0,e} \lesssim h_K^{\frac{1}{2}-\beta} |v|_{1,\beta,K},$$

where $\mathcal{M}_e^0 v = \frac{1}{|e|} \int_e v ds$ is the mean value of v on e . Consequently for all $v \in H^{1,\beta}(\Omega)$ and $w \in H^1(\Omega)$ we have

$$(52) \quad \left| \int_e (v - \mathcal{M}_e^0 v)(w - \mathcal{M}_e^0 w) ds \right| \lesssim h_K^{1-\beta} |v|_{1,\beta,K} |w|_{1,K}.$$

Proof: First we remark that $\mathcal{M}_e^0 v$ has a meaning for $v \in H^{1,\beta}(\Omega)$ due to the embedding $H^{1,\beta}(K) \hookrightarrow L^2(e)$.

On the reference triangle \hat{K} due to the compact embedding of $H^{1,\beta}(\hat{K})$ into $L^2(\hat{K})$, we clearly have

$$\|\hat{v} - \mathcal{M}_{\hat{e}}^0 \hat{v}\|_{0,\hat{e}} \lesssim \|\hat{v} - \mathcal{M}_{\hat{e}}^0 \hat{v}\|_{1,\beta,\hat{K}} \lesssim |\hat{v} - \mathcal{M}_{\hat{e}}^0 \hat{v}|_{1,\beta,\hat{K}} \lesssim |\hat{v}|_{1,\beta,\hat{K}}.$$

By change of variables and the assumption (H1') we conclude

$$\|v - \mathcal{M}_e^0 v\|_{0,e} \leq |e|^{\frac{1}{2}} \|\hat{v} - \mathcal{M}_{\hat{e}}^0 \hat{v}\|_{0,\hat{e}} \lesssim h_K^{\frac{1}{2}} |\hat{v}|_{1,\beta,\hat{K}} \lesssim h_K^{\frac{1}{2}-\beta} |v|_{1,\beta,K}.$$

The estimate (52) directly follows from (51) and Cauchy-Schwarz's inequality. \blacksquare

Theorem 4.4 *Let the assumptions of Theorem 4.2 be satisfied. If, for all $K \in \mathcal{T}_h$, z_K is the barycenter of K and if $f \in H^1(\Omega)$, then it holds*

$$(53) \quad \|u - u_{BN}\|_{0,\Omega} \lesssim h^2 \|f\|_{1,\Omega}.$$

Proof: We use a duality argument as in Theorem 3.7 but with necessary adaptations due to the nonconformity of the approximation (see [8, Thm 3.2] for the regular case).

Consider the auxiliary (dual) problem: Let $\phi \in H_0^1(\Omega)$ be the unique solution of

$$(54) \quad \begin{cases} -\Delta \phi = u - u_{BN} \text{ in } \Omega, \\ \phi = 0 \text{ on } \partial\Omega. \end{cases}$$

Then by the results from section 1 we know that $\phi \in H^{2,\beta}(\Omega)$ with β as before, and

$$(55) \quad |\phi|_{2,\beta,\Omega} + |\phi|_{1,\Omega} \lesssim \|u - u_{BN}\|_{0,\Omega}.$$

Now by (54) and Green's formula on each triangle K we may write

$$\begin{aligned} \|u - u_{BN}\|_{0,\Omega}^2 &= - \sum_{K \in \mathcal{T}_h} \int_K (u - u_{BN}) \Delta \phi dx \\ &= \sum_{K \in \mathcal{T}_h} \left(\int_K \nabla(u - u_{BN}) \cdot \nabla \phi dx - \int_{\partial K} (u - u_{BN}) \frac{\partial \phi}{\partial n} ds \right). \end{aligned}$$

Note that, contrary to the previous situation, u_{BN} is no more in $H_0^1(\Omega)$ and consequently the above boundary terms are not equal to zero. For all $v \in S_h^0$ we then get

$$(56) \quad \begin{aligned} \|u - u_{BN}\|_{0,\Omega}^2 &= a_h(u - u_{BN}, \phi - v) \\ &+ a_h(u - u_{BN}, v) - \sum_{K \in \mathcal{T}_h} \int_{\partial K} (u - u_{BN}) \frac{\partial \phi}{\partial n} ds. \end{aligned}$$

We now estimate the three terms of the above right-hand side. For the first one Cauchy-Schwarz's inequality leads to

$$(57) \quad |a_h(u - u_{BN}, \phi - v)| \leq \|u - u_{BN}\|_{1,h} \|\phi - v\|_{1,h}.$$

For the second term the identity (3.38) of [8] showed that

$$(58) \quad a_h(u - u_{BN}, v) = \sum_{K \in T_h} \left(\int_{\partial K} v \frac{\partial u}{\partial n} ds + (f, v - Q(v))_K \right),$$

where, for all $K \in T_h$, $Q(v)|_K := \sum_{e \in E_h(K)} v(m_e) g_{K_e}$, and g_{K_e} is the characteristic function of the set $b_{e,K}$. So it remains to estimate the two terms of the right-hand side of (58).

As $v \in S_h^0$ we may write

$$(59) \quad \sum_{K \in T_h} \int_{\partial K} v \frac{\partial u}{\partial n} ds = \sum_{K \in T_h} \sum_{e \in E_h(K)} \int_e v \left(\frac{\partial u}{\partial n} - \mathcal{M}_e^0 \left(\frac{\partial u}{\partial n} \right) \right) ds.$$

Since $\phi = 0$ on the boundary and is continuous in Ω the above identity may be transformed into

$$\begin{aligned} \sum_{K \in T_h} \int_{\partial K} v \frac{\partial u}{\partial n} ds &= \sum_{K \in T_h} \sum_{e \in E_h(K)} \int_e (v - \phi) \left(\frac{\partial u}{\partial n} - \mathcal{M}_e^0 \left(\frac{\partial u}{\partial n} \right) \right) ds \\ &= \sum_{K \in T_h} \sum_{e \in E_h(K)} \int_e ((v - \phi) - \mathcal{M}_e^0(v - \phi)) \left(\frac{\partial u}{\partial n} - \mathcal{M}_e^0 \left(\frac{\partial u}{\partial n} \right) \right) ds. \end{aligned}$$

Consequently by Lemma 4.3 we obtain

$$\begin{aligned} \left| \sum_{K \in T_h} \int_{\partial K} v \frac{\partial u}{\partial n} ds \right| &\lesssim \sum_{K \in T_h, O \in \partial K} h_K^{1-\beta} |u|_{2,\beta,K} |v - \phi|_{1,K} \\ &\quad + \sum_{K \in T_h, O \notin \partial K} h_K |u|_{2,K} |v - \phi|_{1,K}. \end{aligned}$$

Making use of the refinement rules (H2') and (H3') we arrive at

$$(60) \quad \left| \sum_{K \in T_h} \int_{\partial K} v \frac{\partial u}{\partial n} ds \right| \lesssim h |u|_{2,\beta,\Omega} \|v - \phi\|_{1,h}.$$

For the second term of the right-hand side of (58) by the identity (3.45) of [8] we have

$$(f, v - Q(v))_K = (f - f_K, v - Q(v))_K, \forall K \in T_h,$$

where we recall that f_K is the mean of f on K . Cauchy-Schwarz's inequality and the Bramble-Hilbert Lemma ([11]) then yield

$$|(f - f_K, v - Q(v))_K| \leq \|f - f_K\|_{0,K} \|v - Q(v)\|_{0,K} \lesssim h_K^2 |f|_{1,K} |v|_{1,K}, \forall K \in T_h.$$

This estimate directly leads to

$$(61) \quad \left| \sum_{K \in T_h} (f, v - Q(v))_K \right| \lesssim h^2 \|v\|_{1,h} |f|_{1,\Omega}.$$

Coming back to (58) and using the estimates (60) and (61) we get

$$|a_h(u - u_{BN}, v)| \lesssim h |u|_{2,\beta,\Omega} \|\phi - v\|_{1,h} + h^2 \|v\|_{1,h} |f|_{1,\Omega},$$

and by the triangular inequality

$$(62) \quad |a_h(u - u_{BN}, v)| \lesssim h(|u|_{2,\beta,\Omega} + |f|_{1,\Omega})(\|\phi - v\|_{1,h} + h|\phi|_{1,\Omega}).$$

For the estimation of the boundary terms in (56), we remark that the fact that u is continuous in Ω , is zero on the boundary and that u_{BN} belongs to S_h^0 allow to write

$$\begin{aligned} & \sum_{K \in T_h} \int_{\partial K} (u - u_{BN}) \frac{\partial \phi}{\partial n} ds \\ &= \sum_{K \in T_h} \int_{\partial K} ((u - u_{BN}) - \mathcal{M}_e^0(u - u_{BN})) \left(\frac{\partial \phi}{\partial n} - \mathcal{M}_e^0\left(\frac{\partial \phi}{\partial n}\right) \right) ds. \end{aligned}$$

By Lemma 4.3 we then get

$$\begin{aligned} & \left| \sum_{K \in T_h} \int_{\partial K} (u - u_{BN}) \frac{\partial \phi}{\partial n} ds \right| \\ & \lesssim \sum_{K \in T_h, O \in \partial K} h_K^{1-\beta} |\phi|_{2,\beta,K} |u - u_{BN}|_{1,K} + \sum_{K \in T_h, O \notin \partial K} h_K |\phi|_{2,K} |u - u_{BN}|_{1,K}. \end{aligned}$$

Using Cauchy-Schwarz's inequality and the assumptions (H2') and (H3') we arrive at

$$(63) \quad \left| \sum_{K \in T_h} \int_{\partial K} (u - u_{BN}) \frac{\partial \phi}{\partial n} ds \right| \lesssim h |\phi|_{2,\beta,\Omega} \|u - u_{BN}\|_{1,h}.$$

Using the estimates (57), (62) and (63) into (56) and taking $v := I_{CR}\phi$ the Crouzeix-Raviart interpolant of ϕ , we conclude thanks to the estimates (45), (50) and (55). \blacksquare

5 Numerical tests

Consider the Laplace equation with Dirichlet boundary conditions,

$$-\Delta u = 0 \quad \text{in } \Omega, \quad u = g \quad \text{on } \partial\Omega,$$

in the domain $\Omega := (-1, 1)^2 \setminus [0, 1] \times [-1, 0]$, which has a non convex corner at the origin with interior angle $\omega = \frac{3\pi}{2}$. The right-hand side g is taken such that

$$u = r^{2/3} \sin \frac{2}{3}\theta$$

is the exact solution of the problem. It has the typical singular behaviour near the corner [18]. We approximate the above problem using the cell-center method of section 2 and the conforming finite volume-element method from section 3. For both methods we use quasi-uniform meshes and appropriate refined ones for $h = \frac{1}{n}$, for the values $n = 10, 50, 100, 125$, as illustrated by Figures 8 and 9 for $n = 10$.

From the numerical solutions obtained by the cell-center method, the mesh depending norm $\|e_\tau\|_\tau$ and the L^2 -norm $\|e_\tau\|_{0,\Omega}$ were computed. Tables 1 and 2 show respectively the rate of convergence for quasi-uniform meshes and β -refined meshes for $\beta = \frac{1}{3}$. Figure 10 illustrates the same result in a double logarithmic scale so that the slope of the curves corresponds to the approximation order of convergence. From these results we may conclude that refined meshes allow to improve significantly the order of convergence.

For the conforming finite volume-element method, Tables 3, 4 and Figure 11 show the rate of convergence for quasi-uniform meshes and β -refined meshes for $\beta = \frac{1}{3}$ of the L^2 -norm $\|u - u_{BC}\|_{0,\Omega}$ and of the H^1 -norm $\|u - u_{BC}\|_{1,\Omega}$. As before these results confirm that the use of refined meshes improves significantly the order of convergence.

Note that numerical tests for the nonconforming finite volume-element method give similar results.

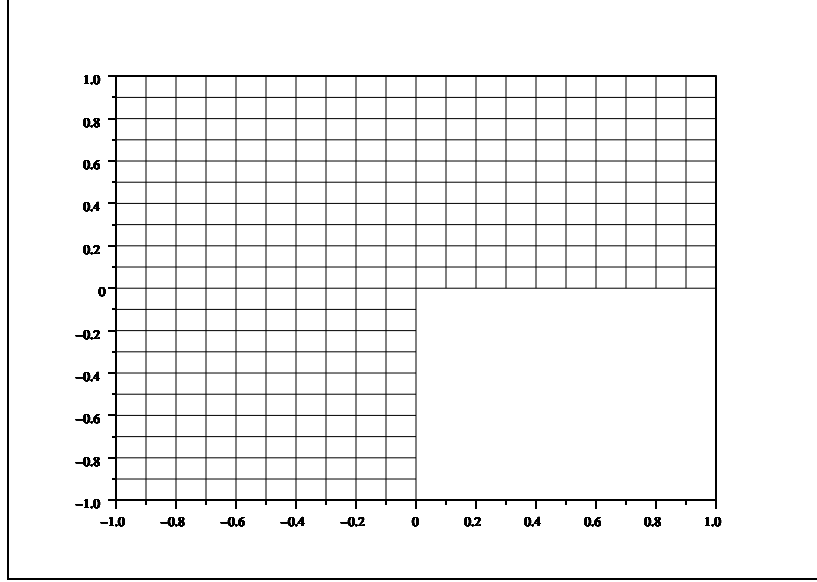

Figure 8: Quasi-uniform mesh for $n=10$

n	$\ e_\tau\ _\tau$	$\ e_\tau\ _{0,\Omega}$
10	4.3554E-02	5.17E-03
50	1.6464E-02	6.92E-04
100	1.1162E-02	3.66E-04
125	1.0382E-02	3.50E-04

Table 1: Numerical results for quasi-uniform meshes for the cell-center method

n	$\ e_\tau\ _\tau$	$\ e_\tau\ _{0,\Omega}$
10	4.3863E-02	4.19E-03
50	8.7885E-03	1.91E-04
100	4.4022E-03	5.30E-04
125	3.5286E-03	3.16E-04

Table 2: Numerical results for β -refined meshes ($\beta = \frac{1}{3}$) for the cell-center method

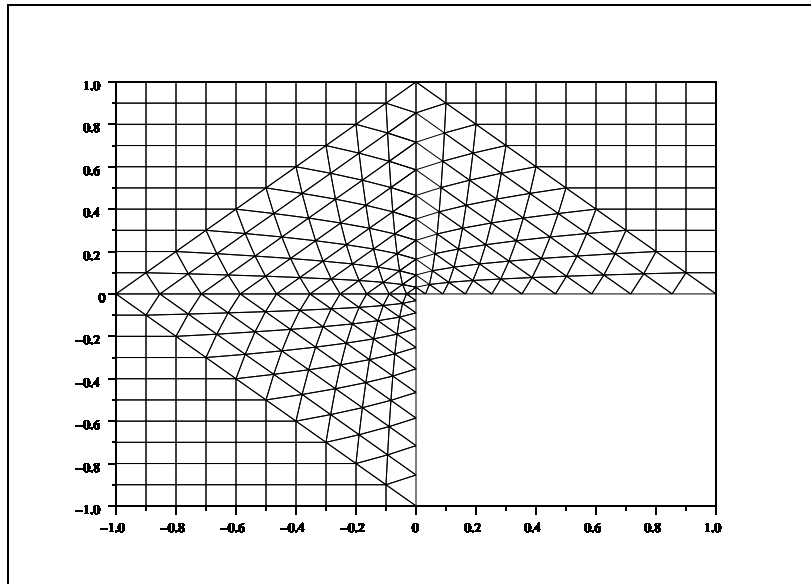

Figure 9: β -refined mesh for $\beta = \frac{1}{3}$ and $n = 10$

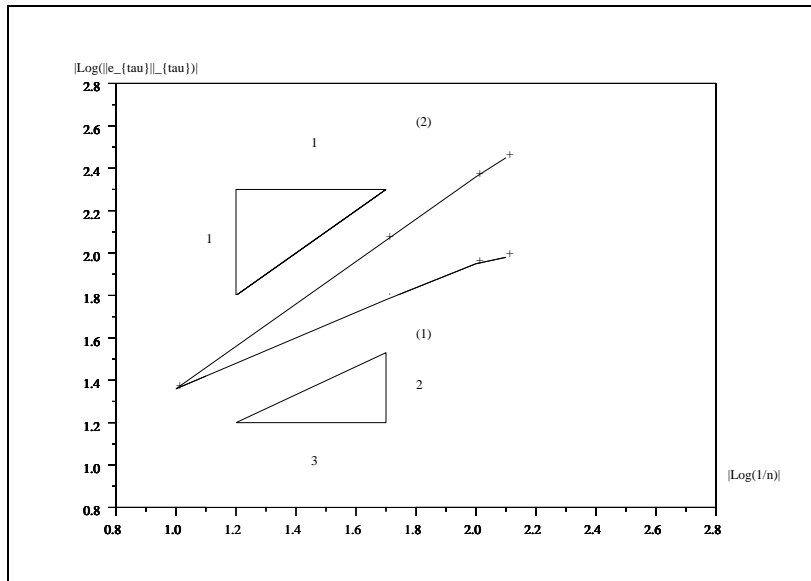

Figure 10: Comparison of quasi-uniform (line (1)) and graded meshes (line (2)) for the cell-center method

n	$\ u - u_{BC}\ _{0,\Omega}$ for a non refined mesh	$\ u - u_{BC}\ _{0,\Omega}$ for a β -refined mesh ($\beta=1/3$)
10	4.9514 E-03	2.0370 E-03
50	6.1035 E-04	1.1324 E-04
100	2.4593 E-04	3.1821 E-05
110	2.1697 E-04	2.6701 E-05

Table 3: Numerical error of the L^2 -norm for quasi-uniform meshes and β -refined meshes ($\beta = \frac{1}{3}$) for the conforming finite volume-element method

n	$\ u - u_{BC}\ _{1,\Omega}$ for a non refined mesh	$\ u - u_{BC}\ _{1,\Omega}$ for a β -refined mesh ($\beta=1/3$)
10	0.1126	6.9098 E-02
50	3.9283 E-02	1.6420 E-02
100	2.4848 E-02	8.7142 E-03
110	2.3329 E-02	7.9830 E-03

Table 4: Numerical error of the H^1 -norm for quasi-uniform meshes and β -refined meshes ($\beta = \frac{1}{3}$) for the conforming finite volume-element method

References

- [1] T. Apel, *Anisotropic interpolation error estimates for isoparametric quadrilateral finite elements*, Computing, **60**, 157-174, 1998.
- [2] T. Apel, G. Lube, *Anisotropic mesh refinement for a singularly perturbed reaction-diffusion model problem*, Appl. Numer. Math., **26**, 415-433, 1998.
- [3] T. Apel, *Anisotropic finite elements : Local estimates and applications*, Advances in Numerical Mathematics, Teubner, Stuttgart, 1999.
- [4] R. E. Bank, D. J. Rose, *Some error estimates for the box method*, SIAM J. Numer. Anal., **24**, 777-787, 1987.
- [5] J. Baranger, J. F. Maitre, F. Oudin, *Connection between finite volume and mixed finite element methods*, Math. Mod. Numer. Anal., **30**, 445-465, 1996.
- [6] Z. Cai, *On the finite volume-element method*, Numer. Math., **58**, 713-735, 1991.
- [7] S. Champier, T. Gallouët, R. Herbin, *Convergence of an upstream finite volume scheme for a nonlinear hyperbolic equation on a triangular mesh*, Numer. Math., **66**, 139-157, 1993.

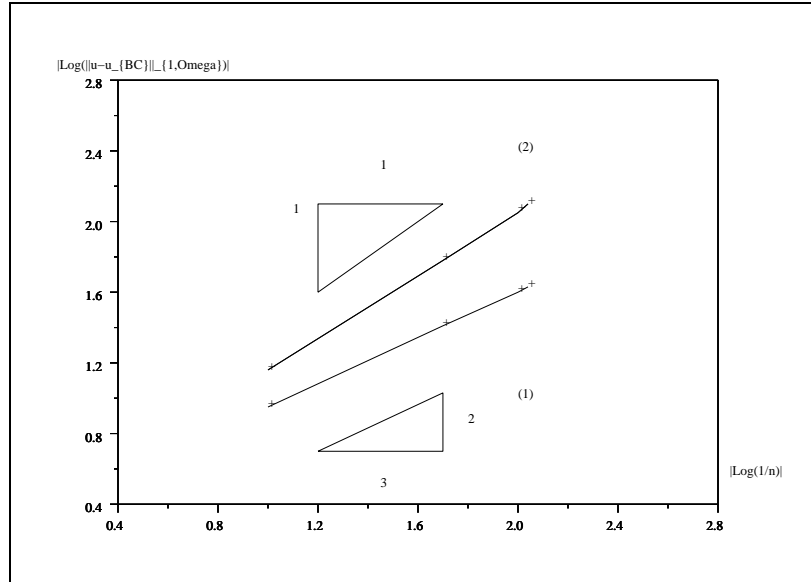

Figure 11: Comparison of quasi-uniform (line (1)) and graded meshes (line (2)) for the conforming finite volume-element method

- [8] P. Chatzipanteliditis, *A finite volume method based on the Crouzeix-Raviart element for elliptic PDE's in two dimensions*, Numer. Math., **82**, 409-432, 1999.
- [9] P. Chatzipanteliditis, *Finite volume methods for elliptic PDE's : a new approach*, Math. Mod. Numer. Anal., **36**, 307-324, 2002.
- [10] P. Chatzipanteliditis, R. D. Lazarov, *The finite volume-element method in non convex polygonal domains*, in: R. Herbin, O. Kröner eds, Finite Volume for Complex Applications, Hermès, 171-178, 2002.
- [11] P. G. Ciarlet, *The finite element method for elliptic problems*, Studies in Mathematics and its applications, North Holland, 1978.
- [12] M. Crouzeix, P. A. Raviart, *Conforming and non conforming finite element methods for solving the stationary Stokes equation I*, RAIRO-M²AN, **7**, 77-104, 1973.
- [13] K. Djadel, S. Nicaise, J. Tabka, *Some refined finite volume methods for elliptic problems with singularities*, in: R. Herbin, O. Kröner eds, Finite Volume for Complex Applications, Hermès, 729-736, 2002.

- [14] H. El Bouzid, S. Nicaise, *Nonconforming finite element methods and singularities in polygonal domains*, Advances in Mathematical Sciences and Applications, **7**, 935-962, 1997.
- [15] H. El Sossa, *Quelques méthodes d'éléments finis mixtes raffinées basées sur l'utilisation des champs de Raviart-Thomas*, Thesis, University of Valenciennes (France), 2001.
- [16] R. Eymard, T. Gallouët, R. Herbin, *Finite volume methods*, Handbook of Numerical Analysis, **7**, 723-1020, 2000.
- [17] T. Gallouët, R. Herbin, M. H. Vignal, *Error estimates on the approximate finite volume solution of convection-diffusion equations with general boundary conditions*, SIAM J. Numer. Anal., **37**, 1935-1972, 2000.
- [18] P. Grisvard, *Elliptic problems in nonsmooth domains*, Monographs and Studies in Mathematics, **21**, Pitman, Boston, 1985.
- [19] W. Hackbush, *On first and second order box schemes*, Computing, **41**, 277-296, 1989.
- [20] B. Heinrich, *Finite difference methods on irregular networks*, Int. Series of Num. Math., **82**, Birkhäuser Verlag, Basel, 1987.
- [21] B. Heinrich, *The box method for elliptic interface problems on locally refined meshes*, in: W. Hackbush and al. eds, Adaptive methods-algorithm, theory and appl., Notes Numer. Fluid. Mech., **46**, 177-186, 1994.
- [22] H. Juanguo, X. Shitong, *On the finite volume-element method for general self-adjoint elliptic operator*, SIAM J. Numer. Anal., **35**, 1762-1774, 1998.
- [23] J. A. Mackenzie, K.W. Morton, *Finite volume solutions of convection-diffusion test problems*, Math. Comp., **60**, 189-220, 1992.
- [24] K. W. Morton, *Finite volume methods and their analysis*, Oxford University Computing Laboratory, report n° 90/11, 1990.
- [25] K. W. Morton, *Numerical solution of convection-diffusion problems*, Chapman and Hall, London, 1996.
- [26] L. A. Oganessian, L. A. Rukhovets, *Variational-difference methods for the solution of elliptic equations*, Izd. Akad. Nauk Armyanskoi SSR, Jerevan, 1979, in Russian.

- [27] S. Ramadhyani, S. V. Patankar, *Solution of the Poisson equation : Comparison of the Galerkin and control-volume methods*, Int. J. for Numer. Meth. in Eng., **15**, 1395-1418, 1980.
- [28] G. Raugel, *Résolution numérique par une méthode d'éléments finis du problème de Dirichlet pour le laplacien dans un polygone*, C. R. Acad. Sc. Paris, Série I, **286**, 791-794, 1978.
- [29] H. Triebel, *Interpolation theory, function spaces, differential operators*, North Holland, 1978.