

Detection of 10^{-21} strain of space-time with an optical interferometer

Sanichiro Yoshida
Southeastern Louisiana University
SLU 10878 Hammond, Louisiana 70402, USA

ABSTRACT The LIGO (Laser Interferometer for Gravitational-wave Observatory) gravitational wave detector is a Michelson interferometer designed to detect a strain of space-time on the order of 10^{-21} . The first generation of LIGO detector (LIGO I detector) is now in full operation, experiencing the fourth science run. In this paper, the LIGO I detector and key techniques necessary to achieve such high sensitivity are outlined.

Introduction

Gravitational wave detectors [1] are designed to explore our universe through analysis of spatio-temporal fluctuations of the space-time known as gravitational waves. Unlike other methods such as radio astronomy or conventional observatories, the gravitational-wave detection does not rely on electromagnetic or other type of radiations. Therefore, it is expected that events such as supernovas can be observed in a fundamentally different way from the conventional methods. The LIGO (Laser Interferometer Gravitational wave Observatory) detector [2] is an earth-based, Michelson interferometer designed to detect the strain of space-time generated by a gravitational wave when it propagates to the earth.

The first generation of LIGO detector (LIGO I detector) [3] has a design-sensitivity of 10^{-21} in strain at a frequency band of 100 – 200 Hz, which is expected to be high enough to detect a signal from a source in our own galaxy [1, 4]. Twin interferometers, each with an arm length of 4 km, have been constructed in the Hanford, Washington and Livingston, Louisiana sites. As of February 2005, the LIGO I detector is in full operation, and the fourth science run is being undertaken. At the same time, the advanced LIGO detector, whose designed sensitivity is an order of magnitude better than the LIGO I in the same frequency band, is in the design stage.

The purpose of this paper is to describe the main features of the LIGO I detector and outline some of the techniques essential to achieve such a high sensitivity. It is hoped that information provided by this paper will be useful for applications in the field of high-resolution experimental mechanics.

Gravitational wave and optical interferometric detection

According to general relativity, gravity is a property of space-time [5]. A massive object deforms the space-time around it, and small masses move on the geodesics of the space-time. Therefore, if a gigantic mass moves at a certain location in our universe, the space-time changes its curved state and all the objects in the universe feel that change. It is intuitively understood that the closer to the source, the sooner and greater these objects would feel the change, and objects at some distance would feel the change with a certain delay in phase and decrease in the magnitude. In other words, the effect travels through the space, i.e., a gravitational wave propagates. This situation is analogous to that when an electric dipole pair oscillates. The electromagnetic field of the surrounding area immediately changes, and the change propagates through the space as an electromagnetic wave. Consequently, all electric charges in the universe feel the change with a certain delay and decay. In fact, a gravitational wave travels at the speed of light as a transverse wave like an electromagnetic wave. An important difference from the electromagnetic case is the fact that the mass, which corresponds to the electric charge in the analogy, has only one sign. In the electromagnetic world, a positive charge attracts a negative charge, but in the gravitational world, a positive mass attracts another positive mass. Consequently, the effect is quadrupole-like, rather than dipole-like.

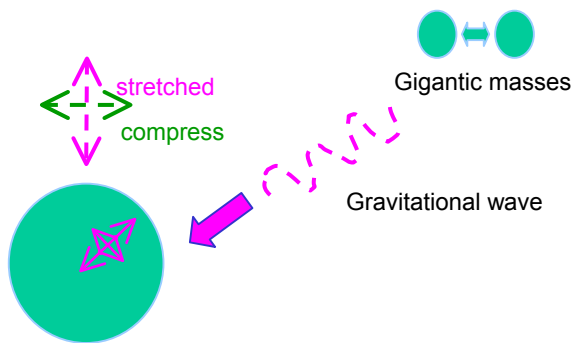

Fig.1 Conceptual picture of gravitational wave's propagation.

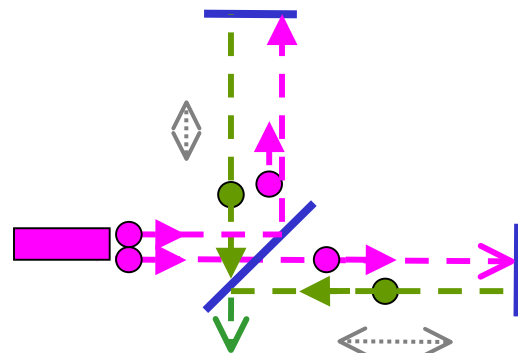

Fig.2 Schematic illustration of relative phase difference

The basic idea behind the LIGO gravitational wave detector is rather straightforward. When a gravitational wave propagates to the earth, the above-mentioned quadrupole-like effect stretches the space-time around us in one direction and compresses it in the orthogonal direction. These changes can be viewed as a transformation from one coordinate system to another, i.e., “before the space-time deformation coordinate system”, to “the stretched or compressed space-time coordinate system”. Special relativity states that the speed of light remains the same under such transformations. Therefore, if a pair of photons are split from each other at a certain point, one travels along the stretched direction while the other travels along the compressed direction, and they are reflected by mirrors placed at the same distance from the splitting point before the transformation and recombined at the splitting point, the one travels along the stretched path will be behind the other at the moment of recombination. In terms of wave optics, the phase of the former is retarded relative to the latter. So, if we can detect such a relative phase difference, we can detect the effect of the gravitational wave. This leads to the idea of using a Michelson interferometer.

LIGO I detector

While the basic idea is straightforward, the actual measurement is quite challenging because the stretch/compression of space-time due to a gravitational wave is extremely small. It is predicted that a gravitational wave generated by a source in our own galaxy causes deformation of space-time on the earth of not more than 10^{-21} in strain [1, 2]. This means that even if the interferometer has an arm length on the order of a km, the corresponding length change due to a gravitational wave is on the order of 10^{-18} m, which is power-of-two smaller than the typical size of an atom, 10^{-10} m. This constraint requires a number of techniques, which will be outlined in the rest of this paper.

Noise source and gravitational wave signal detection band

Obviously, to detect such an extremely small signal, the management of various noises is extremely important. Fig. 3 shows main noise sources at various frequencies. The dominant noise sources at the low frequency range (from DC to about 50 Hz), the middle frequency range (50 – 200 Hz) and the high frequency range (over 200 Hz) are, respectively, seismic noise, thermal noise, and shot noise. Here, seismic noise is vibration of the ground; thermal noise is Brownian motion of the mirror (test mass), and shot noise is statistical fluctuation in the number of photons detected by a photo-detector. The LIGO I detector is designed to have the best sensitivity in a frequency band of 100 Hz – 200 Hz, where the overall noise is minimum. To maintain the wave front of the laser beam at this level, it is essential that the light is free of scattering, i.e., residual molecules must be removed from the beam path. For this reason, all the interferometer optics are installed in vacuum chambers and the entire optical path in the arm is covered by a beam tube maintained at a high vacuum.

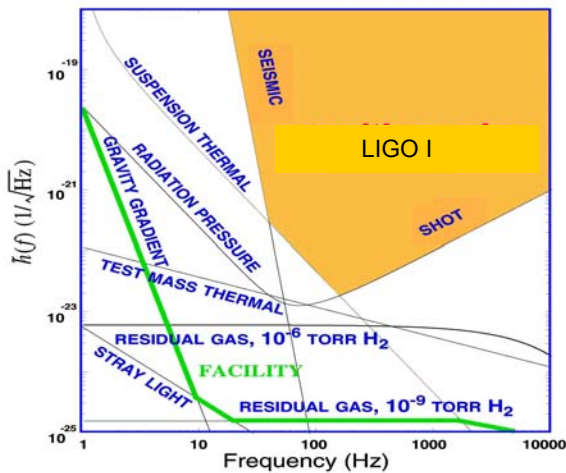

Fig. 3 Dominant noises at various frequencies [2]

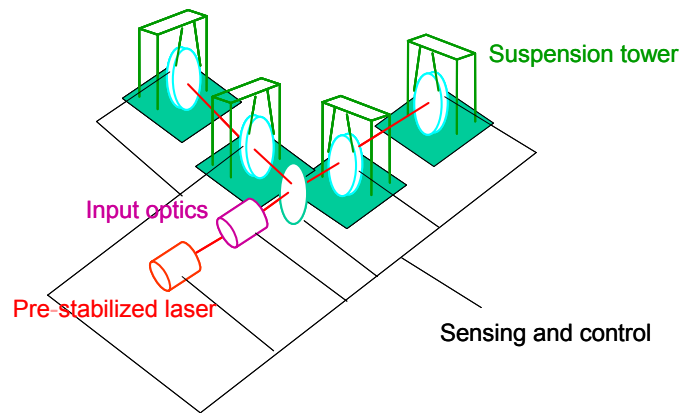

Fig. 4 Schematic view of LIGO I interferometer

LIGO I detector and sub-systems

One obvious idea to increase the sensitivity is to make the interferometer’s arm longer. As a simple consideration will reveal, the best sensitivity is achieved when the arm length is such that after a complete round trip in the arm the photons experience a half cycle of the gravitational wave [1]; i.e., along the stretched arm, the photons experience the stretched half cycle while along the other arm the photons experience the compresses half cycle of the gravitational oscillation. This means that at 200 Hz, the ideal arm length is $3 \times 10^8 \times (1/200)/2 = 750$ km, which is extremely impractical. To overcome this problem, the arm of the LIGO detector is configured as an optical cavity; in this fashion, the phase difference accumulates as the photons travel back and forth in the cavities. Within the limit where the laser shot noise becomes dominant, the sensitivity increases as the number of photons that carry the phase information increases. The LIGO I detector recycles the power coupled into the arm cavities. The LIGO I optics consists of three main sub-systems (Fig. 4): (1) the pre-stabilized laser [6], (2) the input optics [7], and (3) the core optics sub-systems [8]. The pre-stabilized laser subsystem is in air and the other two subsystems are in vacuum.

Pre-stabilized laser subsystem

The pre-stabilized laser consists of a master oscillator and power amplifier of Nd:YAG laser oscillating at $1.064 \mu\text{m}$. The output of the amplifier is stabilized in frequency, and reshaped in the wave front so that a clean beam in a TEM₀₀ Hermite-Gaussian mode can be delivered to the downstream optics. Three electro-optical phase modulators are installed in this sub-system for the purpose of generating three side bands that are used to lock the mode cleaner, recycling cavity and arm cavity (for cavity locking, see below). Optics in this sub-system are made of fused silica and 25 mm in diameter. They are mechanically mounted on an optical table, shielded by an acoustic damper. For further details about the pre-stabilized laser subsystem, see ref. 6.

Input optics subsystem

The input optics sub-system consists of a mode cleaner and a mode-matching telescope (Fig. 5), and its function is to provide a clean, mode-matched beam to the arm cavities. The mode cleaner is a triangular cavity and it serves to reduce amplitude and frequency noises of the pre-stabilized laser light, decrease beam jitter (motion), filter non-TEM₀₀ components and incorrectly-polarized component introduced by the optics in front of it. The cavity length of the mode cleaner is controlled by the Pound-Drever-Hall reflection-sensing scheme described later. The mode-matching telescope consists of three concave mirrors and it serves to convert the TEM₀₀ mode on the mode cleaner's basis to that on the arm cavity basis. All the mirrors in this sub-system are dielectric coated fused silica, where the diameter of the third mode-matching telescopic mirror is 250 mm and that of the other mirrors is 75 mm. To isolate from seismic noise, these mirrors are suspended from a suspension cage and placed on an optical table with vibration isolation stacks. For further details about the input optics subsystem, see ref. 7.

Core optics subsystem

The core optics subsystem is an interconnected system consisting of arm cavities, a Michelson cavity, and a power-recycling cavity (Fig. 6). The arm cavities are defined by the input test mass (ITM) and end test mass (ETM) of the two arms, and behave as reflectors when locked. The Michelson cavity is defined by the beam splitter (BS) and two arm cavities. The power-recycling cavity is defined by the recycling mirror (RM) and two ITMs. Here the word lock means the situation where the cavity is at resonance and the error signal associated with the cavity length is locked around the null point (see below). Since the core optic is a coupled cavity, it is necessary to lock the cavity for multiple degrees of freedom [9]. In the LIGO I detector, this control is actualized through the length sensing control as described below. When the interferometer is locked for all the degrees of freedom, the coupled cavity has an optical gain of 3000 (the arm cavity 120 and the power-recycling cavity 25). For further details about the core optics subsystem, see ref. 8.

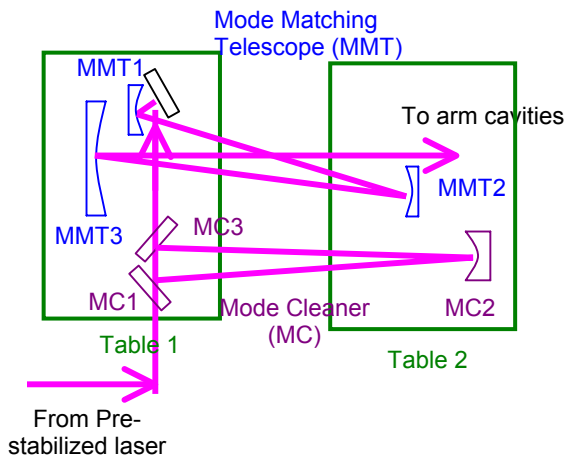

Fig. 5 Mode matching with input optics

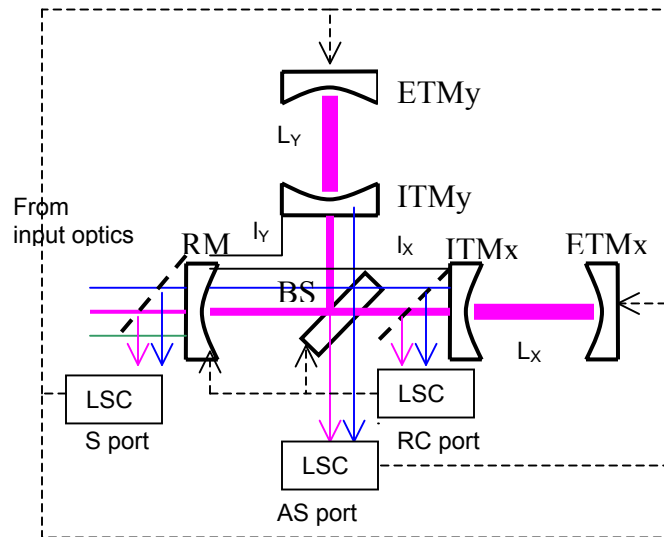

Fig. 6 LIGO I cavities. Dashed lines represent controls.

Suspended mirror

To detect a gravitational wave in the above-mentioned fashion, it is essential that the mirrors forming the interferometer are free masses. In the LIGO detector, the interferometer mirrors are suspended with a wire from a suspension cage, and their positions are actively controlled so that the cavity length is maintained at the resonance (Fig. 4). To reduce positioning fluctuation due to the motion of individual suspended mirror forming the cavity, the suspension is designed to have a high quality factor with a resonance frequency far away from the signal band (100 – 200 Hz). To isolate from ground motion, the suspension cage is installed on an optical table placed on vibration isolation stacks [10]. For further details about the LIGO optic suspension, see refs. 3 and 11.

Controls

To form an optical cavity with suspended mirrors, it is essential to locate and orient the mirrors precisely. To this end, the LIGO detector employs various feedback controls. Below some of these controls are outlined. For details of each control, see the reference provided in each section.

Local damping control [11]

Fig. 7 shows the 75 mm diameter suspended mirror. The local damping control is actualized by a combination of shadow sensor and coil actuator, which works as follows. Each mirror has four bar magnets attached on the rear surface and one magnet on a side as the inserts of Fig. 7 indicate. On the suspension cage, five actuator heads consisting of a shadow sensor (a pair of a light emitting diode and a photodiode) and an electric coil around the shadow sensor are attached in such a way that each of the magnets is located in the space inside one actuator head. When the mirror is at the right position and orientation, the position of the actuator head is adjusted relative to the magnet so that about a half of the light from the light emitting diode is blocked by the magnet. For example, when the mirror experiences an upward pitch motion (a rotational motion around a horizontal axis going through the mirror's body in the direction that causes the light reflected on the mirror's front surface goes up), the upper two sensors' reading decreases (because the magnets go deeper in the shadow sensors) and the lower two sensors' reading increases as compared with the nominal orientation. In response to this change in the signal over time (dV/dt , where V is the sensor's signal corresponding to the pitch motion) is minimized. Since dV/dt is proportional to the velocity of the mirror's pitch motion, the control signal damps the mirror's pitch motion. In the same fashion, the local damping servo damps the mirror's position (normal to the mirror surface), yaw (rotation around a vertical axis) and side (translational displacement parallel to the mirror surface) motions. It is important to note that the local damping servo is designed not to decrease the quality factor of the suspension so that the mass is quiet and free at the signal band.

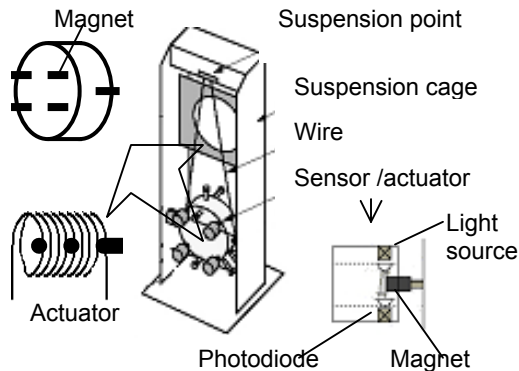

Fig. 7 Suspension cage and local damping sensor/actuator

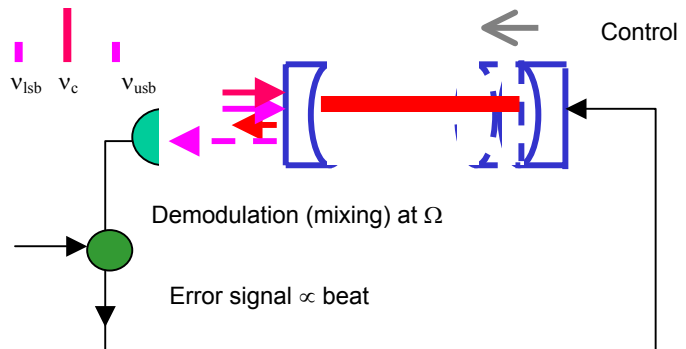

Fig. 8 Pound-Drever-Hall reflection sensing. Carrier is reflected when cavity length is incorrect. Side bands are always reflected.

Length sensing control [12]

The length sensing control plays the most important role in the LIGO detector. With the power-recycling cavity, the coupled cavity has four degrees of freedom (Fig. 6): (1) the common arm cavity length $L_+ = (L_x + L_y)/2$, (2) the differential cavity length $L_- = (L_x - L_y)/2$, (3) recycling cavity length $l_+ = (l_x + l_y)/2$, and (4) Michelson length $l_- = (l_x - l_y)/2$. These degrees of freedom are controlled by signals denoted by dashed lines in Fig. 6. As to what signal is used to control which degree of freedom is not a simple matter because the same signal has sensitivity to more than one degree of freedom. Roughly speaking, the differential mode l_- is controlled by moving the beam splitter using the quad-phase signal from the recycling cavity port; the common modes L_+ and l_+ are controlled by moving the end test masses and recycling mirror, respectively, using the in-phase signals from the symmetric port and recycling port (both signals have sensitivity to both common modes); and the differential mode L_- is controlled by moving the end test masses using the quad-phase signal from the anti-symmetric port, based on the Pound-Drever-Hall reflection sensing and Schnupp's asymmetry scheme. Here the in-phase and quad-phase represent the phase reference to the modulation signal for the phase modulation as described below, and the anti-symmetric (AS), recycling (RC) and symmetric (S) ports are as shown in Fig. 6.

Of these four degrees of freedom, the differential cavity length L_- is particularly important because it reads out gravitational wave signals, as will be formulated below. It should be noted that the control servo for L_- has substantial gain in the signal band; in other words, the test masses are not completely free objects. However, since the closed loop transfer function is precisely characterized, it is possible to extract from the error signal the portion due to a gravitational wave. On the other hand, since the control force works equally on the length change due to a gravitational signal and noises, the signal-to-noise ratio is not degraded by the control servo.

Pound-Drever-Hall reflection sensing [14]

Consider the light incident to an optical cavity is phase-modulated and has side bands, where the carrier frequency is resonant to the cavity and the side band frequencies are not resonant. When the cavity length is correct, the carrier component of the incident light is coupled into the cavity and the side band components are rejected at the first mirror of the cavity. Therefore, if a pick-off mirror is placed before the first mirror, the picked-off light consists of a mixture of carrier and side bands when the cavity length is incorrect (Fig. 8), and consists of only the carrier when the cavity length is correct. The Pound-Drever-Hall sensing scheme utilizes the fact that the beat between the carrier and the first order side bands has a component proportional to the error in the cavity length. Since this component oscillates at the modulation frequency, a DC error signal can be generated by demodulating the output of the photo detector. Below, this mechanism is outlined.

Let ω be the carrier frequency, Ω be the modulation frequency, ϕ be the set cavity length in the unit of phase, and δ be the deviation from the resonant cavity length in the unit of phase. Then the optical power at the pick-off mirror can be given as

$$P_{po} \propto \cos(\omega t \pm \Omega t) \cdot \cos\{\omega t + (\phi + \delta)\} = (1/2)[\cos\{2\omega t \pm \Omega t + (\phi + \delta)\} + \cos\{(\phi + \delta) \mp \Omega t\}]$$

The second term in the bracket, which oscillates at the modulation frequency Ω , can be further transformed as

$$\cos\{(\phi + \delta) \mp \Omega t\} = \cos(\phi + \delta) \cdot \cos\Omega t \pm \sin(\phi + \delta) \cdot \sin\Omega t$$

When the set phase $\phi = \pi/2$ and the deviation δ is small, the above equation can be approximated as $\delta \cdot \cos\Omega t \pm \sin\Omega t$, where the small angle approximation $\sin\delta \cong \delta$ and $\cos\delta \cong 1$ are used. Therefore, if the output voltage of the photo-detector, which is proportional to P_{po} , is demodulated at the modulation frequency, the in-phase component of the resultant signal is proportional to δ . Using this fact, we can make a control servo that pushes the demodulated signal toward zero to adjust the location of the back mirror at the resonance.

Schnupp's asymmetry [15]

The LIGO I detector reads out the gravitational wave signal by applying the Pound-Drever-Hall scheme to the Michelson interferometer. When a gravitational wave deforms the space-time, one of the arm cavities becomes longer than the other, and consequently, the carriers having passed through the respective arm cavities show a relative phase difference when recombined at the beam splitter. If the differential cavity length L_1 and L_2 are adjusted in such a way that at the side of the beam splitter labeled as the anti-symmetric (AS) port in Fig. 6 the carrier from the two arms interfere destructively but the side bands reflected by the input test masses interfere constructively, the deviation of the arm cavity length from the perfectly resonating condition due to gravitational wave signal can be sensed as the resultant Pound-Drever-Hall error signal from the photo detector placed at the anti-symmetric port. Note that if the distance from the beam splitter to an input test mass is the same as that to the other input test mass, it is impossible to make the carriers interfere destructively and side bands constructively; it is necessary to introduce asymmetry and this asymmetry is called the Schnupp's asymmetry.

Gravitational wave signal at anti-symmetric port

The Pound-Drever-Hall error signal due to a gravitational wave can be expressed as follows. Let $\Phi = \Phi_{gw} + \Phi_0$ be the differential phase change in one arm, where Φ_{gw} is due to a gravitational wave signal and Φ_0 is a set phase. Since the other arm experiences a phase change with an opposite sign and the same amount, the relative phase change detected at the anti-symmetric port is 2Φ . With a similar argument as above, the output of a photo-detector placed at the anti-symmetric port can be written as

$$P_{AS} \propto 1 + \cos 2(\Phi_0 + \Phi_{gw} + \Gamma \sin \Omega t)$$

where Γ is the depth of the phase modulation. By expressing $\cos(\Gamma \sin \Omega t)$ and $\sin(\Gamma \sin \Omega t)$ with Bessel functions and using the small angle approximation $\sin\delta \cong \delta$ and $\cos\delta \cong 1$, P_{AS} can be simplified as follows [15].

$$P_{AS} \propto (\Gamma^2 + 4\Gamma\Phi_{gw}\sin\Omega t - \Gamma^2\cos 2\Omega t)$$

By demodulating this signal at the modulation frequency Ω , we can detect the phase change Φ_{gw} . It is important to note that only the gravitational signal term has oscillation at the modulation frequency Ω [16].

Alignment sensing control [17]

The alignment sensing control is based on a technique called the wave front sensing scheme [18]. When the incident beam and a cavity have angular misalignment, the optical power coupled into the cavity reduces. This situation can be viewed as higher order modes are excited (from the viewpoint of the original, correct TEM00), and these higher order modes are not

coupled into the cavity. The wave front sensing scheme detects the amplitude modulation due to interference between the carrier TEM₀₀ mode and a side band TEM_{01/10} using a segmented photo-detector (Fig. 9). Since the two peaks in the TEM_{10/01} mode are out of phase from each other, when one peak interferes with the TEM₀₀ mode constructively, the other interferes destructively. Consequently, the outputs from two segments of a photo-detector separated at the beam center have out-of-phase temporal modulation. Using the same demodulation technique as the length sensing control, the wave front sensing scheme generates a DC error signal from the beat between the carrier and side band, and thereby controls the orientation of the mirror to correct the angular misalignment.

Thermal compensation [19]

When the arm cavity is locked, high optical power is transmitted through the input test mass. Consequently, an unwanted gradient in the index of refraction is generated inside the input test mass by a mechanism known as the thermal lensing effect, and the mode matching to the arm cavity is degraded. To reduce this effect, the LIGO I detector uses a thermal compensation system, in which 10.6 μm radiation from a carbon dioxide laser is directly applied to the input test mass. Fig. 10 illustrates the thermal compensation conceptually, where the edge of the thermal lens induced by the YAG laser is heated by CO₂ laser radiation so that the thermal change in the index of refraction becomes uniform.

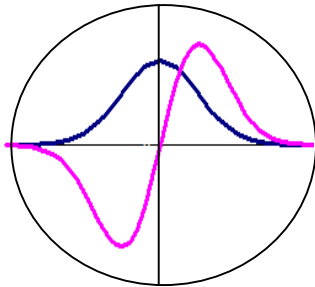

Fig. 9 Wave front sensor. Beat between TEM₀₀ and TEM₁₀ on right-half and left-half have a phase difference of π

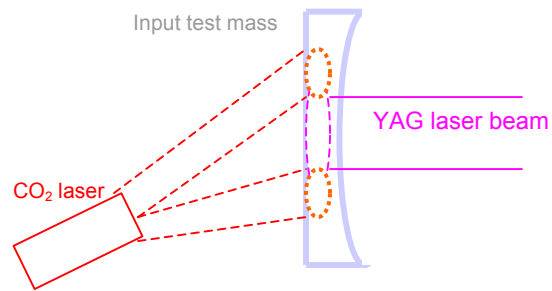

Fig. 10 Thermal compensation. CO₂ laser radiation forms artificial positive lens near the edge of thermal lens induced by YAG laser radiation.

Best sensitivity

Since the completion of hardware installation in 2000, commissioning activity has been conducted and is still being continued. As of February 2005, three scientific runs have been conducted and the fourth run is being undertaken. Fig. 11 shows the trend of the best sensitivity achieved in the previous three science runs. In the frequency band of 100 – 200 Hz, the best sensitivity has reached the level less than a factor of two above the targeted sensitivity. The duty cycle of the measurement mode is at a level higher than 60%.

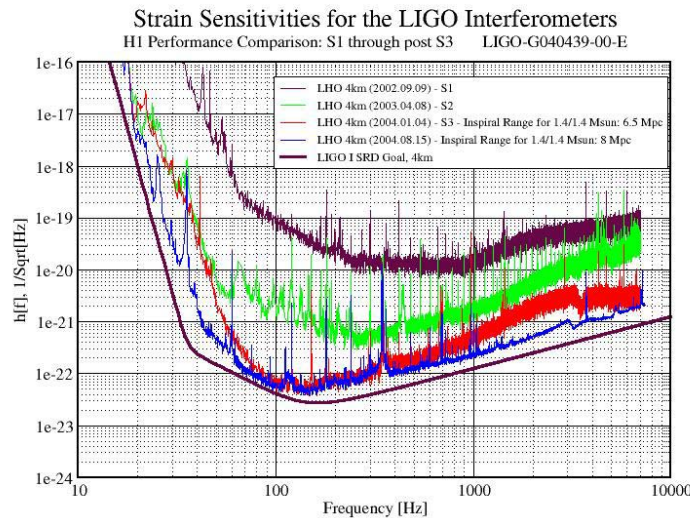

Fig. 11 Best sensitivity of LIGO I detector

Conclusion

Basic features of the LIGO I gravitational wave detector were presented. The interferometer and its subsystems were described and key techniques essential for the operation of the detector were outlined. References were provided for further details about these techniques.

References

- [1] P. R. Saulson, *Fundamentals of Interferometric Gravitational-wave Detectors* (World Science, 1994)
- [2] B. C. Barish and R. Weiss, "LIGO and detection of Gravitational waves," *Physics Today*, 52, 10, 44-50 (1999)
- [3] B. Abbot, et al., "Detector Description and Performance for the First Coincidence Observations between LIGO and GEO," *Nuclear Inst. and Methods in Physics Research A*, 517, 154-179 (2004)
- [4] K. Thorn, in S. Hawking, W. Israel, eds., *300 Years of Gravitation*, (Cambridge U. P., Cambridge, 1987)
- [5] B. F. Schutz, *A first course in general relativity*, chap. 5 (Cambridge U. P., Cambridge, 1985)
- [6] R. Savage, P. King, and S. Seel, "A Highly-Stabilized 10-Watt Nd:YAG Laser for the Laser Interferometer Gravitational-Wave Observatory," *Laser Phys.* 8, 679 (1998)
- [7] S. Yoshida et al., "Recent Developments in the LIGO Input Optics," in S. Kawamura and N. Mio eds., *Gravitational Wave Detection II, Proceedings of the 2nd TAMA International Workshop on Gravitational Wave Detection*, Oct. 19-22, 1999, Tokyo, Japan, 51-59 (Univ. Acad. Press, Inc., Tokyo, 2000)
- [8] S. Whitcom et al., "Optics development in LIGO", in K. Tsubono, M. -K. Fujimoto, K. Kuroda eds., *Proceedings of the TAMA International Workshop on Gravitational Wave Detection*, Nov. 11-12, 1996, Saitama, Japan (Univ. Acad. Press, Inc., Tokyo, 1997)
- [9] M. Evans, et al., "Lock acquisition of a gravitational wave interferometer," *Opt. Lett.*, 27, 598 (2002)
- [10] J. Giaime, P. Saha, D. Shoemaker, L. Sievers, "A Passive Vibration Isolation Stack for LIGO: Design, Modeling, and Testing," *Rev. Sci. Instr.* 67, 208 (1996)
- [11] P. Fritschel, "Local Damping Gain in SOS & LOS Suspensions," *LIGO T990085-00-D* (1999)
- [12] P. Fritschel, R. Bork, G. Gonzalez, N. Mavalvala, D. Ouimette, H. Rong, D. Sigg, and M. Zucker, "Readout and Control of a Power-Recycled Interferometric Gravitational -Wave Antenna," *Appl. Opt.* 40, 4988 (2001)
- [13] M. Rakhmanov, R. L. Savage, D. H. Reitze and D. B. Tanner, "Dynamics resonance of light in Fabry-Perot cavities," *Phys. Lett. A*, 305, 239 (2002)
- [14] R. Drever, J. Hall, F. Kowalski, J. Hough, G. Ford, A. Munley and H. Ward, "Laser phase and frequency stabilization using an optical resonator," *Appl. Phys. B*, 31, 97-105 (1983)
- [15] L. Schnupp unpublished (1987)
- [16] P. R. Saulson, *Fundamentals of Interferometric Gravitational-wave Detectors* , p. 194 (World Science, 1994)
- [17] P. Fritschel, N. Mavalvala, D. Shoemaker, D. Sigg, D. Zucker and G. Gonzalez, "Alignment of an interferometric gravitational-wave detector," *Appl. Opt.* 37, 6734 (1998)
- [18] N. Mavalvala, D. Sigg, and D. Shoemaker, "Experimental test of an alignment-sensing scheme for a gravitational-wave interferometer," *Appl. Opt.* 37, 7743 (1998)
- [19] D. Zucker, D. Ottaway and K. Mason, "Thermal Compensator Retrofit for LIGO I," *LIGO T-030062-03-D* (2003)