



HAL
open science

Determination of wind turbine far wake using actuator disk

Rodeyna Amer, Ivan Dobrev, Fawaz Massouh

► **To cite this version:**

Rodeyna Amer, Ivan Dobrev, Fawaz Massouh. Determination of wind turbine far wake using actuator disk. Valencia Global 2014, Escuela Técnica Superior de Ingeniería del Diseño, Jun 2014, Valencia, Spain. pp.254-260. hal-01083853

HAL Id: hal-01083853

<https://hal.science/hal-01083853>

Submitted on 1 Apr 2015

HAL is a multi-disciplinary open access archive for the deposit and dissemination of scientific research documents, whether they are published or not. The documents may come from teaching and research institutions in France or abroad, or from public or private research centers.

L'archive ouverte pluridisciplinaire **HAL**, est destinée au dépôt et à la diffusion de documents scientifiques de niveau recherche, publiés ou non, émanant des établissements d'enseignement et de recherche français ou étrangers, des laboratoires publics ou privés.



Science Arts & Métiers (SAM)

is an open access repository that collects the work of Arts et Métiers ParisTech researchers and makes it freely available over the web where possible.

This is an author-deposited version published in: <http://sam.ensam.eu>
Handle ID: <http://hdl.handle.net/10985/8925>

To cite this version :

Rodeyna AMER, Ivan DOBREV, Fawaz MASSOUH - Determination of wind turbine far wake using actuator disk - In: Valencia Global 2014, Escuela Técnica Superior de Ingeniería del Diseño, Spain, 2014-06-19 - Proceedings of the 4th International Meeting Valencia Global - 2014

Any correspondence concerning this service should be sent to the repository

Administrator : archiveouverte@ensam.eu

Determination of wind turbine far wake using actuator disk

RODEYNA AMER¹, IVAN DOBREV² and FAWAZ MASSOUH³

¹Damascus University, rodeyna_amer@yahoo.com

²ENSAM-Paris, ivan.dobrev@ensam.eu

³ENSAM-Paris, fawaz.massouh@ensam.eu

Keywords: Wind turbine, Wake, Atmospheric boundary layer

Abstract

The growth in size of wind turbines over the last years is significant. The rotor diameter becomes somehow comparable to atmospheric boundary layer at the land surface. In this case the assumption of uniform velocity of upcoming wind cannot be valid. The aim of this paper is to create a simplified model of wind turbine rotor which can represent the aerodynamic interaction of atmospheric boundary layer with a horizontal axis wind turbine. Such model will be also useful for the study of optimal placement of wind turbines in a wind farm when a large number of calculations is needed and when the time required for full CFD calculations becomes prohibitive. In this study we adopt actuator disk model which takes in account with sufficient precision the influence of blade geometry on wind turbine aerodynamic performance. The proposed actuator disk model is tested in the case of horizontal axis wind turbine using wall-modelled large eddy simulation. The obtained results of aerodynamic performance and wake show the rapidity of calculation and the reliability of proposed approach.

1 Introduction

The aerodynamic interaction between atmospheric boundary layer (ABL) and wind turbines becomes important problem in both the wind turbine design and also the optimizing of wind turbines placement in a wind park. The wind turbine rotor converts airflow kinetic energy into mechanical energy and as results the flow velocity behind the rotor will be lower than the upstream velocity. The Froude-Rankine momentum theory shows that the amount of power which can be extracted by a wind turbine rotor is $16/27$ of the total power in the wind. At this point of operation, so-called Betz limit, the velocity decreasing at the rotor plane represents $1/3$ of upstream velocity and becomes $2/3$ in the far wake, Hansen [1]. The accurate prediction of the wake is of great importance for the study of optimal placement of wind turbines in the wind farm. The flow in the rotor wake is highly turbulent with large scale turbulent structures. If another wind turbine operates in this wake, its blades will be subjected to unsteady aerodynamic forces and that will lead to the decreasing of blade fatigue life. It should be noted that it is not practical to avoid completely aerodynamic interference between the wind turbines because in this case, the increasing of distance between the wind turbines will decrease significantly the park efficiency. As rule of thumb the distance between the wind turbines is nearly seven diameters, if the wind farms have multiple rows of turbines, Wizelius [2]. However, depending on local land use requirements, ground surface relief or atmospheric boundary layer, this rule cannot be always applied.

Generally the optimal wind turbine placement is carried out by means of special software. For many years this software was based on simplified engineering tools, but in recent years the use computational fluids dynamics (CFD) becomes more and more common. Depending on optimizing algorithm, during the design process, multiple cases of wind turbine placements must be considered. However, the full geometric modelling of all of the wind turbines is not practical, because of the high computational requirement. In order to reduce computing time, several researchers adopt the so-called hybrid models which couple the CFD solver to blade element model, Vermeer [3]. In this kind of modelling, the aerodynamics forces applied on the blade do not result directly from CFD, but are calculated separately using inflow data and blade geometry. This calculation is car-

ried out jointly with the numerical simulation. The blade forces are calculated at each iteration and are implemented as source terms in the flow. Depending on the distribution of the source terms, there exist three hybrid models: actuator disk, actuator line and actuator surface.

The simplest hybrid model is the actuator disk which replaces the wind turbine rotor by a thin disk volume. Generally, the disk has a diameter equal to the rotor diameter and in its interior the blade forces exerted on the fluid are replaced by equivalent source terms. This model was introduced in the case of wind turbine by Sørensen&Myken in [4] by means of an axisymmetric Euler solver. In this study, the rotor is replaced by equivalent source terms with constant intensity. This intensity is calculated from the thrust of the wind turbine. Lately Sørensen&Kock [5], propose improved model in which the source terms vary depending on rotor radius. In this study, the authors calculate source terms from the rotor inflow and the blade aerodynamic data. Three-dimensional calculations with actuator disk are presented by Amara et al [6] in the cases of isolated and clustered wind turbines. The obtained results for isolated wind turbine are similar of those calculated in axisymmetrical case, but in 3D permit to show a positive effect of interference for two row periodic wind farm. The actuator disk is extensively tested by Mikkelsen [7] for several operation conditions. Here, the author proves model reliability for wind turbine analysis and wake calculation. Kasmi&Masson [8] also develop actuator disk model and apply an extended $k-\epsilon$ turbulence model. This turbulence model permits to improve the flow simulation around the rotor and also in the near and in the far wake. Calculations carried out for three different wind turbines, show better results especially for near wake in comparison with standard $k-\epsilon$ methods. The Reynolds Averaged Navier-Stokes (RANS) based turbulence modelling is often used for modelling of flow over complex terrain. The RANS provides reasonable accuracy but have some difficulties to represent the instantaneous flow. For this kind of flow it is well known that the method of Large Eddy Simulation (LES) reproduces well detailed flow characteristics, Jimenez [9]. The simplified rotor model with constant source term intensity, gives satisfying information not only for the mean flow, but also for eddies larger than the mesh size. The authors suggest that LES will be especially useful to reproduce the wake meandering. The advantages of using of LES are confirmed by Wu et al [10] who compare the results of simulation with those obtained by means of hot wire anemometry in the wind tunnel. Additionally, the authors show that the actuator disk with source terms distributed according to blade load gives better results in comparison with uniform distribution. Lately, the same model presented by Porté-Agel et al [11] is applied in case of large offshore wind park. In this study, the researchers calculate the power output of the wind turbine for multiple wind direction and show a strong power fluctuation for small wind direction shift.

The actuator disk gives a good result for the far wake, where the individual presence of the blades becomes small and therefore can be neglected. However, if a detailed representation of near wake or blade tip vortices is needed, a three-dimensional model for each blade must be used. Sørensen in [12] proposes so called actuator line model. In this model, the real blades geometry is replaced in CFD by source terms distributed radially along lines coincident with blade axis. Compared to actuator disk, this model represents each blade individually with its tip and root vortices which improves the near wake representation. The comparison of the actuator line with experimental data reveals the effectiveness of this proposed model for power characteristic calculation. The reliability of the model to represent near and far wake are proved by Ivanell [13], Troldborg [14] and recently by Lynch et al [15].

More complete hybrid model is the model of actuator surface applied by Dobrev&Massouh, [16], [17], Shen [18] et al and Sibuet Waters&Masson [19]. The main advantage of this model is more realistic force distribution along the blade. Instead of generic radial distribution around the blade axis, in this model the sources terms (or pressure discontinuity) are distributed similarly to pressure discontinuity created by the real blade. Thus velocity gradients created by the actuator surface becomes very close to real case which improve the initial conditions for the wake.

Regardless of good results presented by the actuator line and actuator surface, the model of the actuator disk is useful where the rapid calculation is needed. In fact, more realistic and fine source terms distribution needs more cells. Thus, the study presented by Churchfield et al [20] needs 315 million cells in order to simulate a wind park with 48 wind turbines.

The aim of this work is the creation of a numerical model of actuator disk which is capable to take into account the atmospheric boundary layer and also the development of wake behind the wind turbine.

2 Numerical model

The development of the actuator disk model presented in this paper is based on the works of Amara et al [6]. The model is implemented in commercial CFD code Ansys Fluent using special user defined functions (UDFs). The blade forces are represented by source terms which are calculated using blade geometry, blade airfoil data and the velocity field. Blade airfoil data can be obtained from experimental tests or extracted from 2D/3D simulations. CFD simulations are viscous and unsteady and use RANS or WMLES approach. The numerical model is developed for the case of single wind turbine installed on flat terrain and takes in account the inlet atmospheric boundary layer.

2.1 Actuator disk

The classical actuator model is developed for the case of steady flow and constant upstream velocity. However the atmospheric boundary layer should be taken into account and thus, some assumptions are required. Here we follow the approach present by Macridis and Chick [21], which distributes source terms depending on velocity in plane of actuator disk.

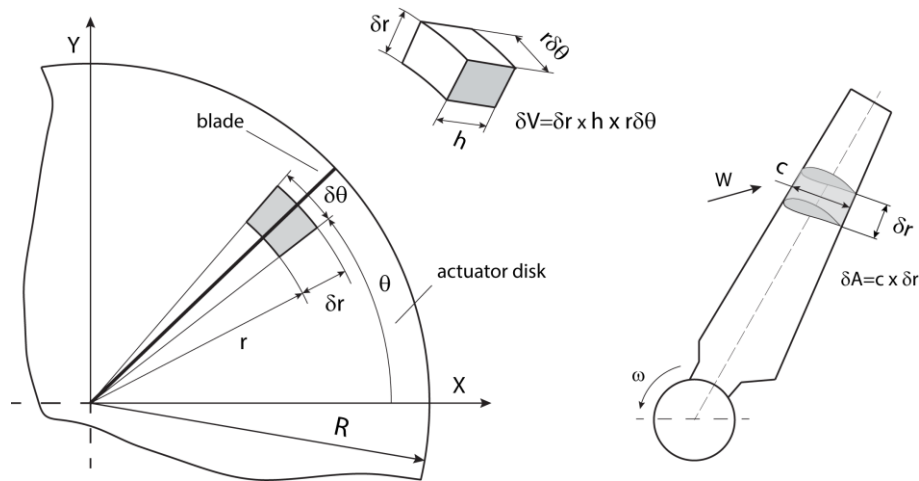

Fig. 1. Actuator disk concept

In the simulation model the rotor blades forces are distributed in a thin disk and each cell of this disk takes a fraction of the total blade forces. Usually, when the inflow velocity is constant, the blade forces depend only on radius and do not vary azimuthally so they can be averaged spatially. Here contrarily the blade forces are averaged temporarily over one blade passing period T :

$$T = \frac{2\pi}{N \cdot \omega} \quad (1).$$

Here ω is the angular velocity and N is the number of blades. The actuator disk, with a radius R equal to the rotor radius, is presented in Fig. 1. Let's calculate the averaged source terms intensity for an infinitesimal element situated at the radius r and the azimuth angle θ . This element corresponds to the sector $\delta\theta$, and if the blade is assumed as a thin line, the staying time of the blade in this element will be $\delta t = \delta\theta / \omega$; Fig.2. During the time δt this element will be submitted to the blade element force $\delta F_{L,D}$. Therefore, during a blade passing period, the time averaged force can be calculated as:

$$\delta F_{mL,D} = \delta F_{L,D} \frac{\delta t}{T} = \delta F_{L,D} \frac{N\delta\theta}{2\pi} \quad (2).$$

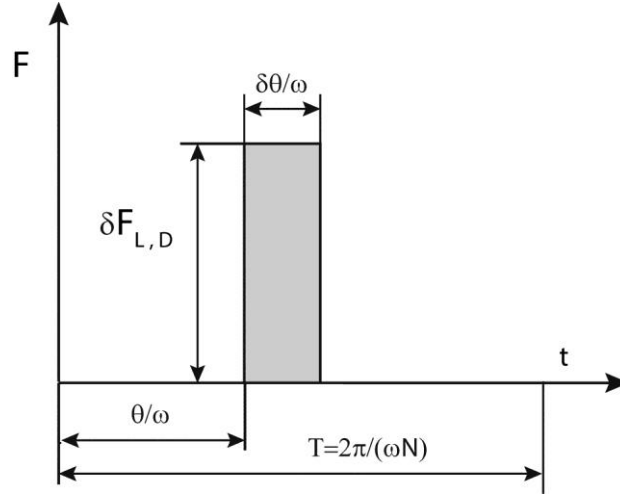

Fig. 2. Time diagram

Here, the force $\delta F_{L,D}$ which is applied on infinitesimal blade element with radial length of δr and chord of c , can be obtained by means of the blade element theory:

$$\delta F_{L,D} = \rho \frac{W^2}{2} C_{L,D}(\alpha) c(r) \delta r \quad (3).$$

In this formula, ρ is the air density, W is relative velocity and $C_{L,D}$ is the lift/drag coefficient of the blade section, Fig 3. The angle α is angle of attack, β is pitch angle and ϕ is the flow angle.

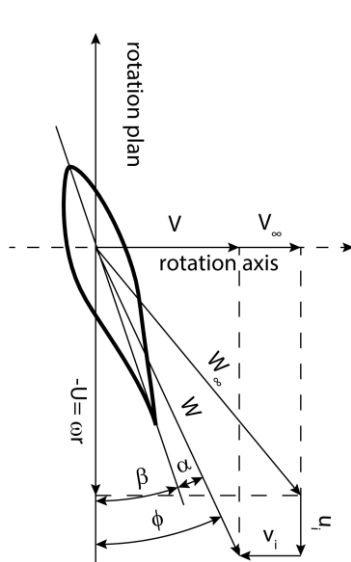

Fig. 3. Velocity

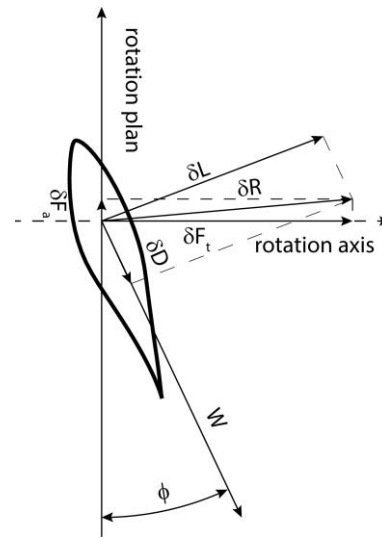

Fig. 4. Aerodynamic forces

Replacement of the blade force in Eq. (2) by means of the force, represented by Eq. (3), permit to obtain the averaged blade force applied on the infinitesimal actuator surface element:

$$\delta F_{mL,D} = \rho \frac{W^2}{2} C_{L,D}(\alpha) c(r) \delta r \frac{N \delta \theta}{2\pi} \quad (4).$$

If the actuator disk has a thickness h , the volume of the considered infinitesimal element is $dV = \delta r \times r \delta \theta \times h$. Therefore intensity of source terms is this element is:

$$f_{L,D} = \frac{\delta F_{mL,D}}{\delta V} = \rho \frac{W^2}{2} C_{L,D}(\alpha) c(r) \delta r \frac{N \delta \theta}{2\pi} \frac{1}{\delta r r \delta \theta h} \quad (5).$$

The simplification of Eq. (5) gives:

$$f_{L,D} = \rho \frac{W^2}{2} C_{L,D}(\alpha) c(r) \frac{N}{2\pi r h} \quad (6).$$

Thus, the eq. (6) permits to calculate the source terms intensity for each cell of the actuator disk, depending on cell centre radius r_c . In Eq. (6) the relative velocity is calculated from the following relation:

$$W = \sqrt{(\omega r + u_i)^2 + V^2} \quad (7).$$

Here ω is the angular velocity of the rotor disk, V is the axial velocity and u_i is the tangential velocity. The axial and tangential velocities should be obtained from CFD model during calculation, in the plane of actuator disk.

2.2 Tip loss correction, power and thrust

The tip loss correction for the wind turbines and propellers take into account finite aspect ratio of the blades. This correction takes into account the decreasing of pressure discontinuity near the blade tip and should be applied when blade element method is used. The correction factor F_1 is introduced in order to correct the blade section aerodynamic coefficients. Here the method proposed by Shen et al [21] is adopted:

$$C_{L,D} = F_1 C_{L,D}^{2d} \quad (8).$$

In this formula $C_{L,D}^{2d}$ is the lift or drag coefficient issues from 2d airfoil data and

$$F_1 = \frac{2}{\pi} \cos^{-1} \left[\exp \left(-g \frac{B(R-r)}{2r \sin \phi} \right) \right] \quad (9).$$

Here the function g is equal to:

$$g = \exp[-0.125(N\omega/V_\infty - 21)] + 0.1 \quad (10).$$

To obtain the power and the thrust (axial force) of the rotor, it is needed to calculate the tangential f_t and axial f_a source terms intensity. These intensities can be expressed by projections of the total aerodynamic force δR , Fig. 3, on the axial and tangential directions as follows:

$$f_t = f_L \sin \phi - f_D \cos \phi \quad (11),$$

and

$$f_a = f_L \cos \phi + f_D \sin \phi \quad (12).$$

Integration of f_a in the volume of actuator disk gives the thrust of the rotor:

$$F_a = \int_V f_a dv \quad (13).$$

Integration of f_t gives the power of the rotor:

$$F_a = \omega \int_V r f_t dv \quad (14).$$

Generally for CFD calculation the source terms should be expressed for Cartesian coordinate system. In the model presented in this paper, the axial direction coincides with z-axis, but tangential source terms should be expressed as source terms which act in x- and y- directions:

$$f_x = -f_t \sin \theta; \quad f_y = f_t \cos \theta; \quad f_z = f_a \quad (15).$$

2.3 Inflow boundary layer

The parameters of boundary layer which is used in this paper are proposed by Richards&Norris [23] and Tominaga et al [24]. Thus inlet velocity varies with height H as:

$$V(H) = \frac{u_{ref}^*}{K} \ln \left(\frac{H + H_0}{H} \right) \quad (16),$$

where $K=0.433$ is von Karman constant and u_{ref}^* is the friction velocity at the reference height:

$$u_{ref}^* = \frac{K U_{ref}}{\ln \left(\frac{H_{ref} + H_0}{H_{ref}} \right)} \quad (17).$$

The turbulence kinetic energy k and turbulent dissipation rate ε can be calculated as follows:

$$k = \frac{u_{ref}^2}{\sqrt{C_\mu}} \quad (18),$$

$$\varepsilon(H) = \frac{u_{ref}^3}{K(H + H_0)} \quad (19).$$

The atmospheric boundary layer parameters Eq. 16-19 are implemented in CFD code as user defined functions.

3 Numerical result and discussion:

3.1 Numerical model

The studied horizontal axis wind turbine has 3-blade rotor with diameter of 60m and hub height of 60m. The computational domain has length of 27.5D, width of 10D and height of 7.5D, where D is the rotor diameter, Fig. 5. The block structured grid of the domain has approximately 3 million hexahedral cells. Initially, the mesh has 200x100x100 cell, but in order to ameliorate the boundary layer modelling, the boundary cells of the ground surface are refined two times. The number of cell is limited, because such grid should represent only a part of large wind park model. The nacelle and mast are not modelled, distinct volume for the actuator disk is not defined and source terms are imposed only in cells in virtual volume which represent the rotor. Such approach permits to change wind turbine placement without change of initial grid.

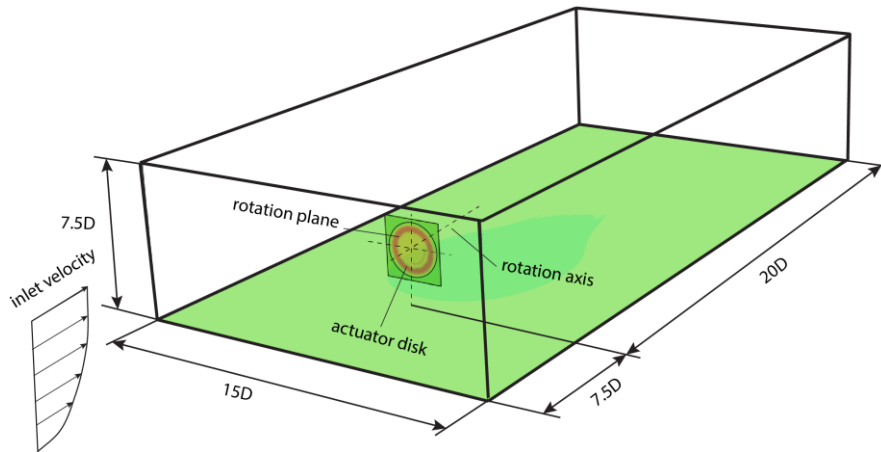

Fig. 5. Computational domain

The simulation is carried out by means CFD Ansys Fluent 14.5.7. For the turbulence, the model of wall modelled large eddy simulation (WMLES) is applied, Shur et al [25]. This kind of modelling permits to use LES, without need of fine boundary wall cells. The WMLES model is unsteady and can capture the vortex structures behind the rotor, better than any RANS method. Some inconvenience is the low time step; CFL should be less than 0.3. In this study the time step is equal to 0.01s. In order to obtain sufficient information about the flow structures behind the rotor and wake stability, more than 15000 time step are carried out during the simulation.

The presented simulation is carried out in the case of upstream velocity of 12.5 m/s at hub height, and angular velocity of 2.83 rad/s. The inlet velocities are calculated by means of Eq.16-17 and perturbed using method proposed by Mann [26]. The Fig. 6 and Fig. 7 shows the results obtained for unsteady velocity in horizontal and vertical plane. The Fig. 8 and Fig. 9 represent the vorticity and show that after a distance of 150m (nearly 2.5D) the wake becomes instable and after 10D vorticity tends to disappear.

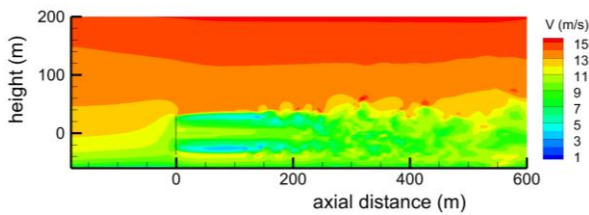

Fig. 6. Snapshot of velocity in vertical plane

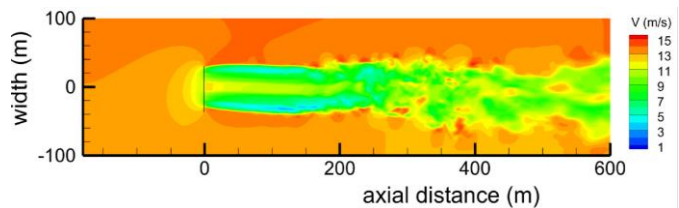

Fig. 7. Snapshot velocity in horizontal plane

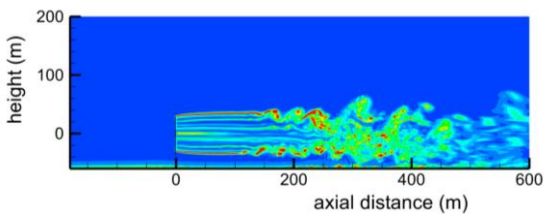

Fig. 8. Snapshot of vorticity in vertical plane

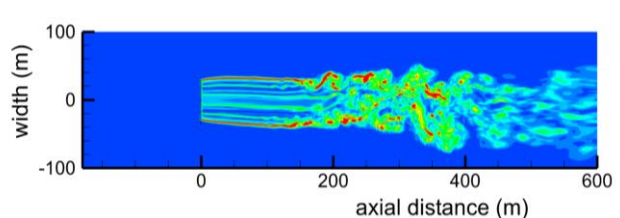

Fig. 9. Snapshot of vorticity in horizontal plane

The unsteady information about flow field is interesting, but it is important to show mean flow parameters. For this proper orthogonal decomposition (POD) is carried out using approach proposed by Chen et al [27]. The result for first mode POD of flow velocity in the vertical plane and corre-

sponding vorticity are shown in Fig. 10 and Fig. 11. The second and third modes POD of velocity are shown in Fig. 12 and Fig. 13. These velocity fields are quite similar, but slightly shifted in axial direction.

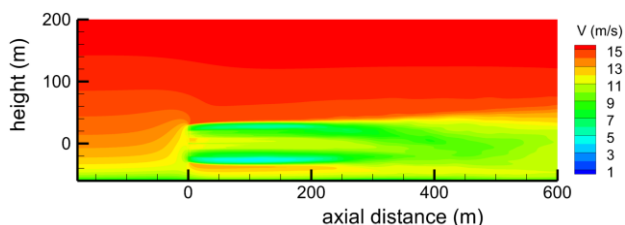

Fig. 10. POD, first mode: velocity in vertical plane

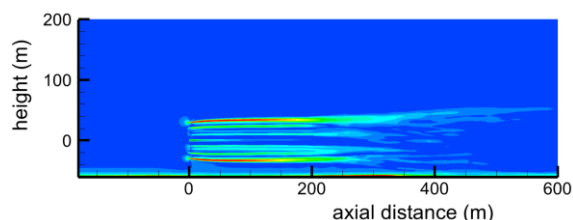

Fig. 11. POD, first mode: vorticity in horizontal plane

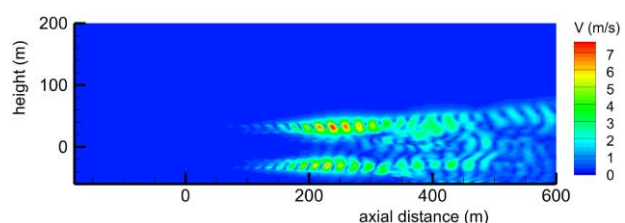

Fig. 11. POD, second mode: velocity in vertical plane

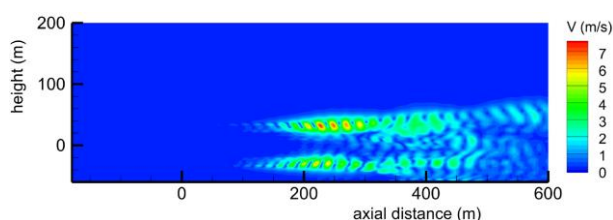

Fig. 12. POD, third mode: velocity in vertical plane

4 Conclusion

The proposed model of actuator disk takes into account the irregularity of the flow through the rotor and permits to represent the interaction of the wind turbine with atmospheric boundary layer. Despite of limited cell number it is possible to explore the wake development, its instability and mixing with the external flow. The obtained results are promising and the next step of model validation should be PIV measurement.

References

- [1] Hansen, M., Aerodynamics of wind turbines, *Routledge*, 2013.
- [2] Wizelius, T., Developing wind power projects: theory and practice, *Earthscan*, 2007
- [3] Vermeer, L. J., Sørensen, J., et Crespo, A., Wind turbine wake aerodynamics, *Progress in aerospace sciences*, vol. 39, no 6, p. 467-510, 2003
- [4] Sørensen, J., Myken, A., Unsteady actuator disc model for horizontal axis wind turbines. *Journal of Wind Engineering and Industrial Aerodynamics*, 39(1), 139-149, 1992.
- [5] Sørensen, J., Kock, C., A model for unsteady rotor aerodynamics, *Journal of wind engineering and industrial aerodynamics*, 58(3), 259-275, 1995
- [6] Ammara, I., Leclerc, C., Masson, C., A viscous three-dimensional differential/actuator-disk method for the aerodynamic analysis of wind farms, *Journal of Solar Energy Engineering*, 124(4), 345-356, 2002
- [7] Mikkelsen, R., Actuator disc methods applied to wind turbines. Diss. Technical University of Denmark, 2003.
- [8] El Kasmi, A., Masson, C. An extended $k-\epsilon$ model for turbulent flow through horizontal-axis wind turbines. *Journal of Wind Engineering and Industrial Aerodynamics*, 96(1), 103-122, 2008.
- [9] Jimenez, A., Crespo, A., Migoya, E., Garcia, J., Advances in large-eddy simulation of a wind turbine wake, *Journal of Physics: Conference Series*, Vol. 75, No. 1, p. 012041, 2007.

-
- [10] Wu, Y., Porté-Agel, F., Large-eddy simulation of wind-turbine wakes: evaluation of turbine parametrisations. *Boundary-layer meteorology*, 138(3), 345-366, 2011.
- [11] Porté-Agel, F., Wu, Y., Chen, C., A Numerical Study of the Effects of Wind Direction on Turbine Wakes and Power Losses in a Large Wind Farm. *Energies*, 6(10), 5297-5313, 2013.
- [12] Sørensen, J., Shen, W., Numerical modeling of wind turbine wakes, *Journal of fluids engineering*, vol. 124, no 2, p. 393-399, 2002.
- [13] Ivanell, S., Sørensen, J., Mikkelsen, R., Henningson, D, Analysis of numerically generated wake structures. *Wind Energy*, 12(1), 63-80, 2009.
- [14] Troldborg, N., Sorensen, J., Mikkelsen, R., Numerical simulations of wake characteristics of a wind turbine in uniform inflow. *Wind Energy*, 13(1), 86-99, 2010.
- [15] Lynch, C. E., Prosser, D. T., & Smith, M. J. (2014). An efficient actuating blade model for unsteady rotating system wake simulations. *Computers & Fluids*, 92, 138-150.
- [16] Dobrev, I., Massouh, F., Rapin, M., Actuator surface hybrid model, *Journal of Physics: Conference Series*, Vol. 75, No. 1, p. 012019, 2007
- [17] Dobrev, I., Massouh, F., Memon, A. Experimental and numerical study of flow around a wind turbine rotor. *International Journal of Engineering Systems Modelling and Simulation*, 5(1), 137-146, 2013.
- [18] Shen, W., Zhang, J., & Sørensen, J., The actuator surface model: a new Navier–Stokes based model for rotor computations. *Journal of Solar Energy Engineering*, 131(1), 011002, 2009.
- [19] Sibuet Watters, C., Masson, C., Modeling of lifting- device aerodynamics using the actuator surface concept. *International journal for numerical methods in fluids*, 62(11), 1264-1298, 2010.
- [20] Churchfield, M., Lee, S., Moriarty, P., Martinez, L., Leonardi, S., Vijayakumar, G., Brasseur, J., A large-eddy simulation of wind-plant aerodynamics, *AIAA paper*, (2012-0537), 2012
- [21] Makridis, A., Chick, J. Validation of a CFD model of wind turbine wakes with terrain effects. *Journal of Wind Engineering and Industrial Aerodynamics*, 123, 12-29, 2013.
- [22] Shen, W., Sørensen, J., Mikkelsen, R., Tip loss correction for actuator/Navier–Stokes computations. *Journal of Solar Energy Engineering*, 127(2), 209-213, 2005.
- [23] Richards, P., Norris, S., Appropriate boundary conditions for computational wind engineering models revisited. *Journal of Wind Engineering and Industrial Aerodynamics*, 99(4), 257-266, 2011.
- [24] Tominaga, Y., Mochida, A., Yoshie, R., Kataoka, H., Nozu, T., Yoshikawa, M., Shirasawa, T., AIJ guidelines for practical applications of CFD to pedestrian wind environment around buildings. *Journal of wind engineering and industrial aerodynamics*, 96(10), 1749-1761, 2008
- [25] Shur, M., Spalart, P., Strelets, M., Travin, A., A hybrid RANS-LES approach with delayed-DES and wall-modelled LES capabilities., *International Journal of Heat and Fluid Flow*, 29(6), 1638-1649, 2008.
- [26] Mann, J., Wind field simulation, *Probabilistic engineering mechanics*, 13(4), 269-282, 1998.
- [27] Chen, H., Reuss, D., Sick, V., On the use and interpretation of proper orthogonal decomposition of in-cylinder engine flows. *Measurement Science and Technology*, 23(8), 085302.,2012