



HAL
open science

Advances and applications of DS_mT for information fusion - Collected works - Volume 3

Florentin Smarandache, Jean Dezert

► To cite this version:

Florentin Smarandache, Jean Dezert (Dir.). Advances and applications of DS_mT for information fusion - Collected works - Volume 3. American Research Press, 3, pp.760, 2009, Advances and applications of DS_mT for information fusion, 1-59973-073-1. hal-01080187

HAL Id: hal-01080187

<https://hal.science/hal-01080187v1>

Submitted on 5 Nov 2014

HAL is a multi-disciplinary open access archive for the deposit and dissemination of scientific research documents, whether they are published or not. The documents may come from teaching and research institutions in France or abroad, or from public or private research centers.

L'archive ouverte pluridisciplinaire **HAL**, est destinée au dépôt et à la diffusion de documents scientifiques de niveau recherche, publiés ou non, émanant des établissements d'enseignement et de recherche français ou étrangers, des laboratoires publics ou privés.



Distributed under a Creative Commons Attribution - NonCommercial - NoDerivatives 4.0 International License

Florentin Smarandache & Jean Dezert

Editors

**Advances and Applications of DS_mT
for Information Fusion
Collected Works**

Volume 3

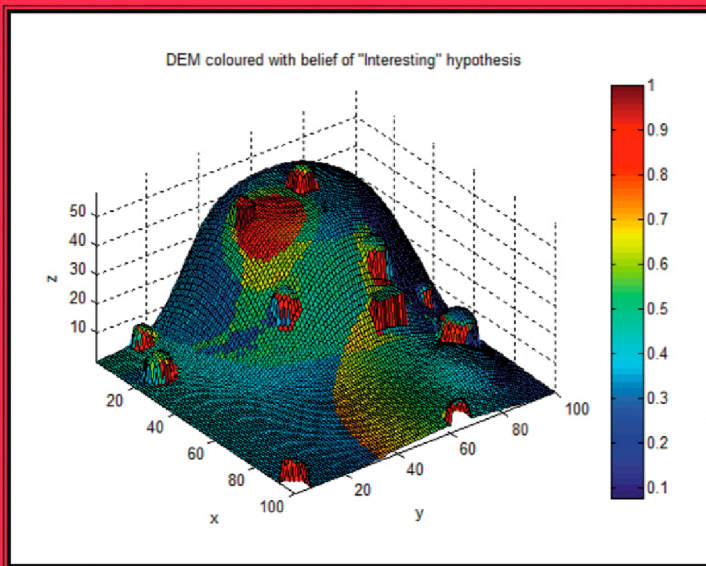

American Research Press (ARP)

2009

Florentin Smarandache & Jean Dezert

Editors

Advances and Applications of DS_mT for Information Fusion

Collected Works

Volume 3

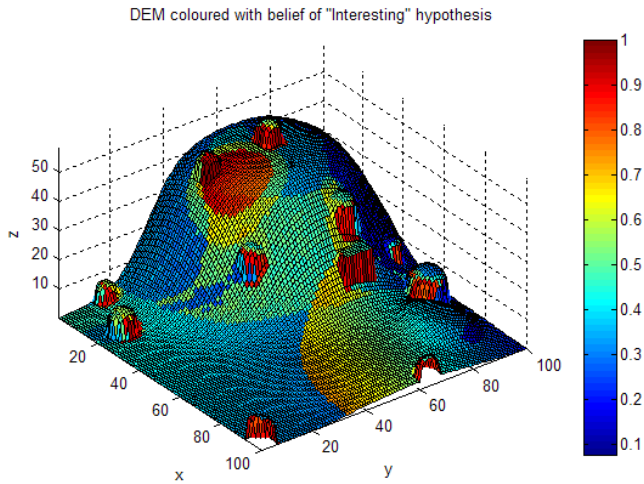

ARP

2009

This book can be ordered in a paper bound reprint from:

Books on Demand
ProQuest Information & Learning
(University of Microfilm International)
300 N. Zeeb Road, P.O. Box 1346,
Ann Arbor, MI 48106-1346, U.S.A.

The book is also in Amazon Search Inside the Book, in Amazon Kindle, and in Google Book Search and can be downloaded freely from the web site:

<http://www.gallup.unm.edu/~smarandache/DST-book3.pdf>.

Download books from the Digital Library of Science at:

<http://www.gallup.unm.edu/~smarandache/eBooks-otherformats.htm>

This book has been peer reviewed and recommended for publication by:

1 - Dr. Albena Tchamova

Institute for Parallel Processing, Bulgarian Academy of Sciences,
“Acad. G. Bonchev” Str., bl.25-A, 1113 Sofia, Bulgaria.

2 - Dr. Pierre Valin

Decision Support Systems section, Defence R&D Canada Valcartier,
2459 Pie-XI Blvd. North, Québec, G3J 1X5, Canada.

ISBN-10: 1-59973-073-1

ISBN-13: 978-1-59973-073-8

EAN: 9781599730738

The ISSN 1938-5544 has been assigned by The Library of Congress, Washington D.C., U.S.A., for this book series.

This book has been typesetted using L^AT_EX and the memoir class and printed in the United States of America.

© 2009 by the Editors, the Authors for their articles, and the Publishing House.

About the cover: This figure is drawn from Chapter 13 and corresponds to the 3D simulated interest map for automatic goal allocation for a planetary rover. The colors are associated to the interest level for each point on the surrounding landscape.

Preamble

This volume on advances and applications of Dezert-Smarandache Theory (DSmT) for information fusion collects theoretical and applied contributions of researchers working in different fields of applications and in mathematics. Some contributions have not been published until now, or only partially published and presented since the summer 2006 in international conferences, seminars, workshops and journals. Several chapters include figures in color which can be seen from the free electronic copy of this volume available at <http://www.gallup.unm.edu/~smarandache/DSmT-book3.pdf> or upon request to editors or authors. Part 1 of this volume presents the current state-of-the-art on theoretical investigations while Part 2 presents new applications in defense, geosciences, remote sensing, medicine, etc. Some works in this book are at their preliminary stages, others are under progress, and some are at their final stages of development. We hope that this third volume on DSmT will bring help and suscite new ideas to researchers and engineers working in quantitative and qualitative information fusion under uncertainty. This third volume has about 760 pages, split into 25 chapters, from 41 contributors.

In the first part of this volume the readers will discover: the different fusion spaces where the DSmT can work (power-set, hyper-power set, or super-power set) depending on the model associated with the frame of the problem one wants to solve; new fusion rules such as the simple uniform or partial uniform redistribution rules, and more complex classes based on redistribution to subsets or complements including also the reliability of the sources; a new probabilistic transformation which outperforms the classical pignistic transformation in term of probabilistic information content; a DSm Field and Linear Algebra of Refined Labels (FLARL) that is able to deal exactly with qualitative masses if the labels are equidistant (if they are not equidistant, the FLARL operators can be still used, but the result will be approximate); the extension of quantitative fusion rules into qualitative fusion rules by simply replacing the numerical operations by corresponding qualitative operations thanks to FLARL; the extension of the proportional conflict redistribution rule no. 6 on continuous frames for combining densities of probabilities and thus keeping multiple modes in the resulting fusionned density; new sampling techniques based on referee functions for the fusion and also codes or pseudo-codes to implement some rules, etc.

More applications of DSMT have emerged in the past three years from the apparition of the second book of DSMT in summer 2006. Part 2 of this volume presents some of them done in target tracking, in satellite image fusion, in snow-avalanche risk assessment, in multi-biometric match score fusion, in assessment of an attribute information retrieved based on the sensor data or human originated information, in sensor management, in automatic goal allocation for a planetary rover, in computer-aided medical diagnosis, in multiple camera fusion for tracking objects on ground plane, in object identification, in fusion of Electronic Support Measures (ESM) allegiance reports, in map regenerating forest stands, in target type tracking, etc.

We want to thank all the contributors of this third volume for their research works and their interests in the development of DSMT. We are also grateful to other colleagues for encouraging us to edit this third volume, for sharing with us several ideas and for their questions and comments on DSMT through the years. We specially thank Dr. Albena Tchamova for her constant devotion and help in the preparation and in the peer-review of this volume. We thank Dr. Erik Blasch, 2007 President of the International Society of Information Fusion (www.isif.org.) for the Preface. We also thank Prof. Pierre Valin, 2006 ISIF President, for peer-reviewing the chapters of this book. Jean Dezert thanks Dr. Romain Kervarc, Dr. Christophe Peyret and Dr. Grégoire Mercier for helping him to overcome typesetting difficulties under \LaTeX during the preliminary stage of this book project. Florentin Smarandache is grateful to The University of New Mexico, U.S.A. that many times partially sponsored him to attend international conferences, workshops and seminars on Information Fusion and Jean Dezert is grateful to the Department of Information Modeling and Processing (DTIM) at the French Aerospace Lab (Office National d'Études et de Recherches Aérospatiales), Châtillon, France for encouraging him to carry on this research and for its financial support.

The Editors.

Preface

Each decade, there have been probabilistic and non-probabilistic reasoning advances that have spawned a new generation of processing techniques to support information fusion. Dezert-Smarandache Theory (DSmT) is the theory of the first decade of the 21st century. Dr. Jean Dezert and Dr. Florentin Smarandache have combined their efforts to advance the mathematical field of evidence theory popularized by Dempster-Shafer (DS). The DS method extended Bayesian theory to deal with conflicting and imprecise data, ignorance, and belief and plausibility relations. DSmT further generalizes the DS theory to include the hyper-power set over which (1) complex static and dynamic information fusion results are realized for large data conflicts, (2) the frame of discernment (set) is refined and beliefs redistributed, and (3) data is better understood over vagueness, imprecision, and large relative differences.

Throughout the last decade, Dr. Dezert and Dr. Smarandache have supported the decision-making community by providing solutions to information fusion technique limitations by developing the DSmT, providing seminars and tutorials, as well as producing a series of texts. The dedication of their efforts is demonstrated through the compilation of the on-line and freely available texts and exemplar code. The hard work and contribution is a serious commitment to organize their thoughts, teach the next generation of researchers, as well as provide valuable feedback to the authors and researchers throughout the world.

As this text is the third volume in the series on *Advances and Applications of DSmT for Information Fusion*, the broad range of applications shows the power of the DSmT technique to advance the state-of-the-art in many mathematical, business, and engineering fields. Volume 1 focused on defining the DSmT, providing comparisons between many fusion rules, and the hybrid DSm (DSmH) rule applied to tracking in clutter, data association, and distributed situation analysis. Volume 2 focused on the Proportional Conflict Redistribution (PCR) rules, Belief Conditioning Rules (BCR), and fusion of qualitative beliefs for applications in targeting and tracking. Volume 2 also provides many MATLABTM routines to implement the DSmT.

The completion of the third volume is quite exciting as it contains 25 chapters, from 41 contributors, detailing the DSMT applications over 700 pages. In the current installment of *DSMT Advances and Applications*, there is something for everyone in the field of Information Fusion. Dezert and Smarandache work with Frédéric Dambreville to present new *advances* for the Proportional Conflict Redistribution (PCR) rule for qualitative applications. Arnaud Martin and Xinde Li provide new developments in belief redistribution of subsets or complements (RSC) and imprecise labels, respectively. Milan Daniel provides new insights on Belief Conditioning Rules (BCR). For these various advances, examples are shown for applications in tracking that leverage contemporary techniques such as particle filtering.

Applications demonstrate the power of the DSMT framework. In this third Volume, DSMT is applied to the entire spectrum of the Information Fusion that would interest any reader in data, sensor, information, and mathematical fusion topics. Highlighted in Figure 1 are the contemporary issues that include the links between (1) data conditioning and information management, (2) combined situation and impact assessment, and (2) knowledge representation between machine processing and user coordination. Various applications leverage DSMT “Advances” listed above along with DSMT (hybrid), DSMT (Probabilistic), and DSMT theoretical insights. The third volume attacks these application issues of coordination between the “levels” of information fusion.

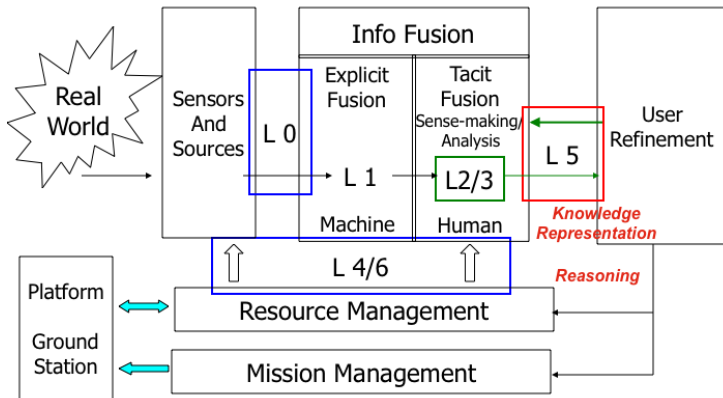

Figure 1: Data Fusion Information Group (DFIG) Model.

Briefly, here is a list of DSMT applications in Vol. 3 as categorized by the DFIG:

- Level 0 – *Data Assessment*: terrain analysis and data conditioning
- Level 1 – *Object Assessment*: simultaneous track and identification as well as image fusion
- Level 2 – *Situation Assessment*: association as well as event and entity determination
- Level 3 – *Impact Assessment*: geographic risk assessment
- Level 4 – *Process Refinement*: sensor management and performance evaluation
- Level 5 – *User Refinement*: decision and display
- Level 6 – *Mission Management*: attribute information for command and control

Many results are presented for different research areas including: robotics, biometric fingerprinting, satellite image fusion, and standard object tracking and identification. Without a doubt, DSMT is the *tool*¹ from this decade that advances information fusion for decision-making.

Erik Blasch, PhD, MBA
Air Force Research Laboratory
Dayton, OH
April 2009

1. E. Bossé, J. Roy, and S. Wark, *Concepts, Models, and Tools for Information Fusion*, Artech House, 2007.

Contents

Preamble	i
Preface	iii
Part I Advances on DSmT	1
Chapter 1 An introduction to DSmT	3
<i>by J. Dezert and F. Smarandache</i>	
1.1 Introduction	4
1.2 Foundations of DSmT	4
1.2.1 The power set, hyper-power set and super-power set . .	6
1.2.2 Notion of free and hybrid DS <i>m</i> models	18
1.2.3 Generalized belief functions	20
1.2.4 The classic DS <i>m</i> rule of combination	21
1.2.5 The hybrid DS <i>m</i> rule of combination	22
1.2.6 Examples of combination rules	24
1.2.7 Fusion of imprecise beliefs	29
1.3 Proportional Conflict Redistribution rule	33
1.3.1 PCR formulas	34
1.3.2 Examples	35
1.3.3 Zadeh's example	39
1.4 Uniform and partially uniform redistribution rules	41
1.5 RSC Fusion rules	43
1.6 The generalized pignistic transformation (GPT)	45
1.6.1 The classical pignistic transformation	45
1.6.2 Notion of DS <i>m</i> cardinality	46
1.6.3 The Generalized Pignistic Transformation	47
1.7 The DS <i>m</i> P transformation	48
1.7.1 The Probabilistic Information Content (PIC)	49
1.7.2 The DS <i>m</i> P formula	50
1.7.3 Examples for DS <i>m</i> P and BetP	51
1.8 Fusion of qualitative beliefs	54
1.8.1 Qualitative Operators	54
1.8.2 Qualitative Belief Assignment	55
1.8.3 Qualitative Conjunctive Rule	56

1.8.4	Qualitative DS _m Classic rule	56
1.8.5	Qualitative hybrid DS _m rule	57
1.8.6	Qualitative PCR5 rule (qPCR5)	58
1.8.7	A simple example of qualitative fusion of qba's	58
1.8.8	A simple example for the qDS _m P transformation	60
1.9	Belief Conditioning Rules	62
1.9.1	Shafer's Conditioning Rule (SCR)	62
1.9.2	Hyper-Power Set Decomposition (HPSD)	63
1.9.3	Quantitative belief conditioning rules (BCR)	63
1.9.4	Qualitative belief conditioning rules	66
1.10	Conclusion	68
1.11	References	68

Chapter 2 DS_m field and linear algebra of refined labels **75**

by F. Smarandache, J. Dezert and X. Li

2.1	Introduction	76
2.2	DS _m field and linear algebra of refined labels	77
2.2.1	Qualitative operators on DS _m -LARL	77
2.2.2	The DS _m field of refined labels	79
2.3	New operators	81
2.4	Working with 2-tuple labels	83
2.5	Working with interval of labels	83
2.6	Concluding remark	83
2.7	References	84

Chapter 3 Transformations of belief masses into subjective probabilities **85**

by J. Dezert and F. Smarandache

3.1	Introduction	86
3.2	Classical and generalized pignistic probabilities	86
3.2.1	Classical pignistic probability	86
3.2.2	Generalized pignistic probability	87
3.3	Sudano's probabilities	87
3.4	Cuzzolin's intersection probability	89
3.4.1	Definition	89
3.4.2	Remarks	90
3.5	A new generalized pignistic transformation	90
3.5.1	The DS _m P formula	91
3.5.2	Advantages of DS _m P	92
3.6	PIC metric for the evaluation of the transformations	95

3.6.1	Shannon entropy	95
3.6.2	The probabilistic information content	96
3.7	Examples and comparisons on a 2D frame	96
3.7.1	Example 1: Shafer's model with a general source	96
3.7.2	Example 2: Shafer's model with the ignorant source	100
3.7.3	Example 3: Shafer's model with a probabilistic source	102
3.7.4	Example 4: Shafer's model with a non-Bayesian mass	103
3.7.5	Example 5: Free DS _m model	103
3.8	Examples on a 3D frame	111
3.8.1	Example 6: Shafer's model with a non-Bayesian mass	111
3.8.2	Example 7: Shafer's model with another non-Bayesian mass	114
3.8.3	Example 8: Shafer's model with yet another non-Bayesian mass	118
3.8.4	Example 9: Shafer's model with yet another non-Bayesian mass	118
3.8.5	Example 10: Hybrid DS _m model	119
3.8.6	Example 11: Free DS _m model	127
3.9	Extension of DS _m P for qualitative belief	131
3.10	Example for qualitative DS _m P	133
3.11	Conclusions	134
3.12	References	134

Chapter 4 Probabilistic PCR6 fusion rule **137**

by F. Dambreville, F. Celeste, J. Dezert and F. Smarandache

4.1	Introduction	138
4.2	PCR6 formula for probabilities	139
4.2.1	Definition and justification of PCR6	139
4.2.2	Reformulation of PCR6	141
4.2.3	Definition of probabilistic PCR6 (p-PCR6)	142
4.2.4	Reformulation of p-PCR6	144
4.2.5	Extension of p-PCR6 on continuous propositions	144
4.2.6	Sampling method	146
4.3	Bayes versus p-PCR6	147
4.3.1	Bayesian fusion rule	147
4.3.2	Fusion based on p-PCR6 for Gaussian distributions	150
4.4	A distributed sequential filtering application	151
4.4.1	Whitened p-PCR6 rule	151
4.4.2	Theoretical setting	151
4.4.3	Scenario and tests	153

4.5	Conclusions	159
4.6	References	160

Chapter 5 A class of fusion rules based on the belief redistribution to subsets or complements **161**

by F. Smarandache, A. Martin and J. Dezert

5.1	Introduction	162
5.2	Fusion rules based on RSC	162
5.2.1	RSC rule no 1	163
5.2.2	RSC rule no 2	163
5.2.3	RSC rule no 3	164
5.2.4	RSC rule no 4	164
5.2.5	RSC rule no 5	165
5.2.6	RSC rule no 6	165
5.2.7	RSC rule no 7	166
5.2.8	RSC rule no 8	166
5.2.9	Remarks	167
5.3	A new class of RSC fusion rules	167
5.4	A general formulation	168
5.4.1	A general formula for the class of RSC fusion rules . . .	169
5.4.2	Example	170
5.5	A general formulation including reliability	172
5.5.1	Examples	172
5.6	A new rule including reliability	176
5.6.1	The fusion of two experts including their reliability . . .	176
5.6.2	Some examples	179
5.6.3	The fusion of $s \geq 2$ experts including their reliability . .	180
5.7	Conclusions	182
5.8	References	182

Chapter 6 Definition of evidence fusion rules based on referee functions **185**

by F. Dambreville

6.1	Introduction	186
6.2	Belief fusion	187
6.2.1	Lattices	187
6.2.2	Belief functions	189
6.2.3	Fusion rules	189
6.2.4	Disjunctive rule	190
6.3	Referee function and fusion rules	191

6.3.1	Referee function	191
6.3.2	Properties	192
6.3.3	Sampling process	195
6.3.4	Algorithmic definition of fusion rules	196
6.4	Example of referee functions	197
6.4.1	Dempster-Shafer rule	197
6.4.2	Disjunctive rule	197
6.4.3	Dubois & Prade rule	198
6.4.4	Averaging rule	199
6.4.5	PCR6 rule	200
6.4.6	Non conjunctive rejection	201
6.4.7	Any rule?	202
6.5	A new rule: PCR \ddagger	203
6.5.1	Limitations of PCR6	203
6.5.2	Algorithm	203
6.5.3	Referee function	205
6.5.4	Variants of PCR \ddagger	206
6.6	Numerical examples	208
6.6.1	Convergence	208
6.6.2	Comparative tests	211
6.7	Conclusion	213
6.8	References	214

**Chapter 7 Implementing general belief function framework with
a practical codification for low complexity 217**

by A. Martin

7.1	Introduction	218
7.2	Short background on theory of belief functions	219
7.3	A general belief function framework	221
7.3.1	A practical codification	221
7.3.2	Adding constraints	224
7.3.3	Codification of the focal elements	224
7.3.4	Combination	225
7.3.5	Decision	226
7.3.6	Generation of D_r^\ominus	230
7.3.7	Decoding	231
7.4	Concluding remarks	232
7.5	MATLAB TM codes	233
7.5.1	Codification	238
7.5.2	Combination	243

7.5.3	Decision	250
7.5.4	Decoding and generation of D_r^\ominus	264
7.6	Acknowledgments	271
7.7	References	271

Chapter 8 Fusion of qualitative information using imprecise 2-tuple labels **275**

by X. Li, X. Huang, J. Dezert, F. Smarandache and L. Duan

8.1	Introduction	276
8.2	DSmT for the fusion of beliefs	278
8.2.1	Basic belief mass	278
8.2.2	Fusion of quantitative beliefs	278
8.3	Linguistic models of qualitative beliefs	280
8.3.1	The 1-tuple linguistic model	280
8.3.2	The 1-tuple linguistic enriched model	281
8.3.3	The precise 2-tuple linguistic model	282
8.3.4	The imprecise 2-tuple linguistic model	284
8.4	Fusion of qualitative beliefs	287
8.4.1	Fusion of precise qualitative beliefs	287
8.4.2	Fusion of imprecise qualitative beliefs	289
8.5	Examples of fusion of qualitative beliefs	291
8.5.1	Example of fusion of precise qualitative beliefs	292
8.5.2	Example of fusion of imprecise qualitative beliefs	294
8.6	Conclusion	295
8.7	References	296

Chapter 9 Non-numeric labels and constrained focal elements **299**

by C. Osswald and A. Martin

9.1	Introduction	300
9.2	Theories of belief functions	301
9.2.1	Basic belief assignments	301
9.2.2	Decision-aid functions	301
9.2.3	Usual combination operators	302
9.2.4	Enough operators available?	303
9.2.5	Operators for the usual bba operations	304
9.3	Extending the definition of labels	305
9.3.1	Discrete and totally ordered labels	306
9.3.2	Max-Min algebra	306
9.3.3	Auto-indenting labels	307
9.3.4	Soft auto-indenting labels	308

9.3.5	Example	308
9.3.6	Lattice Labels	309
9.3.7	Interval masses	310
9.4	Constraints over the focal elements	311
9.4.1	Ordered set	311
9.4.2	Intervals of \mathbb{R}^N	312
9.4.3	Partitions	313
9.4.4	Hierarchies	314
9.4.5	Binary clustering systems	316
9.4.6	Semantic assertions	316
9.5	Conclusion	317
9.6	References	317
9.7	Appendix: algebras	319
9.7.1	Orders and partial orders	319
9.7.2	Lattice	320
9.7.3	Ring and semi-ring	320
9.7.4	Field	321
9.7.5	Vector space	321
9.7.6	Algebra over a field	321

Chapter 10 Analysis of DS_m belief conditioning rules and extension of their applicability **323**

by M. Daniel

10.1	Introduction	324
10.2	Brief preliminaries	324
10.3	Belief conditioning rule BCR1	325
10.4	Belief conditioning rules BCR2–BCR11	326
10.4.1	Belief conditioning rules BCR2–BCR6	326
10.4.2	Belief conditioning rules BCR7–BCR11	329
10.5	Belief conditioning rules BCR12–BCR31	329
10.5.1	Belief conditioning rules BCR12–BCR16	329
10.5.2	Belief conditioning rules BCR17–BCR21	331
10.5.3	The remaining belief conditioning rules	331
10.6	Comparison of BCRs with the classic rules	332
10.6.1	BCR1	332
10.6.2	BCR2–BCR6	332
10.6.3	BCR7–BCR11	332
10.6.4	BCR12–BCR16	332
10.6.5	BCR17–BCR21	333
10.6.6	BCR22–BCR31	333

10.6.7	Comparison of definition domains	333
10.7	Extension of applicability of BCRs	334
10.7.1	Extension of applicability in general DS _m models	334
10.7.2	Extension of applicability in the free DS _m model	337
10.7.3	Extended definition of BCR12	337
10.8	Summary of comparison	338
10.8.1	Summary of coincidence of BCRs with DRC	338
10.8.2	Comparison of BCR1, BCR12 and BCR17 with classic rules of conditioning	339
10.9	Conclusions	340
10.10	References	340
10.11	Appendix: comments to implementation	342

Part II Applications of DS_mT **345**

Chapter 11 Attribute information evaluation in C&C systems **347**

by K. Krenc and A. Kawalec

11.1	Introduction	348
11.2	Assessing information	348
11.2.1	Evaluation factors	348
11.2.2	Not only distance matters	349
11.3	The attribute information evaluation model	350
11.3.1	The types of sensors	351
11.3.2	Classifier	354
11.3.3	Evaluator	354
11.4	Numerical experiments	359
11.4.1	Assumptions	359
11.4.2	Settings and other model information	360
11.4.3	Results	361
11.4.4	Discussion	367
11.5	Latest concepts	368
11.6	Conclusion	370
11.7	References	370

Chapter 12 Utilizing classifier conflict for sensor management and user interaction **371**

by W.L. van Norden and C.M. Jonker

12.1	Introduction	372
12.2	Combination rules	372

12.3	Classification and sensor management	373
12.3.1	Sensor management	374
12.3.2	Modeling the classification space	374
12.3.3	Intersection between elements	375
12.3.4	Interaction with the user	376
12.4	Conflict	377
12.4.1	Tracking conflict in PCR6	377
12.4.2	Redistribution of remaining conflict	379
12.5	Utilizing the conflict in sensor management	382
12.5.1	Conflict per source	382
12.5.2	Conflict per hypotheses	384
12.6	Conclusions	384
12.7	References	384

Chapter 13 Automatic goal allocation for a planetary rover with DSMT **387**

by M. Vasile and M. Ceriotti

13.1	Introduction	388
13.2	Plausible and paradoxical reasoning	390
13.3	Modeling interest for a planetary rover	391
13.3.1	Modeling of sensor information	392
13.3.2	Definition of the Interest Map	392
13.4	Some results with DSMT	397
13.4.1	DST applied the generation of the Interest Map	403
13.5	Final remarks	409
13.6	Acknowledgments	409
13.7	References	409

Chapter 14 Performance evaluation of a tracking algorithm including attribute data **411**

by J. Dezert, A. Tchamova, L. Bojilov and P. Konstantinova

14.1	Introduction	412
14.2	Problem formulation	412
14.2.1	Kinematic likelihood ratios for GDA	413
14.2.2	Attribute likelihood ratios for GDA	414
14.3	Scenario of simulations and results	415
14.3.1	Scenario of simulations	415
14.3.2	Numerical results	416
14.4	Conclusions	421
14.5	References	421

Chapter 15 New fusion rules for solving Blackman’s association problem **425**

by A. Tchamova, J. Dezert and F. Smarandache

- 15.1 On Blackman’s association problem 426
 - 15.1.1 Blackman’s association problem 427
- 15.2 State-of-the-art to find a correct solution 428
- 15.3 Basics of Dezert-Smarandache theory 428
 - 15.3.1 Free DSm model 429
 - 15.3.2 Hybrid DSm model 429
 - 15.3.3 Hyper-power set and classical DSm fusion rule 429
- 15.4 Proportional conflict redistribution rule no.5 430
- 15.5 T-conorm/T-norm based combination rules 431
- 15.6 Measure of estimation based on generalized pignistic probabilities 433
- 15.7 Simulation results 434
- 15.8 Conclusions 435
- 15.9 References 435

Chapter 16 Target type tracking with DSmP **437**

by J. Dezert, F. Smarandache, A. Tchamova and P. Konstantinova

- 16.1 Introduction 438
- 16.2 A short introduction of DSmT 438
- 16.3 DSmH and PCR5 combination rules 440
 - 16.3.1 DSmH combination rule 440
 - 16.3.2 PCR5 combination rule 440
 - 16.3.3 How to choose between PCR5 and DSmH 441
- 16.4 Probabilistic belief transformations 442
 - 16.4.1 Classical and generalized pignistic probabilities 442
 - 16.4.2 A new generalized pignistic transformation 443
- 16.5 The target type tracking problem 445
- 16.6 Simulations results 447
 - 16.6.1 Results based on DSmH fusion 448
 - 16.6.2 Results based on PCR5 fusion 450
 - 16.6.3 Results based on Dempster-Shafer rule 450
- 16.7 Conclusions 453
- 16.8 References 453

Chapter 17 Framework for biometric match score fusion using statistical and belief models **455**

by M. Vatsa, R. Singh and A. Noore

- 17.1 Introduction 456

17.2	Overview of belief function theory based fusion algorithms . . .	457
17.3	Framework for biometric match score fusion	459
17.3.1	Match score fusion	460
17.3.2	Statistical classification	461
17.4	Algorithms and databases used for evaluation	462
17.4.1	Face verification algorithms	462
17.4.2	Fingerprint verification algorithm	462
17.4.3	Biometric databases used for evaluation	463
17.5	Experimental evaluation	463
17.6	Unification of fusion rules	465
17.7	Conclusion	466
17.8	Acknowledgments	467
17.9	References	467

**Chapter 18 Multimodal information retrieval based on DS_mT.
Application to computer-aided medical diagnosis 471**

by G. Quellec, M. Lamard, G. Cazuguel, B. Cochener and C. Roux

18.1	Introduction	472
18.2	Objectives	473
18.3	Shafer's model for information retrieval	473
18.3.1	Image processing	474
18.3.2	Estimation of the degree of match for a feature F_i . . .	475
18.3.3	Designing the frame of discernment	475
18.3.4	Defining the belief mass functions	476
18.3.5	Fusing the belief mass functions	476
18.3.6	Identifying the most similar cases	477
18.3.7	Managing missing values	477
18.4	Hybrid DS _m model for information retrieval	478
18.4.1	Designing the frame of discernment	478
18.4.2	Defining the belief mass functions	479
18.4.3	Fusing the belief mass functions	480
18.4.4	Identifying the most similar cases	483
18.4.5	Managing missing values	483
18.5	Application to computer-aided medical diagnosis	483
18.5.1	Diabetic retinopathy database (DRD)	483
18.5.2	Digital database for screening mammography	487
18.5.3	Objective of the computer-aided diagnosis system	488
18.5.4	Features of the patient records	488
18.5.5	Training and evaluation datasets	488
18.5.6	Results	488

18.6	Discussion and conclusion	491
18.7	References	492
18.8	Appendix: PCR rule with polynomial complexity	495
18.8.1	Algorithm for the conjunctive rule	496
18.8.2	Proposed PCR rule of combination	499
18.8.3	Conclusion	502
Chapter 19 Fusion of ESM allegiance reports using DS_mT		503
<i>by P. Djiknavorian, P. Valin and D. Grenier</i>		
19.1	Background	504
19.1.1	An interpretation of STANAG 1241	504
19.1.2	Another interpretation of STANAG 1241	505
19.2	Dezert-Smarandache theory	506
19.2.1	Formulae for DST and DS _m T	506
19.2.2	A typical simulation scenario	508
19.3	Results for the simulated scenario	509
19.3.1	DST results	510
19.3.2	DS _m H results	511
19.3.3	PCR5 results	511
19.3.4	Decision-making threshold	512
19.4	Monte-Carlo results	513
19.4.1	DST results	513
19.4.2	DS _m H results	514
19.4.3	PCR5 results	514
19.4.4	Effect of varying the ESM parameters	514
19.5	Conclusions	517
19.6	References	518
Chapter 20 Object identification using T-conorm/norm fusion rule		519
<i>by A. Tchamova, J. Dezert and F. Smarandache</i>		
20.1	Introduction	520
20.2	Approach description	520
20.3	Simulation scenario and results	522
20.4	Conclusions	526
20.5	References	526

Chapter 21 Map regenerating forest stands based on DST and DSMT combination rules **529**

by B. Mora, R.A. Fournier and S. Foucher

21.1	Introduction	530
21.2	Reasoning theories	530
21.2.1	Dempster-Shafer theory (DST)	530
21.2.2	Dezert-Smarandache theory (DSMT)	532
21.2.3	Decision rule	532
21.3	Information used in this work	532
21.3.1	Study area	532
21.3.2	Satellite imagery	533
21.3.3	Sample plots	533
21.3.4	Drainage and surface deposit	534
21.4	Methods	535
21.4.1	Reference methods	536
21.4.2	Data fusion methods	536
21.5	Results and their interpretation	540
21.5.1	Results based on the maximum likelihood algorithm	540
21.5.2	Results based on the fusion in DST framework	540
21.5.3	Results based on the fusion in DSMT framework	542
21.6	Sensitivity analysis	542
21.6.1	Mass functions of the ancillary sources	542
21.6.2	Discounting coefficient	542
21.7	Discussion	544
21.8	Conclusion	545
21.9	References	546

Chapter 22 Satellite image fusion using Dezert-Smarandache theory **549**

by A. Bouakache, A. Belhadj-Aissa and G.Mercier

22.1	Introduction	550
22.2	Dezert Smarandache theory basis	551
22.2.1	Mass functions	551
22.2.2	Decision Rule	552
22.3	Implementation of the free and hybrid models	552
22.3.1	Implementation of the free model	552
22.3.2	Implementation of the hybrid model	554
22.4	Application	556
22.4.1	Site of study and data used	556
22.4.2	Fusion based on the free model	557

22.4.3	Fusion based on the hybrid model	560
22.4.4	Comparison between the free and hybrid models	562
22.5	Conclusion	562
22.6	References	563

Chapter 23 Information fusion for natural hazards in mountains 565

by J.-M. Tacnet, M. Batton-Hubert and J. Dezert

23.1	Introduction	566
23.1.1	Natural hazards in mountains	566
23.1.2	Experts are expected to manage and integrate the overall uncertainty	568
23.1.3	A more realistic description of the expertise process	570
23.2	Backgrounds on MCDA and evidential reasoning	572
23.2.1	Multi-criteria decision analysis	572
23.2.2	Evidential reasoning (ER)	579
23.2.3	Mixing MCDA and evidential reasoning	582
23.3	ER-MCDA methodology	585
23.3.1	Possibility and Evidence Theory: why and what for?	586
23.3.2	AHP and ER within uncertain and complex context	587
23.3.3	Step 1: Problem modeling	591
23.3.4	Step 2: Mapping quantitative criterion into a common frame	596
23.3.5	Step 3: Mapping qualitative criterion into a common frame	603
23.3.6	Decision-making	617
23.4	Applications: Sensitivity index in a multi-experts environment	619
23.4.1	Sensitivity index in a multi-experts environment	619
23.5	Discussion	643
23.5.1	Mixing uncertainty, imprecision, importance and traceability	643
23.5.2	Advantages and lacks of the ER-MCDA framework	644
23.5.3	The question of the validation	645
23.5.4	Towards an improved ER-MCDA framework	647
23.6	Conclusion	648
23.7	Acknowledgments	650
23.8	References	651

Chapter 24 Improvement of multiple ground targets tracking with fusion of identification attributes 661

by B. Pannetier and J. Dezert

24.1	Introduction	662
------	------------------------	-----

24.2	Motion model	663
24.2.1	Introduction	663
24.2.2	GIS description	663
24.2.3	Target state under constraint	664
24.3	Measurement model	667
24.3.1	GMTI model	667
24.3.2	IMINT model	669
24.3.3	Ontologic model	670
24.4	VS-IMM with road constraints (VS-IMMC)	670
24.4.1	Track definitions and notations	670
24.4.2	IMM with only one road segment constraint	671
24.4.3	Variation of the set of constrained motion models	673
24.4.4	VS-IMMC within the SB-MHT	674
24.4.5	OOSM algorithm	676
24.5	Target type tracking	677
24.5.1	PCR5 combination rule	677
24.5.2	Principle of the target type tracker	678
24.5.3	Working with multiple sensors	679
24.5.4	Data attributes in the VS IMMC	679
24.6	Simulations and results	680
24.6.1	Scenario description	680
24.6.2	Filter parameters	684
24.6.3	Results	685
24.7	Conclusion	688
24.8	References	689

Chapter 25 Multiple cameras fusion based on DSMT for tracking objects on ground plane **691**

by E. Garcia and L. Altamirano

25.1	Introduction	692
25.2	DSM hybrid model	693
25.3	Multiple cameras fusion	694
25.4	Results and discussion	697
25.4.1	Probabilistic fusion module	698
25.5	Conclusions	703
25.6	References	703

Biographies of contributors **705**

List of Figures **720**

List of Tables

727

Index

731

Part I

Advances on DSMT

Chapter 1

An introduction to DS_mT

Jean Dezert

French Aerospace Research Lab.,
ONERA/DTIM/SIF,
29 Avenue de la Division Leclerc,
92320 Châtillon, France.
jean.dezert@onera.fr

Florentin Smarandache

Chair of Math. & Sciences Dept.,
University of New Mexico,
200 College Road,
Gallup, NM 87301, U.S.A.
smarand@unm.edu

Abstract: *The management and combination of uncertain, imprecise, fuzzy and even paradoxical or highly conflicting sources of information has always been, and still remains today, of primal importance for the development of reliable modern information systems involving artificial reasoning. In this introduction, we present a survey of our recent theory of plausible and paradoxical reasoning, known as Dezert-Smarandache Theory (DS_mT), developed for dealing with imprecise, uncertain and conflicting sources of information. We focus our presentation on the foundations of DS_mT and on its most important rules of combination, rather than on browsing specific applications of DS_mT available in literature. Several simple examples are given throughout this presentation to show the efficiency and the generality of this new theory.*

1.1 Introduction

The management and combination of uncertain, imprecise, fuzzy and even paradoxical or highly conflicting sources of information has always been, and still remains today, of primal importance for the development of reliable modern information systems involving artificial reasoning. The combination (fusion) of information arises in many fields of applications nowadays (especially in defense, medicine, finance, geo-science, economy, etc). When several sensors, observers or experts have to be combined together to solve a problem, or if one wants to update our current estimation of solutions for a given problem with some new information available, we need powerful and solid mathematical tools for the fusion, specially when the information one has to deal with is imprecise and uncertain. In this chapter, we present a survey of our recent theory of plausible and paradoxical reasoning, known as Dezert-Smarandache Theory (DSMT) in the literature, developed for dealing with imprecise, uncertain and conflicting sources of information. Recent publications have shown the interest and the ability of DSMT to solve problems where other approaches fail, especially when conflict between sources becomes high. We focus this presentation rather on the foundations of DSMT, and on the main important rules of combination, than on browsing specific applications of DSMT available in literature. Successful applications of DSMT in target tracking, satellite surveillance, situation analysis, robotics, medicine, biometrics, etc, can be found in Parts II of this volume, in Parts II of [32, 36] and on the world wide web [38]. Several simple examples are given in this chapter to show the efficiency and the generality of DSMT.

1.2 Foundations of DSMT

The development of DSMT (Dezert-Smarandache Theory of plausible and paradoxical reasoning [9, 32]) arises from the necessity to overcome the inherent limitations of DST (Dempster-Shafer Theory [25]) which are closely related with the acceptance of Shafer's model for the fusion problem under consideration (i.e. the frame of discernment Θ is implicitly defined as a finite set of exhaustive and exclusive hypotheses θ_i , $i = 1, \dots, n$ since the masses of belief are defined only on the power set of Θ - see section 1.2.1 for details), the third middle excluded principle (i.e. the existence of the complement for any elements/propositions belonging to the power set of Θ), and the acceptance of Dempster's rule of combination (involving normalization) as the framework for the combination of independent sources of evidence. Discussions on limitations of DST and presentation of some alternative rules to Dempster's rule of com-

combination can be found in [12, 16, 18–20, 22, 24, 32, 40, 48, 51, 52, 55–58] and therefore they will be not reported in details in this introduction. We argue that these three fundamental conditions of DST can be removed and another new mathematical approach for combination of evidence is possible. This is the purpose of DS_mT.

The basis of DS_mT is the refutation of the principle of the third excluded middle and Shafer’s model, since for a wide class of fusion problems the intrinsic nature of hypotheses can be only vague and imprecise in such a way that precise refinement is just impossible to obtain in reality so that the exclusive elements θ_i cannot be properly identified and precisely separated. Many problems involving fuzzy continuous and relative concepts described in natural language and having no absolute interpretation like tallness/smallness, pleasure/pain, cold/hot, Sorites paradoxes, etc, enter in this category. DS_mT starts with the notion of free DS_m model, denoted $\mathcal{M}^f(\Theta)$, and considers Θ only as a frame of exhaustive elements θ_i , $i = 1, \dots, n$ which can potentially overlap. This model is free because no other assumption is done on the hypotheses, but the weak exhaustivity constraint which can always be satisfied according the closure principle explained in [32]. No other constraint is involved in the free DS_m model. When the free DS_m model holds, the commutative and associative classical DS_m rule of combination, denoted DS_mC, corresponding to the conjunctive consensus defined on the free Dedekind’s lattice is performed.

Depending on the nature of the elements of the fusion problem under consideration, it can happen that the free model does not fit with the reality because some subsets of Θ can contain elements known to be truly exclusive and even possibly truly non existing at a given time (specially in dynamic fusion problems where the frame Θ changes with time with the revision of the knowledge available). These integrity constraints are introduced in the free DS_m model $\mathcal{M}^f(\Theta)$ in order to fit with the reality. This allows to construct a hybrid DS_m model $\mathcal{M}(\Theta)$ on which the combination will be efficiently performed. Shafer’s model, denoted $\mathcal{M}^0(\Theta)$, corresponds to a very specific hybrid DS_m model including all possible exclusivity constraints. DST has been developed for working with $\mathcal{M}^0(\Theta)$ whereas DS_mT was proposed for working with any hybrid models (including Shafer’s and free DS_m models), to manage as efficiently and precisely as possible imprecise, uncertain and potentially highly conflicting sources of evidence while keeping in mind the possible dynamicity of the frame. The foundations of DS_mT are therefore totally different from those of all existing approaches managing uncertainties, imprecisions and conflicts. DS_mT provides a new interesting way to attack the information fusion problematic with a general framework in order to cover a wide variety of problems.

DS_mT refutes also the idea that sources of evidence provide their beliefs with the same absolute interpretation of elements of the same frame Θ and the conflict between sources arises not only because of the possible unreliability of sources, but also because of possible different and relative interpretations of Θ , e.g. what is considered as good for somebody can be considered as bad for somebody else. There is some unavoidable subjectivity in the belief assignments provided by the sources of evidence, otherwise it would mean that all bodies of evidence have a same objective and universal interpretation (or measure) of the phenomena under consideration, which unfortunately rarely occurs in reality, but when basic belief assignments (bba's) are based on some objective probabilities transformations. But in this last case, probability theory can handle properly and efficiently the information, and DST, as well as DS_mT, becomes useless. If we now get out of the probabilistic background argumentation for the construction of bba, we claim that in most of cases, the sources of evidence provide their beliefs about elements of the frame of the fusion problem only based on their own limited knowledge and experience without reference to the (inaccessible) absolute truth of the space of possibilities.

1.2.1 The power set, hyper-power set and super-power set

In DS_mT, we take very care of the model associated with the set Θ of hypotheses where the solution of the problem is assumed to belong to. In particular, the three main sets (power set, hyper-power set and super-power set) can be used depending on their ability to fit adequately with the nature of hypotheses. In the following, we assume that $\Theta = \{\theta_1, \dots, \theta_n\}$ is a finite set (called frame) of n exhaustive elements¹. If $\Theta = \{\theta_1, \dots, \theta_n\}$ is a priori not closed (Θ is said to be an open world/frame), one can always include in it a closure element, say θ_{n+1} in such way that we can work with a new closed world/frame $\{\theta_1, \dots, \theta_n, \theta_{n+1}\}$. So without loss of generality, we will always assume that we work in a closed world by considering the frame Θ as a finite set of exhaustive elements. Before introducing the power set, the hyper-power set and the super-power set it is necessary to recall that subsets are regarded as propositions in Dempster-Shafer Theory (see Chapter 2 of [25]) and we adopt the same approach in DS_mT.

¹We do not assume here that elements θ_i are necessary exclusive, unless specified. There is no restriction on θ_i but the exhaustivity.

- **Subsets as propositions:** Glenn Shafer in pages 35–37 of [25] considers the subsets as propositions in the case we are concerned with the true value of some quantity θ taking its possible values in Θ . Then the propositions $\mathcal{P}_\theta(A)$ of interest are those of the form²:

$$\mathcal{P}_\theta(A) \triangleq \text{The true value of } \theta \text{ is in a subset } A \text{ of } \Theta.$$

Any proposition $\mathcal{P}_\theta(A)$ is thus in one-to-one correspondence with the subset A of Θ . Such correspondence is very useful since it translates the logical notions of conjunction \wedge , disjunction \vee , implication \Rightarrow and negation \neg into the set-theoretic notions of intersection \cap , union \cup , inclusion \subset and complementation $c(\cdot)$. Indeed, if $\mathcal{P}_\theta(A)$ and $\mathcal{P}_\theta(B)$ are two propositions corresponding to subsets A and B of Θ , then the conjunction $\mathcal{P}_\theta(A) \wedge \mathcal{P}_\theta(B)$ corresponds to the intersection $A \cap B$ and the disjunction $\mathcal{P}_\theta(A) \vee \mathcal{P}_\theta(B)$ corresponds to the union $A \cup B$. A is a subset of B if and only if $\mathcal{P}_\theta(A) \Rightarrow \mathcal{P}_\theta(B)$ and A is the set-theoretic complement of B with respect to Θ (written $A = c_\Theta(B)$) if and only if $\mathcal{P}_\theta(A) = \neg\mathcal{P}_\theta(B)$. In other words, the following equivalences are then used between the operations on the subsets and on the propositions:

Operations	Subsets	Propositions
Intersection/conjunction	$A \cap B$	$\mathcal{P}_\theta(A) \wedge \mathcal{P}_\theta(B)$
Union/disjunction	$A \cup B$	$\mathcal{P}_\theta(A) \vee \mathcal{P}_\theta(B)$
Inclusion/implication	$A \subset B$	$\mathcal{P}_\theta(A) \Rightarrow \mathcal{P}_\theta(B)$
Complementation/negation	$A = c_\Theta(B)$	$\mathcal{P}_\theta(A) = \neg\mathcal{P}_\theta(B)$

Table 1.1: Correspondence between operations on subsets and on propositions.

- **Canonical form of a proposition:** In DS_mT we consider all propositions/sets in a canonical form. We take the disjunctive normal form, which is a disjunction of conjunctions, and it is unique in Boolean algebra and simplest. For example, $X = A \cap B \cap (A \cup B \cup C)$ it is not in a canonical form, but we simplify the formula and $X = A \cap B$ is in a canonical form.

- **The power set:** $2^\Theta \triangleq (\Theta, \cup)$

Aside Dempster's rule of combination, the power set is one of the corner stones of Dempster-Shafer Theory (DST) since the basic belief assignments to combine

²We use the symbol \triangleq to mean *equals by definition*; the right-hand side of the equation is the definition of the left-hand side.

are defined on the power set of the frame Θ . In mathematics, given a set Θ , the power set of Θ , written 2^Θ , is the set of all subsets of Θ . In Zermelo–Fraenkel set theory with the axiom of choice (ZFC), the existence of the power set of any set is postulated by the axiom of power set. In other words, Θ generates the power set 2^Θ with the \cup (union) operator only. More precisely, the power set 2^Θ is defined as the set of all composite propositions/subsets built from elements of Θ with \cup operator such that:

1. $\emptyset, \theta_1, \dots, \theta_n \in 2^\Theta$.
2. If $A, B \in 2^\Theta$, then $A \cup B \in 2^\Theta$.
3. No other elements belong to 2^Θ , except those obtained by using rules 1 and 2.

Examples of power sets:

- If $\Theta = \{\theta_1, \theta_2\}$, then $2^{\Theta=\{\theta_1, \theta_2\}} = \{\{\emptyset\}, \{\theta_1\}, \{\theta_2\}, \{\theta_1, \theta_2\}\}$ which is commonly written as $2^\Theta = \{\emptyset, \theta_1, \theta_2, \theta_1 \cup \theta_2\}$.
- Let's consider two frames $\Theta_1 = \{A, B\}$ and $\Theta_2 = \{X, Y\}$, then their power sets are respectively $2^{\Theta_1=\{A, B\}} = \{\emptyset, A, B, A \cup B\}$ and $2^{\Theta_2=\{X, Y\}} = \{\emptyset, X, Y, X \cup Y\}$. Let's consider a refined frame $\Theta^{ref} = \{\theta_1, \theta_2, \theta_3, \theta_4\}$. The granules $\theta_i, i = 1, \dots, 4$ are not necessarily exhaustive, nor exclusive. If A and B are expressed more precisely in function of the granules θ_i by example as $A \triangleq \{\theta_1, \theta_2, \theta_3\} \equiv \theta_1 \cup \theta_2 \cup \theta_3$ and $B \triangleq \{\theta_2, \theta_4\} \equiv \theta_2 \cup \theta_4$ then the power sets can be expressed from the granules θ_i as follows:

$$\begin{aligned}
 2^{\Theta_1=\{A, B\}} &= \{\emptyset, A, B, A \cup B\} \\
 &= \{\emptyset, \underbrace{\{\theta_1, \theta_2, \theta_3\}}_A, \underbrace{\{\theta_2, \theta_4\}}_B, \underbrace{\{\{\theta_1, \theta_2, \theta_3\}, \{\theta_2, \theta_4\}\}}_{A \cup B}\} \\
 &= \{\emptyset, \theta_1 \cup \theta_2 \cup \theta_3, \theta_2 \cup \theta_4, \theta_1 \cup \theta_2 \cup \theta_3 \cup \theta_4\}
 \end{aligned}$$

If X and Y are expressed more precisely in function of the finer granules θ_i by example as $X \triangleq \{\theta_1\} \equiv \theta_1$ and $Y \triangleq \{\theta_2, \theta_3, \theta_4\} \equiv \theta_2 \cup \theta_3 \cup \theta_4$ then:

$$\begin{aligned}
 2^{\Theta_2=\{X, Y\}} &= \{\emptyset, X, Y, X \cup Y\} \\
 &= \{\emptyset, \underbrace{\{\theta_1\}}_X, \underbrace{\{\theta_2, \theta_3, \theta_4\}}_Y, \underbrace{\{\{\theta_1\}, \{\theta_2, \theta_3, \theta_4\}\}}_{X \cup Y}\} \\
 &= \{\emptyset, \theta_1, \theta_2 \cup \theta_3 \cup \theta_4, \theta_1 \cup \theta_2 \cup \theta_3 \cup \theta_4\}
 \end{aligned}$$

We see that one has naturally:

$$2^{\Theta_1=\{A,B\}} \neq 2^{\Theta_2=\{X,Y\}} \neq 2^{\Theta^{ref}=\{\theta_1,\theta_2,\theta_3,\theta_4\}}$$

even if working from θ_i with $A \cup B = X \cup Y = \{\theta_1, \theta_2, \theta_3, \theta_4\} = \Theta^{ref}$.

- **The hyper-power set:** $D^\Theta \triangleq (\Theta, \cup, \cap)$

One of the cornerstones of DSMT is the free Dedekind's lattice [4] denoted as hyper-power set in DSMT framework. Let $\Theta = \{\theta_1, \dots, \theta_n\}$ be a finite set (called frame) of n exhaustive elements. The hyper-power set D^Θ is defined as the set of all composite propositions/subsets built from elements of Θ with \cup and \cap operators such that:

1. $\emptyset, \theta_1, \dots, \theta_n \in D^\Theta$.
2. If $A, B \in D^\Theta$, then $A \cap B \in D^\Theta$ and $A \cup B \in D^\Theta$.
3. No other elements belong to D^Θ , except those obtained by using rules 1 and 2.

Therefore by convention, we write $D^\Theta = (\Theta, \cup, \cap)$ which means that Θ generates D^Θ under operators \cup and \cap . The dual (obtained by switching \cup and \cap in expressions) of D^Θ is itself. There are elements in D^Θ which are self-dual (dual to themselves), for example α_8 for the case when $n = 3$ in the following example. The cardinality of D^Θ is majored by 2^{2^n} when the cardinality of Θ equals n , i.e. $|\Theta| = n$. The generation of hyper-power set D^Θ is closely related with the famous Dedekind's problem [3, 4] on enumerating the set of isotone Boolean functions. The generation of the hyper-power set is presented in [32]. Since for any given finite set Θ , $|D^\Theta| \geq |2^\Theta|$ we call D^Θ the hyper-power set of Θ .

Example of the first hyper-power sets:

- For the degenerate case ($n = 0$) where $\Theta = \{\}$, one has $D^\Theta = \{\alpha_0 \triangleq \emptyset\}$ and $|D^\Theta| = 1$.
- When $\Theta = \{\theta_1\}$, one has $D^\Theta = \{\alpha_0 \triangleq \emptyset, \alpha_1 \triangleq \theta_1\}$ and $|D^\Theta| = 2$.
- When $\Theta = \{\theta_1, \theta_2\}$, one has $D^\Theta = \{\alpha_0, \alpha_1, \dots, \alpha_4\}$ and $|D^\Theta| = 5$ with $\alpha_0 \triangleq \emptyset$, $\alpha_1 \triangleq \theta_1 \cap \theta_2$, $\alpha_2 \triangleq \theta_1$, $\alpha_3 \triangleq \theta_2$ and $\alpha_4 \triangleq \theta_1 \cup \theta_2$.

- When $\Theta = \{\theta_1, \theta_2, \theta_3\}$, one has $D^\Theta = \{\alpha_0, \alpha_1, \dots, \alpha_{18}\}$ and $|D^\Theta| = 19$ with

$$\begin{array}{ll}
\alpha_0 \triangleq \emptyset & \\
\alpha_1 \triangleq \theta_1 \cap \theta_2 \cap \theta_3 & \alpha_{10} \triangleq \theta_2 \\
\alpha_2 \triangleq \theta_1 \cap \theta_2 & \alpha_{11} \triangleq \theta_3 \\
\alpha_3 \triangleq \theta_1 \cap \theta_3 & \alpha_{12} \triangleq (\theta_1 \cap \theta_2) \cup \theta_3 \\
\alpha_4 \triangleq \theta_2 \cap \theta_3 & \alpha_{13} \triangleq (\theta_1 \cap \theta_3) \cup \theta_2 \\
\alpha_5 \triangleq (\theta_1 \cup \theta_2) \cap \theta_3 & \alpha_{14} \triangleq (\theta_2 \cap \theta_3) \cup \theta_1 \\
\alpha_6 \triangleq (\theta_1 \cup \theta_3) \cap \theta_2 & \alpha_{15} \triangleq \theta_1 \cup \theta_2 \\
\alpha_7 \triangleq (\theta_2 \cup \theta_3) \cap \theta_1 & \alpha_{16} \triangleq \theta_1 \cup \theta_3 \\
\alpha_8 \triangleq (\theta_1 \cap \theta_2) \cup (\theta_1 \cap \theta_3) \cup (\theta_2 \cap \theta_3) & \alpha_{17} \triangleq \theta_2 \cup \theta_3 \\
\alpha_9 \triangleq \theta_1 & \alpha_{18} \triangleq \theta_1 \cup \theta_2 \cup \theta_3
\end{array}$$

The cardinality of hyper-power set D^Θ for $n \geq 1$ follows the sequence of Dedekind's numbers [27], i.e. 1,2,5,19,167, 7580,7828353,... and analytical expression of Dedekind's numbers has been obtained recently by Tombak in [47] (see [32] for details on generation and ordering of D^Θ). Interesting investigations on the programming of the generation of hyper-power sets for engineering applications have been done in Chapter 15 of [36] and in Chapter 7 of this volume.

Examples of hyper-power sets:

Let's consider the frames $\Theta_1 = \{A, B\}$ and $\Theta_2 = \{X, Y\}$, then their corresponding hyper-power sets are $D^{\Theta_1=\{A,B\}} = \{\emptyset, A \cap B, A, B, A \cup B\}$ and $D^{\Theta_2=\{X,Y\}} = \{\emptyset, X \cap Y, X, Y, X \cup Y\}$. Let's consider a refined frame $\Theta^{ref} = \{\theta_1, \theta_2, \theta_3, \theta_4\}$ where the granules θ_i , $i = 1, \dots, 4$ are now considered as *truly exhaustive and exclusive*. If A and B are expressed more precisely in function of the granules θ_i by example as $A \triangleq \{\theta_1, \theta_2, \theta_3\}$ and $B \triangleq \{\theta_2, \theta_4\}$ then

$$\begin{aligned}
D^{\Theta_1=\{A,B\}} &= \{\emptyset, A \cap B, A, B, A \cup B\} \\
&= \{\emptyset, \underbrace{\{\theta_1, \theta_2, \theta_3\} \cap \{\theta_2, \theta_4\}}_{A \cap B = \{\theta_2\}}, \underbrace{\{\theta_1, \theta_2, \theta_3\}}_A, \underbrace{\{\theta_2, \theta_4\}}_B, \\
&\quad \underbrace{\{\{\theta_1, \theta_2, \theta_3\}, \{\theta_2, \theta_4\}\}}_{A \cup B = \{\theta_1, \theta_2, \theta_3, \theta_4\}}\} \\
&= \{\emptyset, \theta_2, \theta_1 \cup \theta_2 \cup \theta_3, \theta_2 \cup \theta_4, \theta_1 \cup \theta_2 \cup \theta_3 \cup \theta_4\} \\
&\neq 2^{\Theta_1=\{A,B\}}
\end{aligned}$$

If X and Y are expressed more precisely in function of the finer granules θ_i by example as $X \triangleq \{\theta_1\}$ and $Y \triangleq \{\theta_2, \theta_3, \theta_4\}$ then in assuming that θ_i , $i = 1, \dots, 4$ are exhaustive and exclusive, one gets

$$\begin{aligned}
 D^{\Theta_2=\{X,Y\}} &= \{\emptyset, X \cap Y, X, Y, X \cup Y\} \\
 &= \{\emptyset, \underbrace{\{\theta_1\} \cap \{\theta_2, \theta_3, \theta_4\}}_{\substack{X \cap Y = \emptyset \\ \emptyset}}, \underbrace{\{\theta_1\}}_X, \underbrace{\{\theta_2, \theta_3, \theta_4\}}_Y, \underbrace{\{\{\theta_1\}, \{\theta_2, \theta_3, \theta_4\}\}}_{X \cup Y}\} \\
 &= \{\emptyset, \underbrace{\{\theta_1\}}_X, \underbrace{\{\theta_2, \theta_3, \theta_4\}}_Y, \underbrace{\{\{\theta_1\}, \{\theta_2, \theta_3, \theta_4\}\}}_{X \cup Y}\} \\
 &\equiv 2^{\Theta_2=\{X,Y\}}
 \end{aligned}$$

Therefore, we see that $D^{\Theta_2=\{X,Y\}} \equiv 2^{\Theta_2=\{X,Y\}}$ because the exclusivity constraint $X \cap Y = \emptyset$ holds since one has assumed $X \triangleq \{\theta_1\}$ and $Y \triangleq \{\theta_2, \theta_3, \theta_4\}$ with exhaustive and exclusive granules θ_i , $i = 1, \dots, 4$.

If the granules θ_i , $i = 1, \dots, 4$ are not assumed exclusive, then of course the expressions of hyper-power sets cannot be simplified and one would have:

$$\begin{aligned}
 D^{\Theta_1=\{A,B\}} &= \{\emptyset, A \cap B, A, B, A \cup B\} \\
 &= \{\emptyset, (\theta_1 \cup \theta_2 \cup \theta_3) \cap (\theta_2 \cup \theta_4), \theta_1 \cup \theta_2 \cup \theta_3, \theta_2 \cup \theta_4, \theta_1 \cup \theta_2 \cup \theta_3 \cup \theta_4\} \\
 &\neq 2^{\Theta_1=\{A,B\}}
 \end{aligned}$$

$$\begin{aligned}
 D^{\Theta_2=\{X,Y\}} &= \{\emptyset, X \cap Y, X, Y, X \cup Y\} \\
 &= \{\emptyset, \theta_1 \cap (\theta_2 \cup \theta_3 \cup \theta_4), \theta_1, \theta_2 \cup \theta_3 \cup \theta_4, \theta_1 \cup \theta_2 \cup \theta_3 \cup \theta_4\} \\
 &\neq 2^{\Theta_2=\{X,Y\}}
 \end{aligned}$$

Shafer's model of a frame: More generally, when all the elements of a given frame Θ are known (or are assumed to be) truly exclusive, then the hyper-power set D^Θ reduces to the classical power set 2^Θ . Therefore, working on power set 2^Θ as Glenn Shafer has proposed in his Mathematical Theory of Evidence [25]) is equivalent to work on hyper-power set D^Θ with the assumption that all elements of the frame are exclusive. This is what we call *Shafer's model of the frame* Θ , written $\mathcal{M}^0(\Theta)$, even if such model/assumption has not been clearly stated explicitly by Shafer himself in his milestone book.

- **The super-power set:** $S^\Theta \triangleq (\Theta, \cup, \cap, c(\cdot))$

The notion of super-power set has been introduced by Smarandache in the Chapter 8 of [36]. It corresponds actually to the theoretical construction of the power set of the minimal³ refined frame Θ^{ref} of Θ . Θ generates S^Θ under operators \cup , \cap and complementation $c(\cdot)$. $S^\Theta = (\Theta, \cup, \cap, c(\cdot))$ is a Boolean algebra with respect to the union, intersection and complementation. Therefore working with the super-power set is equivalent to work with a minimal theoretical refined frame Θ^{ref} satisfying Shafer's model. More precisely, S^Θ is defined as the set of all composite propositions/subsets built from elements of Θ with \cup , \cap and $c(\cdot)$ operators such that:

1. $\emptyset, \theta_1, \dots, \theta_n \in S^\Theta$.
2. If $A, B \in S^\Theta$, then $A \cap B \in S^\Theta$, $A \cup B \in S^\Theta$.
3. If $A \in S^\Theta$, then $c(A) \in S^\Theta$.
4. No other elements belong to S^Θ , except those obtained by using rules 1, 2 and 3.

As reported in [33], a similar generalization has been previously used in 1993 by Guan and Bell [15] for the Dempster-Shafer rule using propositions in sequential logic and reintroduced in 1994 by Paris in his book [21], page 4.

Example of a super-power set:

Let's consider the frame $\Theta = \{\theta_1, \theta_2\}$ and let's assume $\theta_1 \cap \theta_2 \neq \emptyset$, i.e. θ_1 and θ_2 are not disjoint according to Fig. 1.1 where $A \triangleq p_1$ denotes the part of θ_1 belonging only to θ_1 (p stands here for *part*), $B \triangleq p_2$ denotes the part of θ_2 belonging only to θ_2 and $C \triangleq p_{12}$ denotes the part of θ_1 and θ_2 belonging to both. In this example, $S^{\Theta=\{\theta_1, \theta_2\}}$ is then given by

$$S^\Theta = \{\emptyset, \theta_1 \cap \theta_2, \theta_1, \theta_2, \theta_1 \cup \theta_2, c(\emptyset), c(\theta_1 \cap \theta_2), c(\theta_1), c(\theta_2), c(\theta_1 \cup \theta_2)\}$$

where $c(\cdot)$ is the complement in Θ . Since $c(\emptyset) = \theta_1 \cup \theta_2$ and $c(\theta_1 \cup \theta_2) = \emptyset$, the super-power set is actually given by

$$S^\Theta = \{\emptyset, \theta_1 \cap \theta_2, \theta_1, \theta_2, \theta_1 \cup \theta_2, c(\theta_1 \cap \theta_2), c(\theta_1), c(\theta_2)\}$$

Let's now consider the minimal refinement $\Theta^{ref} = \{A, B, C\}$ of Θ built by splitting the granules θ_1 and θ_2 depicted on the previous Venn diagram into disjoint parts (i.e. Θ^{ref} satisfies the Shafer's model) as follows:

³The minimality refers here to the cardinality of the refined frames.

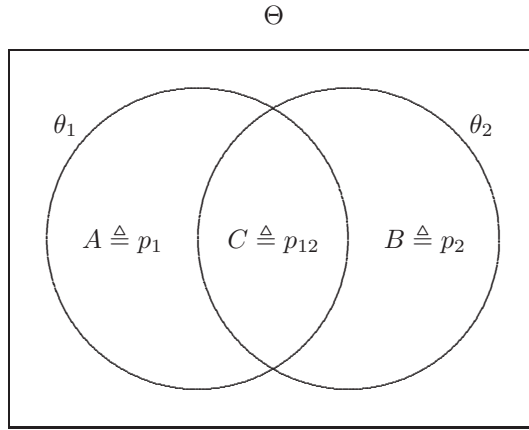

Figure 1.1: Venn diagram of a free DSm model for a 2D frame.

$$\theta_1 = A \cup C, \quad \theta_2 = B \cup C, \quad \theta_1 \cap \theta_2 = C$$

Then the classical power set of Θ^{ref} is given by

$$2^{\Theta^{ref}} = \{\emptyset, A, B, C, A \cup B, A \cup C, B \cup C, A \cup B \cup C\}$$

We see that we can define easily a one-to-one correspondence, written \sim , between all the elements of the super-power set S^Θ and the elements of the power set $2^{\Theta^{ref}}$ as follows:

$$\emptyset \sim \emptyset, \quad (\theta_1 \cap \theta_2) \sim C, \quad \theta_1 \sim (A \cup C), \quad \theta_2 \sim (B \cup C), \quad (\theta_1 \cup \theta_2) \sim (A \cup B \cup C)$$

$$c(\theta_1 \cap \theta_2) \sim (A \cup B), \quad c(\theta_1) \sim B, \quad c(\theta_2) \sim A$$

Such one-to-one correspondence between the elements of S^Θ and $2^{\Theta^{ref}}$ can be defined for any cardinality $|\Theta| \geq 2$ of the frame Θ and thus one can consider S^Θ as the mathematical construction of the power set $2^{\Theta^{ref}}$ of the minimal refinement of the frame Θ . Of course, when Θ already satisfies Shafer's model, the hyper-power set and the super-power set coincide with the classical power set of Θ . It is worth to note that even if we have a mathematical tool to build the minimal refined frame satisfying Shafer's model, it doesn't mean necessary that one must work with this super-power set in general in real applications because most of the time the elements/granules of S^Θ have no clear physical

meaning, not to mention the drastic increase of the complexity since one has $2^\Theta \subseteq D^\Theta \subseteq S^\Theta$ and

$$|2^\Theta| = 2^{|\Theta|} < |D^\Theta| < |S^\Theta| = 2^{|\Theta^{ref}|} = 2^{2^{|\Theta|-1}} \quad (1.1)$$

Typically,

$ \Theta = n$	$ 2^\Theta = 2^n$	$ D^\Theta $	$ S^\Theta = 2^{\Theta^{ref}} = 2^{2^n - 1}$
2	4	5	$2^3 = 8$
3	8	19	$2^7 = 128$
4	16	167	$2^{15} = 32768$
5	32	7580	$2^{31} = 2147483648$

Table 1.2: Cardinalities of 2^Θ , D^Θ and S^Θ .

In summary, DSMT offers truly the possibility to build and to work on refined frames and to deal with the complement whenever necessary, but in most of applications either the frame Θ is already built/chosen to satisfy Shafer's model or the refined granules have no clear physical meaning which finally prevent to be considered/assessed individually so that working on the hyper-power set is usually sufficient for dealing with uncertain imprecise (quantitative or qualitative) and highly conflicting sources of evidences. Working with S^Θ is actually very similar to working with 2^Θ in the sense that in both cases we work with classical power sets; the only difference is that when working with S^Θ we have implicitly switched from the original frame Θ representation to a minimal refinement Θ^{ref} representation. Therefore, in the sequel we focus our discussions based mainly on hyper-power set rather than (super-) power set which has already been the basis for the development of DST. But as already mentioned, DSMT can easily deal with belief functions defined on 2^Θ or S^Θ similarly as those defined on D^Θ .

Generic notation: In the sequel, we use the generic notation G^Θ for denoting the sets (power set, hyper-power set and super-power set) on which the belief functions are defined.

Remark on the logical refinement: The refinement in logic theory presented recently by Cholvy in [2] was actually proposed in nineties by a Guan and Bell [15] and by Paris [21]. This refinement is isomorphic to the refinement in set theory done by many researchers. If $\Theta = \{\theta_1, \theta_2, \theta_3\}$ is a language where the propositional variables are $\theta_1, \theta_2, \theta_3$, Cholvy considers all 8 possible logical combinations of propositions θ_i 's or negations of θ_i 's (called interpretations), and defines the $8 = 2^3$ disjoint parts/propositions of the Venn diagram

in Fig. 1.2 [one also considers as a part the negation of the total ignorance] in the set theory, so that:

$$\begin{aligned}
 i_1 &= \theta_1 \wedge \theta_2 \wedge \theta_3 \\
 i_2 &= \theta_1 \wedge \theta_2 \wedge \neg\theta_3 \\
 i_3 &= \theta_1 \wedge \neg\theta_2 \wedge \theta_3 \\
 i_4 &= \theta_1 \wedge \neg\theta_2 \wedge \neg\theta_3 \\
 i_5 &= \neg\theta_1 \wedge \theta_2 \wedge \theta_3 \\
 i_6 &= \neg\theta_1 \wedge \theta_2 \wedge \neg\theta_3 \\
 i_7 &= \neg\theta_1 \wedge \neg\theta_2 \wedge \theta_3 \\
 i_8 &= \neg\theta_1 \wedge \neg\theta_2 \wedge \neg\theta_3
 \end{aligned}$$

where $\neg\theta_i$ means the negation of θ_i .

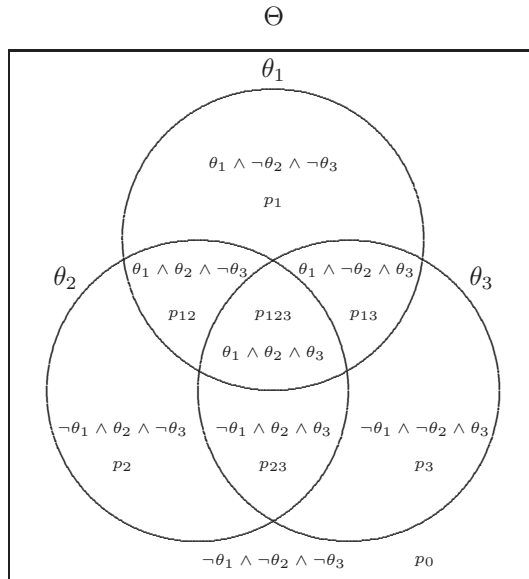

Figure 1.2: Venn diagram of the free DS_m model for a 3D frame.

Because of Shafer's equivalence of subsets and propositions, Cholvy's logical refinement is strictly equivalent to the refinement we did already in 2006 in defining S^Θ - see Chap. 8 of [36] - but in the set theory framework.

We did it using Smarandache's codification (easy to understand and read) in the following way:

- each Venn diagram disjoint part p_{ij} , or p_{ijk} represents respectively the intersection of p_i and p_j only, or p_i and p_j and p_k only, etc; while the complement of the total ignorance is considered p_0 [p stands for part].

Thus, we have an easier and clearer representation in DSmT than in logical representation. While the refinement in DST using logical approach for n very large is very hard, we can simply consider in the DSmT the super-power set $S^\ominus = (\Theta, \cup, \cap, c(.))$. So, in DSmT representation the disjoint parts are noted as follows:

$$\begin{aligned}
 p_{123} &= \theta_1 \wedge \theta_2 \wedge \theta_3 = i_1 \\
 p_{12} &= \theta_1 \wedge \theta_2 \wedge \neg\theta_3 = i_2 \\
 p_{13} &= \theta_1 \wedge \neg\theta_2 \wedge \theta_3 = i_3 \\
 p_{23} &= \neg\theta_1 \wedge \theta_2 \wedge \theta_3 = i_5 \\
 p_1 &= \theta_1 \wedge \neg\theta_2 \wedge \neg\theta_3 = i_4 \\
 p_2 &= \neg\theta_1 \wedge \theta_2 \wedge \neg\theta_3 = i_6 \\
 p_3 &= \neg\theta_1 \wedge \neg\theta_2 \wedge \theta_3 = i_7 \\
 p_0 &= \neg\theta_1 \wedge \neg\theta_2 \wedge \neg\theta_3 = i_8
 \end{aligned}$$

As seeing, in Smarandache's codification a disjoint Venn diagram part is equal to the intersection of singletons whose indexes show up as indexes of the Venn part; for example in p_{12} case indexes 1 and 2, intersected with the complement of the missing indexes, in this case index 3 is missing.

Smarandache's codification can easily transform any set from S^\ominus into its canonical disjunctive normal form. For example, $\theta_1 = p_1 \cup p_{12} \cup p_{13} \cup p_{123}$ (i.e. all Venn diagram disjoint parts that contain the index "1" in their indexes ; such indexes from S^\ominus are 1, 12, 13, 123) can be expressed as

$$\theta_1 = (\theta_1 \cap c(\theta_2) \cap c(\theta_3)) \cup (\theta_1 \cap \theta_2 \cap c(\theta_3)) \cup (\theta_1 \cap c(\theta_2) \cap \theta_3) \cup (\theta_1 \cap \theta_2 \cap \theta_3)$$

where the set values of each part was taken from the above table.

$\theta_1 \wedge \theta_2 = p_{12} \cup p_{123}$ (i.e. all Venn diagram disjoint parts that contain the index "12" in their indexes) equals to $(\theta_1 \wedge \theta_2 \wedge \neg\theta_3) \vee (\theta_1 \wedge \theta_2 \wedge \theta_3)$.

The refinement based on Venn Diagram, becomes very hard and almost impossible when the cardinal of Θ , n , is large and all intersections are non-empty (the free model). Suppose $n = 20$, or even bigger, and we have the free model. How can we construct a Venn Diagram where to show all possible intersections of 20 sets? Its geometrical figure would be very hard to design and very hard to read (you don't identify well each disjoint part of a such Venn Diagram to what intersection of sets it belongs to). The larger is n , the more difficult is the refinement. Fortunately, based on Smarandache's codification, we can algebraically design in an easy way for all such intersections (for example, if n is very big, we can use computer programs to make combinations of indexes $\{1, 2, \dots, n\}$ taken in groups of 1, of 2, ..., or of n elements each), so the refinement should not be a big problem from the programming point of view, but we must always keep in mind if such refinement is really necessary and if it has (or not) a deep physical interpretation and justification for the problem under consideration.

The assertion in [2], upon Milan Daniel's, that hybrid DSMT rule is equivalent to Dubois-Prade rule is untrue, since in dynamic fusion they give different results. Such example has been already given in [8] and is reported in section 1.2.6.3 for the sake of clarification for the readers. The assertion in [2] that "from an expressivity point of view DSMT is equivalent to DST" is partially true since this idea is true when the refinement is possible (not always it is practically/physically possible), and even when the spaces we work on, $S^\Theta = 2^{\Theta^{ref}}$, where the hypotheses are exclusive, DSMT offers the advantage that the refinement is already done (it is not necessary for the user to do (or implicitly presuppose) it as in DST). Also, DSMT accepts from the very beginning the possibility to deal with non-exclusive hypotheses and of course it can a fortiori deal with sets of exclusive hypothesis and work either on 2^Θ or $2^{\Theta^{ref}}$ whenever necessary, while DST first requires implicitly to work with exclusive hypotheses only.

The main distinctions between DSMT and DST are summarized by the following points:

1. The refinement is not always (physically) possible, especially for elements from the frame of discernment whose frontiers are not clear, such as: colors, vague sets, unclear hypotheses, etc. in the frame of discernment; DST does not fit well for working in such cases, while DSMT does;
2. Even in the case when the frame of discernment can be refined (i.e. the *atomic* elements of the frame have all a distinct physical meaning), it is still easier to use DSMT than DST since in DSMT framework the

refinement is done automatically by the mathematical construction of the super-power set;

3. DSMT offers better fusion rules, for example Proportional Conflict redistribution Rule # 5 (PCR5) - presented in the sequel - is better than Dempster's rule; hybrid DSMT rule (DSMT_H) works for the dynamic fusion, while Dubois-Prade fusion rule does not (DSMT_H is an extension of Dubois-Prade rule); therefore DSMT with its fusion rules cannot be considered as a special case of DST, contrariwise to some authors' claims in the literature (see [5] by example).
4. DSMT offers the best qualitative operators (when working with labels) giving the most accurate and coherent results;
5. DSMT offers new interesting quantitative conditioning rules (BCRs) and qualitative conditioning rules (QBCRs), different from Shafer's conditioning rule (SCR). SCR can be seen simply as a combination of a prior mass of belief with the mass $m(A) = 1$ whenever A is the conditioning event;
6. DSMT proposes a new approach for working with imprecise quantitative or qualitative information and not limited to interval-valued belief structures as proposed generally in the literature [6, 7, 49].

1.2.2 Notion of free and hybrid DSMT models

Free DSMT model: The elements $\theta_i, i = 1, \dots, n$ of Θ constitute the finite set of hypotheses/concepts characterizing the fusion problem under consideration. When there is no constraint on the elements of the frame, we call this model the *free DSMT model*, written $\mathcal{M}^f(\Theta)$. This free DSMT model allows to deal directly with fuzzy concepts which depict a continuous and relative intrinsic nature and which cannot be precisely refined into finer disjoint information granules having an absolute interpretation because of the unreachable universal truth. In such case, the use of the hyper-power set D^Θ (without integrity constraints) is particularly well adapted for defining the belief functions one wants to combine.

Shafer's model: In some fusion problems involving discrete concepts, all the elements $\theta_i, i = 1, \dots, n$ of Θ can be truly exclusive. In such case, all the exclusivity constraints on $\theta_i, i = 1, \dots, n$ have to be included in the previous model to characterize properly the true nature of the fusion problem and to fit it with the reality. By doing this, the hyper-power set D^Θ as well as the super-power set S^Θ reduce naturally to the classical power set 2^Θ and this constitutes what

we have called *Shafer's model*, denoted $\mathcal{M}^0(\Theta)$. Shafer's model corresponds actually to the most restricted hybrid DSMT model.

Hybrid DSMT models: Between the class of fusion problems corresponding to the free DSMT model $\mathcal{M}^f(\Theta)$ and the class of fusion problems corresponding to Shafer's model $\mathcal{M}^0(\Theta)$, there exists another wide class of hybrid fusion problems involving in Θ both fuzzy continuous concepts and discrete hypotheses. In such (hybrid) class, some exclusivity constraints and possibly some non-existential constraints (especially when working on dynamic⁴ fusion) have to be taken into account. Each hybrid fusion problem of this class will then be characterized by a proper hybrid DSMT model denoted $\mathcal{M}(\Theta)$ with $\mathcal{M}(\Theta) \neq \mathcal{M}^f(\Theta)$ and $\mathcal{M}(\Theta) \neq \mathcal{M}^0(\Theta)$.

In any fusion problems, we consider as primordial at the very beginning and before combining information expressed as belief functions to define clearly the proper frame Θ of the given problem and to choose explicitly its corresponding model one wants to work with. Once this is done, the second important point is to select the proper set 2^Θ , D^Θ or S^Θ on which the belief functions will be defined. The third important point will be the choice of an efficient rule of combination of belief functions and finally the criteria adopted for decision-making.

In the sequel, we focus our presentation mainly on hyper-power set D^Θ (unless specified) since it is the most interesting new aspect of DSMT for readers already familiar with DST framework, but a fortiori we can work similarly on classical power set 2^Θ if Shafer's model holds, and even on $2^{\Theta^{ref}}$ (the power set of the minimal refined frame) whenever one wants to use it and if possible.

Examples of models for a frame Θ :

- Let's consider the 2D problem where $\Theta = \{\theta_1, \theta_2\}$ with $D^\Theta = \{\emptyset, \theta_1 \cap \theta_2, \theta_1, \theta_2, \theta_1 \cup \theta_2\}$ and assume now that θ_1 and θ_2 are truly exclusive (i.e. Shafer's model \mathcal{M}^0 holds), then because $\theta_1 \cap \theta_2 \stackrel{\mathcal{M}^0}{=} \emptyset$, one gets $D^\Theta = \{\emptyset, \theta_1 \cap \theta_2 \stackrel{\mathcal{M}^0}{=} \emptyset, \theta_1, \theta_2, \theta_1 \cup \theta_2\} = \{\emptyset, \theta_1, \theta_2, \theta_1 \cup \theta_2\} \equiv 2^\Theta$.

- As another simple example of hybrid DSMT model, let's consider the 3D case with the frame $\Theta = \{\theta_1, \theta_2, \theta_3\}$ with the model $\mathcal{M} \neq \mathcal{M}^f$ in which we force all possible conjunctions to be empty, but $\theta_1 \cap \theta_2$. This hybrid DSMT model is then represented with the Venn diagram on Fig. 1.3 (where boundaries of

⁴i.e. when the frame Θ and/or the model \mathcal{M} is changing with time.

intersection of θ_1 and θ_2 are not precisely defined if θ_1 and θ_2 represent only fuzzy concepts like smallness and tallness by example).

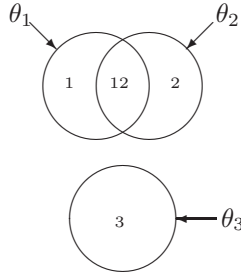

Figure 1.3: Venn diagram of a DS_m hybrid model for a 3D frame.

1.2.3 Generalized belief functions

From a general frame Θ , we define a map $m(\cdot) : G^\Theta \rightarrow [0, 1]$ associated to a given body of evidence \mathcal{B} as

$$m(\emptyset) = 0 \quad \text{and} \quad \sum_{A \in G^\Theta} m(A) = 1 \tag{1.2}$$

The quantity $m(A)$ is called the generalized basic belief assignment/mass (gbba) of A .

The generalized belief and plausibility functions are defined in almost the same manner as within DST, i.e.

$$\text{Bel}(A) = \sum_{\substack{B \subseteq A \\ B \in G^\Theta}} m(B) \quad \text{Pl}(A) = \sum_{\substack{B \cap A \neq \emptyset \\ B \in G^\Theta}} m(B) \tag{1.3}$$

We recall that G^Θ is the generic notation for the set on which the gbba is defined (G^Θ can be 2^Θ , D^Θ or even S^Θ depending on the model chosen for Θ). These definitions are compatible with the definitions of the classical belief functions in DST framework when $G^\Theta = 2^\Theta$ for fusion problems where Shafer’s model $\mathcal{M}^0(\Theta)$ holds. We still have $\forall A \in G^\Theta, \text{Bel}(A) \leq \text{Pl}(A)$.

Note that when working with the free DS_m model $\mathcal{M}^f(\Theta)$, one has always $\text{Pl}(A) = 1 \forall A \neq \emptyset \in (G^\Theta = D^\Theta)$ which is normal.

Example: Let's consider the simple frame $\Theta = \{A, B\}$, then depending on the model we choose for G^Θ , one will consider either:

- G^Θ as the power set 2^Θ and therefore:

$$m(A) + m(B) + m(A \cup B) = 1$$

- G^Θ as the hyper-power set D^Θ and therefore:

$$m(A) + m(B) + m(A \cup B) + m(A \cap B) = 1$$

- G^Θ as the super-power set S^Θ and therefore:

$$\begin{aligned} m(A) + m(B) + m(A \cup B) + m(A \cap B) \\ + m(c(A)) + m(c(B)) + m(c(A) \cup c(B)) = 1 \end{aligned}$$

1.2.4 The classic DSMT rule of combination

When the free DSMT model $\mathcal{M}^f(\Theta)$ holds for the fusion problem under consideration, the classic DSMT rule of combination $m_{\mathcal{M}^f(\Theta)} \equiv m(\cdot) \triangleq [m_1 \oplus m_2](\cdot)$ of two independent⁵ sources of evidences \mathcal{B}_1 and \mathcal{B}_2 over the same frame Θ with belief functions $\text{Bel}_1(\cdot)$ and $\text{Bel}_2(\cdot)$ associated with gbba $m_1(\cdot)$ and $m_2(\cdot)$ corresponds to the conjunctive consensus of the sources. It is given by [32]:

$$\forall C \in D^\Theta, \quad m_{\mathcal{M}^f(\Theta)}(C) \equiv m(C) = \sum_{\substack{A, B \in D^\Theta \\ A \cap B = C}} m_1(A)m_2(B) \quad (1.4)$$

Since D^Θ is closed under \cup and \cap set operators, this new rule of combination guarantees that $m(\cdot)$ is a proper generalized belief assignment, i.e. $m(\cdot) : D^\Theta \rightarrow [0, 1]$. This rule of combination is commutative and associative and can always be used for the fusion of sources involving fuzzy concepts when free DSMT model holds for the problem under consideration. This rule can be directly and easily extended for the combination of $k > 2$ independent sources of evidence [32].

According to Table 1.2, this classic DSMT rule of combination looks very expensive in terms of computations and memory size due to the huge number

⁵While independence is a difficult concept to define in all theories managing epistemic uncertainty, we follow here the interpretation of Smets in [39] and [40], p. 285 and consider that two sources of evidence are independent (i.e distinct and noninteracting) if each leaves one totally ignorant about the particular value the other will take.

of elements in D^Θ when the cardinality of Θ increases. This remark is however valid only if the cores (the set of focal elements of gbba) $\mathcal{K}_1(m_1)$ and $\mathcal{K}_2(m_2)$ coincide with D^Θ , i.e. when $m_1(A) > 0$ and $m_2(A) > 0$ for all $A \neq \emptyset \in D^\Theta$. Fortunately, it is important to note here that in most of the practical applications the sizes of $\mathcal{K}_1(m_1)$ and $\mathcal{K}_2(m_2)$ are much smaller than $|D^\Theta|$ because bodies of evidence generally allocate their basic belief assignments only over a subset of the hyper-power set. This makes things easier for the implementation of the classic DS m rule (1.4). The DS m rule is actually very easy to implement. It suffices for each focal element of $\mathcal{K}_1(m_1)$ to multiply it with the focal elements of $\mathcal{K}_2(m_2)$ and then to pool all combinations which are equivalent under the algebra of sets. While very costly in term on memory storage in the worst case (i.e. when all $m(A) > 0$, $A \in D^\Theta$ or $A \in 2^{\Theta^{ref}}$), the DS m rule however requires much smaller memory storage than when working with S^Θ , i.e. working with a minimal refined frame satisfying Shafer's model.

In most fusion applications only a small subset of elements of D^Θ have a non null basic belief mass because all the commitments are just usually impossible to obtain precisely when the dimension of the problem increases. Thus, it is not necessary to generate and keep in memory all elements of D^Θ (or eventually S^Θ) but only those which have a positive belief mass. However there is a real technical challenge on how to manage efficiently all elements of the hyper-power set. This problem is obviously much more difficult when trying to work on a refined frame of discernment Θ^{ref} if one really prefers to use Dempster-Shafer theory and apply Dempster's rule of combination. It is important to keep in mind that the ultimate and minimal refined frame consisting in exhaustive and exclusive finite set of refined exclusive hypotheses is just impossible to justify and to define precisely for all problems dealing with fuzzy and ill-defined continuous concepts. A discussion on refinement with an example has been included in [32].

1.2.5 The hybrid DS m rule of combination

When the free DS m model $\mathcal{M}^f(\Theta)$ does not hold due to the true nature of the fusion problem under consideration which requires to take into account some known integrity constraints, one has to work with a proper hybrid DS m model $\mathcal{M}(\Theta) \neq \mathcal{M}^f(\Theta)$. In such case, the hybrid DS m rule (DS mH) of combination based on the chosen hybrid DS m model $\mathcal{M}(\Theta)$ for $k \geq 2$ independent sources of information is defined for all $A \in D^\Theta$ as [32]:

$$m_{DSmH}(A) = m_{\mathcal{M}(\Theta)}(A) \triangleq \phi(A) \left[S_1(A) + S_2(A) + S_3(A) \right] \quad (1.5)$$

where all sets involved in formulas are in the canonical form and $\phi(A)$ is the characteristic non-emptiness function of a set A , i.e. $\phi(A) = 1$ if $A \notin \emptyset$ and $\phi(A) = 0$ otherwise, where $\emptyset \triangleq \{\emptyset_{\mathcal{M}}, \emptyset\}$. $\emptyset_{\mathcal{M}}$ is the set of all elements of D^{\ominus} which have been forced to be empty through the constraints of the model \mathcal{M} and \emptyset is the classical/universal empty set. $S_1(A) \equiv m_{\mathcal{M}^f(\theta)}(A)$, $S_2(A)$, $S_3(A)$ are defined by

$$S_1(A) \triangleq \sum_{\substack{X_1, X_2, \dots, X_k \in D^{\ominus} \\ X_1 \cap X_2 \cap \dots \cap X_k = A}} \prod_{i=1}^k m_i(X_i) \quad (1.6)$$

$$S_2(A) \triangleq \sum_{\substack{X_1, X_2, \dots, X_k \in \emptyset \\ [\mathcal{U}=A] \vee [(\mathcal{U} \in \emptyset) \wedge (A=I_t)]}} \prod_{i=1}^k m_i(X_i) \quad (1.7)$$

$$S_3(A) \triangleq \sum_{\substack{X_1, X_2, \dots, X_k \in D^{\ominus} \\ X_1 \cup X_2 \cup \dots \cup X_k = A \\ X_1 \cap X_2 \cap \dots \cap X_k = \emptyset}} \prod_{i=1}^k m_i(X_i) \quad (1.8)$$

with $\mathcal{U} \triangleq u(X_1) \cup u(X_2) \cup \dots \cup u(X_k)$ where $u(X)$ is the union of all θ_i that compose X , $I_t \triangleq \theta_1 \cup \theta_2 \cup \dots \cup \theta_n$ is the total ignorance. $S_1(A)$ corresponds to the classic DSMT rule for k independent sources based on the free DSMT model $\mathcal{M}^f(\Theta)$; $S_2(A)$ represents the mass of all relatively and absolutely empty sets which is transferred to the total or relative ignorances associated with non-existential constraints (if any, like in some dynamic problems); $S_3(A)$ transfers the sum of relatively empty sets directly onto the canonical disjunctive form of non-empty sets.

The hybrid DSMT rule of combination generalizes the classic DSMT rule of combination and is not equivalent to Dempster's rule. It works for any models (the free DSMT model, Shafer's model or any other hybrid models) when manipulating precise generalized (or eventually classical) basic belief functions. An extension of this rule for the combination of imprecise generalized (or eventually classical) basic belief functions is presented in next section. As already stated, in DSMT framework it is also possible to deal directly with complements if necessary depending on the problem under consideration and the information provided by the sources of evidence themselves.

The first and simplest way is to work with S^{\ominus} on Shafer's model when a minimal refinement is possible and makes sense. The second way is to deal

with partially known frame and introduce directly the complementary hypotheses into the frame itself. By example, if one knows only two hypotheses θ_1 , θ_2 and their complements $\bar{\theta}_1$, $\bar{\theta}_2$, then we can choose to switch from original frame $\Theta = \{\theta_1, \theta_2\}$ to the new frame $\Theta = \{\theta_1, \theta_2, \bar{\theta}_1, \bar{\theta}_2\}$. In such case, we don't necessarily assume that $\bar{\theta}_1 = \theta_2$ and $\bar{\theta}_2 = \theta_1$ because $\bar{\theta}_1$ and $\bar{\theta}_2$ may include other unknown hypotheses we have no information about (case of partial known frame). More generally, in DSMT framework, it is not necessary that the frame is built on pure/simple (possibly vague) hypotheses θ_i as usually done in all theories managing uncertainty. The frame Θ can also contain directly as elements conjunctions and/or disjunctions (or mixed propositions) and negations/complements of pure hypotheses as well. The DSMT rules also work in such non-classic frames because DSMT works on any distributive lattice built from Θ anywhere Θ is defined.

1.2.6 Examples of combination rules

Here are some numerical examples on results obtained by DSMT rules of combination. More examples can be found in [32].

1.2.6.1 Example with $\Theta = \{\theta_1, \theta_2, \theta_3, \theta_4\}$

Let's consider the frame of discernment $\Theta = \{\theta_1, \theta_2, \theta_3, \theta_4\}$, two independent experts, and the two following bbas

$$m_1(\theta_1) = 0.6 \quad m_1(\theta_3) = 0.4 \quad m_2(\theta_2) = 0.2 \quad m_2(\theta_4) = 0.8$$

represented in terms of mass matrix

$$\mathbf{M} = \begin{bmatrix} 0.6 & 0 & 0.4 & 0 \\ 0 & 0.2 & 0 & 0.8 \end{bmatrix}$$

- Dempster's rule cannot be applied because: $\forall 1 \leq j \leq 4$, one gets $m(\theta_j) = 0/0$ (undefined!).
- But the classic DSMT rule works because one obtains: $m(\theta_1) = m(\theta_2) = m(\theta_3) = m(\theta_4) = 0$, and $m(\theta_1 \cap \theta_2) = 0.12$, $m(\theta_1 \cap \theta_4) = 0.48$, $m(\theta_2 \cap \theta_3) = 0.08$, $m(\theta_3 \cap \theta_4) = 0.32$ (partial paradoxes/conflicts).
- Suppose now one finds out that all intersections are empty (Shafer's model), then one applies the hybrid DSMT rule and one gets (index h stands here for hybrid rule): $m_h(\theta_1 \cup \theta_2) = 0.12$, $m_h(\theta_1 \cup \theta_4) = 0.48$, $m_h(\theta_2 \cup \theta_3) = 0.08$ and $m_h(\theta_3 \cup \theta_4) = 0.32$.

1.2.6.2 Generalization of Zadeh's example with $\Theta = \{\theta_1, \theta_2, \theta_3\}$

Let's consider $0 < \epsilon_1, \epsilon_2 < 1$ be two very tiny positive numbers (close to zero), the frame of discernment be $\Theta = \{\theta_1, \theta_2, \theta_3\}$, have two experts (independent sources of evidence s_1 and s_2) giving the belief masses

$$\begin{aligned} m_1(\theta_1) &= 1 - \epsilon_1 & m_1(\theta_2) &= 0 & m_1(\theta_3) &= \epsilon_1 \\ m_2(\theta_1) &= 0 & m_2(\theta_2) &= 1 - \epsilon_2 & m_2(\theta_3) &= \epsilon_2 \end{aligned}$$

From now on, we prefer to use matrices to describe the masses, i.e.

$$\begin{bmatrix} 1 - \epsilon_1 & 0 & \epsilon_1 \\ 0 & 1 - \epsilon_2 & \epsilon_2 \end{bmatrix}$$

- Using Dempster's rule of combination, one gets

$$m(\theta_3) = \frac{(\epsilon_1 \epsilon_2)}{(1 - \epsilon_1) \cdot 0 + 0 \cdot (1 - \epsilon_2) + \epsilon_1 \epsilon_2} = 1$$

which is absurd (or at least counter-intuitive). Note that whatever positive values for ϵ_1, ϵ_2 are, Dempster's rule of combination provides always the same result (one) which is abnormal. The only acceptable and correct result obtained by Dempster's rule is really obtained only in the trivial case when $\epsilon_1 = \epsilon_2 = 1$, i.e. when both sources agree in θ_3 with certainty which is obvious.

- Using the DSMT rule of combination based on free-DSMT model, one gets $m(\theta_3) = \epsilon_1 \epsilon_2$, $m(\theta_1 \cap \theta_2) = (1 - \epsilon_1)(1 - \epsilon_2)$, $m(\theta_1 \cap \theta_3) = (1 - \epsilon_1)\epsilon_2$, $m(\theta_2 \cap \theta_3) = (1 - \epsilon_2)\epsilon_1$ and the others are zero which appears more reliable/trustable.
- Going back to Shafer's model and using the hybrid DSMT rule of combination, one gets $m(\theta_3) = \epsilon_1 \epsilon_2$, $m(\theta_1 \cup \theta_2) = (1 - \epsilon_1)(1 - \epsilon_2)$, $m(\theta_1 \cup \theta_3) = (1 - \epsilon_1)\epsilon_2$, $m(\theta_2 \cup \theta_3) = (1 - \epsilon_2)\epsilon_1$ and the others are zero.

Note that in the special case when $\epsilon_1 = \epsilon_2 = 1/2$, one has

$$\begin{aligned} m_1(\theta_1) &= 1/2 & m_1(\theta_2) &= 0 & m_1(\theta_3) &= 1/2 \\ m_2(\theta_1) &= 0 & m_2(\theta_2) &= 1/2 & m_2(\theta_3) &= 1/2 \end{aligned}$$

Dempster's rule of combinations still yields $m(\theta_3) = 1$ while the hybrid DSMT rule based on the same Shafer's model yields now $m(\theta_3) = 1/4$, $m(\theta_1 \cup \theta_2) = 1/4$, $m(\theta_1 \cup \theta_3) = 1/4$, $m(\theta_2 \cup \theta_3) = 1/4$ which is normal.

1.2.6.3 Comparison with Smets, Yager and Dubois & Prade rules

We compare the results provided by DSMT rules and the main common rules of combination on the following very simple numerical example where only 2 independent sources (a priori assumed equally reliable) are involved and providing their belief initially on the 3D frame $\Theta = \{\theta_1, \theta_2, \theta_3\}$. It is assumed in this example that Shafer's model holds and thus the belief assignments $m_1(\cdot)$ and $m_2(\cdot)$ do not commit belief to internal conflicting information. $m_1(\cdot)$ and $m_2(\cdot)$ are chosen as follows:

$$\begin{array}{cccc} m_1(\theta_1) = 0.1 & m_1(\theta_2) = 0.4 & m_1(\theta_3) = 0.2 & m_1(\theta_1 \cup \theta_2) = 0.3 \\ m_2(\theta_1) = 0.5 & m_2(\theta_2) = 0.1 & m_2(\theta_3) = 0.3 & m_2(\theta_1 \cup \theta_2) = 0.1 \end{array}$$

These belief masses are usually represented in the form of a belief mass matrix \mathbf{M} given by

$$\mathbf{M} = \begin{bmatrix} 0.1 & 0.4 & 0.2 & 0.3 \\ 0.5 & 0.1 & 0.3 & 0.1 \end{bmatrix} \quad (1.9)$$

where index i for the rows corresponds to the index of the source no. i and the indexes j for columns of \mathbf{M} correspond to a given choice for enumerating the focal elements of all sources. In this particular example, index $j = 1$ corresponds to θ_1 , $j = 2$ corresponds to θ_2 , $j = 3$ corresponds to θ_3 and $j = 4$ corresponds to $\theta_1 \cup \theta_2$.

Now let's imagine that one finds out that θ_3 is actually truly empty because some extra and certain knowledge on θ_3 is received by the fusion center. As example, θ_1 , θ_2 and θ_3 may correspond to three suspects (potential murders) in a police investigation, $m_1(\cdot)$ and $m_2(\cdot)$ corresponds to two reports of independent witnesses, but it turns out that finally θ_3 has provided a strong alibi to the criminal police investigator once arrested by the policemen. This situation corresponds to set up a hybrid model \mathcal{M} with the constraint $\theta_3 \stackrel{\mathcal{M}}{=} \emptyset$.

Let's examine the result of the fusion in such situation obtained by the Smets', Yager's, Dubois & Prade's and hybrid DSMT rules of combinations. First note that, based on the free DSMT model, one would get by applying the classic DSMT rule (denoted here by index $DSmC$) the following fusion result

$$\begin{array}{ll} m_{DSmC}(\theta_1) = 0.21 & m_{DSmC}(\theta_2) = 0.11 \\ m_{DSmC}(\theta_3) = 0.06 & m_{DSmC}(\theta_1 \cup \theta_2) = 0.03 \\ m_{DSmC}(\theta_1 \cap \theta_2) = 0.21 & m_{DSmC}(\theta_1 \cap \theta_3) = 0.13 \\ m_{DSmC}(\theta_2 \cap \theta_3) = 0.14 & m_{DSmC}(\theta_3 \cap (\theta_1 \cup \theta_2)) = 0.11 \end{array}$$

But because of the exclusivity constraints (imposed here by the use of Shafer's model and by the non-existential constraint $\theta_3 \stackrel{M}{=} \emptyset$), the total conflicting mass is actually given by $k_{12} = 0.06 + 0.21 + 0.13 + 0.14 + 0.11 = 0.65$.

- If one applies **Dempster's rule** [25] (denoted here by index DS), one gets:

$$\begin{aligned} m_{DS}(\emptyset) &= 0 \\ m_{DS}(\theta_1) &= 0.21/[1 - k_{12}] = 0.21/[1 - 0.65] = 0.21/0.35 = 0.600000 \\ m_{DS}(\theta_2) &= 0.11/[1 - k_{12}] = 0.11/[1 - 0.65] = 0.11/0.35 = 0.314286 \\ m_{DS}(\theta_1 \cup \theta_2) &= 0.03/[1 - k_{12}] = 0.03/[1 - 0.65] = 0.03/0.35 = 0.085714 \end{aligned}$$

- If one applies **Smets' rule** [41, 42] (i.e. the non normalized version of Dempster's rule with the conflicting mass transferred onto the empty set), one gets:

$$\begin{aligned} m_S(\emptyset) &= m(\emptyset) = 0.65 && \text{(conflicting mass)} \\ m_S(\theta_1) &= 0.21 \\ m_S(\theta_2) &= 0.11 \\ m_S(\theta_1 \cup \theta_2) &= 0.03 \end{aligned}$$

- If one applies **Yager's rule** [50–52], one gets:

$$\begin{aligned} m_Y(\emptyset) &= 0 \\ m_Y(\theta_1) &= 0.21 \\ m_Y(\theta_2) &= 0.11 \\ m_Y(\theta_1 \cup \theta_2) &= 0.03 + k_{12} = 0.03 + 0.65 = 0.68 \end{aligned}$$

- If one applies **Dubois & Prade's rule** [13], one gets because $\theta_3 \stackrel{\mathcal{M}}{=} \emptyset$:

$$\begin{aligned}
m_{DP}(\emptyset) &= 0 && \text{(by definition of Dubois & Prade's rule)} \\
m_{DP}(\theta_1) &= [m_1(\theta_1)m_2(\theta_1) + m_1(\theta_1)m_2(\theta_1 \cup \theta_2) \\
&\quad + m_2(\theta_1)m_1(\theta_1 \cup \theta_2)] \\
&\quad + [m_1(\theta_1)m_2(\theta_3) + m_2(\theta_1)m_1(\theta_3)] \\
&= [0.1 \cdot 0.5 + 0.1 \cdot 0.1 + 0.5 \cdot 0.3] + [0.1 \cdot 0.3 + 0.5 \cdot 0.2] \\
&= 0.21 + 0.13 = 0.34 \\
m_{DP}(\theta_2) &= [0.4 \cdot 0.1 + 0.4 \cdot 0.1 + 0.1 \cdot 0.3] + [0.4 \cdot 0.3 + 0.1 \cdot 0.2] \\
&= 0.11 + 0.14 = 0.25 \\
m_{DP}(\theta_1 \cup \theta_2) &= [m_1(\theta_1 \cup \theta_2)m_2(\theta_1 \cup \theta_2)] \\
&\quad + [m_1(\theta_1 \cup \theta_2)m_2(\theta_3) + m_2(\theta_1 \cup \theta_2)m_1(\theta_3)] \\
&\quad + [m_1(\theta_1)m_2(\theta_2) + m_2(\theta_1)m_1(\theta_2)] \\
&= [0.30.1] + [0.3 \cdot 0.3 + 0.1 \cdot 0.2] + [0.1 \cdot 0.1 + 0.5 \cdot 0.4] \\
&= [0.03] + [0.09 + 0.02] + [0.01 + 0.20] \\
&= 0.03 + 0.11 + 0.21 = 0.35
\end{aligned}$$

Now if one adds up the masses, one gets $0+0.34+0.25+0.35 = 0.94$ which is less than 1. Therefore Dubois & Prade's rule of combination does not work when a singleton, or an union of singletons, becomes empty (in a dynamic fusion problem). The products of such empty-element columns of the mass matrix \mathbf{M} are lost; this problem is fixed in DSMT by the sum $S_2(\cdot)$ in (1.5) which transfers these products to the total or partial ignorances.

- Finally, if one applies **DSmH rule**, one gets because $\theta_3 \stackrel{\mathcal{M}}{=} \emptyset$:

$$\begin{aligned}
m_{DSmH}(\emptyset) &= 0 && \text{(by definition of DSmH)} \\
m_{DSmH}(\theta_1) &= 0.34 && \text{(same as } m_{DP}(\theta_1)) \\
m_{DSmH}(\theta_2) &= 0.25 && \text{(same as } m_{DP}(\theta_2)) \\
m_{DSmH}(\theta_1 \cup \theta_2) &= [m_1(\theta_1 \cup \theta_2)m_2(\theta_1 \cup \theta_2)] \\
&\quad + [m_1(\theta_1 \cup \theta_2)m_2(\theta_3) + m_2(\theta_1 \cup \theta_2)m_1(\theta_3)] \\
&\quad + [m_1(\theta_1)m_2(\theta_2) + m_2(\theta_1)m_1(\theta_2)] + [m_1(\theta_3)m_2(\theta_3)] \\
&= 0.03 + 0.11 + 0.21 + 0.06 = 0.35 + 0.06 = 0.41 \\
&\neq m_{DP}(\theta_1 \cup \theta_2)
\end{aligned}$$

We can easily verify that $m_{DSmH}(\theta_1) + m_{DSmH}(\theta_2) + m_{DSmH}(\theta_1 \cup \theta_2) = 1$. In this example, using the hybrid DSm rule, one transfers the product

of the empty-element θ_3 column, $m_1(\theta_3)m_2(\theta_3) = 0.2 \cdot 0.3 = 0.06$, to $m_{DSmH}(\theta_1 \cup \theta_2)$, which becomes equal to $0.35 + 0.06 = 0.41$. Clearly, DS_mH rule doesn't provide the same result as Dubois and Prade's rule, but only when working on static frames of discernment (restricted cases).

1.2.7 Fusion of imprecise beliefs

In many fusion problems, it seems very difficult (if not impossible) to have precise sources of evidence generating precise basic belief assignments (especially when belief functions are provided by human experts), and a more flexible plausible and paradoxical theory supporting imprecise information becomes necessary. In the previous sections, we presented the fusion of precise uncertain and conflicting/paradoxical generalized basic belief assignments (gbba) in DS_mT framework. We mean here by precise gbba, basic belief functions/masses $m(\cdot)$ defined precisely on the hyper-power set D^Θ where each mass $m(X)$, where X belongs to D^Θ , is represented by only one real number belonging to $[0, 1]$ such that $\sum_{X \in D^\Theta} m(X) = 1$. In this section, we present the DS_m fusion rule for dealing with admissible imprecise generalized basic belief assignments $m^I(\cdot)$ defined as real subunitary intervals of $[0, 1]$, or even more general as real subunitary sets [i.e. sets, not necessarily intervals].

An imprecise belief assignment $m^I(\cdot)$ over D^Θ is said *admissible* if and only if there exists for every $X \in D^\Theta$ at least one real number $m(X) \in m^I(X)$ such that $\sum_{X \in D^\Theta} m(X) = 1$. The idea to work with imprecise belief structures represented by real subset intervals of $[0, 1]$ is not new and has been investigated in [6, 7, 17] and references therein. The proposed works available in the literature, upon our knowledge were limited only to sub-unitary interval combination in the framework of Transferable Belief Model (TBM) developed by Smets [41, 42]. We extend the approach of Lamata & Moral and Denœux based on subunitary interval-valued masses to subunitary set-valued masses; therefore the closed intervals used by Denœux to denote imprecise masses are generalized to any sets included in $[0, 1]$, i.e. in our case these sets can be unions of (closed, open, or half-open/half-closed) intervals and/or scalars all in $[0, 1]$. Here, the proposed extension is done in the context of DS_mT framework, although it can also apply directly to fusion of imprecise belief structures within TBM as well if the user prefers to adopt TBM rather than DS_mT.

Before presenting the general formula for the combination of generalized imprecise belief structures, we remind the following set operators involved in the DS_m fusion formulas. Several numerical examples are given in the chapter 6 of [32].

- **Addition of sets**

$$S_1 \boxplus S_2 = S_2 \boxplus S_1 \triangleq \{x \mid x = s_1 + s_2, s_1 \in S_1, s_2 \in S_2\}$$

- **Subtraction of sets**

$$S_1 \boxminus S_2 \triangleq \{x \mid x = s_1 - s_2, s_1 \in S_1, s_2 \in S_2\}$$

- **Multiplication of sets**

$$S_1 \boxtimes S_2 \triangleq \{x \mid x = s_1 \cdot s_2, s_1 \in S_1, s_2 \in S_2\}$$

- **Division of sets:** If 0 doesn't belong to S_2 ,

$$S_1 \boxdiv S_2 \triangleq \{x \mid x = s_1/s_2, s_1 \in S_1, s_2 \in S_2\}$$

1.2.7.1 DS m rule of combination for imprecise beliefs

We present the generalization of the DS m rules to combine any type of imprecise belief assignment which may be represented by the union of several sub-unitary (half-) open intervals, (half-)closed intervals and/or sets of points belonging to $[0,1]$. Several numerical examples are also given. In the sequel, one uses the notation (a, b) for an open interval, $[a, b]$ for a closed interval, and $(a, b]$ or $[a, b)$ for a half open and half closed interval. From the previous operators on sets, one can generalize the DS m rules (classic and hybrid) from scalars to sets in the following way [32] (chap. 6): $\forall A \neq \emptyset \in D^\Theta$,

$$m^I(A) = \underbrace{\sum}_{\substack{X_1, X_2, \dots, X_k \in D^\Theta \\ (X_1 \cap X_2 \cap \dots \cap X_k) = A}} \underbrace{\prod}_{i=1, \dots, k} m_i^I(X_i) \quad (1.10)$$

where \sum and \prod represent the summation, and respectively product, of sets.

Similarly, one can generalize the hybrid DS m rule from scalars to sets in the following way:

$$m_{DSmH}^I(A) = m_{\mathcal{M}(\Theta)}^I(A) \triangleq \phi(A) \boxtimes \left[S_1^I(A) \boxplus S_2^I(A) \boxplus S_3^I(A) \right] \quad (1.11)$$

where all sets involved in formulas are in the canonical form and $\phi(A)$ is the characteristic non emptiness function of the set A and $S_1^I(A)$, $S_2^I(A)$ and $S_3^I(A)$

are defined by

$$S_1^I(A) \triangleq \sum_{\substack{X_1, X_2, \dots, X_k \in D^\Theta \\ X_1 \cap X_2 \cap \dots \cap X_k = A}} \prod_{i=1, \dots, k} m_i^I(X_i) \quad (1.12)$$

$$S_2^I(A) \triangleq \sum_{\substack{X_1, X_2, \dots, X_k \in \emptyset \\ [A=A] \vee [(A \in \emptyset) \wedge (A=I_t)]}} \prod_{i=1, \dots, k} m_i^I(X_i) \quad (1.13)$$

$$S_3^I(A) \triangleq \sum_{\substack{X_1, X_2, \dots, X_k \in D^\Theta \\ X_1 \cup X_2 \cup \dots \cup X_k = A \\ X_1 \cap X_2 \cap \dots \cap X_k = \emptyset}} \prod_{i=1, \dots, k} m_i^I(X_i) \quad (1.14)$$

In the case when all sets are reduced to points (numbers), the set operations become normal operations with numbers; the sets operations are generalizations of numerical operations. When imprecise belief structures reduce to precise belief structure, DS m rules (1.10) and (1.11) reduce to their precise version (1.4) and (1.5) respectively.

1.2.7.2 Example

Here is a simple example of fusion with multiple-interval masses. For simplicity, this example is a particular case when the theorem of admissibility (see [32] p. 138 for details) is verified by a few points, which happen to be just on the bounders. It is an extreme example, because we tried to comprise all kinds of possibilities which may occur in the imprecise or very imprecise fusion. So, let's consider a fusion problem over $\Theta = \{\theta_1, \theta_2\}$, two independent sources of information with the following imprecise admissible belief assignments

$A \in D^\Theta$	$m_1^I(A)$	$m_2^I(A)$
θ_1	$[0.1, 0.2] \cup \{0.3\}$	$[0.4, 0.5]$
θ_2	$(0.4, 0.6) \cup [0.7, 0.8]$	$[0, 0.4] \cup \{0.5, 0.6\}$

Table 1.3: Inputs of the fusion with imprecise bba's.

Using the DS m classic (DS m C) rule for sets, one gets

$$\begin{aligned} m^I(\theta_1) &= ([0.1, 0.2] \cup \{0.3\}) \boxtimes [0.4, 0.5] \\ &= ([0.1, 0.2] \boxtimes [0.4, 0.5]) \cup (\{0.3\} \boxtimes [0.4, 0.5]) \\ &= [0.04, 0.10] \cup [0.12, 0.15] \end{aligned}$$

$$\begin{aligned}
m^I(\theta_2) &= ((0.4, 0.6) \cup [0.7, 0.8]) \boxminus ([0, 0.4] \cup \{0.5, 0.6\}) \\
&= ((0.4, 0.6) \boxminus [0, 0.4]) \cup ((0.4, 0.6) \boxminus \{0.5, 0.6\}) \\
&\quad \cup ([0.7, 0.8] \boxminus [0, 0.4]) \cup ([0.7, 0.8] \boxminus \{0.5, 0.6\}) \\
&= (0, 0.24) \cup (0.20, 0.30) \cup (0.24, 0.36) \cup [0, 0.32] \\
&\quad \cup [0.35, 0.40] \cup [0.42, 0.48] = [0, 0.40] \cup [0.42, 0.48]
\end{aligned}$$

$$\begin{aligned}
m^I(\theta_1 \cap \theta_2) &= [([0.1, 0.2] \cup \{0.3\}) \boxminus ([0, 0.4] \cup \{0.5, 0.6\})] \boxplus [[0.4, 0.5] \\
&\quad \boxminus ((0.4, 0.6) \cup [0.7, 0.8])] \\
&= [([0.1, 0.2] \boxminus [0, 0.4]) \cup ([0.1, 0.2] \boxminus \{0.5, 0.6\}) \\
&\quad \cup (\{0.3\} \boxminus [0, 0.4]) \cup (\{0.3\} \boxminus \{0.5, 0.6\})] \\
&\quad \boxplus [([0.4, 0.5] \boxminus (0.4, 0.6)) \cup ([0.4, 0.5] \boxminus [0.7, 0.8])] \\
&= [[0, 0.08] \cup [0.05, 0.10] \cup [0.06, 0.12] \cup [0, 0.12] \\
&\quad \cup \{0.15, 0.18\}] \boxplus [(0.16, 0.30) \cup [0.28, 0.40]] \\
&= [[0, 0.12] \cup \{0.15, 0.18\}] \boxplus (0.16, 0.40) \\
&= (0.16, 0.52] \cup (0.31, 0.55] \cup (0.34, 0.58] = (0.16, 0.58]
\end{aligned}$$

Hence finally the fusion admissible result with DSMT rule is given by:

$A \in D^\Theta$	$m^I(A) = [m_1^I \oplus m_2^I](A)$
θ_1	$[0.04, 0.10] \cup [0.12, 0.15]$
θ_2	$[0, 0.40] \cup [0.42, 0.48]$
$\theta_1 \cap \theta_2$	$(0.16, 0.58]$
$\theta_1 \cup \theta_2$	0

Table 1.4: Fusion result with the DSMT rule.

If one finds out⁶ that $\theta_1 \cap \theta_2 \stackrel{\mathcal{M}}{\equiv} \emptyset$ (this is our hybrid model \mathcal{M} one wants to deal with), then one uses the hybrid DSMT rule (1.11) for sets: $m_{\mathcal{M}}^I(\theta_1 \cap \theta_2) = 0$ and $m_{\mathcal{M}}^I(\theta_1 \cup \theta_2) = (0.16, 0.58]$, the others imprecise masses are not changed.

With the hybrid DSMT rule (DSMT) applied to imprecise beliefs, one gets now the results given in Table 1.5.

⁶We consider now a dynamic fusion problem.

$A \in D^\Theta$	$m_{\mathcal{M}}^I(A) = [m_1^I \oplus m_2^I](A)$
θ_1	$[0.04, 0.10] \cup [0.12, 0.15]$
θ_2	$[0, 0.40] \cup [0.42, 0.48]$
$\theta_1 \cap \theta_2 \stackrel{\mathcal{M}}{\equiv} \emptyset$	0
$\theta_1 \cup \theta_2$	$(0.16, 0.58]$

Table 1.5: Fusion result with DS*m*H rule for \mathcal{M} .

Let's check now the admissibility condition. For the source 1, there exist the precise masses $(m_1(\theta_1) = 0.3) \in ([0.1, 0.2] \cup \{0.3\})$ and $(m_1(\theta_2) = 0.7) \in ((0.4, 0.6) \cup [0.7, 0.8])$ such that $0.3 + 0.7 = 1$. For the source 2, there exist the precise masses $(m_1(\theta_1) = 0.4) \in ([0.4, 0.5])$ and $(m_2(\theta_2) = 0.6) \in ([0, 0.4] \cup \{0.5, 0.6\})$ such that $0.4 + 0.6 = 1$. Therefore both sources associated with $m_1^I(\cdot)$ and $m_2^I(\cdot)$ are admissible imprecise sources of information. It can be verified that DS*m*C fusion of $m_1(\cdot)$ and $m_2(\cdot)$ yields the paradoxical bba $m(\theta_1) = [m_1 \oplus m_2](\theta_1) = 0.12$, $m(\theta_2) = [m_1 \oplus m_2](\theta_2) = 0.42$ and $m(\theta_1 \cap \theta_2) = [m_1 \oplus m_2](\theta_1 \cap \theta_2) = 0.46$. One sees that the admissibility condition is satisfied since $(m(\theta_1) = 0.12) \in (m^I(\theta_1) = [0.04, 0.10] \cup [0.12, 0.15])$, $(m(\theta_2) = 0.42) \in (m^I(\theta_2) = [0, 0.40] \cup [0.42, 0.48])$ and $(m(\theta_1 \cap \theta_2) = 0.46) \in (m^I(\theta_1 \cap \theta_2) = (0.16, 0.58])$ such that $0.12 + 0.42 + 0.46 = 1$. Similarly if one finds out that $\theta_1 \cap \theta_2 = \emptyset$, then one uses DS*m*H rule and one gets: $m(\theta_1 \cap \theta_2) = 0$ and $m(\theta_1 \cup \theta_2) = 0.46$; the others remain unchanged. The admissibility condition still holds, because one can pick at least one number in each subset $m^I(\cdot)$ such that the sum of these numbers is 1.

1.3 Proportional Conflict Redistribution rule

Instead of applying a direct transfer of partial conflicts onto partial uncertainties as with DS*m*H, the idea behind the Proportional Conflict Redistribution (PCR) rule [34, 36] is to transfer (total or partial) conflicting masses to non-empty sets involved in the conflicts proportionally with respect to the masses assigned to them by sources as follows:

1. calculation the conjunctive rule of the belief masses of sources;
2. calculation the total or partial conflicting masses;
3. redistribution of the (total or partial) conflicting masses to the non-empty sets involved in the conflicts proportionally with respect to their masses assigned by the sources.

The way the conflicting mass is redistributed yields actually several versions of PCR rules. These PCR fusion rules work for any degree of conflict, for any DSMT models (Shafer's model, free DSMT model or any hybrid DSMT model) and both in DST and DSMT frameworks for static or dynamical fusion situations. We present below only the most sophisticated proportional conflict redistribution rule denoted PCR5 in [34, 36]. PCR5 rule is what we feel the most efficient PCR fusion rule developed so far. This rule redistributes the partial conflicting mass to the elements involved in the partial conflict, considering the conjunctive normal form of the partial conflict. PCR5 is what we think the most mathematically exact redistribution of conflicting mass to non-empty sets following the logic of the conjunctive rule. It does a better redistribution of the conflicting mass than Dempster's rule since PCR5 goes backwards on the tracks of the conjunctive rule and redistributes the conflicting mass only to the sets involved in the conflict and proportionally to their masses put in the conflict. PCR5 rule is quasi-associative and preserves the neutral impact of the vacuous belief assignment because in any partial conflict, as well in the total conflict (which is a sum of all partial conflicts), the conjunctive normal form of each partial conflict does not include Θ since Θ is a neutral element for intersection (conflict), therefore Θ gets no mass after the redistribution of the conflicting mass. We have proved in [36] the continuity property of the fusion result with continuous variations of bba's to combine.

1.3.1 PCR formulas

The PCR5 formula for the combination of two sources ($s = 2$) is given by: $m_{PCR5}(\emptyset) = 0$ and $\forall X \in G^\Theta \setminus \{\emptyset\}$

$$m_{PCR5}(X) = m_{12}(X) + \sum_{\substack{Y \in G^\Theta \setminus \{X\} \\ X \cap Y = \emptyset}} \left[\frac{m_1(X)^2 m_2(Y)}{m_1(X) + m_2(Y)} + \frac{m_2(X)^2 m_1(Y)}{m_2(X) + m_1(Y)} \right] \quad (1.15)$$

where all sets involved in formulas are in canonical form and where G^Θ corresponds to classical power set 2^Θ if Shafer's model is used, or to a constrained hyper-power set D^Θ if any other hybrid DSMT model is used instead, or to the super-power set S^Θ if the minimal refinement Θ^{ref} of Θ is used; $m_{12}(X) \equiv m_\cap(X)$ corresponds to the conjunctive consensus on X between the $s = 2$ sources and where all denominators are different from zero. If a denominator is zero, that fraction is discarded.

A general formula of PCR5 for the fusion of $s > 2$ sources has been proposed in [36], but a more intuitive PCR formula (denoted PCR6) which provides good

results in practice has been proposed by Martin and Osswald in [36] (pages 69-88) and is given by: $m_{PCR6}(\emptyset) = 0$ and $\forall X \in G^\Theta \setminus \{\emptyset\}$

$$m_{PCR6}(X) = m_{12\dots s}(X) + \sum_{\substack{\bigcap_{k=1}^{s-1} Y_{\sigma_i(k)} \cap X \equiv \emptyset \\ (Y_{\sigma_i(1)}, \dots, Y_{\sigma_i(s-1)}) \in (G^\Theta)^{s-1}}} \left(\frac{\prod_{j=1}^{s-1} m_{\sigma_i(j)}(Y_{\sigma_i(j)})}{m_i(X) + \sum_{j=1}^{s-1} m_{\sigma_i(j)}(Y_{\sigma_i(j)})} \right) \quad (1.16)$$

where σ_i counts from 1 to s avoiding i :

$$\begin{cases} \sigma_i(j) = j & \text{if } j < i, \\ \sigma_i(j) = j + 1 & \text{if } j \geq i, \end{cases} \quad (1.17)$$

Since Y_i is a focal element of expert/source i , $m_i(X) + \sum_{j=1}^{s-1} m_{\sigma_i(j)}(Y_{\sigma_i(j)}) \neq 0$; the belief mass assignment $m_{12\dots s}(X) \equiv m_\cap(X)$ corresponds to the conjunctive consensus on X between the $s > 2$ sources. For two sources ($s = 2$), PCR5 and PCR6 formulas coincide.

1.3.2 Examples

- **Example 1:** Let's take $\Theta = \{A, B\}$ of exclusive elements (Shafer's model), and the following bba:

	A	B	$A \cup B$
$m_1(\cdot)$	0.6	0	0.4
$m_2(\cdot)$	0	0.3	0.7
$m_\cap(\cdot)$	0.42	0.12	0.28

The conflicting mass is $k_{12} = m_\cap(A \cap B)$ and equals $m_1(A)m_2(B) + m_1(B)m_2(A) = 0.18$. Therefore A and B are the only focal elements involved in the conflict. Hence according to the PCR5 hypothesis only A and B deserve a part of the conflicting mass and $A \cup B$ do not deserve. With PCR5, one redistributes the conflicting mass $k_{12} = 0.18$ to A and B proportionally with the masses $m_1(A)$ and $m_2(B)$ assigned to A and B respectively.

Here are the results obtained from Dempster's rule, DS_mH and PCR5:

	A	B	$A \cup B$
m_{DS}	0.512	0.146	0.342
m_{DSmH}	0.420	0.120	0.460
m_{PCR5}	0.540	0.180	0.280

- **Example 2:** Let's modify example 1 and consider

	A	B	$A \cup B$
$m_1(\cdot)$	0.6	0	0.4
$m_2(\cdot)$	0.2	0.3	0.5
$m_{\cap}(\cdot)$	0.50	0.12	0.20

The conflicting mass $k_{12} = m_{\cap}(A \cap B)$ as well as the distribution coefficients for the PCR5 remains the same as in the previous example but one gets now

	A	B	$A \cup B$
m_{DS}	0.609	0.146	0.231
m_{DSmH}	0.500	0.120	0.380
m_{PCR5}	0.620	0.180	0.200

- **Example 3:** Let's modify example 2 and consider

	A	B	$A \cup B$
$m_1(\cdot)$	0.6	0.3	0.1
$m_2(\cdot)$	0.2	0.3	0.5
$m_{\cap}(\cdot)$	0.44	0.27	0.05

The conflicting mass $k_{12} = 0.24 = m_1(A)m_2(B) + m_1(B)m_2(A) = 0.24$ is now different from previous examples, which means that $m_2(A) = 0.2$ and $m_1(B) = 0.3$ did make an impact on the conflict. Therefore A and B are the only focal elements involved in the conflict and thus only A and B deserve a part of the conflicting mass. PCR5 redistributes the partial conflicting mass 0.18 to A and B proportionally with the masses $m_1(A)$ and $m_2(B)$ and also the partial conflicting mass 0.06 to A and B proportionally with the masses $m_2(A)$ and $m_1(B)$. After all derivations (see [14] for details), one finally gets:

	A	B	$A \cup B$
m_{DS}	0.579	0.355	0.066
m_{DSmH}	0.440	0.270	0.290
m_{PCR5}	0.584	0.366	0.050

One clearly sees that $m_{DS}(A \cup B)$ gets some mass from the conflicting mass although $A \cup B$ does not deserve any part of the conflicting mass (according to PCR5 hypothesis) since $A \cup B$ is not involved in the conflict (only A and B are involved in the conflicting mass). Dempster's rule appears to us less exact than PCR5 and Inagaki's rules [16]. It can be showed [14] that Inagaki's fusion rule (with an optimal choice of tuning parameters) can become in some cases very close to PCR5 but upon our opinion PCR5 result is more exact (at least less ad-hoc than Inagaki's one).

- **Example 4 (A more concrete example):** Three people, John (J), George (G), and David (D) are suspects to a murder. So the frame of discernment is $\Theta \triangleq \{J, G, D\}$. Two sources $m_1(\cdot)$ and $m_2(\cdot)$ (witnesses) provide the following information:

	J	G	D
m_1	0.9	0	0.1
m_2	0	0.8	0.2

We know that John and George are friends, but John and David hate each other, and similarly George and David.

- Free model, i. e. all intersections are nonempty: $J \cap G \neq \emptyset$, $J \cap D \neq \emptyset$, $G \cap D \neq \emptyset$, $J \cap G \cap D \neq \emptyset$. Using the DSm classic rule one gets:

	J	G	D	$J \cap G$	$J \cap D$	$G \cap D$	$J \cap G \cap D$
m_{DSmC}	0	0	0.02	0.72	0.18	0.08	0

So we can see that John and George together ($J \cap G$) are most likely to have committed the crime, since the mass $m_{DSmC}(J \cap G) = 0.72$ is the biggest resulting mass after the fusion of the two sources. In Shafer's model, only one suspect could commit the crime, but the free and hybrid models allow two or more people to have committed the same crime - which happens in reality.

- b) Let's consider the hybrid model, i. e. some intersections are empty, and others are not. According to the above statement about the relationships between the three suspects, we can deduce that $J \cap G \neq \emptyset$, while $J \cap D = G \cap D = J \cap G \cap D = \emptyset$. Then we first apply the DSMT Classic rule, and then the transfer of the conflicting masses is done with PCR5:

	J	G	D	$J \cap G$	$J \cap D$	$G \cap D$	$J \cap G \cap D$
m_1	0.9	0	0.1				
m_2	0	0.8	0.2				
m_{DSmC}	0	0	0.02	0.72	0.18	0.08	0

Using PCR5 now we transfer $m(J \cap D) = 0.18$, since $J \cap D = \emptyset$, to J and D proportionally with 0.9 and 0.2 respectively, so J gets 0.15 and D gets 0.03 since:

$$xJ/0.9 = zD/0.2 = 0.18/(0.9 + 0.2) = 0.18/1.1$$

whence $xJ = 0.9(0.18/1.1) = 0.15$ and $zD = 0.2(0.18/1.1) = 0.03$. Again using PCR5, we transfer $m(G \cap D) = 0.08$, since $G \cap D = \emptyset$, to G and D proportionally with 0.8 and 0.1 respectively, so G gets 0.07 and D gets 0.01 since:

$$yG/0.8 = zD/0.1 = 0.08/(0.8 + 0.1) = 0.08/0.9$$

whence $yG = 0.8(0.08/0.9) = 0.07$ and $zD = 0.1(0.08/0.9) = 0.01$. Adding we get finally:

	J	G	D	$J \cap G$	$J \cap D$	$G \cap D$	$J \cap G \cap D$
m_{PCR5}	0.15	0.07	0.06	0.72	0	0	0

So one has a high belief that the criminals are John and George (both of them committed the crime) since $m(J \cap D) = 0.72$ and it is by far the greatest fusion mass.

In Shafer's model, if we try to refine we get the disjoint parts: D , $J \cap G$, $J \setminus (J \cap G)$, and $G \setminus (J \cap G)$, but the last two are ridiculous (what is the real/physical nature of $J \setminus (J \cap G)$ or $G \setminus (J \cap G)$? Half of a person(!) ?), so the refining does not work here in reality. That's why the hybrid and free models are needed.

- **Example 5 (Imprecise PCR5):** The PCR5 formula can naturally work also for the combination of imprecise bba's. This has been already presented in section 1.11.8 page 49 of [36] with a numerical example to show how to apply it. This example will therefore not be reincluded here.

1.3.3 Zadeh's example

We compare here the solutions for well-known Zadeh's example [55, 58] provided by several fusion rules. A detailed presentation with more comparisons can be found in [32, 36]. Let's consider $\Theta = \{M, C, T\}$ as the frame of three potential origins about possible diseases of a patient (M standing for meningitis, C for concussion and T for tumor), the Shafer's model and the two following belief assignments provided by two independent doctors after examination of the same patient.

$$\begin{array}{lll} m_1(M) = 0.9 & m_1(C) = 0 & m_1(T) = 0.1 \\ m_2(M) = 0 & m_2(C) = 0.9 & m_2(T) = 0.1 \end{array}$$

The total conflicting mass is high since it is

$$m_1(M)m_2(C) + m_1(M)m_2(T) + m_2(C)m_1(T) = 0.99$$

- with Dempster's rule and Shafer's model (DS), one gets the counter-intuitive result (see justifications in [12, 32, 48, 52, 55]): $m_{DS}(T) = 1$
- with Yager's rule [52] and Shafer's model: $m_Y(M \cup C \cup T) = 0.99$ and $m_Y(T) = 0.01$
- with DS mH and Shafer's model:

$$m_{DSmH}(M \cup C) = 0.81 \quad m_{DSmH}(T) = 0.01$$

$$m_{DSmH}(M \cup T) = m_{DSmH}(C \cup T) = 0.09$$

- The Dubois & Prade's rule (DP) [12] based on Shafer's model provides in Zadeh's example the same result as DS mH , because DP and DS mH coincide in all static fusion problems⁷.
- with PCR5 and Shafer's model: $m_{PCR5}(M) = m_{PCR5}(C) = 0.486$ and $m_{PCR5}(T) = 0.028$.

One sees that when the total conflict between sources becomes high, DS mT is able (upon authors opinion) to manage more adequately through DS mH or PCR5 rules the combination of information than Dempster's rule, even when working with Shafer's model - which is only a specific hybrid model. DS mH rule is in agreement with DP rule for the static fusion, but DS mH and DP rules

⁷Indeed DP rule has been developed for static fusion only while DS mH has been developed to take into account the possible dynamicity of the frame itself and also its associated model.

differ in general (for non degenerate cases) for dynamic fusion while PCR5 rule is the most exact proportional conflict redistribution rule. Besides this particular example, we showed in [32] that there exist several infinite classes of counter-examples to Dempster's rule which can be solved by DSMT.

In summary, DST based on Dempster's rule provides counter-intuitive results in Zadeh's example, or in non-Bayesian examples similar to Zadeh's and no result when the conflict is 1. Only ad-hoc discounting techniques allow to circumvent troubles of Dempster's rule or we need to switch to another model of representation/frame; in the later case the solution obtained doesn't fit with the Shafer's model one originally wanted to work with. We want also to emphasize that in dynamic fusion when the conflict becomes high, both DST [25] and Smets' Transferable Belief Model (TBM) [41] approaches fail to respond to new information provided by new sources. This can be easily showed by the very simple following example.

Example (where TBM doesn't respond to new information):

Let $\Theta = \{A, B, C\}$ with the (precise) bba's $m_1(A) = 0.4$, $m_1(C) = 0.6$ and $m_2(A) = 0.7$, $m_2(B) = 0.3$. Then one gets⁸ with Dempster's rule, Smets' TBM (i.e. the non-normalized version of Dempster's combination), DSMT and PCR5: $m_{DS}^{12}(A) = 1$, $m_{TBM}^{12}(A) = 0.28$, $m_{TBM}^{12}(\emptyset) = 0.72$,

$$\begin{cases} m_{DSmH}^{12}(A) = 0.28 \\ m_{DSmH}^{12}(A \cup B) = 0.12 \\ m_{DSmH}^{12}(A \cup C) = 0.42 \\ m_{DSmH}^{12}(B \cup C) = 0.18 \end{cases}$$

$$\begin{cases} m_{PCR5}^{12}(A) = 0.574725 \\ m_{PCR5}^{12}(B) = 0.111429 \\ m_{PCR5}^{12}(C) = 0.313846 \end{cases}$$

Now let's consider a temporal fusion problem and introduce a third source $m_3(\cdot)$ with $m_3(B) = 0.8$ and $m_3(C) = 0.2$. Then one sequentially combines the results obtained by $m_{TBM}^{12}(\cdot)$, $m_{DS}^{12}(\cdot)$, $m_{DSmH}^{12}(\cdot)$ and $m_{PCR}^{12}(\cdot)$ with the new evidence $m_3(\cdot)$ and one sees that $m_{DS}^{(12)3}$ becomes not defined (division by

⁸We introduce here explicitly the indexes of sources in the fusion result since more than two sources are considered in this example.

zero) and $m_{TBM}^{(12)3}(\emptyset) = 1$ while (DS mH) and (PCR5) provide

$$\begin{cases} m_{DSmH}^{(12)3}(B) = 0.240 \\ m_{DSmH}^{(12)3}(C) = 0.120 \\ m_{DSmH}^{(12)3}(A \cup B) = 0.224 \\ m_{DSmH}^{(12)3}(A \cup C) = 0.056 \\ m_{DSmH}^{(12)3}(A \cup B \cup C) = 0.360 \end{cases}$$

$$\begin{cases} m_{PCR5}^{(12)3}(A) = 0.277490 \\ m_{PCR5}^{(12)3}(B) = 0.545010 \\ m_{PCR5}^{(12)3}(C) = 0.177500 \end{cases}$$

When the mass committed to empty set becomes one at a previous temporal fusion step, then both DST and TBM do not respond to new information⁹. Let's continue the example and consider a fourth source $m_4(\cdot)$ with $m_4(A) = 0.5$, $m_4(B) = 0.3$ and $m_4(C) = 0.2$. Then it is easy to see that $m_{DS}^{((12)3)4}(\cdot)$ is not defined since at previous step $m_{DS}^{(12)3}(\cdot)$ was already not defined, and that $m_{TBM}^{((12)3)4}(\emptyset) = 1$ whatever $m_4(\cdot)$ is because at the previous fusion step one had $m_{TBM}^{(12)3}(\emptyset) = 1$. Therefore for a number of sources $n \geq 2$, DST and TBM approaches do not respond to new information incoming in the fusion process while both (DS mH) and (PCR5) rules respond to new information. To make DST and/or TBM working properly in such cases, it is necessary to introduce ad-hoc temporal discounting techniques which are not necessary to introduce if DS mT is adopted. If there are good reasons to introduce temporal discounting, there is obviously no difficulty to apply the DS m fusion of these discounted sources. An analysis of this behavior for target type tracking is presented in [10, 36].

1.4 Uniform and partially uniform redistribution rules

The principles of Uniform Redistribution Rule (URR) and Partially Uniform Redistribution Rule (PURR) have been proposed in 2006 with examples in [35].

⁹Actually Dempster's rule doesn't respond also to new compatible information/bba as soon as a total mass of belief is already committed by a source to only one focal element. For example, if one considers $\Theta = \{A, B\}$ with Shafer's model ($A \cap B = \emptyset$) and with $m_1(A) = 1$, $m_2(A) = 0.2$ and $m_2(B) = 0.8$, then Dempster's rule always provides $m_{DS}(A) = 1$ whatever are the values taken by $m_2(A) > 0$ and $m_2(B) > 0$.

The Uniform Redistribution Rule consists in redistributing the total conflicting mass k_{12} to all focal elements of G^\ominus generated by the consensus operator. This way of redistributing mass is very simple and URR is different from Dempster's rule of combination, because Dempster's rule redistributes the total conflict proportionally with respect to the masses resulted from the conjunctive rule of non-empty sets. PCR5 rule presented in section 1.3 does proportional redistributions of partial conflicting masses to the sets involved in the conflict. The URR formula for two sources is given by: $\forall A \neq \emptyset$

$$m_{12URR}(A) = m_{12}(A) + \frac{1}{n_{12}} \sum_{\substack{X_1, X_2 \in G^\ominus \\ X_1 \cap X_2 = \emptyset}} m_1(X_1)m_2(X_2) \quad (1.18)$$

where $m_{12}(A)$ is the result of the conjunctive rule applied to belief assignments $m_1(\cdot)$ and $m_2(\cdot)$, and $n_{12} = \text{Card}\{Z \in G^\ominus, m_1(Z) \neq 0 \text{ or } m_2(Z) \neq 0\}$.

For $s \geq 2$ sources to combine: $\forall A \neq \emptyset$, one has

$$m_{12\dots sURR}(A) = m_{12\dots s}(A) + \frac{1}{n_{12\dots s}} \sum_{\substack{X_1, X_2, \dots, X_s \in G^\ominus \\ X_1 \cap X_2 \cap \dots \cap X_s = \emptyset}} \prod_{i=1}^s m_i(X_i) \quad (1.19)$$

where $m_{12\dots s}(A)$ is the result of the conjunctive rule applied to $m_i(\cdot)$, for all $i \in \{1, 2, \dots, s\}$ and

$$n_{12\dots s} = \text{Card}\{Z \in G^\ominus, m_1(Z) \neq 0 \text{ or } m_2(Z) \neq 0 \text{ or } \dots \text{ or } m_s(Z) \neq 0\}$$

As alternative (modified version of URR), we can also consider the cardinal of the ensemble of sets whose masses resulted from the conjunctive rule are non-null, i.e. the cardinality of the core of conjunctive consensus:

$$n_{12\dots s}^c = \text{Card}\{Z \in G^\ominus, m_{12\dots s}(Z) \neq 0\}$$

It is also possible to do a uniformly partial redistribution, i.e. to uniformly redistribute the conflicting mass only to the sets involved in the conflict. For example, if $m_{12}(A \cap B) = 0.08$ and $A \cap B = \emptyset$, then 0.08 is equally redistributed to A and B only, supposing A and B are both non-empty, so 0.04 assigned to A and 0.04 to B .

The Partially Uniform Redistribution Rule (PURR) for two sources is defined as follows: $\forall A \neq \emptyset$

$$m_{12PURR}(A) = m_{12}(A) + \frac{1}{2} \sum_{\substack{X_1, X_2 \in G^\Theta \\ X_1 \cap X_2 = \emptyset \\ X_1 = A \text{ or } X_2 = A}} m_1(X_1)m_2(X_2) \quad (1.20)$$

where $m_{12}(A)$ is the result of the conjunctive rule applied to belief assignments $m_1(\cdot)$ and $m_2(\cdot)$.

For $s \geq 2$ sources to combine: $\forall A \neq \emptyset$, one has

$$m_{12\dots sPURR}(A) = m_{12\dots s}(A) + \frac{1}{s} \sum_{\substack{X_1, X_2, \dots, X_s \in G^\Theta \\ X_1 \cap X_2 \cap \dots \cap X_s = \emptyset \\ \text{at least one } X_j = A, j \in \{1, \dots, s\}}} \text{Card}_A(\{X_1, \dots, X_s\}) \prod_{i=1}^s m_1(X_i) \quad (1.21)$$

where $\text{Card}_A(\{X_1, \dots, X_s\})$ is the number of A 's occurring in $\{X_1, X_2, \dots, X_s\}$.

If $A = \emptyset$, $m_{12PURR}(A) = 0$ and $m_{12\dots sPURR}(A) = 0$.

These rules have a low computation cost with respect to Proportional Conflict Redistribution (PCR) rules developed in the DSMT framework and they preserve the neutrality of the vacuous belief assignment (VBA) since any bba $m_1(\cdot)$ combined with VBA defined on any frame $\Theta = \{\theta_1, \dots, \theta_n\}$ by $m_{VBA}(\theta_1 \cup \dots \cup \theta_n) = 1$, using the conjunctive rule, gives $m_1(\cdot)$, so no conflicting mass is needed to transfer. Of course these rules are very easy to implement but from a theoretical point of view they remain less precise in their transfer of conflicting beliefs since they do not take into account the proportional redistribution with respect to the mass of each set involved in the conflict. Reasonably, URR or PURR cannot outperform PCR5 but they may hopefully could appear as good enough in some specific fusion problems when the level of total conflict is not important. PURR does a more refined redistribution than URR and MURR but it requires a little more calculation.

1.5 RSC Fusion rules

In this section, we briefly¹⁰ recall a new class of fusion rules based on the belief redistribution to subsets or complements and denoted CRSC (standing for Class of Redistribution rules to Subsets or Complements) for short.

¹⁰This class is presented in details in chapter 5 of this volume with several examples.

Let $m_1(\cdot)$ and $m_2(\cdot)$ be two normalized basic belief assignments (bba's) defined¹¹ from S^Θ to $[0, 1]$. We use the conjunctive rule to first combine $m_1(\cdot)$ with $m_2(\cdot)$ to get $m_\cap(\cdot)$ and then the mass of conflict say $m_\cap(X \cap Y) = 0$, when $X \cap Y = \emptyset$ or even when $X \cap Y$ is different from the empty set is redistributed to subsets or complements in many ways (see chapter 5 for details). The new class of fusion rule (denoted $CRSC_c$) for transferring the conflicting masses only is defined for $A \in S^\Theta \setminus \{\emptyset, I_t\}$ by:

$$m_{CRSC_c}(A) = m_\cap(A) + [\alpha \cdot m_\cap(A) + \beta \cdot Card(A) + \gamma \cdot f(A)] \cdot \sum_{\substack{X, Y \in S^\Theta \\ X \cap Y = \emptyset \\ A \subseteq M}} \frac{m_1(X)m_2(Y)}{\sum_{Z \in S^\Theta, Z \subseteq M} [\alpha \cdot m_\cap(Z) + \beta \cdot Card(Z) + \gamma \cdot f(Z)]} \quad (1.22)$$

where $I_t = \theta_1 \cup \theta_2 \cup \dots \cup \theta_n$ represents the total ignorance when $\Theta = \{\theta_1, \dots, \theta_n\}$. M can be $c(X \cup Y)$ (the complement of $X \cup Y$), or a subset of $c(X \cup Y)$, or $X \cup Y$, or a subset of $X \cup Y$; $\alpha, \beta, \gamma \in \{0, 1\}$ but $\alpha + \beta + \gamma \neq 0$; in a weighted way we can take $\alpha, \beta, \gamma \in [0, 1]$ also with $\alpha + \beta + \gamma \neq 0$; $f(X)$ is a function of X , i.e. another parameter that the mass of X is directly proportionally with respect to; $Card(X)$ is the cardinal of X .

The mass of belief $m_{CRSC_c}(I_t)$ committed to the total ignorance is given by:

$$m_{CRSC_c}(I_t) = m_\cap(I_t) + \sum_{\substack{X, Y \in S^\Theta \\ \{X \cap Y = \emptyset \text{ and } M = \emptyset\} \\ \text{or } \{X \cap Y = \emptyset \text{ and } Den(Z) = 0\}}} m_1(X)m_2(Y) \quad (1.23)$$

where $Den(Z) \triangleq \sum_{Z \in S^\Theta, Z \subseteq M} [\alpha \cdot m_\cap(Z) + \beta \cdot Card(Z) + \gamma \cdot f(Z)]$.

A more general formula for the redistribution of conflict and non-conflict to subsets or complements class of rules for the fusion of masses of belief for two sources of evidence is defined $A \in (S^\Theta \setminus S_\cap^{non\emptyset}) \setminus \{\emptyset, \Theta\}$ by:

$$m_{CRSC}(A) = m_\cap(A) + \sum_{\substack{X, Y \in S^\Theta \\ \{X \cap Y = \emptyset, A \in T(X, Y)\} \\ \text{or } \{X \cap Y \in S_{\cap, r}^{non\emptyset}, A \in T'(X, Y)\}}} f(A) \frac{m_1(X)m_2(Y)}{\sum_{Z \in T(X, Y)} f(Z)} \quad (1.24)$$

¹¹Since these rules use explicitly the complementation operator $c(\cdot)$, they apply only with the super-power set S^Θ or on 2^Θ depending on the underlying model chosen for the frame Θ .

and for $A = I_t$:

$$m_{CRSC}(I_t) = m_{\cap}(I_t) + \sum_{\substack{X, Y \in S^{\ominus} \\ X \cap Y = \emptyset, \\ \{T(X, Y) = \emptyset \text{ or } \sum_{Z \in T(X, Y)} f(Z) = 0\}}} m_1(X)m_2(Y) \quad (1.25)$$

where $S_{\cap} = \{X \in S^{\ominus} | X = Y \cap Z, \text{ where } Y, Z \in S^{\ominus} \setminus \{\emptyset\}\}$, all propositions are expressed in their canonical form and where X contains at least an \cap symbol in its expression; S_{\cap}^{\emptyset} be the set of all empty intersections from S_{\cap} (i.e. the set of exclusivity constraints), and $S_{\cap}^{non\emptyset}$ the set of all non-empty intersections from S_{\cap} . $S_{\cap, r}^{non\emptyset}$ is the set of all non-empty intersections from $S_{\cap}^{non\emptyset}$ whose masses are redistributed to other sets/propositions. The set $S_{\cap, r}^{non\emptyset}$ highly depends on the model for the frame of the application under consideration. $f(\cdot)$ is a mapping from S^{\ominus} to \mathbb{R}^+ . For example, we can choose $f(X) = m_{\cap}(X)$, $f(X) = |X|$, $f^T(X) = \frac{|X|}{|T(X, Y)|}$, or $f(x) = m_{\cap}(X) + |X|$, etc. The function T specifies a subset of S^{\ominus} , for example $T(X, Y) = \{c(X \cup Y)\}$, or $T(X, Y) = \{X \cup Y\}$ or can specify a set of subsets of S^{\ominus} . For example, $T(X, Y) = \{A \subset c(X \cup Y)\}$, or $T(X, Y) = \{A \subset X \cup Y\}$. The function T' is a subset of S^{\ominus} , for example $T'(X, Y) = \{X \cup Y\}$, or T' is a subset of $X \cup Y$, etc.

It is important to highlight that in formulas (1.22)-(1.23) one transfers only the conflicting masses, whereas the formulas (1.24)-(1.25) are more general since one transfers the conflicting masses or the non-conflicting masses as well depending on the preferences of the fusion system designer. The previous formulas have been directly extended for any $s \geq 2$ sources of evidence in chapter 5. All denominators in these CRSC formulas are naturally supposed different from zero. It is worth to note also that the extensions of these rules for including the reliabilities of the sources are also presented in chapter 5 of this volume.

1.6 The generalized pignistic transformation (GPT)

1.6.1 The classical pignistic transformation

We follow here Philippe Smets' vision which considers the management of information as a two 2-levels process: credal (for combination of evidences) and pignistic¹² (for decision-making), i.e. "when someone must take a decision, he/she

¹²Pignistic terminology has been coined by Philippe Smets and comes from pignus, a bet in Latin.

must then construct a probability function derived from the belief function that describes his/her credal state. This probability function is then used to make decisions" [40] (p. 284). One obvious way to build this probability function corresponds to the so-called Classical Pignistic Transformation (CPT) defined in DST framework (i.e. based on the Shafer's model assumption) as [42]:

$$BetP\{A\} = \sum_{X \in 2^\Theta} \frac{|X \cap A|}{|X|} m(X) \quad (1.26)$$

where $|A|$ denotes the cardinality of the set A (with convention $|\emptyset|/|\emptyset| = 1$, to define $BetP\{\emptyset\}$). Decisions are achieved by computing the expected utilities of the acts using the subjective/pignistic $BetP\{.\}$ as the probability function needed to compute expectations. Usually, one uses the maximum of the pignistic probability as decision criterion. The maximum of $BetP\{.\}$ is often considered as a prudent betting decision criterion between the two other alternatives (max of plausibility or max. of credibility which appears to be respectively too optimistic or too pessimistic). It is easy to show that $BetP\{.\}$ is indeed a probability function (see [41]).

1.6.2 Notion of DSMT cardinality

One important notion involved in the definition of the Generalized Pignistic Transformation (GPT) is the DSMT cardinality. The DSMT cardinality of any element A of hyper-power set D^Θ , denoted $\mathcal{C}_M(A)$, corresponds to the number of parts of A in the corresponding fuzzy/vague Venn diagram of the problem (model \mathcal{M}) taking into account the set of integrity constraints (if any), i.e. all the possible intersections due to the nature of the elements θ_i . This intrinsic cardinality depends on the model \mathcal{M} (free, hybrid or Shafer's model). \mathcal{M} is the model that contains A , which depends both on the dimension $n = |\Theta|$ and on the number of non-empty intersections present in its associated Venn diagram (see [32] for details). The DSMT cardinality depends on the cardinal of $\Theta = \{\theta_1, \theta_2, \dots, \theta_n\}$ and on the model of D^Θ (i.e., the number of intersections and between what elements of Θ - in a word the structure) at the same time; it is not necessarily that every singleton, say θ_i , has the same DSMT cardinal, because each singleton has a different structure; if its structure is the simplest (no intersection of this elements with other elements) then $\mathcal{C}_M(\theta_i) = 1$, if the structure is more complicated (many intersections) then $\mathcal{C}_M(\theta_i) > 1$; let's consider a singleton θ_i : if it has 1 intersection only then $\mathcal{C}_M(\theta_i) = 2$, for 2 intersections only $\mathcal{C}_M(\theta_i)$ is 3 or 4 depending on the model \mathcal{M} , for m intersections it is between $m + 1$ and 2^m depending on the model; the maximum DSMT cardinality is 2^{n-1} and occurs for $\theta_1 \cup \theta_2 \cup \dots \cup \theta_n$ in the free model

\mathcal{M}^f ; similarly for any set from D^Θ : the more complicated structure it has, the bigger is the DSMT cardinal; thus the DSMT cardinality measures the complexity of an element from D^Θ , which is a nice characterization in our opinion; we may say that for the singleton θ_i not even $|\Theta|$ counts, but only its structure (= how many other singletons intersect θ_i). Simple illustrative examples are given in Chapter 3 and 7 of [32]. One has $1 \leq \mathcal{C}_M(A) \leq 2^n - 1$. $\mathcal{C}_M(A)$ must not be confused with the classical cardinality $|A|$ of a given set A (i.e. the number of its distinct elements) - that's why a new notation is necessary here. $\mathcal{C}_M(A)$ is very easy to compute by programming from the algorithm of generation of D^Θ given explicated in [32].

Example: let's take back the example of the simple hybrid DSMT model described in section 1.2.2, then one gets the following list of elements (with their DSMT cardinal) for the restricted D^Θ taking into account the integrity constraints of this hybrid model:

$A \in D^\Theta$	$\mathcal{C}_M(A)$
$\alpha_0 \triangleq \emptyset$	0
$\alpha_1 \triangleq \theta_1 \cap \theta_2$	1
$\alpha_2 \triangleq \theta_3$	1
$\alpha_3 \triangleq \theta_1$	2
$\alpha_4 \triangleq \theta_2$	2
$\alpha_5 \triangleq \theta_1 \cup \theta_2$	3
$\alpha_6 \triangleq \theta_1 \cup \theta_3$	3
$\alpha_7 \triangleq \theta_2 \cup \theta_3$	3
$\alpha_8 \triangleq \theta_1 \cup \theta_2 \cup \theta_3$	4

Example of DSMT cardinals: $\mathcal{C}_M(A)$ for hybrid model \mathcal{M} .

1.6.3 The Generalized Pignistic Transformation

To take a rational decision within DSMT framework, it is necessary to generalize the Classical Pignistic Transformation in order to construct a pignistic probability function from any generalized basic belief assignment $m(\cdot)$ drawn from the DSMT rules of combination. Here is the simplest and direct extension of the CPT to define the Generalized Pignistic Transformation:

$$\forall A \in D^\Theta, \quad \text{BetP}\{A\} = \sum_{X \in D^\Theta} \frac{\mathcal{C}_M(X \cap A)}{\mathcal{C}_M(X)} m(X) \quad (1.27)$$

where $\mathcal{C}_{\mathcal{M}}(X)$ denotes the DSMT cardinal of proposition X for the DSMT model \mathcal{M} of the problem under consideration.

The decision about the solution of the problem is usually taken by the maximum of pignistic probability function $BetP\{\cdot\}$. Let's remark the close resemblance of the two pignistic transformations (1.26) and (1.27). It can be shown that (1.27) reduces to (1.26) when the hyper-power set D^{\ominus} reduces to classical power set 2^{\ominus} if we adopt Shafer's model. But (1.27) is a generalization of (1.26) since it can be used for computing pignistic probabilities for any models (including Shafer's model). It has been proved in [32] (Chap. 7) that $BetP\{\cdot\}$ defined in (1.27) is indeed a probability distribution. In the following section, we introduce a new alternative to BetP which is presented in details in the chapter 3 of this volume.

1.7 The DSMT transformation

In the theories of belief functions, the mapping from the belief to the probability domain is a controversial issue. The original purpose of such mappings was to make (hard) decision, but contrariwise to erroneous widespread idea/-claim, this is not the only interest for using such mappings nowadays. Actually the probabilistic transformations of belief mass assignments (as the pignistic transformation mentioned previously) are for example very useful in modern multitarget multisensor tracking systems (or in any other systems) where one deals with soft decisions (i.e. where all possible solutions are kept for state estimation with their likelihoods). For example, in a Multiple Hypotheses Tracker using both kinematical and attribute data, one needs to compute all probabilities values for deriving the likelihoods of data association hypotheses and then mixing them altogether to estimate states of targets. Therefore, it is very relevant to use a mapping which provides a high probabilistic information content (PIC) for expecting better performances.

In this section, we briefly recall a new probabilistic transformation, denoted *DSMT* and introduced in [11] which will be explained in details in Chapter 3 of this volume. *DSMT* is straight and different from other transformations. The basic idea of *DSMT* consists in a new way of proportionalizations of the mass of each partial ignorance such as $A_1 \cup A_2$ or $A_1 \cup (A_2 \cap A_3)$ or $(A_1 \cap A_2) \cup (A_3 \cap A_4)$, etc. and the mass of the total ignorance $A_1 \cup A_2 \cup \dots \cup A_n$, to the elements involved in the ignorances. This new transformation takes into account both the values of the masses and the cardinality of elements in the proportional redistribution process. We first remind what PIC criteria is and

then shortly present the general formula for DSMP transformation with few numerical examples. More examples and comparisons with respect to other transformations are given in the chapter 3.

1.7.1 The Probabilistic Information Content (PIC)

Following Sudano's approach [43, 44, 46], we adopt the Probabilistic Information Content (PIC) criterion as a metric depicting the strength of a critical decision by a specific probability distribution. It is an essential measure in any threshold-driven automated decision system. The PIC is the dual of the normalized Shannon entropy. A PIC value of one indicates the total knowledge to make a correct decision (one hypothesis has a probability value of one and the rest of zero). A PIC value of zero indicates that the knowledge to make a correct decision does not exist (all the hypotheses have an equal probability value), i.e. one has the maximal entropy. The PIC is used in our analysis to sort the performances of the different pignistic transformations through several numerical examples. We first recall what Shannon entropy and PIC measure are and their tight relationship.

- **Shannon entropy**

Shannon entropy, usually expressed in bits (binary digits), of a probability measure $P\{\cdot\}$ over a discrete finite set $\Theta = \{\theta_1, \dots, \theta_n\}$ is defined by¹³ [26]:

$$H(P) \triangleq - \sum_{i=1}^n P\{\theta_i\} \log_2(P\{\theta_i\}) \quad (1.28)$$

$H(P)$ is maximal for the uniform probability distribution over Θ , i.e. when $P\{\theta_i\} = 1/n$ for $i = 1, 2, \dots, n$. In that case, one gets $H(P) = H_{\max} = - \sum_{i=1}^n \frac{1}{n} \log_2(\frac{1}{n}) = \log_2(n)$. $H(P)$ is minimal for a totally deterministic probability, i.e. for any $P\{\cdot\}$ such that $P\{\theta_i\} = 1$ for some $i \in \{1, 2, \dots, n\}$ and $P\{\theta_j\} = 0$ for $j \neq i$. $H(P)$ measures the randomness carried by any discrete probability $P\{\cdot\}$.

- **The PIC metric**

The Probabilistic Information Content (PIC) of a probability measure $P\{\cdot\}$ associated with a probabilistic source over a discrete finite set $\Theta = \{\theta_1, \dots, \theta_n\}$ is defined by [44]:

$$PIC(P) = 1 + \frac{1}{H_{\max}} \cdot \sum_{i=1}^n P\{\theta_i\} \log_2(P\{\theta_i\}) \quad (1.29)$$

¹³with common convention $0 \log_2 0 = 0$.

The PIC is nothing but the dual of the normalized Shannon entropy and thus is actually unit less. $PIC(P)$ takes its values in $[0, 1]$. $PIC(P)$ is maximum, i.e. $PIC_{\max} = 1$ with any deterministic probability and it is minimum, i.e. $PIC_{\min} = 0$, with the uniform probability over the frame Θ . The simple relationships between $H(P)$ and $PIC(P)$ are $PIC(P) = 1 - (H(P)/H_{\max})$ and $H(P) = H_{\max} \cdot (1 - PIC(P))$.

1.7.2 The DSMP formula

Let's consider a discrete frame Θ with a given model (free DSMT model, hybrid DSMT model or Shafer's model), the $DSMP$ mapping is defined by $DSMP_{\epsilon}(\emptyset) = 0$ and $\forall X \in G^{\Theta} \setminus \{\emptyset\}$ by

$$DSMP_{\epsilon}(X) = \sum_{Y \in G^{\Theta}} \frac{\sum_{\substack{Z \subseteq X \cap Y \\ \mathcal{C}(Z)=1}} m(Z) + \epsilon \cdot \mathcal{C}(X \cap Y)}{\sum_{\substack{Z \subseteq Y \\ \mathcal{C}(Z)=1}} m(Z) + \epsilon \cdot \mathcal{C}(Y)} m(Y) \quad (1.30)$$

where $\epsilon \geq 0$ is a tuning parameter and G^{Θ} corresponds to the generic set (2^{Θ} , S^{Θ} or D^{Θ} including eventually all the integrity constraints (if any) of the model \mathcal{M}); $\mathcal{C}(X \cap Y)$ and $\mathcal{C}(Y)$ denote the DSMT cardinals¹⁴ of the sets $X \cap Y$ and Y respectively. ϵ allows to reach the maximum PIC value of the approximation of $m(\cdot)$ into a subjective probability measure. The smaller ϵ , the better/bigger PIC value. In some particular degenerate cases however, the $DSMP_{\epsilon=0}$ values cannot be derived, but the $DSMP_{\epsilon>0}$ values can however always be derived by choosing ϵ as a very small positive number, say $\epsilon = 1/1000$ for example in order to be as close as we want to the maximum of the PIC. When $\epsilon = 1$ and when the masses of all elements Z having $\mathcal{C}(Z) = 1$ are zero, (1.30) reduces to (1.27), i.e. $DSMP_{\epsilon=1} = BetP$. The passage from a free DSMT model to a Shafer's model involves the passage from a structure to another one, and the cardinals change as well in the formula (1.30). $DSMP$ works for all models (free, hybrid and Shafer's). In order to apply classical transformation (Pignistic, Cuzzolin's one, Sudano's ones, etc - see Chapter 3 in this volume), we need at first to refine the frame (on the cases when it is possible!) in order to work with Shafer's model, and then apply their formulas. In the case where refinement makes sense, then one can apply the other subjective probabilities on the refined frame. $DSMP$ works on the refined frame as well and gives the same result as it does on the non-refined frame. Thus $DSMP$ with $\epsilon > 0$ works on any models and so is very

¹⁴We have omitted the index of the model \mathcal{M} for the notation convenience.

general and appealing. $DSmP$ does a redistribution of the ignorance mass with respect to both the singleton masses and the singletons' cardinals in the same time. Now, if all masses of singletons involved in all ignorances are different from zero, then we can take $\epsilon = 0$, and $DSmP$ gives the best result, i.e. the best PIC value. In summary, $DSmP$ does an 'improvement' over previous known probabilistic transformations in the sense that $DSmP$ mathematically makes a more accurate redistribution of the ignorance masses to the singletons involved in ignorances. $DSmP$ and $BetP$ work in both theories: DST (= Shafer's model) and DSMT (= free or hybrid models) as well.

1.7.3 Examples for DSMP and BetP

The examples briefly presented here are detailed in Chapter 3 including additional results based on Cuzzolin's and Sudano's transformations.

- With Shafer's model and a non-Bayesian mass

Let's consider the frame $\Theta = \{A, B\}$ and let's assume Shafer's model and the non-Bayesian mass (more precisely the simple support mass) given in Table 1.6. We summarize in Table 1.7, the results obtained with DSMP and BetP. One sees that $PIC(DSmP_{\epsilon \rightarrow 0})$ is maximum among all PIC values.

	A	B	$A \cup B$
$m(\cdot)$	0.4	0	0.6

Table 1.6: Quantitative inputs for example 4 in Chapter 3.

	A	B	$PIC(\cdot)$
$BetP(\cdot)$	0.7000	0.3000	0.1187
$DSmP_{\epsilon=0.001}(\cdot)$	0.9985	0.0015	0.9838
$DSmP_{\epsilon=0}(\cdot)$	1	0	1

Table 1.7: Results for example 4 in Chapter 3.

The best result is an adequate probability, not the biggest PIC in this case. This is because $P(B)$ deserves to receive some mass from $m(A \cup B)$, so the most correct result is done by $DSmP_{\epsilon=0.001}$ in Table 1.7 (of course we can choose any other very small positive value for ϵ if we want). Always when a singleton whose mass is zero, but it is involved in an ignorance whose mass is not zero, then ϵ (in $DSmP$ formula (1.30)) should be taken different from zero.

• With a hybrid DSMT model

Let's consider the frame $\Theta = \{A, B, C\}$ and let's consider the hybrid DSMT model in which all intersections of elements of Θ are empty, but $A \cap B$ corresponding to figure 1.4. In this case, G^Θ reduces to 9 elements $\{\emptyset, A \cap B, A, B, C, A \cup B, A \cup C, B \cup C, A \cup B \cup C\}$. The input masses of focal elements are given by $m(A \cap B) = 0.20$, $m(A) = 0.10$, $m(C) = 0.20$, $m(A \cup B) = 0.30$, $m(A \cup C) = 0.10$, and $m(A \cup B \cup C) = 0.10$ and given in the Table 1.8.

	D'	$A' \cup D'$	C'
$m(\cdot)$	0.2	0.1	0.2
	$A' \cup B' \cup D'$	$A' \cup C' \cup D'$	$A' \cup B' \cup C' \cup D'$
$m(\cdot)$	0.3	0.1	0.1

Table 1.8: Quantitative inputs for example 8 in Chapter 3.

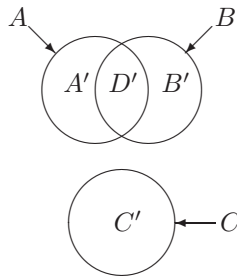

Figure 1.4: Hybrid model for $\Theta = \{A, B, C\}$.

Applying BetP and DSMT transformations, one gets:

	A'	B'	C'	D'	$PIC(\cdot)$
$BetP(\cdot)$	0.2084	0.1250	0.2583	0.4083	0.0607
$DSMT_{\epsilon=0.001}(\cdot)$	0.0025	0.0017	0.2996	0.6962	0.5390

Table 1.9: Results for example 8 in Chapter 3.

• With a free DS m model

Let's consider the frame $\Theta = \{A, B, C\}$ and let's consider the free DS m model depicted on Figure 1.5 with the input masses given in Table 1.10. To apply Sudano's and Cuzzolin's mappings, one works on the refined frame $\Theta^{\text{ref}} = \{A', B', C', D', E', F', G'\}$ where the elements of Θ^{ref} are exclusive (assuming such refinement has a physical meaning) according to Figure 1.5. This refinement step is not necessary when using DS m P since it works directly on DS m free model. The PIC values obtained with DS m P and BetP are given in Table 1.11. One sees that DS m P $_{\epsilon \rightarrow 0}$ provides here again the best results in term of PIC.

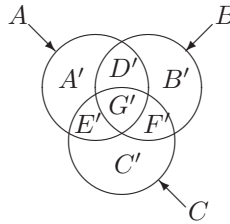

Figure 1.5: Free DS m model for a 3D frame for example 9 in Chapter 3.

	$A \cap B \cap C$	$A \cap B$	A	$A \cup B$	$A \cup B \cup C$
$m(\cdot)$	0.1	0.2	0.3	0.1	0.3

Table 1.10: Quantitative inputs for example 9 in Chapter 3.

Transformations	$PIC(\cdot)$
$BetP(\cdot)$	0.1176
$DSmP_{\epsilon=0.001}(\cdot)$	0.8986

Table 1.11: Results for example 9 in Chapter 3.

An extension of DS m P (denoted qDS m P) for working with qualitative labels instead of numbers is possible and has been proposed and presented in 2008 in [11] using approximate operators on labels. A simple example for qDS m P based on precise operators on refined labels is presented in the next section.

1.8 Fusion of qualitative beliefs

We recall here the notion of qualitative belief assignment to model beliefs of human experts expressed in natural language (with linguistic labels). We show how qualitative beliefs can be efficiently combined using an extension of DSMT to qualitative reasoning. A more detailed presentation can be found in [36]. The derivations are based on a new arithmetic on linguistic labels which allows a direct extension of all quantitative rules of combination and conditioning. The qualitative version of PCR5 rule and DSMP is also presented in the sequel.

1.8.1 Qualitative Operators

Computing with words (CW) and qualitative information is more vague, less precise than computing with numbers, but it offers the advantage of robustness if done correctly. Here is a general arithmetic we propose for computing with words (i.e. with linguistic labels). Let's consider a finite frame $\Theta = \{\theta_1, \dots, \theta_n\}$ of n (exhaustive) elements θ_i , $i = 1, 2, \dots, n$, with an associated model $\mathcal{M}(\Theta)$ on Θ (either Shafer's model $\mathcal{M}^0(\Theta)$, free-DSm model $\mathcal{M}^f(\Theta)$, or more general any Hybrid-DSm model [32]). A model $\mathcal{M}(\Theta)$ is defined by the set of integrity constraints on elements of Θ (if any); Shafer's model $\mathcal{M}^0(\Theta)$ assumes all elements of Θ truly exclusive, while free-DSm model $\mathcal{M}^f(\Theta)$ assumes no exclusivity constraints between elements of the frame Θ . Let's define a finite set of linguistic labels $\tilde{L} = \{L_1, L_2, \dots, L_m\}$ where $m \geq 2$ is an integer. \tilde{L} is endowed with a total order relationship \prec , so that $L_1 \prec L_2 \prec \dots \prec L_m$. To work on a close linguistic set under linguistic addition and multiplication operators, we extend \tilde{L} with two extreme values L_0 and L_{m+1} where L_0 corresponds to the minimal qualitative value and L_{m+1} corresponds to the maximal qualitative value, in such a way that

$$L_0 \prec L_1 \prec L_2 \prec \dots \prec L_m \prec L_{m+1}$$

where \prec means inferior to, or less (in quality) than, or smaller (in quality) than, etc. hence a relation of order from a qualitative point of view. But if we make a correspondence between qualitative labels and quantitative values on the scale $[0, 1]$, then $L_{\min} = L_0$ would correspond to the numerical value 0, while $L_{\max} = L_{m+1}$ would correspond to the numerical value 1, and each L_i would belong to $[0, 1]$, i. e.

$$L_{\min} = L_0 < L_1 < L_2 < \dots < L_m < L_{m+1} = L_{\max}$$

From now on, we work on extended ordered set L of qualitative values

$$L = \{L_0, \tilde{L}, L_{m+1}\} = \{L_0, L_1, L_2, \dots, L_m, L_{m+1}\}$$

In our previous works, we did propose approximate qualitative operators, but in this book we propose to use better and accurate operators for qualitative labels. Since these new operators are defined in details in Chapter 2 devoted on the DS m Field and Linear Algebra of Refined Labels (FLARL), we just briefly introduce here only the the main ones (i.e. the accurate label addition, multiplication and division). In FLARL, we can replace the "qualitative quasi-normalization" of qualitative operators we used in our previous papers by "qualitative normalization" since in FLARL we have exact qualitative calculations and exact normalization.

- Label addition :

$$L_a + L_b = L_{a+b} \quad (1.31)$$

$$\text{since } \frac{a}{m+1} + \frac{b}{m+1} = \frac{a+b}{m+1}.$$

- Label multiplication :

$$L_a \times L_b = L_{(ab)/(m+1)} \quad (1.32)$$

$$\text{since } \frac{a}{m+1} \cdot \frac{b}{m+1} = \frac{(ab)/(m+1)}{m+1}.$$

- Label division (when $L_b \neq L_0$):

$$L_a \div L_b = L_{(a/b)(m+1)} \quad (1.33)$$

$$\text{since } \frac{a}{m+1} \div \frac{b}{m+1} = \frac{a}{b} = \frac{(a/b)(m+1)}{m+1}.$$

More accurate qualitative operations (substraction, scalar multiplication, scalar root, scalar power, etc) can be found in Chapter 2. Of course, if one really needs to stay within the original set of labels, an approximation will be necessary at the very end of the calculations.

1.8.2 Qualitative Belief Assignment

A qualitative belief assignment¹⁵ (qba) is a mapping function $qm(\cdot) : G^\Theta \mapsto L$ where G^Θ corresponds either to 2^Θ , to D^Θ or even to S^Θ depending on the model of the frame Θ we choose to work with. In the case when the labels are equidistant, i.e. the qualitative distance between any two consecutive labels is the same, we get an exact qualitative result, and a qualitative basic belief assignment (bba) is considered normalized if the sum of all its qualitative masses is equal to $L_{\max} = L_{m+1}$. If the labels are not equidistant, we still can use

¹⁵We call it also qualitative belief mass or q-mass for short.

all qualitative operators defined in the FLARL, but the qualitative result is approximate, and a qualitative bba is considered quasi-normalized if the sum of all its masses is equal to L_{\max} . Using the qualitative operator of FLARL, we can easily extend all the combination and conditioning rules from quantitative to qualitative. In the sequel we will consider $s \geq 2$ qualitative belief assignments $qm_1(\cdot), \dots, qm_s(\cdot)$ defined over the same space G^\ominus and provided by s independent sources S_1, \dots, S_s of evidence.

Note: The addition and multiplication operators used in all qualitative fusion formulas in next sections correspond to qualitative addition and qualitative multiplication operators and must not be confused with classical addition and multiplication operators for numbers.

1.8.3 Qualitative Conjunctive Rule

The qualitative Conjunctive Rule (qCR) of $s \geq 2$ sources is defined similarly to the quantitative conjunctive consensus rule, i.e.

$$qm_{qCR}(X) = \sum_{\substack{X_1, \dots, X_s \in G^\ominus \\ X_1 \cap \dots \cap X_s = X}} \prod_{i=1}^s qm_i(X_i) \quad (1.34)$$

The total qualitative conflicting mass is given by

$$K_{1\dots s} = \sum_{\substack{X_1, \dots, X_s \in G^\ominus \\ X_1 \cap \dots \cap X_s = \emptyset}} \prod_{i=1}^s qm_i(X_i)$$

1.8.4 Qualitative DSMT Classic rule

The qualitative DSMT Classic rule (q-DSMT) for $s \geq 2$ is defined similarly to DSMT Classic fusion rule (DSMT) as follows : $qm_{qDSMT}(\emptyset) = L_0$ and for all $X \in D^\ominus \setminus \{\emptyset\}$,

$$qm_{qDSMT}(X) = \sum_{\substack{X_1, \dots, X_s \in D^\ominus \\ X_1 \cap \dots \cap X_s = X}} \prod_{i=1}^s qm_i(X_i) \quad (1.35)$$

1.8.5 Qualitative hybrid DS m rule

The qualitative hybrid DS m rule (q-DS m H) is defined similarly to quantitative hybrid DS m rule [32] as follows:

$$qm_{qDSmH}(\emptyset) = L_0 \quad (1.36)$$

and for all $X \in G^\Theta \setminus \{\emptyset\}$

$$qm_{qDSmH}(X) \triangleq \phi(X) \cdot [qS_1(X) + qS_2(X) + qS_3(X)] \quad (1.37)$$

where all sets involved in formulas are in the canonical form and $\phi(X)$ is the characteristic non-emptiness function of a set X , i.e. $\phi(X) = L_{m+1}$ if $X \notin \emptyset$ and $\phi(X) = L_0$ otherwise, where $\emptyset \triangleq \{\emptyset_{\mathcal{M}}, \emptyset\}$. $\emptyset_{\mathcal{M}}$ is the set of all elements of D^Θ which have been forced to be empty through the constraints of the model \mathcal{M} and \emptyset is the classical/universal empty set. $qS_1(X) \equiv qm_{qDSmC}(X)$, $qS_2(X)$, $qS_3(X)$ are defined by

$$qS_1(X) \triangleq \sum_{\substack{X_1, X_2, \dots, X_s \in D^\Theta \\ X_1 \cap X_2 \cap \dots \cap X_s = X}} \prod_{i=1}^s qm_i(X_i) \quad (1.38)$$

$$qS_2(X) \triangleq \sum_{\substack{X_1, X_2, \dots, X_s \in \emptyset \\ [\mathcal{U}=X] \vee [(\mathcal{U} \in \emptyset) \wedge (X = I_t)]}} \prod_{i=1}^s qm_i(X_i) \quad (1.39)$$

$$qS_3(X) \triangleq \sum_{\substack{X_1, X_2, \dots, X_k \in D^\Theta \\ X_1 \cup X_2 \cup \dots \cup X_s = X \\ X_1 \cap X_2 \cap \dots \cap X_s \in \emptyset}} \prod_{i=1}^s qm_i(X_i) \quad (1.40)$$

with $\mathcal{U} \triangleq u(X_1) \cup \dots \cup u(X_s)$ where $u(X)$ is the union of all θ_i that compose X , $I_t \triangleq \theta_1 \cup \dots \cup \theta_n$ is the total ignorance. $qS_1(X)$ is nothing but the qDS m C rule for s independent sources based on $\mathcal{M}^f(\Theta)$; $qS_2(X)$ is the qualitative mass of all relatively and absolutely empty sets which is transferred to the total or relative ignorances associated with non existential constraints (if any, like in some dynamic problems); $qS_3(X)$ transfers the sum of relatively empty sets directly onto the canonical disjunctive form of non-empty sets. qDS m H generalizes qDS m C works for any models (free DS m model, Shafer's model or any hybrid models) when manipulating qualitative belief assignments.

1.8.6 Qualitative PCR5 rule (qPCR5)

In classical (i.e. quantitative) DSmT framework, the Proportional Conflict Redistribution rule no. 5 (PCR5) defined in [36] has been proven to provide very good and coherent results for combining (quantitative) belief masses, see [10, 34]. When dealing with qualitative beliefs within the DSm Field and Linear Algebra of Refined Labels (see Chapter 2 in this book) we get an exact qualitative result no matter what fusion rule is used (DSm fusion rules, Dempster's rule, Smets's rule, Dubois-Prade's rule, etc.). The exact qualitative result will be a refined label (but the user can round it up or down to the closest integer index label).

1.8.7 A simple example of qualitative fusion of qba's

Let's consider the following set of ordered linguistic labels

$$L = \{L_0, L_1, L_2, L_3, L_4, L_5\}$$

(for example, L_1, L_2, L_3 and L_4 may represent the values: $L_1 \triangleq$ very poor, $L_2 \triangleq$ poor, $L_3 \triangleq$ good and $L_4 \triangleq$ very good, where \triangleq symbol means by definition).

Let's consider now a simple two-source case with a 2D frame $\Theta = \{\theta_1, \theta_2\}$, Shafer's model for Θ , and qba's expressed as follows:

$$qm_1(\theta_1) = L_1, \quad qm_1(\theta_2) = L_3, \quad qm_1(\theta_1 \cup \theta_2) = L_1$$

$$qm_2(\theta_1) = L_2, \quad qm_2(\theta_2) = L_1, \quad qm_2(\theta_1 \cup \theta_2) = L_2$$

The two qualitative masses $qm_1(\cdot)$ and $qm_2(\cdot)$ are normalized since:

$$qm_1(\theta_1) + qm_1(\theta_2) + qm_1(\theta_1 \cup \theta_2) = L_1 + L_3 + L_1 = L_{1+3+1} = L_5$$

and

$$qm_2(\theta_1) + qm_2(\theta_2) + qm_2(\theta_1 \cup \theta_2) = L_2 + L_1 + L_2 = L_{2+1+2} = L_5$$

We first derive the result of the conjunctive consensus. This yields:

$$\begin{aligned} qm_{12}(\theta_1) &= qm_1(\theta_1)qm_2(\theta_1) + qm_1(\theta_1)qm_2(\theta_1 \cup \theta_2) + qm_1(\theta_1 \cup \theta_2)qm_2(\theta_1) \\ &= L_1 \times L_2 + L_1 \times L_2 + L_1 \times L_2 \\ &= L_{\frac{1 \cdot 2}{5}} + L_{\frac{1 \cdot 2}{5}} + L_{\frac{1 \cdot 2}{5}} = L_{\frac{2}{5} + \frac{2}{5} + \frac{2}{5}} = L_{\frac{6}{5}} = L_{1.2} \end{aligned}$$

$$\begin{aligned}
qm_{12}(\theta_2) &= qm_1(\theta_2)qm_2(\theta_2) + qm_1(\theta_2)qm_2(\theta_1 \cup \theta_2) + qm_1(\theta_1 \cup \theta_2)qm_2(\theta_2) \\
&= L_3 \times L_1 + L_3 \times L_2 + L_1 \times L_1 \\
&= L_{\frac{3 \cdot 1}{5}} + L_{\frac{3 \cdot 2}{5}} + L_{\frac{1 \cdot 1}{5}} = L_{\frac{3}{5} + \frac{6}{5} + \frac{1}{5}} = L_{\frac{10}{5}} = L_2
\end{aligned}$$

$$qm_{12}(\theta_1 \cup \theta_2) = qm_1(\theta_1 \cup \theta_2)qm_2(\theta_1 \cup \theta_2) = L_1 \times L_2 = L_{\frac{1 \cdot 2}{5}} = L_{\frac{2}{5}} = L_{0.4}$$

$$\begin{aligned}
qm_{12}(\theta_1 \cap \theta_2) &= qm_1(\theta_1)qm_2(\theta_2) + qm_1(\theta_2)qm_2(\theta_1) \\
&= L_1 \times L_1 + L_2 \times L_3 = L_{\frac{1 \cdot 1}{5}} + L_{\frac{2 \cdot 3}{5}} \\
&= L_{\frac{1}{5} + \frac{6}{5}} = L_{\frac{7}{5}} = L_{1.4}
\end{aligned}$$

Therefore we get:

- for the fusion with qDS_mC, when assuming $\theta_1 \cap \theta_2 \neq \emptyset$,

$$qm_{qDSmC}(\theta_1) = L_{1.2} \quad qm_{qDSmC}(\theta_2) = L_2$$

$$qm_{qDSmC}(\theta_1 \cup \theta_2) = L_{0.4} \quad qm_{qDSmC}(\theta_1 \cap \theta_2) = L_{1.4}$$

- for the fusion with qDS_mH, when assuming $\theta_1 \cap \theta_2 = \emptyset$. The mass of $\theta_1 \cap \theta_2$ is transferred to $\theta_1 \cup \theta_2$. Hence:

$$qm_{qDSmH}(\theta_1) = L_{1.2} \quad qm_{qDSmH}(\theta_2) = L_2$$

$$qm_{qDSmH}(\theta_1 \cap \theta_2) = L_0 \quad qm_{qDSmH}(\theta_1 \cup \theta_2) = L_{0.4} + L_{1.4} = L_{1.8}$$

- for the fusion with qPCR5, when assuming $\theta_1 \cap \theta_2 = \emptyset$. The mass $qm_{12}(\theta_1 \cap \theta_2) = L_{1.4}$ is transferred to θ_1 and to θ_2 in the following way:

$$qm_{12}(\theta_1 \cap \theta_2) = qm_1(\theta_1)qm_2(\theta_2) + qm_2(\theta_1)qm_1(\theta_2)$$

Then, $qm_1(\theta_1)qm_2(\theta_2) = L_1 \times L_1 = L_{\frac{1 \cdot 1}{5}} = L_{\frac{1}{5}} = L_{0.2}$ is redistributed to θ_1 and θ_2 proportionally with respect to their qualitative masses put in the conflict L_1 and respectively L_1 :

$$\frac{x_{\theta_1}}{L_1} = \frac{y_{\theta_2}}{L_1} = \frac{L_{0.2}}{L_1 + L_1} = \frac{L_{0.2}}{L_{1+1}} = \frac{L_{0.2}}{L_2} = L_{\frac{0.2}{2 \cdot 5}} = L_{\frac{1}{2}} = L_{0.5}$$

whence $x_{\theta_1} = y_{\theta_2} = L_1 \times L_{0.5} = L_{\frac{1 \cdot 0.5}{5}} = L_{\frac{0.5}{5}} = L_{0.1}$.

Actually, we could easier see that $qm_1(\theta_1)qm_2(\theta_2) = L_{0.2}$ had in this case to be equally split between θ_1 and θ_2 since the mass put in the

conflict by θ_1 and θ_2 was the same for each of them: L_1 . Therefore $\frac{L_{0.2}}{2} = L_{0.2} = L_{0.1}$.

Similarly, $qm_2(\theta_1)qm_1(\theta_2) = L_2 \times L_3 = L_{\frac{2 \cdot 3}{5}} = L_{\frac{6}{5}} = L_{1.2}$ has to be redistributed to θ_1 and θ_2 proportionally with L_2 and L_3 respectively :

$$\frac{x'_{\theta_1}}{L_2} = \frac{y'_{\theta_2}}{L_3} = \frac{L_{1.2}}{L_2 + L_3} = \frac{L_{1.2}}{L_{2+3}} = \frac{L_{1.2}}{L_5} = L_{\frac{1.2}{5} \cdot 5} = L_{1.2}$$

whence $\begin{cases} x'_{\theta_1} = L_2 \times L_{1.2} = L_{\frac{2 \cdot 1.2}{5}} = L_{\frac{2.4}{5}} = L_{0.48} \\ y'_{\theta_2} = L_3 \times L_{1.2} = L_{\frac{3 \cdot 1.2}{5}} = L_{\frac{3.6}{5}} = L_{0.72} \end{cases}$ Now, add all these to the qualitative masses of θ_1 and θ_2 respectively:

$$qm_{qPCR5}(\theta_1) = qm_{12}(\theta_1) + x_{\theta_1} + x'_{\theta_1} = L_{1.2} + L_{0.1} + L_{0.48} = L_{1.2+0.1+0.48} = L_{1.78}$$

$$qm_{qPCR5}(\theta_2) = qm_{12}(\theta_2) + y_{\theta_2} + y'_{\theta_2} = L_2 + L_{0.1} + L_{0.72} = L_{2+0.1+0.72} = L_{2.82}$$

$$qm_{qPCR5}(\theta_1 \cup \theta_2) = qm_{12}(\theta_1 \cup \theta_2) = L_{0.4}$$

$$qm_{qPCR5}(\theta_1 \cap \theta_2) = L_0$$

The qualitative mass results using all fusion rules (qDSmC,qDSmH,qPCR5) remain normalized in FLARL.

Naturally, if one prefers to express the final results with qualitative labels belonging in the original discrete set of labels $L = \{L_0, L_1, L_2, L_3, L_4, L_5\}$, some approximations will be necessary to round continuous indexed labels to their closest integer/discrete index value; by example, $qm_{qPCR5}(\theta_1) = L_{1.78} \approx L_2$, $qm_{qPCR5}(\theta_2) = L_{2.82} \approx L_3$ and $qm_{qPCR5}(\theta_1 \cup \theta_2) = L_{0.4} \approx L_0$.

1.8.8 A simple example for the qDSmP transformation

We first recall that the qualitative extension of (1.30), denoted $qDSmP_\epsilon(\cdot)$ is given by $qDSmP_\epsilon(\emptyset) = L_0$ and $\forall X \in G^\Theta \setminus \{\emptyset\}$ by

$$qDSmP_\epsilon(X) = \sum_{Y \in G^\Theta} \frac{\sum_{\substack{Z \subseteq X \cap Y \\ \mathcal{C}(Z)=1}} qm(Z) + \epsilon \cdot \mathcal{C}(X \cap Y)}{\sum_{\substack{Z \subseteq Y \\ \mathcal{C}(Z)=1}} qm(Z) + \epsilon \cdot \mathcal{C}(Y)} qm(Y) \quad (1.41)$$

where all operations in (1.41) are referred to labels, that is q -operators on linguistic labels and not classical operators on numbers.

Let's consider the simple frame $\Theta = \{\theta_1, \theta_2\}$ (here $n = |\Theta| = 2$) with Shafer's model (i.e. $\theta_1 \cap \theta_2 = \emptyset$) and the following set of linguistic labels $L = \{L_0, L_1, L_2, L_3, L_4, L_5\}$, with $L_0 = L_{\min}$ and $L_5 = L_{\max} = L_{m+1}$ (here $m = 4$) and the following qualitative belief assignment: $qm(\theta_1) = L_1$, $qm(\theta_2) = L_3$ and $qm(\theta_1 \cup \theta_2) = L_1$. $qm(\cdot)$ is quasi-normalized since $\sum_{X \in 2^\Theta} qm(X) = L_5 = L_{\max}$. In this example and with DS*m*P transformation, $qm(\theta_1 \cup \theta_2) = L_1$ is redistributed to θ_1 and θ_2 proportionally with respect to their qualitative masses L_1 and L_3 respectively. Since both L_1 and L_3 are different from L_0 , we can take the tuning parameter $\epsilon = 0$ for the best transfer. ϵ is taken different from zero when a mass of a set involved in a partial or total ignorance is zero (for qualitative masses, it means L_0).

Therefore using (1.33), one has

$$\frac{x_{\theta_1}}{L_1} = \frac{x_{\theta_2}}{L_3} = \frac{L_1}{L_1 + L_3} = \frac{L_1}{L_4} = L_{\frac{1}{4},5} = L_{\frac{5}{4}} = L_{1.25}$$

and thus using (1.32), one gets

$$x_{\theta_1} = L_1 \times L_{1.25} = L_{\frac{1 \cdot (1.25)}{5}} = L_{\frac{1.25}{5}} = L_{0.25}$$

$$x_{\theta_2} = L_3 \times L_{1.25} = L_{\frac{3 \cdot (1.25)}{5}} = L_{\frac{3.75}{5}} = L_{0.75}$$

Therefore,

$$qDSmP_{\epsilon=0}(\theta_1 \cap \theta_2) = qDSmP_{\epsilon=0}(\emptyset) = L_0$$

$$qDSmP_{\epsilon=0}(\theta_1) = L_1 + x_{\theta_1} = L_1 + L_{0.25} = L_{1.25}$$

$$qDSmP_{\epsilon=0}(\theta_2) = L_3 + x_{\theta_2} = L_3 + L_{0.75} = L_{3.75}$$

Naturally in our example, one has also

$$\begin{aligned} qDSmP_{\epsilon=0}(\theta_1 \cup \theta_2) &= qDSmP_{\epsilon=0}(\theta_1) + qDSmP_{\epsilon=0}(\theta_2) - qDSmP_{\epsilon=0}(\theta_1 \cap \theta_2) \\ &= L_{1.25} + L_{3.75} - L_0 = L_5 = L_{\max} \end{aligned}$$

Since $H_{\max} = \log_2 n = \log_2 2 = 1$, using the qualitative extension of PIC formula (1.29), one obtains the following qualitative PIC value:

$$\begin{aligned} PIC &= 1 + \frac{1}{1} \cdot [qDSmP_{\epsilon=0}(\theta_1) \log_2(qDSmP_{\epsilon=0}(\theta_1)) \\ &\quad + qDSmP_{\epsilon=0}(\theta_2) \log_2(qDSmP_{\epsilon=0}(\theta_2))] \\ &= 1 + L_{1.25} \log_2(L_{1.25}) + L_{3.75} \log_2(L_{3.75}) \approx L_{0.94} \end{aligned}$$

since we considered the isomorphic transformation $L_i = i/(m + 1)$ (in our particular example $m = 4$ interior labels).

1.9 Belief Conditioning Rules

1.9.1 Shafer's Conditioning Rule (SCR)

Until very recently, the most commonly used conditioning rule for belief revision was the one proposed by Shafer [25] and referred here as Shafer's Conditioning Rule (SCR). The SCR consists in combining the prior bba $m(\cdot)$ with a specific bba focused on A with Dempster's rule of combination for transferring the conflicting mass to non-empty sets in order to provide the revised bba. In other words, the conditioning by a proposition A , is obtained by SCR as follows :

$$m_{SCR}(\cdot|A) = [m \oplus m_S](\cdot) \quad (1.42)$$

where $m(\cdot)$ is the prior bba to update, A is the conditioning event, $m_S(\cdot)$ is the bba focused on A defined by $m_S(A) = 1$ and $m_S(X) = 0$ for all $X \neq A$ and \oplus denotes Dempster's rule of combination [25].

The SCR approach based on Dempster's rule of combination of the prior bba with the bba focused on the conditioning event remains subjective since actually in such belief revision process both sources are subjective and in our opinions SCR doesn't manage satisfactorily the objective nature/absolute truth carried by the conditioning term. Indeed, when conditioning a prior mass $m(\cdot)$, knowing (or assuming) that the truth is in A , means that we have in hands an absolute (not subjective) knowledge, i.e. the truth in A has occurred (or is assumed to have occurred), thus A is realized (or is assumed to be realized) and this is (or at least must be interpreted as) an absolute truth. The conditioning term "Given A " must therefore be considered as an absolute truth, while $m_S(A) = 1$ introduced in SCR cannot refer to an absolute truth actually, but only to a subjective certainty on the possible occurrence of A from a virtual second source of evidence. The advantage of SCR remains undoubtedly in its simplicity and the main argument in its favor is its coherence with conditional probability when manipulating Bayesian belief assignment. But in our opinion, SCR should better be interpreted as the fusion of $m(\cdot)$ with a particular subjective bba $m_S(A) = 1$ rather than an objective belief conditioning rule. This fundamental remark motivated us to develop a new family of BCR [36] based on hyper-power set decomposition (HPSD) explained briefly in the next section. It turns out that many BCR are possible because the redistribution of masses of elements outside of A (the conditioning event) to those inside A can be done in n -ways. This will be briefly presented right after the next section.

1.9.2 Hyper-Power Set Decomposition (HPSD)

Let $\Theta = \{\theta_1, \theta_2, \dots, \theta_n\}$, $n \geq 2$, a model $\mathcal{M}(\Theta)$ associated for Θ (free DS_m model, hybrid or Shafer's model) and its corresponding hyper-power set D^Θ . Let's consider a (quantitative) basic belief assignment (bba) $m(\cdot) : D^\Theta \mapsto [0, 1]$ such that $\sum_{X \in D^\Theta} m(X) = 1$. Suppose one finds out that the truth is in the set $A \in D^\Theta \setminus \{\emptyset\}$. Let $\mathcal{P}_D(A) = 2^A \cap D^\Theta \setminus \{\emptyset\}$, i.e. all non-empty parts (subsets) of A which are included in D^Θ . Let's consider the normal cases when $A \neq \emptyset$ and $\sum_{Y \in \mathcal{P}_D(A)} m(Y) > 0$. For the degenerate case when the truth is in $A = \emptyset$, we consider Smets' open-world, which means that there are other hypotheses $\Theta' = \{\theta_{n+1}, \theta_{n+2}, \dots, \theta_{n+m}\}$, $m \geq 1$, and the truth is in $A \in D^{\Theta'} \setminus \{\emptyset\}$. If $A = \emptyset$ and we consider a close-world, then it means that the problem is impossible. For another degenerate case, when $\sum_{Y \in \mathcal{P}_D(A)} m(Y) = 0$, i.e. when the source gave us a totally (100%) wrong information $m(\cdot)$, then, we define: $m(A|A) \triangleq 1$ and, as a consequence, $m(X|A) = 0$ for any $X \neq A$. Let $s(A) = \{\theta_{i_1}, \theta_{i_2}, \dots, \theta_{i_p}\}$, $1 \leq p \leq n$, be the singletons/atoms that compose A (for example, if $A = \theta_1 \cup (\theta_3 \cap \theta_4)$ then $s(A) = \{\theta_1, \theta_3, \theta_4\}$). The Hyper-Power Set Decomposition (HPSD) of $D^\Theta \setminus \{\emptyset\}$ consists in its decomposition into the three following subsets generated by A :

- $D_1 = \mathcal{P}_D(A)$, the parts of A which are included in the hyper-power set, except the empty set;
- $D_2 = \{(\Theta \setminus s(A)), \cup, \cap\} \setminus \{\emptyset\}$, i.e. the sub-hyper-power set generated by $\Theta \setminus s(A)$ under \cup and \cap , without the empty set.
- $D_3 = (D^\Theta \setminus \{\emptyset\}) \setminus (D_1 \cup D_2)$; each set from D_3 has in its formula singletons from both $s(A)$ and $\Theta \setminus s(A)$ in the case when $\Theta \setminus s(A)$ is different from empty set.

D_1 , D_2 and D_3 have no element in common two by two and their union is $D^\Theta \setminus \{\emptyset\}$.

Simple example of HPSD: Let's consider $\Theta = \{\theta_1, \theta_2, \theta_3\}$ with Shafer's model (i.e. all elements of Θ are exclusive) and let's assume that the truth is in $\theta_2 \cup \theta_3$, i.e. the conditioning term is $\theta_2 \cup \theta_3$. Then one has the following HPSD: $D_1 = \{\theta_2, \theta_3, \theta_2 \cup \theta_3\}$, $D_2 = \{\theta_1\}$ and $D_3 = \{\theta_1 \cup \theta_2, \theta_1 \cup \theta_3, \theta_1 \cup \theta_2 \cup \theta_3\}$. More complex and detailed examples can be found in [36].

1.9.3 Quantitative belief conditioning rules (BCR)

Since there exists actually many ways for redistributing the masses of elements outside of A (the conditioning event) to those inside A , several BCR's have

been proposed in [36]. In this introduction, we will not browse all the possibilities for doing these redistributions and all BCR's formulas but only one, the BCR number 17 (i.e. BCR17) which does in our opinion the most refined redistribution since:

- the mass $m(W)$ of each element W in $D_2 \cup D_3$ is transferred to those $X \in D_1$ elements which are included in W if any proportionally with respect to their non-empty masses;
- if no such X exists, the mass $m(W)$ is transferred in a pessimistic/prudent way to the k -largest element from D_1 which are included in W (in equal parts) if any;
- if neither this way is possible, then $m(W)$ is indiscriminately distributed to all $X \in D_1$ proportionally with respect to their nonzero masses.

BCR17 is defined by the following formula (see [36], Chap. 9 for detailed explanations and examples):

$$m_{BCR17}(X|A) = m(X) \cdot \left[S_{D_1} + \sum_{\substack{W \in D_2 \cup D_3 \\ X \subset W \\ S(W) \neq 0}} \frac{m(W)}{S(W)} \right] + \sum_{\substack{W \in D_2 \cup D_3 \\ X \subset W, X \text{ is } k\text{-largest} \\ S(W) = 0}} m(W)/k \quad (1.43)$$

where "X is k -largest" means that X is the k -largest (with respect to inclusion) set included in W and

$$S(W) \triangleq \sum_{Y \in D_1, Y \subset W} m(Y) + \sum_{\substack{Z \in D_1, \\ \text{or } Z \in D_2 \mid \nexists Y \in D_1 \text{ with } Y \subset Z}} m(Z)$$

$$S_{D_1} \triangleq \frac{\sum_{Y \in D_1} m(Y)}{\sum_{Y \in D_1} m(Y)}$$

Note: The authors mentioned in an Erratum to the printed version of the second volume of DS_mT book series (<http://fs.gallup.unm.edu/Erratum.pdf>)

and they also corrected the online version of the aforementioned book (see page 240 in <http://fs.gallup.unm.edu//DSMT-book2.pdf> that all denominators of the BCR's formulas are naturally supposed to be different from zero. Of course, Shafer's conditioning rule as stated in Theorem 3.6, page 67 of [25] does not work when the denominator is zero and that's why Shafer has introduced the condition $Bel(\bar{B}) < 1$ (or equivalently $Pl(B) > 0$) in his theorem when the conditioning term is B .

A simple example for BCR17: Let's consider $\Theta = \{\theta_1, \theta_2, \theta_3\}$ with Shafer's model (i.e. all elements of Θ are exclusive) and let's assume that the truth is in $\theta_2 \cup \theta_3$, i.e. the conditioning term is $A \triangleq \theta_2 \cup \theta_3$. Then one has the following HPSD:

$$D_1 = \{\theta_2, \theta_3, \theta_2 \cup \theta_3\}, \quad D_2 = \{\theta_1\}$$

$$D_3 = \{\theta_1 \cup \theta_2, \theta_1 \cup \theta_3, \theta_1 \cup \theta_2 \cup \theta_3\}.$$

Let's consider the following prior bba: $m(\theta_1) = 0.2$, $m(\theta_2) = 0.1$, $m(\theta_3) = 0.2$, $m(\theta_1 \cup \theta_2) = 0.1$, $m(\theta_2 \cup \theta_3) = 0.1$ and $m(\theta_1 \cup \theta_2 \cup \theta_3) = 0.3$.

With BCR17, for D_2 , $m(\theta_1) = 0.2$ is transferred proportionally to all elements of D_1 , i.e. $\frac{x_{\theta_2}}{0.1} = \frac{y_{\theta_3}}{0.2} = \frac{z_{\theta_2 \cup \theta_3}}{0.1} = \frac{0.2}{0.4} = 0.5$ whence the parts of $m(\theta_1)$ redistributed to θ_2 , θ_3 and $\theta_2 \cup \theta_3$ are respectively $x_{\theta_2} = 0.05$, $y_{\theta_3} = 0.10$, and $z_{\theta_2 \cup \theta_3} = 0.05$. For D_3 , there is actually no need to transfer $m(\theta_1 \cup \theta_3)$ because $m(\theta_1 \cup \theta_3) = 0$ in this example; whereas $m(\theta_1 \cup \theta_2) = 0.1$ is transferred to θ_2 (no case of k -elements herein); $m(\theta_1 \cup \theta_2 \cup \theta_3) = 0.3$ is transferred to θ_2 , θ_3 and $\theta_2 \cup \theta_3$ proportionally to their corresponding masses:

$$x_{\theta_2}/0.1 = y_{\theta_3}/0.2 = z_{\theta_2 \cup \theta_3}/0.1 = 0.3/0.4 = 0.75$$

whence $x_{\theta_2} = 0.075$, $y_{\theta_3} = 0.15$, and $z_{\theta_2 \cup \theta_3} = 0.075$. Finally, one gets

$$m_{BCR17}(\theta_2|\theta_2 \cup \theta_3) = 0.10 + 0.05 + 0.10 + 0.075 = 0.325$$

$$m_{BCR17}(\theta_3|\theta_2 \cup \theta_3) = 0.20 + 0.10 + 0.15 = 0.450$$

$$m_{BCR17}(\theta_2 \cup \theta_3|\theta_2 \cup \theta_3) = 0.10 + 0.05 + 0.075 = 0.225$$

which is different from the result obtained with SCR, since one gets in this example:

$$m_{SCR}(\theta_2|\theta_2 \cup \theta_3) = m_{SCR}(\theta_3|\theta_2 \cup \theta_3) = 0.25$$

$$m_{SCR}(\theta_2 \cup \theta_3|\theta_2 \cup \theta_3) = 0.50$$

More complex and detailed examples can be found in [36].

1.9.4 Qualitative belief conditioning rules

In this section we present only the qualitative belief conditioning rule no 17 which extends the principles of the previous quantitative rule BCR17 in the qualitative domain using the operators on linguistic labels defined previously. We consider from now on a general frame $\Theta = \{\theta_1, \theta_2, \dots, \theta_n\}$, a given model $\mathcal{M}(\Theta)$ with its hyper-power set D^Θ and a given extended ordered set L of qualitative values $L = \{L_0, L_1, L_2, \dots, L_m, L_{m+1}\}$. The prior qualitative basic belief assignment (qbba) taking its values in L is denoted $qm(\cdot)$. We assume in the sequel that the conditioning event is $A \neq \emptyset$, $A \in D^\Theta$, i.e. the absolute truth is in A . The approach we present here is a direct extension of BCR17 using FLARL operators. Such extension can be done with all quantitative BCR's rules proposed in [36], but only qBCR17 is presented here for the sake of space limitations.

1.9.4.1 Qualitative Belief Conditioning Rule no 17 (qBCR17)

Similarly to BCR17, qBCR17 is defined by the following formula:

$$\begin{aligned}
 qm_{qBCR17}(X|A) = qm(X) \cdot & \left[qS_{D_1} + \sum_{\substack{W \in D_2 \cup D_3 \\ X \subset W \\ qS(W) \neq 0}} \frac{qm(W)}{qS(W)} \right] \\
 & + \sum_{\substack{W \in D_2 \cup D_3 \\ X \subset W, X \text{ is } k\text{-largest} \\ qS(W) = 0}} qm(W)/k \quad (1.44)
 \end{aligned}$$

where "X is k-largest" means that X is the k-largest (with respect to inclusion) set included in W and

$$\begin{aligned}
 qS(W) & \triangleq \sum_{Y \in D_1, Y \subset W} qm(Y) \\
 & \quad + \sum_{Z \in D_1,} qm(Z) \\
 S_{D_1} & \triangleq \frac{\text{or } Z \in D_2 \mid \nexists Y \in D_1 \text{ with } Y \subset Z}{\sum_{Y \in D_1} qm(Y)}
 \end{aligned}$$

Naturally, all operators (summation, product, division, etc) involved in the formula (1.44) are the operators defined in FLARL working on linguistic labels.

It is worth to note that the formula (1.44) requires also the division of the label $qm(W)$ by a scalar k . This division is defined as follows:

Let $r \in \mathbb{R}, r \neq 0$. Then the label division by a scalar is defined by

$$\frac{L_a}{r} = L_{a/r} \tag{1.45}$$

1.9.4.2 A simple example for qBCR17

Let's consider $L = \{L_0, L_1, L_2, L_3, L_4, L_5, L_6\}$ a set of ordered linguistic labels. For example, L_1, L_2, L_3, L_4 and L_5 may represent the values: $L_1 \triangleq$ very poor, $L_2 \triangleq$ poor, $L_3 \triangleq$ medium, $L_4 \triangleq$ good and $L_5 \triangleq$ very good. Let's consider also the frame $\Theta = \{A, B, C, D\}$ with the hybrid model corresponding to the Venn diagram on Figure 1.6.

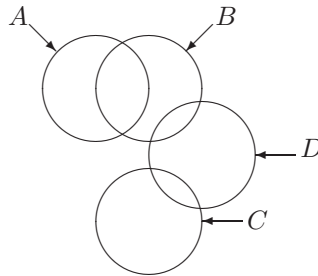

Figure 1.6: Venn Diagram for the hybrid model for this example.

We assume that the prior qualitative bba $qm(\cdot)$ is given by:

$$qm(A) = L_1, \quad qm(C) = L_1, \quad qm(D) = L_4$$

and the qualitative masses of all other elements of G^Θ take the minimal/zero value L_0 . This mass is normalized since $L_1 + L_1 + L_4 = L_{1+1+4} = L_6 = L_{\max}$.

If we assume that the conditioning event is the proposition $A \cup B$, i.e. the absolute truth is in $A \cup B$, the hyper-power set decomposition (HPSD) is obtained as follows: D_1 is formed by all parts of $A \cup B$, D_2 is the set generated by $\{(C, D), \cup, \cap\} \setminus \emptyset = \{C, D, C \cup D, C \cap D\}$, and $D_3 = \{A \cup C, A \cup D, B \cup C, B \cup D, A \cup B \cup C, A \cup (C \cap D), \dots\}$.

Because the truth is in $A \cup B$, $qm(D) = L_4$ is transferred in a prudent way to $(A \cup B) \cap D = B \cap D$ according to our hybrid model, because $B \cap D$ is the 1-largest element from $A \cup B$ which is included in D . While $qm(C) = L_1$ is

transferred to A only, since it is the only element in $A \cup B$ whose qualitative mass $qm(A)$ is different from L_0 (zero); hence:

$$qm_{qBCR17}(A|A \cup B) = qm(A) + qm(C) = L_1 + L_1 = L_{1+1} = L_2.$$

Therefore, one finally gets:

$$\begin{aligned} qm_{qBCR17}(A|A \cup B) &= L_2, & qm_{qBCR17}(C|A \cup B) &= L_0 \\ qm_{qBCR17}(D|A \cup B) &= L_0, & qm_{qBCR17}(B \cap D|A \cup B) &= L_4 \end{aligned}$$

which is a normalized qualitative bba.

More complicated examples based on other qBCR's can be found in [37].

1.10 Conclusion

A general presentation of the foundations of DSMT has been proposed in this introduction. DSMT proposes new quantitative and qualitative rules of combination for uncertain, imprecise and highly conflicting sources of information. Several applications of DSMT have been proposed recently in the literature and show the potential and the efficiency of this new theory. DSMT offers the possibility to work in different fusion spaces depending on the nature of problem under consideration. Thus, one can work either in $2^\Theta = (\Theta, \cup)$ (i.e. in the classical power set as in DST framework), in $D^\Theta = (\Theta, \cup, \cap)$ (the hyper-power set — also known as Dedekind's lattice) or in the super-power set $S^\Theta = (\Theta, \cup, \cap, c(\cdot))$, which includes 2^Θ and D^Θ and which represents the power set of the minimal refinement of the frame Θ when the refinement is possible (because for vague elements whose frontiers are not well known the refinement is not possible). We have enriched the DSMT with a subjective probability ($DSmP_\epsilon$) that gets the best Probabilistic Information Content (PIC) in comparison with other existing subjective probabilities. Also, we have defined and developed the DSMT Field and Linear Algebra of Refined Labels that permit the transformation of any fusion rule to a corresponding qualitative fusion rule which gives an exact qualitative result (i.e. a refined label), so far the best in literature.

1.11 References

- [1] J. Bolanos, L.M. De Campos, S. Moral, *Propagation of linguistic labels in causal networks*, Proc. of 2nd IEEE Int. Conf. on Fuzzy Systems, Vol. 2, pp. 863–870, 28 March–1 April 1993.

- [2] L. Cholvy *Using logic to understand relations between DS_mT and Dempster-Shafer Theory*, in pp. 312–317 of the Proceedings of the Rencontres francophones sur la Logique Floue et ses Applications (LFA 2008), Lens, France, October 16-17, 2008.
- [3] L. Comtet, *Sperner Systems*, Sec.7.2 in *Advanced Combinatorics: The Art of Finite and Infinite Expansions*, D. Reidel Publ. Co., pp. 271-273, 1974.
- [4] R. Dedekind, *Über Zerlegungen von Zahlen durch ihre grössten gemeinsamen Teiler*, In *Gesammelte Werke*, Bd. 1. pp. 103-148, 1897.
- [5] M. Daniel, *The DS_m approach as a special case of the Dempster-Shafer theory*, in *Symbolic and quantitative approaches to reasoning with uncertainty* (Mellouli Ed.), *Lecture Notes in Computer Science 4724* (*Lecture Notes in Artificial Intelligence*), pp. 381-392 (2007); 9th European conference, ECSQARU 2007, Hammamet, Tunisia, October 31–November 2, 2007.
- [6] T. Denœux, *Reasoning with imprecise belief structures*, Technical Report Heudiasys 97/44, available at <http://www.hds.utc.fr/~tdenoeux/>.
- [7] T. Denœux, *Reasoning with imprecise belief structures*, *International Journal of Approximate Reasoning*, 20, pp. 79-111, 1999.
- [8] J. Dezert J., F. Smarandache, *Panel Discussion on DS_mT*, Fusion 2004 International Conference, Stockholm, Sweden (and also in *Tutorials on DS_mT* given in Fusion 2005-2008 Conferences).
- [9] J. Dezert J., F. Smarandache, *DS_mT: A New Paradigm Shift for Information Fusion*, in *Proceedings of Cogis '06 Conference*, Paris, March 2006.
- [10] J. Dezert, A. Tchamova, F. Smarandache, P. Konstantinova, *Target Type Tracking with PCR5 and Dempster's rules: A Comparative Analysis*, in *Proceedings of Fusion 2006 International conference on Information Fusion*, Fusion 2006, Firenze, Italy, July 10-13, 2006.
- [11] J. Dezert, F. Smarandache, *A new probabilistic transformation of belief mass assignment*, in *Proceedings of Fusion 2008 Conference*, Cologne, Germany, July 2008.
- [12] D. Dubois, H. Prade, *On the unicity of Dempster rule of combination*, *International Journal of Intelligent Systems*, Vol. 1, pp 133-142, 1986.

- [13] D. Dubois, H. Prade, *Representation and combination of uncertainty with belief functions and possibility measures*, Computational Intelligence, 4, pp. 244-264, 1988.
- [14] M.C. Florea, *Combinaison d'informations hétérogènes dans le cadre unificateur des ensembles aléatoires : Approximations et robustesse*, Ph.D. Thesis, Laval University, Canada, July 2007.
- [15] J.W. Guan, D.A. Bell, *Generalizing the Dempster-Shafer rule of combination to Boolean algebras*, Proc. of IEEE/ACM Int. Conf. on Developing and Managing Projects, Washington, March, pp. 229-236, 1993.
- [16] T. Inagaki, *Interdependence between safety-control policy and multiple-sensor schemes via Dempster-Shafer theory*, IEEE Trans. on reliability, Vol. 40, no. 2, pp. 182-188, 1991.
- [17] M. Lamata, S. Moral, *Calculus with linguistic probabilities and beliefs*, In R. R. Yager, M. Fedrizzi, and J. Kacprzyk, editors, *Advances in Dempster-Shafer Theory of Evidence*, pp. 133-152, Wiley.
- [18] E. Lefevre, O. Colot, P. Vannoorenberghe, *Belief functions combination and conflict management*, Information Fusion Journal, Elsevier Publisher, Vol. 3, No. 2, pp. 149-162, 2002.
- [19] E. Lefevre, O. Colot, P. Vannoorenberghe, *Reply to the Comments of R. Haenni on the paper "Belief functions combination and conflict management"*, Information Fusion Journal, Elsevier Publisher, Vol. 4, pp. 63-65, 2003.
- [20] C.K. Murphy, *Combining belief functions when evidence conflicts*, Decision Support Systems, Elsevier Publisher, Vol. 29, pp. 1-9, 2000.
- [21] J.B. Paris, *The uncertain reasoner's companion, a mathematical perspective*, Cambridge University Press, 1994.
- [22] J. Pearl, *Probabilistic reasoning in Intelligent Systems: Networks of Plausible Inference*, Morgan Kaufmann Publishers, San Mateo, CA, 1988.
- [23] A. Robinson, *Non-Standard Analysis*, North-Holland Publ. Co., 1966.
- [24] K. Sentz, S. Ferson, *Combination of evidence in Dempster-Shafer Theory*, SANDIA Tech. Report, SAND2002-0835, 96 pages, April 2002.
- [25] G. Shafer, *A Mathematical Theory of Evidence*, Princeton Univ. Press, Princeton, NJ, 1976.

- [26] C.E. Shannon, *A Mathematical Theory of Communication*, Bell Syst. Tech. J., 27, pp. 379-423 and 623-656, 1948.
- [27] N.J.A. Sloane, *The On-line Encyclopedia of Integer Sequences 2003*, (Sequence No. A014466),
<http://www.research.att.com/~njas/sequences/>
- [28] F. Smarandache, *A Unifying Field in Logics: Neutrosophic Logic. Neutrosophy, Neutrosophic Set, Probability, and Statistics*, (4th Ed.), Amer. Research Press, Rehoboth, 2005.
- [29] F. Smarandache, *A Unifying Field in Logics: Neutrosophic Logic*, Multiple-valued logic, An international journal, Vol. 8, No. 3, pp. 385-438, 2002.
- [30] F. Smarandache, *Neutrosophy: A new branch of philosophy*, Multiple-valued logic, An international journal, Vol. 8, No. 3, pp. 297-384, 2002.
- [31] F. Smarandache (Editor), *Proceedings of the First International Conference on Neutrosophics*, Univ. of New Mexico, Gallup Campus, NM, U.S.A., 1-3 Dec. 2001, Xiquan, Phoenix, 2002.
- [32] F. Smarandache, J. Dezert (Editors), *Applications and Advances of DSMT for Information Fusion*, Am. Res. Press, Rehoboth, 2004.
<http://www.gallup.unm.edu/~smarandache/DSMT-book1.pdf>
- [33] F. Smarandache, *Unification of Fusion Theories (UFT)*, Presented at NATO Advanced Study Institute, Albena, Bulgaria, 16-27 May 2005 also in International Journal of Applied Mathematics & Statistics, Vol. 2, 1-14, 2004 and on <http://arxiv.org/abs/cs/0409040>.
- [34] F. Smarandache, J. Dezert, *Information Fusion Based on New Proportional Conflict Redistribution Rules*, Proceedings of Fusion 2005 Conf., Philadelphia, July 26-29, 2005.
- [35] F. Smarandache, J. Dezert, *Uniform and Partially Uniform Redistribution Rules*, published in "Advances and Applications of DSMT for Plausible and Paradoxical Reasoning for Information Fusion", International Workshop organized by the Bulgarian IST Centre of Competence in 21st Century, December 14, 2006, Bulg. Acad. of Sciences, Sofia, Bulgaria.
<http://xxx.lanl.gov/abs/cs/070202>

- [36] F. Smarandache, J. Dezert (Editors), *Applications and Advances of DSMT for Information Fusion*, Vol. 2, American Research Press, Rehoboth, August 2006.
<http://www.gallup.unm.edu/~smarandache/DSMT-book2.pdf>
- [37] F. Smarandache, J. Dezert, *Qualitative Belief Conditioning Rules*, Proceedings of Fusion 2007 Conf., Québec, Canada, July 2007.
- [38] F. Smarandache, *DSMT web page*, <http://fs.gallup.unm.edu//DSMT.htm>
- [39] Ph. Smets, *Combining non distinct evidence*, Proc. North American Fuzzy Information Processing (NAFIP 1986), New Orleans, LA, 1986.
- [40] Ph. Smets, E.H. Mamdani, D. Dubois, H. Prade (Editors), *Non-Standard Logics for Automated Reasoning*, Academic Press, 1988.
- [41] Smets Ph., Kennes R., *The transferable belief model*, Artif. Intel., 66(2), pp. 191-234, 1994.
- [42] Ph. Smets, *Data Fusion in the Transferable Belief Model*, Proceedings of the 3rd International Conference on Information Fusion, Fusion 2000, Paris, July 10-13, 2000, pp PS21-PS33.
- [43] J. Sudano, *Pignistic Probability Transforms for Mixes of Low- and High-Probability Events*, Proc. of Fusion 2001, Montréal, August 2001.
- [44] J. Sudano, *The system probability information content (PIC) ...*, Proc. of Fusion 2002, Annapolis, July 2002.
- [45] J. Sudano, *Equivalence Between Belief Theories and Naive Bayesian Fusion for Systems with Independent Evidential Data - Part I, The Theory*, Proc. of Fusion 2003, Cairns, July 2003.
- [46] J. Sudano, *Yet Another Paradigm Illustrating Evidence Fusion (YAPIEF)*, Proc. of Fusion 2006, Florence, July 2006.
- [47] M. Tombak, A. Isotamm, T. Tamme, *On logical method for counting Dedekind numbers*, Lect. Notes on Comp.Sci., 2138, p. 424-427, Springer-Verlag, 2001 (www.cs.ut.ee/people/m_tombak/publ.html).
- [48] F. Voorbraak, *On the justification of Dempster's rule of combination*, Artificial Intelligence, 48, pp. 171-197, 1991.
<http://turing.wins.uva.nl/~fransv/#pub>

- [49] Y.-M. Wang, J.-B. Yang, D.-L. Xu, K.-S. Chin, *On the combination and normalization of interval-valued belief structures*, Information Sciences 177, pp. 1230–1247, 2007.
- [50] R. R. Yager, *Hedging in the combination of evidence*, Journal of Information and Optimization Science, Vol. 4, No. 1, pp. 73-81, 1983.
- [51] R. R. Yager, *On the relationships of methods of aggregation of evidence in expert systems*, Cybernetics and Systems, Vol. 16, pp. 1-21, 1985.
- [52] R. R. Yager, *On the Dempster-Shafer framework and new combination rules*, Information Sciences, Vol. 41, pp. 93–138, 1987.
- [53] L. Zadeh, *Fuzzy sets*, Inform. and Control 8, pp. 338-353, 1965.
- [54] L. Zadeh, *Fuzzy Logic and Approximate Reasoning*, Synthese, 30, 407-428, 1975.
- [55] L. Zadeh, *On the validity of Dempster's rule of combination*, Memo M 79/24, Univ. of California, Berkeley, 1979.
- [56] L. Zadeh, *Review of Mathematical theory of evidence, by Glenn Shafer*, AI Magazine, Vol. 5, No. 3, pp. 81-83, 1984.
- [57] L. Zadeh, *A simple view of the Dempster-Shafer theory of evidence and its implications for the rule of combination*, Berkeley Cognitive Science Report No. 33, University of California, Berkeley, CA, 1985.
- [58] L. Zadeh, *A simple view of the Dempster-Shafer theory of evidence and its implication for the rule of combination*, AI Magazine 7, No.2, pp. 85-90, 1986.
- [59] L. Zhang, *Representation, independence, and combination of evidence in the Dempster-Shafer Theory*, Advances in the Dempster-Shafer Theory of Evidence, R.R. Yager, J. Kacprzyk and M. Fedrizzi, Eds., John Wiley and Sons, Inc., New York, pp. 51-69, 1994.

Chapter 2

DSm field and linear algebra of refined labels

Florentin Smarandache
Chair of Math. & Sciences Dept.,
University of New Mexico,
200 College Road,
Gallup, NM 87301, U.S.A.
smarand@unm.edu

Jean Dezert
The French Aerospace Lab.,
ONERA/DTIM/SIF,
29 Av. Division Leclerc,
92320 Châtillon, France.
jean.dezert@onera.fr

Xinde Li
Key Lab. of Meas. and Control of CSE,
School of Automation, Southeast Univ.,
Nanjing, China, 210096.
xindeli@seu.edu.cn

Abstract: *This chapter presents the DSm Field and Linear Algebra of Refined Labels (FLARL) in DSmT framework in order to work precisely with qualitative labels for information fusion. We present and justify the basic operators on qualitative labels (addition, subtraction, multiplication, division, root, power, etc).*

2.1 Introduction

Definitions of group, field, algebra, vector space, and linear algebra used in this paper can be found in [1, 2, 4]. Let L_1, L_2, \dots, L_m be labels, where $m \geq 1$ is an integer. We consider a relation of order defined on these labels which can be "smaller", "less in quality", "lower", etc., $L_1 < L_2 < \dots < L_m$. Let's extend this set of labels with a minimum label L_0 , and a maximum label L_{m+1} . In the case when the labels are equidistant, i.e. the qualitative distance between any two consecutive labels is the same, we get an exact qualitative result, and a qualitative basic belief assignment (bba) is considered normalized if the sum of all its qualitative masses is equal to $L_{\max} = L_{m+1}$. If the labels are not equidistant, we still can use all qualitative operators defined in the FLARL, but the qualitative result is approximate, and a qualitative bba is considered quasi-normalized if the sum of all its masses is equal to L_{\max} . Connecting them to the classical interval $[0, 1]$, we have:

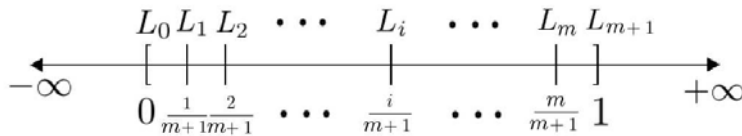

Figure 2.1: Ordered set of labels in $[0, 1]$.

So, $0 \equiv L_0 < L_1 < L_2 < \dots < L_i < \dots < L_m < L_{m+1} \equiv 1$, and $L_i = \frac{i}{m+1}$ for $i \in \{0, 1, 2, \dots, m, m+1\}$.

1. **Ordinary labels:** The set of labels $\tilde{L} \triangleq \{L_0, L_1, L_2, \dots, L_i, \dots, L_m, L_{m+1}\}$ whose indexes are positive integers between 0 and $m+1$, is called the set of *1-Tuple labels*. We call a set of labels to be *equidistant labels*, if the geometric distance between any two consecutive labels is the same, i.e. $L_{i+1} - L_i = \text{Constant}$ for any i .

And, the opposite definition: a set of labels is of *non-equidistant labels* if the distances between consecutive labels is not the same, i.e. there exists $i \neq j$ such that $L_{i+1} - L_i \neq L_{j+1} - L_j$.

For simplicity and symmetry of the calculations, we further consider the case of equidistant labels. But the same procedures can *approximately* work for non-equidistant labels.

This set of 1-Tuple labels is isomorphic with the numerical set $\{\frac{i}{m+1}, i = 0, 1, \dots, m+1\}$ through the isomorphism $f_{\tilde{L}}(L_i) = \frac{i}{m+1}$.

2. **Refined labels:** We theoretically extend the set of labels \tilde{L} to the left and right sides of the interval $[0, 1]$ towards $-\infty$ and respectively $+\infty$. So, we define:

$$L_{\mathbb{Z}} \triangleq \left\{ \frac{j}{m+1}, j \in \mathbb{Z} \right\}$$

where \mathbb{Z} is the set of all positive and negative integers (zero included).

Thus:

$$L_{\mathbb{Z}} = \{ \dots, L_{-j}, \dots, L_{-2}, L_{-1}, L_0, L_1, L_2, \dots, L_j, \dots \} = \{ L_j, j \in \mathbb{Z} \},$$

i.e. the set of extended labels with positive and negative indexes.

Similarly, one defines $L_{\mathbb{Q}} \triangleq \{ L_q, q \in \mathbb{Q} \}$ as the set of labels whose indexes are fractions. $L_{\mathbb{Q}}$ is isomorphic with \mathbb{Q} through the isomorphism $f_{\mathbb{Q}}(L_q) = \frac{q}{m+1}$ for any $q \in \mathbb{Q}$.

Even more general, we can define:

$$L_{\mathbb{R}} \triangleq \left\{ \frac{r}{m+1}, r \in \mathbb{R} \right\}$$

where \mathbb{R} is the set of all real numbers. $L_{\mathbb{R}}$ is isomorphic with \mathbb{R} through the isomorphism $f_{\mathbb{R}}(L_r) = \frac{r}{m+1}$ for any $r \in \mathbb{R}$.

2.2 DSm field and linear algebra of refined labels

We will prove that $(L_{\mathbb{R}}, +, \times)$ is a field, where $+$ is the vector addition of labels, and \times is the vector multiplication of labels which is called the *DSm field of refined labels*. Therefore, for the first time we introduce decimal or refined labels, i.e. labels whose index is decimal. For example: $L_{\frac{3}{2}}$ which is $L_{1.5}$ means a label in the middle of the label interval $[L_1, L_2]$. We also theoretically introduce *negative* labels, L_{-i} which is equal to $-L_i$, that occur in qualitative calculations.

Even more, $(L_{\mathbb{R}}, +, \times, \cdot)$, where \cdot means scalar product, is a commutative linear algebra over the field of real numbers \mathbb{R} , with unit element, and whose each non-null element is invertible with respect to the multiplication of labels. This is called the *DSm Linear Algebra of Refined labels* (DSm-LARL for short).

2.2.1 Qualitative operators on DSm-LARL

Let's define the *qualitative operators* on this linear algebra. Let a, b, c in \mathbb{R} , and the labels $L_a = \frac{a}{m+1}$, $L_b = \frac{b}{m+1}$ and $L_c = \frac{c}{m+1}$. Let the scalars α, β in \mathbb{R} .

- **Vector Addition (addition of labels):**

$$L_a + L_b = L_{a+b} \quad (2.1)$$

$$\text{since } \frac{a}{m+1} + \frac{b}{m+1} = \frac{a+b}{m+1}.$$

- **Vector Subtraction (subtraction of labels):**

$$L_a - L_b = L_{a-b} \quad (2.2)$$

$$\text{since } \frac{a}{m+1} - \frac{b}{m+1} = \frac{a-b}{m+1}.$$

- **Vector Multiplication (multiplication of labels):**

$$L_a \times L_b = L_{(ab)/(m+1)} \quad (2.3)$$

$$\text{since } \frac{a}{m+1} \cdot \frac{b}{m+1} = \frac{(ab)/(m+1)}{m+1}.$$

- **Scalar Multiplication (number times label):**

$$\alpha \cdot L_a = L_a \cdot \alpha = L_{\alpha a} \quad (2.4)$$

$$\text{since } \alpha \cdot \frac{a}{m+1} = \frac{\alpha a}{m+1}.$$

As a particular case, for $\alpha = -1$, we get: $-L_a = L_{-a}$.

$$\text{Also, } \frac{L_a}{\beta} = L_a \div \beta = \frac{1}{\beta} \cdot L_a = L_{\frac{a}{\beta}}.$$

- **Vector Division (division of labels):**

$$L_a \div L_b = L_{(a/b)(m+1)} \quad (2.5)$$

$$\text{since } \frac{a}{m+1} \div \frac{b}{m+1} = \frac{a}{b} = \frac{(a/b)(m+1)}{m+1}.$$

- **Scalar Power:**

$$(L_a)^p = L_{a^p/(m+1)^{p-1}} \quad (2.6)$$

$$\text{since } \left(\frac{a}{m+1}\right)^p = \frac{a^p/(m+1)^{p-1}}{m+1}, \forall p \in \mathbb{R}.$$

- **Scalar Root:**

$$\sqrt[k]{L_a} = (L_a)^{\frac{1}{k}} = L_{a^{\frac{1}{k}}/(m+1)^{\frac{1}{k}-1}} \quad (2.7)$$

which results from replacing $p = \frac{1}{k}$ in the power formula (2.6), $\forall k$ integer ≥ 2 .

2.2.2 The DSm field of refined labels

Since $(L_{\mathbb{R}}, +, \times)$ is isomorphic with the set of real numbers $(\mathbb{R}, +, \times)$, it results that $(L_{\mathbb{R}}, +, \times)$ is a field, called *DSm field of refined labels*. The field isomorphism: $f_{\mathbb{R}} : L_{\mathbb{R}} \rightarrow \mathbb{R}$, $f_{\mathbb{R}}(L_r) = \frac{r}{m+1}$ satisfies the axioms:

Axiom A1:

$$f_{\mathbb{R}}(L_a + L_b) = f_{\mathbb{R}}(L_a) + f_{\mathbb{R}}(L_b) \quad (2.8)$$

since $f_{\mathbb{R}}(L_a + L_b) = f_{\mathbb{R}}(L_{a+b}) = \frac{a+b}{m+1}$ and $f_{\mathbb{R}}(L_a) + f_{\mathbb{R}}(L_b) = \frac{a}{m+1} + \frac{b}{m+1} = \frac{a+b}{m+1}$.

Axiom A2:

$$f_{\mathbb{R}}(L_a \times L_b) = f_{\mathbb{R}}(L_a) \cdot f_{\mathbb{R}}(L_b) \quad (2.9)$$

since $f_{\mathbb{R}}(L_a \times L_b) = f_{\mathbb{R}}(L_{(ab)/(m+1)}) = \frac{ab}{m+1}$ and $f_{\mathbb{R}}(L_a) \cdot f_{\mathbb{R}}(L_b) = \frac{a}{m+1} \cdot \frac{b}{m+1} = \frac{ab}{(m+1)^2}$.

$(L_{\mathbb{R}}, +, \cdot)$ is a *vector space of refined labels* over the field of real numbers \mathbb{R} , since $(L_{\mathbb{R}}, +)$ is a commutative group, and the scalar multiplication (which is an external operation) verifies the axioms:

Axiom B1:

$$1 \cdot L_a = L_{1 \cdot a} = L_a \quad (2.10)$$

Axiom B2:

$$(\alpha \cdot \beta) \cdot L_a = \alpha \cdot (\beta \cdot L_a) \quad (2.11)$$

since both, left and right sides, are equal to $L_{\alpha\beta a}$

Axiom B3:

$$\alpha \cdot (L_a + L_b) = \alpha \cdot L_a + \alpha \cdot L_b \quad (2.12)$$

since $\alpha \cdot (L_a + L_b) = \alpha \cdot L_{a+b} = L_{\alpha(a+b)} = L_{\alpha a + \alpha b} = L_{\alpha a} + L_{\alpha b} = \alpha \cdot L_a + \alpha \cdot L_b$.

Axiom B4:

$$(\alpha + \beta) \cdot L_a = \alpha \cdot L_a + \beta \cdot L_a \quad (2.13)$$

since $(\alpha + \beta) \cdot L_a = L_{(\alpha+\beta)a} = L_{\alpha a + \beta a} = L_{\alpha a} + L_{\beta a} = \alpha \cdot L_a + \beta \cdot L_a$.

$(L_{\mathbb{R}}, +, \times, \cdot)$ is a *Linear Algebra of Refined Labels* over the field \mathbb{R} of real numbers, called *DSm Linear Algebra of Refined Labels* (DSm-LARL for short), which is commutative, with identity element (which is L_{m+1}) for vector multiplication, and whose non-null elements (labels) are invertible with respect to the vector multiplication. This occurs since $(L_{\mathbb{R}}, +, \cdot)$ is a vector space, $(L_{\mathbb{R}}, \times)$ is a commutative group, the set of scalars \mathbb{R} is well-known as a field, and also one has:

- The vector multiplication is associative:

Axiom C1 (Associativity of vector multiplication):

$$L_a \times (L_b \times L_c) = (L_a \times L_b) \times L_c \quad (2.14)$$

since $L_a \times (L_b \times L_c) = L_a \times L_{(b \cdot c)/(m+1)} = L_{(a \cdot b \cdot c)/(m+1)^2}$ while $(L_a \times L_b) \times L_c = L_{(ab)/(m+1)} \times L_c = L_{(a \cdot b \cdot c)/(m+1)^2}$ as well.

- The vector multiplication is distributive with respect to addition:

Axiom C2:

$$L_a \times (L_b + L_c) = L_a \times L_b + L_a \times L_c \quad (2.15)$$

since $L_a \times (L_b + L_c) = L_a \times L_{b+c} = L_{(a \cdot (b+c))/(m+1)}$ and $L_a \times L_b + L_a \times L_c = L_{(ab)/(m+1)} + L_{(ac)/(m+1)} = L_{(ab+ac)/(m+1)} = L_{(a(b+c))/(m+1)}$.

Axiom C3:

$$(L_a + L_b) \times L_c = L_a \times L_c + L_b \times L_c \quad (2.16)$$

since $(L_a + L_b) \times L_c = L_{a+b} \times L_c = L_{((a+b)c)/(m+1)} = L_{(ac+bc)/(m+1)} = L_{(ac)/(m+1)} + L_{(bc)/(m+1)} = L_a \times L_c + L_b \times L_c$.

Axiom C4:

$$\alpha \cdot (L_a \times L_b) = (\alpha \cdot L_a) \times L_b = L_a \times (\alpha \cdot L_b) \quad (2.17)$$

since $\alpha \cdot (L_a \times L_b) = \alpha \cdot L_{(ab)/(m+1)} = L_{(\alpha ab)/(m+1)} = L_{((\alpha a)b)/(m+1)} = L_{\alpha a} \times L_b = (\alpha \cdot L_a) \times L_b$; but also $L_{(\alpha ab)/(m+1)} = L_{(a(\alpha b))/(m+1)} = L_a \times L_{\alpha b} = L_a \times (\alpha \cdot L_b)$.

- The *Unitary Element* for vector multiplication is L_{m+1} , since

Axiom D1:

$$L_a \times L_{m+1} = L_{m+1} \times L_a = L_{(a(m+1))/(m+1)} = L_a, \forall a \in \mathbb{R}. \quad (2.18)$$

- All $L_a \neq L_0$ are *invertible* with respect to vector multiplication and the inverse of L_a is $(L_a)^{-1}$ with:

Axiom E1:

$$(L_a)^{-1} = L_{(m+1)^2/a} = \frac{1}{L_a} \quad (2.19)$$

since $L_a \times (L_a)^{-1} = L_a \times L_{(m+1)^2/a} = L_{(a \cdot (m+1)^2/a)/(m+1)} = L_{m+1}$.

Therefore the DSm linear algebra is a *Division Algebra*. DSm Linear Algebra is also a trivial Lie Algebra since we can define a law:

$$(L_a, L_b) \rightarrow [L_a, L_b] = L_a \times L_b - L_b \times L_a = L_0$$

such that

$$[L_a, L_a] = L_0 \tag{2.20}$$

and Jacobi identity is satisfied:

$$[L_a, [L_b, L_c]] + [L_b, [L_c, L_a]] + [L_c, [L_a, L_b]] = L_0 \tag{2.21}$$

Actually $(L_{\mathbb{R}}, +, \times, \cdot)$ is a field, and therefore in particular a ring, and any ring with the law: $[x, y] = xy - yx$ is a Lie Algebra.

We can extend the field isomorphism $f_{\mathbb{R}}$ to a linear algebra isomorphism by defining¹: $f_{\mathbb{R}} : \mathbb{R} \cdot L_{\mathbb{R}} \rightarrow \mathbb{R} \cdot \mathbb{R}$ with $f_{\mathbb{R}}(\alpha \cdot L_{r_1}) = \alpha \cdot f_{\mathbb{R}}(L_{r_1})$ since $f_{\mathbb{R}}(\alpha \cdot L_{r_1}) = f_{\mathbb{R}}(L_{(\alpha \cdot r_1)}) = \alpha \cdot r_1 / (m + 1) = \alpha \cdot \frac{r_1}{m + 1} = \alpha \cdot f_{\mathbb{R}}(L_{r_1})$. Since $(\mathbb{R}, +, \cdot)$ is a trivial linear algebra over the field of reals \mathbb{R} , and because $(L_{\mathbb{R}}, +, \cdot)$ is isomorphic with it through the above $f_{\mathbb{R}}$ linear algebra isomorphism, it results that $(L_{\mathbb{R}}, +, \cdot)$ is also a linear algebra which is associative and commutative.

2.3 New operators

Let's now define new operators, such as scalar-vector (mixed) addition, scalar-vector (mixed) subtraction, scalar-vector (mixed) division, vector power, and vector root.

They might be surprising since such "strange" operators have not been defined in science, but for DSm linear Algebra they make perfect sense since $(L_{\mathbb{R}}, +, \times)$ is isomorphic to $(\mathbb{R}, +, \times)$ and a label is equivalent to a real number, since for a fixed $m \geq 1$ we have

$$\forall L_a \in L_{\mathbb{R}}, \exists! r \in \mathbb{R}, r = \frac{a}{m + 1} \quad \text{such that} \quad L_a = r$$

and reciprocally

$$\forall r \in \mathbb{R}, \exists! L_a \in L_{\mathbb{R}}, L_a = L_{r(m+1)} \quad \text{such that} \quad r = L_a$$

In consequence, we can substitute a real number by a label, and reciprocally.

¹where \cdot denotes the scalar multiplication.

- **Scalar-vector (mixed) addition:**

$$L_a + \alpha = \alpha + L_a = L_{a+\alpha(m+1)} \quad (2.22)$$

since $L_a + \alpha = L_a + \frac{\alpha(m+1)}{(m+1)} = L_a + L_{\alpha(m+1)} = L_{a+\alpha(m+1)}$.

- **Scalar-vector (mixed) subtractions:**

$$L_a - \alpha = L_{a-\alpha(m+1)} \quad (2.23)$$

since $L_a - \alpha = L_a - \frac{\alpha(m+1)}{(m+1)} = L_a - L_{\alpha(m+1)} = L_{a-\alpha(m+1)}$.

$$\alpha - L_a = L_{\alpha(m+1)-a} \quad (2.24)$$

since $\alpha - L_a = \frac{\alpha(m+1)}{(m+1)} - L_a = L_{\alpha(m+1)} - L_a = L_{\alpha(m+1)-a}$.

- **Scalar-vector (mixed) divisions:**

$$L_a \div \alpha = \frac{L_a}{\alpha} = \frac{1}{\alpha} \cdot L_a = L_{\frac{a}{\alpha}}, \text{ for } \alpha \neq 0, \quad (2.25)$$

which is equivalent to the scalar multiplication $(\frac{1}{\alpha}) \cdot L_a$ where $\frac{1}{\alpha} \in \mathbb{R}$.

$$\alpha \div L_a = L_{\frac{\alpha(m+1)^2}{a}} \quad (2.26)$$

since $\alpha \div L_a = \frac{\alpha(m+1)}{m+1} \div L_a = L_{\alpha(m+1)} \div L_a = L_{\alpha(m+1)/a \cdot (m+1)} = L_{\frac{\alpha(m+1)^2}{a}}$.

- **Vector power:**

$$(L_a)^{L_b} = L_{a \frac{b}{m+1} / (m+1)^{\frac{b-m-1}{m+1}}} \quad (2.27)$$

since $(L_a)^{L_b} = (L_a)^{\frac{b}{m+1}} = L_{a \frac{b}{m+1} / (m+1)^{\frac{b}{m+1}-1}} = L_{a \frac{b}{m+1} / (m+1)^{\frac{b-m-1}{m+1}}}$
where we replaced $p = \frac{b}{m+1}$ in the scalar product formula.

- **Vector root:**

$$\sqrt[b]{L_a} = L_{a \frac{m+1}{b} / (m+1)^{\frac{m-b+1}{b}}} \quad (2.28)$$

since $\sqrt[b]{L_a} = (L_a)^{\frac{1}{L_b}} = (L_a)^{\frac{1}{b/(m+1)}} = (L_a)^{\frac{m+1}{b}} = L_{a \frac{m+1}{b} / (m+1)^{\frac{m+1}{b}-1}} = L_{a \frac{m+1}{b} / (m+1)^{\frac{m-b+1}{b}}}$.

$L_{\mathbb{R}}$ endowed with all these scalar and vector (addition, subtraction, multiplication, division, power, and root) operators becomes a powerful mathematical tool in the DSm field and simultaneously linear algebra of refined labels.

Therefore, if we want to work with only 1-Tuple labels (ordinary labels), in all these operators we set the restrictions that indexes are integers belonging to $\{0, 1, 2, \dots, m, m+1\}$; if an index is less than 0 then we force it to be 0, and if greater than $m+1$ we force it to $m+1$.

2.4 Working with 2-tuple labels

For 2-Tuple labels defined by Herrera and Martinez [3], that have the form (L_i, σ_i^h) where i is an integer and σ_i^h is a remainder in $[-\frac{0.5}{m+1}, \frac{0.5}{m+1})$, we use the scalar addition (when $\sigma_i^h \geq 0$) or scalar subtraction (when $\sigma_i^h < 0$) as defined previously in order to transform a 2-Tuple label into a refined label and then we use all previous twelve operators defined in FLARL. Actually, $(L_i, \sigma_i^h) = L_i + \sigma_i^h$ and it doesn't matter if σ_i^h is positive, zero, or negative.

2.5 Working with interval of labels

Interval of labels (i.e. imprecise labels) in the DSm Linear Algebra are intervals of the form $[L_{r_1}, L_{r_2}]$, $[L_{r_1}, L_{r_2})$, $(L_{r_1}, L_{r_2}]$, (L_{r_1}, L_{r_2}) where $r_1, r_2 \in \mathbb{R}$ and $r_1 < r_2$. To observe that r_1 and r_2 can be positive, negative, zero, decimals, etc. For $r_1 = r_2$, the closed labeled interval $[L_{r_1}, L_{r_2}] \equiv L_{r_1} \equiv L_{r_2}$, while the other intervals are empty.

For intervals of labels or, more general, for sets of labels, we use the operations on sets (addition, subtraction, multiplication, division, power, root of sets) employed in working with imprecise information as proposed in [5].

2.6 Concluding remark

All previous four categories of labels: 1-Tuple labels, 2-Tuple labels, Imprecise labels, and specially refined labels can be enriched. Enrichment of a category of labels means that one take into account also the degree of confidence in each label (or in each interval of labels), as in statistics. For example, the refined labels $L_i(c_i)$ means that we are c_i percent confident in label L_i , where $c_i \in [0, 1]$. L_i and c_i are independent, which means that we apply all previous twelve qualitative operators on L_i 's, while for the percentage c_i we can use quantitative operators such as min, max, average, etc. To remark that σ_i^h from Herrera-Martinez 2-Tuple labels is not independent from L_i that is associated and σ_i^h

can be interpreted as a refinement factor of L_i whereas c_i is interpreted as a confidence factor for L_i . Therefore, c_i from enriched labels is different from σ_i^h from 2-Tuple labels and they have totally different meanings. From the refined label model of qualitative beliefs and the previous operators, we are able to extend the DSm classic (DSmC) and the PCR5 numerical fusion rules proposed in Dezert-Smarandache Theory (DSmT) and all other numerical fusion rules from any fusion theory (DST, TBM, etc.) in the qualitative domain.

2.7 References

- [1] A. Bouvier, M. George, F. Le Lionnais, *Dictionnaire des Mathématiques*, article *Algèbre sur un corps commutatif ou K-algèbre*, p. 22, Presses Universitaires de France, Paris, 1979.
- [2] J. Hefferon, *Linear Algebra*, Mathematics, Saint Michael's College, Colchester, Vermont USA 05439, USA, 449 pages, 2008, free e-Book available at <http://joshua.smcvt.edu/linearalgebra/>
- [3] F. Herrera, L. Martínez, *A 2-Tuple fuzzy linguistic representation model for computing with words*, IEEE Trans. on Fuzzy Systems, Vol-8, No-6, pp. 746-752, 2000.
- [4] I. D. Ion, N. Radu, *Algebra*, Ed. Didactica si Pedagogica, Bucharest, 1981.
- [5] F. Smarandache, J. Dezert, (Editors), *Advances and Applications of DSmT for Information Fusion (Collected Works)*, American Research Press, Rehoboth, 2004. <http://www.gallup.unm.edu/~smarandache/DSmT-book1.pdf>

Chapter 3

Transformations of belief masses into subjective probabilities

Jean Dezert
The French Aerospace Lab,
ONERA/DTIM/SIF,
29 Av. de la Division Leclerc,
92320 Châtillon,
France.
Jean.Dezert@onera.fr

Florentin Smarandache
Chair of Math. & Sciences Dept.
Department of Mathematics,
University of New Mexico,
Gallup, NM 87301,
U.S.A.
smarand@unm.edu

Abstract: *In this chapter, we propose in the DSMT framework, a new probabilistic transformation, called DSMP, in order to build a subjective probability measure from any basic belief assignment defined on any model of the frame of discernment. Several examples are given to show how the DSMP transformation works and we compare it to main existing transformations proposed in the literature so far. We show the advantages of DSMP over classical transformations in term of Probabilistic Information Content (PIC). The direct extension of this transformation for dealing with qualitative belief assignments is also presented. This theoretical work must increase the performances of DSMT-based hard-decision based systems as well as in soft-decision based systems in many fields where it could be used, i.e. in biometrics, medicine, robotics, surveillance and threat assessment, multisensor-multitarget tracking for military and civilian applications, etc.*

3.1 Introduction

In the theories of belief functions, Dempster-Shafer Theory (DST) [10], Transferable Belief Model (TBM) [15] or DS_mT [12, 13], the mapping from the belief to the probability domain is a controversial issue. The original purpose of such mappings was to make a (hard) decision, but contrariwise to erroneous widespread idea/claim, this is not the only interest for using such mappings nowadays. Actually the probabilistic transformations of belief mass assignments are very useful in modern multitarget multisensor tracking systems (or in any other systems) where one deals with soft decisions (i.e. where all possible solutions are kept for state estimation with their likelihoods). For example, in a Multiple Hypotheses Tracker using both kinematical and attribute data, one needs to compute all probabilities values for deriving the likelihoods of data association hypotheses and then mixing them altogether to estimate states of targets. Therefore, it is very relevant to use a mapping which provides a high probabilistic information content (PIC) for expecting better performances. This perfectly justifies the theoretical work proposed in this chapter. A classical transformation is the so-called *pignistic probability* [16], denoted *BetP*, which offers a good compromise between the maximum of credibility *Bel* and the maximum of plausibility *Pl* for decision support. Unfortunately, *BetP* doesn't provide the highest PIC in general as pointed out by Sudano [17–19]. We propose hereafter a new generalized pignistic transformation, denoted *DS_mP*, which is justified by the maximization of the PIC criterion. An extension of this transformation in the qualitative domain is also presented. This chapter is an extended version of a paper presented at Fusion 2008 conference in Cologne, Germany [7]. An application of *DS_mP* for the Target Type Tracking problem will be presented in Chapter 16.

3.2 Classical and generalized pignistic probabilities

3.2.1 Classical pignistic probability

The basic idea of the classical pignistic probability proposed and coined by Philippe Smets in [14, 16] consists in transferring the positive mass of belief of each non specific element onto the singletons involved in that element split by the cardinality of the proposition when working with normalized basic belief assignments (bba's). The (classical) pignistic probability in TBM framework is given by¹ $BetP(\emptyset) = 0$ and $\forall X \in 2^\Theta \setminus \{\emptyset\}$ by:

¹We assume that $m(\cdot)$ is of course a non degenerate bba, i.e. $m(\emptyset) \neq 1$.

$$BetP(X) = \sum_{Y \in 2^\Theta, Y \neq \emptyset} \frac{|X \cap Y|}{|Y|} \frac{m(Y)}{1 - m(\emptyset)}, \quad (3.1)$$

where 2^Θ is the power set of the finite and discrete frame Θ assuming Shafer's model, i.e. all elements of Θ are assumed truly exclusive.

In Shafer's approach, $m(\emptyset) = 0$ and the formula (3.1) can be rewritten for any singleton $\theta_i \in \Theta$ as

$$BetP(\theta_i) = \sum_{\substack{Y \in 2^\Theta \\ \theta_i \subseteq Y}} \frac{1}{|Y|} m(Y) = m(\theta_i) + \sum_{\substack{Y \in 2^\Theta \\ \theta_i \subset Y}} \frac{1}{|Y|} m(Y) \quad (3.2)$$

3.2.2 Generalized pignistic probability

The classical pignistic probability has been generalized in DSMT framework for any regular bba $m(\cdot) : G^\Theta \mapsto [0, 1]$ (i.e. such that $m(\emptyset) = 0$ and $\sum_{X \in G^\Theta} m(X) = 1$) and for any model of the frame (free DSMT model, hybrid DSMT model and Shafer's model as well). A detailed presentation of this transformation with several examples can be found in Chapter 7 of [12]. It is given by $BetP(\emptyset) = 0$ and $\forall X \in G^\Theta \setminus \{\emptyset\}$ by

$$BetP(X) = \sum_{Y \in G^\Theta} \frac{\mathcal{C}_M(X \cap Y)}{\mathcal{C}_M(Y)} m(Y) \quad (3.3)$$

where G^Θ corresponds to the hyper-power set including all the integrity constraints of the model (if any)²; $\mathcal{C}_M(Y)$ denotes the DSMT cardinal³ of the set Y . The formula (3.3) reduces to (3.2) when G^Θ reduces to classical power set 2^Θ when one adopts Shafer's model.

3.3 Sudano's probabilities

indexSudano's probabilities

John Sudano has proposed several transformations for approximating any quantitative belief mass $m(\cdot)$ by a subjective probability measure [21]. These

² $G^\Theta = 2^\Theta$ if one adopts Shafer's model for Θ and $G^\Theta = D^\Theta$ (Dedekind's lattice) if one adopts the free DSMT model for Θ [12].

³ $\mathcal{C}_M(Y)$ is the number of parts of Y in the Venn diagram of the model \mathcal{M} of the frame Θ under consideration [12] (Chap. 7).

transformations were denoted $PrPl$, $PrNPl$, $PraPl$, $PrBel$ and $PrHyb$, and were all defined in DST framework. They use different kinds of mappings either proportional to the plausibility, to the normalized plausibility, to all plausibilities, to the belief, or a hybrid mapping.

$PrPl(\cdot)$ and $PrBel(\cdot)$ transformations are mathematically defined⁴ as follows for all $X \neq \emptyset \in \Theta$:

$$PrPl(X) = Pl(X) \cdot \sum_{\substack{Y \in 2^\Theta \\ X \subseteq Y}} \frac{1}{CS[Pl(Y)]} m(Y) \quad (3.4)$$

$$PrBel(X) = Bel(X) \cdot \sum_{\substack{Y \in 2^\Theta \\ X \subseteq Y}} \frac{1}{CS[Bel(Y)]} m(Y) \quad (3.5)$$

where the denominators involved in the formulas are given by the compound-to-sum of singletons $CS[\cdot]$ operator defined by [17]:

$$CS[Pl(Y)] \triangleq \sum_{\substack{Y_i \in 2^\Theta \\ |Y_i|=1 \\ \cup_i Y_i=Y}} Pl(Y_i) \quad \text{and} \quad CS[Bel(Y)] \triangleq \sum_{\substack{Y_i \in 2^\Theta \\ |Y_i|=1 \\ \cup_i Y_i=Y}} Bel(Y_i)$$

$PrNPl(\cdot)$, $PraPl(\cdot)$ and $PrHyb(\cdot)$ also proposed by John Sudano [17, 21] are defined as follows:

- The mapping proportional to the *normalized* plausibility

$$PrNPl(X) = \frac{1}{\Delta} \sum_{\substack{Y \in 2^\Theta \\ Y \cap X \neq \emptyset}} m(Y) = \frac{1}{\Delta} \cdot Pl(X) \quad (3.6)$$

where Δ is a normalization factor such that $\sum_{X \in \Theta} PrNPl(X) = 1$.

- The mapping proportional to *all* plausibilities

$$PraPl(X) = Bel(X) + \epsilon \cdot Pl(X) \quad (3.7)$$

with

$$\epsilon \triangleq \frac{1 - \sum_{Y \in 2^\Theta} Bel(Y)}{\sum_{Y \in 2^\Theta} Pl(Y)}$$

⁴For notational convenience and simplicity, we use a different but equivalent notation than the one originally proposed by John Sudano in his publications.

- The hybrid pignistic probability

$$PrHyb(X) = PraPl(X) \cdot \sum_{\substack{Y \in 2^\Theta \\ X \subseteq Y}} \frac{1}{CS[PraPl(Y)]} m(Y) \quad (3.8)$$

with

$$CS[PraPl(Y)] \triangleq \sum_{\substack{Y_i \in 2^\Theta \\ |Y_i|=1 \\ \cup_i Y_i=Y}} PraPl(Y_i)$$

- The pedigree pignistic probability [18]: It is denoted $PrPed(\cdot)$ and was introduced by John Sudano in [18]. $PrPed(\cdot)$ uses the *combined* bba's with the probability proportionally functions to compute a better pignistic probability estimate when used in conjunction with the Generalized belief fusion algorithm [sic [19]]. This kind of transformation is out of the scope of this chapter, since it cannot be applied directly for approximating a bba $m(\cdot)$ without reference to some prior bba's and a fusion rule. Here we search for an efficient approximation of $m(\cdot)$ by a subjective probability measure without any other considerations on how $m(\cdot)$ has been obtained. We just want to use the minimal information available about $m(\cdot)$, i.e. the values of $m(A)$ for all $A \in G^\Theta$.

3.4 Cuzzolin's intersection probability

In 2007, a new transformation has been proposed in [4] by Fabio Cuzzolin in the framework of DST. From a geometric interpretation of Dempster's rule, an *Intersection Probability* measure was proposed from the proportional repartition of the Total Non Specific Mass⁵ (TNSM) by each contribution of the non-specific masses involved in it. For notational convenience, we will denote it $CuzzP$ in the sequel.

3.4.1 Definition

$CuzzP(\cdot)$ is defined on any finite and discrete frame $\Theta = \{\theta_1, \dots, \theta_n\}$, $n \geq 2$, satisfying Shafer's model, by

$$CuzzP(\theta_i) = m(\theta_i) + \frac{\Delta(\theta_i)}{\sum_{j=1}^n \Delta(\theta_j)} \times TNSM \quad (3.9)$$

⁵i.e. the mass committed to partial and total ignorances, i.e. to disjunctions of elements of the frame.

with $\Delta(\theta_i) \triangleq Pl(\theta_i) - m(\theta_i)$ and

$$TNSM = 1 - \sum_{j=1}^n m(\theta_j) = \sum_{A \in 2^\Theta, |A| > 1} m(A) \quad (3.10)$$

3.4.2 Remarks

While appealing at the first glance because of its interesting geometric justification, Cuzzolin's transformation seems to be not totally satisfactory in our point of view for approximating any belief mass $m(\cdot)$ into subjective probability for the following reasons:

1. Although (3.9) does not include explicitly Dempster's rule, its geometrical justification [2–4, 6] is strongly conditioned by the acceptance of Dempster's rule as the fusion operator for belief functions. This is a dogmatic point of view we disagree with since it has been recognized for many years by different experts of AI community, that other fusion rules can offer better performances, especially for cases where highly conflicting sources are involved.
2. Some parts of the masses of partial ignorance, say A , involved in the TNSM, are also transferred to singletons, say $\theta_i \in \Theta$ which are not included in A (i.e. such that $\{\theta_i\} \cap A = \emptyset$). Such transfer is not justified and does not make sense in our point of view. To be more clear, let's take $\Theta = \{A, B, C\}$ and $m(\cdot)$ defined on its power set with all masses strictly positive. In that case, $m(A \cup B) > 0$ does count in TNSM and thus it is a bit redistributed back to C with the ratio $\frac{\Delta(C)}{\Delta(A) + \Delta(B) + \Delta(C)}$ through $TNSM > 0$. There is no solid reason for committing partially $m(A \cup B)$ to C since, only A and B are involved in that partial ignorance. Similar remarks hold for the partial redistribution of $m(A \cup C) > 0$.
3. It is easy to verify moreover that $CuzzP(\cdot)$ is mathematically not defined when $m(\cdot)$ is already a probabilistic belief mass because in such case all terms $\Delta(\cdot)$ equal zero in (3.9) so that one gets 0/0 indetermination in Cuzzolin's formula. This remark is important only from the mathematical point of view.

3.5 A new generalized pignistic transformation

We propose a new generalized pignistic transformation, denoted $DSmP$ to avoid confusion with the previous existing transformations, which is straightforward, and also different from Sudano's and Cuzzolin's redistributions which

are more refined but less exact in our opinions than what we present here. The basic idea of our $DSmP(\cdot)$ transformation consists in a new way of proportionalizations of the mass of each partial ignorance such as $A_1 \cup A_2$ or $A_1 \cup (A_2 \cap A_3)$ or $(A_1 \cap A_2) \cup (A_3 \cap A_4)$, etc. and the mass of the total ignorance $A_1 \cup A_2 \cup \dots \cup A_n$, to the elements involved in the ignorances. This new transformation takes into account both the values of the masses and the cardinality of elements in the proportional redistribution process. We first present the general formula for this new transformation, and the numerical examples, and comparisons with respect to other transformations are given in next sections.

3.5.1 The DSmP formula

Let's consider a discrete frame Θ with a given model (free DSm model, hybrid DSm model or Shafer's model), the $DSmP$ mapping is defined by $DSmP_\epsilon(\emptyset) = 0$ and $\forall X \in G^\Theta \setminus \{\emptyset\}$ by

$$DSmP_\epsilon(X) = \sum_{Y \in G^\Theta} \frac{\sum_{\substack{Z \subset X \cap Y \\ \mathcal{C}(Z)=1}} m(Z) + \epsilon \cdot \mathcal{C}(X \cap Y)}{\sum_{\substack{Z \subset Y \\ \mathcal{C}(Z)=1}} m(Z) + \epsilon \cdot \mathcal{C}(Y)} m(Y) \quad (3.11)$$

where $\epsilon \geq 0$ is a tuning parameter and G^Θ corresponds to the hyper-power set including eventually all the integrity constraints (if any) of the model \mathcal{M} ; $\mathcal{C}(X \cap Y)$ and $\mathcal{C}(Y)$ denote the DSm cardinals⁶ of the sets $X \cap Y$ and Y respectively.

The parameter ϵ allows to reach the maximum PIC value of the approximation of $m(\cdot)$ into a subjective probability measure. The smaller ϵ , the better/bigger PIC value. In some particular degenerate cases however, the $DSmP_{\epsilon=0}$ values cannot be derived, but the $DSmP_{\epsilon>0}$ values can however always be derived by choosing ϵ as a very small positive number, say $\epsilon = 1/1000$ for example in order to be as close as we want to the maximum of the PIC (see the next sections for details and examples).

It is interesting to note also that when $\epsilon = 1$ and when the masses of all elements Z having $\mathcal{C}(Z) = 1$ are zero, (3.11) reduces to (3.3), i.e. $DSmP_{\epsilon=1} = BetP$. The passage from a free DSm model to a Shafer's model induces a

⁶We have omitted the index of the model \mathcal{M} for notational convenience.

change in the Venn diagram representation, and so the cardinals change as well in the formula (3.11).

If one works on a (ultimate refined) frame Θ , which implies that Shafer's model holds, then the $DSmP_\epsilon(\theta_i)$ probability of any element θ_i , $i = 1, 2, \dots, n$ of the frame $\Theta = \{\theta_1, \dots, \theta_n\}$ can be directly obtained by:

$$DSmP_\epsilon(\theta_i) = m(\theta_i) + (m(\theta_i) + \epsilon) \sum_{\substack{X \in 2^\Theta \\ X \supset \theta_i \\ c(X) \geq 2}} \frac{m(X)}{\sum_{\substack{Y \in 2^\Theta \\ Y \subset X \\ c(Y)=1}} m(Y) + \epsilon \cdot C(X)} \quad (3.12)$$

The probabilities of (partial or total) ignorances are then obtained from the additivity property of the probabilities of elementary exclusive elements, i.e. for $i, j = 1, \dots, n$, $i \neq j$, $DSmP_\epsilon(\theta_i \cup \theta_j) = DSmP_\epsilon(\theta_i) + DSmP_\epsilon(\theta_j)$, etc.

3.5.2 Advantages of DSmP

$DSmP$ works for all models (free, hybrid and Shafer's). In order to apply classical $BetP$, $CuzzP$ or Sudano's mappings, we need at first to refine the frame (on the cases when it is possible!) in order to work with Shafer's model, and then apply their formulas. In the case where refinement makes sense, then one can apply the other subjective probabilities on the refined frame. $DSmP$ works on the refined frame as well and gives the same result as it does on the non-refined frame. Thus $DSmP$ with $\epsilon > 0$ works on any model and so is very general and appealing. It is a combination of $PrBel$ and $BetP$. $PrBel$ performs a redistribution of an ignorance mass to the singletons involved in that ignorance proportionally with respect to the singleton masses. While $BetP$ also does a redistribution of an ignorance mass to the singletons involved in that ignorance but proportionally with respect to the singleton cardinals. $PrBel$ does not work when the masses of all singletons involved in an ignorance are null since it gives the indetermination $0/0$; and in the case when at least one singleton mass involved in an ignorance is zero, that singleton does not receive any mass from the distribution even if it was involved in an ignorance, which is not fair/good. $BetP$ works all the time, but the redistribution is rough and does not take into account the masses of the singletons.

So, $DSmP$ solves the $PrBel$ problem by doing a redistribution of the ignorance mass with respect to both the singleton masses and the singletons' cardinals in the same time. Now, if all masses of singletons involved in all ig-

norances are different from zero, then we can take $\epsilon = 0$, and $DSmP$ coincides with $PrBel$ and both of them give the best result, i.e. the best PIC value.

$PrNPl$ is not satisfactory since it yields an abnormal behavior. Indeed, in any model, when a bba $m(\cdot)$ is transformed into a probability, normally (we mean it is logically that) the masses of ignorances are transferred to the masses of elements of cardinal 1 (in Shafer's model these elements are singletons). Thus, the resulting probability of an element whose cardinal is 1 should be greater than or equal to the mass of that element. In other words, if A in G^Θ and $\mathcal{C}(A) = 1$, then $P(A) \geq m(A)$ for any probability transformation $P(\cdot)$. This legitimate property is not satisfied by $PrNPl$ as seen in the following example.

Example: Let's consider Shafer's model with $\Theta = \{A, B, C\}$ and $m(A) = 0.2$, $m(B) = m(C) = 0$ and $m(B \cup C) = 0.8$, then the $DSmP$ transformation provides for any $\epsilon > 0$:

$$\begin{aligned} DSmP_\epsilon(A) &= 0.2 = BetP(A) \\ DSmP_\epsilon(B) &= 0.4 = BetP(B) \\ DSmP_\epsilon(C) &= 0.4 = BetP(C) \end{aligned}$$

Applying Sudano's probabilities formulas (3.4)-(3.8), one gets⁷:

- Probability $PrPl(\cdot)$:

$$\begin{aligned} PrPl(A) &= 0.2 \cdot [0.2/0.2] = 0.2 \\ PrPl(B) &= 0.8 \cdot [0.8/(0.8 + 0.8)] = 0.4 \\ PrPl(C) &= 0.8 \cdot [0.8/(0.8 + 0.8)] = 0.4 \end{aligned}$$

- Probability $PrBel(\cdot)$:

$$\begin{aligned} PrBel(A) &= 0.2 \cdot [0.2/0.2] = 0.2 \\ PrBel(B) &= 0 \cdot [0.8/(0 + 0)] = NaN \\ PrBel(C) &= 0 \cdot [0.8/(0 + 0)] = NaN \end{aligned}$$

- Probability $PrNPl(\cdot)$:

$$\begin{aligned} PrNPl(A) &= 0.2/(0.2 + 0.8 + 0.8) \approx 0.1112 \\ PrNPl(B) &= 0.8/(0.2 + 0.8 + 0.8) \approx 0.4444 \\ PrNPl(C) &= 0.8/(0.2 + 0.8 + 0.8) \approx 0.4444 \end{aligned}$$

⁷We use *NaN* acronym here standing for *Not a Number*. We could also use the standard "N/A" standing for "does not apply".

- Probability $PraPl(\cdot)$: $\epsilon = \frac{1-0.2-0-0}{0.2+0.8+0.8} \approx 0.4444$

$$PraPl(A) = 0.2 + 0.4444 \cdot 0.2 \approx 0.2890$$

$$PraPl(B) = 0 + 0.4444 \cdot 0.8 \approx 0.3555$$

$$PraPl(C) = 0 + 0.4444 \cdot 0.8 \approx 0.3555$$

- Probability $PrHyb(\cdot)$:

$$PrHyb(A) = 0.2890 \cdot \left[\frac{0.2}{0.2890} \right] = 0.2$$

$$PrHyb(B) = 0.3555 \cdot \left[\frac{0.8}{0.3555 + 0.3555} \right] = 0.4$$

$$PrHyb(C) = 0.3555 \cdot \left[\frac{0.8}{0.3555 + 0.3555} \right] = 0.4$$

Applying Cuzzolin's probabilities formula (3.9), one gets:

$$\begin{aligned} CuzzP(A) &= m(A) + \frac{\Delta(A)}{\Delta(A) + \Delta(B) + \Delta(C)} \cdot TNSM \\ &= 0.2 + \frac{0}{0 + 0.8 + 0.8} \cdot 0.8 = 0.2 \end{aligned}$$

$$\begin{aligned} CuzzP(B) &= m(B) + \frac{\Delta(B)}{\Delta(A) + \Delta(B) + \Delta(C)} \cdot TNSM \\ &= 0 + \frac{0.8}{0 + 0.8 + 0.8} \cdot 0.8 = 0.4 \end{aligned}$$

$$\begin{aligned} CuzzP(C) &= m(C) + \frac{\Delta(C)}{\Delta(A) + \Delta(B) + \Delta(C)} \cdot TNSM \\ &= 0 + \frac{0.8}{0 + 0.8 + 0.8} \cdot 0.8 = 0.4 \end{aligned}$$

since $TNSM = m(B \cup C) = 0.8$, $\Delta(A) = Pl(A) - m(A) = 0$, $\Delta(B) = Pl(B) - m(B) = 0.8$ and $\Delta(C) = Pl(C) - m(C) = 0.8$.

In such a particular example, $BetP$, $PrPl$, $CuzzP$, $PrHyb$ and $DSmP_{\epsilon > 0}$ transformations coincide. $PrBel(\cdot)$ is mathematically not defined. Such conclusion is not valid in general as we will show in the next examples of this chapter. From this very simple example, one sees clearly the abnormal behavior of $PrNPl(\cdot)$ transformation because $PrNPl(A) = 0.1112 < m(A) = 0.2$; it is not normal that singleton A loses mass when $m(\cdot)$ is transformed into a

subjective probability since the resulted subjective probability of an element whose cardinal is 1 should be greater than or equal to the mass of that element.

In summary, $DSmP$ does an improvement of all Sudano, Cuzzolin, and BetP formulas, in the sense that $DSmP$ mathematically makes a more accurate redistribution of the ignorance masses to the singletons involved in ignorances. $DSmP$ and $BetP$ work in both theories: DST (= Shafer's model) and DSmT (= free or hybrid models) as well. In order to use Sudano's and Cuzzolin's in DSmT models, we have to refine the frame (see Example 3.7.5).

3.6 PIC metric for the evaluation of the transformations

Following Sudano's approach [17, 18, 21], we adopt the Probabilistic Information Content (PIC) criterion as a metric depicting the strength of a critical decision by a specific probability distribution. It is an essential measure in any threshold-driven automated decision system. The PIC is the dual of the normalized Shannon entropy. A PIC value of one indicates the total knowledge (i.e. minimal entropy) or information to make a correct decision (one hypothesis has a probability value of one and the rest are zero). A PIC value of zero indicates that the knowledge or information to make a correct decision does not exist (all the hypothesis have an equal probability value), i.e. one has the maximal entropy. The PIC is used in our analysis to sort the performances of the different pignistic transformations through several numerical examples. We first recall what Shannon entropy and PIC measure are and their tight relationship.

3.6.1 Shannon entropy

Shannon entropy, usually expressed in bits (binary digits), of a discrete probability measure $P\{\cdot\}$ over a discrete finite set $\Theta = \{\theta_1, \dots, \theta_n\}$ is defined by⁸ [11]:

$$H(P) \triangleq - \sum_{i=1}^n P\{\theta_i\} \log_2(P\{\theta_i\}) \quad (3.13)$$

$H(P)$ measures the randomness carried by any discrete probability measure $P\{\cdot\}$. $H(P)$ is maximal for the uniform probability measure over Θ , i.e. when $P\{\theta_i\} = 1/n$ for $i = 1, 2, \dots, n$. In that case, one gets:

⁸with common convention $0 \log_2 0 = 0$ as in [1].

$$H(P) = H_{\max} = - \sum_{i=1}^n \frac{1}{n} \log_2\left(\frac{1}{n}\right) = \log_2(n)$$

$H(P)$ is minimal for a totally *deterministic probability* measure, i.e. for any $P\{\cdot\}$ such that $P\{\theta_i\} = 1$ for some $i \in \{1, 2, \dots, n\}$ and $P\{\theta_j\} = 0$ for $j \neq i$.

3.6.2 The probabilistic information content

The Probabilistic Information Content (PIC) of a discrete probability measure $P\{\cdot\}$ over a discrete finite set $\Theta = \{\theta_1, \dots, \theta_n\}$ is defined by [18]:

$$PIC(P) = 1 + \frac{1}{H_{\max}} \cdot \sum_{i=1}^n P\{\theta_i\} \log_2(P\{\theta_i\}) \quad (3.14)$$

The PIC metric is nothing but the dual of the normalized Shannon entropy and is actually unitless. It actually measures the information content of a probabilistic source characterized by the probability measure $P\{\cdot\}$. The $PIC(P)$ metric takes its values in $[0, 1]$ and is maximum, i.e. $PIC(P) = PIC_{\max} = 1$ with any *deterministic probability* measures. $PIC(P) = PIC_{\min} = 0$ when the probability measure is uniform over the frame Θ , i.e. $P\{\theta_i\} = 1/n$ for $i = 1, 2, \dots, n$. The simple relationships between $H(P)$ and $PIC(P)$ are :

$$PIC(P) = 1 - \frac{H(P)}{H_{\max}} \quad (3.15)$$

$$H(P) = H_{\max} \cdot (1 - PIC(P)) \quad (3.16)$$

3.7 Examples and comparisons on a 2D frame

3.7.1 Example 1: Shafer's model with a general source

Let's consider the 2D frame $\Theta = \{A, B\}$ with Shafer's model (i.e. $A \cap B = \emptyset$) and the non-Bayesian quantitative belief assignment (mass) given in Table 3.1. In this example since one adopts Shafer's model for the frame Θ , G^Θ coincides with 2^Θ , i.e. $G^\Theta = 2^\Theta = \{\emptyset, A, B, A \cup B\}$.

	A	B	$A \cup B$
$m(\cdot)$	0.3	0.1	0.6

Table 3.1: Quantitative input for example 3.7.1

Let's explain in details the derivations of the different transformations⁹:

• **With the pignistic probability:**

$$\text{Bet}P(A) = m(A) + \frac{1}{2}m(A \cup B) = 0.3 + (0.6/2) = 0.60$$

$$\text{Bet}P(B) = m(B) + \frac{1}{2}m(A \cup B) = 0.1 + (0.6/2) = 0.40$$

Since we are working with Shafer's model, the generalized pignistic probability given by (3.3) coincides with the classical pignistic probability.

• **With Sudano's probabilities:**

Applying Sudano's probabilities formulas (3.4)-(3.8), one gets:

- With the probability $\text{Pr}Pl(\cdot)$:

$$\text{Pr}Pl(A) = 0.9 \cdot [0.3/0.9 + 0.6/(0.9 + 0.7)] = 0.6375$$

$$\text{Pr}Pl(B) = 0.7 \cdot [0.1/0.7 + 0.6/(0.9 + 0.7)] = 0.3625$$

- With the probability $\text{Pr}Bel(\cdot)$:

$$\text{Pr}Bel(A) = 0.3 \cdot [0.3/0.3 + 0.6/(0.3 + 0.1)] = 0.7500$$

$$\text{Pr}Bel(B) = 0.1 \cdot [0.1/0.1 + 0.6/(0.3 + 0.1)] = 0.2500$$

- With the probability $\text{Pr}NPl(\cdot)$:

$$\text{Pr}NPl(A) = 0.9/(0.9 + 0.7) = 0.5625$$

$$\text{Pr}NPl(B) = 0.7/(0.9 + 0.7) = 0.4375$$

- With the probability $\text{Pr}aPl(\cdot)$: $\epsilon = \frac{1-0.3-0.1}{0.9+0.7} = 0.375$

$$\text{Pr}aPl(A) = 0.3 + 0.375 \cdot 0.9 = 0.6375$$

$$\text{Pr}aPl(B) = 0.1 + 0.375 \cdot 0.7 = 0.3625$$

- With the probability $\text{Pr}Hyb(\cdot)$:

$$\text{Pr}Hyb(A) = 0.6375 \cdot \left[\frac{0.3}{0.6375} + \frac{0.6}{0.6375 + 0.3625} \right] = 0.6825$$

$$\text{Pr}Hyb(B) = 0.3625 \cdot \left[\frac{0.1}{0.3625} + \frac{0.6}{0.6375 + 0.3625} \right] = 0.3175$$

⁹All results presented here are rounded to their fourth decimal place for convenience.

- **With Cuzzolin's probability:**

Since $TNSM = m(A \cup B) = 0.6$, $\Delta(A) = Pl(A) - m(A) = 0.6$ and $\Delta(B) = Pl(B) - m(B) = 0.6$, one gets

$$CuzzP(A) = m(A) + \frac{\Delta(A)}{\Delta(A) + \Delta(B)} \cdot TNSM = 0.3 + \frac{0.6}{0.6 + 0.6} \cdot 0.6 = 0.6000$$

$$CuzzP(B) = m(B) + \frac{\Delta(B)}{\Delta(A) + \Delta(B)} \cdot TNSM = 0.1 + \frac{0.6}{0.6 + 0.6} \cdot 0.6 = 0.4000$$

- **With DSmP transformation:**

If one uses the DSmP formula (3.11) for this 2D case with Shafer's model, one gets:

$$\begin{aligned} DSmP_{\epsilon}(A) &= \frac{m(A) + \epsilon \cdot \mathcal{C}(A)}{m(A) + \epsilon \cdot \mathcal{C}(A)} \cdot m(A) + \frac{0}{m(B) + \epsilon \cdot \mathcal{C}(B)} \cdot m(B) \\ &\quad + \frac{m(A) + \epsilon \cdot \mathcal{C}(A)}{m(A) + m(B) + \epsilon \cdot \mathcal{C}(A \cup B)} \cdot m(A \cup B) \quad (3.17) \end{aligned}$$

$$\begin{aligned} DSmP_{\epsilon}(B) &= \frac{0}{m(A) + \epsilon \cdot \mathcal{C}(A)} \cdot m(A) + \frac{m(B) + \epsilon \cdot \mathcal{C}(B)}{m(B) + \epsilon \cdot \mathcal{C}(B)} \cdot m(B) \\ &\quad + \frac{m(B) + \epsilon \cdot \mathcal{C}(B)}{m(A) + m(B) + \epsilon \cdot \mathcal{C}(A \cup B)} \cdot m(A \cup B) \quad (3.18) \end{aligned}$$

$$\begin{aligned} DSmP_{\epsilon}(A \cup B) &= \frac{m(A) + \epsilon \cdot \mathcal{C}(A)}{m(A) + \epsilon \cdot \mathcal{C}(A)} \cdot m(A) + \frac{m(B) + \epsilon \cdot \mathcal{C}(B)}{m(B) + \epsilon \cdot \mathcal{C}(B)} \cdot m(B) \\ &\quad + \frac{m(A) + m(B) + \epsilon \cdot \mathcal{C}(A \cup B)}{m(A) + m(B) + \epsilon \cdot \mathcal{C}(A \cup B)} \cdot m(A \cup B) \quad (3.19) \end{aligned}$$

Since we use Shafer's model in this example $\mathcal{C}(A) = \mathcal{C}(B) = 1$ and $\mathcal{C}(A \cup B) = 2$ and finally one gets with the DSmP transformation the following analytical expressions:

$$DSmP_{\epsilon}(A) = m(A) + \frac{m(A) + \epsilon}{m(A) + m(B) + 2 \cdot \epsilon} \cdot m(A \cup B)$$

$$DSmP_{\epsilon}(B) = m(B) + \frac{m(B) + \epsilon}{m(A) + m(B) + 2 \cdot \epsilon} \cdot m(A \cup B)$$

$$DSmP_{\epsilon}(A \cup B) = m(A) + m(B) + m(A \cup B) = 1$$

One can verify that the expressions of $DSmP_{\epsilon}(A)$ and $DSmP_{\epsilon}(B)$ are also consistent with the formula (3.12) and it can be easily verified that

$$DSmP_{\epsilon}(A) + DSmP_{\epsilon}(B) = DSmP_{\epsilon}(A \cup B) = 1.$$

- Applying formula (3.11) (or equivalently the three previous expressions) for $\epsilon = 0.001$ yields:

$$DSmP_{\epsilon=0.001}(A) \approx 0.3 + 0.4492 = 0.7492$$

$$DSmP_{\epsilon=0.001}(B) \approx 0.1 + 0.1508 = 0.2508$$

$$DSmP_{\epsilon=0.001}(A \cup B) = 1$$

- Applying formula (3.11) for $\epsilon = 0$ yields¹⁰:

$$DSmP_{\epsilon=0}(A) = 0.3 + 0.45 = 0.75$$

$$DSmP_{\epsilon=0}(B) = 0.1 + 0.15 = 0.25$$

$$DSmP_{\epsilon=0}(A \cup B) = 1$$

	<i>A</i>	<i>B</i>	<i>PIC</i> (.)
<i>PrNPL</i> (.)	0.5625	0.4375	0.0113
<i>BetP</i> (.)	0.6000	0.4000	0.0291
<i>CuzzP</i> (.)	0.6000	0.4000	0.0291
<i>PrPl</i> (.)	0.6375	0.3625	0.0553
<i>PraPl</i> (.)	0.6375	0.3625	0.0553
<i>PrHyb</i> (.)	0.6825	0.3175	0.0984
$DSmP_{\epsilon=0.001}$ (.)	0.7492	0.2508	0.1875
<i>PrBel</i> (.)	0.7500	0.2500	0.1887
$DSmP_{\epsilon=0}$ (.)	0.7500	0.2500	0.1887

Table 3.2: Results for example 3.7.1.

Results: We summarize in Table 3.2, the results of the subjective probabilities and their corresponding PIC values sorted by increasing values. It is interesting to note that $DSmP_{\epsilon \rightarrow 0}$ (.) provides same result as with *PrBel*(.) and $PIC(DSmP_{\epsilon \rightarrow 0}$ (.)) is greater than the PIC values obtained with *PrNPL*, *BetP*, *CuzzP*, *PrPl* and *PraPl* transformations.

¹⁰It is possible since the masses of *A* and *B* are not zero, so we actually get a proportionnalization with respect to masses only.

3.7.2 Example 2: Shafer's model with the ignorant source

Let's consider the 2D frame $\Theta = \{A, B\}$ with Shafer's model (i.e. $A \cap B = \emptyset$) and the vacuous belief mass characterizing the totally ignorant source given in Table 3.3.

	A	B	$A \cup B$
$m(\cdot)$	0	0	1

Table 3.3: Vacuous belief mass for example 3.7.2

- With the pignistic probability:

$$BetP(A) = BetP(B) = 0 + (1/2) = 0.5$$

- With Sudano's probabilities:

Applying Sudano's probabilities formulas (3.4)-(3.8), one gets:

- Probability $PrPl(\cdot)$:

$$PrPl(A) = PrPl(B) = 1 \cdot [0/1 + 1/(1+1)] = 0.5$$

- With the probability $PrBel(\cdot)$:

$$PrBel(A) = PrBel(B) = 0 \cdot [0/0 + 1/(0+0)] = NaN$$

- With the probability $PrNPl(\cdot)$:

$$PrNPl(A) = PrNPl(B) = 1/(1+1) = 0.5$$

- With the probability $PraPl(\cdot)$: $\epsilon = \frac{1-0-0}{1+1} = 0.5$

$$PraPl(A) = PraPl(B) = 0 + 0.5 \cdot 1 = 0.5$$

- With the probability $PrHyb(\cdot)$:

$$PrHyb(A) = PrHyb(B) = 0.5 \cdot \left[\frac{0}{0.5} + \frac{1}{0.5+0.5} \right] = 0.5$$

• **With Cuzzolin’s probability:**

Since $TNSM = m(A \cup B) = 1$, $\Delta(A) = Pl(A) - m(A) = 1$ and $\Delta(B) = Pl(B) - m(B) = 1$, one gets

$$CuzzP(A) = CuzzP(B) = 0 + \frac{1}{1+1} \cdot 1 = 0.5$$

• **With $DSmP$ transformation:**

Applying formula (3.11) (or (3.12) since we work here with Shafer’s model) for $\epsilon > 0$ yields¹¹:

$$\begin{aligned} DSmP_{\epsilon>0}(A) &= m(A \cup B)/2 = 0.5 \\ DSmP_{\epsilon>0}(B) &= m(A \cup B)/2 = 0.5 \\ DSmP_{\epsilon>0}(A \cup B) &= 1 \end{aligned}$$

In the particular case of the totally ignorant source characterized by the vacuous belief assignment, all transformations coincide with the uniform probability measure over singletons of Θ , except $PrBel(\cdot)$ which is mathematically not defined in that case. This result can be easily proved for any size of the frame Θ with $|\Theta| > 2$. We summarize in Table 3.4, the results of the subjective probabilities and their corresponding PIC values.

	<i>A</i>	<i>B</i>	<i>PIC</i> (.)
<i>PrBel</i> (.)	<i>NaN</i>	<i>NaN</i>	<i>NaN</i>
<i>BetP</i> (.)	0.5	0.5	0
<i>PrPl</i> (.)	0.5	0.5	0
<i>PrNPl</i> (.)	0.5	0.5	0
<i>PraPl</i> (.)	0.5	0.5	0
<i>PrHyb</i> (.)	0.5	0.5	0
<i>CuzzP</i> (.)	0.5	0.5	0
<i>DSmP</i> _{$\epsilon>0$} (.)	0.5	0.5	0

Table 3.4: Results for example 3.7.2.

¹¹It is not possible to apply the $DSmP$ formula for $\epsilon = 0$ in this particular case, but ϵ can be chosen as small as we want.

3.7.3 Example 3: Shafer's model with a probabilistic source

Let's consider the 2D frame $\Theta = \{A, B\}$ and let's assume Shafer's model and let's see what happens when applying all the transformations on a probabilistic source¹² which commits a belief mass only to singletons of 2^Θ , i.e. a Bayesian mass [10]. It is intuitively expected that all transformations are idempotent when dealing with probabilistic sources, since actually there is no reason/need to modify $m(\cdot)$ (the input mass) to obtain a new subjective probability measure since $Bel(\cdot)$ associated with $m(\cdot)$ is already a probability measure.

If we consider, for example, the uniform probabilistic mass given in Table 3.5, it is very easy to verify in this case, that almost all transformations coincide with the probabilistic input mass as expected, so that the idempotency property is satisfied.

	A	B	$A \cup B$
$m_u(\cdot)$	0.5	0.5	0

Table 3.5: Uniform probabilistic mass for example 3.7.3

Only Cuzzolin's transformation fails to satisfy this property because in $CuzzP(\cdot)$ formula (3.9) one gets 0/0 indetermination since all $\Delta(\cdot) = 0$ in (3.9). This remark is valid whatever the dimension of the frame is, and for any probabilistic mass, not only for uniform belief mass $m_u(\cdot)$. We summarize in Table 3.6, the results of the subjective probabilities and their corresponding PIC values:

	A	B	$PIC(\cdot)$
$CuzzP(\cdot)$	NaN	NaN	NaN
$BetP(\cdot)$	0.5	0.5	0
$PrPl(\cdot)$	0.5	0.5	0
$PrNPl(\cdot)$	0.5	0.5	0
$PraPl(\cdot)$	0.5	0.5	0
$PrHyb(\cdot)$	0.5	0.5	0
$PrBel(\cdot)$	0.5	0.5	0
$DSmP_\epsilon(\cdot)$	0.5	0.5	0

Table 3.6: Results for example 3.7.3.

¹²This has obviously no practical interest since the source already provides a probability measure, nevertheless this is very interesting to see the theoretical behavior of the transformations in such case.

3.7.4 Example 4: Shafer’s model with a non-Bayesian mass

Let’s assume Shafer’s model and the non-Bayesian mass (more precisely the simple support mass) given in Table 3.7. We summarize in Table 3.8, the results obtained with all transformations. One sees that $PIC(DSmP_{\epsilon=0})$ is maximum among all PIC values. $PrBel(\cdot)$ does not work correctly since it can not have a division by zero; even overcoming it¹³, $PrBel$ does not do a fair redistribution of the ignorance $m(A \cup B) = 0.6$ because B does not receive anything from the mass 0.6, although B is involved in the ignorance $A \cup B$. All $m(A \cup B) = 0.6$ was unfairly redistributed to A only.

	A	B	$A \cup B$
$m(\cdot)$	0.4	0	0.6

Table 3.7: Quantitative input for example 3.7.4

	A	B	$PIC(\cdot)$
$PrBel(\cdot)$	1	NaN	NaN
$PrNPl(\cdot)$	0.6250	0.3750	0.0455
$BetP(\cdot)$	0.7000	0.3000	0.1187
$CuzzP(\cdot)$	0.7000	0.3000	0.1187
$PrPl(\cdot)$	0.7750	0.2250	0.2308
$PraPl(\cdot)$	0.7750	0.2250	0.2308
$PrHyb(\cdot)$	0.8650	0.1350	0.4291
$DSmP_{\epsilon=0.001}(\cdot)$	0.9985	0.0015	0.9838
$DSmP_{\epsilon=0}(\cdot)$	1	0	1

Table 3.8: Results for example 3.7.4.

3.7.5 Example 5: Free DSm model

Let’s consider the 2D frame $\Theta = \{A, B\}$ with the free DSm model (i.e. $A \cap B \neq \emptyset$) and the following generalized quantitative belief given in Table 3.9. In the case of free-DSm (or hybrid DSm) models, the pignistic probability $BetP$ and the $DSmP$ can be derived directly from $m(\cdot)$ without the ultimate refinement of the frame Θ whereas Sudano’s and Cuzzolin’s probabilities cannot be derived

¹³since the *direct* derivation of $PrBel(B)$ cannot be done from the formula (3.5) because of the undefined form $0/0$, we could however force it to $PrBel(B) = 0$ since $PrBel(B) = 1 - PrBel(A) = 1 - 1 = 0$, and consequently we indirectly take $PIC(PrBel) = 1$.

directly from the formulas (3.4)-(3.9) in such models. However, Sudano's and Cuzzolin's probabilities can be obtained indirectly after an intermediary step of ultimate refinement of the frame Θ into Θ^{ref} which satisfies Shafer's model. More precisely, instead of working directly on the 2D frame $\Theta = \{A, B\}$ with $m(\cdot)$ given in Table 3.9, we need to work on the 3D frame $\Theta^{\text{ref}} = \{A' \triangleq A \setminus \{A \cap B\}, B' \triangleq B \setminus \{A \cap B\}, C' \triangleq A \cap B\}$ satisfying Shafer's model with the equivalent bba $m(\cdot)$ defined as in Table 3.10.

	$A \cap B$	A	B	$A \cup B$
$m(\cdot)$	0.4	0.2	0.1	0.3

Table 3.9: Quantitative input on the original frame Θ

	C'	$A' \cup C'$	$B' \cup C'$	$A' \cup B' \cup C'$
$m(\cdot)$	0.4	0.2	0.1	0.3

Table 3.10: Quantitative equivalent input on the refined frame Θ^{ref}

- **With the pignistic probability:** With the generalized pignistic transformation [12] (Chap.7, p. 148), one gets:

$$\begin{aligned} \text{Bet}P(A) &= m(A) + \frac{m(B)}{2} + m(A \cap B) + \frac{2}{3}m(A \cup B) \\ &= 0.2 + 0.05 + 0.4 + 0.2 = 0.85 \end{aligned}$$

$$\begin{aligned} \text{Bet}P(B) &= m(B) + \frac{m(A)}{2} + m(A \cap B) + \frac{2}{3}m(A \cup B) \\ &= 0.1 + 0.1 + 0.4 + 0.2 = 0.80 \end{aligned}$$

$$\begin{aligned} \text{Bet}P(A \cap B) &= \frac{m(A)}{2} + \frac{m(B)}{2} + m(A \cap B) + \frac{1}{3}m(A \cup B) \\ &= 0.1 + 0.05 + 0.4 + 0.1 = 0.65 \end{aligned}$$

We can easily check that

$$\text{Bet}P(A \cup B) = \text{Bet}P(A) + \text{Bet}P(B) - \text{Bet}P(A \cap B) = 0.85 + 0.80 - 0.65 = 1$$

- **With Sudano's probabilities:** Working on the refined frame Θ^{ref} , with the bba $m(\cdot)$ defined in Table 3.10, one finally obtains from (3.4)-(3.8):

- *With the probability $PrPl(\cdot)$:*

$$PrPl(A') \approx 0.1456$$

$$PrPl(B') \approx 0.0917$$

$$PrPl(C') \approx 0.7627$$

so that:

$$PrPl(A) = 0.1456 + 0.7627 = 0.9083$$

$$PrPl(B) = 0.0917 + 0.7627 = 0.8544$$

$$PrPl(A \cap B) = PrPl(C') = 0.7627$$

- *With the probability $PrBel(\cdot)$:* It cannot be directly computed by (3.5) because of the division by zero involved in derivation of $PrBel(A')$ and $PrBel(B')$, i.e. formally one gets

$$PrBel(A') = NaN$$

$$PrBel(B') = NaN$$

$$PrBel(C') = 1$$

But because $PrBel(C') = 1$, one can set artificially/indirectly $PrBel(A') = 0$ and $PrBel(B') = 0$, so that:

$$PrBel(A) = NaN + 1 \approx 0 + 1 = 1$$

$$PrBel(B) = NaN + 1 \approx 0 + 1 = 1$$

$$PrBel(A \cap B) = 1$$

but fundamentally, $PrBel(A) = NaN$ and $PrBel(B) = NaN$ from $PrBel(\cdot)$ formula.

- *With the probability $PrNPl(\cdot)$:*

$$PrNPl(A') \approx 0.2632$$

$$PrNPl(B') \approx 0.2105$$

$$PrNPl(C') \approx 0.5263$$

so that:

$$PrNPl(A) = 0.2632 + 0.5263 = 0.7895$$

$$PrNPl(B) = 0.2105 + 0.5263 = 0.7368$$

$$PrNPl(A \cap B) = PrNPl(C') = 0.5263$$

- With the probability $PraPl(\cdot)$: $\epsilon \approx 0.3157$

$$PraPl(A') \approx 0.1579$$

$$PraPl(B') \approx 0.1264$$

$$PraPl(C') \approx 0.7157$$

so that:

$$PraPl(A) = 0.1579 + 0.7157 = 0.8736$$

$$PraPl(B) = 0.1264 + 0.7157 = 0.8421$$

$$PraPl(A \cap B) = PraPl(C') = 0.7157$$

- With the probability $PrHyb(\cdot)$:

$$PrHyb(A') \approx 0.0835$$

$$PrHyb(B') \approx 0.0529$$

$$PrHyb(C') \approx 0.8636$$

so that:

$$PrHyb(A) = 0.0835 + 0.8636 = 0.9471$$

$$PrHyb(B) = 0.0529 + 0.8636 = 0.9165$$

$$PrHyb(A \cap B) = PrHyb(C') = 0.8636$$

- **With Cuzzolin's probability:** Working on the refined frame Θ^{ref} , with the bba $m(\cdot)$ defined in Table 3.10, one has $TNSM = m(A' \cup C') + m(B' \cup C') + m(A' \cup B' \cup C') = 0.6$, $\Delta(A') = 0.5$, $\Delta(B') = 0.4$ and $\Delta(C') = 0.4$. Therefore:

$$\begin{aligned} CuzzP(A') &= m(A') + \frac{\Delta(A')}{\Delta(A') + \Delta(B') + \Delta(C')} \cdot TNSM \\ &= 0 + \frac{0.5}{0.5 + 0.4 + 0.6} \cdot 0.6 = 0.20 \end{aligned}$$

$$\begin{aligned} CuzzP(B') &= m(B') + \frac{\Delta(B')}{\Delta(A') + \Delta(B') + \Delta(C')} \cdot TNSM \\ &= 0 + \frac{0.4}{0.5 + 0.4 + 0.6} \cdot 0.6 = 0.16 \end{aligned}$$

$$\begin{aligned} CuzzP(C') &= m(C') + \frac{\Delta(C')}{\Delta(A') + \Delta(B') + \Delta(C')} \cdot TNSM \\ &= 0.4 + \frac{0.6}{0.5 + 0.4 + 0.6} \cdot 0.6 = 0.64 \end{aligned}$$

which finally gives:

$$\begin{aligned} CuzzP(A) &= CuzzP(A') + CuzzP(C') = 0.84 \\ CuzzP(B) &= CuzzP(B') + CuzzP(C') = 0.80 \\ CuzzP(A \cap B) &= CuzzP(C') = 0.64 \end{aligned}$$

• **With *DSmP* transformation:**

If one uses the *DSmP* formula (3.11) for this 2D case with the free *DSm* model where $\mathcal{C}(A \cap B) = 1$, $\mathcal{C}(A) = \mathcal{C}(B) = 2$ and $\mathcal{C}(A \cup B) = 3$, one gets the following analytical expressions of $DSmP_\epsilon(\cdot)$ (assuming all denominators are strictly positive):

$$\begin{aligned} DSmP_\epsilon(A \cap B) &= m(A \cap B) + \frac{m(A \cap B) + \epsilon}{m(A \cap B) + 2 \cdot \epsilon} \cdot m(A) + \frac{m(A \cap B) + \epsilon}{m(A \cap B) + 2 \cdot \epsilon} \cdot m(B) \\ &\quad + \frac{m(A \cap B) + \epsilon}{m(A \cap B) + 3 \cdot \epsilon} \cdot m(A \cup B) \quad (3.20) \end{aligned}$$

$$\begin{aligned} DSmP_\epsilon(A) &= m(A \cap B) + m(A) + \frac{m(A \cap B) + \epsilon}{m(A \cap B) + 2 \cdot \epsilon} \cdot m(B) \\ &\quad + \frac{m(A \cap B) + 2 \cdot \epsilon}{m(A \cap B) + 3 \cdot \epsilon} \cdot m(A \cup B) \quad (3.21) \end{aligned}$$

$$\begin{aligned} DSmP_\epsilon(B) &= m(A \cap B) + m(B) + \frac{m(A \cap B) + \epsilon}{m(A \cap B) + 2 \cdot \epsilon} \cdot m(A) \\ &\quad + \frac{m(A \cap B) + 2 \cdot \epsilon}{m(A \cap B) + 3 \cdot \epsilon} \cdot m(A \cup B) \quad (3.22) \end{aligned}$$

$$DSmP_\epsilon(A \cup B) = m(A \cap B) + m(A) + m(B) + m(A \cup B) = 1 \quad (3.23)$$

- Applying formula (3.11) for $\epsilon = 0.001$ yields:

$$\begin{aligned} DSmP_{\epsilon=0.001}(A \cap B) &\approx 0.9978 \\ DSmP_{\epsilon=0.001}(A) &\approx 0.9990 \\ DSmP_{\epsilon=0.001}(B) &\approx 0.9988 \\ DSmP_{\epsilon=0.001}(A \cup B) &= 1 \end{aligned}$$

which induces the underlying probability measure on the refined frame

$$\begin{aligned}
 p_1 &= P(A \setminus (A \cap B)) \approx 0.0012 \\
 p_2 &= P(B \setminus (A \cap B)) \approx 0.0010 \\
 p_3 &= P(A \cap B) \approx 0.9978
 \end{aligned}$$

This yields to $PIC \approx 0.9842$.

- Applying formula (3.11) for $\epsilon = 0$ yields¹⁴: One gets

$$\begin{aligned}
 DSmP_{\epsilon=0}(A \cap B) &= 1 & DSmP_{\epsilon=0}(A) &= 1 \\
 DSmP_{\epsilon=0}(A \cup B) &= 1 & DSmP_{\epsilon=0}(B) &= 1
 \end{aligned}$$

which induces the underlying probability measure on the refined frame

$$\begin{aligned}
 p_1 &= P(A \setminus (A \cap B)) = 0 \\
 p_2 &= P(B \setminus (A \cap B)) = 0 \\
 p_3 &= P(A \cap B) = 1
 \end{aligned}$$

which yields the maximum PIC value, i.e. $PIC = 1$.

We summarize in Table 3.11, the results of the subjective probabilities and their corresponding PIC values sorted in increasing order:

	<i>A</i>	<i>B</i>	<i>A</i> ∩ <i>B</i>	<i>PIC</i> (.)
<i>PrNPl</i> (.)	0.7895	0.7368	0.5263	0.0741
<i>CuzzP</i> (.)	0.8400	0.8000	0.6400	0.1801
<i>BetP</i> (.)	0.8500	0.8000	0.6500	0.1931
<i>PraPl</i> (.)	0.8736	0.8421	0.7157	0.2789
<i>PrPl</i> (.)	0.9083	0.8544	0.7627	0.3570
<i>PrHyb</i> (.)	0.9471	0.9165	0.8636	0.5544
<i>DSmP</i> _{ε=0.001} (.)	0.9990	0.9988	0.9978	0.9842
<i>PrBel</i> (.)	<i>NaN</i>	<i>NaN</i>	1	1
<i>DSmP</i> _{ε=0} (.)	1	1	1	1

Table 3.11: Results for example 3.7.5.

¹⁴It is possible since the mass of $A \cap B$ is not zero.

From Table 3.11, one sees that $PIC(DSmP_{\epsilon \rightarrow 0})$ is the maximum value. $PrBel$ does not work correctly because it cannot be directly evaluated for A and B since the underlying $PrBel(A')$ and $PrBel(B')$ are mathematically undefined in such case.

Remark: If one works on the *refined frame* Θ^{ref} and one applies the $DSmP$ mapping of the bba $m(\cdot)$ defined in Table 3.10, one obtains naturally the same results for $DSmP$ as those given in table 3.11. Of course the results of $BetP$ in Table 3.11 are the same using directly the formula (3.3) as those using (3.1) on Θ^{ref} .

Proof: Applying (3.11) with Shafer's model for $m(\cdot)$ defined in Table 3.10, one gets directly the $DSmP_{\epsilon}$ values of atomic elements A' , B' and C' of the refined frame Θ^{ref} , i.e.:

$$DSmP_{\epsilon}(A') = \frac{\epsilon \cdot \mathcal{C}(A')}{m(C') + \epsilon \cdot \mathcal{C}(A' \cup C')} \cdot m(A' \cup C') + \frac{\epsilon \cdot \mathcal{C}(A')}{m(C') + \epsilon \cdot \mathcal{C}(A' \cup B' \cup C')} \cdot m(A' \cup B' \cup C') \quad (3.24)$$

$$DSmP_{\epsilon}(B') = \frac{\epsilon \cdot \mathcal{C}(B')}{m(C') + \epsilon \cdot \mathcal{C}(B' \cup C')} \cdot m(B' \cup C') + \frac{\epsilon \cdot \mathcal{C}(B')}{m(C') + \epsilon \cdot \mathcal{C}(A' \cup B' \cup C')} \cdot m(A' \cup B' \cup C') \quad (3.25)$$

$$DSmP_{\epsilon}(C') = \frac{m(C') + \epsilon \cdot \mathcal{C}(C')}{m(C') + \epsilon \cdot \mathcal{C}(C')} \cdot m(C') + \frac{m(C') + \epsilon \cdot \mathcal{C}(C')}{m(C') + \epsilon \cdot \mathcal{C}(A' \cup C')} \cdot m(A' \cup C') + \frac{m(C') + \epsilon \cdot \mathcal{C}(C')}{m(C') + \epsilon \cdot \mathcal{C}(B' \cup C')} \cdot m(B' \cup C') + \frac{m(C') + \epsilon \cdot \mathcal{C}(C')}{m(C') + \epsilon \cdot \mathcal{C}(A' \cup B' \cup C')} \cdot m(A' \cup B' \cup C') \quad (3.26)$$

Since on the refined frame with Shafer's model, $\mathcal{C}(A') = \mathcal{C}(B') = \mathcal{C}(C') = 1$, $\mathcal{C}(A' \cup B') = \mathcal{C}(A' \cup C') = \mathcal{C}(B' \cup C') = 2$ and $\mathcal{C}(A' \cup B' \cup C') = 3$, the previous expressions can be simplified as:

$$DSmP_{\epsilon}(A') = \frac{\epsilon}{m(C') + 2 \cdot \epsilon} \cdot m(A' \cup C') + \frac{\epsilon}{m(C') + 3 \cdot \epsilon} \cdot m(A' \cup B' \cup C') \quad (3.27)$$

$$DSmP_{\epsilon}(B') = \frac{\epsilon}{m(C') + 2 \cdot \epsilon} \cdot m(B' \cup C') + \frac{\epsilon}{m(C') + 3 \cdot \epsilon} \cdot m(A' \cup B' \cup C') \quad (3.28)$$

$$DSmP_{\epsilon}(C') = m(C') + \frac{m(C') + \epsilon}{m(C') + 2 \cdot \epsilon} \cdot m(A' \cup C') + \frac{m(C') + \epsilon}{m(C') + 2 \cdot \epsilon} \cdot m(B' \cup C') \\ + \frac{m(C') + \epsilon}{m(C') + 3 \cdot \epsilon} \cdot m(A' \cup B' \cup C') \quad (3.29)$$

One sees that the expressions of $DSmP_{\epsilon}(A')$, $DSmP_{\epsilon}(B')$ and $DSmP_{\epsilon}(C')$ we obtain here, coincide with the expressions that one would obtain by applying directly the formula (3.12) specifically when Shafer's model holds (i.e. when a ultimate refined frame is used). It can be easily verified that:

$$DSmP_{\epsilon}(A') + DSmP_{\epsilon}(B') + DSmP_{\epsilon}(C') = 1$$

Replacing ϵ and $m(C')$, $m(A' \cup C')$, $m(B' \cup C')$ and $m(A' \cup B' \cup C')$ by their numerical values, one gets the same numerical values as those given by p_1 , p_2 and p_3 . For example if $\epsilon = 0.001$, one obtains from the previous expressions:

$$DSmP_{\epsilon=0.001}(A') = \frac{0.001}{0.4 + 2 \cdot 0.001} \cdot 0.2 + \frac{0.001}{0.4 + 3 \cdot 0.001} \cdot 0.3 \approx 0.0012$$

$$DSmP_{\epsilon=0.001}(B') = \frac{0.001}{0.4 + 2 \cdot 0.001} \cdot 0.1 + \frac{0.001}{0.4 + 3 \cdot 0.001} \cdot 0.3 \approx 0.0010$$

$$DSmP_{\epsilon=0.001}(C') = 0.4 + \frac{0.4 + 0.001}{0.4 + 2 \cdot 0.001} \cdot 0.2 \\ + \frac{0.4 + 0.001}{0.4 + 2 \cdot 0.001} \cdot 0.1 + \frac{0.4 + 0.001}{0.4 + 3 \cdot 0.001} \cdot 0.3 \approx 0.9978$$

From the probabilities of these atomic elements A' , B' and C' , one can easily compute the probability of $A \cap B = C'$, $A = A' \cup C'$, $B = B' \cup C'$ and $A \cup B = A' \cup B' \cup C'$ by:

$$DSmP_{\epsilon}(A \cap B) = DSmP_{\epsilon}(C')$$

$$DSmP_{\epsilon}(A) = DSmP_{\epsilon}(A') + DSmP_{\epsilon}(C')$$

$$DSmP_\epsilon(B) = DSmP_\epsilon(B') + DSmP_\epsilon(C')$$

$$DSmP_\epsilon(A \cup B) = DSmP_\epsilon(A') + DSmP_\epsilon(B') + DSmP_\epsilon(C')$$

Therefore, for $\epsilon = 0.001$, one obtains:

$$DSmP_{\epsilon=0.1}(A \cap B) = 0.9978$$

$$DSmP_{\epsilon=0.1}(A) = 0.0012 + 0.9978 = 0.9990$$

$$DSmP_{\epsilon=0.1}(B) = 0.0010 + 0.9978 = 0.9988$$

$$DSmP_{\epsilon=0.1}(A \cup B) = 0.0012 + 0.0010 + 0.9978 = 1$$

We can verify that this result is the same result as the one obtained directly with formula 3.11 when one uses the free DSm model (see 7th row of the Table 3.11). This completes the proof.

3.8 Examples on a 3D frame

3.8.1 Example 6: Shafer’s model with a non-Bayesian mass

This example is drawn from [21]. Let’s consider the 3D frame $\Theta = \{A, B, C\}$ with Shafer’s model and the following non-Bayesian quantitative belief mass.

	<i>A</i>	<i>B</i>	<i>C</i>	<i>A ∪ B</i>	<i>A ∪ C</i>	<i>B ∪ C</i>	<i>A ∪ B ∪ C</i>
<i>m</i> (.)	0.35	0.25	0.02	0.20	0.07	0.05	0.06

Table 3.12: Quantitative input for example 3.8.1

- **With the pignistic probability:** Applying formula (3.1), one gets

$$BetP(A) = 0.35 + \frac{0.20}{2} + \frac{0.07}{2} + \frac{0.06}{3} = 0.5050$$

$$BetP(B) = 0.25 + \frac{0.20}{2} + \frac{0.05}{2} + \frac{0.06}{3} = 0.3950$$

$$BetP(C) = 0.02 + \frac{0.07}{2} + \frac{0.05}{2} + \frac{0.06}{3} = 0.1000$$

- **With Sudano’s probabilities:** The belief and plausibility ao *A*, *B* and *C* are

$$Bel(A) = 0.35 \quad Bel(B) = 0.25 \quad Bel(C) = 0.02$$

$$Pl(A) = 0.68 \quad Pl(B) = 0.56 \quad Pl(C) = 0.20$$

Applying formulas (3.4)-(3.8), one obtains the following Sudano’s probabilities:

– With the probability $PrPl(\cdot)$:

$$\begin{aligned} PrPl(A) &= Pl(A) \cdot \left[\frac{m(A)}{Pl(A)} + \frac{m(A \cup B)}{Pl(A) + Pl(B)} + \frac{m(A \cup C)}{Pl(A) + Pl(C)} \right. \\ &\quad \left. + \frac{m(A \cup B \cup C)}{Pl(A) + Pl(B) + Pl(C)} \right] \\ &= 0.68 \cdot \left[\frac{0.35}{0.68} + \frac{0.20}{1.24} + \frac{0.07}{0.88} + \frac{0.06}{1.44} \right] \approx 0.5421 \end{aligned}$$

and similarly,

$$PrPl(B) \approx 0.4005 \quad PrPl(C) \approx 0.0574$$

– With the probability $PrBel(\cdot)$:

$$\begin{aligned} PrBel(A) &= Bel(A) \cdot \left[\frac{m(A)}{Bel(A)} + \frac{m(A \cup B)}{Bel(A) + Bel(B)} \right. \\ &\quad \left. + \frac{m(A \cup C)}{Bel(A) + Bel(C)} + \frac{m(A \cup B \cup C)}{Bel(A) + Bel(B) + Bel(C)} \right] \\ &= 0.35 \cdot \left[\frac{0.35}{0.35} + \frac{0.20}{0.60} + \frac{0.07}{0.37} + \frac{0.06}{0.62} \right] \approx 0.5668 \end{aligned}$$

and similarly,

$$PrBel(B) \approx 0.4038 \quad PrBel(C) \approx 0.0294$$

– With the probability $PrNPl(\cdot)$:

$$PrNPl(A) = \frac{1}{\Delta} Pl(A) = \frac{Pl(A)}{Pl(A) + Pl(B) + Pl(C)} = \frac{0.68}{1.44} \approx 0.4722$$

and similarly,

$$PrNPl(B) \approx 0.3889 \quad PrNPl(C) \approx 0.1389$$

– With the probability $PraPl(\cdot)$: Applying formula (3.7), one gets

$$\epsilon = \frac{1 - Bel(A) - Bel(B) - Bel(C)}{Pl(A) + Pl(B) + Pl(C)} = \frac{0.38}{1.44}$$

$$PraPl(A) = Bel(A) + \epsilon \cdot Pl(A) = 0.35 + \frac{0.38}{1.44} \cdot 0.68 \approx 0.5294$$

and similarly,

$$PraPl(B) \approx 0.3978 \quad PraPl(C) \approx 0.0728$$

– With the probability $PrHyb(\cdot)$:

$$\begin{aligned} PrHyb(A) &= PraPl(A) \cdot \left[\frac{m(A)}{PraPl(A)} + \frac{m(A \cup B)}{PraPl(A) + PraPl(B)} \right. \\ &\quad + \frac{m(A \cup C)}{PraPl(A) + PraPl(C)} \\ &\quad \left. + \frac{m(A \cup B \cup C)}{PraPl(A) + PraPl(B) + PraPl(C)} \right] \approx 0.5575 \end{aligned}$$

and similarly,

$$PrHyb(B) \approx 0.4019 \quad PrHyb(C) \approx 0.0406$$

- **With Cuzzolin's probability:** Since $TNSM = m(A \cup B) = 0.38$, $\Delta(A) = Pl(A) - m(A) = 0.33$, $\Delta(B) = Pl(B) - m(B) = 0.31$ and $\Delta(C) = Pl(C) - m(C) = 0.18$, one gets:

$$CuzzP(A) = 0.35 + \frac{0.33}{0.33 + 0.31 + 0.18} \cdot 0.38 \approx 0.5029$$

$$CuzzP(B) = 0.25 + \frac{0.31}{0.33 + 0.31 + 0.18} \cdot 0.38 \approx 0.3937$$

$$CuzzP(C) = 0.02 + \frac{0.18}{0.33 + 0.31 + 0.18} \cdot 0.38 \approx 0.1034$$

- **With $DSmP$ transformation:**

- Applying formula (3.11) for $\epsilon = 0.001$ yields:

$$DSmP_{\epsilon=0.001}(A) \approx 0.5665$$

$$DSmP_{\epsilon=0.001}(B) \approx 0.4037$$

$$DSmP_{\epsilon=0.001}(C) \approx 0.0298$$

$$DSmP_{\epsilon=0.001}(A \cup B) \approx 0.9702$$

$$DSmP_{\epsilon=0.001}(A \cup C) \approx 0.5963$$

$$DSmP_{\epsilon=0.001}(B \cup C) \approx 0.4335$$

$$DSmP_{\epsilon=0.001}(A \cup B \cup C) = 1$$

- Applying formula (3.11) for $\epsilon = 0$ yields:

$$\begin{aligned}
 DSmP_{\epsilon=0}(A) &\approx 0.5668 \\
 DSmP_{\epsilon=0}(B) &\approx 0.4038 \\
 DSmP_{\epsilon=0}(C) &\approx 0.0294 \\
 DSmP_{\epsilon=0}(A \cup B) &\approx 0.9706 \\
 DSmP_{\epsilon=0}(A \cup C) &\approx 0.5962 \\
 DSmP_{\epsilon=0}(B \cup C) &\approx 0.4332 \\
 DSmP_{\epsilon=0}(A \cup B \cup C) &= 1
 \end{aligned}$$

We summarize in Table 3.13, the results of the subjective probabilities and their corresponding PIC values sorted in increasing order.

	<i>A</i>	<i>B</i>	<i>C</i>	<i>PIC(.)</i>
<i>PrNPl(.)</i>	0.4722	0.3889	0.1389	0.0936
<i>CuzzP(.)</i>	0.5029	0.3937	0.1034	0.1377
<i>BetP(.)</i>	0.5050	0.3950	0.1000	0.1424
<i>PraPl(.)</i>	0.5294	0.3978	0.0728	0.1861
<i>PrPl(.)</i>	0.5421	0.4005	0.0574	0.2149
<i>PrHyb(.)</i>	0.5575	0.4019	0.0406	0.2517
<i>DSmP_{ε=0.001}(.)</i>	0.5665	0.4037	0.0298	0.2783
<i>PrBel(.)</i>	0.5668	0.4038	0.0294	0.2793
<i>DSmP_{ε=0}(.)</i>	0.5668	0.4038	0.0294	0.2793

Table 3.13: Results for example 3.8.1.

One sees that $DSmP_{\epsilon \rightarrow 0}$ provides the same result as *PrBel* which corresponds the best result in term of PIC for this example.

3.8.2 Example 7: Shafer's model with another non-Bayesian mass

Let's consider the 3D frame $\Theta = \{A, B, C\}$ with Shafer's model and the following non-Bayesian quantitative belief mass:

	A	B	C	A ∪ B	A ∪ C	B ∪ C	A ∪ B ∪ C
m(.)	0.1	0	0.2	0.3	0.1	0	0.3

Table 3.14: Quantitative input for example 3.8.2

- **With the pignistic probability:**

$$BetP(A) = 0.1 + \frac{0.3}{2} + \frac{0.1}{2} + \frac{0.3}{3} = 0.40$$

$$BetP(B) = 0 + \frac{0.3}{2} + \frac{0.3}{3} = 0.25$$

$$BetP(C) = 0.2 + \frac{0.1}{2} + \frac{0.3}{3} = 0.35$$

- **With Sudano’s probabilities:** The belief and plausibility of A, B and C are

$$Bel(A) = 0.10 \quad Bel(B) = 0 \quad Bel(C) = 0.20$$

$$Pl(A) = 0.80 \quad Pl(B) = 0.60 \quad Pl(C) = 0.60$$

Applying formulas (3.4)-(3.8), one obtains:

- *With the probability PrPl(.):*

$$\begin{aligned} PrPl(A) &= Pl(A) \cdot \left[\frac{m(A)}{Pl(A)} + \frac{m(A \cup B)}{Pl(A) + Pl(B)} \right. \\ &\quad \left. + \frac{m(A \cup C)}{Pl(A) + Pl(C)} + \frac{m(A \cup B \cup C)}{Pl(A) + Pl(B) + Pl(C)} \right] \\ &= 0.80 \cdot \left[\frac{0.10}{0.80} + \frac{0.30}{1.40} + \frac{0.10}{1.40} + \frac{0.30}{2} \right] \approx 0.4486 \end{aligned}$$

and similarly,

$$PrPl(B) \approx 0.2186 \quad PrPl(C) \approx 0.3328$$

- *With the probability PrBel(.):*

$$\begin{aligned} PrBel(A) &= Bel(A) \cdot \left[\frac{m(A)}{Bel(A)} + \frac{m(A \cup B)}{Bel(A) + Bel(B)} \right. \\ &\quad \left. + \frac{m(A \cup C)}{Bel(A) + Bel(C)} + \frac{m(A \cup B \cup C)}{Bel(A) + Bel(B) + Bel(C)} \right] \\ &= 0.10 \cdot \left[\frac{0.10}{0.80} + \frac{0.30}{0.10} + \frac{0.10}{0.30} + \frac{0.30}{0.30} \right] \approx 0.5333 \end{aligned}$$

$PrBel(C) \approx 0.4667$ but from the formula (3.5), one gets $PrBel(B) = NaN$ because of the division by zero. Since $PrBel(A) + PrBel(B) + PrBel(C)$ must be one, one could circumvent the problem by taking $PrBel(B) = 0$.

– With the probability $PrNPl(\cdot)$:

$$PrNPl(A) = \frac{Pl(A)}{Pl(A) + Pl(B) + Pl(C)} = \frac{0.80}{2} = 0.40$$

$$PrNPl(B) = \frac{Pl(B)}{Pl(A) + Pl(B) + Pl(C)} = \frac{0.60}{2} = 0.30$$

$$PrNPl(C) = \frac{Pl(C)}{Pl(A) + Pl(B) + Pl(C)} = \frac{0.60}{2} = 0.30$$

– With the probability $PraPl(\cdot)$: Applying formula (3.7), one gets

$$\epsilon = \frac{1 - Bel(A) - Bel(B) - Bel(C)}{Pl(A) + Pl(B) + Pl(C)} = 0.35$$

$$PraPl(A) = 0.10 + 0.35 \cdot 0.80 = 0.38$$

$$PraPl(B) = 0 + 0.35 \cdot 0.60 = 0.21$$

$$PraPl(C) = 0.20 + 0.35 \cdot 0.60 = 0.41$$

– With the probability $PrHyb(\cdot)$:

$$PrHyb(A) \approx 0.4553 \quad PrHyb(B) \approx 0.1698 \quad PrHyb(C) \approx 0.3749$$

- **With Cuzzolin's probability:** Since $TNSM = 0.3 + 0.1 + 0.3 = 0.7$, $\Delta(A) = 0.7$, $\Delta(B) = 0.6$ and $\Delta(C) = 0.4$, one gets:

$$CuzzP(A) = 0.1 + \frac{0.7}{1.7} \times 0.7 = 0.388$$

$$CuzzP(B) = 0 + \frac{0.6}{1.7} \times 0.7 = 0.247$$

$$CuzzP(C) = 0.2 + \frac{0.4}{1.7} \times 0.7 = 0.365$$

• With *DSmP* transformation:

- Applying formula (3.11) for $\epsilon = 0.001$ yields:

$$\begin{aligned}
 DSmP_{\epsilon=0.001}(A) &\approx 0.5305 \\
 DSmP_{\epsilon=0.001}(B) &\approx 0.0039 \\
 DSmP_{\epsilon=0.001}(C) &\approx 0.4656 \\
 DSmP_{\epsilon=0.001}(A \cup B) &\approx 0.5344 \\
 DSmP_{\epsilon=0.001}(A \cup C) &\approx 0.9961 \\
 DSmP_{\epsilon=0.001}(B \cup C) &\approx 0.4695 \\
 DSmP_{\epsilon=0.001}(A \cup B \cup C) &= 1
 \end{aligned}$$

- The formula (3.11) for $\epsilon = 0$ cannot be applied in this example because of 0/0 indetermination, but one can always choose ϵ arbitrary small in order to evaluate $DSmP_{\epsilon \rightarrow 0}(\cdot)$.

	<i>A</i>	<i>B</i>	<i>C</i>	<i>PIC</i> (.)
<i>PrBel</i> (.)	0.5333	<i>NaN</i>	0.4667	<i>NaN</i>
<i>PrNPl</i> (.)	0.4000	0.3000	0.3000	0.0088
<i>CuzzP</i> (.)	0.3880	0.2470	0.3650	0.0163
<i>BetP</i> (.)	0.4000	0.2500	0.3500	0.0164
<i>PraPl</i> (.)	0.3800	0.2100	0.4100	0.0342
<i>PrPl</i> (.)	0.4486	0.2186	0.3328	0.0368
<i>PrHyb</i> (.)	0.4553	0.1698	0.3749	0.0650
$DSmP_{\epsilon=0.001}(\cdot)$	0.5305	0.0039	0.4656	0.3500

Table 3.15: Results for example 3.8.2.

We summarize in Table 3.15, the results of the subjective probabilities and their corresponding PIC values sorted in increasing order. One sees that $DSmP_{\epsilon \rightarrow 0}$ provides the highest PIC and *PrBel* is mathematically undefined. If one set artificially $PrBel(B) = 0$, one will get the same result with *PrBel* as with $DSmP_{\epsilon \rightarrow 0}$.

3.8.3 Example 8: Shafer’s model with yet another non-Bayesian mass

Let’s modify a bit the previous and consider the 3D frame $\Theta = \{A, B, C\}$ with Shafer’s model and the following non-Bayesian quantitative belief assignments (mass) having masses on B and C equal zero and according to Table 3.16.

	A	B	C	$A \cup B$	$A \cup C$	$B \cup C$	$A \cup B \cup C$
$m(\cdot)$	0.1	0	0	0.2	0	0.3	0.4

Table 3.16: Quantitative input for example 3.8.3

	A	B	C	$PIC(\cdot)$
$PrBel(\cdot)$	0.7000	<i>NaN</i>	<i>NaN</i>	<i>NaN</i>
$CuzzP(\cdot)$	0.3455	0.3681	0.2864	0.0049
$PrNPl(\cdot)$	0.3043	0.3913	0.3044	0.0067
$BetP(\cdot)$	0.3333	0.3833	0.2834	0.0068
$PraPl(\cdot)$	0.3739	0.3522	0.2739	0.0077
$PrHyb(\cdot)$	0.3526	0.4066	0.2408	0.0203
$PrPl(\cdot)$	0.3093	0.4377	0.2530	0.0239
$DSmP_{\epsilon=0.001}(\cdot)$	0.6903	0.1558	0.1539	0.2413

Table 3.17: Results for example 3.8.3.

We summarize in Table 3.17, the results of the subjective probabilities and their corresponding PIC values sorted in increasing order. $DSmP_{\epsilon \rightarrow 0}$ provides here the best results in term of PIC metric with respect to all other transformations. $PrBel$ doesn’t work here because the two values $PrBel(B)$ and $PrBel(C)$ are mathematically undefined. Of course if we set artificially $PrBel(B) = PrBel(C) = (1 - PrBel(A))/2 = 0.15$, then we will obtain same result as with $DSmP_{\epsilon \rightarrow 0}$, but there is no solid reason for using such artificial trick for circumventing the inherent limitation of the $PrBel$ transformation.

3.8.4 Example 9: Shafer’s model with yet another non-Bayesian mass

Here is an example where the $PrBel(\cdot)$ provides a counter intuitive result. Let’s consider again Shafer’s model for $\Theta = \{A, B, C\}$ with the following bba

In this example $PrBel(B)$ and $PrBel(C)$ require division by zero which is impossible. Even if in $PrBel$ formula we force the mass $m(B \cup C) = 0.9$ to

	A	B	C	$B \cup C$
$m(\cdot)$	0.1	0	0	0.9

Table 3.18: Quantitative input for example 3.8.4

be transferred to A , we get $PrBel(A) = 1$, but it is not fair nor intuitive to have the mass of $B \cup C$ transferred to A , since A was not at all involved in the ignorance $B \cup C$. Using $DSmP_\epsilon$ we get for the elements of Θ : $DSmP_\epsilon(A) = 0.1$, $DSmP_\epsilon(B) = 0.45$ and $DSmP_\epsilon(C) = 0.45$ no matter what $\epsilon > 0$ is equal to. We summarize in Table 3.19, the results of the subjective probabilities and their corresponding PIC values sorted in increasing order (the verification is left to the reader):

	A	B	C	$PIC(\cdot)$
$PrBel(\cdot)$	0.1000	<i>NaN</i>	<i>NaN</i>	<i>NaN</i>
$PraPl(\cdot)$	0.1474	0.4263	0.4263	0.0814
$BetP(\cdot)$	0.1000	0.4500	0.4500	0.1362
$CuzzP(\cdot)$	0.1000	0.4500	0.4500	0.1362
$PrPl(\cdot)$	0.1000	0.4500	0.4500	0.1362
$PrHyb(\cdot)$	0.1000	0.4500	0.4500	0.1362
$DSmP_\epsilon(\cdot)$	0.1000	0.4500	0.4500	0.1362
$PrNPl(\cdot)$	0.0526	0.4737	0.4737	0.2146

Table 3.19: Results for example 3.8.4.

One sees that $DSmP_\epsilon$ coincides with $BetP$, $CuzzP$, $PrPl(\cdot)$ and $PrHyb(\cdot)$ in this special case. $PrBel(\cdot)$ is mathematically undefined. If one forces artificially $PrBel(B) = PrBel(C) = 0$, one gets $PrBel(A) = 1$ which does not make sense. $PrNPl$ provides a *better* PIC than other transformations here only because it is subject to an abnormal behavior as already explained in section 3.5.2, and therefore it cannot be considered as a serious candidate for transforming any bba into a subjective probability.

3.8.5 Example 10: Hybrid DS*m* model

We consider here the hybrid DS*m* model for the frame $\Theta = \{A, B, C\}$ in which we force all possible intersection of elements of Θ to be empty, except $A \cap B$. In this case the hyper-power set D^Θ reduces to 9 elements $\{\emptyset, A \cap B, A, B, C, A \cup B, A \cup C, B \cup C, A \cup B \cup C\}$. The quantitative belief masses are chosen according to Table 3.20 (the mass of elements not included in the Table are equal to zero).

	$A \cap B$	A	C
$m(\cdot)$	0.2	0.1	0.2
	$A \cup B$	$A \cup C$	$A \cup B \cup C$
$m(\cdot)$	0.3	0.1	0.1

Table 3.20: Quantitative input for example 3.8.5

One has according to Figure 3.1 (see [12], page 55): $\mathcal{C}(A \cap B) = 1$, $\mathcal{C}(A) = 2$, $\mathcal{C}(B) = 2$, $\mathcal{C}(C) = 1$, $\mathcal{C}(A \cup B) = 3$, $\mathcal{C}(A \cup C) = 3$, $\mathcal{C}(B \cap C) = 3$ and $\mathcal{C}(A \cup B \cup C) = 4$.

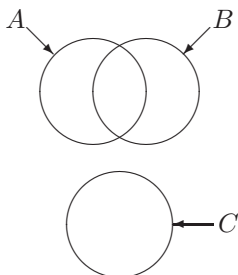

Figure 3.1: Hybrid DSsm model for example 3.8.4

In order to apply Sudano’s and Cuzzolin’s transformations, we need to work on the refined frame Θ^{ref} with Shafer’s model as depicted on Figure 3.2:

$$\Theta^{\text{ref}} = \{A' \triangleq A \setminus (A \cap B), B' \triangleq B \setminus (A \cap B), C' \triangleq C, D' \triangleq A \cap B\}$$

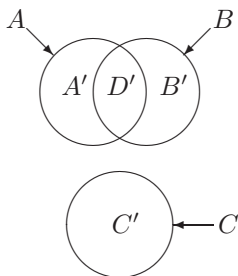

Figure 3.2: Refined 3D frame

For Sudano’s and Cuzzolin’s transformations, we use the following equivalent bba as numerical input of the transformations:

	D'	$A' \cup D'$	C'
$m(\cdot)$	0.2	0.1	0.2
	$A' \cup B' \cup D'$	$A' \cup C' \cup D'$	$A' \cup B' \cup C' \cup D'$
$m(\cdot)$	0.3	0.1	0.1

Table 3.21: Quantitative equivalent input on refined frame for example 3.8.5

• **With the pignistic probability:**

Applying the generalized pignistic transform (3.3) directly on Θ with $m(\cdot)$ given in Table 3.20, one gets:

$BetP\{A \cap B\} =$	$BetP\{A\} =$	$BetP\{B\} =$	$BetP\{C\} =$
$(1/1) \cdot 0.2$	$(1/1) \cdot 0.2$	$(1/1) \cdot 0.2$	$(0/1) \cdot 0.2$
$+(1/2) \cdot 0.1$	$+(2/2) \cdot 0.1$	$+(1/2) \cdot 0.1$	$+(0/2) \cdot 0.1$
$+(1/2) \cdot 0$	$+(1/2) \cdot 0$	$+(2/2) \cdot 0$	$+(0/2) \cdot 0$
$+(0/1) \cdot 0.2$	$+(0/2) \cdot 0.2$	$+(0/1) \cdot 0.2$	$+(1/1) \cdot 0.2$
$+(1/3) \cdot 0.3$	$+(2/3) \cdot 0.3$	$+(2/3) \cdot 0.3$	$+(0/3) \cdot 0.3$
$+(1/3) \cdot 0.1$	$+(2/3) \cdot 0.1$	$+(1/3) \cdot 0.1$	$+(1/3) \cdot 0.1$
$+(1/3) \cdot 0$	$+(1/3) \cdot 0$	$+(2/3) \cdot 0$	$+(1/3) \cdot 0$
$+(1/4) \cdot 0.1$	$+(2/4) \cdot 0.1$	$+(2/4) \cdot 0.1$	$+(1/4) \cdot 0.1$
≈ 0.408333	≈ 0.616666	≈ 0.533333	≈ 0.258333

Table 3.22: Derivation of $BetP\{A \cap B\}$, $BetP\{A\}$, $BetP\{B\}$ and $BetP\{C\}$

It is easy to verify that the pignistic probability of the whole frame Θ is one since one has $BetP\{A \cup B \cup C\} = (1/1) \cdot 0.2 + (2/2) \cdot 0.1 + (2/2) \cdot 0 + (2/2) \cdot 0.2 + (3/3) \cdot 0.3 + (3/3) \cdot 0.1 + (3/3) \cdot 0 + (4/4) \cdot 0.1 = 0.2 + 0.1 + 0.2 + 0.3 + 0.1 + 0.1 = 1$. Moreover, one can verify also that the classical equality $BetP\{A \cup B\} = BetP\{A\} + BetP\{B\} - BetP\{A \cap B\}$ is satisfied since $BetP(\cdot)$ is a (subjective) probability measure, similarly for $BetP\{A \cup C\}$ and for $BetP\{B \cup C\}$. $BetP\{A \cap C\}$ and $BetP\{B \cap C\}$ equal zero in this example.

$BetP\{A \cup B\} =$	$BetP\{A \cup C\} =$	$BetP\{B \cup C\} =$
$(1/1) \cdot 0.2$	$(1/1) \cdot 0.2$	$(1/1) \cdot 0.2$
$+(2/2) \cdot 0.1$	$+(2/2) \cdot 0.1$	$+(1/2) \cdot 0.1$
$+(2/2) \cdot 0$	$+(1/2) \cdot 0$	$+(2/2) \cdot 0$
$+(0/1) \cdot 0.2$	$+(1/1) \cdot 0.2$	$+(2/2) \cdot 0.2$
$+(3/3) \cdot 0.3$	$+(2/3) \cdot 0.3$	$+(2/3) \cdot 0.3$
$+(2/3) \cdot 0.1$	$+(3/3) \cdot 0.1$	$+(2/3) \cdot 0.1$
$+(2/3) \cdot 0$	$+(2/3) \cdot 0$	$+(3/3) \cdot 0$
$+(3/4) \cdot 0.1$	$+(3/4) \cdot 0.1$	$+(3/4) \cdot 0.1$
≈ 0.741666	$= 0.875000$	≈ 0.791666

Table 3.23: Derivation of $BetP\{A \cup B\}$, $BetP\{A \cup C\}$ and $BetP\{B \cup C\}$

The underlying probability measure of the atomic elements of Θ^{ref} is then given by:

$$BetP\{A'\} = BetP\{A\} - BetP\{A \cap B\} \approx 0.2084$$

$$BetP\{B'\} = BetP\{B\} - BetP\{A \cap B\} \approx 0.1250$$

$$BetP\{C'\} = BetP\{C\} \approx 0.2583$$

$$BetP\{D'\} = BetP\{A \cap B\} \approx 0.4083$$

- **With Sudano's probabilities:** The belief and plausibility of elements of Θ^{ref} are

$$Bel(A') = 0 \qquad Pl(A') = 0.6$$

$$Bel(B') = 0 \qquad Pl(B') = 0.4$$

$$Bel(C') = 0.2 \qquad Pl(C') = 0.4$$

$$Bel(D') = 0.2 \qquad Pl(D') = 0.8$$

Applying the formulas (3.4)-(3.8) on Θ^{ref} with the masses given in Table 3.21, one gets:

- With the probability $PrPl(\cdot)$:

$$PrPl(A') \approx 0.2035 \qquad PrPl(B') \approx 0.0848$$

$$PrPl(C') \approx 0.2404 \qquad PrPl(D') \approx 0.4713$$

- With the probability $PrBel(\cdot)$: One cannot directly apply (3.5) because of the division by zero involved in derivation of $PrBel(A')$ and $PrBel(B')$,

i.e. formally one gets

$$\begin{array}{ll} PrBel(A') = NaN & PrBel(B') = NaN \\ PrBel(C') = 0.3000 & PrBel(D') = 0.7000 \end{array}$$

But because $PrBel(C') + PrBel(D') = 1$, one can set artificially/indirectly $PrBel(A') = PrBel(B') = 0$ and this would yield to $PIC \approx 0.5593$, but fundamentally, $PrBel(A') = NaN$ and $PrBel(B') = NaN$ from $PrBel(.)$ formula, so that PIC is mathematically indeterminate.

- With the probability $PrNPl(.)$:

$$\begin{array}{ll} PrNPl(A') \approx 0.2728 & PrNPl(B') \approx 0.1818 \\ PrNPl(C') \approx 0.1818 & PrNPl(D') \approx 0.3636 \end{array}$$

- With the probability $PraPl(.)$: $\epsilon \approx 0.2727$

$$\begin{array}{ll} PraPl(A') \approx 0.1636 & PraPl(B') \approx 0.1091 \\ PraPl(C') \approx 0.3091 & PraPl(D') \approx 0.4182 \end{array}$$

- With the probability $PrHyb(.)$:

$$\begin{array}{ll} PrHyb(A') \approx 0.1339 & PrHyb(B') \approx 0.0583 \\ PrHyb(C') \approx 0.2656 & PrHyb(D') \approx 0.5422 \end{array}$$

- **With Cuzzolin's probability:** Working on the refined frame Θ^{ref} , with the bba $m(.)$ defined in Table 3.21, one has $TNSM = 0.6$, $\Delta(A') = 0.6$, $\Delta(B') = 0.4$, $\Delta(C') = 0.2$ and $\Delta(D') = 0.6$. Therefore:

$$\begin{aligned} CuzzP(A') &= m(A') + \frac{\Delta(A') \cdot TNSM}{\Delta(A') + \Delta(B') + \Delta(C') + \Delta(D')} \\ &= 0 + \frac{0.6 \cdot 0.6}{0.6 + 0.4 + 0.2 + 0.6} = 0.2000 \end{aligned}$$

$$\begin{aligned} CuzzP(B') &= m(B') + \frac{\Delta(B') \cdot TNSM}{\Delta(A') + \Delta(B') + \Delta(C') + \Delta(D')} \\ &= 0 + \frac{0.4 \cdot 0.6}{0.6 + 0.4 + 0.2 + 0.6} \approx 0.1333 \end{aligned}$$

$$\begin{aligned} CuzzP(C') &= m(C') + \frac{\Delta(C') \cdot TNSM}{\Delta(A') + \Delta(B') + \Delta(C') + \Delta(D')} \\ &= 0.2 + \frac{0.2 \cdot 0.6}{0.6 + 0.4 + 0.2 + 0.6} \approx 0.2667 \end{aligned}$$

$$\begin{aligned} CuzzP(D') &= m(D') + \frac{\Delta(D') \cdot TNSM}{\Delta(A') + \Delta(B') + \Delta(C') + \Delta(D')} \\ &= 0.2 + \frac{0.6 \cdot 0.6}{0.6 + 0.4 + 0.2 + 0.6} = 0.4000 \end{aligned}$$

- **With DSmP transformation:** Applying directly the formula (3.11) on the frame Θ with this hybrid model and for the chosen bba $m(\cdot)$, yield to the following analytical expressions:

$$\begin{aligned} DSmP_{\epsilon}(A \cap B) &= \frac{m((A \cap B) \cap (A \cap B)) + \epsilon \cdot \mathcal{C}((A \cap B) \cap (A \cap B))}{m(A \cap B) + \epsilon \cdot \mathcal{C}(A \cap B)} \cdot m(A \cap B) \\ &\quad + \frac{m(A \cap (A \cap B)) + \epsilon \cdot \mathcal{C}(A \cap (A \cap B))}{m(A \cap B) + \epsilon \cdot \mathcal{C}(A)} \cdot m(A) \\ &\quad + \frac{m((A \cup B) \cap (A \cap B)) + \epsilon \cdot \mathcal{C}((A \cup B) \cap (A \cap B))}{m(A \cap B) + \epsilon \cdot \mathcal{C}(A \cup B)} \cdot m(A \cup B) \\ &\quad + \frac{m((A \cup C) \cap (A \cap B)) + \epsilon \cdot \mathcal{C}((A \cup C) \cap (A \cap B))}{m(A \cap B) + m(C) + \epsilon \cdot \mathcal{C}(A \cup C)} \cdot m(A \cup C) \\ &\quad + \frac{m((A \cup B \cup C) \cap (A \cap B)) + \epsilon \cdot \mathcal{C}((A \cup B \cup C) \cap (A \cap B))}{m(A \cap B) + m(C) + \epsilon \cdot \mathcal{C}(A \cup B \cup C)} \cdot m(A \cup B \cup C) \end{aligned}$$

Since we work with this hybrid DSm model, one has $\mathcal{C}(A \cap B) = 1$, $\mathcal{C}(C) = 1$, $\mathcal{C}(A) = \mathcal{C}(B) = 2$, $\mathcal{C}(A \cup B) = \mathcal{C}(A \cup C) = \mathcal{C}(B \cup C) = 3$ and $\mathcal{C}(A \cup B \cup C) = 4$. So that the previous expression can be simplified as:

$$\begin{aligned} DSmP_{\epsilon}(A \cap B) &= \frac{m(A \cap B) + \epsilon \cdot 1}{m(A \cap B) + \epsilon \cdot 1} \cdot m(A \cap B) + \frac{m(A \cap B) + \epsilon \cdot 1}{m(A \cap B) + \epsilon \cdot 2} \cdot m(A) \\ &\quad + \frac{m(A \cap B) + \epsilon \cdot 1}{m(A \cap B) + \epsilon \cdot 3} \cdot m(A \cup B) + \frac{m(A \cap B) + \epsilon \cdot 1}{m(A \cap B) + m(C) + \epsilon \cdot 3} \cdot m(A \cup C) \\ &\quad + \frac{m(A \cap B) + \epsilon \cdot 1}{m(A \cap B) + m(C) + \epsilon \cdot 4} \cdot m(A \cup B \cup C) \end{aligned}$$

Similarly, one gets:

$$\begin{aligned} DSmP_\epsilon(A) &= \frac{m(A \cap B) + \epsilon \cdot 1}{m(A \cap B) + \epsilon \cdot 1} \cdot m(A \cap B) + \frac{m(A \cap B) + \epsilon \cdot 2}{m(A \cap B) + \epsilon \cdot 2} \cdot m(A) \\ &+ \frac{m(A \cap B) + \epsilon \cdot 2}{m(A \cap B) + \epsilon \cdot 3} \cdot m(A \cup B) + \frac{m(A \cap B) + \epsilon \cdot 2}{m(A \cap B) + m(C) + \epsilon \cdot 3} \cdot m(A \cup C) \\ &+ \frac{m(A \cap B) + \epsilon \cdot 2}{m(A \cap B) + m(C) + \epsilon \cdot 4} \cdot m(A \cup B \cup C) \end{aligned}$$

$$\begin{aligned} DSmP_\epsilon(B) &= \frac{m(A \cap B) + \epsilon \cdot 1}{m(A \cap B) + \epsilon \cdot 1} \cdot m(A \cap B) + \frac{m(A \cap B) + \epsilon \cdot 1}{m(A \cap B) + \epsilon \cdot 2} \cdot m(A) \\ &+ \frac{m(A \cap B) + \epsilon \cdot 2}{m(A \cap B) + \epsilon \cdot 3} \cdot m(A \cup B) + \frac{m(A \cap B) + \epsilon \cdot 1}{m(A \cap B) + m(C) + \epsilon \cdot 3} \cdot m(A \cup C) \\ &+ \frac{m(A \cap B) + \epsilon \cdot 2}{m(A \cap B) + m(C) + \epsilon \cdot 4} \cdot m(A \cup B \cup C) \end{aligned}$$

$$\begin{aligned} DSmP_\epsilon(C) &= \frac{m(C) + \epsilon \cdot 1}{m(C) + \epsilon \cdot 1} \cdot m(C) + \frac{m(C) + \epsilon \cdot 1}{m(A \cap B) + m(C) + \epsilon \cdot 3} \cdot m(A \cup C) \\ &+ \frac{m(C) + \epsilon \cdot 1}{m(A \cap B) + m(C) + \epsilon \cdot 4} \cdot m(A \cup B \cup C) \end{aligned}$$

$$\begin{aligned} DSmP_\epsilon((A \cap B) \cup C) &= \frac{m(A \cap B) + \epsilon \cdot 1}{m(A \cap B) + \epsilon \cdot 1} \cdot m(A \cap B) + \frac{m(A \cap B) + \epsilon \cdot 1}{m(A \cap B) + \epsilon \cdot 2} \cdot m(A) \\ &+ \frac{m(C) + \epsilon \cdot 1}{m(C) + \epsilon \cdot 1} \cdot m(C) + \frac{m(A \cap B) + \epsilon \cdot 1}{m(A \cap B) + \epsilon \cdot 3} \cdot m(A \cup B) \\ &+ \frac{m(A \cap B) + m(C) + \epsilon \cdot 2}{m(A \cap B) + m(C) + \epsilon \cdot 3} \cdot m(A \cup C) + \frac{m(A \cap B) + m(C) + \epsilon \cdot 3}{m(A \cap B) + m(C) + \epsilon \cdot 4} \cdot m(A \cup B \cup C) \end{aligned}$$

$$\begin{aligned} DSmP_\epsilon(A \cup B) &= \frac{m(A \cap B) + \epsilon \cdot 1}{m(A \cap B) + \epsilon \cdot 1} \cdot m(A \cap B) + \frac{m(A \cap B) + \epsilon \cdot 2}{m(A \cap B) + \epsilon \cdot 2} \cdot m(A) \\ &+ \frac{m(A \cap B) + \epsilon \cdot 3}{m(A \cap B) + \epsilon \cdot 3} \cdot m(A \cup B) + \frac{m(A \cap B) + \epsilon \cdot 2}{m(A \cap B) + m(C) + \epsilon \cdot 3} \cdot m(A \cup C) \\ &+ \frac{m(A \cap B) + \epsilon \cdot 3}{m(A \cap B) + m(C) + \epsilon \cdot 4} \cdot m(A \cup B \cup C) \end{aligned}$$

$$\begin{aligned}
DSmP_{\epsilon}(A \cup C) &= \frac{m(A \cap B) + \epsilon \cdot 1}{m(A \cap B) + \epsilon \cdot 1} \cdot m(A \cap B) + \frac{m(A \cap B) + \epsilon \cdot 2}{m(A \cap B) + \epsilon \cdot 2} \cdot m(A) \\
&\quad + \frac{m(C) + \epsilon \cdot 1}{m(C) + \epsilon \cdot 1} \cdot m(C) + \frac{m(A \cap B) + \epsilon \cdot 2}{m(A \cap B) + \epsilon \cdot 3} \cdot m(A \cup B) \\
&+ \frac{m(A \cap B) + m(C) + \epsilon \cdot 3}{m(A \cap B) + m(C) + \epsilon \cdot 3} \cdot m(A \cup C) + \frac{m(A \cap B) + m(C) + \epsilon \cdot 3}{m(A \cap B) + m(C) + \epsilon \cdot 4} \cdot m(A \cup B \cup C)
\end{aligned}$$

$$\begin{aligned}
DSmP_{\epsilon}(B \cup C) &= \frac{m(A \cap B) + \epsilon \cdot 1}{m(A \cap B) + \epsilon \cdot 1} \cdot m(A \cap B) + \frac{m(A \cap B) + \epsilon \cdot 1}{m(A \cap B) + \epsilon \cdot 2} \cdot m(A) \\
&\quad + \frac{m(C) + \epsilon \cdot 1}{m(C) + \epsilon \cdot 1} \cdot m(C) + \frac{m(A \cap B) + \epsilon \cdot 2}{m(A \cap B) + \epsilon \cdot 3} \cdot m(A \cup B) \\
&+ \frac{m(A \cap B) + m(C) + \epsilon \cdot 2}{m(A \cap B) + m(C) + \epsilon \cdot 3} \cdot m(A \cup C) + \frac{m(A \cap B) + m(C) + \epsilon \cdot 3}{m(A \cap B) + m(C) + \epsilon \cdot 4} \cdot m(A \cup B \cup C)
\end{aligned}$$

$$\begin{aligned}
DSmP_{\epsilon}(A \cup B \cup C) &= \frac{m(A \cap B) + \epsilon \cdot 1}{m(A \cap B) + \epsilon \cdot 1} \cdot m(A \cap B) + \frac{m(A \cap B) + \epsilon \cdot 2}{m(A \cap B) + \epsilon \cdot 2} \cdot m(A) \\
&\quad + \frac{m(C) + \epsilon \cdot 1}{m(C) + \epsilon \cdot 1} \cdot m(C) + \frac{m(A \cap B) + \epsilon \cdot 3}{m(A \cap B) + \epsilon \cdot 3} \cdot m(A \cup B) \\
&\quad + \frac{m(A \cap B) + m(C) + \epsilon \cdot 3}{m(A \cap B) + m(C) + \epsilon \cdot 3} \cdot m(A \cup C) \\
&\quad + \frac{m(A \cap B) + m(C) + \epsilon \cdot 4}{m(A \cap B) + m(C) + \epsilon \cdot 4} \cdot m(A \cup B \cup C) = 1
\end{aligned}$$

- Applying formula (3.11) for $\epsilon = 0.001$ yields:

$$\begin{aligned}
DSmP_{\epsilon=0.001}(A \cap B) &\approx 0.6962 \\
DSmP_{\epsilon=0.001}(A) &\approx 0.6987 \\
DSmP_{\epsilon=0.001}(B) &\approx 0.6979 \\
DSmP_{\epsilon=0.001}(C) &\approx 0.2996 \\
DSmP_{\epsilon=0.001}((A \cap B) \cup C) &\approx 0.9958 \\
DSmP_{\epsilon=0.001}(A \cup B) &\approx 0.7004 \\
DSmP_{\epsilon=0.001}(A \cup C) &\approx 0.9983 \\
DSmP_{\epsilon=0.001}(B \cup C) &\approx 0.9975 \\
DSmP_{\epsilon=0.001}(A \cup B \cup C) &= 1
\end{aligned}$$

which induces the underlying probability measure on the refined frame

$$P(A') \approx 0.0025 \quad P(B') \approx 0.0017 \quad P(C') \approx 0.2996 \quad P(D') \approx 0.6962$$

	A'	B'	C'	D'	$PIC(\cdot)$
$PrBel(\cdot)$	NaN	NaN	0.3000	0.7000	NaN
$PrNPl(\cdot)$	0.2728	0.1818	0.1818	0.3636	0.0318
$CuzzP(\cdot)$	0.2000	0.1333	0.2667	0.4000	0.0553
$BetP(\cdot)$	0.2084	0.1250	0.2583	0.4083	0.0607
$PraPl(\cdot)$	0.1636	0.1091	0.3091	0.4182	0.0872
$PrPl(\cdot)$	0.2035	0.0848	0.2404	0.4713	0.1124
$PrHyb(\cdot)$	0.1339	0.0583	0.2656	0.5422	0.1928
$DSmP_{\epsilon=0.001}(\cdot)$	0.0025	0.0017	0.2996	0.6962	0.5390

Table 3.24: Results for example 3.8.5.

We summarize in Table 3.24, the results on the refined frame for the subjective probabilities and their corresponding PIC values sorted in increasing order. $DSmP_{\epsilon \rightarrow 0}$ provides here the best result in term of PIC metric with respect to all other transformations.

3.8.6 Example 11: Free DSm model

We consider the free DSm model as Figure 3.3 for $\Theta = \{A, B, C\}$ with the bba given in Table 3.25.

	$A \cap B \cap C$	$A \cap B$	A
$m(\cdot)$	0.1	0.2	0.3
	$A \cup B$	$A \cup B \cup C$	
$m(\cdot)$	0.1	0.3	

Table 3.25: Quantitative input for example 3.8.6

In order to apply Sudano’s and Cuzzolin’s transformations, we need to work one the refined frame

$$\Theta^{\text{ref}} = \{A', B', C', D', E', F', G'\}$$

where elements of Θ^{ref} corresponds to separate parts (assuming such refinement makes physically sense/meaning - sometimes depending on the nature of elements A, B and C the refinement has no physical sense but can just be seen as a mathematical abstract refined frame) of the Venn Diagram of Figure 3.3.

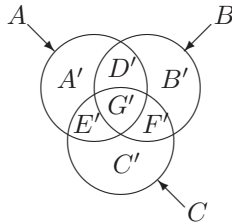

Figure 3.3: Free DS_m model for a 3D frame.

- **With the pignistic probabilities:** One gets for singletons of Θ^{ref} .

$$\begin{array}{lll}
 \text{Bet}P\{A'\} \approx 0.1345 & \text{Bet}P\{B'\} \approx 0.0595 & \text{Bet}P\{C'\} \approx 0.0429 \\
 \text{Bet}P\{D'\} \approx 0.2345 & \text{Bet}P\{E'\} \approx 0.1345 & \text{Bet}P\{F'\} \approx 0.0595 \\
 \text{Bet}P\{G'\} \approx 0.3345 & &
 \end{array}$$

- **With Sudano's probabilities:** The belief and plausibility of elements of Θ^{ref} are

$$\begin{array}{ll}
 \text{Bel}(A') = 0 & \text{Pl}(A') = 0.7 \\
 \text{Bel}(B') = 0 & \text{Pl}(B') = 0.4 \\
 \text{Bel}(C') = 0 & \text{Pl}(C') = 0.3 \\
 \text{Bel}(D') = 0 & \text{Pl}(D') = 0.9 \\
 \text{Bel}(E') = 0 & \text{Pl}(E') = 0.7 \\
 \\
 \text{Bel}(F') = 0 & \text{Pl}(F') = 0.4 \\
 \text{Bel}(G') = 0.1 & \text{Pl}(G') = 1
 \end{array}$$

Applying the formulas (3.4)-(3.8) on Θ^{ref} one obtains:

- With the probability $\text{PrPl}(\cdot)$:

$$\begin{array}{lll}
 \text{PrPl}(A') \approx 0.1284 & \text{PrPl}(B') \approx 0.0370 & \text{PrPl}(C') \approx 0.0205 \\
 \text{PrPl}(D') \approx 0.2599 & \text{PrPl}(E') \approx 0.1284 & \text{PrPl}(F') \approx 0.0370 \\
 \text{PrPl}(G') \approx 0.3887 & &
 \end{array}$$

- With the probability $PrBel(\cdot)$: If one applies $PrBel(\cdot)$ formula restricted only with positive masses (to circumvent 0/0 undeterminations, one obtains $PrBel(G') = 1$ and $PIC = 1$. But if one strictly applies $PrBel(\cdot)$ formula which normally must include all masses (even those taking zero values), then $PrBel(\cdot)$ yields to 0/0 indeterminations and thus $PIC = NaN$.

- With the probability $PrNPl(\cdot)$:

$$\begin{array}{ll} PrNPl(A') \approx 0.1591 & PrNPl(B') \approx 0.0909 \\ PrNPl(C') \approx 0.0682 & PrNPl(D') \approx 0.2045 \\ PrNPl(E') \approx 0.1591 & PrNPl(F') \approx 0.0909 \\ PrNPl(G') \approx 0.2273 & \end{array}$$

- With the probability $PraPl(\cdot)$: $\epsilon \approx 0.2045$

$$\begin{array}{ll} PraPl(A') \approx 0.1432 & PraPl(B') \approx 0.0818 \\ PraPl(C') \approx 0.0614 & PraPl(D') \approx 0.1841 \\ PraPl(E') \approx 0.1432 & PraPl(F') \approx 0.0818 \\ PraPl(G') \approx 0.3045 & \end{array}$$

- With the probability $PrHyb(\cdot)$:

$$\begin{array}{ll} PrHyb(A') \approx 0.1136 & PrHyb(B') \approx 0.0333 \\ PrHyb(C') \approx 0.0184 & PrHyb(D') \approx 0.2214 \\ PrHyb(E') \approx 0.1136 & PrHyb(F') \approx 0.0333 \\ PrHyb(G') \approx 0.4663 & \end{array}$$

- **With Cuzzolin's probability:** Working on the refined frame Θ^{ref} , one has $TNSM = 0.9$, $\Delta(A') = 0.7$, $\Delta(B') = 0.4$, $\Delta(C') = 0.3$, $\Delta(D') = 0.9$, $\Delta(E') = 0.7$, $\Delta(F') = 0.4$ and $\Delta(G') = 0.9$. Therefore:

$$\begin{array}{ll} CuzzP(A') \approx 0.1465 & CuzzP(B') \approx 0.0837 \\ CuzzP(C') \approx 0.0628 & CuzzP(D') \approx 0.1884 \\ CuzzP(E') \approx 0.1465 & CuzzP(F') \approx 0.0837 \\ CuzzP(G') \approx 0.2884 & \end{array}$$

- **With $DSmP$ transformation:**

Applying formula (3.11) for $\epsilon = 0.001$ yields¹⁵:

$$\begin{aligned}
 DSmP_{\epsilon=0.001}(A \cap B \cap C) &\approx 0.9678 \\
 DSmP_{\epsilon=0.001}(A \cap B) &\approx 0.9764 \\
 DSmP_{\epsilon=0.001}(A \cap C) &\approx 0.9745 \\
 DSmP_{\epsilon=0.001}(B \cap C) &\approx 0.9716 \\
 DSmP_{\epsilon=0.001}((A \cup B) \cap C) &\approx 0.9782 \\
 DSmP_{\epsilon=0.001}((A \cup C) \cap B) &\approx 0.9802 \\
 DSmP_{\epsilon=0.001}((B \cup C) \cap A) &\approx 0.9831 \\
 DSmP_{\epsilon=0.001}((A \cap B) \cup (A \cap C) \cup (B \cap C)) &\approx 0.9868 \\
 DSmP_{\epsilon=0.001}(A) &\approx 0.9897 \\
 DSmP_{\epsilon=0.001}(B) &\approx 0.9839 \\
 DSmP_{\epsilon=0.001}(C) &\approx 0.9810 \\
 DSmP_{\epsilon=0.001}((A \cap B) \cup C) &\approx 0.9896 \\
 DSmP_{\epsilon=0.001}((A \cap C) \cup B) &\approx 0.9963 \\
 DSmP_{\epsilon=0.001}((B \cap C) \cup A) &\approx 0.9935 \\
 DSmP_{\epsilon=0.001}(A \cup B) &\approx 0.9972 \\
 DSmP_{\epsilon=0.001}(A \cup C) &\approx 0.9963 \\
 DSmP_{\epsilon=0.001}(B \cup C) &\approx 0.9934 \\
 DSmP_{\epsilon=0.001}(A \cup B \cup C) &= 1
 \end{aligned}$$

which induces the underlying probability measure on the refined frame¹⁶

$$\begin{aligned}
 P(A') &= DSmP(A) - DSmP(A \cap B) - DSmP(A \cap C) \\
 &\quad + DSmP(A \cap B \cap C) \approx 0.0066
 \end{aligned}$$

$$\begin{aligned}
 P(B') &= DSmP(B) - DSmP(A \cap B) - DSmP(B \cap C) \\
 &\quad + DSmP(A \cap B \cap C) \approx 0.0038
 \end{aligned}$$

$$\begin{aligned}
 P(C') &= DSmP(C) - DSmP(A \cap C) - DSmP(B \cap C) \\
 &\quad + DSmP(A \cap B \cap C) \approx 0.0028
 \end{aligned}$$

¹⁵The verification is left to the reader.

¹⁶Here we use the Poincaré's formula. The index ϵ has been omitted due to space limitation for notational convenience.

$$\begin{aligned}
 P(D') &= DSMP(A \cap B) - DSMP(A \cap B \cap C) \approx 0.0086 \\
 P(E') &= DSMP(A \cap C) - DSMP(A \cap B \cap C) \approx 0.0067 \\
 P(F') &= DSMP(B \cap C) - DSMP(A \cap B \cap C) \approx 0.0037 \\
 P(G') &= DSMP(A \cap B \cap C) \approx 0.9678
 \end{aligned}$$

Note that these probabilities can also be computed directly by the formula (3.12) using the proper bba defined on the refined frame. For example by applying (3.12), one gets for this example (with $m(A) = m(A' \cup D' \cup E' \cup G') = 0.3$, $m(A \cup B) = m(A' \cup B' \cup D' \cup E' \cup F' \cup G') = 0.1$ and $m(A \cup B \cup C) = m(A' \cup B' \cup C' \cup D' \cup E' \cup F' \cup G') = 0.2$)

$$P(A') = \frac{\epsilon \cdot 0.3}{0.1 + \epsilon \cdot 4} + \frac{\epsilon \cdot 0.1}{0.1 + \epsilon \cdot 6} + \frac{\epsilon \cdot 0.3}{0.1 + \epsilon \cdot 7}$$

which is equal to 0.0066 when $\epsilon = 0.001$. Similar derivations can be done using (3.12) to obtain directly the probabilities of the other elements of the refined frame.

We summarize in Table 3.26, the PIC values obtained with the different transformations sorted in increasing order. $DSMP_{\epsilon \rightarrow 0}$ provides here again the best result in term of PIC metric with respect to all other transformations.

Transformations	$PIC(\cdot)$
$PrBel(\cdot)$	NaN
$PrNPl(\cdot)$	0.0414
$CuzzP(\cdot)$	0.0621
$PraPl(\cdot)$	0.0693
$BetP(\cdot)$	0.1176
$DSMP_{\epsilon=0.1}(\cdot)$	0.1854
$PrPl(\cdot)$	0.1940
$PrHyb(\cdot)$	0.2375
$DSMP_{\epsilon=0.001}(\cdot)$	0.8986

Table 3.26: Results for example 3.8.6.

3.9 Extension of DSMP for qualitative belief

In order to compute directly with words (linguistic labels), Smarandache and Dezert have defined in [13] a *qualitative basic belief assignment* $qm(\cdot)$ as a mapping function from G^Θ into a set of linguistic labels $L = \{L_0, \tilde{L}, L_{m+1}\}$

where $\tilde{L} = \{L_1, \dots, L_m\}$ is a finite set of linguistic labels and where $m \geq 2$ is an integer. For example, L_1 can take the linguistic value “poor”, L_2 the linguistic value “good”, etc. \tilde{L} is endowed with a total order relationship \prec , so that $L_1 \prec L_2 \prec \dots \prec L_m$. To work on a true closed linguistic set L under linguistic operators, \tilde{L} is extended with two extreme values $L_0 = L_{\min}$ and $L_{m+1} = L_{\max}$, where L_0 corresponds to the minimal qualitative value and L_{m+1} corresponds to the maximal qualitative value, in such a way that $L_0 \prec L_1 \prec L_2 \prec \dots \prec L_m \prec L_{m+1}$, where \prec means inferior to, or less (in quality) than, or smaller than, etc.

From the isomorphism between the set of linguistic equidistant labels and a set of numbers in the interval $[0, 1]$ and the DSm Field and Linear Algebra of Refined Labels (FLARL) proposed in Chapter 2, one disposes of a set of precise operators on linguistic labels (addition, subtraction, multiplication, division, etc) which allows a direct extension of (quantitative) DSmP formula to its qualitative version as follows: $qDSmP_\epsilon(\emptyset) = L_0$ and $\forall X \in G^\Theta \setminus \{\emptyset\}$ by

$$qDSmP_\epsilon(X) = \sum_{Y \in G^\Theta} \frac{\sum_{\substack{Z \subset X \cap Y \\ \mathcal{C}(Z)=1}} qm(Z) + \epsilon \cdot \mathcal{C}(X \cap Y)}{\sum_{\substack{Z \subset Y \\ \mathcal{C}(Z)=1}} qm(Z) + \epsilon \cdot \mathcal{C}(Y)} qm(Y) \quad (3.30)$$

where all operations¹⁷ in (3.30) are referred to labels as explained in Chapter 2.

The derivation of a qualitative PIC from qualitative DSmP can be also obtained as follows: Let’s consider a finite space of discrete exclusive events $\Theta = \{\theta_1, \theta_2, \dots, \theta_n\}$ and a subjective qualitative alike probability measure $qP(\cdot) : \Theta \mapsto L = \{L_0, L_1, \dots, L_m, L_{m+1}\}$. Then one defines the entropy and PIC metrics from $qP(\cdot)$ as

$$H(qP) \triangleq - \sum_{i=1}^n qP\{\theta_i\} \log_2(qP\{\theta_i\}) \quad (3.31)$$

$$PIC(qP) = 1 + \frac{1}{H_{\max}} \cdot \sum_{i=1}^n qP\{\theta_i\} \log_2(qP\{\theta_i\}) \quad (3.32)$$

where $H_{\max} = \log_2(n)$ and in order to compute the logarithms, one utilizes the isomorphism $L_i = i/(m + 1)$.

¹⁷In our previous papers, we used only approximate operators for labels. In working with FLARL, we use precise operators for labels.

3.10 Example for qualitative DS_mP

Let's consider the frame $\Theta = \{A, B, C\}$ with Shafer's model and the following set of linguistic labels $L = \{L_0, L_1, L_2, L_3, L_4, L_5\}$ ($m = 4$) with $L_0 = L_{\min}$ and $L_5 = L_{\max}$. Let's consider the following qualitative belief assignment $qm(A) = L_1$, $qm(B \cup C) = L_4$ and $qm(X) = L_0$ for all $X \in 2^\Theta \setminus \{A, B \cup C\}$. $qm(\cdot)$ is quasi-normalized since $\sum_{X \in 2^\Theta} qm(X) = L_5 = L_{\max}$. In this example, $qm(B \cup C) = L_4$ is redistributed by $qDSmP_\epsilon(\cdot)$ to B and C only, since B and C were involved in the ignorance, proportionally with respect to their cardinals (since their masses are $L_0 \equiv 0$). Applying $qDSmP_\epsilon(\cdot)$ formula (3.30), one gets for this example:

$$qDSmP_\epsilon(A) = L_1$$

$$\begin{aligned} qDSmP_\epsilon(B) &= \frac{qm(B) + \epsilon \cdot \mathcal{C}(B)}{qm(B) + qm(C) + \epsilon \cdot \mathcal{C}(B \cup C)} qm(B \cup C) \\ &= \frac{L_0 + \epsilon \cdot 1}{L_0 + L_0 + \epsilon \cdot 2} \cdot L_4 = \frac{L_{0+(\epsilon \cdot 1) \cdot 5}}{L_{0+0+(\epsilon \cdot 2) \cdot 5}} \cdot L_4 \\ &= \frac{L_{\epsilon \cdot 5}}{L_{\epsilon \cdot 10}} \cdot L_4 = L_{\frac{5\epsilon}{10\epsilon} \cdot 5} \cdot L_4 = L_{2.5} \cdot L_4 \\ &= L_{2.5 \cdot 4/5} = L_{10/5} = L_2 \end{aligned}$$

Similarly, one gets

$$\begin{aligned} qDSmP_\epsilon(C) &= \frac{qm(C) + \epsilon \cdot \mathcal{C}(C)}{qm(B) + qm(C) + \epsilon \cdot \mathcal{C}(B \cup C)} qm(B \cup C) \\ &= \frac{L_0 + \epsilon \cdot 1}{L_0 + L_0 + \epsilon \cdot 2} \cdot L_4 = L_2 \end{aligned}$$

Thanks to the isomorphism between labels and numbers, all the properties of operations with numbers are transmitted to the operations with labels. $qDSmP_\epsilon(\cdot)$ is normalized since $qDSmP_\epsilon(A) + qDSmP_\epsilon(B) + qDSmP_\epsilon(C)$ equals $L_1 + L_2 + L_2 = L_5 = L_{\max}$. Applying the PIC formula (3.32), one obtains (here $n = |\Theta| = 3$):

$$PIC(qDSmP_\epsilon) = 1 + \frac{1}{\log_2 3} (L_1 \log_2(L_1) + L_2 \log_2(L_2) + L_2 \log_2(L_2)) \approx \frac{1}{5} L_1$$

where in order to compute the qualitative logarithms, one utilized the isomorphism $L_i = \frac{i}{m+1}$.

3.11 Conclusions

Motivated by the necessity to use a better (more informational) probabilistic approximation of belief assignment $m(\cdot)$ for applications involving hard and/or soft decisions, we have developed in this chapter a new probabilistic transformation, called *DSmP*, for approximating $m(\cdot)$ into a subjective probability measure. *DSmP* provides the maximum of the Probabilistic Information Content (PIC) of the source because it is based on proportional redistribution of partial and total uncertainty masses to elements of cardinal 1 with respect to their corresponding masses and cardinalities. *DSmP* works with any model (Shafer's, hybrid, or free DSm model) of the frame. $DSmP_{\epsilon=0}$ coincides with Sudano's *PrBel* transformation for the cases when all masses of singletons involved in ignorances are nonzero. *PrBel* formula is restricted to work on Shafer's model only while $DSmP_{\epsilon>0}$ is always defined and for any model. We have clearly shown through simple examples that the classical *BetP* and Cuzzolin's transformations do not perform well in term of PIC criterion. It has been shown also how *DSmP* can be extended to the qualitative domain to approximate qualitative belief assignments provided by human sources in natural language.

3.12 References

- [1] T. Cover, J. Thomas, *Elements of Information Theory*, Wiley and Sons, New York, 1991(Second edition, 2006).
- [2] F. Cuzzolin, *Geometry of Dempster's rule, Special Session on Knowledge Representation under Vagueness and Uncertainty*, 2002 International Conference on Fuzzy Systems and Knowledge Discovery (FSKD'02), Singapore, November 18-22, 2002.
- [3] F. Cuzzolin, *Geometry of Dempster's rule of combination*, IEEE Transactions on Systems, Man, and Cybernetics part B, 34 (2), pages 961- 977, April 2004.
- [4] F. Cuzzolin, *On the properties of the Intersection probability*, submitted to the Annals of Mathematics and Artificial Intelligence, February 2007.
- [5] F. Cuzzolin, *Two new Bayesian approximations of belief functions based on convex geometry*, IEEE Transactions on Systems, Man, and Cybernetics part B, Volume 37, Issue 4, Aug. 2007 Page(s):993 - 1008.

- [6] F. Cuzzolin, *A geometric approach to the theory of evidence*, IEEE Transactions on Systems, Man, and Cybernetics, Part C, 2008 (to appear).<http://perception.inrialpes.fr/people/Cuzzolin/pubs.html>
- [7] J. Dezert, F. Smarandache, *A new probabilistic transformation of belief mass assignment*, in Proceedings of Fusion 2008, Cologne, Germany, July 2008.
- [8] X. Li and X. Huang and J. Dezert and F. Smarandache, *Enrichment of Qualitative Belief for Reasoning under Uncertainty*, in Proceedings of Fusion 2007, Québec, July 2007.
- [9] K. Sentz, S. Ferson, *Combination of evidence in Dempster-Shafer Theory*, SANDIA Tech. Report, SAND2002-0835, 96 pages, April 2002.
- [10] G. Shafer, *A mathematical theory of evidence*, Princeton University Press, 1976.
- [11] C.E. Shannon, *A Mathematical Theory of Communication*, Bell Syst. Tech. J., 27, pp. 379-423 and 623-656, 1948.
- [12] F. Smarandache and J. Dezert (Editors), *Applications and Advances of DS_mT for Information Fusion (Collected works)*, American Research Press, Rehoboth, 2004. <http://www.gallup.unm.edu/~smarandache/DSmT-book1.pdf>.
- [13] F. Smarandache and J. Dezert (Editors), *Applications and Advances of DS_mT for Information Fusion (Collected works)*, Vol. 2, American Research Press, Rehoboth, 2006. <http://www.gallup.unm.edu/~smarandache/DSmT-book2.pdf>.
- [14] Ph. Smets, *Constructing the pignistic probability function in a context of uncertainty*, Uncertainty in Artificial Intelligence, vol. 5, pp. 29-39, 1990.
- [15] Ph. Smets, *The Combination of Evidence in the Transferable Belief Model*, IEEE Transactions on Pattern Analysis and Machine Intelligence, Vol. 12, No. 5, pp. 447-458, 1990.
- [16] Ph. Smets, *Decision making in the TBM: the necessity of the pignistic transformation*, Int. Jour. Approx. Reasoning, vol. 38, 2005.
- [17] J. Sudano, *Pignistic Probability Transforms for Mixes of Low- and High-Probability Events*, in Proceedings of Fusion 2001 Int. Conference on Information Fusion, Montreal, Canada, August 2001.

- [18] J. Sudano, ‘*The system probability information content (PIC) relationship to contributing components, combining independent multi-source beliefs, hybrid and pedigree pignistic probabilities*, in Proceedings of Fusion 2002 International Conference on Information Fusion, Annapolis, Maryland, U.S.A., Volume 2, pp. 1277–1283, July 2002.
- [19] J. Sudano, *Equivalence Between Belief Theories and Naive Bayesian Fusion for Systems with Independent Evidential Data - Part I, The Theory*, in Proceedings of Fusion 2003 Int. Conference on Information Fusion, Cairns, Australia, July 2003.
- [20] J. Sudano, *Equivalence Between Belief Theories and Naive Bayesian Fusion for Systems with Independent Evidential Data - Part II, The Example*, in Proceedings of Fusion 2003 Int. Conference on Information Fusion, Cairns, Australia, pp. 1357–1364, July 2003.
- [21] J. Sudano, *Yet Another Paradigm Illustrating Evidence Fusion (YAPIEF)*, in Proceedings of Fusion 2006 Int. Conference on Information Fusion, Firenze, Italy, July 2006.

Chapter 4

Probabilistic PCR6 fusion rule

Frédéric Dambreville, Francis Celeste
Délégation Générale pour l'Armement,
DGA/CEP/EORD/FAS,
16 bis, Av. Prieur de la Côte d'Or
Arcueil, F 94114, France.
<http://email.fredericdambreville.com>
francis.celeste@etca.fr

Jean Dezert
The French Aerospace Lab.,
ONERA/DTIM/SIF,
29 Av. de la Division Leclerc,
Châtillon, F 92320, France.
jean.dezert@onera.fr

Florentin Smarandache
Chair of Math. & Sciences Dept.,
University of New Mexico,
200 College Road,
Gallup, NM 87301, U.S.A.
smarand@unm.edu

Abstract: *This chapter defines and implements a non-Bayesian fusion rule for combining densities of probabilities, derived from imprecise knowledge. This rule is the restriction to a strict probabilistic paradigm of the Proportional Conflict Redistribution rule no 6 (PCR6) developed in the DSMT framework for fusing basic belief assignments. A sampling method for probabilistic PCR6 (p-PCR6) is defined. It is shown that p-PCR6 allows to keep the modes of local densities and preserve as much as possible the whole information inherent to each densities to combine. In particular, p-PCR6 is able of maintaining multiple hypotheses/modes, when they are too distant for fusion, contrariwise to classical technique. The question of sequential filtering by p-PCR6 is addressed, thus implying the necessity to handle the redundancy of the information.*

Notations

- $\delta[x = y]$ is the Dirac distribution of variable x on value y ,
- $I[b]$, function of Boolean b , is defined by $I[\mathbf{true}] = 1$ and $I[\mathbf{false}] = 0$. In particular, $I[x = y]$ could be seen as a discrete counterpart of the Dirac $\delta[x = y]$.

4.1 Introduction

Bayesian inference is a powerful principle for modeling and manipulating probabilistic information. In many cases, Bayesian inference is considered as an optimal and legitimate rule for inferring such information. Bayesian filters for example, and their approximations by means of sequential Monte-Carlo, are typically regarded as optimal filters [1, 2, 7].

However, Bayesian methods need strong hypotheses, in particular about the information prior and the independence prior. A degradation of the performance of Bayesian filter occurs if the filter is not correctly initialized or updated, in accordance to the models in use. Being given a model of the system kinematic and of the measurement process, the main issue is to develop filtering methods which are sufficiently robust against the bias at the initialization as well as error in modeling. In this paper, a non-Bayesian rule for fusing the probabilistic information is proposed. This rule, denoted p-PCR6, is the restriction to the probabilistic paradigm of the Proportional Conflict redistribution rule no.6 (PCR6) which has been proposed in [12] for combining basic belief assignments. p-PCR6 is also an extension of discrete PCR6 version to its continuous probabilistic counterpart.

PCR6 has been first established for combining evidences (i.e. discrete belief assignments) in the DSMT framework. In particular, it has been designed in order to cope with highly conflicting and uncertain information. This rule could be considered in a probabilistic paradigm by restricting the basic belief assignment involved to only *probabilistic belief assignment*¹, and directly extended to densities of probabilities. This rule is non-Bayesian by nature. Although Bayesian techniques are widely well known and used in target tracking community (including authors works in tracking), it is interesting to see how such new approach can perform to estimate its real interest and potentiality.

¹The denomination *probabilistic belief assignment* is preferred to *Bayesian belief assignment*, generally used in the literature, since we consider that Probability and Bayesian inference are distinguishable notions.

Surprisingly, it turns out through our works, that such approach is robust to an erroneous modeling: in particular, it is able of maintaining multiple hypotheses, when they are too distant for fusion. The resulting p-PCR6-based filter happens to be essentially non-linear, and has been implemented in our simulation using particle filtering techniques. In particular, the p-PCR6 multisensor filter developed here is based on a quite simple and direct implementation in terms of particles drawing and resampling. At the end of this chapter, the question of sequential filtering is addressed. In this case, it is necessary to take into account the redundancy of information over the time. Then, p-PCR6 is adapted in order to remove this redundancy.

Section 4.2 introduces the PCR6 rules, and establishes some results about probabilistic PCR6. A sampling method is deduced. Section 4.3 compares the results of the Bayesian rule and of probabilistic PCR6 on a simple example. On the basis of this comparison, some arguments about the robustness of PCR6 are given. Section 4.4 investigates the sequential filtering issue. Application of p-PCR6 to distributed filtering is provided as example. Section 4.5 concludes.

4.2 PCR6 formula for probabilities

4.2.1 Definition and justification of PCR6

The Proportional Conflict Redistribution rule no. 6 (PCR6) of combination [5] is an extension of rule PCR5 [10, 11]. These rules come from the necessity to manage precisely and efficiently the partial conflicts when combining conflicting and uncertain information expressed in terms of (quantitative) belief assignments. These rule have been proved useful and powerful in several applications where it has been used [12]. PCR5 and PCR6 are equivalent, when restricted to only two sources of information.

Let be given an universe of events Θ . A distribution of evidence over Θ is characterized by means of a basic belief assignment (bba) $m : \mathcal{P}(\Theta) \rightarrow \mathbb{R}^+$ such that:

$$m(\emptyset) = 0 \quad \text{and} \quad \sum_{X \subset \Theta} m(X) = 1 ,$$

where $\mathcal{P}(\Theta)$ is the set of subset of Θ .²

²In the general case, bba could also be defined over hyper-power sets (Dedekind's lattice) [12].

A bba typically represents the knowledge, which can be both uncertain and imprecise, that a sensor provides about its belief in the true state of the universe. The question then arising is *How to fuse the bba's related to multiple sensor responses?* The main idea is to corroborate the information of each sensor in a conjunctive way.

Example: Let's assume two sources with basic belief assignments m_1 and m_2 such that $m_1(A) = 0.6$, $m_1(A \cup B) = 0.4$ and $m_2(B) = 0.3$, $m_2(A \cup B) = 0.7$. The fused bba is then characterized in a conjunctive way by:

$$\begin{aligned} m_{\wedge}(A \cap B) &= m_1(A)m_2(B) = 0.18, \\ m_{\wedge}(A) &= m_1(A)m_2(A \cup B) = 0.42, \\ m_{\wedge}(B) &= m_1(A \cup B)m_2(B) = 0.12, \\ m_{\wedge}(A \cup B) &= m_1(A \cup B)m_2(A \cup B) = 0.28. \end{aligned}$$

The conjunctive consensus works well when there is no possibility of conflict. Now, make the hypothesis $A \cap B = \emptyset$. Then, it is obtained $m_{\wedge}(\emptyset) = 0.18$, which is not an acceptable result for a conventional interpretation of \emptyset as a contradiction. Most existing rules solve this issue by redistributing the conflict $m_{\wedge}(\emptyset)$ over the other propositions. In PCR6, the partial conflicting mass $m_1(A)m_2(B)$ is redistributed to A and B only with the respective proportions $x_A = 0.12$ and $x_B = 0.06$, according to the proportionalization principle:

$$\frac{x_A}{m_1(A)} = \frac{x_B}{m_2(B)} = \frac{m_1(A)m_2(B)}{m_1(A) + m_2(B)} = \frac{0.18}{0.9} = 0.2.$$

Basically, the idea of PCR6 is to transfer the conflicting mass only to the elements involved in the conflict and proportionally to their individual masses.

Some theoretical considerations and justifications already briefly aforementioned led to the following PCR6 combination rule. Being given two bba's m_1 and m_2 , the fused bba m_{PCR6} according to PCR6, or equivalently to PCR5 in this case, is defined for any $X \in \mathcal{P}(\Theta) \setminus \{\emptyset\}$ by:

$$\begin{aligned} m_{\text{PCR5/PCR6}}(X) &= m_{\wedge}(X) \\ &+ \sum_{\substack{Y \in \mathcal{P}(\Theta) \\ X \cap Y = \emptyset}} \left(\frac{m_1(X)^2 m_2(Y)}{m_1(X) + m_2(Y)} + \frac{m_2(X)^2 m_1(Y)}{m_2(X) + m_1(Y)} \right) \quad (4.1) \end{aligned}$$

where $m_{\wedge}(\cdot)$ corresponds to the conjunctive consensus:

$$m_{\wedge}(X) \triangleq \sum_{\substack{Y_1 \cap Y_2 = X \\ Y_1, Y_2 \in \mathcal{P}(\Theta)}} m_1(Y_1)m_2(Y_2).$$

When fusing $s \geq 2$ sources of informations, characterized by the bba's m_1 to m_s , the fused bba is defined in [5] by:

$$m_{\text{PCR6}}(X) = m_{\wedge}(X) + \sum_{i=1}^s m_i(X)^2 \sum_{\substack{\bigcap_{k=1}^{s-1} Y_{\sigma_i(k)} \cap X = \emptyset \\ Y_{\sigma_i(1)}, \dots, Y_{\sigma_i(s-1)} \in \mathcal{P}(\Theta)}} \left(\frac{\prod_{j=1}^{s-1} m_{\sigma_i(j)}(Y_{\sigma_i(j)})}{m_i(X) + \sum_{j=1}^{s-1} m_{\sigma_i(j)}(Y_{\sigma_i(j)})} \right), \quad (4.2)$$

where $m_{\wedge}(\cdot)$ corresponds to the conjunctive consensus:

$$m_{\wedge}(X) \triangleq \sum_{\substack{Y_1 \cap \dots \cap Y_s = X \\ Y_1, \dots, Y_s \in \mathcal{P}(\Theta)}} \prod_{i=1}^s m_i(Y_i),$$

and the function σ_i counts from 1 to s avoiding i :

$$\sigma_i(j) = j \times I[j < i] + (j + 1) \times I[j \geq i].$$

4.2.2 Reformulation of PCR6

Definition (4.2) could be reformulated into a more intuitive expression.

$$m_{\text{PCR6}}(X) = m_{\wedge}(X) + \sum_{i=1}^s \sum_{\substack{\bigcap_{k=1}^s Y_k = \emptyset \\ Y_1, \dots, Y_s \in \mathcal{P}(\Theta)}} \left(\frac{I[X = Y_i] m_i(Y_i) \prod_{j=1}^s m_j(Y_j)}{\sum_{j=1}^s m_j(Y_j)} \right),$$

and then:

$$m_{\text{PCR6}}(X) = m_{\wedge}(X) + \sum_{\substack{\bigcap_{k=1}^s Y_k = \emptyset \\ Y_1, \dots, Y_s \in \mathcal{P}(\Theta)}} \prod_{i=1}^s m_i(Y_i) \frac{\sum_{j=1}^s I[X = Y_j] m_j(Y_j)}{\sum_{j=1}^s m_j(Y_j)}. \quad (4.3)$$

At last, a new formulation of PCR6 is derived for $X \in \mathcal{P}(\Theta) \setminus \{\emptyset\}$:

$$m_{\text{PCR6}}(X) = \sum_{Y_1, \dots, Y_s \in \mathcal{P}(\Theta)} \left(\prod_{i=1}^s m_i(Y_i) \right) F_{\text{PCR6}}(X|Y_{1:s}),$$

where the function F_{PCR6} is defined by:

$$\begin{aligned} F_{\text{PCR6}}(X|Y_{1:s}) &= I \left[\bigcap_{k=1}^s Y_k = X \right] + I \left[\bigcap_{k=1}^s Y_k = \emptyset \right] \frac{\sum_{j=1}^s I[X = Y_j] m_j(Y_j)}{\sum_{j=1}^s m_j(Y_j)} \\ &= \frac{\sum_{j=1}^s \left(I \left[\bigcap_{k=1}^s Y_k = X \right] + I \left[\bigcap_{k=1}^s Y_k = \emptyset \right] I[X = Y_j] \right) m_j(Y_j)}{\sum_{j=1}^s m_j(Y_j)}. \end{aligned} \quad (4.4)$$

When considering probabilistic densities instead of belief functions, the components $\prod_{i=1}^s m_i(Y_i)$ and $\frac{\sum_{j=1}^s (I[\bigcap_{k=1}^s Y_k = X] + I[\bigcap_{k=1}^s Y_k = \emptyset] I[X = Y_j]) m_j(Y_j)}{\sum_{j=1}^s m_j(Y_j)}$ have a straightforward interpretation. The first is interpreted as an independent generation of answers by each source of information. The second is interpreted as a random choice among the answers *or* the consensus, weighted by the respective evidences.

4.2.3 Definition of probabilistic PCR6 (p-PCR6)

In [12], Dezert and Smarandache proposed a probabilistic version of the PCR5 / PCR6 rule (4.1) for two sources, by restricting the bba's m_1 and m_2 to discrete probabilities P_1 and P_2 which are called then *probabilistic belief assignments* (or *masse*¹). Probabilistic belief masses are bba's, which focal elements³ consist only in elements of the frame Θ , i.e. the singletons only. When dealing with probabilistic belief assignments $m_1 \equiv P_1$ and $m_2 \equiv P_2$, the conjunctive consensus is restricted to the same singleton, so that $m_\wedge(X) = P_1(X)P_2(X)$.

³Focal elements are elements of $\mathcal{P}(\Theta)$ having a strictly positive mass.

As a consequence, the PCR5/PCR6 formula (4.1) for two sources reduces to:

$$P_{\text{PCR5/PCR6}}(X) = P_1(X)P_2(X) + P_1(X) \sum_{Y \in \Theta \setminus \{X\}} \frac{P_1(X)P_2(Y)}{P_1(X) + P_2(Y)} \\ + P_2(X) \sum_{Y \in \Theta \setminus \{X\}} \frac{P_2(X)P_1(Y)}{P_2(X) + P_1(Y)} .$$

Now, it happens that:

$$P_1(X)P_2(X) = P_1(X) \frac{P_1(X)P_2(X)}{P_1(X) + P_2(X)} + P_2(X) \frac{P_2(X)P_1(X)}{P_1(X) + P_2(X)} ,$$

and finally:

$$P_{\text{PCR5/PCR6}}(X) = P_1(X) \sum_{Y \in \Theta} \frac{P_1(X)P_2(Y)}{P_1(X) + P_2(Y)} + P_2(X) \sum_{Y \in \Theta} \frac{P_2(X)P_1(Y)}{P_2(X) + P_1(Y)} . \quad (4.5)$$

Of course, this formula generalizes in the case of PCR6 for any number of sources. Since:

$$m_{\wedge}(X) = \prod_{i=1}^s P_i(X) = \sum_{i=1}^s P_i(X) \frac{\prod_{i=1}^s P_i(X)}{\sum_{i=1}^s P_i(X)}$$

and, for $X, Y_{\sigma_i(k)} \in \Theta$,

$$\bigcap_{k=1}^{s-1} Y_{\sigma_i(k)} \cap X \neq \emptyset \text{ if and only if } Y_{\sigma_i(1)} = \dots = Y_{\sigma_i(s)} = X , \quad (4.6)$$

it comes:

$$P_{\text{PCR6}}(X) = \sum_{i=1}^s P_i(X)^2 \sum_{Y_{\sigma_i(1)}, \dots, Y_{\sigma_i(s-1)} \in \Theta} \left(\frac{\prod_{j=1}^{s-1} P_{\sigma_i(j)}(Y_{\sigma_i(j)})}{P_i(X) + \sum_{j=1}^{s-1} P_{\sigma_i(j)}(Y_{\sigma_i(j)})} \right) . \quad (4.7)$$

Equations (4.5) and (4.7) are however difficult to handle practically. The reformulated definition of p-PCR6 is introduced now.

4.2.4 Reformulation of p-PCR6

From (4.4), it is deduced:

$$P_{\text{PCR6}}(X) = \sum_{Y_1, \dots, Y_s \in \Theta} \prod_{i=1}^s P_i(Y_i) \frac{\sum_{j=1}^s \left(I[X = Y_1 = \dots = Y_s] + I \left[\bigcap_{k=1}^s Y_k = \emptyset \right] I[X = Y_j] \right) P_j(Y_j)}{\sum_{j=1}^s P_j(Y_j)} .$$

Now, the property (4.6) implies:

$$I[X = Y_1 = \dots = Y_s] + I \left[\bigcap_{k=1}^s Y_k = \emptyset \right] I[X = Y_j] = I[X = Y_j] .$$

As a consequence, the p-PCR6 rules is equivalently defined by:

$$P_{\text{PCR6}}(X) = \sum_{Y_1, \dots, Y_s \in \Theta} \prod_{i=1}^s P_i(Y_i) \frac{\sum_{j=1}^s I[X = Y_j] P_j(Y_j)}{\sum_{j=1}^s P_j(Y_j)} . \quad (4.8)$$

4.2.5 Extension of p-PCR6 on continuous propositions

The previous discrete p-PCR6 formula is now extended to densities of probabilities of random variables. Formula (4.7) is thus adapted for the fusion of continuous densities p_1, \dots, p_s :

$$p_{\text{PCR6}}(x) \triangleq \sum_{i=1}^s p_i(x) \int_{\Theta^{s-1}} \frac{p_i(x) \prod_{j=1}^{s-1} p_{\sigma_i(j)}(y_{\sigma_i(j)})}{p_i(x) + \sum_{j=1}^{s-1} p_{\sigma_i(j)}(y_{\sigma_i(j)})} \prod_{j=1}^{s-1} dy_{\sigma_i(j)} . \quad (4.9)$$

Notice that $p_i(x)$ is put inside the integration, so as to deal with possible singularities, when $p_i(x) = 0$. It is also necessary to prove that p_{PCR6} is a probabilistic density. And of course, it is possible to guess a reformulated definition of p-PCR6 for densities by means of (4.8). But, we establish now these results by calculus. First at all, a result is proved for computing the expectation based on p_{PCR6} .

4.2.5.1 Expectation

The expectation of a function according to the fused probability p_{PCR6} is expressed from the initial probabilities p_1, \dots, p_s by:

$$\int_{\Theta} p_{\text{PCR6}}(y) f(y, z) dy = \int_{\Theta^s} \prod_{i=1}^s p_i(y_i) \frac{\sum_{i=1}^s p_i(y_i) f(y_i, z)}{\sum_{i=1}^s p_i(y_i)} \prod_{i=1}^s dy_i . \quad (4.10)$$

Proof.

$$\begin{aligned} & \int_{\Theta} p_{\text{PCR6}}(y) f(y, z) dy \\ &= \sum_{i=1}^s \int_{\Theta} p_i(y) \int_{\Theta^{s-1}} \frac{p_i(y) \prod_{j=1}^{s-1} p_{\sigma_i(j)}(y_{\sigma_i(j)})}{p_i(y) + \sum_{j=1}^{s-1} p_{\sigma_i(j)}(y_{\sigma_i(j)})} f(y, z) \left(\prod_{j=1}^{s-1} dy_{\sigma_i(j)} \right) dy \\ &= \sum_{i=1}^s \int_{\Theta^s} p_i(y_i) \frac{\prod_{j=1}^s p_j(y_j)}{\sum_{j=1}^s p_j(y_j)} f(y_i, z) \prod_{j=1}^s dy_j \\ &= \int_{\Theta^s} \prod_{i=1}^s p_i(y_i) \frac{\sum_{i=1}^s p_i(y_i) f(y_i, z)}{\sum_{i=1}^s p_i(y_i)} \prod_{i=1}^s dy_i . \end{aligned}$$

□□□

Corollary. The density p_{PCR6} is actually probabilistic, since it is derived:

$$\int_{\Theta} p_{\text{PCR6}}(y) dy = 1 ,$$

by taking $f = 1$.

4.2.5.2 Reformulated definition

$$p_{\text{PCR6}}(z) = \int_{\Theta^s} \left(\prod_{i=1}^s p_i(y_i) \right) \pi(z|y_{1:s}) \prod_{i=1}^s dy_i, \quad (4.11)$$

$$\text{where } \pi(z|y_{1:s}) = \frac{\sum_{i=1}^s p_i(y_i) \delta[y_i = z]}{\sum_{i=1}^s p_i(y_i)}.$$

Proof.

Apply lemma 1 to the Dirac distribution $f(y, z) = \delta[y = z]$.

□□□

4.2.6 Sampling method

Being able to sample p_1, \dots, p_s , it is possible to sample p_{PCR6} by applying the definition (4.11). The implied sampling process (let z be the sample to be generated) is sketched as follows:

1. For any $k \in \{1, \dots, s\}$, generate y_k according to p_k , *together with its evaluation* $p_k(y_k)$,
2. Generate $\theta \in [0, 1]$ according to the uniform law,
3. Find j such that $\frac{\sum_{k=1}^{j-1} p_k(y_k)}{\sum_{k=1}^s p_k(y_k)} < \theta < \frac{\sum_{k=1}^j p_k(y_k)}{\sum_{k=1}^s p_k(y_k)}$,
4. Set $z = y_j$.

It is seen subsequently that p-PCR6 does not preserve the Gaussian distributions. As a consequence, its manipulation is essentially addressed by means of a Monte-Carlo method, and the previous sampling method is implemented in the applications.

The next section is devoted to a comparison of p-PCR6 and Bayesian rules on very simple examples.

4.3 Bayes versus p-PCR6

4.3.1 Bayesian fusion rule

In this section, we are interested in the fusion of two independent estimators by means of the Bayesian inference. Such fusion has to take into account the prior about the state of the system. Subsequently, this prior is chosen to be uniform. Although this is just a particular case of application, it is sufficient for our purpose, *i.e.* the illustration of essential differences between the Bayesian and PCR6 approaches.

4.3.1.1 General case

In Bayesian filter, the estimator is explained by means of the posterior probability $p(x|z_1, z_2)$ conditionally to the observation z_1 and z_2 . Notice that this posterior estimation should not be confounded with the true state of the system. Now, our purpose here is to derive a rule for deriving the global estimator $p(x|z_1, z_2)$ from the partial estimators $p(x|z_1)$ and $p(x|z_2)$. Applying Bayes' rule, one gets $p(x|z_1, z_2) \propto p(z_1, z_2|x)p(x)$.⁴ To go further in the derivation, one must assume the conditional independence between the two probabilistic sources/densities, *i.e.* $p(z_1, z_2|x) = p(z_1|x)p(z_2|x)$. As a consequence, $p(x|z_1, z_2) \propto p(z_1|x)p(z_2|x)p(x)$, and then:

$$p(x|z_1, z_2) \propto \frac{p(x|z_1)p(x|z_2)}{p(x)}. \quad (4.12)$$

So, in order to compute $p(x|z_1, z_2)$, it is needed both $p(x|z_1)$, $p(x|z_2)$ and the prior $p(x)$. If one assumes uniform prior for $p(x)$, and using notations $p_{\text{Bayes}} = p(\cdot|z_1, z_2)$, $p_1 = p(\cdot|z_1)$ and $p_2 = p(\cdot|z_2)$, the Bayes' fusion formula (4.12) becomes:

$$p_{\text{Bayes}}(x) \propto p_1(x)p_2(x). \quad (4.13)$$

(It is noticed that a discrete counterpart of this result could also be obtained by applying Dempster Shafer rule to probabilistic belief masses)

4.3.1.2 Gaussian subcase

We investigate here the solution of the problem when p_1 and p_2 are Gaussian distributions. So assume for simplicity that $p_1(x)$ and $p_2(x)$ are mono-dimensional Gaussian distributions:

$$p_1(x) = \frac{1}{\sigma_1\sqrt{2\pi}} e^{-\frac{1}{2}\frac{(x-\bar{x}_1)^2}{\sigma_1^2}} \quad \text{and} \quad p_2(x) = \frac{1}{\sigma_2\sqrt{2\pi}} e^{-\frac{1}{2}\frac{(x-\bar{x}_2)^2}{\sigma_2^2}}$$

⁴ $p(\alpha|\beta) \propto \gamma$ means " $p(\alpha|\beta)$ is proportional to γ for β fixed".

In absence of prior information, one assumes $p(x)$ uniform. The Bayesian rule requires to compute (4.13). Then, it is easily shown that p_{Bayes} is Gaussian:

$$p_{\text{Bayes}}(x) = \frac{1}{\sigma_{\text{Bayes}} \sqrt{2\pi}} e^{-\frac{1}{2} \frac{(x - \bar{x}_{\text{Bayes}})^2}{\sigma_{\text{Bayes}}^2}},$$

with

$$\sigma_{\text{Bayes}}^2 = \frac{\sigma_1^2 \sigma_2^2}{\sigma_1^2 + \sigma_2^2},$$

and

$$\bar{x}_{\text{Bayes}} = \sigma_{\text{Bayes}}^2 \left(\frac{\bar{x}_1}{\sigma_1^2} + \frac{\bar{x}_2}{\sigma_2^2} \right).$$

When $\sigma_1 = \sigma_2 = \sigma$, it is implied then:

$$\sigma_{\text{Bayes}}^2(x) = \frac{\sigma^2}{2} \text{ and } \bar{x}_{\text{Bayes}} = \frac{\bar{x}_1 + \bar{x}_2}{2}.$$

Hence, the resulting standard deviation σ_{Bayes} after Bayes fusion is equal to the initial standard deviation divided by the factor $\sqrt{2}$ and thus $\sigma_{\text{Bayes}} < \sigma$. This fusion process is optimal, when the model parameters are correct. Now, imagine that the difference $\bar{x}_2 - \bar{x}_1$ is obtained from a bias error of the model. For example, let us consider that the estimation of sensor 1 is correct but that the estimation of sensor 2 is erroneous, in regards to the deviation σ . Assuming x being the true state of the system, it comes most likely: $p_1(x) \gg p_{\text{Bayes}}(x) \gg p_2(x)$. Thus, the Bayesian fusion propagates the errors. This implies an irrelevant estimation. It is noticed however, that the bias is divided by two, each time a fusion with a good estimation occurs, while the deviation is only divided by $\sqrt{2}$. Then, good estimations will make the process converge correctly after some iteration.

The theoretical plots and those obtained with Monte Carlo simulation are given in figures 4.1, 4.2 and 4.3. These figures make the comparison with the p-PCR6 fused densities. This comparison will be discussed subsequently. It is yet confirmed that the Bayesian rule just concentrates the information, by reducing the deviation, even when the information are distant (that is putatively false).

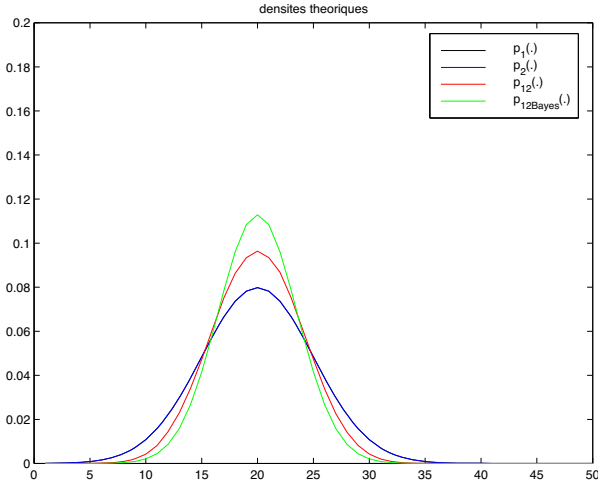

Figure 4.1: p-PCR6 fusion versus Bayesian fusion (theoretical).

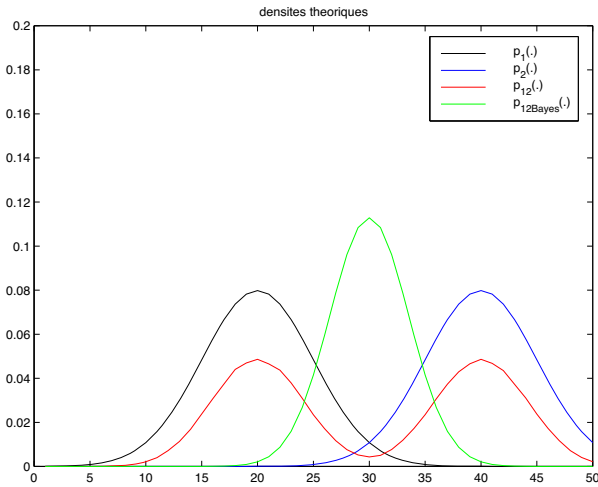

Figure 4.2: p-PCR6 fusion versus Bayesian fusion (theoretical).

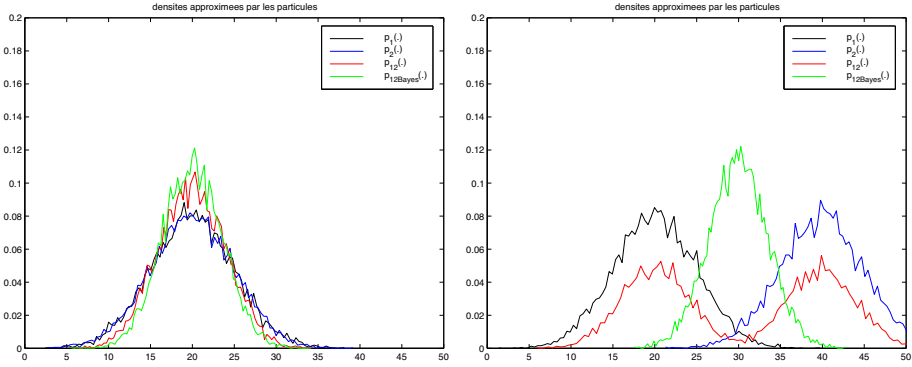

Figure 4.3: p-PCR6 fusion versus Bayesian fusion (based on 10000 samples).

4.3.2 Fusion based on p-PCR6 for Gaussian distributions

The same Gaussian distribution, p_1 and p_2 , are considered, but are now fused by p-PCR6 rule (4.9), thus resulting in density p_{PCR6} . The fused densities are both computed, figures 4.1 and 4.2, and sampled, figure 4.3. Direct computations are expensive, and are obtained in two steps:

- Compute $I_s(x) = \int \frac{p_s(x)p_{\bar{s}}(y)}{p_s(x)+p_{\bar{s}}(y)} dy$, where $s \in \{1, 2\}$ and $\bar{s} \in \{1, 2\} \setminus \{s\}$,
- Then compute $p_{\text{PCR6}}(x) = p_1(x)I_1(x) + p_2(x)I_2(x)$.

It appears clearly that computed and sampled densities match well, thus confirming the rightness of our sampling method. Now, contrariwise to the Bayesian rule, it is noticed two different behaviors (which are foreseeable mathematically):

- When the densities p_1 and p_2 are close, p_{PCR6} acts as an amplifier of the information by reducing the variance. However, this phenomena is weaker than for p_{Bayes} . p-PCR6 is thus able to amplify the fused information, but is less powerful than the Bayesian rule in this task.
- When the densities p_1 and p_2 are distant, p_{PCR6} keeps both modes present in each density and preserves the richness of information by not merging both densities into only one (unimodal) Gaussian density. This is a very interesting and new property from a theoretical point of view, which presents advantages for practical applications.

In regards to these differences, it is thus foreseeable that the p-PCR6 should be more robust to potential errors.

4.4 A distributed sequential filtering application

4.4.1 Whitened p-PCR6 rule

It has been seen that the p-PCR6 fusion of the same densities $p_1 = p_2$ will result in an amplified density p_{PCR6} . Of course, this is not practicable when the densities p_1 and p_2 are related to correlated variables. Consider for example that the state y are measured by z^1 and z^2 . The (distributed) posterior probabilities are $p_s(y) = p(y|z^s) \propto p(y)p(z^s|y)$ for $s = 1, 2$. It happens that p_1 and p_2 are correlated, so that p-PCR6 should not be applied directly. In particular, the fusion of p_1 and p_2 by means of p-PCR6 results in a density p_{PCR6} stronger than the prior p over y , even when there is no informative measure, *i.e.* $p(z^s|y) = p(z^s)$! In order to handle this difficulty, we propose a *whitened* p-PCR6 rule, producing a fused density $p_{\text{whitePCR6}}$ from the updated information only:

$$p_{\text{whitePCR6}}(y) = \int \int_{\Theta^2} p_1(y_1)p_2(y_2)\pi(y|y_1, y_2) dy_1 dy_2, \quad (4.14)$$

$$\text{where } \pi(y|y_1, y_2) = \frac{\frac{p(y_1|z^1)}{p(y_1)}\delta[y_1 = y] + \frac{p(y_2|z^2)}{p(y_2)}\delta[y_2 = y]}{\frac{p(y_1|z^1)}{p(y_1)} + \frac{p(y_2|z^2)}{p(y_2)}}.$$

In (4.14), the proportion $\frac{p(y|z^s)}{p(y)}$ should be considered as the information intrinsically obtained from sensor s . It happens that the whitened p-PCR6 does not change the prior when there is no informative measure, *i.e.* $p_{\text{whitePCR6}}(y) = p(y)$ when $p(z^s|y) = p(z^s)$ for $s = 1, 2$.

4.4.2 Theoretical setting

A target is moving according to a known Markov prior law. Let y_t be the state of the target at time t . It is assumed:

$$p(y_{1:t+1}) = p(y_{t+1}|y_t)p(y_{1:t}).$$

In order to estimate the state of the target, S sensors are providing some measurements. Denote z_t^s the measurement of the state y_t by sensor s . The measure is characterized by the law $p(z_t^s|y_t)$, which is known. It is assumed

that the measure are made independently, conditionally to the state:

$$p(z_t^{1:S}|y_t) = \prod_{s=1}^S p(z_t^s|y_t) .$$

Our purpose is to derive or approximate the optimal estimator, $p(y_{t+1}|z_{1:t+1}^{1:S})$, from the distributed retroacted estimators, $p(y_{t+1}|z_{1:t}^{1:S}, z_{t+1}^s)$, related to sensors s . There is a Bayesian approach to this problem, and we propose some comparison with a p-PCR6 approach and a whitened p-PCR6 approach.

4.4.2.1 Distributed Bayesian filter

This filter is derived from:

$$p(y_{t+1}|z_{1:t}^{1:S}) = \int_{y_t} p(y_{t+1}|y_t)p(y_t|z_{1:t}^{1:S}) dy_t , \quad (4.15)$$

$$p(y_{t+1}|z_{1:t}^{1:S}, z_{t+1}^s) \propto p(z_{t+1}^s|y_{t+1})p(y_{t+1}|z_{1:t}^{1:S}) , \quad (4.16)$$

$$p(y_{t+1}|z_{1:t+1}^{1:S}) \propto \left(\prod_{s=1}^S \frac{p(y_{t+1}|z_{1:t}^{1:S}, z_{t+1}^s)}{p(y_{t+1}|z_{1:t}^{1:S})} \right) p(y_{t+1}|z_{1:t}^{1:S}) . \quad (4.17)$$

This approach is unstable, when some components of the target state are non-observable; for example, adaptations of the method are necessary [2] for bearing only sensors. However, the method will be applied as it is here to bearing only sensors, in order to compare to the robustness of the PCR6 approach.

4.4.2.2 p-PCR6 filter

This filter is derived from (4.15), (4.16) and:

$$p(y_{t+1}|z_{1:t+1}^{1:S}) = \int_{y_{t+1}^{1:S}} \left(\prod_{s=1}^S p(y_{t+1}^s|z_{1:t}^{1:S}, z_{t+1}^s) \right) \pi(y_{t+1}|y_{t+1}^{1:S}) dy_{t+1}^{1:S} \quad (4.18)$$

$$\text{where } \pi(y_{t+1}|y_{t+1}^{1:S}) = \frac{\sum_{s=1}^S p(y_{t+1}^s|z_{1:t}^{1:S}, z_{t+1}^s) \delta[y_{t+1} = y_{t+1}^s]}{\sum_{s=1}^S p(y_{t+1}^s|z_{1:t}^{1:S}, z_{t+1}^s)} ,$$

and $p(y_{t+1}^s|z_{1:t}^{1:S}, z_{t+1}^s)$ is an instance of $p(y_{t+1}|z_{1:t}^{1:S}, z_{t+1}^s)$, obtained by just replacing y_{t+1} by y_{t+1}^s .

It is noticed that this filter is necessary suboptimal, since it makes use of the p-PCR6 rule on correlated variables. The whitened p-PCR6 filter will resolve this difficulty. However, it is seen that the p-PCR6 filter still works experimentally on the considered examples.

4.4.2.3 Whitened p-PCR6 filter

This filter is derived from (4.15), (4.16) and:

$$p(y_{t+1}|z_{1:t+1}^{1:S}) = \int_{y_{t+1}^{1:S}} \left(\prod_{s=1}^S p(y_{t+1}^s|z_{1:t}^{1:S}, z_{t+1}^s) \right) \pi(y_{t+1}|y_{t+1}^{1:S}) dy_{t+1}^{1:S} \quad (4.19)$$

$$\text{where } \pi(y_{t+1}|y_{t+1}^{1:S}) = \frac{\sum_{s=1}^S \frac{p(y_{t+1}^s|z_{1:t}^{1:S}, z_{t+1}^s)}{p(y_{t+1}^s|z_{1:t}^{1:S})} \delta[y_{t+1} = y_{t+1}^s]}{\sum_{s=1}^S \frac{p(y_{t+1}^s|z_{1:t}^{1:S}, z_{t+1}^s)}{p(y_{t+1}^s|z_{1:t}^{1:S})}}.$$

Again, y_{t+1}^s is just an instance of y_{t+1} for sensor s .

These filters have been implemented by means of particles. The sampling of p-PCR6 has been explained yet, but it is not the purpose of this paper to explain all the theory of particle filtering; a consultation of the literature, *e.g.* [9], is expected.

4.4.3 Scenario and tests

These examples are retrieved from [4]. This work has been implemented by *Alois Kirchner* during his internship in our team.

4.4.3.1 Scenario for passive multi-sensor target tracking

In order to test the p-PCR6 fusion rule, we simulate the following scenario: in a 2-dimensional space, two independent passive sensors are located in (0,100) and (100,0) in Cartesian coordinates. These sensors provide a noisy azimuth measurement (0.01 rad. normal noise) on the position of a moving target. We associate a tracking particle filter to each sensor. The motion model is the following :

$$\begin{aligned} \dot{x}_{t+1} &= \dot{x}_t + 0.1 * N(0, 1) \\ \dot{y}_{t+1} &= \dot{y}_t + 0.1 * N(0, 1) \\ x_{t+1} &= x_t + dt * \dot{x}_t + 0.3 * N(0, 1) \\ y_{t+1} &= y_t + dt * \dot{y}_t + 0.3 * N(0, 1) \end{aligned} \quad (4.20)$$

where $dt = 1$ time unit and $N(0,1)$ is the normal distribution.

In our simulations, each local particle filter is implemented by means of 200 particles. At each time step, we proceed to the fusion of the local posterior densities and then re-inject the fused state density into each local filter (feedback loop). Three different paradigms are considered for the fusion: Bayesian, p-PCR6 and whitened p-PCR6 rules. These filters try to estimate both the position and speed of the target which is assumed to follow a quasi-constant velocity model. It is noticed that we are dealing directly with both the observable and non-observable components of the target state.

4.4.3.2 A simple example

In this first example, the filters are well initialized (we give them good starting speed and position). The mobile follows a non-linear trajectory (figure 4.4), in order to show the capability of this distributed filter to converge. On this example, the Bayesian filter manages to track the target with some difficulties during the last curve in figure 4.4. On the same example, p-PCR6 and whitened p-PCR6 rules have been tested with success. While both filters have to reestimate the speed direction at each turn, it appears that this reestimation is more difficult for p-PCR6. This difference is also particularly apparent during the last curve.

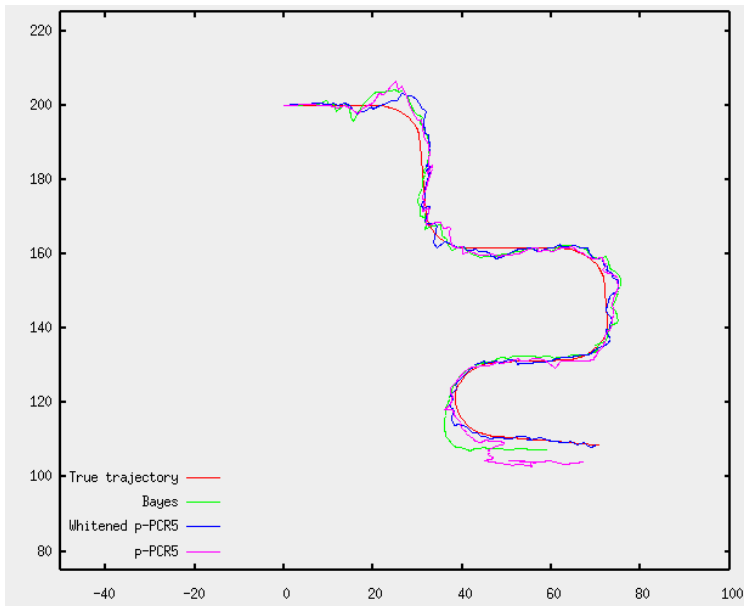
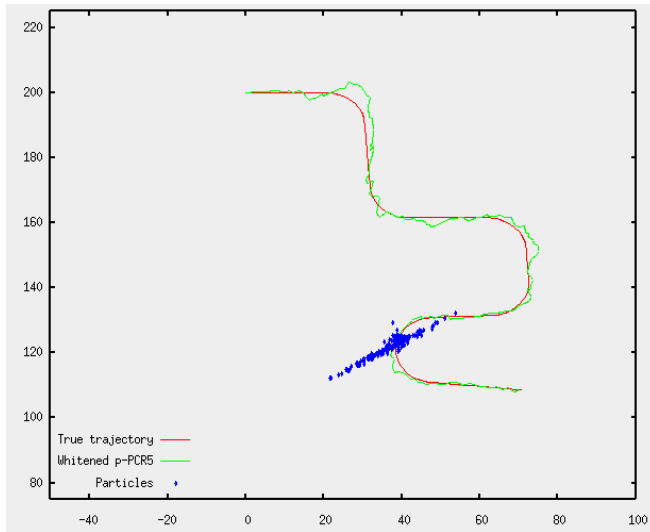
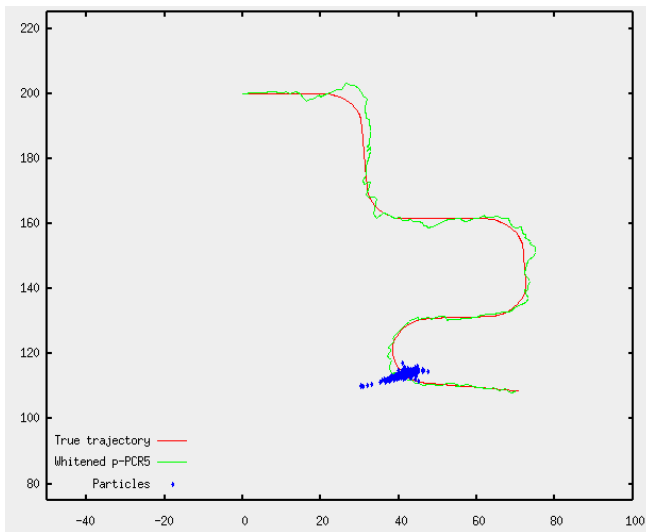

Figure 4.4: Estimated trajectories using different tracking methods.

Figure 4.5 displays the particle cloud of the whitened PCR6 filter during and after the last curve. The variance rises along the curve, resulting in the cross-like cloud of sub-figure 4.5(a), which is characteristic to the p-PCR6 fusion: *the branches correspond to the direction the sensors are looking at*. Then, the p-PCR6, by amplifying the zone where the filters are according to see the object, allows the process to converge again toward the object real position in an expansion-contraction pattern (figure 4.5(b)).



(a) Time step 160.



(b) Time step 170.

Figure 4.5: Particle clouds for whitened p-PCR6 in the last curve.

In more difficult cases, with poor initialization for instance (see figure 4.6), both p-PCR6 and whitened p-PCR6 manage to follow the target, while the Bayesian filter diverges in about one third of the cases and give mitigate results otherwise.

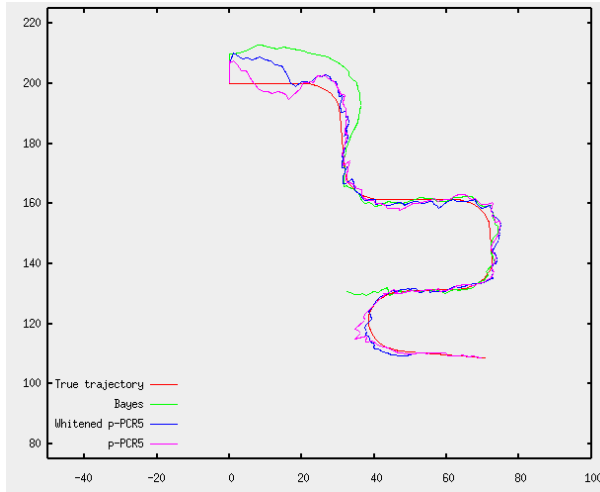

Figure 4.6: Estimated trajectories using different tracking methods. Poor initialization: null speed and 10 units away starting position.

Next sections investigate more thoroughly the properties of the whitened p-PCR6 filtering.

4.4.3.3 Whitened p-PCR6 robustness against poor initialization

In order to test the capability of (whitened) p-PCR6 to recover from erroneous measurements or from a total contradiction of the local estimations, we considered two scenarios in which the filters are badly initialized at various degrees. In these scenarios, the real trajectory of the object is the same: it starts from $(200, 0)$ and moves toward $(200, 150)$ at a constant speed $(0, 1)$.

In the first scenario (figure 4.7), the first filter, which sensor is placed at $(0, 100)$, is initialized at position $(190, 10)$ and at speed $(0, 0)$. The second filter, which sensor is at $(100, 0)$, is initialized at position $(210, 10)$ and at the same speed (figure 4.7(a)). As the estimated positions are far from the real one and both sensors are looking at the object from a remote position, the particle cloud quickly spread horizontally (figure 4.7(b)). Then the (whitened) PCR6 begins to find zones where both filters estimate a non-negligible probability of presence and amplifies them until convergence (figure 4.7(c)). Though the particle cloud still seems to be fairly spread (because of

sensors remote position), the global estimate is very close from the real position and speed, and will remain so until the last time step (figure 4.7(d)).

		x	y	x speed	y speed
First example	Filter 1	190	10	0	0
	Filter 2	210	10	0	0
Second example	Filter 1	190	10	0.1	-1
	Filter 2	210	10	0.5	1.5

Table 4.1: Initialization data.

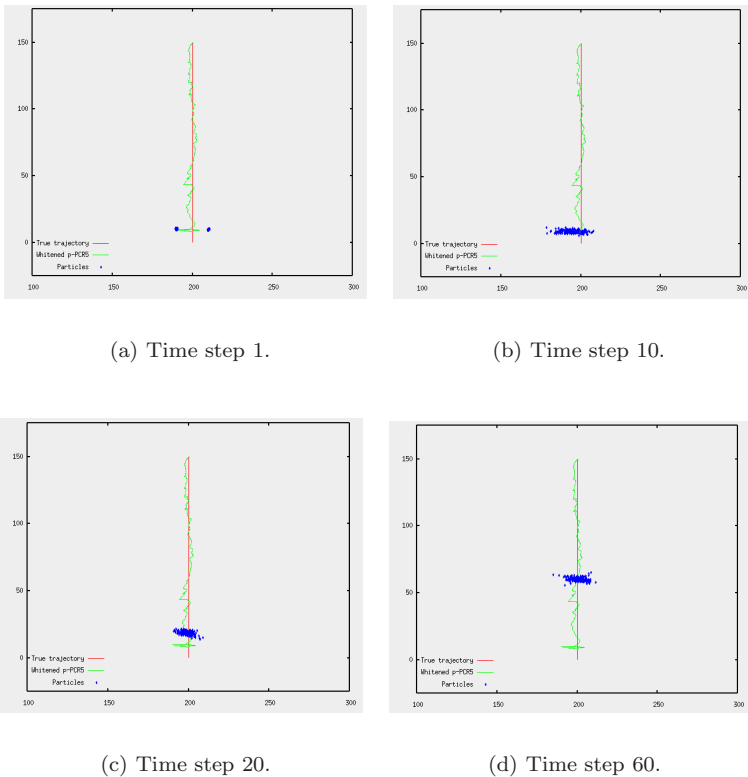
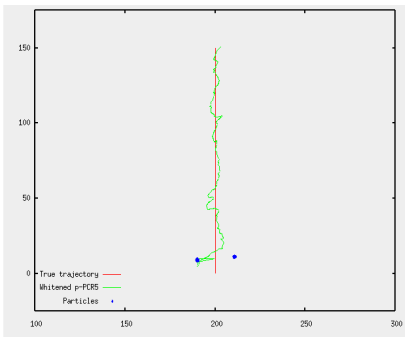
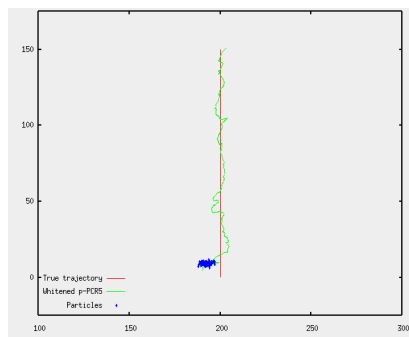

Figure 4.7: The real mobile starts at (200,0) and moves upward at constant speed (0,1); poor filters initialization.

Our second example (figure 4.8) is an extreme case: the initialization is quite worse (see table 4.1), since our motion model assumes nearly constant speed and therefore makes it hard to recover from such erroneous and contradictory speed initialization. An interesting point is that, for a tight prediction noise, p-PCR6 sometimes does not converge on this example, while whitened p-PCR6 usually does. Artificially raising the prediction noise solves this problem for ‘standard’ p-PCR6, showing its trend to over-concentrate the particle cloud.



(a) Time step 1.



(b) Time step 10.

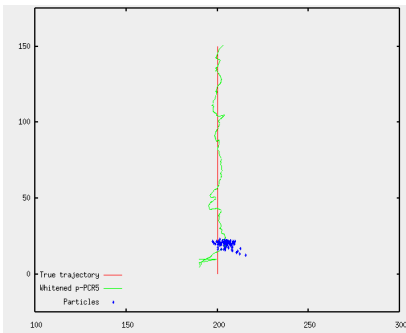

(c) Time step 20.

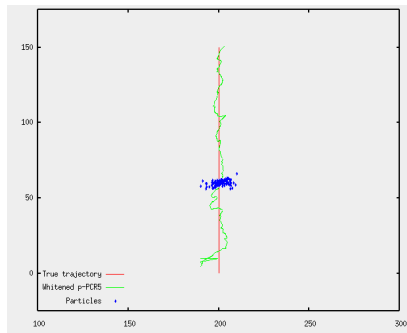

(d) Time step 60.

Figure 4.8: The real mobile starts at $(200, 0)$ and moves upward at constant speed $(0, 1)$; *bad* filters initialization.

4.4.3.4 Whitenened p-PCR6 versus mean

As seen before, the PCR6-fusion of two probabilistic densities amplifies the areas where both densities have a non-negligible value. Otherwise, it usually works like just averaging the two densities. In order to measure the impact of the amplification, we reprocessed the first example of previous subsection while using the mean, $p_{\text{mean}} = \frac{p_1 + p_2}{2}$, instead of p-PCR6. The result (figure 4.9) is self explanatory: the same expansion as with p-PCR6 occurs (figure 4.7), but contraction never happens.

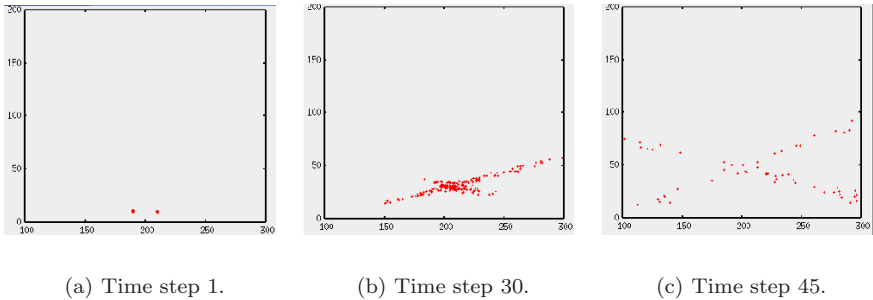

Figure 4.9: Using mean instead of p-PCR6. Red dots are the positions of the particles after fusion. The real mobile starts from (200,0) at time step 0 and moves at the constant speed (0,1).

4.4.3.5 Concluding remarks

The results presented here have clearly shown that p-PCR6, and especially whitenened p-PCR6, filters are more robust than the Bayesian filter against bad initialization. However, it is clear that Bayesian filters are the best, when the priors are correctly defined. The real interest of p-PCR6 is that it does not need a precise prior knowledge about the antedating local particle filters.

4.5 Conclusions

This paper has investigated a new fusion rule, p-PCR6, for fusing probabilistic densities. This rule is derived from the PCR6 rule for fusing evidences. It has a simple interpretation from a sampling point of view. p-PCR6 has been compared to the Bayesian rule on a simple fusion example. Then, it has been shown that p-PCR6 was able to maintain multiple hypothesis in the fusion process, by generating multiple modes. Thus, more robustness of p-PCR6 were foreseeable in comparison to Bayes' rule. This robustness has been tested successfully on examples of distributed target

tracking. It is expected that this new rule will have many applications, in particular in case of ill-posed filtering problems.

4.6 References

- [1] S. Arulampalam, S. Maskell, N. Gordon, T. Clapp, *A Tutorial on Particle Filters for On-line Non-linear/Non-Gaussian Bayesian Tracking*, IEEE Trans. on Signal Processing, Vol. 50 (2), pp. 174–188, 2002.
- [2] Th. Bréhard, J.-P. Le Cadre, *Hierarchical particle filter for bearings only tracking*, IEEE Trans. on Aerospace and Electronic Systems, 2006.
- [3] Y. Bar-Shalom, *Estimation and Tracking: Principles and Techniques*, YBS Publishing, 1991.
- [4] A. Kirchner, F. Dambreville, F. Celeste, J. Dezert, F. Smarandache, *Application of probabilistic PCR5 Fusion Rule for Multisensor Target Tracking*, International Conference on Information Fusion, Quebec, Canada, 9–12 July 2007.
- [5] A. Martin, C. Osswald, *A new generalization of the proportional conflict redistribution rule stable in terms of decision*, Applications and Advances of DSMT for Information Fusion, Book 2, American Research Press Rehoboth, F. Smarandache and J. Dezert, pp. 69–88 2006.
- [6] K.S. Miller, *Multidimensional Gaussian Distributions*, John Wiley & Sons, Inc., New York, 1964.
- [7] N. Oudjane, C. Musso, F. Legland, *Improving regularized particle filters*, in Doucet, De Freitas, and Gordon, editors, *Sequential Monte Carlo Methods in Practice*, New York, 2001. Springer-Verlag.
- [8] A. Papoulis, *Probability, random variables and stochastic processes*, Mc Graw-Hill Book Company, New York, 1965 (1984 reedition).
- [9] B. Ristic, S. Arulampalam, N. Gordon, *Beyond the Kalman Filter: Particle Filters for Tracking Applications*, Artech House, 2004.
- [10] F. Smarandache, J. Dezert, *Information Fusion Based on New Proportional Conflict Redistribution Rules*, International Conference on Information Fusion, Philadelphia, U.S.A., 25–29 July 2005.
- [11] F. Smarandache, J. Dezert, *Proportional Conflict Redistribution Rules for Information Fusion*, Applications and Advances of DSMT for Information Fusion, Book 2, American Research Press, Rehoboth, F. Smarandache and J. Dezert, pp. 3–68, 2006.
- [12] F. Smarandache, J. Dezert (Editors), *Applications and Advances on DSMT for Information Fusion (Collected Works)*, American Research Press, Rehoboth, June 2006.
<http://www.gallup.unm.edu/~smarandache/DSMT-book2.pdf>.

Chapter 5

A class of fusion rules based on the belief redistribution to subsets or complements

Florentin Smarandache
Chair of Math. & Sciences Dept.,
Univ. of New Mexico, 200 College Road,
Gallup, NM 87301, U.S.A.
smarand@unm.edu

Arnaud Martin
ENSIETA E312-EA3876,
2 Rue François Verny,
29806 Brest Cedex 9, France.
Arnaud.Martin@ensieta.fr

Jean Dezert
The French Aerospace Lab,
29 Avenue de la Division Leclerc,
92320 Châtillon, France.
jean.dezert@onera.fr

Abstract:

In this chapter we present a class of fusion rules based on the redistribution of the conflicting or even non-conflicting masses to the subsets or to the complements of the elements involved in the conflict proportionally with respect to their masses or/and cardinals. At the end, these rules are presented in a more general theoretical way including explicitly the reliability of each source of evidence. Some examples are also provided.

5.1 Introduction

In DSMT, we take very care of the model associated with the set Θ of hypotheses where the solution of the problem is assumed to belong to. In particular, the three main sets: $2^\Theta \triangleq (\Theta, \cup)$ (power set), $D^\Theta \triangleq (\Theta, \cup, \cap)$ (hyper-power set) and $S^\Theta \triangleq (\Theta, \cup, \cap, c(\cdot))$ (super-power set) can be used depending on their ability to fit adequately with the nature of the hypotheses of the frame under consideration. These sets had been presented with examples in Chapter 1 of this volume and will be not reintroduced here. We just recall that the notion of super-power set has been introduced by Smarandache in the Chapter 8 of [13] and corresponds actually to the theoretical construction of the power set of the minimal refined frame Θ^{ref} of Θ . Actually, Θ generates S^Θ under operators \cup , \cap and complementation $c(\cdot)$. S^Θ is a Boolean algebra with respect to the union, intersection and complementation. Therefore working with the super-power set is equivalent to work with the power set of a minimal theoretical refined frame Θ^{ref} when the refinement is possible satisfying Shafer's model as explained in Chapter 1. Of course, when Θ already satisfies Shafer's model, the hyper-power set D^Θ and the super-power set S^Θ coincide with the classical power set 2^Θ of Θ . In general, $2^\Theta \subseteq D^\Theta \subseteq S^\Theta$. In this chapter, we introduce a new family of fusion rules based on redistribution of the conflicting (or even non-conflicting masses) to subsets or complements (RSC) for working either on the super-power set S^Θ or directly on 2^Θ whenever Shafer's model holds for Θ . This RSC family of fusion rules which uses the complementation operator $c(\cdot)$ cannot be performed on hyper-power set D^Θ since by construction the complementation is not allowed in D^Θ .

Note that these last years, the DSMT has relaunched the studies on the combination rules especially in order to manage the conflict [1, 2, 7, 11, 12]. In [9], we proposes in the context of the DSMT some rules where not only the conflict is transferred. In [15, 16] some new combination rules are proposed to redistribute the belief to subsets or complements. Some of these rules are built similarly to the proportional conflict redistribution rules [3]. Here we extend the idea of rules based on the belief redistribution to subsets or complements.

5.2 Fusion rules based on RSC

Let $\Theta = \{\theta_1, \theta_2, \dots, \theta_n\}$, for $n \geq 2$, be the frame of discernment of the problem under consideration, and $S^\Theta = (\Theta, \cup, \cap, c(\cdot))$ its super-power set (see Chapter 1 for details) where $c(\cdot)$ means the complementation operator in S^Θ . Let's denote I_t the total ignorance, i.e. $I_t \triangleq \theta_1 \cup \theta_2 \cup \dots \cup \theta_n$. Let $m_1(\cdot)$ and $m_2(\cdot)$ be two normalized basic belief assignments (bba's) defined from S^Θ to $[0, 1]$. We use the conjunctive rule to first combine $m_1(\cdot)$ with $m_2(\cdot)$ to get $m_{12}(\cdot)$ and then we redistribute the mass of conflict $m_{12}(X \cap Y) \neq 0$, when $X \cap Y = \emptyset$ or even when $X \cap Y$ different from the empty set, in eight ways where all denominators in these fusion rule formulas are supposed different from zero. In the sequel, we denote these rules with the acronym RSC (standing for Redistribution to Subsets or Complements) for notation convenience.

5.2.1 RSC rule no 1

If $X \cap Y = \emptyset$, then $m_{12}(X \cap Y)$ is redistributed to $c(X \cup Y)$ in the case we are not confident in X nor in Y , but we use a pessimistic redistribution. Mathematically, this RSC1 fusion rule is given by $m_{RSC1}(\emptyset) = 0$, and for all $A \in S^\Theta \setminus \{\emptyset, I_t\}$ by:

$$m_{RSC1}(A) = m_{12}(A) + \sum_{\substack{X, Y \in S^\Theta \\ X \cap Y = \emptyset \text{ and } c(X \cup Y) = A}} m_1(X)m_2(Y) \quad (5.1)$$

where $m_{12}(A) = \sum_{\substack{X, Y \in S^\Theta \\ X \cap Y = A}} m_1(X)m_2(Y)$ is the mass of the conjunctive consensus on A .

For the total ignorance, one has:

$$m_{RSC1}(I_t) = m_{12}(I_t) + \sum_{\substack{X, Y \in S^\Theta \\ X \cap Y = \emptyset \text{ and } c(X \cup Y) = \emptyset}} m_1(X)m_2(Y) \quad (5.2)$$

The second term of (5.2) takes care for the case where the complement of $X \cup Y$ is \emptyset while $X \cap Y = \emptyset$. In that specific case, the mass of $X \cap Y$ is transferred to the total ignorance.

5.2.2 RSC rule no 2

If $X \cap Y = \emptyset$, then $m_{12}(X \cap Y)$ is redistributed to all subsets of $c(X \cup Y)$ proportionally with respect to their corresponding masses in the case we are not confident in X nor in Y , but we use an optimistic redistribution. Mathematically, this RSC2 fusion rule is given by $m_{RSC2}(\emptyset) = 0$, and for all $A \in S^\Theta \setminus \{\emptyset, I_t\}$ by:

$$m_{RSC2}(A) = m_{12}(A) + \sum_{\substack{X, Y \in S^\Theta \\ X \cap Y = \emptyset, A \in c(X \cup Y)}} \frac{m_1(X)m_2(Y)}{\sum_{Z \in c(X \cup Y) \subset S^\Theta} m_{12}(Z)} \cdot m_{12}(A) \quad (5.3)$$

where the denominator of the fraction is different from zero. If the denominator is zero, that fraction is discarded.

For the total ignorance, one has:

$$\begin{aligned}
 m_{RSC2}(I_t) = & m_{12}(I_t) + \sum_{\substack{X, Y \in S^\Theta \\ X \cap Y = \emptyset \text{ and } c(X \cup Y) = \emptyset}} m_1(X)m_2(Y) \\
 & + \sum_{\substack{X, Y \in S^\Theta \\ X \cap Y = \emptyset \text{ and } \sum_{Z \in c(X \cup Y) \subset S^\Theta} m_{12}(Z) = 0}} m_1(X)m_2(Y) \quad (5.4)
 \end{aligned}$$

$m_{RSC2}(I_t)$ works similarly as $m_{RSC1}(I_t)$ in the first 2 parts; in addition of this, it also assigns to I_t the masses of empty intersections whose all subsets have the mass equals to zero, so no such proportionalization is possible in $m_{RSC2}(A)$ previous formula.

5.2.3 RSC rule no 3

If $X \cap Y = \emptyset$, then $m_{12}(X \cap Y)$ is redistributed to all subsets of $c(X \cup Y)$ proportionally with respect to their corresponding *cardinals* (not masses as we did in RSC2) in the case we are not confident in X nor in Y ; this is a prudent redistribution with respect to the cardinals. Mathematically, this RCS3 fusion rule is given by $m_{RSC3}(\emptyset) = 0$, and for all $A \in S^\Theta \setminus \{\emptyset, I_t\}$ by:

$$m_{RSC3}(A) = m_{12}(A) + \sum_{\substack{X, Y \in S^\Theta \\ X \cap Y = \emptyset, A \in c(X \cup Y)}} \frac{m_1(X)m_2(Y)}{\sum_{Z \in c(X \cup Y) \subset S^\Theta} Card(Z)} \cdot Card(A) \quad (5.5)$$

where the denominator of the fraction is different from zero. If the denominator is zero, that fraction is discarded.

For the total ignorance, one has:

$$\begin{aligned}
 m_{RSC3}(I_t) = & m_{12}(I_t) + \sum_{\substack{X, Y \in S^\Theta \\ X \cap Y = \emptyset \text{ and } c(X \cup Y) = \emptyset}} m_1(X)m_2(Y) \\
 & + \sum_{\substack{X, Y \in S^\Theta \\ X \cap Y = \emptyset \text{ and } \sum_{Z \in c(X \cup Y) \subset S^\Theta} Card(Z) = 0}} m_1(X)m_2(Y) \quad (5.6)
 \end{aligned}$$

5.2.4 RSC rule no 4

If $X \cap Y = \emptyset$, then $m_{12}(X \cap Y)$ is redistributed to all subsets of $c(X \cup Y)$ proportionally with respect to their corresponding *masses and cardinals* (i.e. RSC2 and RSC3

combined) in the case we are not confident in X nor in Y ; this is a mixture of optimistic and prudent redistribution and this resembles somehow to DS_mP (see Chapter 3 and we could also introduce an ϵ tuning parameter). Mathematically, this RCS4 fusion rule is given by $m_{RSC4}(\emptyset) = 0$, and for all $A \in S^\ominus \setminus \{\emptyset, I_t\}$ by:

$$m_{RSC4}(A) = m_{12}(A) + \sum_{\substack{X, Y \in S^\ominus \\ X \cap Y = \emptyset, A \in c(X \cup Y)}} \frac{m_1(X)m_2(Y)}{\sum_{Z \in c(X \cup Y) \subset S^\ominus} [m_{12}(Z) + Card(Z)]} \cdot [m_{12}(A) + Card(A)] \quad (5.7)$$

where the denominator of the fraction is different from zero. If the denominator is zero, that fraction is discarded.

For the total ignorance, one has:

$$m_{RSC4}(I_t) = m_{12}(I_t) + \sum_{\substack{X, Y \in S^\ominus \\ X \cap Y = \emptyset \text{ and } c(X \cup Y) = \emptyset}} m_1(X)m_2(Y) + \sum_{\substack{X, Y \in S^\ominus \\ X \cap Y = \emptyset \text{ and } \sum_{Z \in c(X \cup Y) \subset S^\ominus} [m_{12}(Z) + Card(Z)] = 0}} m_1(X)m_2(Y) \quad (5.8)$$

5.2.5 RSC rule no 5

If $X \cap Y = \emptyset$, then $m_{12}(X \cap Y)$ is redistributed to X and Y proportionally with respect to their corresponding *cardinals*. Mathematically, this RSC5 fusion rule is given by $m_{RSC5}(\emptyset) = 0$, and for all $A \in S^\ominus \setminus \{\emptyset\}$ by:

$$m_{RSC5}(A) = m_{12}(A) + \sum_{\substack{X \in S^\ominus \\ X \cap A = \emptyset}} \frac{m_1(X)m_2(A) + m_1(A)m_2(X)}{Card(X) + Card(A)} \cdot Card(A) \quad (5.9)$$

where the denominator of the fraction is different from zero. If the denominator is zero, that fraction is discarded.

5.2.6 RSC rule no 6

If $X \cap Y = \emptyset$, then $m_{12}(X \cap Y)$ is redistributed to all subsets of $X \cup Y$ proportionally with respect to their corresponding *cardinals*. Mathematically, this RSC6 fusion rule is given by $m_{RSC6}(\emptyset) = 0$, and for all $A \in S^\ominus \setminus \{\emptyset\}$ by:

$$m_{RSC6}(A) = m_{12}(A) + \sum_{\substack{X, Y \in S^\Theta \\ X \cap Y = \emptyset \\ A \subseteq X \cup Y}} \frac{m_1(X)m_2(Y)}{\sum_{Z \in S^\Theta, Z \subseteq X \cup Y} Card(Z)} \cdot Card(A) \quad (5.10)$$

where the denominator of the fraction is different from zero. If the denominator is zero, that fraction is discarded.

5.2.7 RSC rule no 7

If $X \cap Y = \emptyset$, then $m_{12}(X \cap Y)$ is redistributed to X and Y proportionally with respect to their corresponding *cardinals and masses*. Mathematically, this RSC7 fusion rule is given by $m_{RSC7}(\emptyset) = 0$, and for all $A \in S^\Theta \setminus \{\emptyset\}$ by:

$$m_{RSC7}(A) = m_{12}(A) + \sum_{\substack{X \in S^\Theta \\ X \cap A = \emptyset}} \frac{m_1(X)m_2(A) + m_1(A)m_2(X)}{Card(X) + Card(A) + m_{12}(X) + m_{12}(A)} \cdot [Card(A) + m_{12}(A)] \quad (5.11)$$

where the denominator of the fraction is different from zero. If the denominator is zero, that fraction is discarded.

5.2.8 RSC rule no 8

If $X \cap Y = \emptyset$, then $m_{12}(X \cap Y)$ is redistributed to all subsets of $X \cup Y$ proportionally with respect to their corresponding *cardinals and masses*. Mathematically, this new fusion rule (denoted RSC8) is given by $m_{RSC8}(\emptyset) = 0$, and for all $A \in S^\Theta \setminus \{\emptyset\}$ by:

$$m_{RSC8}(A) = m_{12}(A) + \sum_{\substack{X, Y \in S^\Theta \\ X \cap Y = \emptyset \\ A \subseteq X \cup Y}} \frac{m_1(X)m_2(Y)}{\sum_{Z \in S^\Theta, Z \subseteq X \cup Y} Card(Z) + m_{12}(Z)} \cdot [Card(A) + m_{12}(A)] \quad (5.12)$$

where the denominator of the fraction is different from zero. If the denominator is zero, that fraction is discarded.

5.2.9 Remarks

We can generalize all these previous formulas for any $s \geq 2$, where s is the number of sources. We can adjust all these formulas for the case when $X \cap Y \neq \emptyset$ but we still want to transfer $m_{12}(X \cap Y)$ to subsets of $c(X \cup Y)$, or to subset of $X \cup Y$, or to both groups of subsets, but we need to have a justification for these.

In choosing a fusion rule, among so many, we apply the following criteria:

- a) Reliability of sources of information $m_i(\cdot)$: Are they all reliable or not ? In what percentage is reliable each source ?
- b) Confidence in the hypotheses of the frame of discernment and in elements of S^\ominus : Are we confident in all of them ? In what percentage are we confident in each of them ?
- c) Optimistic, pessimistic, or medium redistribution of the conflicting masses - depending on user's experience.

5.3 A new class of RSC fusion rules

Using the conjunctive rule, let's denote:

$$m_{\cap}(A) \equiv m_{12}(A) = [m_1 \oplus m_2](A) = \sum_{\substack{X, Y \in S^\ominus \\ X \cap Y = A}} m_1(X)m_2(Y)$$

For $A \in S^\ominus \setminus \{\emptyset, I_t\}$, we have the following new class of fusion rule (denoted $CRSC_c$) for transferring the conflicting masses only:

$$m_{CRSC_c}(A) = m_{\cap}(A) + [\alpha \cdot m_{\cap}(A) + \beta \cdot Card(A) + \gamma \cdot f(A)] \cdot \sum_{\substack{X, Y \in S^\ominus \\ X \cap Y = \emptyset \\ A \subseteq M}} \frac{m_1(X)m_2(Y)}{\sum_{Z \in S^\ominus, Z \subseteq M} [\alpha \cdot m_{\cap}(Z) + \beta \cdot Card(Z) + \gamma \cdot f(Z)]} \quad (5.13)$$

where M can be $c(X \cup Y)$, or a subset of $c(X \cup Y)$, or $X \cup Y$, or a subset of $X \cup Y$; $\alpha, \beta, \gamma \in \{0, 1\}$ but $\alpha + \beta + \gamma \neq 0$; in a weighted way we can take $\alpha, \beta, \gamma \in [0, 1]$ also with $\alpha + \beta + \gamma \neq 0$; $f(X)$ is a function of X , i.e. another parameter that the mass of X is directly proportionally with respect to; $card(X)$ is the cardinal of X .

And $m_{CRSC_c}(I_t)$ is given by:

$$m_{CRSC_c}(I_t) = m_{\cap}(I_t) + \sum_{\substack{X, Y \in S^\ominus \\ \{X \cap Y = \emptyset \text{ and } M = \emptyset\} \\ \text{or } \{X \cap Y = \emptyset \text{ and } Den(Z) = 0\}}} m_1(X)m_2(Y) \quad (5.14)$$

where $Den(Z) \triangleq \sum_{Z \in S^\Theta, Z \subseteq M} [\alpha \cdot m_\cap(Z) + \beta \cdot Card(Z) + \gamma \cdot f(Z)]$.

In $m_{CRSCc}(\cdot)$ formula if we replace: $\alpha = 0$ or 1 , $\beta = 0$ or 1 , $\gamma = 0$, $M = c(X \cup Y)$ or $X \cup Y$, or $\{\{X\}, \{Y\}\}$, we obtain nine fusion rules including the previous 2-8 rules. For $\alpha = 1$, $\beta = 0$, $\gamma = 0$, $M = \{c(X), X \cap Y, c(Y)\}$, we obtain one of Yamada's rules [15, 16] and discussed in [3]. For $\alpha = 1$, $\beta = 0$, $\gamma = 0$, $M = \{X \cap Y, X \cup Y\}$, we obtain another one of Yamada's rules.

5.4 A general formulation

Let $\Theta = \{\theta_1, \theta_2, \dots, \theta_n\}$, for $n \geq 2$ be the frame of discernment, and $S^\Theta = (\Theta, \cup, \cap, c(\cdot))$ its super-power set. The element Θ (also denoted I_t) represents the total ignorance. When the elements θ_i are exclusive two by two S^Θ reduces to the classical power set 2^Θ , otherwise $S^\Theta \equiv 2^{\Theta^{ref}}$ if Θ is refinable and $|S^\Theta| = 2^{2^{|\Theta|}-1}$ (see chapter 1 for details and examples). $c(X)$ means the complement of X in S^Θ . $S^\Theta = (\Theta, \cup, \cap, c(\cdot))$ can also be written as:

$$S^\Theta = D^{\Theta \cup \Theta_c} = 2^{\Theta^{ref}} \tag{5.15}$$

where Θ_c represents the set of complements of the the elements of Θ in 2^Θ .

Example: Let's consider the example given in section 1.2.1 of Chapter 1 using $\Theta = \{\theta_1, \theta_2\}$ with $\theta_1 \cap \theta_2 \neq \emptyset$. According to the definition and the construction of the super-power set, one obtains directly

$$S^\Theta = (\Theta, \cup, \cap, c(\cdot)) = \{\emptyset, \theta_1 \cap \theta_2, \theta_1, \theta_2, \theta_1 \cup \theta_2, c(\theta_1 \cap \theta_2), c(\theta_1), c(\theta_2)\}$$

If we consider both sets $\Theta = \{\theta_1, \theta_2\}$ and $\Theta_c = \{c(\theta_1), c(\theta_2)\}$, then $\Theta \cup \Theta_c = \{\theta_1, \theta_2, c(\theta_1), c(\theta_2)\}$ with the integrity constraints $\theta_1 \cap c(\theta_1) = \emptyset$, $\theta_2 \cap c(\theta_2) = \emptyset$, $c(\theta_1) \cap c(\theta_2) = \emptyset$ and $(\theta_1 \cap \theta_2) \cap (c(\theta_1) \cap c(\theta_2)) = \emptyset$. The hyper-power set $D^{\Theta \cup \Theta_c}$ taking into account all integrity constraints is then given by:

$$D^{\Theta \cup \Theta_c} = \{\emptyset, \theta_1 \cap \theta_2, \theta_1, \theta_2, \theta_1 \cup \theta_2, c(\theta_1) \cup c(\theta_2), c(\theta_1), c(\theta_2)\}$$

but since $c(\theta_1) \cup c(\theta_2) = c(\theta_1 \cap \theta_2)$ (Morgan's law), one sees that

$$D^{\Theta \cup \Theta_c} = (\{\Theta \cup \Theta_c\}, \cup, \cap) = \{\emptyset, \theta_1 \cap \theta_2, \theta_1, \theta_2, \theta_1 \cup \theta_2, c(\theta_1 \cap \theta_2), c(\theta_1), c(\theta_2)\} = S^\Theta$$

Moreover, if we consider the following theoretical refined frame Θ^{ref} built from Θ as follows: $\Theta^{ref} = \{c(\theta_1), \theta_1 \cap \theta_2, c(\theta_2)\}$ where now all elements of Θ^{ref} are truly exclusive, then $2^{\Theta^{ref}} = \{\emptyset, c(\theta_1), \theta_1 \cap \theta_2, c(\theta_2), c(\theta_1) \cup (\theta_1 \cap \theta_2), c(\theta_1) \cup c(\theta_2), (\theta_1 \cap \theta_2) \cup c(\theta_2), c(\theta_1) \cup (\theta_1 \cap \theta_2) \cup c(\theta_2)\}$ which can be simplified since by construction of the refined frame, $\theta_1 = (\theta_2) \cup (\theta_1 \cap \theta_2)$, $\theta_2 = (\theta_1) \cup (\theta_1 \cap \theta_2)$ and $\theta_1 \cup \theta_2 = (\theta_1) \cup (\theta_1 \cap \theta_2) \cup (\theta_2)$:

$$2^{\Theta^{ref}} = \{\emptyset, c(\theta_1), \theta_1 \cap \theta_2, c(\theta_2), \theta_2, c(\theta_1) \cup c(\theta_2), \theta_1, \theta_1 \cup \theta_2\}$$

After rearranging the list of elements of $2^{\Theta^{ref}}$ and since $c(\theta_1) \cup c(\theta_2) = c(\theta_1 \cap \theta_2)$, one finally sees that

$$2^{\Theta^{ref}} = (\Theta^{ref}, \cup) = \{\emptyset, \theta_1 \cap \theta_2, \theta_1, \theta_2, \theta_1 \cup \theta_2, c(\theta_1 \cap \theta_2), c(\theta_1), c(\theta_2)\} = S^\Theta$$

The proposed class of fusion rules is based on a proportional conflict transfer. When there is no conflict between experts the conjunctive rule is used, otherwise the masses of conflicts resulting from conjunctive fusion of experts for incompatible propositions of (super) power set is redistributed on some compatible propositions through different mechanisms which give rise to different fusion rules as explained in the sequel. The use of the conjunctive rule assumes that the experts are reliable, or the reliability of each expert is known and taken into account in the mass values. We denote the set of intersections/conjunctions by: $S_\cap = \{X \in S^\Theta | X = Y \cap Z, \text{ where } Y, Z \in S^\Theta \setminus \{\emptyset\}\}$ where all propositions are expressed in their canonical form and where X contains at least an \cap symbol in its expression. For example, $A \cap A \notin S_\cap$ since $A \cap A$ is not in a canonical form and $A \cap A = A$. Also $(A \cap B) \cap B$ is not a canonical form but $(A \cap B) \cap B = A \cap B \in S_\cap$.

Let S_\cap^\emptyset be the set of all empty intersections from S_\cap (i.e. the set of exclusivity constraints), and $S_\cap^{non\emptyset}$ the set of all non-empty intersections from S_\cap , and $S_{\cap,r}^{non\emptyset}$ the set of all non-empty intersections from $S_\cap^{non\emptyset}$ whose masses are redistributed to other sets/propositions. The set $S_{\cap,r}^{non\emptyset}$ highly depends on the model for the frame of the application under consideration.

5.4.1 A general formula for the class of RSC fusion rules

For $A \in (S^\Theta \setminus S_\cap^{non\emptyset}) \setminus \{\emptyset, \Theta\}$, we propose the general formula for the redistribution of conflict and non-conflict to subsets or complements class of rules for the fusion of masses of belief for two sources of evidence:

$$m_{CRSC}(A) = m_\cap(A) + \sum_{\substack{X, Y \in S^\Theta \\ \{X \cap Y = \emptyset, A \in T(X, Y)\} \\ \text{or } \{X \cap Y \in S_{\cap,r}^{non\emptyset}, A \in T'(X, Y)\}}} f(A) \frac{m_1(X)m_2(Y)}{\sum_{Z \in T(X, Y)} f(Z)} \quad (5.16)$$

and for $A = \Theta$:

$$m_{CRSC}(\Theta) = m_\cap(\Theta) + \sum_{\substack{X, Y \in S^\Theta \\ X \cap Y = \emptyset, \\ \{T(X, Y) = \emptyset \text{ or } \sum_{Z \in T(X, Y)} f(Z) = 0\}}} m_1(X)m_2(Y) \quad (5.17)$$

where f is a mapping from S^Θ to \mathbb{R}^+ . For example, we can choose $f(X) = m_\cap(X)$, $f(X) = |X|$, $f^T(X) = \frac{|X|}{|T(X, Y)|}$, or $f(x) = m_\cap(X) + |X|$, etc. The function T specifies a subset of S^Θ , for example $T(X, Y) = \{c(X \cup Y)\}$, or $T(X, Y) = \{X \cup Y\}$ or can specify a set of subsets of S^Θ . For example, $T(X, Y) = \{A \subset c(X \cup Y)\}$,

or $T(X, Y) = \{A \subset X \cup Y\}$. The function T' is a subset of S^Θ , for example $T'(X, Y) = \{X \cup Y\}$, or T' is a subset of $X \cup Y$, etc.

It is important to highlight that in formulas (5.13)-(5.14) one transfers only the conflicting masses, whereas the formulas (5.16)-(5.17) are more general since one transfers the conflicting masses or the non-conflicting masses as well depending on the preferences of the fusion system designer. The previous formulas can be directly extended for any $s \geq 2$ sources of evidence as follows: For $A \in (S^\Theta \setminus S_{\cap}^{non\emptyset}) \setminus \{\emptyset, \Theta\}$ we have:

$$m_{CRSC}(A) = m_{\cap}(A) + \sum_{\substack{X_1, \dots, X_s \in S^\Theta \\ \{\cap_{i=1}^s X_i = \emptyset, A \in T(X_1, \dots, X_s)\} \\ \text{or } \{\cap_{i=1}^s X_i \in S_{\cap, r}^{non\emptyset}, A \in T'(X_1, \dots, X_s)\}}} f(A) \frac{\prod_{i=1}^s m_i(X_i)}{\sum_{Z \in T(X_1, \dots, X_s)} f(Z)} \quad (5.18)$$

and for $A = \Theta$:

$$m_{CRSC}(\Theta) = m_{\cap}(\Theta) + \sum_{\substack{X_1, \dots, X_s \in S^\Theta \\ \cap_{i=1}^s X_i = \emptyset, \\ \{T(X_1, \dots, X_s) = \emptyset \text{ or } \sum_{Z \in T(X_1, \dots, X_s)} f(Z) = 0\}}} \prod_{i=1}^s m_i(X_i) \quad (5.19)$$

This class of rules of combination is a particular case of the rule given in [6].

5.4.2 Example

We illustrate here the previous general formulas on a simple example corresponding to the hybrid model given in the figure 5.1. $\Theta = \{A, B, C, D\}$, with $A \cap B \neq \emptyset$ and all other intersections are empty.

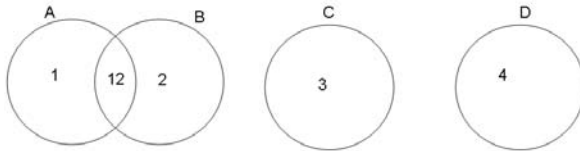

Figure 5.1: Hybrid model.

Let's consider two sources of evidence with their masses of belief $m_1(\cdot)$ and $m_2(\cdot)$ given in the following table:

	m_1	m_2	m_\cap
A	0.2	0.4	0.18
B	0.3	0.2	0.13
C	0.1	0.2	0.07
D	0.2	0.1	0.06
$A \cup B \cup C \cup D$	0.2	0.1	0.02
$A \cap B \neq \emptyset$			0.16
$A \cap C = \emptyset$			0.08
$A \cap D = \emptyset$			0.10
$B \cap C = \emptyset$			0.08
$B \cap D = \emptyset$			0.07
$C \cap D = \emptyset$			0.05

Let's apply the general formula (5.16)-(5.17) with different choices of the function $f(\cdot)$ and $T(X, Y)$:

- **RSC2 rule:** we take $f(A) = m_\cap(A)$, $T(X, Y) = 2^{c(X \cup Y)}$, $T(X, Y) = \emptyset$. $m_\cap(A \cap C) = 0.08$ is transferred to all subsets of $c(A \cup C)$ proportionally with respect to their masses, but D is a subset whose mass is not zero; so the whole conflicting mass 0.08 is transferred to D . Similarly:

- $m_\cap(A \cap D) = 0.10$ is transferred to C only,
- $m_\cap(B \cap C) = 0.08$ is transferred to D only,
- $m_\cap(B \cap D) = 0.07$ is transferred to C only,

But $m_\cap(C \cap D) = 0.05$ is transferred to A and B which are subsets of non-zero mass of $c(C \cup D)$ proportionally with respect to their corresponding masses 0.18 and 0.13 respectively. We obtain:

	A	B	C	D	$A \cup B \cup C \cup D$	$A \cap B \neq \emptyset$
m_{RSC2}	0.21	0.15	0.24	0.22	0.02	0.16

- **RSC3 rule:** we take $f(A) = |A|$, $T(X, Y) = 2^{c(X \cup Y)}$, $T(X, Y) = \emptyset$. $m_\cap(A \cap C) = 0.08$ is transferred to the parts 2, 4 and $2 \cup 4$ proportionally with respect to their cardinals: 1, 1, 2 respectively. Hence the parts 2 and 4 receive 0.02 and $2 \cup 4$ 0.04. Similarly

- $m_\cap(A \cap D) = 0.10$ is transferred to 2, 3 and $2 \cup 3$ with respectively 0.025, 0.025 and 0.05.
- $m_\cap(B \cap C) = 0.08$ is transferred to 1, 4 and $1 \cup 4$ with respectively 0.02, 0.02 and 0.04.
- $m_\cap(B \cap D) = 0.07$ is transferred to 1, 3 and $1 \cup 3$ with respectively 0.0175, 0.0175 and 0.035.
- $m_\cap(C \cap D) = 0.05$ is transferred to 1, 2, 12, $1 \cup 2$, $1 \cup 12$, $2 \cup 12$, $1 \cup 2 \cup 12$ with respectively 0.004166, 0.004166, 0.004166, 0.008333, 0.008333, 0.008333, 0.012503.

- **RSC4 rule:** we take $f(A) = m_{\cap}(A) + |A|$, $T(X, Y) = 2^{c(X \cup Y)}$ and $T(X, Y) = \emptyset$.
- **RSC5 rule:** we take $f(A) = |A|$, $T(X, Y) = \{X, Y\}$ and $T(X, Y) = \emptyset$.
- **RSC6 rule:** we take $f(A) = |A|$, $T(X, Y) = 2^{X \cup Y}$ and $T(X, Y) = \emptyset$.
- **RSC7 rule:** we take $f(A) = m_{\cap}(A) + |A|$, $T(X, Y) = \{X, Y\}$ and $T(X, Y) = \emptyset$.
- **RSC8 rule:** we take $f(A) = m_{\cap}(A) + |A|$, $T(X, Y) = 2^{X \cup Y}$ and $T(X, Y) = \emptyset$.

5.5 A general formulation including reliability

A general fusion formulation including explicitly the reliabilities of the sources of evidence is given by the following formula: for all $A \in S^{\Theta}$, one has

$$m(X) = \sum_{\mathbf{Y} \in (S^{\Theta})^s} \prod_{j=1}^s m_j(Y_j) w(X, \mathbf{m}(\mathbf{Y}), T(\mathbf{Y}), \alpha), \quad (5.20)$$

where $\mathbf{Y} = (Y_1, \dots, Y_s)$ are the responses of the s experts and $m_j(Y_j)$ their associated mass of belief; α is a matrix of terms α_{ij} of the reliability of the expert j for the element i of S^{Θ} , and $\mathbf{Y}, T(\mathbf{Y})$ is the set of subsets of S^{Θ} on which we can transfer the masses $m_j(Y_j)$ for the given \mathbf{Y} vector. In this general formulation, the argument \mathbf{Y} of the transfer function $T(\cdot)$ is a vector of dimension s , whereas we did use the notation $T(X, Y)$ in the two sources case in eq. (5.17).

5.5.1 Examples

We show how to retrieve the principal rules of combinations from the previous general formula (5.20):

- **Conjunctive rule:** It is obtained from (5.20) by taking

$$w(X, \mathbf{m}(\mathbf{Y}), T(\mathbf{Y}), \alpha) = 1 \quad \text{if} \quad \cap_{j=1}^s Y_j = X \quad (5.21)$$

$T(\mathbf{Y}) = \cap_{j=1}^s Y_j$ and we do not consider α .

- **Disjunctive rule** in [4]: It is obtained from (5.20) by taking

$$w(X, \mathbf{m}(\mathbf{Y}), T(\mathbf{Y}), \alpha) = 1 \quad \text{if} \quad \cup_{j=1}^s Y_j = X \quad (5.22)$$

$T(\mathbf{Y}) = \cup_{j=1}^s Y_j$ and we do not consider α .

- **Dubois & Prade rule** in [5]: It is obtained from (5.20) by taking

$$w(X, \mathbf{m}(\mathbf{Y}), T(\mathbf{Y}), \alpha) = \begin{cases} 1 & \text{if } \cap_{j=1}^s Y_j = X \text{ and } X \neq \emptyset \\ 1 & \text{if } \cup_{j=1}^s Y_j = X \text{ and } X = \emptyset \end{cases} \quad (5.23)$$

$T(\mathbf{Y}) = \{\cap_{j=1}^s Y_j, \cup_{j=1}^s Y_j\} \setminus \emptyset$ and we do not consider α .

- **PCR5 rule** introduced in [13], from the equation given in [7]: It is obtained from (5.20) by taking

- $w(X, \mathbf{m}(\mathbf{Y}), T(\mathbf{Y}), \alpha) = 1$ whenever $\cap_{j=1}^s Y_j = X$, and $X \neq \emptyset$.
- and whenever $Y_i = X, i = 1, \dots, s$, and $\cap_{j=1}^s Y_j = \emptyset$,

$$w(X, \mathbf{m}(\mathbf{Y}), T(\mathbf{Y}), \alpha) = \frac{\sum_{i=1}^M m_i(X)}{\prod_{j=1}^s m_j(Y_j)} \times \frac{\left(\prod_{j=1}^{M-1} m_{\sigma_i(j)}(Y_{\sigma_i(j)}) \mathbb{1}_{j>i} \right) \prod_{Y_{\sigma_i(j)}=X} m_{\sigma_i(j)}(Y_{\sigma_i(j)})}{\sum_{Z \in \{X, Y_{\sigma_i(1)}, \dots, Y_{\sigma_i(M-1)}\}} \prod_{Y_{\sigma_i(j)}=Z} (m_{\sigma_i(j)}(Y_{\sigma_i(j)}) \cdot \xi(X=Z, m_i(X)))} \quad (5.24)$$

where:

$$\begin{cases} \sigma_i(j) = j, & \text{if } j < i, \\ \sigma_i(j) = j + 1, & \text{if } j \geq i, \end{cases} \quad (5.25)$$

$$\begin{cases} \xi(B, x) = x & \text{if } B \text{ is true,} \\ \xi(B, x) = 1 & \text{if } B \text{ is false.} \end{cases} \quad (5.26)$$

and $T(\mathbf{Y}) = \{\cap_{j=1}^s Y_j, Y_1, \dots, Y_s\} \setminus \emptyset$ and we do not consider α .

- **PCR6 rule** in [7]: It is obtained from (5.20) by taking

- $w(X, \mathbf{m}(\mathbf{Y}), T(\mathbf{Y}), \alpha) = 1$ whenever $\cap_{j=1}^s Y_j = X$, and $X \neq \emptyset$,
- and whenever $Y_i = X, i = 1, \dots, s$, and $\cap_{j=1}^s Y_j = \emptyset$,

$$w(X, \mathbf{m}(\mathbf{Y}), T(\mathbf{Y}), \alpha) = \frac{\sum_{i=1}^M m_i(X)}{m_i(X) + \sum_{j=1}^{M-1} m_{\sigma_i(j)}(Y_{\sigma_i(j)})} \quad (5.27)$$

where:

$$\begin{cases} \sigma_i(j) = j, & \text{if } j < i, \\ \sigma_i(j) = j + 1, & \text{if } j \geq i, \end{cases} \quad (5.28)$$

$T(\mathbf{Y}) = \{\cap_{j=1}^s Y_j, Y_1, \dots, Y_s\} \setminus \emptyset$ and we do not consider α .

- **RSC1 rule:** It is obtained from (5.20) by taking

$$w(X, \mathbf{m}(\mathbf{Y}), T(\mathbf{Y}), \alpha) = \begin{cases} 1 & \text{if } \cap_{j=1}^s Y_j = X \text{ and } X \neq \emptyset \\ 1, & \text{if } c(\cap_{j=1}^s Y_j) = X \text{ and } \cup_{j=1}^s Y_j = \emptyset \end{cases} \quad (5.29)$$

$T(\mathbf{Y}) = \{\cap_{j=1}^s Y_j, c(\cup_{j=1}^s Y_j)\} \setminus \emptyset$ and we do not consider α .

- **RSC2 rule:** It is obtained from (5.20) by taking

a) $w(X, \mathbf{m}(\mathbf{Y}), T(\mathbf{Y}), \alpha) = 1$ whenever $\cap_{j=1}^s Y_j = X$, and $X \neq \emptyset$.

b)

$$w(X, \mathbf{m}(\mathbf{Y}), T(\mathbf{Y}), \alpha) = \frac{m_{\cap}(X)}{\sum_{Z \subseteq c(\cup_{j=1}^s Y_j)} m_{\cap}(Z)} \quad (5.30)$$

whenever $X \in 2^{c(\cup_{j=1}^s Y_j)}$, $\cap_{j=1}^s Y_j = \emptyset$, $c(\cup_{j=1}^s Y_j) \neq \emptyset$ and

$$\sum_{Z \subseteq c(\cup_{j=1}^s Y_j)} m_{\cap}(Z) \neq 0.$$

c) $w(X, \mathbf{m}(\mathbf{Y}), T(\mathbf{Y}), \alpha) = 1$ whenever $X = \Theta$, $\cap_{j=1}^s Y_j = \emptyset$, and

$$\{c(\cup_{j=1}^s Y_j) = \emptyset \text{ or } \sum_{Z \subseteq c(\cup_{j=1}^s Y_j)} m_{\cap}(Z) = 0\}.$$

$T(\mathbf{Y}) = \{\cap_{j=1}^s Y_j, \{2^{c(\cup_{j=1}^s Y_j)}\}, \Theta\} \setminus \emptyset$ and we do not consider α .

- **RSC3 rule:** It is obtained from (5.20) by taking

a) $w(X, \mathbf{m}(\mathbf{Y}), T(\mathbf{Y}), \alpha) = 1$ whenever $\cap_{j=1}^s Y_j = X$ and $X \neq \emptyset$.

b)

$$w(X, \mathbf{m}(\mathbf{Y}), T(\mathbf{Y}), \alpha) = \frac{|X|}{\sum_{Z(\cup_{j=1}^s Y_j)} |Z|} \quad (5.31)$$

if $X \in 2^{c(\cup_{j=1}^s Y_j)}$, $m_{\cap}(X) \neq 0$, $c(\cup_{j=1}^s Y_j) \neq \emptyset$ and $\cap_{j=1}^s Y_j = \emptyset$.

c) $w(X, \mathbf{m}(\mathbf{Y}), T(\mathbf{Y}), \alpha) = 1$ if $X = \Theta$, $c(\cup_{j=1}^s Y_j) = \emptyset$ and $\cap_{j=1}^s Y_j = \emptyset$.

$T(\mathbf{Y}) = \{\cap_{j=1}^s Y_j, \{2^{c(\cup_{j=1}^s Y_j)}\}, \Theta\} \setminus \emptyset$ and we do not consider α .

Remark: $\sum_{Z(\cup_{j=1}^s Y_j)} |Z| \neq 0$ because $c(\cup_{j=1}^s Y_j) \neq \emptyset$.

- **RSC4 rule:** It is obtained from (5.20) by taking

a) $w(X, \mathbf{m}(\mathbf{Y}), T(\mathbf{Y}), \alpha) = 1$ whenever $\cap_{j=1}^s Y_j = X$ and $X \neq \emptyset$.

b)

$$w(X, \mathbf{m}(\mathbf{Y}), T(\mathbf{Y}), \alpha) = \frac{m_{\cap}(X) + |X|}{\sum_{Z \subseteq c(\cup_{j=1}^s Y_j)} m_{\cap}(Z) + |Z|} \quad (5.32)$$

if $X \in 2^{c(\cup_{j=1}^s Y_j)}$, $\cap_{j=1}^s Y_j = \emptyset$ and $c(\cup_{j=1}^s Y_j) \neq \emptyset$.

c) $w(X, \mathbf{m}(\mathbf{Y}), T(\mathbf{Y}), \alpha) = 1$ if $X = \Theta$, $\cap_{j=1}^s Y_j = \emptyset$ and $c(\cup_{j=1}^s Y_j) = \emptyset$.

$T(\mathbf{Y}) = \{\cap_{j=1}^s Y_j, \{2^{c(\cup_{j=1}^s Y_j)}\}, \Theta\} \setminus \emptyset$ and we do not consider α .

• **RSC5 rule:** It is obtained from (5.20) by taking

a) $w(X, \mathbf{m}(\mathbf{Y}), T(\mathbf{Y}), \alpha) = 1$ whenever $\cap_{j=1}^s Y_j = X$ and $X \neq \emptyset$.

b)

$$w(X, \mathbf{m}(\mathbf{Y}), T(\mathbf{Y}), \alpha) = \frac{|X|}{\sum_{j=1}^s |Y_j|} \quad (5.33)$$

if $Y_i = X, i = 1, \dots, s$, and $\cap_{j=1}^s Y_j = \emptyset$.

$T(\mathbf{Y}) = \{\cap_{j=1}^s Y_j, Y_1, \dots, Y_s\} \setminus \emptyset$ and we do not consider α .

• **RSC6 rule:** It is obtained from (5.20) by taking

a) $w(X, \mathbf{m}(\mathbf{Y}), T(\mathbf{Y}), \alpha) = 1$ whenever $\cap_{j=1}^s Y_j = X$ and $X \neq \emptyset$.

b)

$$w(X, \mathbf{m}(\mathbf{Y}), T(\mathbf{Y}), \alpha) = \frac{|X|}{\sum_{Z \subseteq \cup_{j=1}^s Y_j} |Z|} \quad (5.34)$$

if $X \in 2^{\cup_{j=1}^s Y_j}$, and $\cap_{j=1}^s Y_j = \emptyset$.

$T(\mathbf{Y}) = \{\cap_{j=1}^s Y_j, \{2^{\cup_{j=1}^s Y_j}\}\} \setminus \emptyset$ and we do not consider α .

• **RSC7 rule:** It is obtained from (5.20) by taking

a) $w(X, \mathbf{m}(\mathbf{Y}), T(\mathbf{Y}), \alpha) = 1$ whenever $\cap_{j=1}^s Y_j = X$ and $X \neq \emptyset$.

b)

$$w(X, \mathbf{m}(\mathbf{Y}), T(\mathbf{Y}), \alpha) = \frac{m_{\cap}(X) + |X|}{\sum_{j=1}^s m_{\cap}(Y_j) + |Y_j|} \quad (5.35)$$

if $Y_i = X, i = 1, \dots, s$, and $\cap_{j=1}^s Y_j = \emptyset$.

$T(\mathbf{Y}) = \{\cap_{j=1}^s Y_j, Y_1, \dots, Y_s\} \setminus \emptyset$ and we do not consider α .

- **RSC8 rule:** It is obtained from (5.20) by taking

a) $w(X, \mathbf{m}(\mathbf{Y}), T(\mathbf{Y}), \alpha) = 1$ whenever $\cap_{j=1}^s Y_j = X$ and $X \neq \emptyset$.

b)

$$w(X, \mathbf{m}(\mathbf{Y}), T(\mathbf{Y}), \alpha) = \frac{m_{\cap}(X) + |X|}{\sum_{Z \subseteq \cup_{j=1}^s Y_j} m_{\cap}(Z) + |Z|} \quad (5.36)$$

if $X \in 2^{\cup_{j=1}^s Y_j}$, $\cap_{j=1}^s Y_j = \emptyset$, and $\cup_{j=1}^s Y_j \neq \emptyset$.

c) $w(X, \mathbf{m}(\mathbf{Y}), T(\mathbf{Y}), \alpha) = 1$ if $X = \Theta$, $\cup_{j=1}^s Y_j = \emptyset$.

$T(\mathbf{Y}) = \{\cap_{j=1}^s Y_j, \{2^{\cup_{j=1}^s Y_j}\}, \Theta\} \setminus \emptyset$ and we do not consider α .

5.6 A new rule including reliability

The idea we propose here consists in transferring the mass on $D^T \setminus \{\emptyset\}$, with $T = \{Y_1, \dots, Y_s, c(Y_1), \dots, c(Y_s)\}$, according with respect to their mass and reliability α_{ij} , $i = 1, \dots, s$ and $j = 1, \dots, |S^\Theta|$ an arbitrary order on S^Θ . Hence with the previous notations, $T(\mathbf{Y}) = D^T \setminus \{\emptyset\}$.

5.6.1 The fusion of two experts including their reliability

We first explain the idea for two experts given a basic belief assignment respectively on X and Y . Hence $T(X, Y) = D^{\{X, Y, c(X), c(Y)\}} \setminus \{\emptyset\}$. We note that $X \cup c(X) = Y \cup c(Y) = \Theta$ and $c(X) \cap c(Y) = c(X \cup Y)$ and if $X \cap Y = \emptyset$: $X \cap c(Y) = X$, $Y \cap c(X) = Y$ and $c(X) \cup c(Y) = \Theta$. Hence:

$$T(X, Y) = \{X, Y, X \cap Y, X \cup Y, c(X), c(X) \cap Y, c(X) \cup Y, c(Y), \\ c(Y) \cap X, c(Y) \cup X, c(X) \cup c(Y), c(X) \cap c(Y), \Theta\}$$

If $X \cap Y \neq \emptyset$, and if the reliability $\alpha_{1X} = \alpha_{1Y} = 1$, and if $m_1(X) = m_2(Y) = 1$ then all the belief must be given on $X \cap Y$. If the reliability $\alpha_{1X} = \alpha_{1Y} = 1$ but $m_1(X) \neq 1$ and $m_2(Y) \neq 1$, then the experts are not sure and a part of the mass $m_1(X).m_2(Y)$ can also be transferred on $X \cup Y$. If for example $\alpha_{1X} = 0$ then we should also transfer mass on $c(X)$. If $X \cap Y = \emptyset$, we have a partial conflict between the experts. If the experts are reliable then, we can transfer the mass on X , Y or $X \cup Y$, such as the *DPCR* proposed in [8]. If the experts are not sure then a part of the mass can also be transferred on the complement of X and Y .

Hence we propose the function w given in the Table 5.1 if $X \cap Y = \emptyset$, and in the Table 5.2 if $X \cap Y \neq \emptyset$. The given weights have to be normalized by a factor noted N .

When $X \cap Y = \emptyset$	
Element	Weight N
X	$\alpha_{1X}m_1(X)$
Y	$\alpha_{2Y}m_2(Y)$
$c(X)$	$(1 - \alpha_{1X})(1 - m_1(X))$
$c(Y)$	$(1 - \alpha_{2Y})(1 - m_2(Y))$
$X \cup Y$	$(1 - \alpha_{1X}\alpha_{2Y})(1 - m_1(X)m_2(Y))$
$c(X) \cap c(Y) \neq \emptyset$	$(1 - \alpha_{1X})(1 - \alpha_{2Y})(1 - m_1(X))(1 - m_2(Y))$
$c(X) \cup c(Y) = \Theta$	$(1 - (1 - \alpha_{1X})(1 - \alpha_{2Y}))(1 - (1 - m_1(X))(1 - m_2(Y)))$

Table 5.1: Weighting function w when $X \cap Y = \emptyset$.

When $X \cap Y \neq \emptyset$	
Element	weight N
$X \cap Y$	$\alpha_{1X}\alpha_{2Y}m_1(X)m_2(Y)$
$X \cup Y$	$(1 - \alpha_{1X}\alpha_{2Y})(1 - m_1(X)m_2(Y))$

Table 5.2: Weighting function w when $X \cap Y \neq \emptyset$.

In this form, if the expert 1, for example, is not reliable, we do not transfer on $c(X)$. So we propose the function w is given by the Table 5.3, still for $X \cap Y \neq \emptyset$. In this case, the rule will have a behavior nearer than the average than the conjunctive because the weights on X and Y are higher than the weight on $X \cap Y$. So, we can also propose the function w as in Table 5.4 in order to avoid that.

When $X \cap Y \neq \emptyset$	
Element	weight N
$X \cap Y$	$\alpha_{1X}\alpha_{2Y}m_1(X)m_2(Y)$
$X \cup Y$	$(1 - \alpha_{1X}\alpha_{2Y})(1 - m_1(X)m_2(Y))$
X	$\alpha_{1X}m_1(X)$
Y	$\alpha_{2Y}m_2(Y)$
$c(X) \neq \emptyset$	$(1 - \alpha_{1X})(1 - m_1(X))$
$c(Y) \neq \emptyset$	$(1 - \alpha_{2Y})(1 - m_2(Y))$
$c(X) \cap c(Y) \neq \emptyset$	$(1 - \alpha_{1X})(1 - \alpha_{2Y})(1 - m_1(X))(1 - m_2(Y))$
$c(X) \cup c(Y)$	$(1 - (1 - \alpha_{1X})(1 - \alpha_{2Y}))(1 - (1 - m_1(X))(1 - m_2(Y)))$
$X \cup c(Y)$	$(1 - \alpha_{1X}(1 - \alpha_{2Y}))(1 - m_1(X)(1 - m_2(Y)))$
$c(X) \cup Y$	$(1 - (1 - \alpha_{1X})\alpha_{2Y})(1 - (1 - m_1(X))m_2(Y))$
$X \cap c(Y) \neq \emptyset$	$\alpha_{1X}(1 - \alpha_{2Y})m_1(X)(1 - m_2(Y))$
$c(X) \cap Y \neq \emptyset$	$(1 - \alpha_{1X})\alpha_{2Y}(1 - m_1(X))m_2(Y)$

Table 5.3: Weighting function w when $X \cap Y \neq \emptyset$.

When $X \cap Y \neq \emptyset$	
Element	weight N
$X \cap Y$	$\alpha_{1X}\alpha_{2Y}m_1(X)m_2(Y)$
$X \cup Y$	$(1 - \alpha_{1X}\alpha_{2Y})(1 - m_1(X)m_2(Y))$
X	$(\alpha_{1X}m_1(X))^2$
Y	$(\alpha_{2Y}m_2(Y))^2$
$c(X) \neq \emptyset$	$((1 - \alpha_{1X})(1 - m_1(X)))^2$
$c(Y) \neq \emptyset$	$((1 - \alpha_{2Y})(1 - m_2(Y)))^2$
$c(X) \cap c(Y) \neq \emptyset$	$(1 - \alpha_{1X})(1 - \alpha_{2Y})(1 - m_1(X))(1 - m_2(Y))$
$c(X) \cup c(Y)$	$(1 - (1 - \alpha_{1X})(1 - \alpha_{2Y}))(1 - (1 - m_1(X))(1 - m_2(Y)))$
$X \cup c(Y)$	$(1 - \alpha_{1X}(1 - \alpha_{2Y}))(1 - m_1(X)(1 - m_2(Y)))$
$c(X) \cup Y$	$(1 - (1 - \alpha_{1X})\alpha_{2Y})(1 - (1 - m_1(X))m_2(Y))$
$X \cap c(Y) \neq \emptyset$	$\alpha_{1X}(1 - \alpha_{2Y})m_1(X)(1 - m_2(Y))$
$c(X) \cap Y \neq \emptyset$	$(1 - \alpha_{1X})\alpha_{2Y}(1 - m_1(X))m_2(Y)$

Table 5.4: Weighting function w when $X \cap Y \neq \emptyset$.

5.6.2 Some examples

- if $X \cap Y = \emptyset$ and $\alpha_{1X} = \alpha_{2Y} = 1$, then the only weights are $m_1(X)$ and $m_2(Y)$ respectively on X and Y .
- if $X \cap Y = \emptyset$ and $\alpha_{1X} = 1$ and $\alpha_{2Y} = 0$, then the only weights are $m_1(X)$, $(1 - m_2(Y))$, $m_1(X)(1 - m_2(Y))$ and $1 - m_1(X)m_2(Y)$ respectively on X , $c(Y)$, $X \cap c(Y)$ and $X \cup Y$.
- if $X \cap Y \neq \emptyset$ and $\alpha_{1X} = \alpha_{2Y} = 1$, then the only weights are $m_1(X)m_2(Y)$, $m_1(X)$ (or $m_1(X)^2$) and $m_2(Y)$ (or $m_2(Y)^2$) respectively on $X \cap Y$, X and Y .
- if $X \cap Y \neq \emptyset$ and $\alpha_{1X} = 1$ and $\alpha_{2Y} = 0$, then the only weights are $m_1(X)$, $(1 - m_2(Y))$, $m_1(X)(1 - m_2(Y))$ and $1 - m_1(X)m_2(Y)$ respectively on X , $c(Y)$, $X \cap c(Y)$ and $X \cup Y$.
- if $X \cap Y = \emptyset$ and $m_1(X)m_2(Y) = 1$, then the only weights are α_{1X} and α_{2Y} respectively on X and Y .
- if $X \cap Y \neq \emptyset$ and $m_1(X)m_2(Y) = 1$, then the only weights are $\alpha_{1X}\alpha_{2Y}$, α_{1X} and α_{2Y} respectively on $X \cap Y$, X and Y .

5.6.3 The fusion of $s \geq 2$ experts including their reliability

We note Y_1, \dots, Y_s the responses of the experts. The function w is then given by the Table 5.5 if $\cap_{j=1}^s Y_j = \emptyset$:

$\cap_{j=1}^s Y_j = \emptyset$	
Element	Weight N
Y_j	$\alpha_{jY_j} m_j(Y_j)$
$c(Y_j)$	$(1 - \alpha_{jY_j})(1 - m_j(Y_j))$
$\cup_{j_1=1}^{n_1} Y_{j_1} \cup \cup_{j_2=1}^{n_2} c(Y_{j_2})$ with $n_1 + n_2 = s$	$\left(1 - \prod_{j_1=1}^{n_1} \alpha_{j_1 Y_{j_1}} \prod_{j_2=1}^{n_2} (1 - \alpha_{j_2 Y_{j_2}}) \right)$ $\times \left(1 - \prod_{j_1=1}^{n_1} m_{j_1}(Y_{j_1}) \prod_{j_2=1}^{n_2} (1 - m_{j_2}(Y_{j_2})) \right)$
$\cup_{j=1}^s Y_j$	$(1 - \prod_{j=1}^s \alpha_{jY_j})(1 - \prod_{j=1}^s m_j(Y_j))$
$\cap_{j_1=1}^{n_1} Y_{j_1} \cap \cap_{j_2=1}^{n_2} c(Y_{j_2})$ if $\neq \emptyset$, with $n_1 + n_2 = s$	$\prod_{j_1=1}^{n_1} \alpha_{j_1 Y_{j_1}} m_{j_1}(Y_{j_1})$ $\times \prod_{j_2=1}^{n_2} (1 - \alpha_{j_2 Y_{j_2}})(1 - m_{j_2}(Y_{j_2}))$
$\cap_{j=1}^s c(Y_j)$ if $\neq \emptyset$	$\prod_{j=1}^s (1 - \alpha_{jY_j})(1 - m_j(Y_j))$
$\cup_{j=1}^s c(Y_j)$	$\left(1 - \prod_{j=1}^s (1 - \alpha_{jY_j}) \right)$ $\times \left(1 - \prod_{j=1}^s (1 - m_j(Y_j)) \right)$

Table 5.5: Weighting function w when $\cap_{j=1}^s Y_j = \emptyset$.

The function w given in Table 5.6 if $\cap_{j=1}^s Y_j \neq \emptyset$:

$\cap_{j=1}^s Y_j \neq \emptyset$	
Element	weight N
$\cap_{j=1}^s Y_j$	$\prod_{j=1}^s \alpha_{jY_j} m_j(Y_j)$
$\cup_{j=1}^s Y_j$	$(1 - \prod_{j=1}^s \alpha_{jY_j})(1 - \prod_{j=1}^s m_j(Y_j))$
Y_j	$\alpha_{jY_j} m_j(Y_j)$
$c(Y_j)$ if $\neq \emptyset$	$(1 - \alpha_{jY_j})(1 - m_j(Y_j))$
$\cup_{j_1=1}^{n_1} Y_{j_1} \cup \cup_{j_2=1}^{n_2} c(Y_{j_2})$ if $\neq \emptyset$, with $n_1 + n_2 = s$	$\left(1 - \prod_{j_1=1}^{n_1} \alpha_{j_1 Y_{j_1}} \prod_{j_2=1}^{n_2} (1 - \alpha_{j_2 Y_{j_2}})\right) \times \left(1 - \prod_{j_1=1}^{n_1} m_{j_1}(Y_{j_1}) \prod_{j_2=1}^{n_2} (1 - m_{j_2}(Y_{j_2}))\right)$
$\cap_{j_1=1}^{n_1} Y_{j_1} \cap \cap_{j_2=1}^{n_2} c(Y_{j_2})$ if $\neq \emptyset$, with $n_1 + n_2 = s$	$\prod_{j_1=1}^{n_1} \alpha_{j_1 Y_{j_1}} m_{j_1}(Y_{j_1}) \times \prod_{j_2=1}^{n_2} (1 - \alpha_{j_2 Y_{j_2}})(1 - m_{j_2}(Y_{j_2}))$
$\cap_{j=1}^s c(Y_j)$ if $\neq \emptyset$	$\prod_{j=1}^s (1 - \alpha_{jY_j})(1 - m_j(Y_j))$
$\cup_{j=1}^s c(Y_j)$	$\left(1 - \prod_{j=1}^s (1 - \alpha_{jY_j})\right) \times \left(1 - \prod_{j=1}^s (1 - m_j(Y_j))\right)$

Table 5.6: Weighting function w when $\cap_{j=1}^s Y_j \neq \emptyset$.

Note that with extension $T(\mathbf{Y}) \neq D^{\{\mathbf{Y}, c(\mathbf{Y})\}} \setminus \{\emptyset\}$, but $T(\mathbf{Y}) \subset D^{\{\mathbf{Y}, c(\mathbf{Y})\}} \setminus \{\emptyset\}$.

5.7 Conclusions

We have constructed a Redistribution to Subsets or Complements (RSC) class of fusion rules and we gave eight particular examples. All RSC rules work on the fusion spaces S^\ominus and 2^\ominus . But the RSC rules involving complements do not work on the hyper-power set D^\ominus .

In order to choose what particular RSC rule to apply we need to take into consideration the user's feasibility, confidence/non-confidence in some hypotheses, more or less prudence of the user, optimistic/pessimistic redistribution, etc. In general, if $X \cap Y = \emptyset$, the mass of $X \cap Y$ is transferred either to $c(X \cap Y)$, or to subsets of $c(X \cap Y)$, or to X and Y , or to subsets of $X \cup Y$ proportionally with respect to the masses, or cardinals, or both masses and cardinals, or other parameters of the elements that receive redistributed masses. We can even transfer the mass of $X \cap Y$ when $X \cap Y \neq \emptyset$ in the same way as aforementioned; the transfer of $m(X \cap Y)$ when $X \cap Y \neq \emptyset$ is done or not depending on the confidence/non-confidence of the user in the set $X \cap Y$. A more general theoretical extension of these RSC rules is presented at the end of this chapter. Those can generate new classes of fusion rules.

5.8 References

- [1] M. Daniel, *Comparison between DSm and MinC combination rules*, Chap. 10, pp. 223-241, in [10].
- [2] M. Daniel, *Classical Combination Rules Generalized to DSm Hyper-power Sets and their Comparison with the Hybrid DSm Rule*, Chap. 3, pp. 89-112, in [13].
- [3] J. Dezert, A. Martin, F. Smarandache, *Comments on "A new combination of evidence based on compromise" by K. Yamada*, Fuzzy Sets and Systems, Vol. 160, Issue 6, pp. 853-855, March 2009.
- [4] D. Dubois, H. Prade, *A set-theoretic view of belief functions - Logical operations and approximation by fuzzy sets*, International journal of General Systems, Vol. 12, No. 3, pp. 193-226, 1986.
- [5] D. Dubois, H. Prade, *Representation and combination of uncertainty with belief functions and possibility measures*, Computational Intelligence, Vol. 4, pp. 244-264, 1988.
- [6] E. Lefevre, O. Colot, P. Vannoorenberghe, *Belief functions combination and conflict management*, Information Fusion Journal, Elsevier Publisher, Vol. 3, No. 2, pp. 149-162, 2002.
- [7] A. Martin, C. Osswald, *A new generalization of the proportional conflict redistribution rule stable in terms of decision*, Chap. 2, pp. 69-88, in [13].
- [8] A. Martin and C. Osswald, *Toward a combination rule to deal with partial conflict and specificity in belief functions theory*, International Conference on Information Fusion, Québec, Canada, 9-12 July 2007.

- [9] A. Martin, C. Osswald, J. Dezert, F. Smarandache, *General combination rules for qualitative and quantitative beliefs*, to appear in Journal of Advances in Information Fusion, 2009.
- [10] F. Smarandache, J. Dezert (Editors), *Applications and Advances of DSmT for Information Fusion*, Vol. 1, American Research Press, Rehoboth, August 2004. <http://www.gallup.unm.edu/~smarandache/DSmT-book1.pdf>.
- [11] F. Smarandache, J. Dezert, *Combination of beliefs on hybrid DSm models*, Chap. 4, pp. 61-103, in [10].
- [12] F. Smarandache, J. Dezert, *Information Fusion Based on New Proportional Conflict Redistribution Rules*, International Conference on Information Fusion, Philadelphia, U.S.A., July 2005.
- [13] F. Smarandache, J. Dezert (Editors), *Applications and Advances of DSmT for Information Fusion*, Vol. 2, American Research Press, Rehoboth, August 2006. <http://www.gallup.unm.edu/~smarandache/DSmT-book2.pdf>.
- [14] F. Smarandache, J. Dezert, *Proportional Conflict Redistribution Rules for Information Fusion*, Chap. 1, pp. 3-68, in [13].
- [15] K. Yamada, *On new combination of evidence by compromise*, In proc. of Joint 3rd International Conference on Soft Computing and Intelligent Systems and 7th International Symposium on advanced Intelligent Systems, Tokyo, Japan, 20-24 september, 2006.
- [16] K. Yamada, *A new combination of evidence based on compromise*, Fuzzy Sets and Systems, Vol. 159, No. 13, pp. 1689–1708, July 2008.

Chapter 6

Definition of evidence fusion rules based on referee functions

Frédéric Dambreville
Délégation Générale pour l'Armement,
DGA/CEP/EORD/FAS,
16 bis, Avenue Prieur de la Côte d'Or
Arcueil, F 94114, France
<http://email.fredericdambreville.com>

Abstract: *This chapter defines a new concept and framework for constructing fusion rules for evidences. This framework is based on a referee function, which does a decisional arbitrament conditionally to basic decisions provided by the several sources of information. A simple sampling method is derived from this framework. The purpose of this sampling approach is to avoid the combinatorics which are inherent to the definition of fusion rules of evidences. This definition of the fusion rule by the means of a sampling process makes possible the construction of several rules on the basis of an algorithmic implementation of the referee function, instead of a mathematical formulation. Incidentally, it is a versatile and intuitive way for defining rules. The framework is implemented for various well known evidence rules. On the basis of this framework, new rules for combining evidences are proposed, which takes into account a consensual evaluation of the sources of information.*

Notations

- $I[b]$, function of Boolean b , is defined by $I[\mathbf{true}] = 1$ and $I[\mathbf{false}] = 0$. Typically, $I[x = y]$ has value 1 when $x = y$, and 0 when $x \neq y$,
- Let be given a frame of discernment Θ . Then, the structure G^Θ denotes any lattice constructed from Θ . In particular, G^Θ may be a distributive lattice like the hyper-power set D^Θ ; or G^Θ may be a Boolean algebra like the power set 2^Θ , the super-power set S^Θ , or the free Boolean algebra generated by Θ ,
- $x_{1:n}$ is an abbreviation for the sequence x_1, \dots, x_n ,
- $\max\{x_1, \dots, x_n\}$, or $\max\{x_{1:n}\}$, is the maximal value of the sequence $x_{1:n}$. Similar notations are used for \min ,
- $\max_{x \in X}\{f(x)\}$, or $\max\{f(x) / x \in X\}$, is the maximal value of $f(x)$ when $x \in X$. Similar notations are used for \min

6.1 Introduction

Evidence theory [3, 13] has often been promoted as an alternative approach for fusing information, when the hypotheses for a Bayesian approach cannot be precisely stated. While many academic studies have been accomplished, most industrial applications of data fusion still remain based on a probabilistic modeling and fusion of the information. This great success of the Bayesian approach is explained by at least three reasons:

- The underlying logic of the Bayesian inference [1] seems intuitive and obvious at a first glance. It is known however [9] that the logic behinds the Bayesian inference is much more complex,
- The Bayesian rule is entirely compatible with the preeminent theory of Probability and takes advantage of all the probabilistic background,
- Probabilistic computations are tractable, even for reasonably complex problems.

Then, even if evidences allow a more general and subtle manipulation of the information for some case of use, the Bayesian approach still remains the method of choice for most applications. This chapter intends to address the three afore mentioned points, by providing a random set interpretation of the fusion rules. This interpretation is based on a *referee function*, which does a decisional arbitrament conditionally to basic decisions provided by the several sources of information. This referee function will imply a sampling approach for the definition of the rules. Sampling approach is instrumental for the combinatorics avoidance [12].

In the recent literature, there has been a large amount of work devoted to the definition of new fusion rules [4–6, 8, 10, 11, 14, 15, 17, 18]. The choice for a rule is often dependent of the applications and there is not a systematic approach for this task. The definition of the fusion rule by the means of a sampling process makes possible

the construction of several rules on the basis of an algorithmic implementation of the referee function, instead of a mathematical formulation. Incidentally, it is a versatile and intuitive way for defining rules. Subsequently, our approach is illustrated by implementing two well known evidence rules. On the basis of this framework, new rules for combining evidences are also proposed. Typically, these new rules takes into account a consensual evaluation of the sources, by invalidating irrelevant sources of information on the basis of a majority decision.

Section 6.2 summarize some classical results in the domain of evidence. Section 6.3 introduces the notion of referee function and its application to the definition of fusion rules. A sampling method is obtained as a corollary. Section 6.4 establishes the referee functions for two known rules. Section 6.5 defines new fusion rules. Section 6.6 makes some numerical comparisons. Section 6.7 concludes.

6.2 Belief fusion

This section introduces the notion of belief function and some classical rules of fusion.

6.2.1 Lattices

Lattices are algebraic structures which are useful for encoding logical information. In particular, lattices are generalizations of structures like Boolean algebra, sets, hyper-power sets or *concept lattice* [2, 7]. Sets and hyper-power sets are widely used as a framework for defining and manipulating belief functions. Concept lattices are frameworks used in the ontologic domain of *formal concept analysis*.

Definition 1. A (finite) *lattice* L is a partially ordered (finite) set, *i.e.* (finite) poset, which satisfies the following properties:

- For any two elements $X, Y \in L$, there is a greatest lower bound $X \wedge Y$ of the set $\{X, Y\}$,
- For any two elements $X, Y \in L$, there is a least upper bound $X \vee Y$ of the set $\{X, Y\}$.

The notations $X \cap Y$ (respectively $X \cup Y$) are also used instead of $X \wedge Y$ (respectively $X \vee Y$).

Example. Concept lattices [7] (which are not defined here) are lattices. Concept lattices are widely used for deriving ontologies.

Definition 2. A *bounded lattice* L is a lattice which have a least element \perp and a greatest element \top .

The notations \emptyset or 0 (respectively Ω or 1) are also used instead of \perp (respectively \top).

Proposition. A finite lattice is a bounded lattice.

Proof is achieved by setting: $\perp = \bigwedge_{X \in L} X$ and $\top = \bigvee_{X \in L} X$.

Definition 3. A *distributive lattice* L is a lattice such that \wedge and \vee are mutually distributive:

$$X \wedge (Y \vee Z) = (X \wedge Y) \vee (X \wedge Z) \quad \text{and} \quad X \vee (Y \wedge Z) = (X \vee Y) \wedge (X \vee Z),$$

for any $X, Y, Z \in L$.

Example. Being given a frame of discernment Θ , the hyper-power set D^Θ is typically the free distributive lattice generated by Θ .

Definition 4. A *complemented lattice* is a bounded lattice L , such that each element $X \in L$ has a *complement*, *i.e.* an element $Y \in L$ verifying:

$$X \vee Y = \top \quad \text{and} \quad X \wedge Y = \perp.$$

The complement of X is often denoted $\neg X$ or X^c .

Actually, the complementation is defined by introducing constraints on the lattice. As a consequence, *it is possible to have partial complementation on the lattice.*

Definition 5. A Boolean algebra is a complemented distributive lattice.

Examples. Being given a frame of discernment Θ , the power set 2^Θ , the *super-power set* S^Θ , or the free Boolean algebra generated by Θ , are Boolean algebras.

Conclusion. Bounded lattices (especially, finite lattices) are versatile structures, which are able to address many kind of informational frameworks. Typically, bounded lattices generalize power set and hyper-power set. But since complementation is defined by introducing constraints on the lattice, it is also possible to derive lattice with partial complementation (*i.e.* with a subset of the complementation constraints) which are intermediate structure between hyper-power set and power set. Since bounded lattices are such generalization, this chapter will define evidence fusion rules within this framework. By using a lattice framework, we are also linking our work to the domain of *formal concept analysis*.

In the domain of evidence theories, basic concepts are generally modeled by means of a set of proposition, Θ , called *frame of discernment*. The structure G^Θ is any finite lattice constructed from Θ . In particular, G^Θ may be D^Θ , 2^Θ or S^Θ . Notice that G^Θ is not a lost of generality, and is able to address any finite lattice. From now on, all notions and results are defined within G^Θ , which make them applicable also to any finite lattice.

6.2.2 Belief functions

Belief functions are measures of the uncertainty that could be defined on the propositions of a bounded lattice. In the framework of evidence theory, beliefs are defined so as to manage not only the uncertainty, but also the imprecision encoded within the lattice structure.

Basic belief assignment. A basic belief assignment (bba) on G^Θ is a mapping $m : G^\Theta \rightarrow \mathbb{R}$ such that:

- $m \geq 0$,
- $m(\emptyset) = 0$,
- $\sum_{X \in G^\Theta} m(X) = 1$.

The bba contains an elementary knowledge (in the form of a basic belief) about the whole propositions of G^Θ . The bba, however, does not provide directly the knowledge about an individual proposition. This individual knowledge is imprecise and bounded by the *belief* and the *plausibility*.

Belief. The belief *bel* is constructed from the bba m as follows:

$$bel(X) = \sum_{\substack{Y \in G^\Theta \\ Y \subset X}} m(Y) .$$

The belief is a pessimistic interpretation of the bba.

Plausibility. The plausibility *pl* is constructed from the bba m as follows:

$$pl(X) = \sum_{\substack{Y \in G^\Theta \\ Y \cap X \neq \emptyset}} m(Y) .$$

The plausibility is an optimistic interpretation of the bba.

While fusing beliefs, the essential computations are done by means of the bba's. Our contribution is focused on the bba fusion; belief and plausibility will not be manipulated in this chapter. Notice however that some properties of the belief functions may change, depending on the structure of the lattice being used.

6.2.3 Fusion rules

Let be given s sources of information characterized by their bba's $m_{1:s}$. How could we fuse these information into a single fused bba? There is a variety of rules for fusing bba's. This section covers different classical rules.

Dempster-Shafer. The fused bba m_{DST} obtained from $m_{1:s}$ by means of *Dempster-Shafer* fusion rule [3, 13] is defined by:

$$m_{\text{DST}}(\emptyset) = 0 \text{ and } m_{\text{DST}}(X) = \frac{m_{\wedge}(X)}{1 - m_{\wedge}(\emptyset)} \text{ for any } X \in G^{\Theta} \setminus \{\emptyset\}. \quad (6.1)$$

where $m_{\wedge}(\cdot)$ corresponds to the conjunctive consensus :

$$m_{\wedge}(X) \triangleq \sum_{\substack{Y_1 \cap \dots \cap Y_s = X \\ Y_1, \dots, Y_s \in G^{\Theta}}} \prod_{i=1}^s m_i(Y_i), \quad (6.2)$$

for any $X \in G^{\Theta} \setminus \{\emptyset\}$.

The rejection rate $z = m_{\wedge}(\emptyset)$ is a measure of the conflict between the sources. Notice that the conflict is essentially a conjunctive notion, here.

Historically, this is the first rule for fusing evidences. Essentially, this rule provides a cross fusion of the information: it is based on a conjunctive kernel. However, the conjunctive nature of this rule is altered by the necessary normalization implied by the conflict measurement $m_{\wedge}(\emptyset)$.

6.2.4 Disjunctive rule

The fused bba m_{\vee} obtained from $m_{1:s}$ by means of a *disjunctive* fusion is defined by:

$$m_{\vee}(X) = \sum_{\substack{Y_1 \cup \dots \cup Y_s = X \\ Y_1, \dots, Y_s \in G^{\Theta}}} \prod_{i=1}^s m_i(Y_i), \quad (6.3)$$

for any $X \in G^{\Theta}$.

The disjunctive rule alone is not very useful, but it is interesting when fusing highly conflicting information. When at least one sensor provides the good answer, the disjunctive rule will maintain a minimal knowledge. Typically, this rule may be combined with the conjunctive consensus, in an adaptive way [5, 6].

Rule of Dubois & Prade. Dempster-Shafer fusion rule will have some unsatisfactory behavior, when the conflict level is becoming high. If it is assumed that at least one sensor provides the good answer, then it is wiser to replace the possible conflict by a disjunctive repartition of the belief product. This idea is implemented by the rule of Dubois and Prade [5].

The fused bba $m_{\text{D\&P}}$ for any $X \in G^{\Theta} \setminus \{\emptyset\}$ obtained from $m_{1:s}$ is defined by:

$$m_{\text{D\&P}}(\emptyset) = 0, \\ m_{\text{D\&P}}(X) = \sum_{\substack{Y_1 \cap \dots \cap Y_s = X \\ Y_1, \dots, Y_s \in G^{\Theta}}} \prod_{i=1}^s m_i(Y_i) + \sum_{\substack{Y_1 \cap \dots \cap Y_s = \emptyset \\ Y_1 \cup \dots \cup Y_s = X \\ Y_1, \dots, Y_s \in G^{\Theta}}} \prod_{i=1}^s m_i(Y_i) \quad (6.4)$$

Averaging rule. Averaging, although quite simple, may provide good results on some applications.

Let be given the averaging parameters $\alpha_{1:s} \geq 0$ such that $\sum_{i=1}^s \alpha_i = 1$. The averaged bba $m_\mu[\alpha]$ is obtained from $m_{1:s}$ by:

$$m_\mu[\alpha] = \sum_{i=1}^s \alpha_i m_i .$$

PCR6. The proportional conflict redistribution rules (PCR n , $n = 1, 5$) have been introduced by Smarandache and Dezert [15]. The rule PCR6 has been proposed by Martin and Osswald in [10]. PCR rules will typically replace the possible conflict by an adaptive averaging of the belief product.

The fused bba m_{PCR6} obtained from $m_{1:s}$ by means of PCR6 is defined by:

$$m_{\text{PCR6}}(\emptyset) = 0 ,$$

and, for any $X \in G^\ominus \setminus \{\emptyset\}$, by:

$$m_{\text{PCR6}}(X) = m_\wedge(X) + \sum_{i=1}^s m_i(X)^2 \sum_{\substack{\cap_{k=1}^{s-1} Y_{\sigma_i(k)} \cap X = \emptyset \\ Y_{\sigma_i(1)}, \dots, Y_{\sigma_i(s-1)} \in G^\ominus}} \left(\frac{\prod_{j=1}^{s-1} m_{\sigma_i(j)}(Y_{\sigma_i(j)})}{m_i(X) + \sum_{j=1}^{s-1} m_{\sigma_i(j)}(Y_{\sigma_i(j)})} \right) , \quad (6.5)$$

where the function σ_i counts from 1 to s avoiding i :

$$\sigma_i(j) = j \times I[j < i] + (j + 1) \times I[j \geq i] .$$

N.B. If the denominator in (6.5) is zero, then the fraction is discarded.

Prospective. The previous rules are just examples amongst many possible rules. Most of the rules are characterized by their approaches for handling the conflict. Actually, there is not a definitive criterion for the choice of a particular rule. There is not a clearly intuitive framework for the comparison of the rules as well. This chapter addresses this diversity by proposing a constructive interpretation of fusion rules by means of the notion of referee functions.

6.3 Referee function and fusion rules

6.3.1 Referee function

Definition. A referee function on G^\ominus for s sources of information and with context γ is a mapping $X, Y_{1:s} \mapsto F(X|Y_{1:s}; \gamma)$ defined on propositions $X, Y_{1:s} \in G^\ominus$, which satisfies:

- $F(X|Y_{1:s}; \gamma) \geq 0$,
- $\sum_{X \in G^\Theta} F(X|Y_{1:s}; \gamma) = 1$,

for any $X, Y_{1:s} \in G^\Theta$.

A referee function for s sources of information is also called a s -ary referee function. The quantity $F(X|Y_{1:s}; \gamma)$ is called a *conditional arbitrament* between $Y_{1:s}$ in favor of X . Notice that X is not necessary one of the propositions $Y_{1:s}$; typically, it could be a combination of them. The case $X = \emptyset$ is called the *rejection case*.

Fusion rule. Let be given s basic belief assignments (bba's) $m_{1:s}$ and a s -ary referee function F with context $m_{1:s}$. Then, the fused bba $m_1 \oplus \dots \oplus m_s[F]$ based on the referee F is constructed as follows:

$$m_1 \oplus \dots \oplus m_s[F](X) = I[X \neq \emptyset] \frac{\sum_{Y_{1:s} \in G^\Theta} F(X|Y_{1:s}; m_{1:s}) \prod_{i=1}^s m_i(Y_i)}{1 - \sum_{Y_{1:s} \in G^\Theta} F(\emptyset|Y_{1:s}; m_{1:s}) \prod_{i=1}^s m_i(Y_i)}, \quad (6.6)$$

for any $X \in G^\Theta$.

From now on, the notation $\oplus[m_{1:s}|F] = m_1 \oplus \dots \oplus m_s[F]$ is used.

The value $z = \sum_{Y_{1:s} \in G^\Theta} F(\emptyset|Y_{1:s}; m_{1:s}) \prod_{i=1}^s m_i(Y_i)$ is called the *rejection rate*. Notice that the rejection rate is derived from the rejection generated by $F(\emptyset|Y_{1:s}; m_{1:s})$. As a consequence, the rejection is not exclusively a conjunctive notion in this approach. An example of non conjunctive rejection is proposed in section 6.5.

Examples. Refer to section 6.4 and 6.5.

6.3.2 Properties

Bba status. The function $\oplus[m_{1:s}|F]$ defined on G^Θ is actually a basic belief assignment.

Proof. It is obvious that $\oplus[m_{1:s}|F] \geq 0$.
 Since $I[\emptyset \neq \emptyset] = 0$, it is derived $\oplus[m_{1:s}|F](\emptyset) = 0$.

From $\sum_{X \in G^\Theta} F(X|Y_{1:s}; m_{1:s}) = 1$, it is derived:

$$\begin{aligned} & \sum_{X \in G^\Theta} \sum_{Y_{1:s} \in G^\Theta} F(X|Y_{1:s}; m_{1:s}) \prod_{i=1}^s m_i(Y_i) \\ &= \sum_{Y_{1:s} \in G^\Theta} \left(\prod_{i=1}^s m_i(Y_i) \right) \sum_{X \in G^\Theta} F(X|Y_{1:s}; m_{1:s}) \\ &= \sum_{Y_{1:s} \in G^\Theta} \prod_{i=1}^s m_i(Y_i) \\ &= \prod_{i=1}^s \sum_{Y_i \in G^\Theta} m_i(Y_i) = 1 . \end{aligned}$$

As a consequence:

$$\begin{aligned} & \sum_{X \in G^\Theta} I[X \neq \emptyset] \sum_{Y_{1:s} \in G^\Theta} F(X|Y_{1:s}; m_{1:s}) \prod_{i=1}^s m_i(Y_i) \\ & \quad + \sum_{Y_{1:s} \in G^\Theta} F(\emptyset|Y_{1:s}; m_{1:s}) \prod_{i=1}^s m_i(Y_i) = 1 . \end{aligned}$$

□□□

Referee function without rejection. Let be given s basic belief assignments (bba's) $m_{1:s}$ and a s -ary referee function F with context $m_{1:s}$. Assume that F does not imply rejection, that is:

$$F(\emptyset|Y_{1:s}; m_{1:s}) = 0 \quad \text{for any } Y_{1:s} \in G^\Theta \setminus \{\emptyset\} .$$

Then, the fused bba $\oplus[m_{1:s}|F]$ based on the referee F has the simplified definition:

$$\oplus[m_{1:s}|F](X) = \sum_{Y_{1:s} \in G^\Theta} F(X|Y_{1:s}; m_{1:s}) \prod_{i=1}^s m_i(Y_i) , \quad (6.7)$$

for any $X \in G^\Theta$.

Proof. It is a consequence of $\sum_{Y_{1:s} \in G^\Theta} F(\emptyset|Y_{1:s}; m_{1:s}) \prod_{i=1}^s m_i(Y_i) = 0$.

Separability. Let be given s basic belief assignments (bba's) $m_{1:s}$ and a s -ary referee function F with context $m_{1:s}$. Assume that there is r and t such that $r+t = s$, and two sequences $u_{1:r}$ and $v_{1:t}$ which constitute a partition of $\llbracket 1, s \rrbracket$, that is:

$$\{u_{1:r}\} \cup \{v_{1:t}\} = \llbracket 1, s \rrbracket \quad \text{and} \quad \{u_{1:r}\} \cap \{v_{1:t}\} = \emptyset .$$

Assume also that there are a r -ary referee function G with context $m_{u_{1:r}}$, a t -ary referee function H with context $m_{v_{1:t}}$ and a parameter $\theta \in [0, 1]$ such that:

$$F(X|Y_{1:s}; m_{1:s}) = \theta G(X|Y_{u_{1:r}}; m_{u_{1:r}}) + (1 - \theta) H(X|Y_{v_{1:t}}; m_{v_{1:t}}).$$

Then F is said to be *separable* into the *two* sub-referee functions G and H . Moreover, the fused bba is simplified as follows:

$$\oplus[m_{1:s}|F] = \theta \oplus[m_{u_{1:r}}|G] + (1 - \theta) \oplus[m_{v_{1:t}}|H] \quad (6.8)$$

Notice that the fusion is easier for small arity. As a consequence, separability provides possible simplifications to the fusion.

Proof. It is derived:

$$\begin{aligned} \sum_{X \in G^\Theta} \sum_{Y_{1:s} \in G^\Theta} F(X|Y_{1:s}; m_{1:s}) \prod_{i=1}^s m_i(Y_i) \\ = \theta \sum_{X \in G^\Theta} \sum_{Y_{1:s} \in G^\Theta} G(X|Y_{u_{1:r}}; m_{u_{1:r}}) \prod_{i=1}^s m_i(Y_i) \\ + (1 - \theta) \sum_{X \in G^\Theta} \sum_{Y_{1:s} \in G^\Theta} H(X|Y_{v_{1:t}}; m_{v_{1:t}}) \prod_{i=1}^s m_i(Y_i). \end{aligned}$$

Now:

$$\begin{aligned} \sum_{X \in G^\Theta} \sum_{Y_{1:s} \in G^\Theta} G(X|Y_{u_{1:r}}; m_{u_{1:r}}) \prod_{i=1}^s m_i(Y_i) \\ = \left(\sum_{X \in G^\Theta} \sum_{Y_{u_{1:r}} \in G^\Theta} G(X|Y_{u_{1:r}}; m_{u_{1:r}}) \prod_{i=1}^r m_{u_i}(Y_{u_i}) \right) \prod_{i=1}^t \sum_{Y_{v_i} \in G^\Theta} m_{v_i}(Y_{v_i}) \\ = \oplus[m_{u_{1:r}}|G] \prod_{i=1}^t 1 = \oplus[m_{u_{1:r}}|G]. \end{aligned}$$

It is derived similarly:

$$\sum_{X \in G^\Theta} \sum_{Y_{1:s} \in G^\Theta} H(X|Y_{v_{1:t}}; m_{v_{1:t}}) \prod_{i=1}^s m_i(Y_i) = \oplus[m_{v_{1:t}}|H]. \quad \square \square \square$$

Of course, the notion of separability extends easily to more than two sub-referee functions.

6.3.3 Sampling process

The definition (6.6) makes apparent a fusion process which is similar to a probabilistic conditional decision on the set of propositions. Notice that the basic belief assignments are not related, in practice, to *physical* probabilities. But the implied mathematics are similar, as well as some concepts. In particular, the fusion could be interpreted as a two stages process. In a first stage, the sources of information generate independent entries according to the respective beliefs. Then, a final decision is done by the referee function conditionally to the entries. As a result, an output is produced or not.

This interpretation has two profitable consequences. First at all, it provides an intuitive background for constructing new rules: in our framework, a new rule is just the design of a new referee. Secondly, our interpretation makes possible sampling methods in order to approximate and accelerate complex fusion processes. Notice that the sampling method is used here as a mathematical tool for approximating the *belief*, not for simulating an individual choice. Indeed, evidence approaches deal with belief on propositions, not with individual propositions.

Sampling algorithm. Samples of the fused basic belief assignment $\oplus[m_{1:s}|F]$ are generated by iterating the following processes:

Entries generation: For each $i \in \llbracket 1, s \rrbracket$, generates $Y_i \in G^\ominus$ according to the basic belief assignment m_i , considered as a probabilistic distribution over the set G^\ominus ,

Conditional arbitrament:

1. Generate $X \in G^\ominus$ according to referee function $F(X|Y_{1:s}; m_{1:s})$, considered as a probabilistic distribution over the set G^\ominus ,
2. In the case $X = \emptyset$, reject the sample. Otherwise, keep the sample.

The performance of the sampling algorithm is at least dependent of two factors. First at all, a fast implementation of the arbitrament is necessary. Secondly, low rejection rate is better. Notice however that the rejection rate is not a true handicap. Indeed, high rejection rate means that the incident bba's are not compatible in regard to the fusion rule: these bba should not be fused. By the way, the ratio of rejected samples will provide an empirical estimate of the rejection rate of the law.

The case of separable referee function. Assume that F is separable into G and H , *i.e.* there are $\theta \in [0, 1]$ and a partition $(\{u_{1:r}\}, \{v_{1:t}\})$ of $\llbracket 1, s \rrbracket$ such that:

$$F(X|Y_{1:s}; m_{1:s}) = \theta G(X|Y_{u_{1:r}}; m_{u_{1:r}}) + (1 - \theta)H(X|Y_{v_{1:t}}; m_{v_{1:t}}).$$

Then, samples of the fused basic belief assignment $\oplus[m_{1:s}|F]$ are generated by means of the sub-arbitraments related to G and H :

Choice of a sampling sub-process:

1. Generate a random number $x \in [0, 1]$ according to the uniform distribution,
2. If $x < \theta$ then jump to Sampling process related to G ,
3. Otherwise jump to Sampling process related to H ,

Sampling process related to G :

Entries generation: For each $i \in [1, r]$, generates $Y_{u_i} \in G^\Theta$ according to the basic belief assignment m_{u_i} ,

Conditional arbitrament:

1. Generate $X \in G^\Theta$ according to $G(X|Y_{u_{1:r}}; m_{u_{1:r}})$,
2. In the case $X = \emptyset$, reject the sample. Otherwise, return the sample.

Sampling process related to H :

Entries generation: For each $i \in [1, t]$, generates $Y_{v_i} \in G^\Theta$ according to the basic belief assignment m_{v_i} ,

Conditional arbitrament:

1. Generate $X \in G^\Theta$ according to $H(X|Y_{v_{1:t}}; m_{v_{1:t}})$,
2. In the case $X = \emptyset$, reject the sample. Otherwise, return the sample.

This result is a direct consequence of the property of separability (6.8). This algorithm will spare the sampling of useless entries. Therefore, it is more efficient to implement the separability when it is possible.

6.3.4 Algorithmic definition of fusion rules

As seen previously, fusion rules based on referee functions are easily approximated by means of sampling process. This sampling process is double-staged. The first stage computes the samples related to the entry bba's $m_{1:s}$. The second stage computes the fused samples by a conditional arbitrament between the different hypotheses. This arbitrament is formalized by a referee function.

In practice, it is noteworthy that there is no need for a mathematical definition of the referee function. The only important point is to be able to compute the arbitrament. We have here a new approach for defining fusion rules of evidences. Fusion rules may be defined entirely by the means of an algorithm for computing the conditional arbitrament.

Assertion. *There are three equivalent approaches for defining fusion rules in the paradigm of referee:*

- *By defining a formula which maps the entry bba's $m_{1:s}$ to the fused bba $m_1 \oplus \dots \oplus m_s$ (classical approach),*

- By defining a referee function F , which makes the conditional arbitrament $F(X|Y_{1:s}; m_{1:s})$,
- By constructing an algorithm which actually makes the conditional arbitrament between $Y_{1:s}$ in favor of X .

It is sometimes much easier and more powerful to just construct the algorithm for conditional arbitrament.

The following section illustrates the afore theoretical discussion on well known examples.

6.4 Example of referee functions

Let be given s sources of information characterized by their bba's $m_{1:s}$.

6.4.1 Dempster-Shafer rule

The fused bba m_{DST} obtained from $m_{1:s}$ by means of *Dempster-Shafer* fusion rule is defined by equation (6.1). It has an immediate interpretation by means of referee functions.

Definition by referee function. The definition of a referee function for Dempster-Shafer is immediate:

$$m_{\text{DST}} = \oplus[m_{1:s}|F_{\wedge}] \quad \text{where } F_{\wedge}(X|Y_{1:s}; m_{1:s}) = I \left[X = \bigcap_{k=1}^s Y_k \right].$$

Algorithmic definition. The algorithmic implementation of F_{\wedge} is described subsequently and typically implies possible conditional rejections:

Conditional arbitrament:

1. Set $X = \bigcap_{k=1}^s Y_k$,
2. If $X = \emptyset$, then reject the sample. Otherwise, keep the sample.

6.4.2 Disjunctive rule

The fused bba m_{\vee} obtained from $m_{1:s}$ by means of the disjunctive rule is defined by equation (6.3). It has an immediate interpretation by means of referee functions.

Definition by referee function. The definition of a referee function for the disjunctive rule is immediate from (6.3):

$$m_{\vee} = \oplus[m_{1:s}|F_{\vee}]$$

where:

$$F_{\vee}(X|Y_{1:s}; m_{1:s}) = I \left[X = \bigcup_{k=1}^s Y_k \right] .$$

Algorithmic definition. The algorithmic implementation of F_{\vee} is described subsequently. It does not imply rejections:

Conditional arbitrament:

1. Set $X = \bigcup_{k=1}^s Y_k$.

6.4.3 Dubois & Prade rule

The fused bba $m_{D\&P}$ obtained from $m_{1:s}$ by means of the rule of Dubois & Prade is defined by equation (6.4). It has an interpretation by means of referee functions.

Definition by referee function. The definition of a referee function for Dubois & Prade rule is deduced from (6.4):

$$m_{D\&P} = \oplus[m_{1:s}|F_{D\&P}]$$

where:

$$\begin{aligned} F_{D\&P}(X|Y_{1:s}; m_{1:s}) &= I \left[\bigcap_{k=1}^s Y_k \neq \emptyset \right] F_{\wedge}(X|Y_{1:s}; m_{1:s}) + I \left[\bigcap_{k=1}^s Y_k = \emptyset \right] F_{\vee}(X|Y_{1:s}; m_{1:s}) \\ &= I \left[X = \bigcap_{k=1}^s Y_k \neq \emptyset \right] + I \left[\bigcap_{k=1}^s Y_k = \emptyset \right] I \left[X = \bigcup_{k=1}^s Y_k \right] . \end{aligned}$$

The first formulation of $F_{D\&P}$ is particularly interesting, since it illustrates how to construct a referee function by means of a conditional branching to already existing referee functions. In the case of Dubois & Prade rule, the rule has a disjunctive behavior when there is a conjunctive conflict, *i.e.* $\bigcap_{k=1}^s Y_k = \emptyset$, and a conjunctive behavior otherwise. Thus, the referee function is obtained as the summation of the exclusive sub-arbitraments:

$$I \left[\bigcap_{k=1}^s Y_k = \emptyset \right] F_{\vee}(X|Y_{1:s}; m_{1:s}) \quad (\text{disjunctive case})$$

and

$$I \left[\bigcap_{k=1}^s Y_k \neq \emptyset \right] F_{\wedge}(X|Y_{1:s}; m_{1:s}) \quad (\text{conjunctive case}).$$

Algorithmic definition. The algorithmic implementation of $F_{D\&P}$ is described subsequently. It does not imply rejections:

Conditional arbitrament:

1. Set $X = \bigcap_{k=1}^s Y_k$,
2. If $X = \emptyset$, then set $X = \bigcup_{k=1}^s Y_k$.

6.4.4 Averaging rule

Let be given the averaging parameters $\alpha_{1:s} \geq 0$ such that $\sum_{i=1}^s \alpha_i = 1$. The averaged bba $m_\mu[\alpha] = \sum_{i=1}^s \alpha_i m_i$ could be obtained by means of a referee function.

Averaging by referee function. The definition of a referee function for averaging is immediate:

$$m_\mu[\alpha] = \oplus[m_{1:s}|F_\mu[\alpha]]$$

where:

$$F_\mu[\alpha](X|Y_{1:s}; m_{1:s}) = \sum_{i=1}^s \alpha_i I[X = Y_i] .$$

Proof by applying the separability. It is noticed that F is separable:

$$F_\mu[\alpha](X|Y_{1:s}; m_{1:s}) = \sum_{i=1}^s \alpha_i \text{id}_i(X|Y_i, m_i) ,$$

where the referee function id_i is defined by:

$$\text{id}_i(X|Y_i, m_i) = I[X = Y_i] \quad \text{for any } X, Y_i \in G^\Theta$$

By applying the separability property (6.8), $s - 1$ times, it comes:

$$\oplus[m_{1:s}|F_\mu[\alpha]] = \sum_{i=1}^s \alpha_i \oplus[m_i|\text{id}_i] .$$

It happens that:

$$\oplus[m_i|\text{id}_i] = m_i ,$$

so that:

$$\oplus[m_{1:s}|F_\mu[\alpha]] = \sum_{i=1}^s \alpha_i m_i = m_\mu[\alpha] .$$

Algorithmic implementation of averaging. It is interesting here to implement the separability of the referee function. Therefore, the entire sampling algorithm is derived from the separability property:

Choice of a sampling sub-process:

1. Generate a random integer $i \in [1, s]$ according to probability α ,
2. Jump to Sampling process related to id_i ,

Sampling process related to id_i :

Entries generation: Generates $Y_i \in G^\Theta$ according to the basic belief assignment m_i ,

Conditional arbitrament: Return $X = Y_i$.

6.4.5 PCR6 rule

The fused bba m_{PCR6} obtained from $m_{1:s}$ by means of the PCR6 rule is defined by equation (6.5). It has an interpretation by means of referee functions.

Definition by referee function. Definition (6.5) could be reformulated into:

$$m_{\text{PCR6}}(X) = m_{\wedge}(X) + \sum_{i=1}^s \sum_{\substack{\bigcap_{k=1}^s Y_k = \emptyset \\ Y_1, \dots, Y_s \in G^\Theta}} \left(\frac{I[X = Y_i] m_i(Y_i) \prod_{j=1}^s m_j(Y_j)}{\sum_{j=1}^s m_j(Y_j)} \right),$$

and then:

$$m_{\text{PCR6}}(X) = m_{\wedge}(X) + \sum_{\substack{\bigcap_{k=1}^s Y_k = \emptyset \\ Y_1, \dots, Y_s \in G^\Theta}} \prod_{i=1}^s m_i(Y_i) \frac{\sum_{j=1}^s I[X = Y_j] m_j(Y_j)}{\sum_{j=1}^s m_j(Y_j)}. \quad (6.9)$$

At last, it is derived a formulation of PCR6 by means of a referee function:

$$m_{\text{PCR6}} = \oplus [m_{1:s} | F_{\text{PCR6}}],$$

where the referee function F_{PCR6} is defined by:

$$F_{\text{PCR6}}(X | Y_{1:s}; m_{1:s}) = I \left[X = \bigcap_{k=1}^s Y_k \neq \emptyset \right] + I \left[\bigcap_{k=1}^s Y_k = \emptyset \right] \frac{\sum_{j=1}^s I[X = Y_j] m_j(Y_j)}{\sum_{j=1}^s m_j(Y_j)}. \quad (6.10)$$

Algorithmic definition. Again, the algorithmic implementation is immediate:

Conditional arbitrament:

1. If $\bigcap_{k=1}^s Y_k \neq \emptyset$, then set $X = \bigcap_{k=1}^s Y_k$
2. Otherwise:
 - a) Define the probability P over $\llbracket 1, s \rrbracket$ by:

$$P_i = \frac{m_i(Y_i)}{\sum_{j=1}^s m_j(Y_j)} \text{ for any } i \in \llbracket 1, s \rrbracket ,$$

- b) Generate a random integer $k \in \llbracket 1, s \rrbracket$ according to P ,
 - c) set $X = Y_k$.

It is noticed that this process does not produce any rejection case $X = \emptyset$. As a consequence, the last rejection step has been removed.

Essentially, this algorithm distinguishes two cases:

- there is a consensus; then, answer the consensus,
- there is not a consensus; then choose an entry among all entries proportionally to its belief. It is noteworthy that there is no attempt to transform the entries in this case.

This algorithm is efficient and is not time-consuming. The whole sampling approach should be a good alternative for approximating PCR6, particularly on large frames of discernment.

6.4.6 Non conjunctive rejection

As seen in section 6.3, the rejection, resulting from a fusion based on referee functions, is not necessary a conjunctive conflict: this rejection is the result of the arbitrament rejections $F(\emptyset|Y_{1:s}; m_{1:s})$. An example of rule with disjunctive rejection is proposed now. This example is rather unnatural; it is only constructed for illustration. The context of fusion is the following:

Case a: Entries which union is Ω (*i.e.* is totally imprecise) are rejected; the idea here, is to reject entries which are insufficiently focused,

Case b: An averaging of the bba is done, otherwise.

The referee function is thus obtained by means of a conditional branching to the rejection (case a) or to the averaging (case b). As a consequence, the referee function is obtained as the summation of the following exclusive sub-arbitraments:

Case a: $I \left[\bigcup_{i=1}^s Y_i = \Omega \right] I [X = \emptyset] ,$

Case b: $I \left[\bigcup_{i=1}^s Y_i \neq \Omega \right] \sum_{i=1}^s \frac{I[X = Y_i]}{s}$.

The referee function for this rule is:

$$F(X|Y_{1:s}; m_{1:s}) = I \left[\bigcup_{i=1}^s Y_i = \Omega \right] I[X = \emptyset] + I \left[\bigcup_{i=1}^s Y_i \neq \Omega \right] \sum_{i=1}^s \frac{I[X = Y_i]}{s}.$$

Let us apply this rule to the example of $s = 2$ bba's m_1 and m_2 defined on $2^{\{a,b,c\}}$ by $m_1(\{a\}) = 0.1$, $m_1(\{a, b\}) = 0.9$, $m_2(\{b\}) = 0.2$ and $m_2(\{b, c\}) = 0.8$. Then, the fused bba $m = m_1 \oplus m_2[F]$ is obtained as:

$$\begin{aligned} z &= m_1(\{a\})m_2(\{b, c\}) + m_1(\{a, b\})m_2(\{b, c\}) = 0.8, \\ m(\{a\}) &= \frac{m_1(\{a\})m_2(\{b\})}{2(1-z)} = 0.05, \quad m(\{a, b\}) = \frac{m_1(\{a,b\})m_2(\{b\})}{2(1-z)} = 0.45, \\ m(\{b\}) &= \frac{m_1(\{a\})m_2(\{b\}) + m_1(\{a,b\})m_2(\{b\})}{2(1-z)} = 0.5. \end{aligned}$$

In this example, the rejection rate z is not conjunctive, since it involves $\{a, b\}$ and $\{b, c\}$ such that $\{a, b\} \cap \{b, c\} \neq \emptyset$.

6.4.7 Any rule?

Is it possible to construct a referee function for any existing fusion rule?

Actually, the answer to this question is ambiguous. If it is authorized that F depends on $m_{1:s}$ without restriction, then the theoretical answer is trivially yes.

Property. Let be given the fusion rule $m_1 \oplus \dots \oplus m_s$, applying on the bba's $m_{1:s}$. Define the referee function F by:

$$F(X|Y_{1:s}; m_{1:s}) = m_1 \oplus \dots \oplus m_s(X) \text{ for any } X, Y_{1:s} \in G^\Theta.$$

Then F is actually a referee function and $\oplus[m_{1:s}|F] = m_1 \oplus \dots \oplus m_s$.

Proof is immediate.

Of course, this result is useless in practice, since such referee function is inefficient. It is inefficient because it does not provide an intuitive interpretation of the rule, and is as difficult to compute as the fusion rule. Then, it is useless to have a sampling approach with such definition.

As a conclusion, referee functions have to be considered together with their efficiency. The efficiency of referee function is not a topic which is studied in this chapter.

6.5 A new rule: PCR_#

Definition. For any $k \in \llbracket 1, s \rrbracket$, it is defined:

$$C[k|s] = \{ \gamma \subset \llbracket 1, s \rrbracket / \text{card}(\gamma) = k \} ,$$

the set of k -combinations of $\llbracket 1, s \rrbracket$. Of course, the cardinal of $C[k|s]$ is $\binom{s}{k}$.

For convenience, the undefined object $C[s+1|s]$ is actually defined by:

$$C[s+1|s] = \{ \{ \emptyset \} \} ,$$

so as to ensure:

$$\min_{\gamma \in C[s+1|s]} \left\{ I \left[\bigcap_{i \in \gamma} Y_i = \emptyset \right] \right\} = 1$$

6.5.1 Limitations of PCR6

The algorithmic interpretation of PCR6 has shown that PCR6 distinguishes two cases:

- The entry information are compatible; then, the conjunctive consensus is decided,
- The entry information are not compatible; then, a mean decision is decided, weighted by the relative beliefs of the entries.

In other words, PCR6 only considers consensus or no-consensus cases. But for more than 2 sources, there are many cases of *intermediate consensus*. By construction, PCR6 is not capable to manage intermediate consensus. This is a notable limitation of PCR6.

The new rule PCR_#, which is defined now, extends PCR6 by considering partial consensus in addition to full consensus and absence of consensus. This rule is constructed by specifying the arbitrament algorithm. Then, a referee function is deduced.

6.5.2 Algorithm

The following algorithm tries to reach a maximal consensus. It first tries the full consensus, then consensus of $s-1$ sources, $s-2$ sources, and so on, until a consensus is finally found. When several consensus with k sources is possible, the final answer is chosen randomly, proportionally to the beliefs of the consensus. In the following algorithm, comments are included preceded by `//` (c++ convention).

Conditional arbitrament:

1. Set `stop = false` and `k = s`,
`// k is the size of the consensus, which are searched. At beginning, it is maximal.`

2. For each $\gamma \in C[k|s]$, do:
 - // All possible consensus of size k are tested.
 - a) If $\bigcap_{i \in \gamma} Y_i \neq \emptyset$, then set $\omega_\gamma = \prod_{i \in \gamma} m_i(Y_i)$ and $stop = true$,
 - // If a consensus of size k is found to be functional, then it is no more necessary to diminish the size of the consensus. This is done by changing the value of Boolean $stop$.
 - // Moreover, the functional consensus are weighted by their beliefs.
 - b) Otherwise set $\omega_\gamma = 0$,
 - // Non-functional consensus are weighted zero.
3. If $stop = false$, then set $k = k - 1$ and go back to 2,
 - // If no functional consensus of size k has been found, then it is necessary to test smaller sized consensus. The process is thus repeated for size $k - 1$.
4. Choose $\gamma \in C[k|s]$ randomly, according to the probability:

$$P_\gamma = \frac{\omega_\gamma}{\sum_{\gamma \in C[k|s]} \omega_\gamma},$$

// Otherwise, choose a functional consensus. Here, the decision is random and proportional to the consensus belief.

5. At last, set $X = \bigcap_{i \in \gamma} Y_i$.
 - // Publish the sample related to the consensus.

Algorithm without comment.

Conditional arbitrament:

1. Set $stop = false$ and $k = s$,
2. For each $\gamma \in C[k|s]$, do:
 - a) If $\bigcap_{i \in \gamma} Y_i \neq \emptyset$, then set $\omega_\gamma = \prod_{i \in \gamma} m_i(Y_i)$ and $stop = true$,
 - b) Otherwise set $\omega_\gamma = 0$,
3. If $stop = false$, then set $k = k - 1$ and go back to 2,
4. Choose $\gamma \in C[k|s]$ randomly, according to the probability:

$$P_\gamma = \frac{\omega_\gamma}{\sum_{\gamma \in C[k|s]} \omega_\gamma},$$

5. At last, set $X = \bigcap_{i \in \gamma} Y_i$.

6.5.3 Referee function

Historically, $\text{PCR}_{\#}$ has been defined by means of an algorithm, not by means of a formal definition of the referee function. It is however possible to give a formal definition of the referee function which is equivalent to the algorithm:

$$F_{\text{PCR}_{\#}}(X|Y_{1:s}; m_{1:s}) = \sum_{k=1}^s \min_{\gamma \in C[k+1|s]} \left\{ I \left[\bigcap_{i \in \gamma} Y_i = \emptyset \right] \right\} \\ \times \min \left\{ \max_{\gamma \in C[k|s]} \left\{ I \left[\bigcap_{i \in \gamma} Y_i \neq \emptyset \right] \right\}, \frac{\sum_{\gamma \in C[k|s]} I \left[X = \bigcap_{i \in \gamma} Y_i \neq \emptyset \right] \prod_{i \in \gamma} m_i(Y_i)}{\sum_{\gamma \in C[k|s]} I \left[\bigcap_{i \in \gamma} Y_i \neq \emptyset \right] \prod_{i \in \gamma} m_i(Y_i)} \right\}. \quad (6.11)$$

Sketch of the proof. The following correspondences are established between the arbitrament algorithm and the referee function:

- The summation $\sum_{k=1}^s$ is a formalization of the loop from $k = s$ down to $k = 1$,
- At step k , the component:

$$\min_{\gamma \in C[k+1|s]} \left\{ I \left[\bigcap_{i \in \gamma} Y_i = \emptyset \right] \right\}$$

ensures that there is not a functional consensus of larger size $j > k$. Typically, the component is 0 if a larger sized functional consensus exists, and 1 otherwise. This component is complementary to the summation, as it formalizes the end of the loop, when a functional consensus is actually found,

- At step k , the component:

$$\Omega = \frac{\sum_{\gamma \in C[k|s]} I \left[X = \bigcap_{i \in \gamma} Y_i \neq \emptyset \right] \prod_{i \in \gamma} m_i(Y_i)}{\sum_{\gamma \in C[k|s]} I \left[\bigcap_{i \in \gamma} Y_i \neq \emptyset \right] \prod_{i \in \gamma} m_i(Y_i)}$$

encodes the choice of a functional consensus of size k , proportionally to its belief. The chosen consensus results in the production of the sample X ,

- At step k , the component:

$$\max_{\gamma \in C[k|s]} \left\{ I \left[\bigcap_{i \in \gamma} Y_i \neq \emptyset \right] \right\}$$

tests if there is a functional consensus of size k . The component answers 1 if such consensus exists, and 0 otherwise. It is combined with a minimization of

the form:

$$\min \left\{ \max_{\gamma \in C[k|s]} \left\{ I \left[\bigcap_{i \in \gamma} Y_i \neq \emptyset \right] \right\}, \Omega \right\}, \text{ where } \Omega \leq 1 .$$

This is some kind of “if ... then” : if a functional consensus of size k exists, then the value Ω is computed. Otherwise, it is the value 0 . Since the value Ω encodes a sampling decision, we have here sampling decision, which is conditioned by the fact that a functional consensus exists.

The equivalence is a consequence of these correspondences.

□

6.5.4 Variants of PCR_#

Actually, $\text{card}(C[k|s]) = \binom{s}{k}$ increases quickly when s is great and k is not near 1 or s . As a consequence, PCR_# implies hard combinatorics, when used in its general form. On the other hand, it may be interesting to reject samples, when a consensus is not possible with a minimal quorum. In order to address such problems, a slight extension of PCR_# is proposed now.

Algorithm.

Let $r \in [1, s]$ and let $k_{1:r} \in [1, s]$ be a decreasing sequence such that:

$$s \geq k_1 > \dots > k_r \geq 1 .$$

For convenience, the undefined object k_0 is actually defined by:

$$k_0 = s + 1 ,$$

so as to ensure:

$$\min_{\gamma \in C[k_0|s]} \left\{ I \left[\bigcap_{i \in \gamma} Y_i = \emptyset \right] \right\} = 1$$

Then, the rule PCR_#[$k_{1:r}$] is defined by the following algorithm.

Conditional arbitrament:

1. Set $stop = false$ and $h = 1$,
2. For each $\gamma \in C[k_h|s]$, do:
 - a) If $\bigcap_{i \in \gamma} Y_i \neq \emptyset$, then set $\omega_\gamma = \prod_{i \in \gamma} m_i(Y_i)$ and $stop = true$,
 - b) Otherwise set $\omega_\gamma = 0$,
3. If $stop = false$, then:

- a) set $h = h + 1$,
- b) If $h \leq r$, go back to 2,
4. If $h > r$, then reject the entries and end,
5. Otherwise, choose $\gamma \in C[k_h | s]$ randomly, according to the probability:

$$P_\gamma = \frac{\omega_\gamma}{\sum_{\gamma \in C[k_h | s]} \omega_\gamma},$$

6. Set $X = \bigcap_{i \in \gamma} Y_i$. and end.

Referee function

$$F_{\text{PCR}\sharp[k_{1:r}]}(X|Y_{1:s}; m_{1:s}) =$$

$$I[X = \emptyset] \min_{\gamma \in C[k_r | s]} \left\{ I \left[\bigcap_{i \in \gamma} Y_i = \emptyset \right] \right\} + \sum_{h=1}^r \min_{\gamma \in C[k_{h-1} | s]} \left\{ I \left[\bigcap_{i \in \gamma} Y_i = \emptyset \right] \right\} \\ \times \min \left\{ \max_{\gamma \in C[k_h | s]} \left\{ I \left[\bigcap_{i \in \gamma} Y_i \neq \emptyset \right] \right\}, \frac{\sum_{\gamma \in C[k_h | s]} I \left[X = \bigcap_{i \in \gamma} Y_i \neq \emptyset \right] \prod_{i \in \gamma} m_i(Y_i)}{\sum_{\gamma \in C[k_h | s]} I \left[\bigcap_{i \in \gamma} Y_i \neq \emptyset \right] \prod_{i \in \gamma} m_i(Y_i)} \right\}.$$

proof is left to the reader.

PCR6 and PCR \sharp . Assume that PCR6 is applied to s entries $m_{1:s}$. Then:

$$\text{PCR6} = \text{PCR}\sharp[s, 1]$$

DST and PCR \sharp . Assume that DST is applied to s entries $m_{1:s}$. Then:

$$\text{DST} = \text{PCR}\sharp[s]$$

Variant with truncation and rejection. Let $r \in [1, s]$. The rule $\text{PCR}\sharp[s, s-1, \dots, r]$ will search for maximally sized functional consensus. If it is not possible to find functional consensus with size greater or equal to r , the algorithm rejects the entries.

Variant with truncation and final mean decision. Let $r \in [1, s]$. The rule $\text{PCR}\sharp[s, s-1, \dots, r, 1]$ will search for maximally sized functional consensus. If it is not possible to find functional consensus with size greater or equal to r , the algorithm choose an entry proportionally to its belief.

6.6 Numerical examples

It is assumed:

$$G^\Theta = \{\emptyset, \{a\}, \{b\}, \{c\}, \{b, c\}, \{c, a\}, \{a, b\}, \{a, b, c\}\} .$$

Various examples of bba's, $m_{1:s}$, are considered on G^Θ and fused by means of rules based on different referee functions. The fused rule, $m = \oplus[m_{1:s}|F]$, is computed both mathematically or by means of the sampler. When the fusion is obtained by sampling a particle cloud, the fused bba estimate is deduced from an empirical averaging. The complete process arises as follows:

1. Repeat from $n = 1$ to $n = N$:
 - a) Generate the particle $X_n \in G^\Theta$ by sampling $\oplus[m_{1:s}|F]$,
 - b) If the sampling process failed, then set X_n = rejected ,
2. Compute \hat{z} , the estimate of z , by setting $\hat{z} = \frac{1}{N} \sum_{n=1}^N I[X_n = \text{rejected}]$,
3. For any $X \in G^\Theta$, compute $\hat{m}(X)$, the estimate of $m(X)$, by:

$$\hat{m}(X) = \frac{1}{N(1 - \hat{z})} \sum_{n=1}^N I[X_n = X] .$$

It is known that the accuracy of this estimate is of the magnitude of $\frac{1}{\sqrt{N}}$. Typically, when the rejection rate is zero, *i.e.* $z = 0$, the variance $\sigma(\hat{m}(X))$ is given by:

$$\sigma(m(X)) = \sqrt{\frac{m(X) \cdot (1 - m(X))}{N}} .$$

6.6.1 Convergence

Example 1. The bba's m_1 and m_2 are defined by:

$$\begin{aligned} m_1(\{a, b\}) = 0.2, \quad m_1(\{a, c\}) = 0.4, \quad m_1(\{b, c\}) = 0.3, \quad m_1(\{a, b, c\}) = 0.1, \\ m_2(\{a, b\}) = 0.4, \quad m_2(\{a, c\}) = 0.2, \quad m_2(\{b, c\}) = 0.3, \quad m_2(\{a, b, c\}) = 0.1. \end{aligned}$$

These bba's are fused by means of DST, resulting in $m = m_{\text{DST}}$:

$$\begin{aligned} z = 0, \quad m(\{a\}) = 0.2, \quad m(\{b\}) = 0.18, \quad m(\{a, b\}) = 0.14, \quad m(\{c\}) = 0.18, \\ m(\{a, c\}) = 0.14, \quad m(\{b, c\}) = 0.15, \quad m(\{a, b, c\}) = 0.01. \end{aligned}$$

The estimate \hat{m} of m is obtained by the following process:

1. Repeat from $n = 1$ to $n = N$:
 - a) Generate Y_1 and Y_2 by means of m_1 and m_2 respectively,

- b) If $Y_1 \cap Y_2 = \emptyset$, then set $X_n = \text{rejected}$,
 - c) Otherwise, set $X_n = Y_1 \cap Y_2$,
2. Set $\hat{z} = \frac{1}{N} \sum_{n=1}^N I[X_n = \text{rejected}]$,
 3. For any $X \in G^\Theta$, compute $\hat{m}(X)$ by:

$$\hat{m}(X) = \frac{1}{N(1 - \hat{z})} \sum_{n=1}^N I[X_n = X].$$

The following table compares the empirical estimates of m , computed by means of particle clouds of different sizes N :

$\log_{10} N$	1	2	3	4	5	6	7	8	∞
\hat{z}	0	0	0	0	0	0	0	0	0
$\hat{m}(\{a\})$	0.2	0.18	0.202	0.201	0.200	0.200	0.200	0.200	0.2
$\hat{m}(\{b\})$	0.1	0.19	0.173	0.182	0.181	0.180	0.180	0.180	0.18
$\hat{m}(\{a, b\})$	0.3	0.14	0.139	0.138	0.139	0.140	0.140	0.140	0.14
$\hat{m}(\{c\})$	0.1	0.15	0.179	0.177	0.181	0.180	0.180	0.180	0.18
$\hat{m}(\{a, c\})$	0.3	0.17	0.141	0.136	0.140	0.140	0.140	0.140	0.14
$\hat{m}(\{b, c\})$	0	0.15	0.153	0.155	0.149	0.150	0.150	0.150	0.15
$\hat{m}(\{a, b, c\})$	0	0.02	0.013	0.011	0.010	0.010	0.010	0.010	0.01

For this choice of m_1 and m_2 , there is no conflict. The theoretical accuracy defined previously thus applies. The results are compliant with the theoretical accuracy.

Example 2. This is an example with rejection. The bba's m_1 and m_2 are defined by:

$$m_1(\{a\}) = 0.4, \quad m_1(\{a, b\}) = 0.5, \quad m_1(\{a, b, c\}) = 0.1,$$

$$m_2(\{c\}) = 0.4, \quad m_2(\{b, c\}) = 0.5, \quad m_2(\{a, b, c\}) = 0.1.$$

These bba's are fused by means of DST, resulting in $m = m_{\text{DST}}$:

$$z = 0.56, \quad m(\{a\}) = 0.091, \quad m(\{b\}) = 0.568, \quad m(\{a, b\}) = 0.114, \quad m(\{c\}) = 0.091,$$

$$m(\{b, c\}) = 0.114, \quad m(\{a, b, c\}) = 0.022.$$

The estimate \hat{m} of m is obtained by the same process as for example 1. The following table compares the empirical estimates of m , computed by means of particle clouds of different sizes N :

$\log_{10} N$	1	2	3	4	5	6	7	8	∞
\hat{z}	0.7	0.6	0.56	0.558	0.560	0.559	0.560	0.560	0.56
$\hat{m}(\{a\})$	0.667	0.15	0.109	0.088	0.092	0.090	0.091	0.091	0.091
$\hat{m}(\{b\})$	0	0.375	0.573	0.565	0.566	0.569	0.568	0.568	0.568
$\hat{m}(\{a, b\})$	0	0.125	0.107	0.114	0.114	0.114	0.114	0.114	0.114
$\hat{m}(\{c\})$	0.333	0.225	0.091	0.091	0.091	0.091	0.091	0.091	0.091
$\hat{m}(\{b, c\})$	0	0.125	0.107	0.125	0.115	0.114	0.114	0.114	0.114
$\hat{m}(\{a, b, c\})$	0	0	0.013	0.017	0.022	0.022	0.022	0.022	0.022

Notice that the theoretical accuracy should be corrected, since $z > 0$.

Example 3. The bba's m_1 and m_2 are defined by:

$$m_1(\{a\}) = 0.5, \quad m_1(\{a, b\}) = 0.1, \quad m_1(\{a, b, c\}) = 0.4, \\ m_2(\{c\}) = 0.3, \quad m_2(\{a, c\}) = 0.3, \quad m_2(\{a, b, c\}) = 0.4.$$

These bba's are fused by means of PCR6, resulting in $m = m_{\text{PCR6}}$:

$$m(\{a\}) = 0.385, \quad m(\{b\}) = 0.04, \quad m(\{a, b\}) = 0.007, \quad m(\{c\}) = 0.199, \\ m(\{a, c\}) = 0.12, \quad m(\{b, c\}) = 0.249.$$

It is noticed that $z = 0$ in this case of PCR6. Then, the estimate \hat{m} is obtained by the following process:

1. Repeat from $n = 1$ to $n = N$:
 - a) Generate Y_1 and Y_2 by means of m_1 and m_2 respectively,
 - b) If $Y_1 \cap Y_2 \neq \emptyset$, then set $X_n = Y_1 \cap Y_2$,
 - c) Otherwise, do:
 - i. Compute $\theta = \frac{m_1(Y_1)}{m_1(Y_1) + m_2(Y_2)}$,
 - ii. Generate a random number x uniformly distributed on $[0, 1]$,
 - iii. If $x < \theta$, set $X_n = Y_1$; otherwise, set $X_n = Y_2$,
2. For any $X \in G^\Theta$, compute $\hat{m}(X)$ by:

$$\hat{m}(X) = \frac{1}{N} \sum_{n=1}^N I[X_n = X].$$

The following table compares the empirical estimates of m , computed by means of particle clouds of different sizes N :

$\log_{10} N$	1	2	3	4	5	6	7	8	∞
$m(\{a\})$	0.7	0.41	0.39	0.388	0.382	0.384	0.385	0.385	0.385
$m(\{b\})$	0.1	0.08	0.045	0.041	0.040	0.040	0.040	0.040	0.040
$m(\{a, b\})$	0	0.01	0.008	0.008	0.008	0.008	0.007	0.007	0.007
$m(\{c\})$	0.2	0.13	0.19	0.198	0.200	0.199	0.199	0.199	0.199
$m(\{a, c\})$	0	0.12	0.108	0.121	0.121	0.120	0.120	0.120	0.12
$m(\{b, c\})$	0	0.25	0.259	0.244	0.249	0.249	0.249	0.249	0.249

6.6.2 Comparative tests

Example 4. It is assumed 3 bba's $m_{1:3}$ on G^\ominus defined by:

$$m_1(\{a, b\}) = m_2(\{a, c\}) = m_3(\{c\}) = 1.$$

The bba's m_1 and m_3 are incompatible. However, m_2 is compatible with both m_1 and m_3 , which implies that a partial consensus is possible between m_1 and m_2 or between m_2 and m_3 . As a consequence, PCR# should provide better answers by allowing partial combinations of the bba's. The fusion of the 3 bba's are computed respectively by means of DST, PCR6 and PCR#, and the results confirm the intuition:

- $z_{DST} = 1$ and m_{DST} is undefined,
- $m_{PCR6}(\{a, b\}) = m_{PCR6}(\{a, c\}) = m_{PCR6}(\{c\}) = \frac{1}{3}$,
- $m_{PCR\#}(\{a\}) = m_{PCR\#}(\{c\}) = \frac{1}{2}$ derived from the consensus $\{a, b\} \cap \{a, c\}$, $\{a, c\} \cap \{c\}$ and their beliefs $m_1(\{a, b\})m_2(\{a, c\})$, $m_2(\{a, c\})m_3(\{c\})$.

Example 5. It is assumed 3 bba's $m_{1:3}$ on G^\ominus defined by:

$$\begin{aligned} m_1(\{a\}) &= 0.6, & m_1(\{a, b\}) &= 0.4, \\ m_2(\{a\}) &= 0.3, & m_2(\{a, c\}) &= 0.7, \\ m_3(\{b\}) &= 0.8, & m_3(\{a, b, c\}) &= 0.2. \end{aligned}$$

The computation of PCR# is done step by step:

Full consensus. Full functional consensus are:

Y_1	$\{a, b\}$	$\{a, b\}$	$\{a\}$	$\{a\}$
Y_2	$\{a, c\}$	$\{a\}$	$\{a, c\}$	$\{a\}$
Y_3	$\{a, b, c\}$	$\{a, b, c\}$	$\{a, b, c\}$	$\{a, b, c\}$
$\bigcap_i Y_i$	$\{a\}$	$\{a\}$	$\{a\}$	$\{a\}$
$\prod_i m_i(Y_i)$	0.056	0.024	0.084	0.036

Partial consensus sized 2. Then the possible partial consensus are:

Y_1	$\{a, b\}$	$\{a, b\}$	$\{a\}$	$\{a\}$
Y_2	$\{a, c\}$	$\{a\}$	$\{a, c\}$	$\{a\}$
Y_3	$\{b\}$	$\{b\}$	$\{b\}$	$\{b\}$
$Y_1 \cap Y_2$	$\{a\}$	$\{a\}$	$\{a\}$	$\{a\}$
$Y_2 \cap Y_3$	\emptyset	\emptyset	\emptyset	\emptyset
$Y_3 \cap Y_1$	$\{b\}$	$\{b\}$	\emptyset	\emptyset
$\frac{m_2(Y_2)}{m_2(Y_2)+m_3(Y_3)}$	0.467	0.273	1	1
$\frac{m_3(Y_3)}{m_2(Y_2)+m_3(Y_3)}$	0.533	0.727	0	0
$\prod_i m_i(Y_i)$	0.224	0.096	0.336	0.144

Notice that there is never a 2-sized consensus involving the pair (Y_2, Y_3) . As a consequence, the belief ratios for the partial consensus, *i.e.*:

$$\omega_\gamma = \frac{I \left[\bigcap_{i \in \gamma} Y_i \neq \emptyset \right] \prod_{i \in \gamma} m_i(Y_i)}{\sum_{\gamma' \in C[2|3]} I \left[\bigcap_{i \in \gamma'} Y_i \neq \emptyset \right] \prod_{i \in \gamma'} m_i(Y_i)} \quad \text{for } \gamma \in C[2|3],$$

are simplified as follows:

$$\begin{cases} \omega_{\{1,2\}} = \frac{m_1(Y_1)m_2(Y_2)}{m_1(Y_1)m_2(Y_2)+m_3(Y_3)m_1(Y_1)} = \frac{m_2(Y_2)}{m_2(Y_2)+m_3(Y_3)}, \\ \omega_{\{1,3\}} = \frac{m_3(Y_3)m_1(Y_1)}{m_1(Y_1)m_2(Y_2)+m_3(Y_3)m_1(Y_1)} = \frac{m_3(Y_3)}{m_2(Y_2)+m_3(Y_3)}, \end{cases}$$

The case $\gamma = \{2, 3\}$ does not hold.

1-sized consensus. There is no remaining 1-sized consensus.

Belief compilation. The different cases resulted in only two propositions, *i.e.* $\{a\}$ and $\{b\}$. By combining the entry beliefs $\prod_i m_i(Y_i)$ and ratio beliefs, the fused bba $m = m_{\text{PCR}\#}$ is then deduced:

$$\begin{aligned} m(\{a\}) &= 0.056 + 0.024 + 0.084 + 0.036 + 0.467 \times 0.224 \\ &\quad + 0.273 \times 0.096 + 1 \times 0.336 + 1 \times 0.144 = 0.811, \\ m(\{b\}) &= 0.533 \times 0.224 + 0.727 \times 0.096 = 0.189. \end{aligned}$$

As a conclusion:

$$m_{\text{PCR}\#}(\{a\}) = 0.811 \quad \text{and} \quad m_{\text{PCR}\#}(\{b\}) = 0.189.$$

It is noticed that $z = 0$ for this general case of PCR#. Then, the estimate \hat{m} is obtained by the following process, working for any choice of $m_{1:3}$:

1. Repeat from $n = 1$ to $n = N$:
 - a) Generate Y_1 , Y_2 and Y_3 by means of m_1 , m_2 and m_3 respectively,
 - b) If $Y_1 \cap Y_2 \cap Y_3 \neq \emptyset$, then set $X_n = Y_1 \cap Y_2 \cap Y_3$ and return,
 - c) If $(Y_1 \cap Y_2) \cup (Y_1 \cap Y_3) \cup (Y_2 \cap Y_3) \neq \emptyset$, then do:
 - i. For any $\gamma \in C[2|3] = \{\{1, 2\}, \{1, 3\}, \{2, 3\}\}$, do:
 - A. If $\bigcap_{i \in \gamma} Y_i = \emptyset$, then set $\omega_\gamma = 0$,
 - B. Otherwise, set $\omega_\gamma = \prod_{i \in \gamma} m_i(Y_i)$,
 - ii. For any $\gamma \in C[2|3]$, set $\omega_\gamma = \frac{\omega_\gamma}{\sum_{\gamma' \in C[2|3]} \omega_{\text{gamma}'}}$,
 - iii. Choose $\gamma \in C[2|3]$ randomly accordingly to the probability ω ,

iv. Set $X_n = \bigcap_{i \in \gamma} Y_i$

v. return,

d) Otherwise, do:

i. Compute $\omega_i = \frac{m_i(Y_i)}{m_1(Y_1) + m_2(Y_2) + m_3(Y_3)}$,

ii. Choose $k \in \{1, 2, 3\}$ randomly accordingly to the probability ω ,

iii. Set $X_n = Y_k$,

iv. return,

2. For any $X \in G^\Theta$, compute $\hat{m}(X)$ by:

$$\hat{m}(X) = \frac{1}{N} \sum_{n=1}^N I[X_n = X].$$

The following table compares the empirical estimates of m , computed by means of particle clouds of different sizes N :

$\log_{10} N$	1	2	3	4	5	6	7	8	∞
$m(\{a\})$	1	0.77	0.795	0.812	0.812	0.811	0.811	0.811	0.811
$m(\{b\})$	0	0.23	0.205	0.188	0.188	0.189	0.189	0.189	0.189

These results could be compared to DST and PCR6:

- $z_{\text{DST}} = 0.8$ and $m_{\text{DST}}(\{a\}) = 1$,
- $m_{\text{PCR6}}(\{a\}) = 0.391$, $m_{\text{PCR6}}(\{b\}) = 0.341$,
 $m_{\text{PCR6}}(\{a, b\}) = 0.073$, $m_{\text{PCR6}}(\{a, c\}) = 0.195$,

DST produces highly conflicting results, since source 3 conflicts with the other sources. However, there are some partial consensus which allow the answer $\{b\}$. DST is blind to these partial consensus. On the other hand, PCR6 is able to handle hypothesis $\{b\}$, but is too much optimistic and, still, is unable to fuse partial consensus. Consequently, PCR6 is also unable to diagnose the high inconstancy of belief $m_3(\{b\}) = 0.8$.

6.7 Conclusion

This chapter has investigated a new framework for the definition and interpretation of fusion rules of evidences. This framework is based on the new concept of referee function. A referee function models an arbitrament process conditionally to the contributions of several independent sources of information. It has been shown that fusion rules based on the concept of referee functions have a straightforward sampling-based implementation. As a consequence, a referee function has a natural algorithmic interpretation. Owing to the algorithmic nature of referee functions, the

conception of new rules of fusion is made easier and intuitive. Examples of existing fusion rules have been implemented by means of referee functions. Moreover, an example of rule construction has been provided on the basis of an arbitrament algorithm. The new rule is a quite general extension of both PCR6 and Dempster-Shafer rule. This chapter also addresses the issue of fusion rule approximation. There are cases for which the fusion computation is prohibitive. The sampling process implied by the referee function provides a natural method for the approximation and the computation speed-up. There are still many questions and improvements to be addressed. For example, samples regularization techniques may reduce possible samples degeneration thus allowing smaller particles clouds. Some theoretical questions are also pending; especially, the algebraic properties of the referee functions have almost not been studied. However, this preliminary work is certainly promising for future applications.

6.8 References

- [1] F. Dambreville, *Deterministic modal Bayesian Logic: derive the Bayesian inference within the modal logic T*, <http://arxiv.org/abs/math/0701801>
- [2] B.A. Davey, H.A. Priestley, *Introduction to Lattices and Order*, Cambridge University Press, 2002.
- [3] A.P. Dempster, *Upper and Lower probabilities induced by a multivalued mapping*, *Annals of Mathematical Statistics*, vol. 83, pp. 325–339, 1967.
- [4] T. Denoeux, *The cautious rule of combination for belief functions and some extensions*, *International Conference on Information Fusion*, Florence, Italy, 10–13 July 2006.
- [5] D. Dubois, H. Prade, *On the relevance of non-standard theories of uncertainty in modeling and pooling expert opinions*, in *Reliability Engineering and System Safety*, 36 pp 95-107, 1992.
- [6] M.C. Florea, J. Dezert, P. Valin, F. Smarandache and A.L. Jusselme, *Adaptive combination rule and proportional conflict redistribution rule for information fusion*, *COGNITIVE systems with Interactive Sensors*, Paris, France, March 2006.
- [7] B. Ganter, R. Wille, *Formal Concept Analysis: Mathematical Foundations*, Springer-Verlag, 1998.
- [8] E. Lefevre, O. Colot, P. Vannoorenberghe, *Belief functions combination and conflict management*, *Information Fusion Journal*, Elsevier Publisher, Vol. 3, No. 2, pp. 149–162, 2002.
- [9] D. Lewis, *Probability of Conditionals and Conditional Probabilities*, *Philosophical Review*, LXXXV, 3, 297-315, 1976.

- [10] A. Martin, C. Osswald, *A new generalization of the proportional conflict redistribution rule stable in terms of decision*, Applications and Advances of DS_mT for Information Fusion, Book 2, American Research Press Rehoboth, F. Smarandache and J. Dezert, pp. 69–88 2006.
- [11] A. Martin, C. Osswald, *Toward a combination rule to deal with partial conflict and specificity in belief functions theory*, International Conference on Information Fusion, Québec, Canada, 9–12 July 2007.
- [12] A. Papoulis, *Probability, random variables and stochastic processes*, Mc Graw-Hill Book Company, New York, 1965 (1984 reediting).
- [13] G. Shafer, *A mathematical theory of evidence*, Princeton University Press, 1976.
- [14] F. Smarandache, J. Dezert, *Information Fusion Based on New Proportional Conflict Redistribution Rules*, International Conference on Information Fusion, Philadelphia, U.S.A., 25–29 July 2005.
- [15] F. Smarandache, J. Dezert, *Proportional Conflict Redistribution Rules for Information Fusion*, Applications and Advances of DS_mT for Information Fusion, Book 2, American Research Press Rehoboth, F. Smarandache and J. Dezert, pp. 3–68, 2006.
- [16] F. Smarandache, J. Dezert (Editors), *Applications and Advances on DS_mT for Information Fusion (Collected Works)*, American Research Press, June 2006.
<http://www.gallup.unm.edu/~smarandache/DSmT-book2.pdf>
- [17] Ph. Smets, *The Combination of Evidence in the Transferable Belief Model*, IEEE Transactions on Pattern Analysis and Machine Intelligence, vol. 12, no. 5, pp. 447–458, 1990.
- [18] R.R. Yager, *On the Dempster-Shafer Framework and New Combination Rules*, Informations Sciences, vol. 41, pp. 93–137, 1987.

Chapter 7

Implementing general belief function framework with a practical codification for low complexity

Arnaud Martin
ENSIETA E3I2-EA3876,
2 Rue François Verny, 29806 Brest Cedex 9, France.
Arnaud.Martin@ensieta.fr

Abstract: *In this chapter, we propose a new practical codification of the elements of the Venn diagram in order to easily manipulate the focal elements. In order to reduce the complexity, the eventual constraints must be integrated in the codification at the beginning. Hence, we only consider a reduced hyper-power set D_r^\ominus that can be 2^\ominus or D^\ominus . We describe all the steps of a general belief function framework. The step of decision is studied in particular when we have to decide on intersections of the singletons of the discernment space no actual decision functions are easily to use. Hence, two approaches are proposed, an extension of previous one and an approach based on the specificity of the elements on which to decide. The principal goal of this chapter is to provide practical codes of a general belief function framework for the researchers and users needing the belief function theory.*

This work was carried out while the author was visiting DRDC (Defense Research and Development Canada) at Valcatier, Québec, Canada, and is partially supported by the DGA (Délégation Générale pour l'Armement) and by BMO (Brest Métropole Océane).

7.1 Introduction

Today the belief function theory initiated by [6, 26] is recognized to propose one of the more complete theories for human reasoning under uncertainty, and has been applied in many kinds of applications [32]. This theory is based on the use of functions defined on the power set 2^Θ (the set of all the subsets of Θ), where Θ is the set of considered elements (called *discernment space*), whereas the probabilities are defined only on Θ . A *mass function* or *basic belief assignment*, m is defined by the mapping of the power set 2^Θ onto $[0, 1]$ with:

$$\sum_{X \in 2^\Theta} m(X) = 1. \quad (7.1)$$

One element X of 2^Θ , such as $m(X) > 0$, is called *focal element*. The set of focal elements for m is noted \mathcal{F}_m . A mass function where Θ is a focal element, is called a *non-dogmatic* mass functions.

One of the main goals of this theory is the combination of information given by many experts. When this information can be written as a mass function, many combination rules can be used [23]. The first combination rule proposed by Dempster and Shafer is the normalized conjunctive combination rule given for two basic belief assignments m_1 and m_2 and for all $X \in 2^\Theta$, $X \neq \emptyset$ by:

$$m_{\text{DS}}(X) = \frac{1}{1-k} \sum_{A \cap B = X} m_1(A)m_2(B), \quad (7.2)$$

where $k = \sum_{A \cap B = \emptyset} m_1(A)m_2(B)$ is the inconsistency of the combination (generally called conflict).

However the high computational complexity, especially compared to the probability theory, remains a problem for more industrial uses. Of course, higher the cardinality of Θ is, higher the complexity becomes [38]. The combination rule of Dempster and Shafer is *#P*-complete [25]. Moreover, when combining with this combination rule, non-dogmatic mass functions, the number of focal elements can not decrease.

Hence, we can distinguish two kinds of approaches to reduce the complexity of the belief function framework. First we can try to find optimal algorithms in order to code the belief functions and the combination rules based on Möbius transform [18, 33] or based on local computations [28] or to adapt the algorithms to particular mass functions [3, 27]. Second we can try to reduce the number of focal elements by approximating the mass functions [4, 9, 16, 17, 36, 37], that could be particularly important for dynamic fusion.

In practical applications the mass functions contain at first only few focal elements [1, 7]. Hence it seems interesting to only work with the focal elements and not with the entire space 2^Θ . That is not the case in all general developed algorithms [18, 33].

Now if we consider the extension of the belief function theory proposed by [10], the mass function is defined on the extension of the power set into the hyper-power set D^Θ (that is the set of all the disjunctions and conjunctions of the elements of

Θ). This extension can be seen as a generalization of the classical approach (and it is also called DS_mT for Dezert and Smarandache Theory [29, 30]). This extension is justified in some applications such as in [20, 21]. Try to generate D^Θ is not easy and becomes untractable for more than 6 elements in Θ [11].

In [12], a first proposition has been proposed to order elements of hyper-power set for matrix calculus such as [18, 33] made in 2^Θ . But as we said herein, in real applications it is better to only manipulate the focal elements. Hence, some authors propose algorithms considering only the focal elements [9, 15, 22]. In the previous volume [15, 30] have proposed MATLABTM codes for DS_mT hybrid rule. These codes are a preliminary work, but first it is really not optimized for MATLABTM and second have been developed for a dynamic fusion.

MATLABTM is certainly not the best program language to reduce the speed of processing, however most of people using belief functions do it with MATLABTM.

In this chapter, we propose a codification of the focal elements based on a codification of Θ in order to program easily in MATLABTM a general belief function framework working for belief functions defined on 2^Θ but also on D^Θ .

Hence, in the following section we recall a short background of belief function theory. In section 7.3 we introduce our practical codification for a general belief function framework. In this section, we describe all the steps to fuse basic belief assignments in the order of necessity: the codification of Θ , the addition of the constraints, the codification of focal elements, the step of combination, the step of decision, if necessary the generation of a new power set: the *reduced hyper-power set* D_r^Θ and for the display, the decoding. We particularly investigate the step of the decision for the DS_mT. In section 7.5 we give the major part of the MATLABTM codes of this framework.

7.2 Short background on theory of belief functions

In the DS_mT, the mass functions m are defined by the mapping of the hyper-power set D^Θ onto $[0, 1]$ with:

$$\sum_{X \in D^\Theta} m(X) = 1. \quad (7.3)$$

In the more general model, we can add constraints on some elements of D^Θ , that means that some elements can never be focal elements. Hence, if we add the constraints that all the intersections of elements of Θ are impossible (*i.e.* empty) we recover 2^Θ . So, the constraints given by the application can drastically reduce the number of possible focal elements and so the complexity of the framework. On the contrary of the suggestion given by the flowchart on the cover of the book [29] and the proposed codes in [15], we think that the constraints must be integrated directly in the codification of the focal elements of the mass functions as we shown in section 7.3. Hereunder, the hyper-power set D^Θ taking into account the constraints is called the *reduced hyper-power set* and noted D_r^Θ . Hence, D_r^Θ can be D^Θ , 2^Θ , have a cardinality between these two power sets or inferior to these two power sets. So the normality

condition is given by:

$$\sum_{X \in D_r^\Theta} m(X) = 1, \quad (7.4)$$

where we consider less terms in the sum than in the equation (7.3).

Once the mass functions coming from numerous sources are defined, many combination rules are possible (see [5, 20, 23, 31, 35] for recent reviews of the combination rules). Most of the combination rules are based on the conjunctive combination rule, given for mass functions defined on 2^Θ by:

$$m_c(X) = \sum_{Y_1 \cap \dots \cap Y_s = X} \prod_{j=1}^s m_j(Y_j), \quad (7.5)$$

where $Y_j \in 2^\Theta$ is the response of the source j , and $m_j(Y_j)$ the corresponding basic belief assignment. This rule is commutative, associative, not idempotent, and the major problem which the majority of the rules try to resolve is the increase of the belief on the empty set with the number of sources and the cardinality of Θ [19]. Now, in D^Θ without any constraint, there is no empty set, and the conjunctive rule given by the equation (7.5) for all $X \in D^\Theta$ with $Y_j \in D_r^\Theta$ can be used. If we have some constraints, we must transfer the belief $m_c(\emptyset)$ on other elements of the reduced hyper-power set. There is no optimal combination rule, and we cannot achieve this optimality for general applications.

The last step in a general framework for information fusion system is the decision step. The decision is also a difficult task because no measures are able to provide the best decision in all the cases. Generally, we consider the maximum of one of the three functions: credibility, plausibility, and pignistic probability. Note that other decision functions have been proposed [13].

In the context of the DSMT the corresponding generalized functions have been proposed [14, 29]. The generalized credibility Bel is defined by:

$$\text{Bel}(X) = \sum_{Y \in D_r^\Theta, Y \subseteq X, Y \neq \emptyset} m(Y) \quad (7.6)$$

The generalized plausibility Pl is defined by:

$$\text{Pl}(X) = \sum_{Y \in D_r^\Theta, X \cap Y \neq \emptyset} m(Y) \quad (7.7)$$

The generalized pignistic probability is given for all $X \in D_r^\Theta$, with $X \neq \emptyset$ is defined by:

$$\text{GPT}(X) = \sum_{Y \in D_r^\Theta, Y \neq \emptyset} \frac{\mathcal{C}_M(X \cap Y)}{\mathcal{C}_M(Y)} m(Y), \quad (7.8)$$

where $\mathcal{C}_M(X)$ is the DSMT cardinality corresponding to the number of parts of X in the Venn diagram of the problem [14, 29] associated with a model \mathcal{M} . Generally in

2^Θ , the maximum of these functions is taken on the elements in Θ . In this case, with the goal to reduce the complexity we only have to calculate these functions on the singletons. However, first, there exist methods providing decision on 2^Θ such as in [2] and that can be interesting in some application [24], and secondly, the singletons are not the more precise elements on D_r^Θ . Hence, to calculate these functions on the entire reduced hyper-power set could be necessary, but the complexity could not be inferior to the complexity of D_r^Θ and that can be a real problem if there are a few constraints.

7.3 A general belief function framework

We introduce here a practical codification in order to consider all the previous remarks to reduce the complexity:

- only manipulate focal elements,
- add constraints on the focal elements before combination, and so work on D_r^Θ ,
- a codification easy for union and intersection operations with programs such as MATLABTM.

We first give the simple idea of the practical codification for enumerating the distinct parts of the Venn diagram and therefore a codification of the discernment space Θ . Then we explain how simply add the constraints on the distinct elements of Θ and how to do the codification of the focal elements. The subsections 7.3.4 and 7.3.5 show how to combine and decide with this practical codification, giving a particular reflexion on the decision in DSMT. The subsection 7.3.6 presents the generation of D_r^Θ and the subsection 7.3.7 the decoding.

7.3.1 A practical codification

The simple idea of the practical codification is based on the affectation of an integer number in $[1; 2^n - 1]$ to each distinct part of the Venn diagram that contains $2^n - 1$ distinct parts with $n = |\Theta|$. The figures 7.1 and 7.2 illustrate the codification for respectively $\Theta = \{\theta_1, \theta_2, \theta_3\}$ and $\Theta = \{\theta_1, \theta_2, \theta_3, \theta_4\}$ with the code given in section 7.5. Of course other repartitions of these integers are possible.

Hence, for example the element θ_1 is given by the concatenation of 1, 2, 3 and 5 for $|\Theta| = 3$ and by the concatenation of 1, 2, 3, 4, 6, 7, 9 and 12 for $|\Theta| = 4$. We will note respectively $\theta_1 = [1\ 2\ 3\ 5]$ and $\theta_1 = [1\ 2\ 3\ 4\ 6\ 7\ 9\ 12]$ for $|\Theta| = 3$ and for $|\Theta| = 4$, with increasing order of the integers. Hence, Θ is given respectively for $|\Theta| = 3$ and $|\Theta| = 4$ by:

$$\Theta = \{[1\ 2\ 3\ 5], [1\ 2\ 4\ 6], [1\ 3\ 4\ 7]\}$$

and

$$\Theta = \{[1\ 2\ 3\ 4\ 6\ 7\ 9\ 12], [1\ 2\ 3\ 5\ 6\ 8\ 10\ 13], [1\ 2\ 4\ 5\ 7\ 8\ 11\ 14], [1\ 3\ 4\ 5\ 9\ 10\ 11\ 15]\}.$$

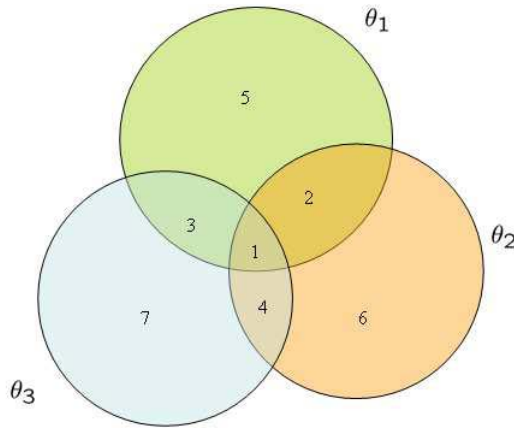

Figure 7.1: Codification for $\Theta = \{\theta_1, \theta_2, \theta_3\}$.

The number of integers for the codification of one element $\theta_i \in \Theta$ is given by:

$$1 + \sum_{i=1}^{n-1} C_{n-1}^i, \tag{7.9}$$

with $n = |\Theta|$ and C_n^p the number of p -uplets with n numbers. The number 1 will be always by convention be the intersection of all the elements of Θ . The codification of $\theta_1 \cap \theta_3$ is given by [1 3] for $|\Theta| = 3$ and [1 2 4 7] for $|\Theta| = 4$. And the codification of $\theta_1 \cup \theta_3$ is given by [1 2 3 4 5 7] for $|\Theta| = 3$ and [1 2 3 4 6 7 9 12] for $|\Theta| = 4$.

In order to reduce the complexity, especially using more hardware language than MATLABTM, we could use binary numbers instead of the integer numbers.

The Smarandache's codification [11], was introduced for the enumeration of distinct parts of a Venn diagram. If $|\Theta| = n$, $\langle i \rangle$ denotes the part of θ_i with no covering with other $\theta_j, i \neq j$. $\langle ij \rangle$ denotes the part of $\theta_i \cap \theta_j$ with no covering with other parts of the Venn diagram. So if $n = 2, \theta_1 \cap \theta_2 = \{\langle 12 \rangle\}$ and if $n = 3, \theta_1 \cap \theta_2 = \{\langle 12 \rangle, \langle 123 \rangle\}$, see the figure 7.3 for an illustration for $n = 3$. The authors note a problem for $n \geq 10$, but if we introduce space in the codification we can conserve integers instead of other symbols and we write $\langle 1 2 3 \rangle$ instead of $\langle 123 \rangle$.

Contrary to the Smarandache's codification, the proposed codification gives only one integer number to each part of the Venn diagram. This codification is more complex for the reader than the Smarandache's codification. Indeed, the reader can understand directly the Smarandache's codification thanks to the meaning of the numbers knowing the n : each disjoint part of the Venn diagram is seen as an inter-

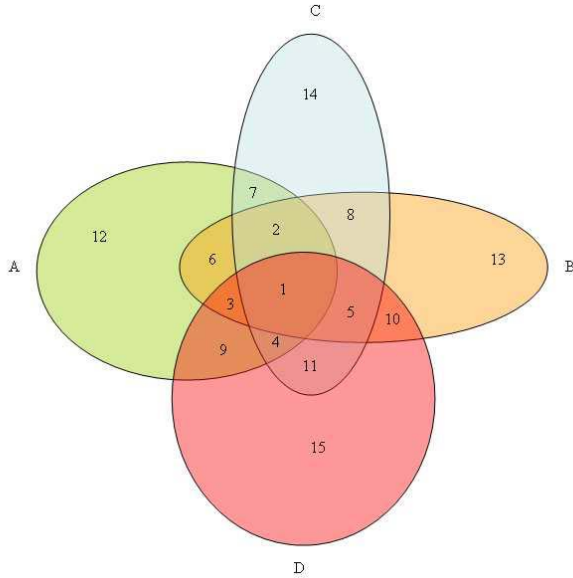

Figure 7.2: Codification for $\Theta = \{\theta_1, \theta_2, \theta_3, \theta_4\}$.

section of the elements of Θ . More exactly, this is a part of the intersections. For example, $\theta_1 \cap \theta_2$ is given with the Smarandache's codification by $\{< 12 >\}$ if $n = 2$ and by $\{< 12 >, < 123 >\}$ if $n = 3$. With the practical codification the same element has also different codification according to the number n . For the previous example $\theta_1 \cap \theta_2$ is given by $[1]$ if $n = 2$, and by $[1\ 2]$ if $n = 3$.

The proposed codification is more practical for computing union and intersection operations and the DSm cardinality, because only one integer represents one of the distinct parts of the Venn diagram. With Smarandache's codification computing union and intersection operations and the DSm cardinality could be very similar than with the practical codification, but adding a routine in order to treat the code of one part of the Venn diagram.

Hence, we propose to use the proposed codification to compute union, intersection and DSm cardinality, and the Smarandache's codification, easier to read, to present the results in order to save eventually a scan of D_r^Θ .

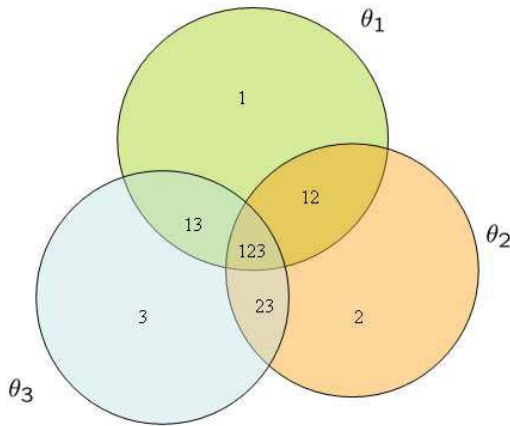

Figure 7.3: Smarandache’s codification for $\Theta = \{\theta_1, \theta_2, \theta_3\}$.

7.3.2 Adding constraints

With this codification, adding constraints is very simple and can reduce rapidly the number of integers. For example assume that in a given application we know $\theta_1 \cap \theta_3 \equiv \emptyset$ (i.e. $\theta_1 \cap \theta_3 \notin D_r^\Theta$), that means that the integers [1 3] for $|\Theta| = 3$ and [1 2 4 7] for $|\Theta| = 4$ do not exist. Hence, the codification of Θ with the reduced discernment space, noted Θ_r , is given respectively for $|\Theta| = 3$ and $|\Theta| = 4$ by:

$$\Theta_r = \{[2\ 5], [2\ 4\ 6], [4\ 7]\}$$

and

$$\Theta_r = \{[3\ 6\ 9\ 12], [3\ 5\ 6\ 8\ 10\ 13], [5\ 8\ 11\ 14], [3\ 5\ 9\ 10\ 11\ 15]\}.$$

Generally we have $|\Theta| = |\Theta_r|$, but it is not necessary if a constraint gives $\theta_i \equiv \emptyset$, with $\theta_i \in \Theta$. This can happen in dynamic fusion, if one element of the discernment space can disappear.

Thereby, the introduction of the simple constraint $\theta_1 \cap \theta_3 \equiv \emptyset$ in Θ , includes all the other constraints that follow from it such as the intersection of all the elements of Θ is empty. In [15] all the constraints must be given by the user.

7.3.3 Codification of the focal elements

In D_r^Θ , the codification of the focal elements is given from the reduced discernment space Θ_r . The codification of an union of two elements of Θ is given by the concatenation of the codification of the two elements using Θ_r . The codification of an

intersection of two elements of Θ is given by the common numbers of the codification of the two elements using Θ_r . In the same way, the codification of an union of two focal elements is given by the concatenation of the codification of the two focal elements and the codification of an intersection of two focal elements is given by the common numbers of the codification of the two focal elements. In fact, for union and intersection operations we only consider one element as the set of the numbers given in its codification.

Hence, with the previous example (we assume $\theta_1 \cap \theta_3 \equiv \emptyset$, with $|\Theta| = 3$ or $|\Theta| = 4$), if the following elements $\theta_1 \cap \theta_2$, $\theta_1 \cup \theta_2$ and $(\theta_1 \cap \theta_2) \cup \theta_3$ are some focal elements, there are coded for $|\Theta| = 3$ by:

$$\begin{aligned}\theta_1 \cap \theta_2 &= [2], \\ \theta_1 \cup \theta_2 &= [2\ 4\ 5\ 6], \\ (\theta_1 \cap \theta_2) \cup \theta_3 &= [2\ 4\ 7],\end{aligned}$$

and for $|\Theta| = 4$ by:

$$\begin{aligned}\theta_1 \cap \theta_2 &= [3\ 6], \\ \theta_1 \cup \theta_2 &= [3\ 5\ 6\ 8\ 9\ 10\ 12\ 13], \\ (\theta_1 \cap \theta_2) \cup \theta_3 &= [3\ 5\ 6\ 8\ 11\ 14].\end{aligned}$$

The DSm cardinality $\mathcal{C}_{\mathcal{M}}(X)$ of one focal element X is simply given by the number of integers in the codification of X . The DSm cardinality of one singleton is given by the equation (7.9), only if there is no constraint on the singleton, and is inferior otherwise.

The previous example with the focal element $(\theta_1 \cap \theta_2) \cup \theta_3$ illustrates well the easiness to deal with the brackets in one expression. The codification of the focal elements can be made with any brackets.

7.3.4 Combination

In order to manage only the focal elements and their associated basic belief assignment, we can use a list structure [9, 15, 22]. The intersection and union operations between two focal elements coming from two mass functions are made as described before. If the intersection between two focal elements is empty the associated codification is $[\]$. Hence the conjunctive combination rule algorithm can be done by algorithm 1. The disjunctive combination rule algorithm is exactly the same by changing \cap in \cup .

Once again, the interest of the codification is for the intersection and union operations. Hence in MATLABTM, we do not need to redefine these operations as in [15].

For more complicated combination rules such as PCR6, we have generally to conserve the intermediate calculus in order to transfer the partial conflict. Algorithms for these rules have been proposed in [22], and MATLABTM codes are given in section 7.5.

Algorithm 1: Conjunctive rule

Data: n experts ex : $ex[1] \dots ex[n]$, $ex[i].focal$, $ex[i].bba$

Result: Fusion of ex by conjunctive rule: $conj$

$extmp \leftarrow ex[1]$;

for $e = 2$ **to** n **do**

$comb \leftarrow \emptyset$;

foreach $foc1$ **in** $extmp.focal$ **do**

foreach $foc2$ **in** $ex[e].focal$ **do**

$tmp \leftarrow extmp.focal(foc1) \cap ex[e].focal(foc2)$;

$comb.focal \leftarrow tmp$;

$comb.bba \leftarrow extmp.bba(foc1) \times ex[e].bba(foc2)$;

 Concatenate same focal in $comb$;

$extmp \leftarrow comb$;

$conj \leftarrow extmp$;

7.3.5 Decision

As we wrote before, we can decide with one of the functions given by the equations (7.6), (7.7), or (7.8). These functions are increasing functions. Hence generally in 2^Θ , the decision is taken on the elements in Θ by the maximum of these functions. In this case, with the goal to reduce the complexity, we only have to calculate these functions on the singletons. However, first, we can provide a decision on any element of 2^Θ such as in [2] that can be interesting in some applications [24], and second, the singletons are not the more precise or interesting elements on D_r^Θ . The figures 7.4 and 7.5 show the DS m cardinality $\mathcal{C}_{\mathcal{M}}(X)$, $\forall X \in D^\Theta$ with respectively $|\Theta| = 3$ and $|\Theta| = 4$. The specificity of the singletons (given by the DS m cardinality) appears at a central position in the set of the specificities of the elements in D^Θ .

Hence, to calculate these decision functions on all the reduced hyper-power set could be necessary, but the complexity could not be inferior to the complexity of D_r^Θ and that can be a real problem. The more reasonable approach is to consider either only the focal elements or a subset of D_r^Θ on which we calculate decision functions.

7.3.5.1 Extended weighted approach

Generally in 2^Θ , the decisions are only made on the singletons [8, 34], and only a few approaches propose a decision on 2^Θ . In order to provide decision on any elements of D_r^Θ , we can first extend the principle of the proposed approach in [2] on D_r^Θ . This approach is based on the weighting of the plausibility with a Bayesian mass function taking into account the cardinality of the elements of 2^Θ .

In a general case, if there is no constraint, the plausibility is not interesting because all elements contain the intersection of all the singletons of Θ . According to

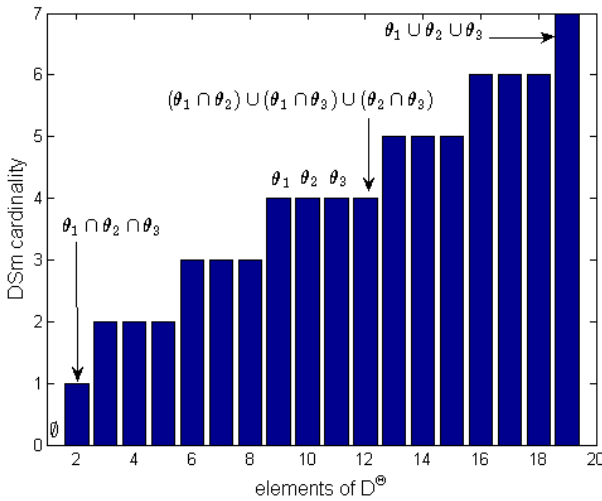

Figure 7.4: DSsm cardinality $\mathcal{C}_{\mathcal{M}}(X), \forall X \in D^\Theta$ with $|\Theta| = 3$.

the constraints the plausibility could be used.

Hence, we generalize here the weighted approach to D_r^Θ for every decision function f_d (plausibility, credibility, pignistic probability, ...). We note f_{wd} the weighted decision function given for all $X \in D_r^\Theta$ by:

$$f_{wd}(X) = m_d(X)f_d(X), \tag{7.10}$$

where m_d is a basic belief assignment given by:

$$m_d(X) = K_d \lambda_X \left(\frac{1}{\mathcal{C}_{\mathcal{M}}(X)^s} \right), \tag{7.11}$$

s is a parameter in $[0, 1]$ allowing a decision from the intersection of all the singletons ($s = 1$) (instead of the singletons in 2^Θ) until the total indecision Θ ($s = 0$). λ_X allows the integration of the lack of knowledge on one of the elements X in D_r^Θ . The constant K_d is the normalization factor giving by the condition of the equation (7.4). Thus we decide the element A :

$$A = \arg \max_{X \in D_r^\Theta} f_{wd}(X), \tag{7.12}$$

If we only want to decide on whichever focal element of D_r^Θ , we only consider $X \in \mathcal{F}_m$ and we decide:

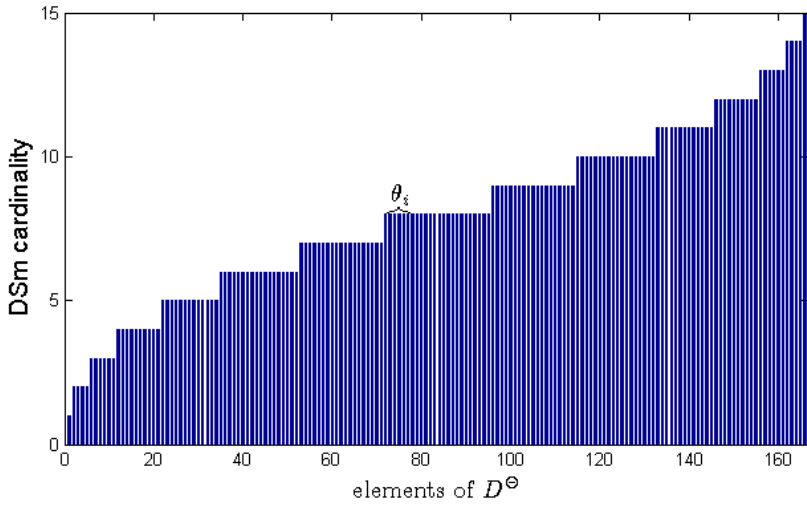

Figure 7.5: DSm cardinality $C_M(X), \forall X \in D^\Theta$ with $|\Theta| = 4$.

$$A = \arg \max_{X \in \mathcal{F}_m} f_{wd}(X), \tag{7.13}$$

with f_{wd} given by the equation (7.10) and:

$$m_d(X) = K_d \lambda_X \left(\frac{1}{C_M(X)^s} \right), \forall X \in \mathcal{F}_m, \tag{7.14}$$

s and K_d are the two parameters defined above.

7.3.5.2 Decision according to the specificity

The cardinality $C_M(X)$ can be seen as a specificity measure of X . The figures 7.4 and 7.5 show that for a given specificity there is different kind of elements such as singletons, unions of intersections or intersections of unions. The figure 7.6 shows well the central role of the singletons (the DSm cardinality of the singletons for $|\Theta|=5$ is 16), but also that there are many other elements (619) with exactly the same cardinality. Hence, it could be interesting to precise the specificity of the elements on which we want to decide. This is the role of s in the Appriou approach. Here we propose to directly give the wanted specificity or an interval of the wanted specificity

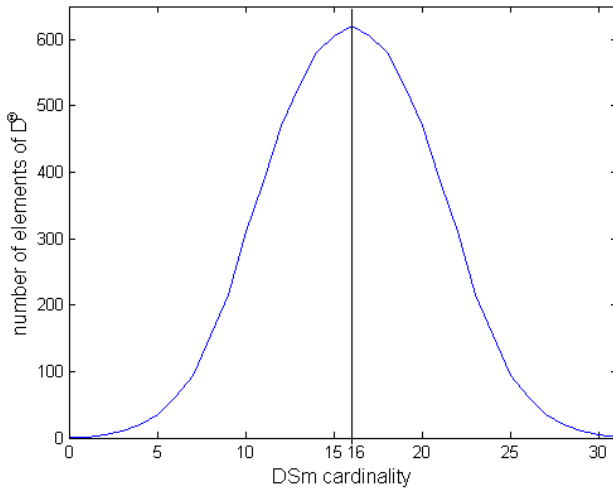

Figure 7.6: Number of elements of D^Θ for $|\Theta| = 5$, with the same DSm cardinality.

in order to build the subset of D_r^Θ on which we calculate decision functions. Thus we decide the element A :

$$A = \arg \max_{X \in \mathcal{S} f_d(X)}, \tag{7.15}$$

where f_d is the chosen decision function (credibility, plausibility, pignistic probability, ...) and

$$\mathcal{S} = \left\{ X \in D_r^\Theta; \min_S \leq \mathcal{C}_M(X) \leq \max_S \right\}, \tag{7.16}$$

with \min_S and \max_S respectively the minimum and maximum of the specificity of the wanted elements. If $\min_S \neq \max_S$, if have to chose a pondered decision function for f_d such as f_{wd} given by the equation (7.10).

However, in order to find all $X \in \mathcal{S}$ we must scan D_r^Θ . To avoid to scan all D_r^Θ , we have to find the cardinality of \mathcal{S} , but we can only calculate an upper bound of the cardinality, unfortunately never reached. Let us define the number of elements of the Venn diagram n_V . This number is given by:

$$n_V = \mathcal{C}_M \left(\bigcup_{i=1}^n \theta_i \right), \tag{7.17}$$

where n is the cardinality of Θ_r and $\theta_i \in \Theta_r$. Recall that the DSm cardinality is simply given by the number of integers of the codification. The upper bound of the cardinality of \mathcal{S} is given by:

$$|\mathcal{S}| < \sum_{s=\min_S}^{\max_S} C_{n_V}^s, \tag{7.18}$$

where $C_{n_V}^s$ is the number of combinations of s elements among n_V . Note that it also works if $\min_S = 0$ for the empty set.

7.3.6 Generation of D_r^Θ

The generation of D_r^Θ could have the same complexity than the generation of D^Θ if there is no constraint given by the user. Today, the complexity of the generation of D^Θ is the complexity of the proposed code in [11]. Assume for example, the simple constraint $\theta_1 \cap \theta_2 \equiv \emptyset$. First, the figures 7.7(a) and 7.7(b) show the DSm cardinality for the elements of D_r^Θ with $|\Theta| = 4$ and the previous given constraint. On the left part of the figure, the elements are ordered by increasing DSm cardinality and on the right part of the figure with the same order as the figure 7.5. We can observe that the cardinality of the elements have naturally decreased and the number of non empty elements also. This is more interesting if the cardinality of Θ is higher. Figure 7.8 presents for a given positive DSm cardinality, the number of elements of D_r^Θ for $|\Theta| = 5$ and with the same constraint $\theta_1 \cap \theta_2 \equiv \emptyset$. Compared to figure 7.6, the total number of non empty elements (the integral of the curve) is considerably lower.

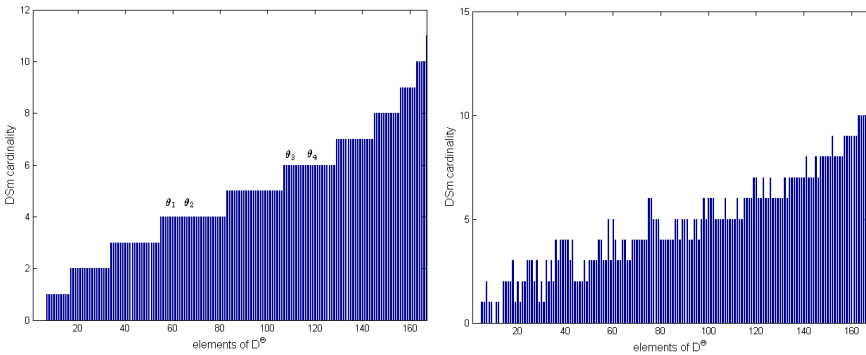

(a) Elements are ordered by increasing DSm cardinality. (b) Elements are ordered with the same order than the figure 7.5.

Figure 7.7: DSm cardinality $\mathcal{C}_{\mathcal{M}}(X)$, $\forall X \in D_r^\Theta$ with $|\Theta| = 4$ and $\theta_1 \cap \theta_2 \equiv \emptyset$.

Thus, we have to generate D_r^\ominus and not D^\ominus . The generation of D^\ominus (see [11] for more details) is based on the generation of monotone boolean functions. A monotone boolean function f_{mb} is a mapping of $(x_1, \dots, x_b) \in \{0, 1\}^b$ to a single binary output such as $\forall x, x' \in \{0, 1\}^b$, with $x \preceq x'$ then $f_{mb}(x) \leq f_{mb}(x')$. Hence, a monotone boolean function is defined by the values of the 2^b elements (x_1, \dots, x_b) , and there is $|D^b|$ different monotone boolean functions. All the values of all these monotone boolean functions can be represented by a $|D^b| \times 2^b$ matrix. If we multiply this matrix by the vector of all the possible intersections of the singletons in Θ with $|\Theta| = b$ (there are 2^b intersections) given an union of intersections, we obtain all the elements of D^\ominus . We can also use the basis of all the unions of Θ (and obtain the intersections of unions), but with our codification the unions are coded with more integer numbers. So, the intersection basis is preferable.

Moreover, if we have some constraints (such as $\theta_1 \cap \theta_2 \equiv \emptyset$), some elements of the intersection basis can be empty. So we only need to generate a $|D^b| \times n_b$ matrix where n_b is the number of non empty intersections of elements in Θ_r . For example, with the constraint given in example for $|\Theta| = 3$, the basis is given by: $\emptyset, \theta_1, \theta_2, \theta_3, \theta_1 \cap \theta_3, \theta_2 \cap \theta_3$, and there are no $\theta_1 \cap \theta_2$ and $\theta_1 \cap \theta_2 \cap \theta_3$.

Hence, the generation of D_r^\ominus can run very fast if the basis is small, *i.e.* if there are some constraints. The MATLABTM code is given in section 7.5.

7.3.7 Decoding

Once the decision on one element A of D_r^\ominus is taken, we have to transmit this decision to the human operator. Hence we must to decode the element A (given by the integer numbers of the codification) in terms of unions and intersections of elements of Θ . If we know that A is in a subset of elements of D_r^\ominus given by the operator, we only have to scan this subset. Now, if the decision A comes from the focal elements (*a priori* unknown) or from all the elements of D_r^\ominus we must scan all D_r^\ominus with possibly high complexity. What we propose here is to consider the elements of D_r^\ominus ordering with first the elements most encountered in applications. Hence, we first scan the elements of 2^\ominus and in the same time the intersection basis that we must build for the generation of D_r^\ominus . Then, only if the element is not found we generate D_r^\ominus and stop the generation when found (see the section 7.5 for more details).

Smarandache's codification is an alternative to the decoding because the user can directly understand it. Hence we can represent the focal element as an union of the distinct part of the Venn diagram. Smarandache's codification allows a clear understanding of the different parts of the Venn diagram unlike the proposed codification. This representation of the results (for the combination or the decision) does not need the generation of D_r^\ominus . However, if we need to generate D_r^\ominus according to the strategy of decision, the decoding will give a better display without more generation of D_r^\ominus .

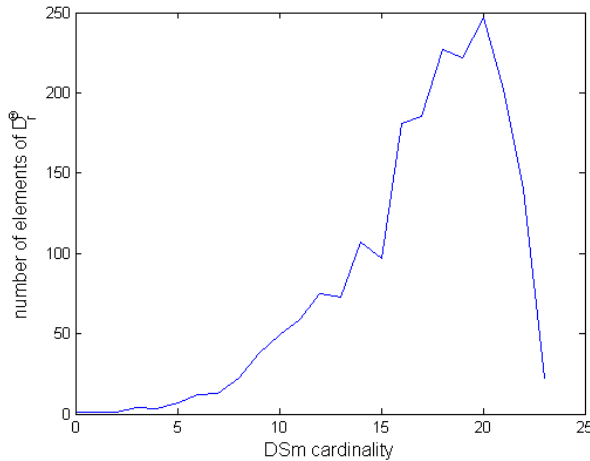

Figure 7.8: Number of elements of D_r^Θ for $|\Theta| = 5$ and $\theta_1 \cap \theta_2 \equiv \emptyset$, with the same positive DS_m cardinality.

7.4 Concluding remarks

This chapter presents a general belief function framework based on a practical codification of the focal elements. First the codification of the elements of the Venn diagram gives a codification of Θ . Then, the eventual constraints are integrated giving a reduced discernment space Θ_r . From the space Θ_r , we obtain the codification of the focal elements. Hence, we manipulate elements of a reduced hyper-power set D_r^Θ and not the complete hyper-power set D^Θ , reducing the complexity according to the kind of given constraints.

With the practical codification, the step of combination is easily made using union and intersection functions.

The step of decision was particularly studied, because of the difficulties to decide on D^Θ or D_r^Θ . An extension of the approach given in [2] in order to give the possibility to decide on the unions in 2^Θ was proposed. Another approach based on the specificity was proposed in order to simply choose the elements on which to decide according to their specificity.

The principal goal of this chapter is to provide practical codes of a general belief function framework for the researchers and users needing the belief function theory. However, for sake of clarity, all the MATLABTM codes are not in the listing, but can be provided on demand to the author. The proposed codes are not optimized either for MATLABTM, or in general and can still have bugs. All suggestions in order to improve them are welcome.

7.5 MATLABTM codes

We give and explain here some MATLABTM codes of the general belief function framework¹. Note that the proposed codes are not optimized either for MATLABTM, or in general.

First the human operator has to describe the problem (see function 1) giving the cardinality of Θ , the list of the focal elements and the corresponding bba for each experts, the eventual constraints (' ' if there is no constraint), the list of elements on which he wants to obtain a decision and the parameters corresponding to the choice of combination rule, the choice of decision criterion the mode of fusion (static or dynamic) and the display. When this is done, he just has to call the fuse function 2.

Function 1. - *Command configuration*

```
% description of the problem
CardTheta=4; % cardinality of Theta
% list of experts with focal elements and associated bba
expert(1).focal={'1' '1u3' '3' '1u2u3'};
expert(1).bba=[0.5421 0.2953 0.0924 0.0702];

expert(2).focal={'1' '2' '1u3' '1u2u3'};
expert(2).bba=[0.2022 0.6891 0.0084 0.1003];

expert(3).focal={'1' '3n4' '1u2u3'};
expert(3).bba=[0.2022 0.6891 0.1087];

constraint={'1n2' '1n3' '2n3'}; % set of empty elements
elemDec={'F'}; % set of decision elements

%-----
% parameters
criterionComb=1; % combination criterion
criterionDec=0; % decision criterion
mode='static'; % mode of fusion
display=3; % kind of display

%-----
% fusion

fuse(expert,constraint,CardTheta,criterionComb,criterionDec,...
mode,elemDec,display)
```

¹Copyright © 2009 Arnaud Martin. May be used free of charge for non commercial products. Selling without prior written consent is prohibited. Obtain permission before redistributing.

The first step of the fuse function 2 is the coding. The cardinality of Θ gives the codification of the singletons of Θ , thanks to the function 3, then we add the constraints to Θ with the function 4 and obtain Θ_r . With Θ_r , the function 6 calling the function 5 codes the focal elements of the experts given by the human operator. The combination is made by the function 7 in static mode. For dynamic fusion, we just consider one expert with the previous combination. In this case the order of the experts given by the user can have an important signification. The decision step is made with the function 11. The last step concerns the display and the hard problem of the decoding. Thus, 4 choices are possible: no display, the results of the combination only, the results of decision only and both results. These displays could take a long time according to the parameters given by the human operator. Hence, the results of the combination could have the complexity of the generation of D_r^Θ and must be avoided if the user does not need it. The complexity of the decision results could also be high if the user does not give the exact set of elements on which to decide, or only the singletons with 'S' or on 2^Θ with '2T'. In other cases, with luck, the execution time can be short thanks to the function 18.

Function 2. - Fuse function

```
function fuse(expert,constraint,n,criterionComb,criterionDec,...
...mode,elemDec,display)

% To fuse experts' opinions
%
% fuse(expert,constraint,n,criterionComb,criterionDec,mode,...
% ...elemDec,display)
%
% Inputs:
% expertC = contains the structure of the list of coded focal
% elements and corresponding bba for all the experts
% constraint = the empty elements
% elemDec = list of elements on which we can decide
% n = size of the discernment space
% criterionComb = is the combination criterion
%       criterionComb=1 Smets criterion
%       criterionComb=2 Dempster-Shafer criterion (normalized)
%       criterionComb=3 Yager criterion
%       criterionComb=4 disjunctive combination criterion
%       criterionComb=5 Florea criterion
%       criterionComb=6 PCR6
%       criterionComb=7 Mean of the bbas
%       criterionComb=8 Dubois criterion (normalized and
%                               disjunctive combination)
%       criterionComb=9 Dubois and Prade criterion
% (mixt combination)
```

```

%         criterionComb=10 Mixt Combination
% (Martin and Osswald criterion)
%         criterionComb=11 DPCR (Martin and Osswald criterion)
%         criterionComb=12 MDPCR (Martin and Osswald criterion)
%         criterionComb=13 Zhang's rule
%
%
% criterionDec = is the combination criterion
%         criterionDec=0 maximum of the bba
%         criterionDec=1 maximum of the pignistic probability
%         criterionDec=2 maximum of the credibility
%         criterionDec=3 maximum of the credibility with reject
%         criterionDec=4 maximum of the plausibility
%         criterionDec=5 Appriou criterion
%         criterionDec=6 DSMP criterion
%
% mode = 'static' or 'dynamic'
% elemDec = list of elements on which we can decide,
%         or A for all, S for singletons only, F for focal elements
%         only, SF for singleton plus focal elements, Cm for given
%         specificity, 2T for only  $2^\Theta$  (DST case)
% display = kind of display
%         display = 0 for no display,
%         display = 1 for combination display,
%         display = 2 for decision display,
%         display = 3 for both displays,
%         display = 4 for both displays with Smarandache
%                 codification
%
% Output:
% res = contains the structure of the list of focal elements and
% corresponding bbas for the combined experts
%
% Copyright (c) 2008 Arnaud Martin

% Coding
[Theta,Scod]=codingTheta(n);
ThetaRed=addConstraint(constraint,Theta);

expertCod=codingExpert(expert,ThetaRed);

%-----
switch nargin
    case 1:5

```

```

        mode='static';
        elemDec=ThetaRed;
        display=4;
    case 6
        elemDec=ThetaRed;
        display=4;
    case 7
        elemDec=string2code(elemDec);
        display=4;
end
%-----
if (display==1) || (display==2) || (display==3)
    [DThetar,D_n]=generationDThetar(ThetaRed);
else
    switch elemDec{1}
        case {'A'}
            [DThetar,D_n]=generationDThetar(ThetaRed);
        otherwise
            DThetar.s={ []};
            DThetar.c={ []};
    end
end
%-----

% Combination
if strcmp(mode, 'static')
    [expertComb]=combination(expertCod,ThetaRed,criterionComb);
else % dynamic case
    nbexp=size(expertCod,2);
    expertTmp(1)=expertCod(1);
    for exp=2:nbexp
        expertTmp(2)=expertCod(exp);
        expertTmp(1)=combination(expertTmp,ThetaRed,...
            ...criterionComb);
    end
    expertComb=expertTmp(1);
end

% Decision
[decFocElem]=decision(expertComb,ThetaRed,DThetar.c,...
    ...criterionDec,elemDec);

% Display
switch display

```

```

case 0
    'no display'
case 1
    % Result of the combination
    sFocal=size(expertComb.focal,2);
    focalRec=decodingExpert(expertComb,ThetaRed,DThetar);
    focal=code2string(focalRec)
    for i=1:sFocal
        disp ( [ focal{i},'=',num2str(expertComb.bba(i)) ] )
    end
case 2
    % Result of the decision
    if isstruct(decFocElem)
        focalDec=decodingFocal(decFocElem.focal,elemDec,...
            ...ThetaRed);
        disp(['decision:',code2string(focalDec)])
    else
        if decFocElem==0
            disp(['decision: rejected'])
        else
            if decFocElem==-1
                disp(['decision: cannot be taken'])
            end
        end
    end
case 3
    % Result of the combination
    sFocal=size(expertComb.focal,2);
    expertDec=decodingExpert(expertComb,ThetaRed,DThetar);
    focal=code2string(expertDec.focal)
    for i=1:sFocal
        disp ( [ focal{i},'=',num2str(expertDec.bba(i)) ] )
    end
    % Result of the decision
    if isstruct(decFocElem)
        focalDec=decodingFocal(decFocElem.focal,elemDec,...
            ...ThetaRed,DThetar);
        disp(['decision:',code2string(focalDec)])
    else
        if decFocElem==0
            disp(['decision: rejected'])
        else
            if decFocElem==-1
                disp(['decision: cannot be taken'])
            end
        end
    end

```

```

        end
    end
end
case 4
% Results with Smarandache codification display
% Result of the combination
sFocal=size(expertComb.focal,2);
expertDec=cod2ScodExpert(expertComb,Scod);
for i=1:sFocal
    disp ([expertDec.focal{i},'=',...
        ...num2str(expertDec.bba(i))])
end
% Result of the decision
if isstruct(decFocElem)
    focalDec=cod2ScodFocal(decFocElem.focal,Scod);
    disp(['decision:',focalDec])
else
    if decFocElem==0
        disp(['decision: rejected'])
    else
        if decFocElem==-1
            disp(['decision: cannot be taken'])
        end
    end
end
end
otherwise
    'Accident in fuse: choice of display is uncorrect'
end

```

7.5.1 Codification

The codification is based on the function 3. The order of the integer numbers could be different, here the choice is made to number the intersection of all the elements with 1 and the smallest integer among the $|\Theta| = n$ bigger integers for the first singleton. At the same time this function gives the correspondence between the integer numbers of the practical codification and Smarandache's codification. This function 3 is based on the MATLABTM function *nchoosek(tab,k)* given the array of all the combination of k elements of the vector *tab*. If the length of *tab* is n , this function return an array of C_n^k rows and k columns.

Function 3. - *codingTheta function*

```
function [Theta,Scod]=codingTheta(n)
```



```

% Code Theta for DSMT framework
%
% [Theta,Scod]=codingTheta(n)
%
% Input:
% n = cardinality of Theta
%
% Outputs:
% Theta = the list of coded elements in Theta
% Scod = the bijection function between the integer of
% the coded elements in Theta and the Smarandache codification
%
% Copyright (c) 2008 Arnaud Martin

i=2^n-1;
tabInd=[];
for j=n:-1:1
    tabInd=[tabInd j];
    Theta{j}=[i];

    Scod{i}=[j];
    i=i-1;
end

i=i+1;
for card=2:n
    tabPerm=nchoosek(tabInd,card);
    for j=1:n
        [l,c]=find(tabPerm==j);
        tabi=i.*ones(1,size(l,1));
        Theta{j}=[sort(tabi-l') Theta{j}];
        for nb=1:size(l,1)
            Scod{i-l(nb)}=[Scod{i-l(nb)} j];
        end
    end
    i=i-size(tabPerm,1);
end

```

The addition of the constraints is made in two steps: first the codification of the elements in the list *constraint* is made with the function 5, then the integer numbers in the codification of the constraints are suppressed from the codification of Θ . The function *string2code* is just the translation of the brackets and union and intersection operators in negative numbers (-3 for '(', -4 for ')', -1 for 'U' and -2 for ' \cap ') in order

to manipulate faster integers than strings. This simple function is not provided here.

Function 4. - *addConstraint function*

```
function [ThetaR]=addConstraint(constraint,Theta)

% Code ThetaR the reduced form of Theta
% taking into account the constraints given by the user
%
% [ThetaR]=addConstraint(constraint,Theta)
%
% Inputs:
% constraint = the list of element considered as constraint
%             or '2T' to work on 2^Theta
% Theta = the description of Theta after coding
%
% Output:
% ThetaR = the description of coded Theta after reduction
% taking into account the constraints
%
% Copyright (c) 2008 Arnaud Martin

if strcmp(constraint{1}, '2T')
    n=size(Theta,2);
    nbCons=1;
    for i=1:n
        for j=i+1:n
            constraint(nbCons)=[i -2 j];
            nbCons=nbCons+1;
        end
    end
else
    constraint=string2code(constraint);
end

constraintC=codingFocal(constraint,Theta);

sConstraint=size(constraintC,2);
unionCons=[];
for i=1:sConstraint
    unionCons=union(unionCons,constraintC{i});
end

sTheta=size(Theta,2);
```

```

for i=1:sTheta
    ThetaR{i}=setdiff(Theta{i},unionCons);
end

```

The function 5 simply transforms the list of focal elements given by the user with the codification of Θ to obtain the list of constraints and with Θ_r for the focal elements of each expert. The function 6 prepares the coding of focal elements and returns the list of the experts with the coded focal elements.

Function 5. - *codingFocal function*

```

function [focalC]=codingFocal(focal,Theta)

% Code the focal element for DSMT framework
%
% [focalC]=codingFocal(focal,Theta)
%
% Inputs:
% focal = the list of focal element for one expert
% Theta = the description of Theta after coding
%
% Output:
% focalC = the list of coded focal element for one expert
%
% Copyright (c) 2008 Arnaud Martin

nbfoc=size(focal,2);
if nbfoc
    for foc=1:nbfoc
        elemC=treat(focal{foc},Theta);
        focalC{foc}=elemC;
    end
else
    focalC={[]};
end
end

%%
function [elemE]=eval(oper,a,b)

if oper==-2
    elemE=intersect(a,b);
else
    elemE=union(a,b);
end

```

```

end

%%
function [elemC,cmp]=treat(focal,Theta)

nbelem=size(focal,2);
PelemC=0;
oper=0;
e=1;
if nbelem
    while e <= nbelem
        elem=focal(e);
        switch elem
            case -1
                oper=-1;
            case -2
                oper=-2;
            case -3
                [elemC,nbe]=treat(focal(e+1:end),Theta);
                e=e+nbe;

                if oper~=0 & ~isequal(PelemC,0)
                    elemC=eval(oper,PelemC,elemC);
                    oper=0;
                end
                PelemC=elemC;

            case -4
                cmp=e;
                e=nbelem;
            otherwise
                elemC=Theta{elem};
                if oper~=0 & ~isequal(PelemC,0)
                    elemC=eval(oper,PelemC,elemC);
                    oper=0;
                end
                PelemC=elemC;
        end
        e=e+1;
    end
else
    elemC=[];
end
end

```

Function 6. - *codingExpert function*

```
function [expertC]=codingExpert(expert,Theta)

% Code the focal element for DSMT framework
%
% [expertC]=codingExpert(expert,Theta)
%
% Inputs:
% expert = structure containing the list of focal elements for
%         each expert and the bba corresponding
% Theta = the description of Theta after coding
%
% Output:
% expertC = structure containing the list of coded focal element
%          for each expert and the bba corresponding
%
% Copyright (c) 2008 Arnaud Martin

    nbExp=size(expert,2);
    for exp=1:nbExp
        focal=string2code(expert(exp).focal);
        expertC(exp).focal=codingFocal(focal,Theta);
        expertC(exp).bba=expert(exp).bba;
    end
end
```

7.5.2 Combination

The function 7 proposes many combination rules. Most of them are based on the function 8, but for some combination rules we need to keep more information, so we use the function 9 for the conjunctive combination. *E.g.* in the function 10 note the simplicity of the code for the PCR6 combination rule. The codes for other combination rules are not given here for the sake of clarity.

Function 7. - *combination function*

```
function [res]=combination(expertC,ThetaR,criterion)

% Give the combination of many experts
%
% [res]=combination(expert,constraint,n,criterion)
%
% Inputs:
```

```

% expertC = contains the structure of the list of focal elements
%           and corresponding bba for all the experts
% ThetaR = the coded and reduced discernment space
% criterion = is the combination criterion
%   criterion=1 Smets criterion (conjunctive rule in open world)
%   criterion=2 Dempster-Shafer criterion (normalized)
%               (conjunctive rule in closed world)
%   criterion=3 Yager criterion
%   criterion=4 disjunctive combination criterion
%   criterion=5 Florea criterion
%   criterion=6 PCR6
%   criterion=7 Mean of the bbas
%   criterion=8 Dubois criterion
%               (normalized and disjunctive combination)
%   criterion=9 Dubois and Prade criterion (mixt combination)
%   criterion=10 Mixt Combination (Martin and Osswald criterion)
%   criterion=11 DPCR (Martin and Osswald criterion)
%   criterion=12 MDPCR (Martin and Osswald criterion)
%   criterion=13 Zhang's rule
%
% Output:
% res = contains the structure of the list of focal elements and
%       corresponding bbas for the combined experts
%
% Copyright (c) 2008 Arnaud Martin

```

```

switch criterion
  case 1
    %Smets criterion
    res=conjunctive(expertC);
  case 2
    %Dempster-Shafer criterion (normalized)
    expConj=conjunctive(expertC);
    ind=findreqcell(expConj.focal, []);
    if ~isempty(ind)
      k=expConj.bba(ind);
      expConj.bba=expConj.bba/(1-k);
      expConj.bba(ind)=0;
    end
    res=expConj;
  case 3
    %Yager criterion
    expConj=conjunctive(expertC);
    ind=findreqcell(expConj.focal, []);

```

```

if ~isempty(ind)
    k=expConj.bba(ind);
    eTheta=ThetaR{1};
    for i=2:n
        eTheta=[union(eTheta,ThetaR{i})];
    end
    indTheta=findeqcell(expConj.focal,eTheta);
    if ~isempty(indTheta)
        expConj.bba(indTheta)=expConj.bba(indTheta)+k;
        expConj.bba(ind)=0;
    else
        sFocal=size(expConj.focal,2);
        expConj.focal(sFocal+1)={eTheta};
        expConj.bba(sFocal+1)=k;
        expConj.bba(ind)=0;
    end
end
res=expConj;
case 4
%disjunctive criterion
[res]=disjunctive(expertC);
case 5
% Florea criterion
expConj=conjunctive(expertC);
expDis=disjunctive(expertC);

ind=findeqcell(expConj.focal, []);
if ~isempty(ind)
    k=expConj.bba(ind);
    alpha=k/(1-k+k*k);
    beta=(1-k)/(1-k+k*k);

    expFlo=expConj;
    expFlo.bba=beta.*expFlo.bba;
    expFlo.bba(ind)=0;
    nbFocConj=size(expConj.focal,2);
    nbFocDis=size(expDis.focal,2);

    expFlo.focal(nbFocConj+1:nbFocConj+nbFocDis)=...
    ...expDis.focal;
    expFlo.bba(nbFocConj+1:nbFocConj+nbFocDis)=...
    ...alpha.*expDis.bba;

    expFlo=reduceExpert(expFlo);

```

```

else
    expFlo=expConj;
end
res=expFlo;
case 6
    % PCR6
    [res]=PCR6(expertC);
case 7
    % Means of the bba
    [res]=meanbba(expertC);
case 8
    % Dubois criterion (normalized & disjunctive combination)
    expDis=disjunctive(expertC);

    ind=findeqcell(expDis.focal,[]);
    if ~isempty(ind)
        k=expDis.bba(ind);
        expDis.bba=expDis.bba/(1-k);
        expDis.bba(ind)=0;
    end
    res=expDis;
case 9
    % Dubois and Prade criterion (mixt combination)
    [res]=DP(expertC);
case 10
    % Martin and Osswald criterion (mixt combination)
    [res]=Mix(expertC);
case 11
    % DPCR (Martin and Osswald criterion)
    [res]=DPCR(expertC);
case 12
    % MDPCR (Martin and Osswald criterion)
    [res]=MDPCR(expertC);
case 13
    % Zhang's rule
    [res]=Zhang(expert)

otherwise
    'Accident: in combination choose of criterion: uncorrect'
end

```



```

function [res]=conjunctive(expert)

% Conjunctive Rule
%
% [res]=conjunctive(expert)
%
% Inputs:
% expert = contains the structures of the list of focal elements
% and corresponding bba for all the experts
%
% Output:
% res = is the resulting expert (structure of the list of focal
%       element and corresponding bba)
%
% Copyright (c) 2008 Arnaud Martin

nbexpert=size(expert,2);
for i=1:nbexpert
    nbfocal(i)=size(expert(i).focal,2);
    nbba(i)=size(expert(i).bba,2);
    if nbfocal(i)~=nbba(i)
        'Accident: in conj: the numbers of bba and focal...
        ... element are different'
    end
end

interm=expert(1);
for exp=2:nbexpert
    nbfocalInterm=size(interm.focal,2);
    i=1;
    comb.focal={};
    comb.bba=[];
    for foc1=1:nbfocalInterm
        for foc2=1:nbfocal(exp)
            tmp=intersect(interm.focal{foc1},...
                ...expert(exp).focal{foc2});
            if isempty(tmp)
                tmp=[];
            end
            comb.focal(i)={tmp};
            comb.bba(i)=interm.bba(foc1)*expert(exp).bba(foc2);
            i=i+1;
        end
    end
end
end

```

```

    interm=reduceExpert(comb);
end
res=interm;

```

Function 9. - *globalConjunctive function*

```

function [res,tabInd]=globalConjunctive(expert)

% Conjunctive Rule conserving all the focal elements
% during the combination
%
% [res,tabInd]=globalConjunctive(expert)
%
% Input:
% expert = contains the structures of the list of focal elements
% and corresponding bba for all the experts
%
% outputs:
% res = is the resulting expert (structure of the list of focal
%       element and corresponding bba)
% tabInd = table of the indices given the combination
%
% Copyright (c) 2008 Arnaud Martin

nbexpert=size(expert,2);
for i=1:nbexpert
    nbfocal(i)=size(expert(i).focal,2);
    nbbba(i)=size(expert(i).bba,2);
    if nbfocal(i)~=nbbba(i)
        'Accident: in conj: the numbers of bba and focal...
        ... element are different'
    end
end
interm=expert(1);
tabIndPrev=[1:1:nbfocal(1)];
for exp=2:nbexpert
    nbfocalInterm=size(interm.focal,2);
    i=1;
    comb.focal={};
    comb.bba=[];
    tabInd=[];
    for foc1=1:nbfocalInterm
        for foc2=1:nbfocal(exp)

```

```

        tmp=intersect(interm.focal{foc1},...
        ...expert(exp).focal{foc2});
        tabInd=[tabInd [tabIndPrev(:,foc1);foc2]];
        if isempty(tmp)
            tmp=[];
        end
        comb.focal(i)={tmp};
        comb.bba(i)=interm.bba(foc1)*expert(exp).bba(foc2);
        i=i+1;
    end
end
tabIndPrev=tabInd;
interm=comb;
end
res=interm;

```

Function 10. - *PCR6 function*

```

function [res]=PCR6(expert)

% PCR6 combination rule
%
% [res]=PCR6(expert)
%
% Input:
% expert = contains the structures of the list of focal elements
% and corresponding bba for all the experts
%
% Output:
% res = is the resulting expert (structure of the list of focal
%       element and corresponding bba)
%
% Reference: A. Martin and C. Osswald, ''A new generalization
% of the proportional conflict redistribution rule stable in
% terms of decision,'' Applications and Advances of DSMT for
% Information Fusion, Book 2, American Research Press Rehoboth,
% F. Smarandache and J. Dezert, pp. 69-88 2006.
%
% Copyright (c) 2008 Arnaud Martin

[expertConj,tabInd]=globalConjunctive(expert);

ind=findeqcell(expertConj.focal,[]);

```

```

nbexp=size(tabInd,1);
if ~isempty(ind)
    expertConj.bba(ind)=0;
    sInd=size(ind,2);
    for i=1:sInd
        P=1;
        S=0;
        for exp=1:nbexp
            bbaexp=expert(exp).bba(tabInd(exp,ind(i)));
            P=P*bbaexp;
            S=S+bbaexp;
        end
        for exp=1:nbexp
            expertConj.focal(end+1)=...
                ...expert(exp).focal(tabInd(exp,ind(i)));
            expertConj.bba(end+1)=...
                ...expert(exp).bba(tabInd(exp,ind(i)))*P/S;
        end
    end
end
res=reduceExpert(expertConj);

```

7.5.3 Decision

The function 11 gives the decision on the expert focal element list for the corresponding bba with one of the chosen criterion and on the elements given by the user for the decision. Note that the choices 'A' and 'Cm' for the variable *elemDec* could take a long time because it needs the generation of D_r^{Θ} . This function can call one of the decision functions 13, 14, 15, 16. If any decision is possible on the chosen elements given by *elemDec*, the function returns -1. In case of rejected element, the function returns 0.

Function 11. - decision function

```

function [decFocElem]=decision(expert,Theta,criterion,elemDec)

% Give the decision for one expert
%
% [decFocElem]=decision(expert,Theta,criterion)
%
% Inputs:
% expert = contains the structure of the list of focal elements
%         and corresponding bba for all the experts
% Theta = list of coded (and reduced with constraint) of the

```

```

%           elements of the discernement space
% criterion = is the combination criterion
%   criterion=0 maximum of the bba
%   criterion=1 maximum of the pignistic probability
%   criterion=2 maximum of the credibility
%   criterion=3 maximum of the credibility with reject
%   criterion=4 maximum of the plausibility
%   criterion=5 DSmp criterion
%   criterion=6 Appriou criterion
%   criterion=7 Credibility on DTheta criterion
%   criterion=8 pignistic on DTheta criterion
% elemDec = list of elements on which we can decide,
%   or A for all, S for singletons only, F for focal elements
%   only, SF for singleton plus focal elements, Cm for given
%   specificity, 2T for only  $2^{\text{Theta}}$  (DST case)
%
% Output:
% decFocElem = the retained focal element, 0 in case of reject, -1
%             if the decision cannot be taken on elemDec
%
% Copyright (c) 2008 Arnaud Martin

type=1;
switch elemDec{1}
    case 'S'
        type=0;
        elemDecC=Theta;
        expertDec=expert;
    case 'F'
        elemDecC=expert.focal;
        expertDec=expert;
    case 'SF'
        expertDec=expert;
        n=size(Theta,2);
        for i=1:n
            expertDec.focal{end+1}=Theta{i};
            expertDec.bba(end+1)=0;
        end
        expertDec=reduceExpert(expertDec);
        elemDecC=expertDec.focal;
    case 'Cm'
        sElem=size(elemDec,2);
        switch sElem

```

```

case 2
    minSpe=str2num(elemDec{2});
    maxSpe=minSpe;
case 3
    minSpe=str2num(elemDec{2});
    maxSpe=str2num(elemDec{3});
otherwise
    'Accident in decision: with the option Cm for ...
    ...elemDec give the specificity of decision element ...
    ...(eventually the minimum and the maximum of the ...
    ...desired specificity'
    pause
end

elemDecC=findFocal(Theta,minSpe,maxSpe);
expertDec.focal=elemDecC;

expertDec.bba=zeros(1,size(elemDecC,2));
for foc=1:size(expert.focal,2)
    ind=findcell(elemDecC,expert.focal{foc});
    if ~isempty(ind)
        expertDec.bba(ind)=expert.bba(foc);
    else
        expertDec.bba(ind)=0;
    end
end

end

case '2T'
    type=0;
    natoms=size(Theta,2);
    expertDec.focal(1)={ [] };
    indFoc=findcell(expert.focal,{ [] });
    if isempty(indFoc)
        expertDec.bba(1)=0;
    else
        expertDec.bba(1)=expert.bba(indFoc);
    end
    step =2;
    for i=1:natoms
        expertDec.focal(step)=codingFocal({[i]},Theta);

        indFoc=findcell(expert.focal,...
            ...expertDec.focal{step});
        if isempty(indFoc)

```

```

        expertDec.bba(step)=0;
    else
        expertDec.bba(step)=expert.bba(indFoc);
    end

    step=step+1;
    indatom=step;
    for step2=2:indatom-2
        expertDec.focal(step)=...
            ...{[union(expertDec.focal{step2},...
                ...expertDec.focal{indatom-1})]};

        indFoc=finddqcell(expert.focal,...
            ...expertDec.focal{step});
        if isempty(indFoc)
            expertDec.bba(step)=0;
        else
            expertDec.bba(step)=expert.bba(indFoc);
        end

        step=step+1;
    end
end
elemDecC=expertDec.focal;
case 'A'
    elemDecC=generationDThetar(Theta);
    elemDecC=reduceFocal(elemDecC);
    expertDec.focal=elemDecC;
    expertDec.bba=zeros(1,size(elemDecC,2));
    for foc=1:size(expert.focal,2)
        expertDec.bba(finddqcell(elemDecC,...
            ...expert.focal{foc}))=expert.bba(foc);
    end
end
otherwise
    type=0;
    elemDec=string2code(elemDec);
    elemDecC=codingFocal(elemDec,Theta);
    expertDec=expert;
    nbElemDec=size(elemDecC,2);
    for foc=1:nbElemDec
        if ~isElem(elemDecC{foc}, expertDec.focal)
            expertDec.focal{end+1}=elemDecC{foc};
            expertDec.bba(end+1)=0;
        end
    end
end

```

```

        end
    end

%-----
nbFocal=size(expertDec.focal,2);
switch criterion

    case 0
        % maximum of the bba
        nbFocal=size(expertDec.focal,2);
        nbElem=0;
        for foc=1:nbFocal
            ind=findqcell(elemDecC,expertDec.focal{foc});
            if ~isempty(ind)
                bba(ind)=expertDec.bba(foc);
            end
        end
        [bbaMax,indMax]=max(bba);
        if bbaMax~=0
            decFocElem.bba=bbaMax;
            decFocElem.focal={elemDecC{indMax}};
        else
            decFocElem=-1;
        end
    case 1
        % maximum of the pignistic probability
        [BetP]=pignistic(expertDec);
        decFocElem=MaxFoc(BetP,elemDecC,type);
    case 2
        % maximum of the credibility
        [Bel]=credibility(expertDec);
        decFocElem=MaxFoc(Bel,elemDecC,type);
    case 3
        % maximum of the credibility with reject
        [Bel]=credibility(expertDec);

        TabSing=[];
        focTheta=[];
        for i=1:size(Theta,2)
            focTheta=union(focTheta,Theta{i});
        end

        for foc=1:nbFocal
            if isElem(Bel.focal{foc}, elemDecC)

```



```

        TabSing=[TabSing [foc ; Bel.Bel(foc)]];
    end

end

[BelMax,indMax]=max(TabSing(2,:));
if BelMax~=0
    focMax=Bel.focal{TabSing(1,indMax)};

    focComplementary=setdiff(focTheta,focMax);
    if isempty(focComplementary)
        focComplementary=[];
    end

    ind=findeqcell(Bel.focal,focComplementary);
    if BelMax < Bel.Bel(ind)
        % if ind is empty this is always false
        decFocElem=0; % That means that we reject
    else
        if isempty(ind)
            decFocElem=0; % That means that we reject
        else
            decFocElem.focal={Bel.focal{TabSing(1,indMax)}};
            decFocElem.Bel=BelMax;
        end
    end
else
    decFocElem=-1; % That means that we reject
end
case 4
    % maximum of the plausibility
    [Pl]=plausibility(expertDec);
    decFocElem=MaxFoc(Pl,elemDecC,type);
case 5
    % DSMP criterion
    epsilon=0.00001; % 0 can allows problem

    [DSMP]=DSMPep(expertDec,epsilon);
    decFocElem=MaxFoc(DSMP,elemDecC,type);
case 6
    % Appriou criterion
    [Pl]=plausibility(expertDec);
    lambda=1;
    r=0.5;
    bm=BayesianMass(expertDec,lambda,r);

```

```

Newbba=Pl.Pl.*bm.bba;
% normalization
Newbba=Newbba/sum(Newbba);
funcDec.focal=Pl.focal;
funcDec.bba=Newbba;
decFocElem=MaxFoc(funcDec,elemDecC,type);
case 7
% Credibility on DTheta criterion
[Bel]=credibility(expertDec);
lambda=1;
r=0.5;
bm=BayesianMass(expertDec,lambda,r);
Newbba=Bel.Bel.*bm.bba;
% normalization
Newbba=Newbba/sum(Newbba);
funcDec.focal=Bel.focal;
funcDec.bba=Newbba;
decFocElem=MaxFoc(funcDec,elemDecC,type);
case 8
% pignistic on DTheta criterion
[BetP]=pignistic(expertDec);
lambda=1;
r=0.5;
bm=BayesianMass(expertDec,lambda,r);
Newbba=BetP.BetP.*bm.bba;
% normalization
Newbba=Newbba/sum(Newbba);
funcDec.focal=BetP.focal;
funcDec.bba=Newbba;
decFocElem=MaxFoc(funcDec,elemDecC,type);
otherwise
'Accident: in decision choose of criterion: uncorrect'
end
end

%%
function [bool]=isElem(focal, listFocal)

% The goal of this function is to return a boolean on the test
% focal in listFocal
%
% [bool]=isElem(focal, listFocal)
%
```

```

% Inputs:
% focal = one focal element (matrix)
% listFocal = the list of elements in Theta (all different)
%
% Output:
% bool = boolean: true if focal is in listFocal, elsewhere false
%
% Copyright (c) 2008 Arnaud Martin

n=size(listFocal,2);
bool=false;
for i=1:n
    if isequal(listFocal{i},focal)
        bool=true;
        break;
    end
end
end

%%
function [decFocElem]=MaxFoc(funcDec,elemDecC,type)

fieldN=fieldnames(funcDec);

switch fieldN{2}
    case 'BetP'
        funcDec.bba=funcDec.BetP;
    case 'Bel'
        funcDec.bba=funcDec.Bel;
    case 'Pl'
        funcDec.bba=funcDec.Pl;
    case 'DSmP'
        funcDec.bba=funcDec.DSmP;

end

if type
    [funcMax,indMax]=max(funcDec.bba);
    FocMax={funcDec.focal{indMax}};
else
    nbFocal=size(funcDec.focal,2);
    TabSing=[];
    for foc=1:nbFocal
        if isElem(funcDec.focal{foc}, elemDecC)

```

```

        TabSing=[TabSing [foc ; funcDec.bba(foc)]];
    end
end
[funcMax,indMax]=max(TabSing(2,:));
FocMax={funcDec.focal{TabSing(1,indMax)}};
end

if funcMax~=0
    decFocElem.focal=FocMax;
    switch fieldN{2}
        case 'BetP'
            decFocElem.BetP=funcMax;
        case 'Bel'
            decFocElem.Bel=funcMax;
        case 'Pl'
            decFocElem.Pl=funcMax;
        case 'DSmP'
            decFocElem.DSmP=funcMax;
    end
else
    decFocElem=-1;
end

end

```

Function 12. - *findFocal function*

```

function [elemDecC]=findFocal(Theta,minSpe,maxSpe)

% Find the element of DTheta with the minium of specificity minSpe
% and the maximum maxSpe
%
% [elemDecC]=findFocal(Theta,minSpe,maxSpe)
%
% Input:
% Theta = list of coded (and eventually reduced with constraint)
%         of the elements of the discernment space
% minSpe = minimum of the wanted specificity
% minSpe = maximum of the wanted specificity
%
% Output:
% elemDec = list of elements on which we want to decide with the
%           minimum of specificity minSpe and the maximum maxSpe

```

```

%
% Copyright (c) 2008 Arnaud Martin

elemDecC{1}=[];

n=size(Theta,2);
ThetaSet=[];
for i=1:n
    ThetaSet=union(ThetaSet,Theta{i});
end
for s=minSpe:maxSpe
    tabs=nchoosek(ThetaSet,s);
    elemDecC(end+1:end+size(tabs,1))=num2cell(tabs,2)';
end

elemDecC=elemDecC(2:end);

```

Function 13. - *pignistic function*

```

function [BetP]=pignistic(expert)

% Generalized Pignistic Transformation
%
% [BetP]=pignistic(expert)
%
% Input:
% expert = contains the structures of the list of focal elements
%          and corresponding bba for all the experts
% expert.focal = list of focal elements
% expert.bba = matrix of bba
%
% Output:
% BetP = contains the structure of the list of focal elements and
%        the matrix of the plausibility corresponding
% BetP.focal = list of focal elements
% BetP.BetP = matrix of the pignistic transformation

% Comment : 1- the code of the focal elements must include
%            the constraints
%            2- The pignistic is given only on the elements
%                in the list of focal of expert (the
%                bba can be 0)
%

```

```

% Copyright (c) 2008 Arnaud Martin

nbFocal=size(expert.focal,2);

BetP.focal=expert.focal;
BetP.BetP=zeros(1,nbFocal);

for focA=1:nbFocal
    for focB=1:nbFocal
        focI=intersect(expert.focal{focA},expert.focal{focB});
        if ~isempty(focI)
            BetP.BetP(focA)=BetP.BetP(focA)+size(focI,2)/...
                ...size(expert.focal{focB},2)*expert.bba(focB);
        else
            if isequal(expert.focal{focB},[])
                % for the empty set:
                % cardinality(empty set)/cardinality(empty set)=1,
                % so we add the bba
                BetP.BetP(focA)=BetP.BetP(focA)+expert.bba(focB);
            end
        end
    end
end
end
end

```

Function 14. - *credibility function*

```

function [Bel]=credibility(expert)

% Credibility function
%
% [Bel]=credibility(expert)
%
% Input:
% expert = contains the structures of the list of focal elements
%          and corresponding bba for all the experts
% expert.focal = list of focal elements
% expert.bba = matrix of bba
%
% Output:
% Bel = contains the structure of the list of focal elements and
%       the matrix of the credibility corresponding
% Bel.focal = list of focal elements
% Bel.Bel = matrix of the credibility

```

```

% Comment : 1- the code of the focal elements must include
%           the constraints
%           2- The credibility is given only on the elements
%           in the list of focal of expert (the
%           bba can be 0)
%
% Copyright (c) 2008 Arnaud Martin

nbFocal=size(expert.focal,2);

Bel.focal=expert.focal;
Bel.Bel=zeros(1,nbFocal);

for focA=1:nbFocal
    for focB=1:nbFocal
        indMem=ismember(expert.focal{focB},expert.focal{focA});
        if sum(indMem)==size(expert.focal{focB},2)...
            && ~isequal(expert.focal{focB},[])
            Bel.Bel(focA)=Bel.Bel(focA)+expert.bba(focB);
        else
            if isequal(expert.focal{focB},[])...
                && isequal(expert.focal{focA},[])
            % the empty set is included to all the focal elements
                Bel.Bel(focA)=Bel.Bel(focA)+expert.bba(focB);
            end
        end
    end
end
end
end

```

Function 15. - *plausibility function*

```

function [Pl]=plausibility(expert)

% Plausibility function
%
% [Pl]=plausibility(expert)
%
% Input:
% expert = contains the structures of the list of focal elements
%         and corresponding bba for all the experts
% expert.focal = list of focal elements
% expert.bba = matrix of bba

```

```

%
% Output:
% Pl = contains the structure of the list of focal elements and
%       the matrix of the plausibility corresponding
% Pl.focal = list of focal elements
% Pl.Pl = matrix of the plausibility

% Comment : 1- the code of the focal elements must include
%            the constraints
%            2- The plausibility is given only on the elements
%                in the list of focal of expert (the
%                bba can be 0)
%
% Copyright (c) 2008 Arnaud Martin

```

```

nbFocal=size(expert.focal,2);
Pl.focal=expert.focal;
Pl.Pl=zeros(1,nbFocal);

for focA=1:nbFocal
    for focB=1:nbFocal
        focI=intersect(expert.focal{focA},expert.focal{focB});
        if ~isempty(focI)
            Pl.Pl(focA)=Pl.Pl(focA)+expert.bba(focB);
        else
            if isequal(expert.focal{focB},[])...
                && isequal(expert.focal{focA},[])
                % for the empty set we keep the bba for the Pl
                Pl.Pl(focA)=Pl.Pl(focA)+expert.bba(focB);
            end
        end
    end
end
end

```

Function 16. - *DSmPep* function

```

function [DSmP]=DSmPep(expert,epsilon)

% DSmP Transformation
%
% [DSmP]=DSmPep(expert,epsilon)
%

```



```

% Inputs:
% expert = contains the structures of the list of focal elements
%           and corresponding bba for all the experts
% expert.focal = list of focal elements
% expert.bba = matrix of bba
% epsilon = epsilon coefficient
%
% Output:
% DSmp = contains the structure of the list of focal elements
%         and the matrix of the plausibility corresponding
% DSmp.focal = list of focal elements
% DSmp.DSmP = matrix of the pignistic transformation
%
% Reference: Dezert & Smarandache, ''A new probabilistic
%           transformation of belief mass assignment'',
%           fusion 2008, Cologne, Germany.
%
% Copyright (c) 2008 Arnaud Martin

nbFocal=size(expert.focal,2);

DSmP.focal=expert.focal;
DSmP.DSmP=zeros(1,nbFocal);

for focA=1:nbFocal
    for focB=1:nbFocal
        focI=intersect(expert.focal{focA},expert.focal{focB});
        sumbbaFocB=0;
        sFocB=size(expert.focal{focB},2);
        for e1B=1:sFocB
            ind=findcell(expert.focal,expert.focal{focB}(e1B));
            if ~isempty(ind)
                sumbbaFocB=sumbbaFocB+expert.bba(ind);
            end
        end
    end
    if ~isempty(focI)
        sumbbaFocI=0;
        sFocI=size(focI,2);
        for e1B=1:sFocI
            ind=findcell(expert.focal,focI(e1B));
            if ~isempty(ind)
                sumbbaFocI=sumbbaFocI+expert.bba(ind);
            end
        end
    end
end

```

```

end
DSmP.DSmP(focA)=DSmP.DSmP(focA)+expert.bba(focB)...
...*(sumbbaFocI+epsilon*sFocI)/...
...*(sumbbaFocB+epsilon*sFocB);
end
end
end

```

7.5.4 Decoding and generation of D_r^\ominus

For the displays, we must decode the focal elements and/or the final decision. The function 17 decodes the focal elements in the structure expert that contains normally only one expert. This function calls the function 18 that really does the decoding for the user. This function is based on the generation of D_r^\ominus given by the function 21 that is a modified and adapted code from [11]. To generate D_r^\ominus we first must create the intersection basis. Hence in the function 18 we use a loop of 2^\ominus in order to generate the basis and at the same time to scan the power set 2^\ominus and also the elements of the intersection basis. These two basis (intersection and union) are in fact concatenated during the construction, so we scan also some elements such as intersections of previous unions and unions of previous intersections. This generated set of elements does not cover D_r^\ominus . When all the searching focal elements (that can be only one decision element) are found, we stop the function and avoid to generate all D_r^\ominus . Hence if the searching elements are not all found after this loop, we begin to generate D_r^\ominus and stop when all elements are found. So, with luck, that can be fast.

We can avoid to generate D_r^\ominus for only the display if we use Smarandache's codification. The function 19 transforms the used code of the focal elements in the structure expert in Smarandache's code, easier to understand by reading. This function calls the function 20 that really does the transformation. The focal elements are directly in string for the display.

Function 17. - *decodingExpert function*

```

function [expertDecod]=decodingExpert(expert,Theta,DTheta)

% The goal of this function is to decode the focal elements in
% expert
%
% [expertDecod]=decodingExpert(expert,Theta)
%
% Inputs:
% expert = contains the structure of the list of focal elements
% after combination and corresponding bba for all the experts
% (generally use for only one after combination)
% Theta = list of coded (and reduced with constraint) of the

```

```

%           elements of the discernement space
% DTheta = list of coded (and reduced with constraint) of the
%           elements of DTheta
%
% Output:
% expertDecod = contains the structure of the list of decoded
%           (for human) focal elements and corresponding bba for
%           all the experts
%
% Copyright (c) 2008 Arnaud Martin

    nbExp=size(expert,2);
    for exp=1:nbExp
        focal=expert(exp).focal;
        expertDecod(exp).focal=decodingFocal(focal,{'A'},Theta,...
            ...DTheta);
        expertDecod(exp).bba=expert(exp).bba;
    end

end

```

Function 18. - *decodingFocal function*

```

function [focalDecod]=decodingFocal(focal,elemDec,Theta,DTheta)

% The goal of this function is to decode the focal elements
%
% [focalDecod]=decodingFocal(focal,elemDec,Theta)
%
% Inputs:
% expert = contains the structure of the list of focal elements
% after combination and corresponding bba for all the experts
% elemDec = the description of the subset of uncoded elements
%           for decision
% Theta = list of coded (and reduced with constraint) of the
%           elements of the discernement space
% DTheta = list of coded (and reduced with constraint) of the
%           elements of DTheta, eventually empty if not necessary
% Output:
% focalDecod = contains the list of decoded (for human) focal
%           elements
%
% Copyright (c) 2008 Arnaud Martin

```

```

switch elemDec{1}
  case {'F','A','SF','Cm'}
    opt=1;
  case 'S'
    opt=0;
    elemDecC=Theta;
    for i=1:size(Theta,2)
      elemDec(i)={i};
    end
  case '2T'
    opt=0;
    natoms=size(Theta,2);
    elemDecC(1)={[]};
    elemDec(1)={[]};
    step =2;
    for i=1:natoms
      elemDecC(step)=codingFocal({[i]},Theta);
      elemDec(step)={[i]};
      step=step+1;
      indatom=step;
      for step2=2:indatom-2
        elemDec(step)={[elemDec{step2} -1 ...
          ...elemDec{indatom-1}]};
        elemDecC(step)={[union(elemDecC{step2},...
          ...elemDecC{indatom-1})]};
        step=step+1;
      end
    end
  end

  otherwise
    opt=0;
    elemDecN=string2code(elemDec);
    elemDecC=codingFocal(elemDecN,Theta);
end

if ~opt
  sFoc=size(focal,2);
  for foc=1:sFoc
    [ind]=findeqcell(elemDecC,focal{foc});
    if isempty(ind)
      'Accident in decodingFocal: elemDec does not be 2T'
      pause
    else

```

```

        focalDecod(foc)=elemDec(ind);
    end
end
else
    focalDecod=cell(size(focal));
    cmp=0;
    sFocal=size(focal,2);
    sDTheta=size(DTheta.c,2);
    i=1;
    while i<sDTheta && cmp<sFocal
        DThetai=DTheta.c{i};
        indeq=findeqcell(focal,DThetai);
        if ~isempty(indeq)
            cmp=cmp+1;
            focalDecod(indeq)=DTheta.s(i);
        end
        i=i+1;
    end
end
end

```

Function 19. - *cod2ScodExpert function*

```

function [expertDecod]=cod2ScodExpert(expert,Scod)

% The goal of this function is to code the focal elements in
% expert with the Smarandache's codification from the practical
% codification in order to display the expert
%
% [expertDecod]=cod2ScodExpert(expert,Scod)
%
% Inputs:
% expert = contains the structure of the list of focal elements
% after combination and corresponding bba for all the experts
% (generally use for only one after combination)
% Scod = list of distinct part of the Venn diagram coded with the
%       Smarandache's codification
% Output:
% expertDecod = contains the structure of the list of decoded
%              (for human) focal elements and corresponding bba
% for all the experts
%
% Copyright (c) 2008 Arnaud Martin

```

```

nbExp=size(expert,2);
for exp=1:nbExp
    focal=expert(exp).focal;
    expertDecod(exp).focal=cod2ScodFocal(focal,Scod);
    expertDecod(exp).bba=expert(exp).bba;
end

end

```

Function 20. - *cod2ScodFocal function*

```

function [focalDecod]=cod2ScodFocal(focal,Scod)

% The goal of this function is to code the focal elements with
% the Smarandache's codification from the practical codification
% in order to display the focal elements
%
% [focalDecod]=cod2ScodFocal(focal,Scod)
%
% Inputs:
% expert = contains the structure of the list of focal elements
%         after combination and corresponding bba for all the experts
% Scod = list of distinct part of the Venn diagram coded with the
%        Smarandache's codification
% Output:
% focalDecod = contains the list of decoded (for human) focal
%             elements
%
% Copyright (c) 2008 Arnaud Martin

sFocal=size(focal,2);
for foc=1:sFocal
    sElem=size(focal{foc},2);
    if sElem==0
        focalDecod{foc}='{}';
    else
        ch='{';
        ch=strcat(ch,'<');
        ch=strcat(ch,num2str(Scod{focal{foc}(1)}));
        ch=strcat(ch,'>>');
        for elem=2:sElem
            ch=strcat(ch,'<');
            ch=strcat(ch,num2str(Scod{focal{foc}(elem)}));

```

```

        ch=strcat(ch,'>');
    end
    focalDecod{foc}=strcat(ch,'');
end
end

```

Function 21. - *generationDThetar function*

```

function [DTheta]=generationDThetar(Theta)

% Generation of DThetar: modified and adapted code from
% Dezert & Smarandache Chapter 2 DSMT book Vol 1
% to generate DTeta
%
% [DTheta]=generationDThetar(Theta)
%
% Input:
% Theta = list of coded (and eventually reduced with constraint)
%         of the elements of the discernment space
%
% Output:
% DTheta = list of coded (and eventually reduced with constraint
%           in this case some elements can be the same) of the
%           elements of the DTheta
%
% Copyright (c) 2008 Arnaud Martin

n=size(Theta,2);
step =1;
for i=1:n
    basetmp(step)={[Theta{i]}};
    step=step+1;
    indatom=step;
    for step2=1:indatom-2
        basetmp(step)={intersect(basetmp{indatom-1},...
            ...basetmp{step2})};
        step=step+1;
    end
end
sBaseTmp=size(basetmp,2);
step=1;
for i=1:sBaseTmp
    if ~isempty(basetmp{i})

```

```

        base(step)=basetmp(i);
        step=step+1;
    end
end
sBase=size(base,2);
DTheta{1}=[];
step=1;
nbC=2;
stop=0;
D_n1 =[0 ; 1];
sDn1=2;
for nn=1:n
    D_n =[ ] ;

    cfirst=1+(nn==n);
    for i =1:sDn1
        Li=D_n1(i,:);
        sLi=size(Li,2);
        if (2*sLi>sBase)&& (Li(sLi-(sBase-sLi))==1)
            stop=1;
            break
        end

        for j=i:sDn1
            Lj=D_n1(j,:);
            if (and(Li,Lj)==Li)&(or(Li,Lj)==Lj)
                D_n=[D_n ; Li Lj ] ;

                if size(D_n,1)>step
                    step=step+1;
                    DTheta{step}=[];
                    for c=cfirst:nbC
                        if D_n(end,c)
                            if isempty(DTheta{step})
                                DTheta{step}=base{sBase+c-nbC};
                            else
                                DTheta{step}=union(DTheta{step},...
                                    ...base{sBase+c-nbC});
                            end
                        end
                    end
                end
            end
        end
    end
end
end
end
end
end

```



```

end
if stop
    break
end
D_n1=D_n;
sDn1=size(D_n1,1);
nbC=2*size(D_n1,2);
end

```

7.6 Acknowledgments

The author thanks Pascal Djiknavorian for the interesting discussion on the generation of D_r^\ominus , Florentin Smarandache for his comments on the codification and Jean Dezert for his advices on the representation of the DSm cardinality $\mathcal{C}_{\mathcal{M}}(X)$.

7.7 References

- [1] A. Appriou, *Uncertain Data Aggregation in Classification an Tracking Process*, in *Aggregation and Fusion of Imperfect Information*, Springer, ed. B. Bouchon-Meunier, pp. 231-260, 1998.
- [2] A. Appriou, *Approche générique de la gestion de l'incertain dans les processus de fusion multisenseur*, *Traitement du signal*, 24(4), pp. 307-319, 2005.
- [3] J.A. Barnett, *Computational methods for a mathematical theory of evidence*, International Joint Conference on Artificial Intelligence (IJCAI), pp. 868-875, Vancouver, Canada, 1981.
- [4] M. Bauer, *Approximation algorithms and decision making in the Dempster-Shafer theory of evidence*, *International Journal of Approximate Reasoning*, 17, pp. 217-237, 1997.
- [5] M. Daniel, *Classical combination rules generalized to DSm hyper-power sets and their comparison with the hybrid DSm rule*, Chap. 3, pp. 89-112, in [?].
- [6] A.P. Dempster, *Upper and Lower probabilities induced by a multivalued mapping*, *Anal. of Mathematical Statistics*, 38, pp. 325-339, 1967.
- [7] T. Denœux, *A k-Nearest Neighbor Classification Rule Based on Dempster-Shafer Theory*, *IEEE Transactions on Systems, Man, and Cybernetics - Part A: Systems and Humans*, 25(5), pp. 804-813, May 1995.
- [8] T. Denœux, *Analysis of evidence-theoretic decision rules for pattern classification*, *Pattern Recognition*, 30(7), pp. 1095-1107, 1997.
- [9] T. Denœux, *Inner and outer approximation of belief structures using a hierarchical clustering approach*, *Int. Journal of Uncertainty, Fuzziness and Knowledge-Based Systems*, 9(4), pp. 437-460, 2001.

- [10] J. Dezert, *Foundations for a new theory of plausible and paradoxical reasoning*, Information & Security: An International Journal, 9, 2002.
- [11] J. Dezert and F. Smarandache, *The generation of the hyper-power sets*, Chap. 2, pp. 37-48, in [29].
- [12] J. Dezert and F. Smarandache, *Partial ordering on hyper-power sets*, Chap. 3, pp. 49-60, in [29].
- [13] J. Dezert and F. Smarandache, *A new probabilistic transformation of belief mass assignment*, In Eleventh International Conference on Information Fusion, Cologne, Germany, July 2008.
- [14] J. Dezert and F. Smarandache and M. Daniel, *The Generalized Pignistic Transformation*, In Seventh International Conference on Information Fusion, Stockholm, Sweden, June 2004.
- [15] P. Djiknavorian and D. Grenier, *Reducing DSMT hybrid rule complexity thought optimisation of the calculation algorithm* Chap. 15, pp. 345-440, in [30].
- [16] R. Haenni and N. Lehmann, *Resource-Bounded and anytime approximation of belief function computations*, International Journal of Approximate Reasoning, 32(1-2), pp. 103-154, 2002.
- [17] R. Haenni and N. Lehmann, *Implementing belief function computations*, International Journal of Intelligent Systems, Special issue on the Dempster-Shafer theory of evidence, 18(1), pp. 31-49, 2003.
- [18] R. Kennes, *Computational Aspect of the Möbius Transformation of Graphs*, IEEE Transactions on Systems, Man, and Cybernetics - Part A: Systems and Humans, 22(2), pp. 201-223, 1992.
- [19] A. Martin and A.-L. Jousselme and C. Osswald, *Conflict measure for the discounting operation on belief functions*, In International Conference on Information Fusion, Cologne, Germany, July 2008.
- [20] A. Martin and C. Osswald, *Generalized proportional conflict redistribution rule applied to Sonar imagery and Radar targets classification*, Chap. 11, pp. 289-304, in [30].
- [21] A. Martin and C. Osswald, *Human experts fusion for image classification*, Information & Security: An International Journal, Special issue on Fusing Uncertain, Imprecise and Paradoxist Information (DSmT), 2006.
- [22] A. Martin and C. Osswald, *A new generalization of the proportional conflict redistribution rule stable in terms of decision*, Chap. 2, pp. 69-88, in [30].
- [23] A. Martin and C. Osswald, *Toward a combination rule to deal with partial conflict and specificity in belief functions theory*, In International Conference on Information Fusion, Québec, Canada, July 2007.

- [24] A. Martin and I. Quidu, *Decision support with belief functions theory for seabed characterization.*, In International Conference on Information Fusion, Cologne, Germany, July 2008.
- [25] P. Orponen, *Dempster's rule of combination is #P-complete*, Artificial Intelligence, 44, pp. 245-253, 1990.
- [26] G. Shafer, *A mathematical theory of evidence*, Princeton University Press, 1976.
- [27] G. Shafer and R. Logan, *Implementing Dempster's Rule for Hierarchical Evidence*, Artificial Intelligence, 33, pp. 271-298, 1987.
- [28] P.P. Shenoy and G. Shafer, *Propagating belief functions with local computations*, IEEE Expert, 1(3), pp. 43-51, 1986.
- [29] F. Smarandache and J. Dezert (Editors), *Advances and Applications of DSmT for Information Fusion, Collected works, Vol. 1*, Rehoboth, U.S.A., 2004.
- [30] F. Smarandache and J. Dezert (Editors), *Advances and Applications of DSmT for Information Fusion, Collected works, Vol. 2*, Rehoboth, U.S.A., 2006.
- [31] F. Smarandache and J. Dezert, *Proportional conflict redistribution rules for information fusion*, Chap. 1, pp. 3-68, in [30].
- [32] Ph. Smets, *Practical uses of belief functions*, In K.B. Laskey and H. Prade, editors, Fifteenth Conference on Uncertainty in Artificial Intelligence, volume 99, pages 612-621, Stockholm, Sweden, July 1999.
- [33] Ph. Smets, *The application of matrix calculus for belief functions*, International Journal of Approximate Reasoning, 31:130, 2002.
- [34] Ph. Smets, *Decision making in the TBM: the necessity of the pignistic transformation*, International Journal of Approximate Reasoning, 38:133-147, 2005.
- [35] Ph. Smets, *Analyzing the combination of conflicting belief functions*, Information Fusion, 8, pp. 387-412, 2006.
- [36] B. Tessem, *Approximations for efficient computation in the theory of evidence*, Artificial Intelligence, 61, pp. 315-329, 1993.
- [37] F. Voorbraak, *A computationally efficient approximation of Dempster-Shafer theory*, International Journal Man-Machine Studies, 30, pp. 525-536, 1989.
- [38] N. Wilson, *Algorithms for Dempster-Shafer theory*, In D.M. Gabbay and Ph. Smets, editors, Handbook of defeasible reasoning and uncertainty management, volume 5: Algorithms for uncertainty and Defeasible Reasoning, pp. 421-475. Kluwer Academic Publisher, Boston, 2000.

Chapter 8

Fusion of qualitative information using imprecise 2-tuple labels

Xinde Li¹, Xinhan Huang², Jean Dezert³,
Florentin Smarandache⁴, Li Duan²

- 1: Key Lab. of Meas. and Control of CSE, School of Automation,
Southeast Univ., Nanjing, 210096, China.
xindeli@seu.edu.cn)
- 2: Dept. of Contr. Sci. and Eng., Huazhong Univ. of Sci. and Tech.,
Wuhan, Hubei, China.
xhhuang@mail.hust.edu.cn, duanlidragon@126.com
- 3: The French Aerospace Lab., ONERA/DTIM/SIF
29 Av. Division Leclerc, 92320 Châtillon, France.
jean.dezert@onera.fr
- 4: Chair of Math. & Sciences Dept., Univ. of New Mexico,
200 College Road, Gallup, NM 87301, U.S.A.
smarand@unm.edu

Abstract: *In this chapter, Herrera-Martínez' 2-tuple linguistic representation model is extended for combining imprecise qualitative information using fusion rules drawn from Dezert-Smarandache Theory (DSmT) or from Dempster-Shafer Theory (DST) frameworks. The proposed approach preserves the precision and the efficiency of the combination of linguistic information. Some basic operators on imprecise 2-tuple labels are presented. We also give simple examples to show how precise and imprecise qualitative information can be combined for reasoning under uncertainty. It is concluded that DSmT can deal efficiently with both precise and imprecise quantitative and qualitative beliefs, which extends the scope of this theory.*

Acknowledgments: This work was supported by the National Natural Science Foundation of China (No. 60804063).

8.1 Introduction

Qualitative methods for reasoning under uncertainty have gained more and more attention by Information Fusion community, especially by the researchers and system designers working in the development of modern multi-source systems for information retrieval, fusion and management in defense, in robotics and so on. This is because traditional methods based only on quantitative representation and analysis are not able to adequately satisfy the need of the development of science and technology that integrate at higher fusion levels human beliefs and reports in complex systems. Therefore qualitative knowledge representation and analysis become more and more important and necessary in next generations of decision-making support systems.

In 1954, Polya was one of the pioneers to characterize formally the qualitative human reports [15]. Then Zadeh [26–30] made important contributions in this field in proposing a fuzzy linguistic approach to model and to combine qualitative/vague information expressed in natural language. However, since the combination process highly depends on the fuzzy operators chosen, a possible issue has been pointed out by Yager in [25]. In 1994, Wellman developed Qualitative Probabilistic Networks (QPN) based on a Qualitative Probability Language, which relaxed precision in representation and reasoning within the probabilistic framework [24]. Subrahmanian introduced the annotated logics, which was a powerful formalism for classical (i.e. consistent), as well as paraconsistent reasoning in artificial intelligence [11, 22]. QPN and Annotated Logics belong actually to the family of imprecise probability [23] and probability bounds analysis (PBA) approaches [6]. Parsons proposed a Qualitative Evidence Theory (QET) with new interesting qualitative reasoning techniques but his QET unfortunately cannot deal efficiently with complex problems of qualitative information fusion encountered in real world [12–14]. Dubois and Prade proposed a Qualitative Possibility Theory (QPT) in Decision Analysis (DA) for the representation and the aggregation of preferences. QPT was driven by the principle of minimal specificity [4]. They use refined linguistic quantifiers to represent either the possibility distributions which encode a piece of imprecise knowledge about a situation, or to represent the qualitative belief masses over the elements in 2^{Θ} . However, the combination process might produce approximate results because of the finite probabilistic scale of the label set [5]. Hájek et al. in [7] proposed a Qualitative Fuzzy Possibilistic Logic (QFPL) which was used to deal with both uncertainty (possibility) and vagueness (fuzziness). QFPL is different from our qualitative reasoning in DS_mT, though the propositional variables were mapped to a set of values i.e. $\{0, 1/n, 2/n, \dots, 1\}$ similar to 1-tuple linguistic model, since it built modality-free formulas from propositional variables using connectives, i.e. $\wedge, \vee, \rightarrow, \neg$.

The purpose of this chapter is to propose a model of imprecise qualitative belief structures for solving fusion problems for applications and not to compare all previous theoretical approaches. We adopt here a pragmatic point of view in order to deal with poor and imprecise qualitative sources of information since in reality the requirement that precise labels are assigned to every individual hypotheses is often regarded as too restrictive.

Some research works on quantitative imprecise belief structures have been done at the end of nineties by Denœux who proposed a representation model in DST framework for dealing with imprecise belief and plausibility functions, imprecise pignistic probabilities together with the extension of Dempster's rule [1] for combining imprecise belief masses. Within the DSMT framework, Dezert and Smarandache further proposed new interval-valued beliefs operators and generalized *DSm* combination rules from precise belief structures fusion to imprecise/sub-unitary intervals fusion, and more generally, to any set of sub-unitary intervals fusion [17]. In [9], Li proposed a revised version of imprecise division operator and the *Min* and *Max* operators for imprecise belief structures, which can be applied to fuzzy-extended reasoning combination rules. Since all the extensions of belief structures proposed so far in the literature concern only *imprecise quantitative belief structures*, we introduce here for the first time a representation for *imprecise qualitative belief structures*. The representation model presented in this chapter is based on the 2-tuple linguistic labels model developed earlier [8] which offers an acceptable computational complexity by working with a finite reduced/coarse granularity set of linguistic labels [3, 19, 20]. The approach adopted here must be viewed as a particular case of the more theoretical approach based on DSMT Field and Linear Algebra of Refined Labels (DSMT-FLARL) proposed in Chapter 2 in this volume.

The 2-tuple linguistic labels representation allows to take into account some available richer information content (if any), like *less good*, *good enough*, *very good* which is not represented within the 1-tuple linguistic labels representation. It can be interpreted somehow as a remainder technique for linguistic labels. Actually, Herrera and Martínez in [8] were the first to propose a 2-tuple fuzzy linguistic representation model for computing with words (CW) for offering a tractable method for aggregating linguistic information (represented by linguistic variables with equidistant labels) through counting indexes of the corresponding linguistic labels. The advantages of the 2-tuple Linguistic representation of symbolic method over methods based on the extension principle in CW in term of complexity and feasibility have been shown in [8]. In 2007, Li et al. [10] have extended the 1-tuple linguistic representation model to Qualitative Enriched Labels (QEL), denoted $L_i(c_i)$, in the DSMT framework. It must be noted that QEL $L_i(c_i)$ is different from Herrera-Martínez' 2-tuple labels denoted (L_i, σ_i^h) . The difference lies in the fact that σ_i^h expresses a kind of refinement correcting term of the standard linguistic label L_i , whereas c_i of QEL expresses a possible confidence factor one may have on the standard linguistic label L_i . In this work, we use Herrera-Martínez' 2-tuple linguistic representation model and introduce new operators for combining imprecise qualitative belief masses based on it.

This chapter is organized as follows: In section 8.2, we remind briefly the basis of DSMT. In section 8.3, we present some 2-tuple linguistic operators and in section 8.4 we present the fusion rules for precise and imprecise qualitative beliefs in DSMT framework. In section 8.5, we provide examples to show how these operators work for combining 2-Tuple qualitative beliefs. Concluding remarks are then given in 8.6.

8.2 DS_mT for the fusion of beliefs

8.2.1 Basic belief mass

In Dempster-Shafer Theory (DST) framework [16], one considers a frame of discernment $\Theta = \{\theta_1, \dots, \theta_n\}$ as a finite set of n exclusive and exhaustive elements (*i.e.* Shafer's model denoted $\mathcal{M}^0(\Theta)$). The power set of Θ is the set of all subsets of Θ . The cardinality of a power set, if the frame of discernment cardinality $|\Theta| = n$ is 2^n . The power set of Θ is denoted 2^Θ . For example, if $\Theta = \{\theta_1, \theta_2\}$, then $2^\Theta = \{\emptyset, \theta_1, \theta_2, \theta_1 \cup \theta_2\}$. In Dezert-Smarandache Theory (DS_mT) framework [17, 19], one considers $\Theta = \{\theta_1, \dots, \theta_n\}$ as a finite set of n exhaustive elements only (*i.e.* free DS_m-model denoted $\mathcal{M}^f(\Theta)$). Eventually some integrity constraints can be introduced in this free model depending on the nature of problem we have to cope with. The hyper-power set of Θ (*i.e.* the free Dedekind's lattice) denoted D^Θ [17] is defined as:

1. $\emptyset, \theta_1, \dots, \theta_n \in D^\Theta$.
2. If $A, B \in D^\Theta$, then $A \cap B$ and $A \cup B$ belong to D^Θ .
3. No other elements belong to D^Θ , except those obtained by using rules 1 or 2.

If $|\Theta| = n$, then $|D^\Theta| \leq 2^{2^n}$. Since for any finite set Θ , $|D^\Theta| \geq |2^\Theta|$, we call D^Θ the hyper-power set of Θ . For example, if $\Theta = \{\theta_1, \theta_2\}$, then $D^\Theta = \{\emptyset, \theta_1 \cap \theta_2, \theta_1, \theta_2, \theta_1 \cup \theta_2\}$. The free DS_m model $\mathcal{M}^f(\Theta)$ corresponding to D^Θ allows to work with vague concepts which exhibit a continuous and relative intrinsic nature. Such concepts cannot be precisely refined in an absolute interpretation because of the unreachable universal truth. The main differences between DST and DS_mT frameworks are (i) the model on which one works with, (ii) the choice of the combination rule and conditioning rules [17, 19], and (iii) aside working with numerical/quantitative beliefs DS_mT allows to compute directly with words (more exactly to combine qualitative belief masses as we will show in the sequel). Here we use the generic notation G^Θ for denoting either D^Θ (when working in DS_mT with free DS_m model) or 2^Θ (when working in DST with Shafer's model) or any other subset of D^Θ (when working with a DS_m hybrid model).

From any finite discrete frame Θ , we define a quantitative basic belief assignment (bba) as a mapping $m(\cdot) : G^\Theta \rightarrow [0, 1]$ associated to a given body of evidence \mathcal{B} which satisfies

$$m(\emptyset) = 0 \quad \text{and} \quad \sum_{A \in G^\Theta} m(A) = 1 \tag{8.1}$$

8.2.2 Fusion of quantitative beliefs

When the free DS_m model $\mathcal{M}^f(\Theta)$ holds, the pure conjunctive consensus, called DS_m classic rule (DS_mC), is performed on $G^\Theta = D^\Theta$. DS_mC of two independent¹

¹While independence is a difficult concept to define in all theories managing epistemic uncertainty, we consider that two sources of evidence are independent (*i.e.* distinct and

sources associated with bba's $m_1(\cdot)$ and $m_2(\cdot)$ is thus given by $m_{DSmC}(\emptyset) = 0$ and $\forall X \in D^\ominus$ by [17]:

$$m_{DSmC}(X) = \sum_{\substack{X_1, X_2 \in D^\ominus \\ X_1 \cap X_2 = X}} m_1(X_1)m_2(X_2) \tag{8.2}$$

D^\ominus being closed under \cup and \cap operators, $DSmC$ guarantees that $m(\cdot)$ is a proper bba.

When Shafer's model holds, instead of distributing the total conflicting mass onto elements of 2^\ominus proportionally with respect to their masses resulted after applying the conjunctive rule as within Dempster's rule (DS) through the normalization step [16], or transferring the partial conflicts onto partial uncertainties as within $DSmH$ rule [17], we propose to use the Proportional Conflict Redistribution rule no.5 (PCR5) [18, 19] which transfers the partial conflicting masses proportionally to non-empty sets involved in the model according to all integrity constraints. PCR5 rule works for any degree of conflict in $[0, 1]$, for any models (Shafer's model, free DSm model or any hybrid DSm model) and both in DST and DSMT frameworks for static or dynamical fusion problems. The PCR5 rule for two sources is defined by: $m_{PCR5}(\emptyset) = 0$ and $\forall X \in G^\ominus \setminus \{\emptyset\}$

$$m_{PCR5}(X) = m_{12}(X) + \sum_{\substack{Y \in G^\ominus \setminus \{X\} \\ X \cap Y = \emptyset}} \left[\frac{m_1(X)^2 m_2(Y)}{m_1(X) + m_2(Y)} + \frac{m_2(X)^2 m_1(Y)}{m_2(X) + m_1(Y)} \right] \tag{8.3}$$

where each element X , and Y , is in the disjunctive normal form. $m_{12}(X)$ corresponds to the conjunctive consensus on X between the two sources. All denominators are different from zero. If a denominator is zero, that fraction is discarded. No matter how big or small is the conflicting mass, PCR5 mathematically does a better redistribution of the conflicting mass than Dempster's rule and other rules since PCR5 goes backwards on the tracks of the conjunctive rule and redistributes the partial conflicting masses only to the sets involved in the conflict and proportionally to their masses put in the conflict, considering the conjunctive normal form of the partial conflict. PCR5 is quasi-associative and preserves the neutral impact of the vacuous belief assignment. General PCR5 fusion formula and improvement for the combination of $k \geq 2$ sources of evidence can be found in [19] with many detailed examples.

noninteracting) if each leaves one totally ignorant about the particular value the other will take.

8.3 Linguistic models of qualitative beliefs

8.3.1 The 1-tuple linguistic model

In order to compute qualitative belief assignments expressed by pure linguistic labels (i.e. 1-tuple linguistic representation model) over G^\ominus , Smarandache and Dezert have defined in [19] a qualitative basic belief assignment $q_1m(.)$ as a mapping function from G^\ominus into a set of linguistic labels $L = \{L_0, \tilde{L}, L_{n+1}\}$ where $\tilde{L} = \{L_1, \dots, L_n\}$ is a finite set of linguistic labels and where $n \geq 2$ is an integer. For example, L_1 can take the linguistic value “poor”, L_2 the linguistic value “good”, etc. \tilde{L} is endowed with a total order relationship \prec , so that $L_1 \prec L_2 \prec \dots \prec L_n$, where \prec means inferior to, or less (in quality) than, or smaller than, etc. To work on a true closed linguistic set L under linguistic addition and multiplication operators, Smarandache and Dezert extended naturally \tilde{L} with two extreme values $L_0 = L_{\min}$ and $L_{n+1} = L_{\max}$, where L_0 corresponds to the minimal qualitative value and L_{n+1} corresponds to the maximal qualitative value, in such a way that $L_0 \prec L_1 \prec L_2 \prec \dots \prec L_n \prec L_{n+1}$. In the sequel $L_i \in L$ are assumed linguistically equidistant labels such that we can make an isomorphism ϕ_L between $L = \{L_0, L_1, L_2, \dots, L_n, L_{n+1}\}$ and $\{0, 1/(n+1), 2/(n+1), \dots, n/(n+1), 1\}$, defined as $\phi_L(L_i) = i/(n+1)$ for all $i = 0, 1, 2, \dots, n, n+1$.

From the extension of the isomorphism between the set of linguistic equidistant labels and a set of numbers in the interval $[0, 1]$, one can built exact operators on linguistic labels which makes possible the extension of all quantitative fusion rules into their qualitative counterparts [10]. We briefly remind the basic (approximate) qualitative operators² (or q -operators for short) on (1-tuple) linguistic labels:

- q -addition:

$$L_i + L_j = \begin{cases} L_{i+j} & \text{if } i + j < n + 1, \\ L_{n+1} = L_{\max} & \text{if } i + j \geq n + 1. \end{cases} \tag{8.4}$$

The q -addition is an extension of the addition operator on equidistant labels which is given by $L_i + L_j = \frac{i}{n+1} + \frac{j}{n+1} = \frac{i+j}{n+1} = L_{i+j}$.

- q -subtraction:

$$L_i - L_j = \begin{cases} L_{i-j} & \text{if } i \geq j, \\ -L_{j-i} & \text{if } i < j. \end{cases} \tag{8.5}$$

where $-L = \{-L_1, -L_2, \dots, -L_n, -L_{n+1}\}$. The q -subtraction is justified since when $i \geq j$, one has with equidistant labels $L_i - L_j = \frac{i}{n+1} - \frac{j}{n+1} = \frac{i-j}{n+1}$.

- q -multiplication³:

$$L_i \cdot L_j = L_{[(i \cdot j)/(n+1)]}. \tag{8.6}$$

²more approximate q -operators can be found in [3] and new accurate operators are introduced in Chapter 2 of this volume.

³The q -multiplication of two linguistic labels defined here can be extended directly to the multiplication of $n > 2$ linguistic labels. For example the product of three linguistic label will be defined as $L_i \cdot L_j \cdot L_k = L_{[(i \cdot j \cdot k)/(n+1)(n+1)]}$, etc.

where $[x]$ means the closest integer⁴ to x (with $[n + 0.5] = n + 1, \forall n \in \mathbb{N}$). This operator is justified by the approximation of the product of equidistant labels given by $L_i \cdot L_j = \frac{i}{n+1} \cdot \frac{j}{n+1} = \frac{(i \cdot j)/(n+1)}{n+1}$. A simpler approximation of the multiplication, but less accurate (as proposed in [19]) is thus

$$L_i \times L_j = L_{\min\{i,j\}} \tag{8.7}$$

- Scalar multiplication of a linguistic label: Let a be a real number. The multiplication of a linguistic label by a scalar is defined by:

$$a \cdot L_i = \frac{a \cdot i}{n + 1} \approx \begin{cases} L_{[a \cdot i]} & \text{if } [a \cdot i] \geq 0, \\ L_{-[a \cdot i]} & \text{otherwise.} \end{cases} \tag{8.8}$$

- Division of linguistic labels:

a) q -division as an internal operator: Let $j \neq 0$, then

$$L_i/L_j = \begin{cases} L_{[(i/j) \cdot (n+1)]} & \text{if } [(i/j) \cdot (n + 1)] < n + 1, \\ L_{n+1} & \text{otherwise.} \end{cases} \tag{8.9}$$

The first equality in (8.9) is well justified because with equidistant labels, one gets: $L_i/L_j = \frac{i/(n+1)}{j/(n+1)} = \frac{(i/j) \cdot (n+1)}{n+1} \approx L_{[(i/j) \cdot (n+1)]}$.

b) Division as an external operator: \boxtimes . Let $j \neq 0$. We define:

$$L_i \boxtimes L_j = i/j. \tag{8.10}$$

since for equidistant labels $L_i \boxtimes L_j = (i/(n + 1))/(j/(n + 1)) = i/j$.

From the q -operators we now can easily and directly extend all quantitative fusion rules like *DSmC* or PCR5 (8.2) or (8.3) into their qualitative version by replacing classical operators on numbers with linguistic labels defined above. Many detailed examples can be found in [3, 10, 18, 19].

8.3.2 The 1-tuple linguistic enriched model

In order to keep working with a coarse/reduced set of linguistic labels for maintaining a low computational complexity, but for taking into account the confidence one may have on the label value declared by a source, we proposed in [10] a qualitative enriched linguistic representation model denoted by $L_i(c_i)$, where the first component L_i is a classical linguistic label and the second component c_i is an assessment (confidence) value. c_i can be either a numerical supporting degree⁵ in

⁴When working with labels, no matter how many operations we have, the best (most accurate) result is obtained if we do only one approximation, and that one should be just at the very end.

⁵In our previous publication [10], we considered $c_i \in [0, \infty)$ but it seems more natural to take it actually in $[0, 1]$ as in statistics.

$[0, 1]$ or a qualitative supporting degree taken its value in a given (ordered) set X of linguistic labels. When $c_i \in [0, 1]$, $L_i(c_i)$ is called an enriched label of type 1, whereas when $\alpha_i \in X$, $L_i(c_i)$ is called an enriched label of type 2. The (quantitative or qualitative) value c_i characterizes the confidence weight one has when the source declares label L_i for committing its qualitative belief to a given proposition $A \in G^\Theta$. For example with enriched labels of type 1, if the label $L_1 \triangleq L_1(1)$ represents our full confidence in the linguistic variable *Good* declared by the source, $L_1(0.7)$ means that we are a bit less confident (i.e. 70% confident only) in the declaration *Good* provided by the source, etc. With enriched labels of type 2, if one chooses by example $X = \{SC, MC, HC\}$, where elements of X have the following meaning: $SC \triangleq$ "Small Confidence", $MC \triangleq$ "Medium Confidence" and $FC \triangleq$ "Full Confidence", then the enriched label $L_1 \triangleq L_1(FC)$ represents linguistic variable *Good* with the full confidence we grant in this declaration (similarly as $L_1(1)$ for type 1), etc. In [10], we have shown how to work (i.e. how to define new *qe*-operators) and how to combine qualitative beliefs based on this enriched linguistic representation model. The computations are based on an independent derivation mechanism of the 1st and 2nd components of the enriched labels $L_i(c_i)$ because the label L_i and its confidence factor c_i , $i = 1, \dots, n$ do not carry the same intrinsic nature of information.

Herrera-Martínez' approach (i.e. the 2-tuple linguistic model) presented in the next section is totally different as it will be shown. In the 2-tuple linguistic model, one tries to refine the value of the labels in order to deal with a richer/finer information but without regards to the confidence one may have on the (refined/2-tuple) labels. Of course, the enrichment of 2-tuple labels can be easily done following ideas presented in [10].

8.3.3 The precise 2-tuple linguistic model

Herrera and Martínez' (precise) 2-tuple model has been introduced in detail in [8]. Here we denote this model (L_i, σ_i^h) where σ_i^h is chosen in $\Sigma \triangleq [-0.5/(n+1), 0.5/(n+1)]$, $i \in \{1, \dots, \infty\}$. The 2-tuple model can be justified since each distance between two equidistant labels is $1/(n+1)$ because of the isomorphism between L and $\{0, 1/(n+1), \dots, n/(n+1), 1\}$, so that $L_i = i/(n+1)$ for all $i = 0, 1, 2, \dots, n, n+1$. Therefore, we take half to the left and half to the right of each label, i.e. $\sigma_i^h \in \Sigma$. So a 2-tuple equidistant linguistic representation model is used to represent the linguistic information by means of 2-tuple item set $\mathbb{L}(L, \sigma^h)$ with $L = \{L_0, L_1, L_2, \dots, L_n, L_{n+1}\}$ isomorphic to $\{0, 1/(n+1), 2/(n+1), \dots, n/(n+1), 1\}$ and the set of qualitative assessments isomorphic to Σ . This 2-tuple approach is an intricate/hybrid mechanism of derivation using jointly L_i and σ_i^h where σ_i^h is a positive or negative numerical remainder with respect to the labels.

8.3.3.1 Symbolic translation

Let's define the normalized index⁶ $i = \text{round}((n + 1) \times \beta) = [(n + 1) \times \beta]$, with $i \in [0, (n + 1)]$ and $\beta \in [0, 1]$, and the Symbolic Translation $\sigma^h \triangleq \beta - i/(n + 1) \in [-0.5/(n + 1), 0.5/(n + 1)]$. Roughly speaking, the Herrera-Martínez symbolic translation of an assessment linguistic value $(n + 1) \times \sigma_i^h$ is a numerical value that supports the difference of information between the (normalized) index obtained from the fusion rule and its closest value in $\{0, 1, \dots, n + 1\}$.

8.3.3.2 Herrera-Martínez transformations

- $\Delta(\cdot)$: conversion of a numerical value into a 2-tuple

$\Delta(\cdot) : [0, 1] \rightarrow L \times \Sigma$ is defined by [8]

$$\Delta(\beta) = (L_i, \sigma^h) \triangleq \begin{cases} L_i, & i = \text{round}((n + 1) \cdot \beta) \\ \sigma^h = \beta - i/(n + 1), & \sigma^h \in \Sigma \end{cases} \quad (8.11)$$

Thus L_i has the closest index label to β and σ^h is the value of its symbolic translation.

- $\nabla(\cdot)$: conversion of a 2-tuple into a numerical value

The inverse/dual function of $\Delta(\cdot)$ is denoted $\nabla(\cdot)$ and $\nabla(\cdot) : L \times \Sigma \rightarrow [0, 1]$ is defined by

$$\nabla((L_i, \sigma_i^h)) = i/(n + 1) + \sigma_i^h = \beta_i \quad (8.12)$$

8.3.3.3 Main operators on 2-tuples

Let's consider two 2-tuples (L_i, σ_i^h) and (L_j, σ_j^h) , then the following operators are defined as follows.

- Addition of 2-tuples

$$\begin{aligned} (L_i, \sigma_i^h) + (L_j, \sigma_j^h) &\equiv \nabla((L_i, \sigma_i^h) + (L_j, \sigma_j^h)) \\ &= \nabla((L_i, \sigma_i^h)) + \nabla((L_j, \sigma_j^h)) = \beta_i + \beta_j = \beta_z \\ &= \begin{cases} \Delta(\beta_z) & \text{if } \beta_z \in [0, 1] \\ L_{n+1} & \text{otherwise} \end{cases} \end{aligned} \quad (8.13)$$

- Product of 2-tuples

$$\begin{aligned} (L_i, \sigma_i^h) \times (L_j, \sigma_j^h) &\equiv \nabla((L_i, \sigma_i^h) \times (L_j, \sigma_j^h)) \\ &= \nabla((L_i, \sigma_i^h)) \times \nabla((L_j, \sigma_j^h)) = \beta_i \times \beta_j = \beta_p \equiv \Delta(\beta_p) \end{aligned} \quad (8.14)$$

with $\beta_p \in [0, 1]$. It can be proved that 2-tuple addition and product operators are commutative and associative.

⁶where $\text{round}(\cdot)$ is the *rounding* operation denoted $[.]$ in our previous q -operators [10].

- Scalar multiplication of a 2-tuple

$$\begin{aligned} \alpha \cdot (L_i, \sigma_i^h) &\equiv \nabla(\alpha \cdot (L_i, \sigma_i^h)) = \alpha \cdot \nabla((L_i, \sigma_i^h)) \\ &= \alpha \cdot \beta_i = \beta_\gamma \equiv \begin{cases} \Delta(\beta_\gamma) & \beta_\gamma \in [0, 1] \\ L_{n+1} & \text{otherwise} \end{cases} \end{aligned} \quad (8.15)$$

- Division of a 2-tuple by a 2-tuple

Let's consider two 2-tuples (L_i, σ_i^h) and (L_j, σ_j^h) with⁷ $(L_i, \sigma_i^h) < (L_j, \sigma_j^h)$, then the division is defined as

$$\begin{aligned} \frac{(L_i, \sigma_i^h)}{(L_j, \sigma_j^h)} &\equiv \nabla\left(\frac{(L_i, \sigma_i^h)}{(L_j, \sigma_j^h)}\right) = \frac{\nabla((L_i, \sigma_i^h))}{\nabla((L_j, \sigma_j^h))} \\ &= \frac{\beta_i}{\beta_j} = \beta_d \equiv \Delta(\beta_d) \quad \text{with } \beta_d \in [0, 1] \end{aligned} \quad (8.16)$$

If $(L_i, \sigma_i^h) \geq (L_j, \sigma_j^h)$, then

$$\frac{(L_i, \sigma_i^h)}{(L_j, \sigma_j^h)} \equiv \nabla\left(\frac{(L_i, \sigma_i^h)}{(L_j, \sigma_j^h)}\right) = \frac{\nabla((L_i, \sigma_i^h))}{\nabla((L_j, \sigma_j^h))} = \frac{\beta_i}{\beta_j} \geq 1$$

and in such case $\frac{(L_i, \sigma_i^h)}{(L_j, \sigma_j^h)}$ is set to the maximum label, i.e. $\frac{(L_i, \sigma_i^h)}{(L_j, \sigma_j^h)} = (L_{n+1}, 0) \sim L_{n+1}$.

8.3.4 The imprecise 2-tuple linguistic model

Since qualitative belief assignment might be imprecise by expert on some occasions, in order to further combine this imprecise qualitative information, we introduce operators on imprecise 2-tuple labels (i.e. addition, subtraction, product and division, etc.). The definition adopted here is the qualitative extension of the one proposed by Denœux' in [1] for reasoning with (quantitative) Interval-valued Belief Structures (IBS).

Definition 1 (IQBS): Let L_{G^Θ} denotes the set of all qualitative belief structures (i.e. precise and imprecise) over G^Θ . An imprecise qualitative belief structure (IQBS) is defined as a non-empty subset \mathbf{m} from L_{G^Θ} , such that there exist n subsets F_1, \dots, F_n over G^Θ and n qualitative intervals $[a_i, b_i]$, $1 \leq i \leq n$ (with $L_0 \leq a_i \leq b_i \leq L_{n+1}$) such that

$$\begin{aligned} \mathbf{m} &= \{m \in L_{G^\Theta} \mid a_i \leq m(F_i) \leq b_i, 1 \leq i \leq n, \\ &\quad \text{and } m(A) = (L_0, 0), \forall A \notin \{F_1, \dots, F_n\}\} \end{aligned}$$

⁷The comparison operator is defined in [8].

Proposition 1: A necessary and sufficient condition for \mathbf{m} to be non-empty is that $L_0 \leq \sum_{i=1}^n a_i \leq L_{n+1} \leq \sum_{i=1}^n b_i$ because there should be at least a qualitative value $c_i \in [a_i, b_i]$, for each i , such that $\sum_{i=1}^n c_i = L_{n+1}$, i.e. the condition of qualitative normalization of $m(\cdot)$. This is an extension of Dencœux' proposition [1].

In order to combine imprecise qualitative belief structures, we use the operations on sets proposed by Dezert and Smarandache in [2].

8.3.4.1 Addition of imprecise 2-tuple labels

The addition operator is very important in most of combination rules for fusing information in most of belief functions theories (in DST framework, in Smets' Transferable Belief Model (TBM) [21] as well as in DSMT framework). The addition operator for imprecise 2-tuple labels (since every imprecise mass of belief is represented here qualitatively by a 2-tuple label) is defined by:

$$\mathbf{m}_1 \boxplus \mathbf{m}_2 = \mathbf{m}_2 \boxplus \mathbf{m}_1 \triangleq \{x \mid x = s_1 + s_2, s_1 \in \mathbf{m}_1, s_2 \in \mathbf{m}_2\} \tag{8.17}$$

where the symbol $+$ means the addition operator on labels and with

$$\begin{cases} \inf(\mathbf{m}_1 + \mathbf{m}_2) = \inf(\mathbf{m}_1) + \inf(\mathbf{m}_2) \\ \sup(\mathbf{m}_1 + \mathbf{m}_2) = \sup(\mathbf{m}_1) + \sup(\mathbf{m}_2) \end{cases}$$

Special case: if a source of evidence supplies precise information, i.e. \mathbf{m} is a precise 2-tuple, say (L_k, α_k^h) , then

$$(L_k, \sigma_k^h) \boxplus \mathbf{m}_2 = \mathbf{m}_2 \boxplus (L_k, \sigma_k^h) = \{x \mid x = (L_k, \sigma_k^h) + s_2, s_2 \in \mathbf{m}_2\} \tag{8.18}$$

with

$$\begin{cases} \inf((L_k, \sigma_k^h) + \mathbf{m}_2) = (L_k, \sigma_k^h) + \inf(\mathbf{m}_2) \\ \sup((L_k, \sigma_k^h) + \mathbf{m}_2) = (L_k, \sigma_k^h) + \sup(\mathbf{m}_2) \end{cases}$$

Example: if 9 labels are used, i.e. $n = 9$,

$$\begin{aligned} [(L_1, 0.01), (L_3, 0.02)] \boxplus [(L_2, 0.02), (L_5, 0.03)] &= [(L_3, 0.03), (L_9, -0.05)] \\ L_3 \boxplus [(L_2, 0.02), (L_5, 0.03)] &= [(L_5, 0.02), (L_8, 0.03)] \end{aligned}$$

8.3.4.2 Subtraction of imprecise 2-tuple labels

The subtraction operator is defined as follows:

$$\mathbf{m}_1 \boxminus \mathbf{m}_2 \triangleq \{x \mid x = s_1 - s_2, s_1 \in \mathbf{m}_1, s_2 \in \mathbf{m}_2\} \tag{8.19}$$

where the symbol $-$ represents the subtraction operator on labels and with

$$\begin{cases} \inf(\mathbf{m}_1 - \mathbf{m}_2) = \inf(\mathbf{m}_1) - \sup(\mathbf{m}_2) \\ \sup(\mathbf{m}_1 - \mathbf{m}_2) = \sup(\mathbf{m}_1) - \inf(\mathbf{m}_2) \end{cases}$$

When $\sup(\mathbf{m}_1 - \mathbf{m}_2) \leq (L_0, 0)$, one takes $\mathbf{m}_1 \boxminus \mathbf{m}_2 = (L_0, 0)$; If $\inf(\mathbf{m}_1 - \mathbf{m}_2) \leq (L_0, 0)$, $\sup(\mathbf{m}_1 - \mathbf{m}_2) \geq (L_0, 0)$, then $\mathbf{m}_1 \boxminus \mathbf{m}_2 = [(L_0, 0), \sup(\mathbf{m}_1 - \mathbf{m}_2)]$; Otherwise, $\mathbf{m}_1 \boxminus \mathbf{m}_2 = [\inf(\mathbf{m}_1 - \mathbf{m}_2), \sup(\mathbf{m}_1 - \mathbf{m}_2)]$.

Special case: if one of sources of evidence supplies precise information, i.e. \mathbf{m} is a precise 2-tuple, say (L_k, α_k^h) , then

$$(L_k, \sigma_k^h) \boxminus \mathbf{m}_2 = \{x \mid x = (L_k, \sigma_k^h) - s_2, s_2 \in \mathbf{m}_2\} \quad (8.20)$$

with

$$\begin{cases} \inf((L_k, \sigma_k^h) - \mathbf{m}_2) = (L_k, \sigma_k^h) - \sup(\mathbf{m}_2) \\ \sup((L_k, \sigma_k^h) - \mathbf{m}_2) = (L_k, \sigma_k^h) - \inf(\mathbf{m}_2) \end{cases}$$

Similarly,

$$\mathbf{m}_1 \boxminus (L_k, \sigma_k^h) = \{x \mid x = s_1 - (L_k, \sigma_k^h), s_1 \in \mathbf{m}_1\} \quad (8.21)$$

with

$$\begin{cases} \inf(\mathbf{m}_1 - (L_k, \sigma_k^h)) = \inf(\mathbf{m}_1) - (L_k, \sigma_k^h) \\ \sup(\mathbf{m}_1 - (L_k, \sigma_k^h)) = \sup(\mathbf{m}_1) - (L_k, \sigma_k^h) \end{cases}$$

Example: if 9 labels are used, i.e. $n = 9$,

$$\begin{aligned} [(L_2, 0.02), (L_5, 0.03)] \boxminus [(L_1, 0.01), (L_3, 0.02)] &= [(L_0, 0), (L_4, 0.02)] \\ [(L_1, 0.01), (L_3, 0.02)] \boxminus (L_5, 0.03) &= (L_0, 0) \\ L_3 \boxminus [(L_2, 0.02), (L_5, 0.03)] &= [(L_0, 0), (L_1, -0.02)] \end{aligned}$$

8.3.4.3 Multiplication of imprecise 2-tuple labels

The multiplication operator plays also an important role in most of the rules of combinations. The multiplication of imprecise 2-tuple labels is defined as follows:

$$\mathbf{m}_1 \boxtimes \mathbf{m}_2 = \mathbf{m}_2 \boxtimes \mathbf{m}_1 \triangleq \{x \mid x = s_1 \times s_2, s_1 \in \mathbf{m}_1, s_2 \in \mathbf{m}_2\} \quad (8.22)$$

where the symbol \times represents the multiplication operator on labels and with

$$\begin{cases} \inf(\mathbf{m}_1 \times \mathbf{m}_2) = \inf(\mathbf{m}_1) \times \inf(\mathbf{m}_2) \\ \sup(\mathbf{m}_1 \times \mathbf{m}_2) = \sup(\mathbf{m}_1) \times \sup(\mathbf{m}_2) \end{cases}$$

Special case: if one of sources of evidence supplies precise information, i.e. \mathbf{m} is a precise 2-tuple, say (L_k, α_k^h) , then

$$(L_k, \sigma_k^h) \boxtimes \mathbf{m}_2 = \mathbf{m}_2 \boxtimes (L_k, \sigma_k^h) = \{x \mid x = (L_k, \sigma_k^h) \times s_2, s_2 \in \mathbf{m}_2\}$$

with

$$\begin{cases} \inf((L_k, \sigma_k^h) \times \mathbf{m}_2) = (L_k, \sigma_k^h) \times \inf(\mathbf{m}_2) \\ \sup((L_k, \sigma_k^h) \times \mathbf{m}_2) = (L_k, \sigma_k^h) \times \sup(\mathbf{m}_2) \end{cases}$$

Example: if 9 labels are used, i.e. $n = 9$,

$$\begin{aligned} [(L_1, 0.01), (L_3, 0.02)] \boxtimes [(L_2, 0.02), (L_5, 0.03)] &= [(L_0, 0.0242), (L_2, -0.0304)] \\ L_3 \boxtimes [(L_2, 0.02), (L_5, 0.03)] &= [(L_1, -0.034), (L_2, -0.041)] \end{aligned}$$

8.3.4.4 Division of imprecise 2-tuple labels

The division operator is also necessary in some combinations rules (like in Dempster's rule or PCR5 by example). So we propose the following division operator for imprecise 2-tuple labels based on division of sets introduced in [2]:

If $\mathbf{m}_2 \neq (L_0, 0)$, then

$$\mathbf{m}_1 \boxminus \mathbf{m}_2 \triangleq \{x \mid x = s_1 \div s_2, s_1 \in \mathbf{m}_1, s_2 \in \mathbf{m}_2\} \quad (8.23)$$

where the symbol \div represents the division operator on labels and with

$$\begin{cases} \inf(\mathbf{m}_1 \div \mathbf{m}_2) = \inf(\mathbf{m}_1) \div \sup(\mathbf{m}_2) \\ \sup(\mathbf{m}_1 \div \mathbf{m}_2) = \sup(\mathbf{m}_1) \div \inf(\mathbf{m}_2) \end{cases}$$

when $\sup(\mathbf{m}_1) \div \inf(\mathbf{m}_2) \leq L_{n+1}$. Otherwise we take $\sup(\mathbf{m}_1 \div \mathbf{m}_2) = L_{n+1}$.

Special case: if one of sources of evidence supplies precise information, i.e. \mathbf{m} is a precise 2-tuple, say $(L_k, \alpha_k^h) \neq (L_0, 0)$, then

$$(L_k, \sigma_k^h) \boxminus \mathbf{m}_2 = \{x \mid x = (L_k, \sigma_k^h) \div s_2, s_2 \in \mathbf{m}_2\} \quad (8.24)$$

with

$$\begin{cases} \inf((L_k, \sigma_k^h) \div \mathbf{m}_2) = (L_k, \sigma_k^h) \div \sup(\mathbf{m}_2) \\ \sup((L_k, \sigma_k^h) \div \mathbf{m}_2) = (L_k, \sigma_k^h) \div \inf(\mathbf{m}_2) \end{cases}$$

Similarly,

$$\mathbf{m}_1 \boxminus (L_k, \sigma_k^h) = \{x \mid x = s_1 \div (L_k, \sigma_k^h), s_1 \in \mathbf{m}_1\} \quad (8.25)$$

with

$$\begin{cases} \inf(\mathbf{m}_1 \div (L_k, \sigma_k^h)) = \inf(\mathbf{m}_1) \div (L_k, \sigma_k^h) \\ \sup(\mathbf{m}_1 \div (L_k, \sigma_k^h)) = \sup(\mathbf{m}_1) \div (L_k, \sigma_k^h) \end{cases}$$

Example: if 9 labels are used, i.e. $n = 9$,

$$[(L_1, 0.01), (L_3, 0.02)] \boxminus [(L_2, 0.02), (L_5, 0.03)] = [(L_2, 0.0075), (L_{10}, 0)]$$

$$L_3 \boxminus [(L_2, 0.02), (L_5, 0.03)] = [(L_6, -0.034), (L_{10}, 0)]$$

$$[(L_2, 0.02), (L_5, 0.03)] \boxminus L_3 = [(L_7, 0.033), (L_{10}, 0)]$$

8.4 Fusion of qualitative beliefs

8.4.1 Fusion of precise qualitative beliefs

From the 2-tuple linguistic representation model of qualitative beliefs and the previous operators on 2-tuple labels, we are now able to extend the *DSmC*, *PCR5* and even Dempster's (DS) fusion rules into the qualitative domain following the track of

our previous works [3, 10, 19]. We denote $q_2m(\cdot)$ the qualitative belief mass/assignment (qba) based on 2-tuple representation in order to make a difference with the qba $q_1m(\cdot)$ based on 1-tuple (classical/pure) linguistic labels and $q_em(\cdot)$ based on qualitative enriched linguistic labels [10]. Mathematically, $q_2m(\cdot)$ expressed by a given source/body of evidence S is defined as a mapping function $q_2m(\cdot): G^\Theta \rightarrow L \times \alpha$ such that:

$$q_2m(\emptyset) = (L_0, 0) \quad \text{and} \quad \sum_{A \in G^\Theta} q_2m(A) = (L_{n+1}, 0) \tag{8.26}$$

From the expressions of quantitative $DSmC$ (8.2), $PCR5$ (8.3) and Dempster's (DS) [16] fusion rules and from the operators on 2-tuple labels, we can define the classical qualitative combination or proportional redistribution rules (q_2DSmC and q_2PCR5) for dealing with 2-tuple linguistic labels (L_i, α_i) . This is done as follows:

- when working with the free DSm model of the frame Θ : $q_2m_{DSmC}(\emptyset) = (L_0, 0)$ and $\forall X \in D^\Theta \setminus \{\emptyset\}$

$$q_2m_{DSmC}(X) = \sum_{\substack{X_1, X_2 \in D^\Theta \\ X_1 \cap X_2 = X}} q_2m_1(X_1)q_2m_2(X_2) \tag{8.27}$$

- when working with Shafer's or hybrid model of the frame Θ : $q_2m_{PCR5}(\emptyset) = (L_0, 0)$ and $\forall X \in G^\Theta \setminus \{\emptyset\}$

$$q_2m_{PCR5}(X) = q_2m_{12}(X) + \sum_{\substack{Y \in G^\Theta \setminus \{X\} \\ X \cap Y = \emptyset}} \left[\frac{q_2m_1(X)^2 q_2m_2(Y)}{q_2m_1(X) + q_2m_2(Y)} + \frac{q_2m_2(X)^2 q_2m_1(Y)}{q_2m_2(X) + q_2m_1(Y)} \right] \tag{8.28}$$

where $q_2m_{12}(X)$ corresponds to the qualitative conjunctive consensus.

It is important to note that addition, product and division operators involved in formulas (8.27) and (8.28) are 2-tuple operators defined in the previous section. These rules can be easily extended for the qualitative fusion of $k > 2$ sources of evidence. The formulas (8.27) and (8.28) are well justified since every 2-tuple (L_i, α_i) can be mapped into a unique β numerical value corresponding to it which makes the qualitative fusion rules q_2DSmC and q_2PCR5 equivalent to the corresponding numerical fusion rules $DSmC$ and $PCR5$ because of the existence of $\Delta(\cdot)$ transformation.

Theorem 1: (Normalization) If $\sum_{A \in G^\Theta} q_2m(A) = (L_{n+1}, 0)$,

then $\sum_{A \in G^\Theta} q_2m_{DSmC}(A) = (L_{n+1}, 0)$, and $\sum_{A \in G^\Theta} q_2m_{PCR5}(A) = (L_{n+1}, 0)$.

Proof: Let's assume that there is a frame of discernment Θ which includes several focal elements. According to DSm model, one defines its hyper-power set

D^\ominus , $A_i \in D^\ominus$, $i = \{1, 2, \dots, n\}$. There exist k evidential sources with qualitative belief mass a_{ij} , $i \in \{1, 2, \dots, k\}$, $j \in \{1, 2, \dots, n\}$. According to the premise, i.e. $\sum_{A \in G^\ominus} q_2 m(A) = (L_{n+1}, 0)$, that is, $\sum_{j \in \{1, 2, \dots, n\}} a_{ij} = (L_{n+1}, 0)$. According to (8.14) and the characteristics of Product operator,

$$\prod_{i \in \{1, 2, \dots, k\}} \sum_{j \in \{1, 2, \dots, n\}} a_{ij} = \prod_{i \in \{1, 2, \dots, k\}} (L_{n+1}, 0) = (L_{n+1}, 0)$$

because

$$\begin{aligned} q_2 m_{DSmC}(X) &= \sum_{\substack{X_1, X_2, \dots, X_k \in D^\ominus \\ X_1 \cap X_2 \cap \dots \cap X_k = X}} q_2 m_1(X_1) q_2 m_2(X_2) \cdots q_2 m_k(X_k) \\ &= \prod_{i \in \{1, 2, \dots, k\}} \sum_{j \in \{1, 2, \dots, n\}} a_{ij} = (L_{n+1}, 0). \end{aligned}$$

Moreover, since $qPCR5$ redistributes proportionally the partial conflicting mass to the elements involved in the partial conflict by considering the canonical form of the partial conflict, the total sum of all qualitative belief mass after redistribution doesn't change and therefore it is equal to $(L_{n+1}, 0)$. This completes the proof.

Similarly, Dempster's rule (DS) can be extended for dealing with 2-tuple linguistic labels by taking $q_2 m_{DS}(\emptyset) = (L_0, 0)$ and $\forall A \in 2^\ominus \setminus \{\emptyset\}$

$$q_2 m_{DS}(A) = \frac{\sum_{\substack{X, Y \in 2^\ominus \\ X \cap Y = A}} q_2 m_1(X) q_2 m_2(Y)}{(L_{n+1}, 0) - \sum_{\substack{X, Y \in 2^\ominus \\ X \cap Y = \emptyset}} q_2 m_1(X) q_2 m_2(Y)} \tag{8.29}$$

8.4.2 Fusion of imprecise qualitative beliefs

Let's consider k sources of evidences providing imprecise qualitative belief assignments/masses \mathbf{m}_{ij} defined on G^\ominus with $|G^\ominus| = d$. We denote by m_{ij} central value of the label provided by the sourc no. i ($1 \leq i \leq k$) for the element $X_j \in G^\ominus$, $1 \leq j \leq d$. For example with qualitative interval-valued beliefs, $\mathbf{m}_{ij} = [m_{ij} - \epsilon_{ij}, m_{ij} + \epsilon_{ij}] \in [(L_0, 0), (L_{n+1}, 0)]$, where $(L_0, 0) \leq \epsilon_{ij} \leq L_{n+1}$. More generally, \mathbf{m}_{ij} can be either an union of open intervals, or of closed intervals, or of semi-open intervals.

The set of imprecise qualitative belief masses provided by the sources of evidences can be represented/characterized by the following belief mass matrices with

$$\text{inf}(\mathbf{M}) = \begin{bmatrix} m_{11} - \epsilon_{11} & m_{12} - \epsilon_{12} & \cdots & m_{1d} - \epsilon_{1d} \\ m_{21} - \epsilon_{21} & m_{22} - \epsilon_{22} & \cdots & m_{2d} - \epsilon_{2d} \\ \cdots & \cdots & \cdots & \cdots \\ m_{k1} - \epsilon_{k1} & m_{k2} - \epsilon_{k2} & \cdots & m_{kd} - \epsilon_{kd} \end{bmatrix}$$

$$\text{sup}(\mathbf{M}) = \begin{bmatrix} m_{11} + \epsilon_{11} & m_{12} + \epsilon_{12} & \cdots & m_{1d} + \epsilon_{1d} \\ m_{21} + \epsilon_{21} & m_{22} + \epsilon_{22} & \cdots & m_{2d} + \epsilon_{2d} \\ \cdots & \cdots & \cdots & \cdots \\ m_{k1} + \epsilon_{k1} & m_{k2} + \epsilon_{k2} & \cdots & m_{kd} + \epsilon_{kd} \end{bmatrix}$$

All the previous qualitative fusion rules working with precise 2-tuple labels can be extended directly for dealing with imprecise 2-tuple labels by replacing precise operators on 2-tuple labels by their counterparts for imprecise 2-tuple labels as defined in section 8.5. We just here present the extensions of *DSmC*, *PCR5* and *DS* rules of combinations. The extensions of other combination rules (*DSmH*, Dubois & Prade's, Yager's, etc) can be done easily in a similar way and will not be reported here.

- **The DSmC fusion of imprecise qualitative beliefs**

The *DSm* classical rule of combination of $k \geq 2$ imprecise qualitative beliefs is defined for the free DSm model of the frame Θ , i.e. $G^\Theta = D^\Theta$ as follows: $q_2m_{DSmC}^I(\emptyset) = (L_0, 0)$ and $\forall X \in D^\Theta \setminus \{\emptyset\}$

$$q_2m_{DSmC}^I(X) = \sum_{\substack{X_1, X_2, \dots, X_k \in D^\Theta \\ X_1 \cap X_2 \cap \dots \cap X_k = X}} \prod_{i=1}^k q_2\mathbf{m}_i(X_i) \tag{8.30}$$

- **The PCR5 fusion of imprecise qualitative beliefs**

When working with Shafer's or DSm hybrid models of the frame Θ , the *PCR5* rule of combination of two imprecise qualitative beliefs is defined by: $q_2m_{PCR5}^I(\emptyset) = (L_0, 0)$ and $\forall X \in G^\Theta \setminus \{\emptyset\}$

$$q_2m_{PCR5}^I(X) = q_2\mathbf{m}_{12}^I(X) + \sum_{\substack{Y \in G^\Theta \setminus \{X\} \\ X \cap Y = \emptyset}} \left[\frac{q_2\mathbf{m}_1(X)^2 q_2\mathbf{m}_2(Y)}{q_2\mathbf{m}_1(X) + q_2\mathbf{m}_2(Y)} + \frac{q_2\mathbf{m}_2(X)^2 q_2\mathbf{m}_1(Y)}{q_2\mathbf{m}_2(X) + q_2\mathbf{m}_1(Y)} \right] \tag{8.31}$$

where $q_2\mathbf{m}_{12}^I(X)$ corresponds to the imprecise qualitative conjunctive consensus defined by

$$q_2\mathbf{m}_{12}^I(X) = \sum_{\substack{X_1, X_2 \in G^\Theta \\ X_1 \cap X_2 = X}} q_2\mathbf{m}_1(X_1)q_2\mathbf{m}_2(X_2) \tag{8.32}$$

- **Dempster's fusion of imprecise qualitative beliefs**

Dempster's rule can also be directly extended for dealing with imprecise qualitative beliefs by taking $q_2\mathbf{m}_{DS}(\emptyset) = (L_0, 0)$ and $\forall A \in 2^\Theta \setminus \{\emptyset\}$

$$q_2\mathbf{m}_{DS}^I(A) = \frac{\sum_{\substack{X, Y \in 2^\Theta \\ X \cap Y = A}} q_2\mathbf{m}_1(X)q_2\mathbf{m}_2(Y)}{(L_{n+1}, 0) - \sum_{\substack{X, Y \in 2^\Theta \\ X \cap Y = \emptyset}} q_2\mathbf{m}_1(X)q_2\mathbf{m}_2(Y)} \quad (8.33)$$

Theorem 2: The following equality holds

$$q_2\mathbf{m}_{DSmC}^I(X) = [\inf(q_2\mathbf{m}_{DSmC}^I(X)), \sup(q_2\mathbf{m}_{DSmC}^I(X))]$$

with

$$\begin{aligned} \inf(q_2\mathbf{m}_{DSmC}^I(X)) &= \sum_{\substack{X_1, X_2, \dots, X_k \in D^\Theta \\ X_1 \cap X_2, \dots, \cap X_k = X}} \prod_{i=1}^k \inf(q_2\mathbf{m}_i(X_i)) \\ \sup(q_2\mathbf{m}_{DSmC}^I(X)) &= \sum_{\substack{X_1, X_2, \dots, X_k \in D^\Theta \\ X_1 \cap X_2, \dots, \cap X_k = X}} \prod_{i=1}^k \sup(q_2\mathbf{m}_i(X_i)) \end{aligned}$$

Proof: Let's assume $\inf(q_2\mathbf{m}_i(X_j))$ and $\sup(q_2\mathbf{m}_i(X_j))$ ($1 \leq i \leq k$) be represented by $a_{ij} \in \inf(\mathbf{M})$ and $b_{ij} \in \sup(\mathbf{M})$ with $a_{ij} \leq b_{ij}$ (\leq represents here a qualitative order). For any label $c_{mj} \in [a_{mj}, b_{mj}]$, one has

$$\sum_{\substack{X_1, X_2, \dots, X_k \in D^\Theta \\ X_1 \cap X_2, \dots, \cap X_k = X}} \prod_{i=1}^k a_{ij} \leq \sum_{\substack{X_1, X_2, \dots, X_k \in D^\Theta \\ X_1 \cap X_2, \dots, \cap X_k = X}} \prod_{i=1, i \neq m}^k a_{ij} c_{mj}$$

and also

$$\sum_{\substack{X_1, X_2, \dots, X_k \in D^\Theta \\ X_1 \cap X_2, \dots, \cap X_k = X}} \prod_{i=1, i \neq m}^k a_{ij} c_{mj} \leq \sum_{\substack{X_1, X_2, \dots, X_k \in D^\Theta \\ X_1 \cap X_2, \dots, \cap X_k = X}} \prod_{i=1}^k b_{ij}$$

Therefore, $q_2\mathbf{m}_{DSmC}^I(X) = [\inf(q_2\mathbf{m}_{DSmC}^I(X)), \sup(q_2\mathbf{m}_{DSmC}^I(X))]$ which completes the proof. Similarly, $q_2\mathbf{m}_{PCR5}^I(X) = [\inf(q_2\mathbf{m}_{PCR5}^I(X)), \sup(q_2\mathbf{m}_{PCR5}^I(X))]$.

This theorem shows that we can compute the upper and lower bounds of imprecise qualitative beliefs by applying the corresponding combination and redistribution rule directly on the bounds.

8.5 Examples of fusion of qualitative beliefs

All examples from this article could easier be calculated using the DS_m Field and Algebra of Refined Labels.

8.5.1 Example of fusion of precise qualitative beliefs

Let's consider an investment corporation which has to choose one project among three proposals $\Theta = \{\theta_1, \theta_2, \theta_3\}$ based on two consulting/expert reports. The linguistic labels used by the experts are among the following ones: $I \mapsto$ Impossible, $EU \mapsto$ Extremely-Unlikely, $VLC \mapsto$ Very-Low-Chance, $LLC \mapsto$ Little-Low-Chance, $SC \mapsto$ Small-Chance, $IM \mapsto$ IT-May, $MC \mapsto$ Meanful-Chance, $LBC \mapsto$ Little-Big-Chance, $BC \mapsto$ Big-Chance, $ML \mapsto$ Most-likely, $C \mapsto$ Certain. So, we consider the following ordered set L (with $|L| = n = 9$) of linguistic labels

$$L \triangleq \{L_0 \equiv I, L_1 \equiv EU, L_2 \equiv VLC, L_3 \equiv LLC, L_4 \equiv SC, L_5 \equiv IM, \\ L_6 \equiv MC, L_7 \equiv LBC, L_8 \equiv BC, L_9 \equiv ML, L_{10} \equiv C\}$$

The qualitative belief assignments/masses provided by the sources/experts are assumed to be given according to Table 8.1.

	Source 1	Source 2
θ_1	$m_1(\theta_1) = (L_4, 0.03)$	$m_2(\theta_1) = (L_5, 0)$
θ_2	$m_1(\theta_2) = (L_3, -0.03)$	$m_2(\theta_2) = (L_2, 0.01)$
θ_3	$m_1(\theta_3) = (L_3, 0)$	$m_2(\theta_3) = (L_3, -0.01)$

Table 8.1: Precise qualitative belief assignments given by the sources.

When working with the free DSm model and applying the qualitative $DSmC$ rule of combination (8.27), we obtain:

$$\begin{aligned} q_2m_{DSmC}(\theta_1) &= \Delta(0.43 \times 0.50) = (L_2, 0.015) \\ q_2m_{DSmC}(\theta_2) &= \Delta(0.27 \times 0.21) = (L_1, -0.0433) \\ q_2m_{DSmC}(\theta_3) &= \Delta(0.30 \times 0.29) = (L_1, -0.013) \\ q_2m_{DSmC}(\theta_1 \cap \theta_2) &= \Delta(0.43 \times 0.21 + 0.50 \times 0.27) = (L_2, 0.0253) \\ q_2m_{DSmC}(\theta_1 \cap \theta_3) &= \Delta(0.43 \times 0.29 + 0.50 \times 0.30) = (L_3, -0.0253) \\ q_2m_{DSmC}(\theta_2 \cap \theta_3) &= \Delta(0.27 \times 0.29 + 0.21 \times 0.30) = (L_1, 0.0413) \end{aligned}$$

We can verify the validity of the Theorem 1, i.e. $\sum_{A \in D^\Theta} q_2m(A) = (L_{10}, 0)$, which proves that is $q_2m_{DSmC}(\cdot)$ is normalized.

Now, let's assume that Shafer's model holds for Θ . In this case the sets $\theta_1 \cap \theta_2, \theta_1 \cap \theta_3, \theta_2 \cap \theta_3$ must be empty and the qualitative conflicting masses $q_2m_{DSmC}(\theta_1 \cap \theta_2), q_2m_{DSmC}(\theta_1 \cap \theta_3)$ and $q_2m_{DSmC}(\theta_2 \cap \theta_3)$ need to be redistributed to the sets involved in these conflicts according to (8.28) if the PCR5 fusion rule is used. So, with PCR5

one gets:

$$\begin{aligned} q_2m_{PCR5}(\theta_1) &= q_2m_{DSmC}(\theta_1) + q_2m_{xA1}(\theta_1) + \\ & \quad q_2m_{xB1}(\theta_1) + q_2m_{xA2}(\theta_1) + q_2m_{xB2}(\theta_1) \\ &= (L_5, 0.03155626126) \end{aligned}$$

$$\begin{aligned} q_2m_{PCR5}(\theta_2) &= q_2m_{DSmC}(\theta_2) + q_2m_{yA1}(\theta_2) + \\ & \quad q_2m_{yB1}(\theta_2) + q_2m_{xA3}(\theta_2) + q_2m_{xB3}(\theta_2) \\ &= (L_2, -0.00263968798) \end{aligned}$$

$$\begin{aligned} q_2m_{PCR5}(\theta_3) &= q_2m_{DSmC}(\theta_3) + q_2m_{yA2}(\theta_3) + \\ & \quad q_2m_{yB2}(\theta_3) + q_2m_{yA3}(\theta_3) + q_2m_{yB3}(\theta_3) \\ &= (L_3, -0.02891657328) \end{aligned}$$

Because $q_2m_{PCR5}(\theta_1)$ is larger than $q_2m_{PCR5}(\theta_2)$ and $q_2m_{PCR5}(\theta_3)$, the investment corporation will choose the first project to invest.

Now, if we prefer to use the extension of Dempster's rule of combination given by the formula (8.33), the total qualitative conflicting mass is $qK_{total} = q_2m_{DSmC}(\theta_1 \cap \theta_2) + q_2m_{DSmC}(\theta_1 \cap \theta_3) + q_2m_{DSmC}(\theta_2 \cap \theta_3) = (L_6, 0.0413)$, and so we obtain:

$$\begin{aligned} q_2m_{DS}(\emptyset) &\triangleq (L_0, 0) \\ q_2m_{DS}(\theta_1) &= \frac{q_2m_{DSmC}(\theta_1)}{L_{10} - qK_{total}} = \frac{(L_2, 0.015)}{L_{10} - (L_6, 0.0413)} = (L_6, -0.0006133) \\ q_2m_{DS}(\theta_2) &= \frac{q_2m_{DSmC}(\theta_2)}{L_{10} - qK_{total}} = \frac{(L_1, -0.0433)}{L_{10} - (L_6, 0.0413)} = (L_2, -0.0419292) \\ q_2m_{DS}(\theta_3) &= \frac{q_2m_{DSmC}(\theta_3)}{L_{10} - qK_{total}} = \frac{(L_1, -0.013)}{L_{10} - (L_6, 0.0413)} = (L_2, 0.0425425) \end{aligned}$$

We see that $q_2m_{DS}(\theta_1)$ is larger than $q_2m_{DS}(\theta_2)$ and $q_2m_{DS}(\theta_3)$, so the first project is also chosen to invest. The final decision is same to the previous one obtained by q_2PCR5 . However, when the total conflict becomes nearer and nearer to L_{10} , then q_2DS formula will become invalid.

If we adopt the simple arithmetic mean method, the results of the fusion are:

$$\begin{aligned} \theta_1 &: \frac{(L_4, 0.03) + (L_5, 0)}{2} = (L_5, -0.035) \\ \theta_2 &: \frac{(L_3, -0.03) + (L_2, 0.01)}{2} = (L_2, 0.04) \\ \theta_3 &: \frac{(L_3, 0) + (L_3, -0.01)}{2} = (L_3, -0.005) \end{aligned}$$

According to the above results, we easily know which project will be chosen to invest. Though the arithmetic mean is the simplest method among three methods, for some complex problems, it will provide unsatisfactory results since it is not neutral with respect to the introduction of a total ignorant source in the fusion process. This method can also be ill adapted to some particular problems. For example, one also investigates the possibility of investment in two projects together, i.e. $\theta_i \cap \theta_j \neq \emptyset$. However, the corporation only choose one of them to invest. How to do it in this case with simple arithmetic mean method? It is more easy to take decision from $q_2PCR5(\cdot)$.

If all qualitative masses involved in the fusion are normalized, no matter what qualitative fusion rule we use the normalization is kept (i.e. the result will also be a normalized mass).

8.5.2 Example of fusion of imprecise qualitative beliefs

Let's consider again the previous example with imprecise qualitative beliefs provide by the sources according to Table 8.2:

	Source 1	Source 2
θ_1	$m_1(\theta_1) = [(L_4, 0.03), (L_5, 0.03)]$	$m_2(\theta_1) = [(L_5, 0), (L_5, 0.04)]$
θ_2	$m_1(\theta_2) = [(L_3, -0.03), (L_4, -0.03)]$	$m_2(\theta_2) = [(L_2, 0.01), (L_3, -0.03)]$
θ_3	$m_1(\theta_3) = [(L_3, 0), (L_4, 0.03)]$	$m_2(\theta_3) = [(L_3, -0.01), (L_3, 0)]$

Table 8.2: Imprecise qualitative belief assignments given by the sources.

If one works with the free DS_m model for the frame Θ , one gets from (8.30) and the theorem 2 the following results:

$$\begin{aligned}
 q_2m_{DSmC}^I(\theta_1) &= [(L_2, 0.015), (L_3, -0.0138)] \\
 q_2m_{DSmC}^I(\theta_2) &= [(L_1, -0.0433), (L_1, -0.0001)] \\
 q_2m_{DSmC}^I(\theta_3) &= [(L_1, -0.013), (L_1, 0.029)] \\
 q_2m_{DSmC}^I(\theta_1 \cap \theta_2) &= [(L_2, 0.0253), (L_3, 0.0429)] \\
 q_2m_{DSmC}^I(\theta_1 \cap \theta_3) &= [(L_3, -0.0253), (L_4, -0.0088)] \\
 q_2m_{DSmC}^I(\theta_2 \cap \theta_3) &= [(L_1, 0.0413), (L_2, 0.0271)]
 \end{aligned}$$

If one works with Shafer's model for the frame Θ (i.e. all elements of Θ are assumed exclusive), then the imprecise qualitative conflicting masses $q_2m_{DSmC}^I(\theta_1 \cap \theta_2)$, $q_2m_{DSmC}^I(\theta_1 \cap \theta_3)$ and $q_2m_{DSmC}^I(\theta_2 \cap \theta_3)$ need to be redistributed to elements involved in these conflicts if PCR5 is used. In such case and from (8.31) and the

Theorem 2, one gets:

$$\begin{aligned}
 q_2 m_{PCR5}^I(\theta_1) &= [(L_5, -0.02036), (L_8, 0.01860)] \\
 q_2 m_{PCR5}^I(\theta_2) &= [(L_2, -0.02909), (L_4, -0.0089)] \\
 q_2 m_{PCR5}^I(\theta_3) &= [(L_3, -0.03308), (L_5, 0.01112)]
 \end{aligned}$$

From the values of $q_2 m_{PCR5}^I(\cdot)$, one will choose the project θ_1 as final decision. It is interesting to note that $q_2 DSmC$ and $q_2 PCR5$ can be interpreted as special case (lower bounds) of $q_2^I DSmC$ and $q_2^I PCR5$.

The approach proposed in this work for combining imprecise qualitative beliefs presents the following properties:

- 1) If one utilizes the q_2 -operators on 2-tuples without doing any approximation in the calculations one gets an exact qualitative result, while working on 1-tuples we round the qualitative result so we get approximations. Thus addition and multiplication operators on 2-tuple are truly commutative and associative contraiwise to addition and multiplication operators on 1-tuples. Actually, Herrera-Martínez' representation deals indirectly with exact qualitative (refined) values of the labels. This can be done directly and easier (without 2-tuple representation) from the DSm Field and Linear Algebra of Refined Labels (DSm-FLARL) presented in Chapter 2 of this volume. In DSm-FLARL we get the exact qualitative result.
- 2) Since the 2-tuples $\{(L_0, \sigma_0^h), \dots, (L_{n+1}, \sigma_{n+1}^h)\}$ express actually continuous qualitative beliefs, they are equivalent to real numbers. So all quantitative fusion rules (and even the belief conditioning rules) can work directly using this qualitative framework. The imprecise qualitative DSmC and PCR5 fusion rules can deal easily and efficiently with imprecise belief structures, which are usually well adapted in real situations dealing with human reports.
- 3) The precise qualitative DSmC and PCR5 fusion rules can be seen as special cases of Imprecise qualitative DSmC and PCR5 fusion rules as shown in our examples.

8.6 Conclusion

In this chapter, we have proposed a new approach for combining imprecise qualitative beliefs based on Herrera-Martínez' 2-Tuple linguistic labels. This approach allows the combination of information in the situations where no precise qualitative information is available. The underlying idea is to work with refined labels expressed as 2-tuples to keep working on the original set of linguistic labels. We have proposed precise and imprecise qualitative operators for 2-tuple labels and we have shown through very simple examples how we can combine precise and/or imprecise qualitative beliefs. The results obtained by this approach are more precise than those based on 1-tuple

representation since no rounding approximation is done in operations and all the information is preserved in the fusion process. An enrichment of 2-tuples representation model can be done similarly to the enrichment done for 1-tuple representation in order to take into account the confidence we may commit to each qualitative (precise or imprecise) 2-tuple label given by the sources. The imprecise qualitative DSmC and PCR5 fusion rules are the extensions of precise qualitative DSmC and PCR5 fusion rules.

8.7 References

- [1] T. Denœux, *Reasoning with imprecise belief structures*, International Journal of Approximate Reasoning, Vol. 20, pp. 79–111, 1999 (published preliminary as Heudiasys 97/44 Technical Report).
- [2] J. Dezert, F. Smarandache, *Fusion of imprecise beliefs*, in [17].
- [3] J. Dezert, F. Smarandache, *A new probabilistic transformation of belief mass assignment*, in Proceedings of Fusion 2008 Int. Conf., Cologne, Germany, July 2008.
- [4] D. Dubois, H. Prade, *Decision-theoretic foundations of qualitative possibility theory*, European Journal of Operational Research, 128 (3), pp. 459–478, 2001.
- [5] D. Dubois, H. Prade, *Qualitative reasoning with imprecise probabilities*, Journal of Intelligent Information Systems, 2(4), pp. 319–363, 1993.
- [6] S. Ferson, S. Donald, *Probability bounds analysis*, in Proceedings of Int. Conf. on Probabilistic Safety Assessment and Management (PSAM4), Springer-Verlag, New York, NY, U.S.A., 1998.
- [7] P. Hájek, D. Harmanová, R. Verbrugge, *A qualitative fuzzy possibilistic logic*, International Journal of Approximate Reasoning, 12 (1), pp. 1–19, 1995.
- [8] F. Herrera, L. Martínez, *A 2-tuple fuzzy linguistic representation model for computing with words*, IEEE Trans. on Fuzzy Systems, Vol. 8 (6), pp. 746–752, 2000.
- [9] X. Li, *Research on Fusion Method of Imperfect Information from Multi-source and Its Application*, Ph.D. Thesis, Huazhong University of Science and Technology, China, June 2007.
- [10] X. Li, X. Huang, J. Dezert, F. Smarandache, *Enrichment of Qualitative Beliefs for Reasoning under Uncertainty*, in Proceedings of Fusion 2007 Int. Conf., Québec, Canada, July 2007.
- [11] M. Kifer, V. S. Subrahmanian, *Theory of Generalized Annotated Logic Programs and its Applications*, Journal of Logic Programming, 1991.

- [12] S. Parsons, *Qualitative methods for reasoning under uncertainty*, Ph.D. Thesis, Dept. of Elec. Eng., Queen Mary and Westfield College, 1993.
- [13] S. Parsons, E. Mamdani, *Qualitative Dempster-Shafer Theory*, in Proceedings of the Third EMACS International Workshop on Qualitative Reasoning and Decision Technologies, Barcelona, Spain, 1993.
- [14] S. Parsons, *Some qualitative approaches to applying Dempster-Shafer theory*, Information and Decision technologies, Vol. 19, pp. 321–337, 1994.
- [15] G. Polya, *Patterns of Plausible Inference*, Princeton University Press, Princeton, NJ, 1954.
- [16] G. Shafer, *A Mathematical Theory of Evidence*, Princeton University Press, Princeton, NJ, 1976.
- [17] F. Smarandache, J. Dezert (Editors), *Advances and Applications of DSmT for Information Fusion (Collected works)*, Vol. 1, American Research Press, Rehoboth, 2004.
<http://www.gallup.unm.edu/~smarandache/DSmT-book1.pdf>.
- [18] F. Smarandache, J. Dezert, *Information Fusion Based on New Proportional Conflict Redistribution Rules*, in Proceedings of Fusion 2005, Philadelphia, U.S.A., July 2005.
- [19] F. Smarandache, J. Dezert (Editors), *Advances and Applications of DSmT for Information Fusion (Collected works)*, Vol. 2, American Research Press, Rehoboth, 2006.
<http://www.gallup.unm.edu/~smarandache/DSmT-book2.pdf>.
- [20] F. Smarandache, J. Dezert (Editors), *Qualitative Belief Conditioning Rules (QBCR)*, in Proceedings of Fusion 2007 Int. Conf., Québec, Canada, July 2007.
- [21] P. Smets, R. Kennes, *The transferable belief model*, Artificial Intelligence, No. 66, pp. 191–243, 1994.
- [22] V. S. Subrahmanian, *On the Semantics of Quantitative Logic Programs*, in Proceedings of the 4th IEEE Symposium on Logic Programming, 1987.
- [23] P. Walley, *Statistical Reasoning with Imprecise Probabilities*, Chapman and Hall, New York, 1991.
- [24] M. P. Wellman, *Some varieties of qualitative probability*, in Proceedings of the 5th Int. Conf. on Information Processing and the Management of Uncertainty (IPMU 1994), Paris, France, July 1994.

- [25] R. R. Yager, *On the retranslation process in Zadeh's paradigm of computing with words*, IEEE Trans. on Systems, Man, and Cybernetics - Part B: Cybernetics, Vol. 34, No. 2, pp. 1184–1195, April 2004.
- [26] L. Zadeh, *Concept of a linguistic variable and its application to approximate reasoning*, Information Sciences, Part 1, Vol. 8, pp. 199–249, 1975.
- [27] L. Zadeh, *A Theory of Approximate Reasoning*, Machine Intelligence, Vol. 9, pp. 149–194, 1979.
- [28] L. Zadeh, *Fuzzy Logic = Computing with Words*, IEEE Transactions on Fuzzy Systems, Vol. 4, No. 2, pp. 103–111, May 1996.
- [29] L. Zadeh, *Towards a theory of fuzzy information granulation and its centrality in human reasoning and fuzzy logic*, Fuzzy Sets and Systems, Vol. 19, pp. 111–127, 1997.
- [30] L. Zadeh, *Some reflections on soft computing, granular computing and their roles in the conception, design and utilization of information/intelligent systems*, Soft Computing, Vol. 2., pp. 23–25, 1998.

Chapter 9

Non-numeric labels and constrained focal elements

Christophe Osswald and Arnaud Martin

ENSIETA, E³I² - EA3876

2, rue François Verny

29806 Brest, Cedex 9, France.

Christophe.Osswald@ensieta.fr, Arnaud.Martin@ensieta.fr

Abstract: *The theory of belief functions allows to build a large family of combination operators, based mostly on intersections and unions between the focal elements expressed by the experts, and multiplications and additions on the masses affected to these focal elements. This chapter explores some algebraic structures where these operators behave differently, masses being linguistic labels, or focal elements being more, or less, than an union of singletons of a discernment space. In some cases, it will be necessary to forget this space and the notion of singleton to work within a space of possible focal elements. We propose five new definitions of labels, with the corresponding algebras, to replace the masses of $[0, 1]$. Adaptations of the theory of belief functions to six constrained spaces for the focal elements expressed by the experts are presented.*

9.1 Introduction

The theory of belief functions, also called theory of evidence or Dempster-Shafer theory [4, 20], relies on the definition of basic belief assignments. A large family of combination operators provides information fusion capabilities. An overview of their behaviour, based on the decisions they induce, has been made with some analysis of similarity tools [18]. This chapter extends some previous works of the authors [19].

However, an automatic process is likely to express a mass between 0 and 1, but a human expert may find it difficult. Interpreting the result can even be a bit more difficult. The operations applied on the focal elements, particularly the union, may lead to elements that cannot be interpreted, nor expressed in the expert's syntax. Therefore, the objective of providing a meaningful basic belief assignment implies the ability to constrain its focal elements within an extension of the discernment space that is restricted to acceptable elements. Dempster and Shafer propose to build this extension by closing the discernment space by the union operator, while Dezert and Smarandache [21] close it by union and intersection (and even by complementation in [23]), and define an equivalence class of the empty set to restrict the hyper-power set obtained. An aim of this chapter is to explore the question of the other closures of the discernment space, with an algebraic point of view, and some algorithmic complexity concerns.

The interpretability and robustness of the values given to the masses in a man-machine interaction is another of the topics of this chapter, and we propose some algebraic constructions to address both the formulas of the theory of belief functions and the human processes of decision making.

The section 9.2 browses the most common definitions, functions and operators of the theory of belief functions. They are classified by their needs of algebraic structures, considering the operators appearing in their definitions – a list of their structures used in the chapter is given in appendix. The section 9.3 proposes three new types of linguistic labels: auto-indenting labels, unfinite auto-indenting labels and soft auto-indenting labels, test their algebraic properties, and illustrates their differences on an example, including a max – min algebra reference. Two other extensions of the $[0, 1]$ real segment are proposed. The section 9.4 shows how to adapt the theory of belief functions to six situations where the properties of the space containing the focal elements of the basic belief assignment are more constrained than a power set or a hyper-power set. Next to the list of the compatible operators, one should keep an eye to the combinatorial complexity they require.

9.2 Theories of belief functions

9.2.1 Basic belief assignments

On a finite or discrete set Θ , called the *discernment space*, it allows to provide mass on any subset of Θ instead of its singletons. Such a mass repartition is called a *basic belief assignment* (bba) m :

$$\sum_{X \in 2^\Theta} m(X) = 1 \tag{9.1}$$

$$\forall X \in 2^\Theta \quad m(X) \geq 0 \tag{9.2}$$

The hypothesis of *closed world* [20] can be added to this definition:

$$m(\emptyset) = 0 \tag{9.3}$$

It is equivalent to allow an *open world*, or add a special element to Θ , receiving the mass \emptyset , and use the properties of a closed world.

If A is an element of 2^Θ with a non-zero mass, it is called a *focal element*. As a possible bearer of mass, Θ is the *ignorance*. We will call $\mathcal{F}(m)$ the set of the focal elements of m , the *focal set* of m . The notation n will be reserved for the cardinal of Θ .

The equation (9.1) can be extended to the hyper-power set D^Θ , closure of Θ under union and intersection operators. Therefore the exclusivity between elements of Θ is not necessary, and one can put some mass on their intersection:

$$\sum_{X \in D^\Theta} m(X) = 1 \tag{9.4}$$

The set of the possible focal elements will be called the *extension* of Θ , noted $E(\Theta)$. It may be 2^Θ (the power set), D^Θ (the hyper-power set), S^Θ (the super-power set), or another closure of Θ .

9.2.2 Decision-aid functions

Belief (Bel), plausibility (Pl) and pignistic probability (BetP) can be used to build increasing monotonic functions on 2^Θ : $A \subset B$ implies $f(A) \leq f(B)$. As $\text{Bel}(A) \leq \text{BetP}(A) \leq \text{Pl}(A)$, the pignistic probability is often considered as an interesting compromise. For any $X \in E(\theta)$, these functions are defined by:

$$\text{Bel}(X) = \sum_{Y \in E(\Theta), Y \subset X, Y \neq \emptyset} m(Y) \tag{9.5}$$

$$\text{Pl}(X) = \sum_{Y \in E(\Theta), Y \cap X \neq \emptyset} m(Y) \tag{9.6}$$

$$\text{BetP}(X) = \sum_{Y \in E(\Theta), Y \neq \emptyset} \frac{|X \cap Y|}{|Y|} \frac{m(Y)}{1 - m(\emptyset)} \quad (9.7)$$

To take a decision, one can choose the maximum of mass, the maximum of belief, the maximum of plausibility or the maximum of pignistic probability. As the three last functions are increasing, their maximum is reached for the ignorance Θ . They will be used for decision-making after selecting a subset of $E(\Theta)$, where all elements are pair-wise incomparable, by example by fixing the cardinal of a possible decision, generally limiting it to the singletons. It is also possible to use a discounting method to deceive the larger elements of $E(\Theta)$.

The cardinal $|X|$ is the number of singletons of Θ included in X when $E(\Theta)$ is 2^Θ , and is defined by the number of regions of the Venn diagram of Θ included in X when $E(\Theta)$ is D^Θ [5]. Many other decision functions have been proposed on 2^Θ , most recently by Cuzzolin [3] and Sudano [27] and adapted to D^Θ and qualitative labels by Dezert and Smarandache [7].

9.2.3 Usual combination operators

A combination operator takes two or more bba's to build another bba. It is an inner operation (Bel, Pl or BetP are not).

The *mean* operator is the simpler one. Its focal set is the union of the focal sets of the input bba's.

$$\text{Mean}(m_1, \dots, m_N)(X) = \frac{1}{N} \sum_{i=1}^N m_i(X) \quad (9.8)$$

The *conjunctive operator*, proposed by Smets [25] for two input bba's m_1 and m_2 , is given by the equation (9.9). It puts the mass $m_1(A)m_2(B)$ on the set $A \cap B$. It is an associative operator, so it is useless to write its expression for N input bba's¹. Dempster [4] prefers a normalized version, multiplying all terms by $\frac{1}{1 - m(\emptyset)}$: it has the same associativity property. Yager transfers the conflicting mass $m(\emptyset)$ on ignorance $m(\Theta)$, loosing associativity.

$$m_{\text{Conj}}(X) = \sum_{A \cap B = X} m_1(A)m_2(B) \quad (9.9)$$

The *disjunctive operator* transfers the mass $m_1(A)m_2(B)$ on the set $A \cup B$. It is usually seen as insufficiently informative, as it transfers mass on a local ignorance in case of distinct focal elements; it preserves the closed world hypothesis. Like the conjunctive operator, it is associative.

$$m_{\text{Dis}}(X) = \sum_{A \cup B = X} m_1(A)m_2(B) \quad (9.10)$$

¹Fusing N bbas of p focal elements, such an expression would decline into a $\mathcal{O}(p^N)$ algorithm, but the associativity can lead to an algorithm in $\mathcal{O}(npN)$ operations, if the number of possible focal elements is linearly limited to $n = |\Theta|$.

The Dubois & Prade combination operator [8] is an interesting compromise between the conjunctive and the disjunctive ones. It puts the mass $m_1(A)m_2(B)$ on $A \cap B$ if $A \cap B$ is not empty, and on $A \cup B$ if it is. It respects the closed world hypothesis, adds information like the conjunctive rule (and even better, as local ignorance should be preferred to conflict), but is not associative. The extension of this rule, called hybrid DSm rule (DSmH) in Dezert-Smarandache Theory (DSmT) framework for dealing with dynamic frames of discernment with non existential integrity constraints has been proposed in [21].

$$m_{\text{DP}}(X) = \sum_{A \cap B = X} m_1(A)m_2(B) + \sum_{\substack{A \cap B = \emptyset \\ A \cup B = X}} m_1(A)m_2(B) \tag{9.11}$$

$$m_{\text{DP}}(\emptyset) = 0 \tag{9.12}$$

A panel of conflict redistributing rules have been proposed [12, 14, 22, 23]; none is associative. The most used is the PCR5/6 combination operator² which is defined for two bba's by.

$$m_{\text{PCR5/6}}(X) = m_{\text{Conj}}(X) + \sum_{\substack{Y \subset \Theta, \\ X \cap Y = \emptyset}} \left(\frac{m_1(X)^2 m_2(Y)}{m_1(X) + m_2(Y)} + \frac{m_2(X)^2 m_1(Y)}{m_2(X) + m_1(Y)} \right) \tag{9.13}$$

9.2.4 Enough operators available?

To define a basic belief assignment, to compute its belief, plausibility and pignistic probability, to apply combination operators, we need to have access to many operators on the masses and the focal elements:

- **Masses:** For most operators, they are multiplied and added. For the Mean combination, they are multiplied by a real number. For the normalization procedure of Demspter, the PCR5/6 operator or the pignistic probability, it is necessary to divide by a mass.
- **Elements:** They pass through intersection and union operators. They are also compared with \emptyset and with a given element of $E(\Theta)$.

The methods exposed in section 9.2.5 need that the masses are expressed in a \mathbb{R} -algebra (addition, inner invertible multiplication, external multiplication). They need that the focal elements are expressed in a lattice where Θ and \emptyset are extremum. The appendix provides a list of definitions for all the algebraic structures presented in this chapter.

²PCR5 and PCR6 are identical when combining two bba's, and differ for more.

In this chapter, we are interested in the following question:

Q: What does happen if the masses and focal elements live in poorer algebraic structures?

9.2.5 Operators for the usual bba operations

As 2^Θ is built by taking all the possible unions of elements of Θ , it is a semi-lattice. If there is no union operator, but a meet operator \vee , one gets the closure of Θ by \vee .

The lattice $(2^\Theta, \cap, \cup)$ (power set of Θ) is obtained by closing Θ by the operator \cup . Its bottom is \emptyset , its top is Θ .

The lattice (D^Θ, \cap, \cup) (hyper-power set of Θ), used as basis of DSMT [21], is obtained by closing Θ by the operators \cap and \cup . If $\Theta = \{\theta_1, \dots, \theta_n\}$. Its bottom is $\bigcap_{i=1}^n \theta_i$, its top is Θ .

Adding constraints on intersections and unions to build an equivalence class for \emptyset corresponds to an anti-chain in the more general lattice. The anti-chain cuts the lower part of the lattice, and its bottom becomes \emptyset , as an efficient element of the equivalence class.

The section 9.4 explores some of the lattices that can also be used to express focal elements.

As a mass is usually a real number, the term *label* will be used when the values assigned to focal elements are not necessarily in a field.

To define a basic belief assignment, the normalization condition (9.1) implies the labels can be added, and a constant value takes the role of “1”. The fact 1 is the neutral element for the multiplication operator, which eliminates the normalization step for the Conj, Dis, DP or PCR combination operators.

This normalization condition may have to be relaxed in an other label algebra, if the “addition” operator cannot have these comfortable properties.

Calculating the plausibility $Pl(A)$ (9.6) requires an inner addition for the labels (semi-group structure), and determines if an intersection between A and another element of $E(\Theta)$ is empty.

Calculating the belief $Bel(A)$ (9.5) requires an inner addition for the labels, and determine if an element X of $E(\Theta)$ is included in A . This can be extended to any

partial order \leq on $E(\Theta)$:

$$\text{Bel}(A) = \sum_{X \leq A} m(X) \quad (9.14)$$

Calculating the pignistic probability $\text{Bel}(A)$ (9.7) requires an inner addition, an inner multiplication and a scalar multiplication – an algebra over \mathbb{R} or \mathbb{Q} – for the labels. In an open world hypothesis ($m(\emptyset)$ can be nonzero) the inner multiplication operator must be invertible.

Non-numeric labels will hardly support a pignistic transformation, but in using the DSm Field and Linear Algebra of Refined Labels (FLARL) proposed in this volume. On $E(\Theta)$, an intersection and a cardinal are required.

For the Mean operator (9.8), the only requirements are an inner addition and a scalar multiplication. Labels can be elements of a vector space.

For the Dis operator (9.10), the requirement is an union operator on $E(\Theta)$. It can be the same operator that the one used to extend Θ to $E(\Theta)$: we get 2^Θ . Then $E(\Theta)$ only needs to be a semi-lattice (Θ, \vee) . Labels live in a ring.

For the Conj operator (9.9), the requirement is an intersection operator, distinct of the one used to extend Θ to $E(\Theta)$. So we need a complete lattice structure on Θ . If $E(\Theta)$ exists without any reference to Θ , a semi-lattice $(E(\Theta), \wedge)$ can be sufficient. Labels must be in a ring too. The DP combination operator (9.11) and Yager's rule have the same constraints.

The normalized Dempster rule needs the multiplication and the addition on the labels to be invertible, because of the multiplication by $1/(1 - m(\emptyset))$.

The PCR5/6 operator, like the pignistic transformation, needs the labels to be expressed in a \mathbb{R} -algebra, with an invertible inner multiplication. An intersection operator is needed, but not the cardinal. That makes the hyper-power set D^Θ a convenient lattice for this operator.

9.3 Extending the definition of labels

Smarandache and Dezert proposed in this volume and in [13, 24] a field structure for linguistic labels, allowing all the combination operators and functions described in the sections 9.2.2 and 9.2.3. Their approach requires a hypothesis of equi-repartition of the linguistic labels which may be hard to fit with human experts' outputs. The normalization condition (9.1) is hard to satisfy, as the value 1 should be reached after at least one integer approximation step, that's why we explore here other algebraic structures.

The section proposes five algebraic structures to associate a belief level with a focal element. None of them is concerned by an equi-repartition hypothesis: the intervals bear the repartition information, where a discretization just give an element of all the admissible values, possibly the center of them. The four other ones just take into account an order or a lattice, and are not concerned with the repartition question, bound to field structure.

The first three structures are variations around the max – min algebra on a finite total order, which contains all the possible labels. So, the finite linguistic set L is predetermined ordered set. Some structures allows it to evolve: the soft auto-indenting labels is such an example.

The fourth structure concerns an extension to any lattice for the labels. It is illustrated by a partial order on semantic labels, but placing the labels in the $[0, 1]^3$ cube would fell in this algebra too.

The interval structure extends real numbers of $[0, 1]$ to real intervals of $[0, 1]$. Therefore the normalization condition becomes $1 \in \sum_{X \in \mathcal{F}(m)} m(X)$; a drawback of this system is that what the information on the focal elements is refined by the fusion operators, the information on the labels is diluted. It approaches the behaviour of a Galois lattice.

9.3.1 Discrete and totally ordered labels

The Conj, Dis and DP combination operators are based on a ring structure over the labels: $(L, +, \times)$. These operators can be replaced to get some other rings: $(L, +, \max)$ or (L, \max, \min) .

In the first case, they form a structure equivalent to \mathbb{N} : one can take a positive non-zero element of L , and define the successor of an element ℓ of L by $\ell + x$. So L either is not finite, and therefore inadequate for linguistic labels, either there is an element whose successor is zero, and it is impossible to define an order on L (that's why $\mathbb{Z}/n\mathbb{Z}$ is not useful for semantic labels).

As L is a finite ordered set, $s(x)$ denotes the successor of an element x : $x \leq s(x)$, $x \neq s(x)$, and if $x \neq y$ and $x \leq y$, then $s(x) \leq y$. the minimum of L is noted 0_L , and M_L its maximum. An element of $E(\Theta)$ with a label 0_L is not a focal element.

9.3.2 Max-Min algebra

The max and min operators effectively fulfill the distribution property, and define a ring on L :

$$\min(a, \max(b, c)) = \max(\min(a, b), \min(a, c))$$

Note that this ring³ is also a lattice.

For any elements a and b of an ordered set L , $\min(a, b) \in L$ and $\max(a, b) \in L$. So, the result of any expression involving elements of L , min and max is still in L . If

³As this ring is compatible with the multiplication by a positive number, it is usually called an algebra. Here, of course, its ring properties are the only useful ones.

such an expression involves elements a_1, \dots, a_k , then

$$f(a_1, \dots, a_k) \leq \max(a_1, \dots, a_k) \tag{9.15}$$

Therefore, if \top is the top of the lattice or semi-lattice $E(\Theta)$,

$$Pl(\top) = \max_{A \in \mathcal{F}(m)} m(A) \tag{9.16}$$

A normalization condition can be that at least one label of m is M_L . This condition is robust to the Conj, Dis and DP combination operators.

However, this algebra lacks a useful property of the usual combination operators of the theory of belief functions: many small amounts of evidence cannot make a high amount of evidence.

In the two following structure, \min is kept as a replacement for the inner multiplication, but the \max operator is slightly transformed.

9.3.3 Auto-indenting labels

The operators for the auto-indenting labels (AIL) treat differently the case of equality for the \max .

$$x \oplus_{\text{AIL}} y = \begin{cases} \max(x, y) & \text{if } x \neq y \\ s(x) & \text{if } x = y, x \neq 0_L, x \neq M_L \\ 0_L & \text{if } x = y = 0_L \\ M_L & \text{if } x = y = M_L \end{cases} \tag{9.17}$$

The second condition allows to enforce a focal element receiving many similar labels. The third condition guarantees that 0_L is a neutral element for \oplus . The fourth condition guarantees that M_L remains the higher possible label. If it is removed, new labels over M_L are allowed. This defines an other operator, which creates unfinite auto-indenting labels, but appearing more slowly than in a $(L, +, \max)$ ring. It is noted AIL_∞ :

$$x \oplus_{\text{AIL}_\infty} y = \begin{cases} \max(x, y) & \text{if } x \neq y \\ s(x) & \text{if } x = y, x \neq 0_L, x \neq M_L \\ 0_L & \text{if } x = y = 0_L \end{cases} \tag{9.18}$$

Note that, for AIL and AIL_∞ , $x \oplus x \oplus x \oplus x = s(s(x))$. The later example, in the section 9.3.5, corresponds to $x \oplus x \oplus x \oplus x \oplus s(s(x)) = x(s(s(x)))$.

These operators are not distributive over \min :

$$\min(1, 2 \oplus 2) = \min(1, 3) = 1 \tag{9.19}$$

$$\min(1, 2) \oplus \min(1, 2) = 1 \oplus 1 = 2 \tag{9.20}$$

So using AIL or AIL_∞ suppresses the associativity property of the Conj and Dis combination operators. AIL respects the normalization property (9.1) through the Conj, Dis and DP combination operators, but AIL_∞ does not.

9.3.4 Soft auto-indenting labels

To distinguish between a label reached by the bba’s’ information and a label reached by accumulation of lower labels, one should prefer to create intermediary labels than jump to the next one⁴. This new label, taking place between x and $s(x)$, is noted x^+ and called “a bit more than x ”.

$$x \oplus_{\text{SAIL}} y = \begin{cases} \max(x, y) & \text{if } x \neq y \\ x^+ & \text{if } x = y, x = y^+, \text{ or } x^+ = y \\ 0_L & \text{if } x = y = 0_L \\ M_L & \text{if } x = y = M_L \end{cases} \quad (9.21)$$

The following table gives the value of $x \oplus_{\text{SAIL}} y$ for x and y taking their values in a label set extended from $\{0, 1, 2, M\}$.

$x \backslash y$	0	1	1^+	2	M
0	0	1	1^+	2	M
1	1	1^+	1^+	2	M
1^+	1^+	1^+	1^+	2	M
2	2	2	2	2^+	M
M	M	M	M	M	M

SAIL respects the normalization property (9.1) through the Conj, Dis and DP combination operators.

9.3.5 Example

The set of linguistic labels is $L = \{\text{no, low, mod, high}\}$ (where mod means moderate). The label “no” is the non-focal label 0_L , and the label “high” is the maximum of L , M_L .

In the following table, we consider the labels in a ring or a pseudo-ring (L, \oplus, \otimes) . We eventually transform the \otimes operator in a more usual multiplication symbol on

⁴To formalize a debate initiated by Terry Gillian, an African swallow is stronger than an European swallow, but how many European swallows are required to carry as much weight as an African swallow?

the labels $(x.y$ or $x^2)$. The Conj combination operator gives:

$$\begin{aligned}
 m(A) &= m_1(A) \otimes m_2(A) \oplus m_1(A) \otimes m_2(A \cup B) \oplus \\
 &\quad m_1(A) \otimes m_2(A \cup C) \oplus m_1(A \cup B) \otimes m_2(A) \oplus \\
 &\quad m_1(A \cup B) \otimes m_2(A \cup C) \oplus m_1(\Theta) \otimes m_2(A) \\
 &= \text{low}^2 \oplus \text{low}^2 \oplus \text{low.high} \oplus \text{high.low} \oplus \\
 &\quad \text{high}^2 \oplus \text{mod.low} \\
 m(A \cup B) &= m_1(A \cup B) \otimes m_2(A \cup B) \oplus m_1(\Theta) \otimes m_2(A \cup B) \\
 &= \text{high.low} \oplus \text{mod.low} \\
 m(A \cup C) &= m_1(\Theta) \otimes m_2(A \cup C) = \text{mod.high}
 \end{aligned}$$

	A	$A \cup B$	$A \cup C$	Θ
m_1	low	high	no	mod
m_2	low	low	high	no
max – min	high	low	mod	no
AIL	high	mod	mod	no
AIL $_{\infty}$	more than high	mod	mod	no
SAIL	high	a bit more than low	mod	no

The label systems AIL, AIL $_{\infty}$ and SAIL are purely discrete and semantic; they allow a certain form of normalization (at least, the bba’s they produce respect a normalization constraint); they allow a decision step by maximizing belief, plausibility or mass; they can’t produce a pignistic probability.

9.3.6 Lattice Labels

A projection on a total order – numeric or linguistic – may be insufficiently for modeling a confidence on a piece of information. In the *TTA150*, a French military manual, a confidence on a communication channel should be characterized by its strength (*strong, quite strong, feeble, very feeble*) and its quality (*clear, readable, deformed, with interferences*). Therefore, the quality of an information received through such a channel should be characterized by the pair formed by its *strength* and its *quality*. The pairs (*strength, quality*) live in a lattice, where $(x, y) \leq (x', y')$ if $x \leq x'$ and $y \leq y'$. Therefore, $(x, y) \vee (x', y') = (\max(x, x'), \max(y, y'))$ and $(x, y) \wedge (x', y') = (\min(x, x'), \min(y, y'))$. The top of the lattice is “strong and clear” while its bottom is “very feeble with interferences”. A lattice is usually not distributive and this one, unlike the max and min operators of section 9.3.2, is not distributive. So using with more than two input bba’s make it depend on the order of the fusion.

In the following example, the strength labels are compressed into (Str, QS, Fee, VF) and the quality labels into $(Cl, Read, Def, Int)$.

	A	$A \cup B$	$A \cup C$	Θ
m_1	Str, Cl	Str, Def		Fee, Int
m_2		QS, Def	Fee, Read	VF, Read
m_{Conj}	QS, Read	Fee, Def	Fee, Int	VF, Int

The label on A is obtained through:

$$\begin{aligned}
 m(A) &= m_1(A) \wedge m_2(\Theta) \vee m_1(A) \wedge m_2(A \cup B) \vee m_1(A) \wedge m_2(A \cup C) \\
 &\quad \vee m_1(A \cup B) \wedge m_2(A \cup C) \\
 &= (VF, Read) \vee (QS, Def) \vee (Fee, Read) \vee (Fee, Def) \\
 &= (QS, Read)
 \end{aligned}$$

9.3.7 Interval masses

A way to make easier the numerical expression of a human expert is to allow him to give a lower and an upper bound for each mass he commits to a focal element. Therefore the label on X is an interval $[x] = [\underline{x}, \bar{x}]$ where $0 \leq \underline{x} \leq \bar{x} \leq 1$. X is a focal element unless $\underline{x} = \bar{x} = 0$. This idea for working with imprecise mass of belief has been proposed and extended to unions of intervals by Dezert and Smarandache [6]; this section focus on the algebraic properties of such extension.

Interval arithmetic [10] does not have a true distributivity property, but only $[x] \times ([y] + [z]) \subset [x] \times [y] + [x] \times [z]$, it is better to factorize the expression obtained before calculation of the upper and lower bounds. But if the lower bounds of $[x]$, $[y]$ and $[z]$ are positive, the equality is reached. Therefore, the context of bba's brings the distributivity property.

Considering $[x]$ and $[y]$ two intervals of $[0, 1]$, the operators $+$ and \times are defined as follows. The last line is only valid if $0 \notin [x]$, and the second one cease to be valid if $\underline{x} < 0$ or $\underline{y} < 0$.

$$\begin{aligned}
 [x] + [y] &= [\underline{x} + \underline{y}, \bar{x} + \bar{y}] \\
 [x] \times [y] &= [\underline{x} \times \underline{y}, \bar{x} \times \bar{y}] \\
 1/[x] &= [1/\bar{x}, 1/\underline{x}]
 \end{aligned}$$

A real x is also the interval $[x, x]$, as stated by the bba 1 for the focal element A . As all the $m(A)$ are intervals, $\sum_{A \in E(\Theta)} m(A)$ is also an interval and one can verify that both bba's are valid toward the relaxed normalization rule:

$$1 \in \sum_{A \in E(\Theta)} m(A) \quad (9.22)$$

Example:

	m_1	m_2	m_{Conj}	m_{DS}	BetP
\emptyset			[0.12, 0.16]	0	0
A	0.2	0	[0.22, 0.26]	[0.25, 0.31]	[0.29, 0.524]
B	0	0	[0.18, 0.41]	[0.205, 0.488]	[0.381, 1]
C	0	0	0	0	[0.137, 0.333]
$A \cup B$	[0.3, 0.5]	[0.6, 0.8]	[0.07, 0.36]	[0.08, 0.429]	0
$B \cup C$	0	[0.1, 0.3]	[0.24, 0.56]	[0.273, 0.667]	0
$A \cup B \cup C$	[0.4, 0.7]	0	0	0	0

As the normalization step between the conjunctive fusion operator and the Dempster-Shafer operator is also a part of the pignistic transformation, we obtain the same pignistic probability from any of the two bba's obtained by fusion of bba's 1 and 2. One should verify that m_{Conj} , m_{DS} and BetP still satisfy the relaxed normalization rule, but the width of $\sum_{A \in E(\Theta)} m(A)$ increases.

The calculus of BetP(B) through the interval arithmetic should provide [0.381, 1.036], but it can be truncated without any information loss, if the further treatments do not resume the intervals by their centers⁵.

9.4 Constraints over the focal elements

What does happen if the lattice $E(\Theta)$ uses operators different of \cap and \cup ? These operators may create focal elements incompatible with the model elements that should appear in the bba produced by the experts (human or artificial). The following examples browse some of these situations, from an order set to a formalism near the natural language, through some classification models. It is possible that the "singletons of Θ " are difficult to exhibit; in this case, $E(\Theta)$ should be considered as the set of interest, as browsing the singletons is interesting only if they are privileged by the experts, or are necessary to calculate a pignistic probability.

9.4.1 Ordered set

If Θ is an ordered set, a subset A of Θ is *connected* if, for any x and y in A , $x \leq y$ brings $x \leq z \leq y$ implies $z \in A$ (resp. $y \leq x$ brings $y \leq z \leq x$ implies $z \in A$). Disconnected subsets do not have any signification in the context of an ordered set (Θ can be a discretization of some real value : {36, 39, 42, 45, 48, 51}). Therefore, the elements of $E(\Theta)$ should be the intervals of \leq , noted $[x, y]$. If $x = y$ the interval is a singleton. If $y < x$, the interval is \emptyset .

⁵This procedure, anyway, should not lead to a probability, as the the sum of the centers is not expected to be 1.

To remain within $E(\Theta)$, the \cap operator is convenient, as it preserves the connectiveness of its operands, but \cup is not: $\{36\} \cup \{42\} = \{36, 42\} \notin E(\Theta)$, but $\{36, 39, 42\}$ is. The hull of the operands gives the smallest interval:

$$[\![x_1, y_1]\!] \vee_{\leq} [\![x_2, y_2]\!] = [\![\min(x_1, x_2), \max(x_2, y_2)]\!] \quad (9.23)$$

The cardinal of an element of $E(\Theta)$ holds as usual, so all the combination operators and decision-aid functions of section 9.2.5 can be used.

As the cardinal of $\mathcal{F}(m)$ is bounded by $\frac{(n+2)(n+1)}{2}$, where 2^Θ has a size of 2^n , the constraint of a total order on Θ can limit the combinatorial explosion inherent to most combinatorial operators.

9.4.2 Intervals of \mathbb{R}^N

In a context of interval analysis [10, 16], the manipulated objects and the results are intervals of \mathbb{R}^N . If the theory guarantees some non-void intersections when manipulating the solutions of an equation, its application in an information fusion system with unpredicted events may lead to conflicting situations.

Here an *interval* $[\mathbf{x}, \mathbf{y}]$ corresponds to a Cartesian product $[x_1, y_1] \times \dots \times [x_N, y_N]$. The intersection works as usual, giving an join operator \wedge_I for the lattice $E(\Theta)$:

$$[\mathbf{x}^1, \mathbf{y}^1] \wedge_I [\mathbf{x}^2, \mathbf{y}^2] = \bigotimes_{i=1}^n [\max(x_i^1, x_i^2), \min(y_i^1, y_i^2)] \quad (9.24)$$

If for some dimension i , $\max(x_i^1, x_i^2) > \min(y_i^1, y_i^2)$, then

$$[\mathbf{x}^1, \mathbf{y}^1] \wedge_I [\mathbf{x}^2, \mathbf{y}^2] = \emptyset \quad (9.25)$$

For the \vee_I operator, the smallest interval of \mathbb{R}^N containing the operands is taken:

$$[\mathbf{x}^1, \mathbf{y}^1] \vee_I [\mathbf{x}^2, \mathbf{y}^2] = \bigotimes_{i=1}^N [\min(x_i^1, x_i^2), \max(y_i^1, y_i^2)] \quad (9.26)$$

The measure of Lebesgue gives the cardinal of interval:

$$\mu([\mathbf{x}, \mathbf{y}]) = \prod_{i=1}^N (y_i - x_i) \quad (9.27)$$

Therefore, all the combination operators and decision-aid functions of section 9.2.5 can be used in a context of interval calculus.

Unlike the usual (\cup, \cap) lattice or the $(\vee_{\leq}, \wedge_{\leq})$ lattice on an ordered set, the (\vee_I, \wedge_I) lattice is just a lattice, not a ring: \vee_I does not distribute over \wedge_I . On figure 9.1 the intervals are $A = [0, 1] \times [2, 3]$, $B = [2, 3] \times [4, 5]$, $C = [2, 3] \times [0, 1]$, $D = [4, 5] \times [2, 3]$. So:

$$\begin{aligned} (A \vee_I B) \wedge_I (C \vee_I D) &= [2, 3] \times [2, 3] \\ (A \wedge_I C) \vee_I (A \wedge_I D) \vee_I (B \wedge_I C) \vee_I (B \wedge_I D) &= \emptyset \end{aligned}$$

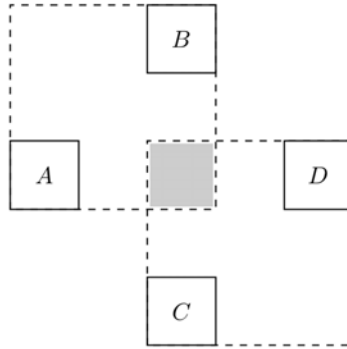

Figure 9.1: Non-distributivity.

9.4.3 Partitions

A set \mathcal{P} of subsets of Θ is a *partition* if for any pair A, B of elements of \mathcal{P} , either $A = B$ or $A \cap B = \emptyset$, and $\bigcup\{A \in \mathcal{P}\} = \Theta$. This structure is popular for unsupervised classification problems; a vast family algorithms, around K -means [15], produce results within this model. The intersection between two partitions, \mathcal{P}_1 and \mathcal{P}_2 , can be easily defined:

$$\mathcal{P}_1 \wedge_P \mathcal{P}_2 = \{A \cap B \mid A \in \mathcal{P}_1, B \in \mathcal{P}_2\} \tag{9.28}$$

However, replacing \cap by \cup in (9.28) does not produce a partition. An operator \vee_P should be constructed by considering the connected parts of the hyper-graph $\mathcal{P}_1 \cup \mathcal{P}_2$, but this tends to give a degenerated partition even if \mathcal{P}_1 and \mathcal{P}_2 differs only slightly. See Guénoche and Garreta [9] for robust methods of comparison between partitions. It is necessary to limit the operators to a closed semi-lattice, whose bottom \perp is a partition in n singletons and top \top is a partition containing only Θ .

The cardinal of a partition $n - |\mathcal{P}|$ where n is the cardinal of Θ and $|\mathcal{P}|$ the number of subsets of Θ in \mathcal{P} . So

$$\begin{aligned} \text{Card}(\perp) &= 0 \\ \text{Card}(\top) &= n - 1 \\ \text{Card}(\mathcal{P}_1 \wedge_P \mathcal{P}_2) &\leq \min(\text{Card}(\mathcal{P}_1), \text{Card}(\mathcal{P}_2)) \end{aligned} \tag{9.29}$$

The partitions on Θ can be used as focal elements for bba's, and use them for all the decision-aid functions, including BetP, and for the Conj and PCR5/6 combination operators.

9.4.4 Hierarchies

A *hierarchy* on Θ is a set \mathcal{H} of subsets of Θ such that:

- for any $x \in \Theta$, $\{x\} \in \mathcal{H}$;
- $\Theta \in \mathcal{H}$;
- for any A and B in \mathcal{H} , $A \cap B \in \{A, B, \emptyset\}$.

This structure is also very popular for unsupervised classification. It is produced by Ward's algorithm, single linkage, complete linkage and many others [11]. A merging operation between two hierarchies \mathcal{H}_1 and \mathcal{H}_2 can be defined by $A \in (\mathcal{H}_1 \odot \mathcal{H}_2)$ if

$$A = \bigcap \{X \in \mathcal{H}_1 \text{ or } X \in \mathcal{H}_2 \mid A \cap X \neq X\} \quad (9.30)$$

This operation is not associative, but it is idempotent, and admits \mathcal{H}_0 , the hierarchy containing only the singletons and Θ , as a neutral element. The structure defined is only a pseudo-semi-lattice using this operator \odot . Its bottom is \mathcal{H}_0 . It has no unique top, but the complete hierarchies (containing exactly $2n-1$ subsets of Θ) have no dominating hierarchy: if \mathcal{H} and \mathcal{H}' are complete, $\mathcal{H}' \odot \mathcal{H} = \mathcal{H}$ implies that $\mathcal{H}' = \mathcal{H}$.

The usual intersection operator works on hierarchies. However, it destroys information instead of making it sharper when possible. The usual union of two hierarchies is not necessarily a hierarchy. So a semi-lattice (\mathbf{H}, \cap) is obtained, whose bottom is \mathcal{H}_0 , and whose greatest elements are the complete hierarchies.

$$A \in (\mathcal{H}_1 \cap \mathcal{H}_2) \text{ iff } A \in \mathcal{H}_1 \text{ and } A \in \mathcal{H}_2 \quad (9.31)$$

Taking the number of subsets of Θ the hierarchy content is efficient to identify the complete hierarchies, but it is not decreasing with \wedge_H . Other definitions are hardly constant on the complete hierarchies.

The pseudo-semi-lattice defined by \odot can be used to model bba's in a hierarchy space, apply on them the decision-aid functions Bel and Pl, and combine them through the PCR5/6 and Conj operators. However, in this latter case, the associativity of the operator is lost.

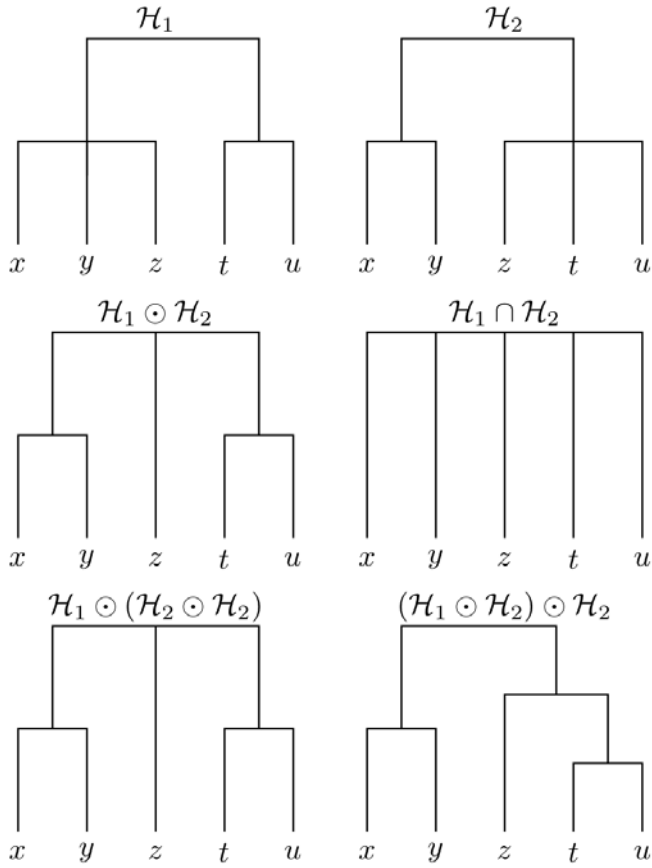

Figure 9.2: Dealing with hierarchies.

9.4.5 Binary clustering systems

A *binary clustering system* [1] on Θ is a set \mathcal{E} of subsets of Θ (called *clusters*) such that, for any x and y in Θ , the set $\mathcal{E}(x, y) = \{A \in \mathcal{E} \mid x \in A, y \in A\}$ admits a unique smallest element, called $A(x, y)$. It is said proper if $A(x, x) = \{x\}$. Hierarchies defined in section 9.4.4 are binary clustering systems; partitions defined in section 9.4.3 are non-proper binary clustering systems (add singletons and Θ for a better system); the closure by intersection of set of intervals of a complete order (see section 9.4.1) is a binary clustering system. \mathcal{E} can be seen as a *hyper-graph*, its elements are its *hyper-edges* and its vertex set is Θ [2].

Therefore, the definition of \mathcal{E} can be restricted to clusters that can be built as a smallest cluster containing a pair of elements of Θ . So the size of \mathcal{E} is bounded by $\mathcal{O}(n^2)$, and the restriction of the intersection of two binary clustering systems on Θ has the same size, and can be calculated in $\mathcal{O}(n^4)$ operations. A join operator \wedge_E can be defined by :

$$\mathcal{E}_1 \wedge_E \mathcal{E}_2 = \bigcup_{x \in \Theta, y \in \Theta} \{A_1(x, y) \cap A_2(x, y)\} \quad (9.32)$$

It defines a semi-lattice whose bottom is \mathcal{E}_\perp , a hyper-graph containing all the possible hyper-edges with 1 or 2 vertices. Its non-proper version is the complete graph whose vertex set is Θ . Its top is the hyper-graph \mathcal{E}_\top whose only hyper-edge is Θ . A cardinal function can be defined by:

$$\text{Card}(\mathcal{E}) = \sum_{\{x, y\} \subset \Theta} (|A(x, y)| - 2) \quad (9.33)$$

So $\text{Card}(\mathcal{E}_\perp) = 0$, $\text{Card}(\mathcal{E}_\top) = \frac{1}{2}n(n+1)(n-2)$, and $\mathcal{E} \leq \mathcal{E}'$ (see section 9.7.2 for the definition of \leq in a lattice) brings $\text{Card}(\mathcal{E}) \leq \text{Card}(\mathcal{E}')$.

So the binary clustering systems on Θ can be used as focal elements for bba's, and they can feed all the decision-aid functions, including BetP, and the Conj and PCR5/6 combination operators.

9.4.6 Semantic assertions

Semantic assertions can be modeled by *conceptual graphs* [26] or ontologies. Meet and join operators can be defined, but these operations can lead to NP-hard problems in a general case. However, some sub-classes of conceptual graphs avoid this combinatorial problem [17].

With the same restrictions on the shape of graphs than the other operations on them, to avoid combinatorial explosion, they can be combined by Conj and Dis operators. As obtaining \emptyset by conjunction of two conceptual graphs is very unlikely, the

PCR5/6 and DP combination operators should not be used: they are nearly equivalent to Conj.

The usual ways to calculate the cardinal of a graph (number of edges or number of vertices) is not compatible with the meet operator, and does not make sense with the specialization of labels. The decision-aid functions should be limited to Pl and Bel.

Then, the conjunctive combination operator, receiving bba's containing "*Johann have seen a Leclerc*" and "*A man have seen a tank near the river*" can put a mass (or a label) on the assertion "*Johann have seen a Leclerc tank near the river*".

9.5 Conclusion

The combination operators of the theory of belief functions are often heavy to manipulate: cumbersome equations⁶, data ill-adapted to matrix calculus under popular scientific software, real risks of combinatorial explosion, by example. However, they are more likely than Bayesian approaches or fuzzy sets to be adapted to many forms of symbolic data. In this chapter, we have shown that the link between the theory of belief functions and the probabilities, the pignistic transformation, relies on "difficult" operations: scalar multiplication and cardinal calculus. Dropping only this link and keeping most of their properties allows bba's to explore many facets of experts' opinions, and build a fused information from them, while other theories only deal with a projection of the experts' assertions on a too small space.

9.6 References

- [1] J.-P. Barthélemy, F. Brucker, *Binary clustering*, Discrete Applied Mathematics, in Press, 2007.
- [2] C. Berge, *Graphes et hyper-graphes*, Dunod, 1972.
- [3] F. Cuzzolin, *A Geometric Approach to the Theory of Evidence*, IEEE Transactions on Systems, Man, and Cybernetics Part C, vol. 38, no. 4, pp. 522–534, 2008.
- [4] A.P. Dempster, *Upper and Lower probabilities induced by a multivalued mapping*, Annals of Mathematical Statistics, vol. 83, pp. 325–339, 1967.
- [5] J. Dezert, F. Smarandache and M. Daniel, *The Generalized Pignistic Transformation*, International Conference on Information Fusion, Stockholm, Sweden, pp. 384–391, 28 June–1st July 2004.

⁶See the M-bba's version of PCR6 in [12].

- [6] J. Dezert and F. Smarandache, *Fusion of imprecise beliefs*, Advances and Applications of DS_mT for Information Fusion, Vol. 2, pp. 123-141, American Research Press, Rehoboth, 2004.
- [7] J. Dezert and F. Smarandache, *A new probabilistic transformation of belief mass assignment*, International Conference on Information Fusion, pp. 1410–1417, $K\sqrt{\partial \ln}$, Germany, July 2008.
- [8] D. Dubois and H. Prade, *Representation and Combination of uncertainty with belief functions and possibility measures*, Computational Intelligence, vol. 4, pp. 244-264, 1988.
- [9] A. Guénoche, H. Garreta, *Representation and evaluation of partitions*, Proceedings of IFCS'2002, pp. 131-138, Springer, 2002.
- [10] L. Jaulin, M. Kieffer, O. Didrit and E. Walter, *Applied Interval Analysis with Examples in Parameter and State Estimation*, Robust Control and Robotics, Springer-Verlag, 2001.
- [11] G.N. Lance, W.T. Williams, *A general theory of classificatory sorting strategies*, The computer journal, Vol. 3, No. 10, pp. 271–277 and Vol. 4, No. 9, pp. 373–380, 1967.
- [12] A. Martin and C. Osswald, *A new generalization of the proportional conflict redistribution rule stable in terms of decision*, Applications and Advances of DS_mT for Information Fusion, Book 2, American Research Press Rehoboth, F. Smarandache and J. Dezert (Editors), pp. 69–88, 2006.
- [13] A. Martin, C. Osswald, J. Dezert and F. Smarandache, *General Combination Rules for Qualitative and Quantitative Beliefs*, to appear in Journal of Advances in Information Fusion (JAIF), 2009.
- [14] A. Martin and C. Osswald, *Toward a combination rule to deal with partial conflict and specificity in belief functions theory*, International Conference on Information Fusion, Québec, Canada, 9-12 July 2007.
- [15] J. McQueen, *Some methods for classification and analysis of multivariate observations*, Proceedings of the Fifth Berkeley Symposium on Mathematical Statistics and Probability, pp. 281–297, 1967.
- [16] R.E. Moore, *Methods and Application of Interval Analysis*, SIAM Publ., Philadelphia, 1979.
- [17] M.-L. Mugnier, *Knowledge Representation and Reasonings Based on Graph Homomorphism*, Research report LIRMM 00-098, Montpellier, 2000.
- [18] C. Osswald and A. Martin, *Understanding the large family of Dempster-Shafer theory's fusion operators - a decision-based measure*, International Conference on Information Fusion, Florence, Italy, 10-13 July 2006.

- [19] C. Osswald and A. Martin, *Discrete labels and rich foci in theory of evidence*, International Conference on Information Fusion, pp 1426–1423, K $\sqrt{\partial}$ ln, Germany, July2008.
- [20] G. Shafer, *A mathematical theory of evidence*, Princeton University Press, 1976.
- [21] F. Smarandache, J. Dezert (Editors), *Application and Advances of DSMT for Information Fusion*, Collected Works, American Research Press, Rehoboth, 2004.
- [22] F. Smarandache, J. Dezert, *Information Fusion Based on New Proportional Conflict Redistribution Rules*, International Conference on Information Fusion, Philadelphia, U.S.A., 25-29 July 2005.
- [23] F. Smarandache, J. Dezert, *Proportional Conflict Redistribution Rules for Information Fusion*, Advances and Applications of DSMT for Information Fusion, Vol. 2, pp. 3-38, American Research Press, Rehoboth, 2006.
- [24] F. Smarandache, J. Dezert, *Qualitative Belief Conditioning Rules (QBCR)*, International Conference on Information Fusion, Québec, Canada, 9-12 July 2007.
- [25] Ph. Smets, *The Combination of Evidence in the Transferable Belief Model*, IEEE Transactions on Pattern Analysis and Machine Intelligence, Vol. 12, No. 5, pp. 447-458, 1990.
- [26] J.F. Sowa, *Conceptual Structures: Information Processing in Mind and Machine*, Addison-Wesley, Reading, MA, 1984.
- [27] J. Sudano, *Yet Another Paradigm Illustrating Evidence Fusion (YAPIEF)*, International Conference on Information Fusion, Florence, July 2006.
- [28] R.R. Yager, *On the Dempster-Shafer Framework and New Combination Rules*, Informations Sciences, Vol. 41, pp. 93–137, 1987.

9.7 Appendix: algebras

All the operators defined on the following structures are *inner* operators : $x, y \in \Theta$ brings $x \diamond y \in \Theta$ for the inner operator \diamond . As most of the algebraic properties of this chapter concern the set of possible focal elements $E(\Theta)$, the symbol Θ is used for the algebraic structures. Obviously, dealing with the space of the labels is not different.

9.7.1 Orders and partial orders

(Θ, \leq) is a partially ordered set (*poset*), if for any a, b , and c in Θ , we have that:

reflexivity : $a \leq a$,

antisymmetry : $a \leq b$ and $b \leq a$ implies $a = b$,

transitivity : $a \leq b$ and $b \leq c$ implies $a \leq c$.

If $x \leq y$ and $x \neq y$, we will note $x < y$.

If for any a and b of Θ we have either $a \leq b$ or $b \leq a$ then Θ is called a *totally ordered set* or simply an *ordered set*.

Expressing a label in a ordered or partially ordered set is easier for an human expert than expressing a significant mass in $[0, 1]$.

9.7.2 Lattice

(Θ, \vee, \wedge) is a *lattice* if the *join* operator \vee and the *meet* operator \wedge satisfy for any a , b and c of Θ :

commutativity : $a \vee b = b \vee a$, $a \wedge b = b \wedge a$,

associativity : $(a \vee b) \vee c = a \vee (b \vee c)$, $(a \wedge b) \wedge c = a \wedge (b \wedge c)$,

idempotence : $a \vee a = a$, $a \wedge a = a$,

absorbion : $a \vee (a \wedge b) = a$, $a \wedge (a \vee b) = a$.

The lattice is *closed* if it has a smallest element \perp (its *bottom*) and a greatest element \top (its *top*): for any $x \in \Theta$, $\perp \wedge x = \perp$, $\perp \vee x = x$, $\top \wedge x = x$, $\top \vee x = \top$.

If we just define a join operator, we get a *semi-lattice*.

For any set Θ , $(2^\Theta, \cap, \cup)$ is a lattice.

Defining the relation \leq by $a \leq b$ iff $a \vee b = b$, makes (Θ, \leq) a poset.

9.7.3 Ring and semi-ring

$(\Theta, +, \times)$ is a *ring* if

- the *addition* operator is invertible, associative and commutative, and has a neutral element, called 0_Θ or 0 if not ambiguous;
- the *multiplication* operator is associative, commutative, and has a neutral element, called 1_Θ or 1 if not ambiguous;;
- the multiplication *distributes* over the addition:

$$a \times (b + c) = (a \times b) + (a \times c)$$

This implies $(\Theta, +)$ is a *group*, and (Θ, \times) is a *monoid*.

For most of the fusion applications, the addition does not need to be invertible, so we just need $(\Theta, +)$ be a *semi-group*. So a *semi-ring* structure for $(\Theta, +, \times)$ is sufficient.

9.7.4 Field

A *field* $(\Theta, +, \times)$ is a ring where the multiplication is invertible on $\Theta \setminus \{0\}$. The set of real numbers \mathbb{R} with the usual addition and multiplication is a field.

It is because the real interval $[0, 1]$ is a part of a field that we can use all of the operators and functions of the section 9.2.5, but they are not inner operations for this segment $[0, 1]$: taking x and y in $[0, 1]$ can lead to $x^{-1} \notin [0, 1]$ and $x+y \notin [0, 1]$.

9.7.5 Vector space

$(\Theta, +, \bullet)$ is a *vector space* over a field \mathbb{F} if $+$ is an inner operator which is invertible, associative and commutative, and has a neutral element 0. The operator \bullet is the external multiplication, also called scalar multiplication, by an element of \mathbb{F} , satisfying, for any a and b in \mathbb{F} and x and y in Θ :

- Distributivity of \bullet over $+$: $a \bullet (x + y) = a \bullet x + a \bullet y$,
- Distributivity of addition over \bullet : $(a +_{\mathbb{F}} b) \bullet x = a \bullet x + b \bullet x$,
- Associativity of multiplications: $(a \times_{\mathbb{F}} b) x = a \bullet (b \bullet x)$.

9.7.6 Algebra over a field

$(\Theta, +, \times, \bullet)$ is an *algebra* over a field \mathbb{F} if $(\Theta, +, \times)$ is a ring, $(\Theta, +, \bullet)$ is vector space over \mathbb{F} , and for any a and b in \mathbb{F} and x and y in Θ we have $(a \bullet x) \times (b \bullet y) = (ab) \bullet (x \times y)$. The multiplication between a and b in (ab) is the multiplication defined in the field \mathbb{F} : $ab = a \times_{\mathbb{F}} b$.

A field can be seen as an algebra over itself, indentifying the inner multiplication and the scalar multiplication: $(\mathbb{R}, +, \bullet, \bullet)$.

No richer algebraic structure will be considered for the fusion applications presented in this chapter.

Chapter 10

Analysis of DS_m belief conditioning rules and extension of their applicability

Milan Daniel
Institute of Computer Science,
Academy of Sciences of the Czech Republic,
Pod vodárenskou věží 2, CZ - 182 07,
Praha 8, Czech Republic.
milan.daniel@cs.cas.cz

Abstract: *Analysis of belief conditioning rules (BCRs) is presented in this chapter. Some simplifications of formulas for BCRs are suggested. A comparison of BCRs with classic rules of conditioning is performed. Finally, definition domains and applicability of BCRs are extended. Full formal definition of the extended version of BCR12 is presented.*

The work was supported by ESF EUROCORES FP006 project ICC/08/E018 of the Grant Agency of the Czech Republic and the Institutional Research Plan AV0Z10300504 "Computer Science for the Information Society: Models, Algorithms, Applications".

10.1 Introduction

This chapter is devoted to belief conditioning in DSmT. We have a (generalized) belief function (BF) given by a (generalized) basic belief assignment (bba) m on a hyper-power set D^Θ , which should be conditioned assuming a sure assumption that the truth is in a given A where $A \in D^\Theta \setminus \emptyset$.

A long series of 31 belief conditioning rules (BCRs) was defined in DSm book vol. 2 [11]. One of the rules — BCR12 — was regarded to be a generalization of Shafer's (i.e., Dempster's) rule of conditioning in the free DSm model, the others are its alternatives. Several techniques are combinatorically combined to define BCRs there. A detailed analysis of all the 31 BCRs has just appeared in Technical Report [6]. The report presents also a comparison of all BCRs with Dempster's rule of conditioning and with its real generalization to DSm hyper-power sets. Based on the presented analysis, extended definitions of BCRs are introduced there. These definitions as much as possible enable to extend definition domains of the rules to increase their applicability to wider class of belief functions.

In this chapter we present the main results of the analysis, the idea of extended definitions, and the complete formal definition of the extended version of BCR12. This theoretical text provides also a series of examples illuminating its theoretical results.

This chapter follows Chapter 9 [12] from DSm book vol. 2 [11], thus it is recommended (but not necessary) to read [12] in advance. Also, the reader can find author's notation of DSmT in Chapter 3 of [11].

10.2 Brief preliminaries

As this is a chapter in the 3rd volume on DSmT we suppose that reader is already familiar with the basis of DSmT, otherwise Chapters 1 and 4 of the 1st volume and/or Chapter 3 of the 2nd volume or the brief introduction from DSmT homepage¹ are recommended. Hence we do not repeat all the general basic notions here, but only principal of those which are closely related to belief conditioning rules.

Conditioning of a basic belief assignment (bba) m by a set A : Smarandache & Dezert assume in [12] that $A \in D^\Theta \setminus \emptyset$, this works in the free DSm model \mathcal{M}^f . Unfortunately there is no explicit mention of any hybrid DSm model in [12], assumptions about hybrid models are hidden there. Nevertheless when working with hybrid DSm models we have to explicitly say these assumptions. We assume that $A \neq \emptyset$ and that all bbms are correctly defined on the hybrid DSm model which is used. Further all denominators of formulas are assumed to be non-zero, see corrigenda of Chapter 9 of [11].

Rules BCR2–11 use splitting of Θ as it is defined in DSm Book vol. 2 Chap. 9, i.e., $\Theta = D_1 \cup D_2 \cup D_3$, where $D_1 = \{X \mid \emptyset \neq X \in D^\Theta, X \subseteq A\}$, $D_2 = ((\Theta \setminus s(A)), \cap, \cup)$, $s(A)$ is the set of all elements of Θ , which compose A , $D_3 = D^\Theta \setminus (D_1 \cup D_2 \cup \emptyset)$.

¹www.gallup.unm.edu/~smarandache/DSmT.htm.

Rules BCR12–31 use D_2 further splitted in two parts $D_{2D} = \{X|X \in D_2 \ \& \ X \cap A \equiv \emptyset\}$, $D_{2I} = \{X|X \in D_2 \ \& \ X \cap A \not\equiv \emptyset\}$, where bbms of focal elements for D_{2I} are processed in the same way (BCR12-BCR21) or in a similar way (BCR22-BCR31) as those from D_3 . Hence there is a new modified splitting of Θ into 3 disjoint parts: $\Theta = D_S \cup D_D \cup D_I = D_1 \cup D_{2D} \cup (D_{2I} \cup D_3)$, defined in [6]. The new splitting $\Theta = D_S \cup D_D \cup D_I$ (to $D_S = D_1 \dots$ non-empty subsets² of A , $D_D = D_{2D} \dots$ sets disjunctive from A , $D_I = D_{2I} \cup D_3 \dots$ non-subsets of A , but intersecting A) is more intuitive. Nevertheless due to editors' wish, and to consistency with DSm book vol. 2 and chapters of this volume we use the original notation $\Theta = D_1 \cup (D_{2D} \cup D_{2I}) \cup D_3$ in this text.

Let $W \in D_3$, we say that $X \in D_1$ is the k -largest, $k \geq 1$, element from D_1 that is included in W , if $(\exists Y \in D_1 \setminus \{X\})(X \subset Y, Y \subset W)$; depending on the model, there are $k \geq 1$ such elements, see [12], corrigenda of page 240. The same is used also for $W \in D_2$, such that $W \cap A \neq \emptyset$. For definitions of k -smallest, k -median and k -average elements from D_1, D_2 see [12].

10.3 Belief conditioning rule BCR1

Belief Conditioning Rule no. 1 (BCR1) is defined for $X \in D_1$ by the formula³

$$m_{BCR1}(X|A) = m(X) + \frac{m(X) \sum_{Z \in D_2 \cup D_3} m(Z)}{\sum_{Y \in D_1} m(Y)} = \frac{m(X)}{\sum_{Y \in D_1} m(Y)}.$$

Alternatively, we can write:

$$m_{BCR1}(X|A) = \frac{m(X)}{\sum_{Y \in D_1} m(Y)} = \frac{m(X)}{\sum_{Y \subseteq A} m(Y)} = \frac{m(X)}{Bel(A)}.$$

$$m_{BCR1}(X|A) = 0 \text{ for } X \in D^\Theta \setminus D_1.$$

BCR1 is the simplest belief conditioning rule. This rule is a generalization of Belief Focusing Rule⁴ defined in D-S theory.

The rule is not defined for Vacuous Belief Function (VBF) for which $m_{VBF}(\Theta) = 1$, it is further not defined e.g. for $m'_{BCR1}(X|\{\theta_1 \cup \theta_2 \cup \theta_3 \cup \theta_4\})$, when $m'(\theta_2 \cup \theta_3 \cup \theta_4 \cup \theta_5) = 1$, etc. In general, $m_{BCR1}(X|A)$ is not defined whenever $Bel(A) = \sum_{Y \subseteq A} m(Y) = \sum_{Y \in D_1} m(Y) = 0$.

The rule is very sensitive with respect to $m(X)$ for $X \subseteq A$, on the other hand all bbms $m(Y)$ such that $Y \cap A \neq \emptyset$ & $Y \not\subseteq A$ are completely ignored by BCR1, see

² More precisely subsets which are not equal to empty set in the case of hybrid DSm models.

³We have to put stress on the fact, that it is necessary to keep in mind, that definition of sets D_1, D_2, D_3 , i.e. splitting of D^Θ , depends on the conditioning set A , which is included in the formula through the set D_1 .

⁴This rule was mentioned in [8], unfortunately, the author of this chapter does not know its original publication.

example 1. Bbm $m(Y)$, where $Y \cap A \neq \emptyset$ may be even assigned to subset of A , which is disjoint from Y (i.e., which has empty intersection⁵ with Y), see example 2.

Example 1. Let us suppose $\Theta = \{a, b, c\}$, the free DSm model \mathcal{M}^f , $m(a) = 0.001$, $m(b) = 0.004$, $m(a \cup c) = 0.800$, $m(b \cup c) = 0.195$ and conditioning set $A = \{a, b\} = a \cup b$. We obtain $m_{BCR1}(a|A) = 0.20$, $m_{BCR1}(b|A) = 0.80$, regardless to large bbm $m(a \cup c)$.

Moreover if we significantly decrease the bbm of $b \cup c \not\subseteq A$ in favour of $a \cup c \not\subseteq A$ as it follows in m' , the resulting conditional bba $m'_{BCR1}(X|A)$ does not reflect it: $m'(a) = 0.001$, $m'(b) = 0.004$, $m'(a \cup c) = 0.990$, $m'(b \cup c) = 0.005$, $m'_{BCR1}(a|A) = 0.20$, $m'_{BCR1}(b|A) = 0.80$.

On the other side, if we slightly decrease the same bbm of $b \cup c \not\subseteq A$ in favour of $a \subseteq A$ then the conditioned bba is changed (ignoring size of $m(X)$ for $X \not\subseteq A$ again): $m''(a) = 0.006$, $m''(b) = 0.004$, $m''(a \cup c) = 0.800$, $m''(b \cup c) = 0.190$, $m''_{BCR1}(a|A) = 0.60$, $m''_{BCR1}(b|A) = 0.40$.

Example 2. Let us suppose $\Theta = \{a, b, c\}$ and any hybrid DSm model, where $a, b \cup c \neq \emptyset$. For $m(a) = 0.1$, $m(a \cup c) = 0.1$, $m(b \cup c) = 0.8$ and conditioning set $A = a \cup b$. We obtain $m_{BCR1}(a|A) = 1$ regardless to large value $m(b \cup c)$. Set a may be disjoint from $b \cup c$, e.g. in Shafer's DSm model.

For comparison with the other belief conditioning rules we can rewrite BCR1 as it follows:

$$m_{BCR1}(X|B) = m(X) + m(X) \frac{\sum_{W \in D_2} m(W)}{\sum_{Y \in D_1} m(Y)} + m(X) \frac{\sum_{W \in D_3} m(W)}{\sum_{Y \in D_1} m(Y)}.$$

Thus $m(X)$ is kept to be assigned to X for all $X \subseteq A$, and $m(X)$ is proportionalized according to $m(Y)$ for all $Y \subseteq A$ (i.e., $Y \in D_1$) otherwise.

10.4 Belief conditioning rules BCR2–BCR11

Generalized basic belief masses of all focal elements X from D_1 are kept to be assigned to X again, and generalized basic belief masses of all focal elements W from D_2 are in the same way proportionalized among all subsets of conditioning set A by all belief conditioning rules BCR2–BCR11. These subsets are proportionalized according to belief masses $m(Y)$ of subsets Y of the conditioning set A .

10.4.1 Belief conditioning rules BCR2–BCR6

Generalized basic belief masses of all focal elements W from D_3 are in similar ways reallocated by belief conditioning rules BCR2–BCR6. Ways of this reallocation specify and mutually differ BCRs from this group. What does it mean $W \in D_3$? It means

⁵This feature depends from a hybrid DSm model which is used; it cannot occur in the case of the free DSm model, where there is no empty intersection.

that W is neither from D_1 , i.e. $W \not\subseteq A$, nor from D_2 , thus some θ_i appear(s) in W which appear(s) also in A , hence $W \cap A \neq \emptyset$.

Similarly to BCR1, none of BCR2 – BCR6 rules are defined for BFs, such that $Bel(A) = \sum_{Y \in D_1} m(Y) = 0$; these cases⁶ are not even mentioned in [12].

We will repeat neither the original formulas from [12] for all BCRs, nor the new compact parametric ones from [6], and make only comments related to BCR2 and BCR6.

10.4.1.1 BCR2 — intersection of $W \in D_3$ with conditioning set A

Rule BCR2 relocates $m(W)$ for $W \in D_3$ to k -largest (k -maximal) elements of D_1 which are subset of W , i.e. to k -largest (k -maximal) elements of $W \cap A$. The largest (maximal) subset of $W \cap A$ is $W \cap A$ itself and it is unique, thus it is 1-largest and we can write BCR2 as it follows:

$$m_{BCR2}(X|A) = m(X) + m(X) \frac{\sum_{W \in D_2} m(W)}{\sum_{Y \in D_1} m(Y)} + \sum_{\substack{W \in D_3 \\ X=W \cap A}} m(W),$$

for all bbas m and conditioning sets A , such that $Bel(A) = \sum_{Y \in D_1} m(Y) \neq 0$. Hence all bbms $m(W)$ from D_3 are relocated to $W \cap A$ by this rule.

10.4.1.2 BCR6 — all non-empty subsets of $W \cap A$

BCR6 splits bbms $m(W)$ from D_3 into same portions and redistributes them among all subsets of $W \cap A$, thus we can slightly simplify its formula as follows:

$$m_{BCR6}(X|A) = m(X) + m(X) \frac{\sum_{W \in D_2} m(W)}{\sum_{Y \in D_1} m(Y)} + \sum_{\substack{W \in D_3 \\ X \subseteq W}} \frac{m(W)}{Card\{V|\emptyset \neq V \subseteq W \cap A\}}.$$

10.4.1.3 Analysis of BCR2–BCR6

The problems which are presented in examples 1 and 2 do not occur using rules BCR2–BCR6 as bbms of sets from D_3 are not proportionalized according to $m(X)$ for $X \in D_1$. On the other hand these bbms $m(W)$ are blindly distributed among several or all subsets of $W \cap A$ by rules BCR3–BCR6, see continuation of Example 2. We also have to note, that as BCR1, rules BCR2–BCR6 proportionalize all bbms of sets from D_2 according to bbms $m(X)$ for $X \in D_1$; which can be often odd and not intuitive, see Example 3.

⁶The cases where $Bel(A) = 0$ are denoted to be degenerated in [13], and any BCR is defined as $m(A|A)$, $m(X|A) = 0$ for $X \neq A$ in the section on BCRs in [13] (the paper on new qualitative belief conditioning rules (QBCRs)). For more details see the appendix.

Example 2 (cont.). Let us suppose the free DSm model \mathcal{M}^f now. When redistributing bbm $m(b \cup c) = 0.8$ we have $W \cap A = (b \cup c) \cap (a \cup b) = b \cup (a \cap c)$ with DSm cardinality $Card_{DSm} = 5$, there are 9 proper subsets of $W \cap A$ in the free DSm model; $Card_{DSm} = 1 : a \cap b \cap c$, $Card_{DSm} = 2 : a \cap b, a \cap c, b \cap c$, $Card_{DSm} = 3 : a \cap (b \cup c), b \cap (a \cup c), c \cap (a \cup b)$, $Card_{DSm} = 4 : b, (a \cap b) \cup (a \cap c) \cup (b \cap c)$. $m(b \cup c)$ is relocated to whole $W \cap A$ by BCR2, $W \cap A = b \cup (a \cap c)$ in the free DSm model and it naturally can be different in various hybrid DSm models, e.g., just b in Shafer's model. $m(b \cup c)$ is relocated to $a \cap b \cap c$ by BCR3 in the free DSm model; it is divided by 3 and redistributed among $a \cap (b \cup c), b \cap (a \cup c), c \cap (a \cup b)$ by BCR4 and BCR5 in the free DSm model; and it is divided by 10 and redistributed among all subsets of $b \cup (a \cap c)$ in the free DSm model. In this simple example, $m(b \cup c)$ is relocated to b by all of BCR2–BCR6 rules in the case of Shafer's model.

Example 3. Let us suppose $\Theta = \{a, b, c\}$ and the free DSm model \mathcal{M}^f again. For $m(a) = 0.01, m(b) = 0.04, m(a \cup c) = 0.50, m(b \cup c) = 0.05, m(c) = 0.40$ and conditioning set $A = a \cup b$. c is in D_2 , thus $m(c)$ is proportionalized between a and b in the ration $m(a) : m(b)$, i.e. $1 : 4$, by all of BCR2–BCR6 rules, regardless the fact that a is significantly more plausible through $m(a \cup c)$ than b is through $m(b \cup c)$.

In the modified example $m'(a) = 0.001, m'(b \cup c) = 0.450, m'(c) = 0.549$ whole $m'(c)$ is relocated to a by all BCR2–BCR6 rules; $m'(b \cup c)$ is relocated or redistributed among subsets of $m'(b \cup c) \cap (a \cup b)$ as it follows:

$$\begin{aligned} m'_{BCR2}(a|A) &= 0.550, m'_{BCR2}((b \cup c) \cap (a \cup b)|A) = 0.450, \\ m'_{BCR3}(a|A) &= 0.550, m'_{BCR3}(a \cap b \cap c|A) = 0.450, \\ m'_{BCR4}(a|A) &= 0.550, m'_{BCR4}(a \cap (b \cup c)|A) = 0.150, \\ m'_{BCR4}(b \cap (a \cup c)|A) &= 0.150, m'_{BCR4}(c \cap (a \cup b)|A) = 0.150, \\ m'_{BCR6}(a|A) &= 0.550, m'_{BCR6}((b \cup c) \cap (a \cup b)|A) = 0.045, m'_{BCR6}(b|A) = 0.045, \\ m'_{BCR6}((a \cap b) \cup (a \cap c) \cup (b \cap c)|A) &= 0.045, m'_{BCR6}(a \cap (b \cup c)|A) = 0.045, \\ m'_{BCR6}(b \cap (a \cup c)|A) &= 0.045, m'_{BCR6}(c \cap (a \cup b)|A) = 0.045, m'_{BCR6}(a \cap b|A) = \\ &= 0.045, m'_{BCR6}(a \cap c|A) = 0.045, \\ m'_{BCR6}(b \cap c|A) &= 0.045, m'_{BCR6}(a \cap b \cap c|A) = 0.045 \end{aligned}$$

(results by BCR5 are the same as those by BCR4 in this example).

For comparison we obtain $m'_{DRC}(a|A) = 0.0022, m'_{DRC}((b \cup c) \cap (a \cup b)|A) = 0.9978$, by the generalized Dempster's rule of conditioning [3].

As it is mentioned in [12], bbms $m(W)$ for $W \in D_3$ are blindly divided by k according the number of sets among those it should be redistributed, regardless of bbms of those sets.

The way of bbm relocation in BCR2 rule is referred as the most *pessimistic/prudent* one and that in BCR3 as the most *optimistic* one. Nevertheless the difference among the rules does not seem to be related to optimism/pessimism, but it is a question of addition or non-addition of an extra additional information when $m(W)$ is redistributed for $W \cap A \neq \emptyset, W \not\subseteq A$, or what additional information is added. Similarly relocation of all $m(W)$ to absorbing $\cap_{i=1, \dots, n} \theta_i$ by BCR3 really does not express any optimism.

When relocating $m(W)$ to $W \cap A$ in BCR2 no additional information is added. All other redistributions of $m(W)$ for $W \in D_3$ in BRC3–BCR6 add to m some additional information, which is mainly based on the specific rule and partly on bbms $m(Y)$ for $Y \in D_1$. Nevertheless there is no need to add any information within conditioning, and definitely there is no reasonable motivation for redistribution of $m(X)$ among sets given by k -median or by k -average as it is performed by BCR4 and BCR5.

Really, from conditioning set A we only know that $m(W)$ should be located to A and/or some of its subsets. From m we only know that $m(W)$ should be located to W (if it is acceptable by A). Hence we know that $m(W)$ conditioned by A should be located to $W \cap A$. We do not know anything more using both the sources of information bba m and conditioning set A . Any other precision of focal elements is addition of some kind of an extra information (out of m and A).

10.4.2 Belief conditioning rules BCR7–BCR11

Analogically to the previous subsection, we can formulate also BCR7–BCR11 rules in the more compact parametric form, see [6]. Similarly to BCR1–BCR6, BCR7 – BCR11 rules are defined for BF's, such that $Bel(A) = \sum_{Y \in D_1} m(Y) \neq 0$ again. Rules BCR8–BCR11 really improve belief conditioning, as they remove blind redistribution of bba W (i.e., division by k) whenever $S(W) \neq 0$; $m(W)$ is redistributed respecting W (only among subsets of W), nevertheless it is proportionalized according $m(Y)$ for $Y \subset A$, thus sensitivity to the values $m(Y)$ for $Y \subset A$ increases and the problem of relocation/redistribution of $m(W)$ for $W \in D_2$ continues.

Because a part of $\{m(W)|W \in D_2\}$ is redistributed among subsets of $W \cap A$ even by BCR7, which uses the k -largest element, the rule BCR7 also add some more additional information within the combination in comparison with BCR2. Thus the change obtained using fractions $m(W)/S(W)$ is counter intuitive in the case of BCR7.

10.5 Belief conditioning rules BCR12–BCR31

The rules from this large group start to distinguish whether $W \cap A$ is empty or non-empty for $W \in D_2$. $m(W)$ are relocated or redistributed in the same or analogical way as those form D_3 in the case of non-empty intersection with A . Thus we can use D_S, D_I, D_D instead of D_1, D_2, D_3 for simplification and higher understandability of formulas, see [6]. Similarly to all the previous rules, BCR12 – BCR31 rules are defined⁷ for BF's, such that $Bel(A) = \sum_{Y \in D_1} m(Y) \neq 0$.

10.5.1 Belief conditioning rules BCR12–BCR16

Bbms of focal elements from both intersective sets of D_{2I} and D_3 are processed in the same way of particular redistribution; this corresponds to class (D_2^p, D_3^p) in the

⁷None of BCRs is defined for $Bel(A) = 0$ in [12].
All BCRs are defined $m(A|A) = 1, m(X|A) = 0$ for $X \neq 0$ if $Bel(A) = 0$ in [13].

classification of the BCRs, see Section 5 in [12].

The rules really improve conditioning again, as $m(W)$ is redistributed only inside $W \cap A$ whenever it is non-empty. The difference among individual rules BCR12–BRC17 is again related to an extra additional information which is added to the original belief within conditioning. Why some information is added within conditioning? There is really no need for it. No information is added when $m(W)$ is relocated to $W \cap A$ by BCR12, thus the rule is the best from these rules. It also corresponds to the fact that it is one of two rules which are recommended by Dezert and Smarandache in [12]. Nevertheless, in the case of hybrid DSm models, the sensitivity with respect to $m(W)$ for $W \in D_1$ within conflicting bbm (when $W \cap A = \emptyset$) redistribution remains similarly to all other DSm BRC rules from [12]. This sensitivity was removed only in the case of the free DSm model, where $D_{2I} = D_2$ and $D_{2D} = \emptyset$, thus all $m(W)$ are redistributed inside $W \cap A$ for all $W \in D_2 \cup D_3$. This of course does not hold for hybrid DSm model in general.

Example 3 (cont.). Let us suppose the free DSm model M^f , again. $c \in D_2$, $c \cap (a \cup b) \neq \emptyset$ in M^f , thus $c \in D_{2I}$ more precisely. Hence $m(c)$ is relocated to $c \cap (a \cup b)$ using BCR12, or redistributed among subsets of $c \cap (a \cup b)$ using BCR13–BCR16.

Let us suppose a hybrid DSm model with a constraint $c \cap (a \cup b) \equiv \emptyset$ now; it trivially holds e.g. in Shafer's model M^0 . In this case $c \in D_{2D}$ and $m(c)$ is redistributed between a and b in the ratio 1 : 4 by all BCR11–BCR16, in the same way as by BCR2–BCR6.

Similarly in the modified example under the constraint $c \cap (a \cup b) \equiv \emptyset$, the entire $m'(c)$ is relocated to the element a by all BCR11–BCR16 in the same way as it is done by BCR2–BCR6.

10.5.1.1 A simplification of BCR12

Using of intersection \cap instead of the superfluous notion k -largest and the equation $\sum_{Y \in D_1} m(Y) = \sum_{Y \subseteq A} m(Y) = Bel(A)$ we can simplify formula for BCR12 as it follows (for detail see [6]):

$$m_{BCR12}(X|A) = \sum_{W \cap A \equiv X} m(W) + \frac{m(X)}{Bel(A)} \cdot \sum_{Z \cap A \equiv \emptyset} m(Z).$$

In the special case of the DSm free model we have⁸

$$m_{BCR12}(X|A) = \sum_{W \cap A \equiv_{M^f} X} m(W).$$

In Shafer's DSm model we have

$$m_{BCR12}(X|A) = \sum_{W \cap A = X} m(W) + \frac{m(X)}{Bel(A)} \cdot \sum_{Z \cap A = \emptyset} m(Z).$$

⁸Note, that this simplification for the free DSm model is already extended in the sense of Section 10.7.

10.5.2 Belief conditioning rules BCR17–BCR21

Focal elements of both D_{2I} and D_3 are processed in the same way again, this time in the way of 'splitted redistribution'; this corresponds to class (D_2^s, D_3^s) , see Section 5 in [12].

Rules BCR17–BCR21 are improvements of BCR7–BCR11, as $m(W)$ is not relocated out of $W \cap A$ whenever non-empty. Moreover rules BCR18–BCR21 decrease a 'blind' redistribution (i.e. division by k) of $m(W)$ with respect to rules BCR13–BCR16. BCR17 does not add any additional information when $m(W)$ is relocated to $W \cap A$ for $W \in D_{2I}$ or $W \in D_3$ where $Bel(W \cap A) = 0$. On the other hand, similarly to BCR7, also BCR17 brings some additional information, which is not added by BCR12, this arises whenever $W \in D_{2I} \cup D_3$ & $Bel(W \cap A) \neq 0$.

10.5.2.1 BCR17

Analogically to BCR12, we can simplify BCR17 as it follows

$$m_{BCR17}(X|A) =$$

$$\sum_{\substack{W \cap A \equiv X \\ W \subseteq A \vee Bel(W \cap A) = 0}} m(W) + \frac{m(X)}{Bel(A)} \cdot \sum_{Z \cap A \equiv \emptyset} m(Z) + m(X) \cdot \sum_{\substack{X \subseteq W, W \not\subseteq A \\ Bel(W \cap A) \neq 0}} \frac{m(W)}{Bel(W \cap A)}.$$

For special cases in the free DSm model and in Shafer's DSm model see [6].

10.5.3 The remaining belief conditioning rules

These rules are just variations of BCR17-BCR21, where the idea of proportionalization of $m(X)/Bel(W \cap A)$ (cf. $m(X)/S(W)$ in [12]) is applied only to D_{2I} or to D_3 . It is applied to $m(W)$ for W from D_3 in BCR22–BCR26, whereas for W from D_{2I} , in BCR27–BCR31.

We can notice that $Bel(W \cap A)$ is always 0 for $W \in D_{2D}$, thus difference between the above two groups of rules can arise only for $W \in D_{2I}$ and $W \in D_3$.

We can further notice that a part of $m(W)$ where $W \cap A \neq \emptyset$ (i.e. $W \in D_{2I} \cup D_3$) is proportionalized, whereas the rest is blindly divided by k (it corresponds to classes (D_2^p, D_3^p) and (D_2^s, D_3^s) in [12]), unfortunately there is no reasonable explanation or motivation for it. This seems to be non-intuitive or even counter-intuitive; in correspondence with this, both of the groups of rules are counter-intuitive. It also corresponds to the fact, that there is no formula for any of BCR22–BCR31 presented in [12]. Hence there is no need for further analysis of these rules.

10.6 Comparison of BCRs with the classic rules

10.6.1 BCR1

As it was already mentioned in Section 10.3, BCR1 rule is just the generalization of the belief focusing rule [3]. From the generalized Dempster's rule of conditioning⁹ (DRC) it differs by processing of $m(W)$ both for W from D_2 and from D_3 . Thus BCR1 coincides with DRC just for belief functions with focal elements from D_1 , i.e., whenever all focal elements are subsets of the conditioning set A ; $m(X|A) = m(X)$ in such a case.

In the same way all BCRs coincide with the generalized belief focusing rule and (hence also with DRC) whenever $Bel(A) = 1$, and differ from it otherwise.

10.6.2 BCR2–BCR6

All BCRs from this group differ from DRC by processing of $m(W)$ for W from D_2 . BCR2 coincides with DRC whenever BCR2 is defined and all focal elements are from $D_1 \cup D_3$. Rules BCR3–BCR6 add more additive information, than BCR2 does, and they differ from DRC also for BFs with focal elements from D_3 .

10.6.3 BCR7–BCR11

All of these rules add more information than BCR2 does, thus all of these rules differ from DRC whenever their focal elements are out of D_1 (i.e., if there exists a focal element which is not subset of A , i.e. if $Bel(A) < 1$).

10.6.4 BCR12–BCR16

All BCRs from this group differ from DRC by processing of $m(W)$ for W from D_{2D} . BCR12 coincides with DRC whenever it is defined and all the focal elements are from $D_1 \cup D_3 \cup D_{2I}$. Rules BCR13–BCR16 add more additive information, than BCR12 does, and they differ from DRC also for BFs with focal elements from $D_{2I} \cup D_3$.

⁹ The original rule was defined by Shafer in [9] and called Dempster's rule of conditioning there. This name is generally used in belief function literature, see e.g. [10]. Nevertheless the editors of this volume started to call the rule Shafer's conditioning rule in [12].

The generalization to hyper-power sets was defined by the author of this chapter in [3] as:

$$m(X|A) = K \sum_{A \cap Y \equiv X} m(Y) = \frac{\sum_{A \cap Y \equiv X} m(Y)}{\sum_{A \cap Y \neq \emptyset} m(Y)}$$

for $\emptyset \neq X \subseteq A$, $X, A \in D_M^\emptyset$, where $K = \frac{1}{1-\kappa}$, $\kappa = \sum_{Y \in D^e, A \cap Y \equiv \emptyset} m(Y)$, and $m(X|A) = 0$ otherwise, i.e., for $X \equiv \emptyset$, $X \not\subseteq A$ and for $X \notin D_M^\emptyset$. The rule is defined (applicable) whenever $\kappa < 1$, i.e., whenever there exists $Y \in D_M^\emptyset$, $Y \cap A \neq \emptyset$, such that $m(Y) > 0$.

To avoid any confusions with the name of the rule, we will not use any personal name in this chapter a denote the rule simply as (the generalized) DRC.

We have seen that the mechanism of BCR12 does not coincide with DRC in general as the rules handle focal elements from D_{2D} in different ways. From the same reason, the rules do not coincide either in Shafer's model, see also the special case of the formula for BCR12 in Subsection 10.5.1.1. Hence we cannot consider BCR12 as a generalization¹⁰ of DRC, which conservatively extends the original DRC.

10.6.5 BCR17–BCR21

All of these rules add more information than BCR12 does, thus all of these rules differ from DRC whenever their focal elements are out of D_1 (i.e., if there exists a focal element which is not subset of A).

10.6.6 BCR22–BCR31

Formulas for the rules BCR22–BCR26 (resp. BCR27–BCR31) are similar to those for BCR12–BCR16, but the rules add more information when processing $m(W)$ for $W \in D_3$ ($W \in D_{2I}$ resp.). Thus all BCRs from this group differ from DRC by processing of $m(W)$ for W from $D_{2D} \cup D_3$ (from $D_{2D} \cup D_{2I} = D_2$ resp.). BCR22 coincides with DRC whenever all focal elements are from $D_1 \cup D_{2I}$. Rules BCR23–BCR26 add more additive information, than BCR22 does, and they differ from DRC also for BFs with focal elements from D_{2I} .

BCR27 coincides with DRC, similarly to BCR2 whenever all focal elements are from $D_1 \cup D_3$. Rules BCR28–BCR31 add more additive information, than BCR27 does, and they differ from DRC also for BFs with focal elements from D_3 .

We have to mention, that the information added in the case of $W \in D_{2I}$ is different from that which is added by BCR2–BCR6. It is based on proportionalization according to $m(Y)$ for $Y \subseteq A$ in BCR2–BCR6, whereas on 'splitted proportionalization' according to $m(Y)$, $Y \cap A \neq \emptyset$ in BCR27–BCR31. Thus even if the coincidence with DRC is the same for two groups of BCRs BCR2–BCR6 and BCR27–BCR31, this does not mean that these two groups of rules coincide themselves in general. The coincidence of the whole groups holds only when these rules coincide with DRC and for other special situations.

10.6.7 Comparison of definition domains

All BCR1–BCR31, as they are defined in [12], have the same definition domain. These rules are not defined¹¹ whenever $Bel(A) = 0$, i.e., if $m(W) = 0$ for all $W \subseteq A$. DRC

¹⁰Let us note, that the extension of BCR12 from [13] does not coincide with the generalized DRC either in the DSm free model.

¹¹We follow [12] here. In [13], there is $Dom(BCRs) = \{BFs\}$, i.e., the set of all belief functions. But the extension $m(A|A) = 1$ [13] has a nature of BCR1 and does not correspond with nature and mutual differences of other BCRs.

is not defined only when $m(W) = 0$ for all $W \cap A \neq \emptyset$, i.e., when $Pl(A) = 0$. Thus the definition domain for BCRs is the proper subset of that of DRC:

$$Dom(BCRs) = \{m | Bel(A) \neq 0\} \subset \{m | Pl(A) \neq 0\} = Dom(DRC).$$

From it, we can easily see again, that BCR12 (as it is published in [12]) is not a generalization of DRC either in the free DSm model.

Further we can see that both BCR2 and BCR12 do coincide with DRC neither for all belief functions, which should be processed in the same way, simply because BCR2 and BCR12 are not defined for some of them, thus they are not applicable in such cases.

10.7 Extension of applicability of BCRs

We can see from the above comparison in the previous section, that some of the rules can coincide with DRC even out of their definition domain. We will extend definition domains of BCRs as much as possible in this section. In the same time we will extend the applicability of the rules¹².

10.7.1 Extension of applicability in general DSm models

Limitation for definition domains of all BCRs is division by

$$\sum_{Y \in D_1} m(Y) = \sum_{Y \subseteq A} m(Y) = Bel(A)$$

which should be non-zero. E.g. we cannot conditionalize the vacuous belief function VBF (where $m_{VBF}(\emptyset) = 1$, $m_{VBF}(X) = 0$ otherwise) by any of BCRs.

We cannot do anything more with BCR1, thus its definition domain is really $\{m | Bel(A) \neq 0\}$. It also corresponds with definition domain of belief focusing.

Division by $\sum_{Y \in D_1} m(Y)$ appears when processing bbms from D_2 in BCR2–BCR11: in summand $m(X) \frac{\sum_{W \in D_2} m(W)}{\sum_{Y \in D_1} m(Y)}$. We can extend the definition with a formula without this summand for conditioning in the case of $\sum_{W \in D_2} m(W) = 0$. In this case there is no necessity to redistribute zero bbms of elements of D_2 and the rules produce correct bbas even without the problematic summand. In this way we extend the definition domain of BCR2–BCR11 also for all BFs such that $\sum_{W \in D_1 \cup D_2} m(W) = 0$. Thus $Dom(BCR2-BCR11) = \{m | \sum_{Y \in D_1} m(Y) \neq 0\} \cup \{m | \sum_{W \in D_1 \cup D_2} m(W) = 0\} = \{m | \sum_{Y \in D_1} m(Y) \neq 0\} \cup \{m | \sum_{W \in D_2} m(W) = 0\} = \{m | Bel(A) \neq 0\} \cup \{m | \sum_{W \in D_2} m(W) = 0\}$.

¹²We keep the original Smarandache & Dezert's ideas of BCRs [12] in this chapter. We only try to extend their definition domains and applicability as much as possible, thus we continue to speak about BCR1–BCR31. Just a reformulation and a completion of their definitions is suggested here, not any new rules.

Example 4. *Making a new friend:*

I've met an interesting person in a conference in Paris. His affiliation is in U.S., but I have a strong feeling that he has European origin. He speaks French very well, he has a French friend, he understands my weak Italian, he has spoken about Romania several times. What is my subjective belief about his origin?

Let us suppose a 4-element frame of discernment $\Theta = \{U, I, F, R\}$, where U stands for U.S., I for Italy, F for France, and R for Romania. An origin of my new friend may be mixed, thus application of hyper-power set is adequate. For simplicity, we do not suppose any constraints, and use the free DSm model on Θ in this example.

Let my belief be given by the following bba m : $m(F \cup R) = 0.6$, $m(I \cup R) = 0.1$, $m(\Theta) = 0.3$. Let us learn a sure evidence that my new friend's origin is American or Romanian, thus my belief represented by m should be conditionalized by $U \cup R$: $F \cup R$, $I \cup R$, $\Theta \in D_3$, $\sum_{Y \in D_1} m(Y) = 0$, thus a conditioning by $U \cup R$ is not possible using the original definition of BCRs. $\sum_{Y \in D_2} m(Y) = 0$ as well, thus we can use the extending simplified formula for this case and perform conditionalization as it follows:

$$\begin{aligned} m_{BCR2}(R|U \cup R) &= 0.7, m_{BCR2}(U \cup R|U \cup R) = 0.3; \\ m_{BCR3}(R|U \cup R) &= 0.7, m_{BCR3}(U \cap R|U \cup R) = 0.3; \\ m_{BCR4}(R|U \cup R) &= 0.85, m_{BCR4}(U|U \cup R) = 0.15; \\ m_{BCR5}(R|U \cup R) &= 0.85, m_{BCR5}(U|U \cup R) = 0.15; \\ m_{BCR6}(R|U \cup R) &= 0.775, m_{BCR6}(U|U \cup R) = 0.075, m_{BCR6}(U \cap R|U \cup R) = 0.075, \\ m_{BCR6}(U \cup R|U \cup R) &= 0.075. \end{aligned}$$

Because of $\sum_{Y \in D_1} m(Y) = Bel(U \cup R) = 0$ it holds true also $S(W) = Bel((U \cup R) \cap W) = 0$, hence rules BCR7–BCR11 produce the same results as BCR2–BCR6 do in our example.

We have seen in Example 4 that the definition domains of BCR2–BCR6 and BCR7 – BCR11 were really extended for a class of generalized belief functions given by bbas such that $\sum_{Y \in D_2} m(Y) = 0$. Of course our extension is not sufficient for conditioning of all bbas, see the modified version of Example 4.

Example 4 (modif.). Let my belief be given by a modified bba m' : $m'(F \cup R) = 0.6$, $m'(I \cup R) = 0.1$, $m'(I \cup F) = 0.1$, $m'(\Theta) = 0.2$. It holds true that $\sum_{Y \in D_1} m'(Y) = 0$ again, $I \cup F \in D_2$ thus $\sum_{Y \in D_2} m'(Y) = m'(I \cup F) = 0.1 > 0$, hence we can use neither the original formulas for BCRs (because of division by zero " $\frac{0.1}{0}$ ") nor the simplified formulas (because their assumptions are not satisfied). Thus we cannot apply BCR2–BCR11 in this modified example.

Division by $\sum_{Y \in D_1} m(Y)$ appears when processing bbms from D_{2D} in BCR12–BCR21: in summand $m(X) \frac{\sum_{W \in D_{2D}} m(W)}{\sum_{Y \in D_1} m(Y)}$. Analogically to the previous group of BCRs, we can extend the definition with a formula without this summand for conditioning in the case of $\sum_{W \in D_{2D}} m(W) = 0$. In this case there is no necessity to redistribute zero bbms of elements of D_{2D} and the rules produce correct bbas even without the problematic summand. In this way we extend the definition domain of BCR12–BCR21 also for all BF's such that $\sum_{W \in D_1 \cup D_{2D}} m(W) = 0$. Thus

$$\text{Dom}(BCR12\text{--}BCR21) = \{m \mid \sum_{Y \in D_1} m(Y) \neq 0\} \cup \{m \mid \sum_{W \in D_{2D}} m(W) = 0\} = \{m \mid \text{Bel}(A) \neq 0\} \cup \{m \mid \text{Pl}(A) = 1\}.$$

The same holds also for BCR22–BCR31, hence we obtain $\text{Dom}(BCR22\text{--}BCR31) = \text{Dom}(BCR12\text{--}BCR21) = \{m \mid \text{Bel}(A) \neq 0\} \cup \{m \mid \text{Pl}(A) = 1\}$.

Example 4 (cont.). It holds true that $\sum_{Y \in D_2} m(Y) = 0$ in the example, thus it holds true also $\sum_{Y \in D_{2D}} m(Y) = 0$ and $\sum_{Y \in D_{2I}} m(Y) = 0$. From the first equality we can see that we can apply also BCR12–BCR31, and from the second one, that rules BCR12–BCR16 and BCR27–BCR31 produce the same results as rules BCR2–BCR6. From $\text{Bel}(U \cap R) = \text{Bel}(A) = 0$ it follows also $\text{Bel}(W \cap A) = 0$ and $S(W) = 0$, and that also rules BCR17–BCR21 and BCR22–BCR26 similarly to rules BCR7–BCR11 produce the same results as BCR2–BCR6 in this example. Thus we have:

$$\begin{aligned} m(R \mid U \cup R) &= 0.7, m(U \cup R \mid U \cup R) = 0.3 \text{ also for } BCR12, BCR17, BCR22, BCR27; \\ m(R \mid U \cup R) &= 0.7, m(U \cap R \mid U \cup R) = 0.3 \text{ also for } BCR13, BCR18, BCR23, BCR28; \\ m(R \mid U \cup R) &= 0.85, m(U \mid U \cup R) = 0.15 \text{ also for } BCR14, BCR19, BCR24, BCR29; \\ m(R \mid U \cup R) &= 0.85, m(U \mid U \cup R) = 0.15 \text{ also for } BCR15, BCR20, BCR25, BCR30; \\ m(R \mid U \cup R) &= 0.775, m(U \mid U \cup R) = 0.075, m(U \cap R \mid U \cup R) = 0.075, m(U \cup R \mid U \cup R) = \\ &= 0.075 \text{ also for } BCR16, BCR21, BCR26, BCR31. \end{aligned}$$

For more distinguishing of BCRs we present the following example:

Example 5. Let us take a 3 colour R-G-B example from DSm web page now. Hence we have 3-element $\Theta = \{R, G, B\}$. Let us further suppose the free DSm model \mathcal{M}^f and a simple bba m such that $m(G) = 0.5, m(R \cup G \cup B) = 0.5, m(X) = 0$ otherwise. Let us make a conditioning by $A = R \cup B$.

$\sum_{Y \in D_1} m(Y) = 0$ and $\sum_{Y \in D_2} m(Y) = m(G) = 0.5 > 0$ thus we cannot apply rules BCR2–BCR11 either in their extended versions. $G \cap (R \cup B) \neq \emptyset$ in \mathcal{M}^f , thus $G \in D_{2I}$ and $\sum_{Y \in D_{2D}} m(Y) = 0$ in this example. Hence we can apply BCR12–BCR31 as it follows:

$$\begin{aligned} m_{BCR12}(G \cap (R \cup B) \mid R \cup B) &= 0.5, m_{BCR12}(R \cup B \mid R \cup B) = 0.5; \\ m_{BCR13}(R \cap G \cap B \mid R \cup B) &= 1.0; \\ m_{BCR14}(R \cap G \mid R \cup B) &= m_{BCR14}(B \cap G \mid R \cup B) = 0.25, \\ m_{BCR14}((R \cap G) \cup (R \cap B) \mid R \cup B) &= m_{BCR14}((R \cap G) \cup (G \cap B) \mid R \cup B) = \\ m_{BCR14}((R \cap B) \cup (G \cap B) \mid R \cup B) &= 0.16\bar{6}; \\ m_{BCR15}(R \cap G \mid R \cup B) &= m_{BCR15}(B \cap G \mid R \cup B) = 0.25, \\ m_{BCR15}((R \cap G) \cup (R \cap B) \mid R \cup B) &= m_{BCR15}((R \cap G) \cup (G \cap B) \mid R \cup B) = \\ m_{BCR15}((R \cap B) \cup (G \cap B) \mid R \cup B) &= 0.16\bar{6}; \\ m_{BCR16}(R \cap G \cap B \mid R \cup B) &= m_{BCR16}(R \cap G \mid R \cup B) = m_{BCR16}(B \cap G \mid R \cup B) = \\ m_{BCR16}((R \cap G) \cup (B \cap G) \mid R \cup B) &= 0.163461538, \\ m_{BCR16}(R \cap B \mid R \cup B) &= m_{BCR16}((R \cap G) \cup (R \cap B) \mid R \cup B) = \\ m_{BCR16}((R \cap B) \cup (B \cap G) \mid R \cup B) &= m_{BCR16}((R \cap G) \cup (B \cap G) \cup (R \cap B) \mid R \cup B) = \\ m_{BCR16}(R \mid R \cup B) &= m_{BCR16}(B \mid R \cup B) = m_{BCR16}(R \cup (B \cap G) \mid R \cup B) = m_{BCR16}(B \cup \\ (R \cap G) \mid R \cup B) &= m_{BCR16}(R \cup B \mid R \cup B) = 0.038461538. \end{aligned}$$

From $\text{Bel}(A) = 0$ it follows that $\text{Bel}(A \cap W) = S(W) = 0$, hence rules BCR17–BCR21 produce the same results as rules BCR12–BCR16 do. The same holds true also for rules BCR22–BCR26 and BCR27–BCR31.

Example 4 (modif. cont.). Analogically, we can continue also modified example of new friend as $(U \cup R) \cap (I \cup F) \neq \emptyset$ in the free DSm model and $(I \cup F) \in D_{2I}$, thus $\sum_{Y \in D_{2D}} m(Y) = 0$ again. In this example we obtain:

$$\begin{aligned} m'_{BCR12}(U \cup R | U \cup R) &= 0.2, \quad m'_{BCR12}((F \cup R) \cap (U \cup R) | U \cup R) = 0.6, \\ m'_{BCR12}((I \cup R) \cap (U \cup R) | U \cup R) &= m'_{BCR12}((I \cup F) \cap (U \cup R) | U \cup R) = 0.1; \\ m'_{BCR13}(U \cap R \cap F \cap I | U \cup R) &= 1.0; \\ \text{etc.} \end{aligned}$$

We can summarize our analysis and extension of the definition domains of BCRs now. In the extended case for general hybrid DSm models the following holds:

$$\begin{aligned} \text{Dom}(BCR1) \subset \text{Dom}(BCR2 - BCR11) \subset \text{Dom}(BCR12 - BCR31) \subset \text{Dom}(DRC), \\ \text{Dom}(BCR1) = \{m | \text{Bel}(A) \neq 0\} \subset \text{Dom}(BCR2 - BCR11) \subset \{m | \text{Bel}(A) \neq 0\} \cup \\ \{m | \text{Pl}(A) = 1\} = \text{Dom}(BCR12 - BCR31) \subset \{m | \text{Pl}(A) \neq 0\} = \text{Dom}(DRC). \end{aligned}$$

Hence we can see that applicability of the extended BCRs is still less than that one of DRC in general.

10.7.2 Extension of applicability in the free DSm model

In the special case of the free DSm model \mathcal{M}^f , $X \cap Y \neq \emptyset$ and $\text{Pl}(X) = \text{Pl}(Y) = 1$ always holds true for any $X, Y \in D^\ominus$. Therefore, we can remove the summand $m(X) \frac{\sum_{W \in D_{2D}} m(W)}{\sum_{Y \in D_1} m(Y)}$ from the definitions of the rules regardless of the condition $\sum_{W \in D_{2D}} m(W) = 0$ which always holds true in \mathcal{M}^f .

$$\begin{aligned} \text{Dom}(BCR1) \subset \text{Dom}(BCR2 - BCR11) \\ \subset \text{Dom}(BCR12 - BCR31) = \text{Dom}(DRC). \end{aligned}$$

Where $\text{Dom}(BCR1) = \{m | \text{Bel}(A) \neq 0\}$ as in a general case, and $\text{Dom}(BCR12 - BCR31)$ is a set of all bbas defined on D^\ominus now.

Under this extension, we finally obtain BCR12 as a full generalization of DRC in \mathcal{M}^f , and BCR12 is completely equivalent to the generalized DRC in the DSm free model \mathcal{M}^f .

10.7.3 Extended definition of BCR12

As an example of full formal definition of BRC, we present here the extended version of BCR12, for extended versions of other BCRs see [6].

The extended version of Belief Conditioning Rule no. 12 (BCR12) is defined for $X \subseteq A$ by the formula

$$m_{BCR12}(X|A) = \sum_{W \cap A \equiv X} m(W) + \frac{m(X)}{\text{Bel}(A)} \cdot \sum_{Z \cap A \equiv \emptyset} m(Z),$$

when $Bel(A) \neq 0$, and by the formula

$$m_{BCR12}(X|A) = \sum_{W \cap A \equiv X} m(W),$$

when $\sum_{W \in D_{2D}} m(W) = 0$.

$m_{BCR12}(X|A) = 0$ for $X \not\subseteq A$ as in the original definition. Our extended BCR12 is not defined for BFs such that $Bel(A) = 0$ & $\sum_{W \in D_{2D}} m(W) > 0$.

In the special case of the DSm free model \mathcal{M}^f we have

$$m_{BCR12}(X|A) = \sum_{W \cap A \equiv_{\mathcal{M}^f} X} m(W)$$

in full generality for any BF.

Thus it is the real and complete generalization¹³ of DRC in \mathcal{M}^f .

10.8 Summary of comparison

10.8.1 Summary of coincidence of BCRs with DRC

As it was already mentioned, BCR12 is the best of BCRs as it does not add any additional information when processing $m(W)$ for W from $D_3 \cup D_{2I}$. This rule has also the greatest coincidence with (the generalized) DRC. BCR12 coincides¹⁴ with DRC for BFs where all focal element are from $D_1 \cup D_3 \cup D_{2I}$, i.e. if $Pl(A) = 1$; this trivially holds for any BF which is defined in the free DSm model \mathcal{M}^f .

This coincidence is based on the fact, that there are no conflicts in \mathcal{M}^f and subsequently several combination rules, which are based on intersection of focal elements, mutually coincide in \mathcal{M}^f , see [2] and also Chapter 3 in [11]. Similarly, also DRC and BCR12 coincide in the free DSm model \mathcal{M}^f with the conjunctive rule of combination (with the 2nd argument fixed to m_A , where $m_A(A) = 1$, $m_A(X) = 0$ for $X \neq A$), hence, also with the generalization of Dempster's rule of combination [2].

DRC performs a normalization, i.e., proportionalization of $m(X)$ according to $m(Y)$ for Y such that $Y \cap A \neq \emptyset$, whereas BCR12 performs a proportionalization according to $m(Y)$ for $Y \subseteq A$. Thus all bbms of Y for $Y \cap A \neq \emptyset$ & $Y \not\subseteq A$ are ignored within the proportionalization in BCR12, hence the rule is more sensitive with respect to bbms of $Y \subseteq A$.

BCR2 coincides with DRC for BFs where all focal element are from $D_1 \cup D_3$. BCR27 coincides with DRC for BFs where all focal element are from $D_1 \cup D_3$. BCR22 coincides with DRC for BFs where all focal element are from $D_1 \cup D_{2I}$. All 27 other BCRs coincide with DRC only for BFs where all focal elements are from D_1 (i.e., if $Bel(A) = 1$), i.e., only in the case of trivial conditioning $m(X|A) = m(X)$ for $X \in A$, and $m(X|A) = 0$ otherwise.

¹³This evidently does not hold true for the extension from [13].

¹⁴We consider the generalized DRC and the new extended version of BCRs in this section.

10.8.2 Comparison of BCR1, BCR12 and BCR17 with classic rules of conditioning

Rule BCR12 is somewhere in between BCR1 (that is equivalent to the generalized belief focusing [3]) and the generalized DRC, as bbms of $X \subseteq A$ are kept located to X by all 3 conditioning rules, bbms of X for $X \cap A = \emptyset$ are proportionalized in the same way by BCR1 and BCR12 (according to $m(Y)$ for $Y \subseteq A$), whereas bbms of X for $X \cap A \neq \emptyset$ & $X \not\subseteq A$ are in the same way relocated to $X \cap A$ by BCR12 and (the generalized) DRC.

The ways of relocation/redistribution of bbms $m(W)$ of focal elements in dependence on their relation to conditioning set A are presented in Table 1.

There is a little bit more complicated situation for BCR17, which is somewhere between BCR1 and BCR12. Bbms $m(W)$ are either redistributed as by BCR1 or relocated as by BCR12 according to $S(W) = Bel(W \cap A)$ for $W \in D_{2I} \cup D_3$, bbms $m(W)$ are relocated as by BCR12 for other focal elements, i.e. for $W \in D_1 \cup D_{2D}$, see Table 1 again.

			BCR1	BCR12	BCR17	DRC
1	D_1	$W \subseteq A$	W	W	W	W
2	D_{2D}	$W \cap A \equiv \emptyset$	$Y : Y \subseteq A$	$Y : Y \subseteq A$	$Y : Y \subseteq A$	$Y : Y \cap A \neq \emptyset$
3	D_{2I}	$W \cap A \neq \emptyset$	$Y : Y \subseteq A$	$W \cap A$	*	$W \cap A$
	D_3	$W \cap A \neq \emptyset$	$Y : Y \subseteq A$	$W \cap A$	*	$W \cap A$

* $m(W)$ should be redistributed among $Y : Y \subseteq W \cap A$ if $Bel(W \cap A) \neq 0$, or relocated to $W \cap A$ otherwise.

Table 10.1: Relocation/redistribution of bbm $m(W)$

The second column of the table contains the domain of focal element W , relation of focal element W and of conditioning set A is in the 3rd column, the 4th – 7th columns display the element of $D_{\mathcal{M}}^{\emptyset}$ to which bbm $m(W)$ should be relocated or the set of elements of $D_{\mathcal{M}}^{\emptyset}$ among them $m(W)$ should be distributed. Note: when $m(W)$ to be proportionalized among Y such that $Y \subseteq A$ or $Y \cap A \neq \emptyset$, $m(Y)$ must be positive; when $m(W)$ to be relocated to $W \cap A$ or redistributed among Y such that $Y \subseteq W \cap A$, $m(W \cap A)$ and $m(Y)$ may be also equal to zero.

When computing BCRs according to Table 1, we have to keep the order¹⁵ of steps (see the first column of the table), due to performing step 3 (redistribution of

¹⁵ Notice, that in the changed order (step 3 before step 2) it would be necessary to normalize conflicts in DRC among all non-conflicting elements (i.e. among all elements of $D_{2I} \cup D_3$).

$D_{2I} \cup D_3$) before step 2 changes BCR12 to DRC as step 2 (redistribution of D_{2D}) differs DRC from BCR12.

In the case of other BCRs, it is not possible to say uniquely which rule adds more information within conditioning process in general, i.e. which rule is closer to DRC than another.

For a table of relocation/redistribution of bbm $m(W)$ for all BCRs see [6].

10.9 Conclusions

All of the 31 Belief Conditioning Rules (BCRs) are analysed in this chapter. The important role of the splitting of D_2 into D_{2D} and D_{2I} is underlined here. And a comparison of all 31 BCRs with Shafer's (i.e. Dempster's) rule of conditioning (DRC) is presented.

Based on the results of the presented analysis and the comparison, the definitions of BCRs are extended to be applicable to as wide definition domain as possible. A series of examples illuminating wider applicability of the new extended version of BCRs are displayed.

From the presented theoretical results it follows that BCR12 and BCR17 are really the best of all 31 BCRs, where BCR12 is better, as it adds less additive information within conditioning process. On the other hand, BCR12 cannot be considered a generalization of DRC. The real generalized DRC [3] is briefly recalled.

As the final recommendation for belief conditioning in DSmT, we recommend using BCR12 or the generalized DRC.

10.10 References

- [1] R. G. Almond, *Graphical Belief Modelling*, Chapman & Hall, London, 1995.
- [2] M. Daniel, *A Generalization of the Classic Combination Rules to DSm Hyperpower Sets*, Information & Security. An Int. Journal, 20, pp. 50–64, 2006.
- [3] M. Daniel, *Classical Belief Conditioning and its Generalization to DSm Theory*, Journal of Uncertain Systems, 2, No. 4, 267-279, 2008.
- [4] M. Daniel, *The DSm Approach as a Special Case of the Dempster-Shafer Theory*, In: K. Mellouli (Ed.), Symbolic and Quantitative Approaches to Reasoning with Uncertainty, Proceedings ECSQARU 2007, LNAI 4724, Springer-Verlag, pp. 381–392, 2007.
- [5] M. Daniel, *Contribution of DSm Approach to the Belief Function Theory*, In: L. Magdalena, M. Ojeda-Aciego, J. L. Verdegay (eds.), Proceedings of IPMU'08, Torremolinos (Málaga, Spain), pp. 417–424, June 2008.

- [6] M. Daniel, *Analysis of DSm Belief Conditioning Rules and their Comparison with Dempster's Rule of Conditioning*, Technical Report V-1033. ICS AS CR, Prague, 2009.
- [7] J. Dezert, *Foundations for a New Theory of Plausible and Paradoxical Reasoning*, Information & Security, An International Journal, 9, 2002.
- [8] R. Jiroušek, J. Vejnarová, *Uncertainty in Expert Systems*, Chap. 2 in V. Mařík, O. Štěpánková, J. Lažanský, et al.: *Artificial Intelligence (2)*, (in Czech), Academia, Praha, pp. 78–101, 1997.
- [9] G. Shafer, *A Mathematical Theory of Evidence*, Princeton University Press, Princeton, New Jersey, 1976.
- [10] F. Smarandache, J. Dezert (Editors), *Advances and Applications of DSmT for Information Fusion*, American Research Press, Rehoboth, 2004.
- [11] F. Smarandache, J. Dezert (Editors), *Advances and Applications of DSmT for Information Fusion*, Volume 2, American Research Press, Rehoboth 2006.
- [12] F. Smarandache, J. Dezert, *Belief Conditioning Rules*, Chapter 9 in [11], pp. 237–268, 2006.
- [13] F. Smarandache, J. Dezert, *Qualitative Belief Conditioning Rules (QBCR)*, Fusion 2007 Int. Conf. on Information Fusion, Québec City, July 2007.

10.11 Appendix: comments to implementation

The extension of BCRs defined in section on BCRs in [13] has already been mentioned in several footnotes in this chapter. It is simply defined for all BCRs as $m(A|A) = 1$, $m(X|A) = 0$ for $X \neq A$ when $Bel(A) = 0$. This definition extends definition domain of all BCRs to the entire set of all (generalized) belief functions. The extension enables implementation of BCRs which always produce a result. This extension fits with the nature of BCR1 which is based only on belief masses of focal elements from D_1 , the other focal elements are simply ignored.

Nevertheless, the results of all other BCRs are related also to the focal elements from D_3 and results of BCR12–BCR31 also to the focal elements from D_2 which intersect conditioning set A . This is ignored by the extension from [13]. Our extension defined in this chapter extends BCRs respecting their nature as much as possible, see different results of particular BCRs in Examples 4 and 5. When applying the extension from [13], we obtain $m(U \cup R|U \cup R) = 1$, $m(X|U \cup R) = 0$ for $X \neq U \cup R$ for all BCRs in Example 4, and $m(R \cup B|R \cup B) = 1$, $m(X|R \cup B) = 0$ for $X \neq R \cup B$ for all BCRs in Example 5; all bbms of original focal elements from D_2 and D_3 are ignored by all BCRs.

Of course our extension has one disadvantage from the point of view of its implementation. There are still some possible non-trivial input belief functions, for which some (extended) BCRs are not defined, hence no implementation can provide any result for such an input. In such a case we can combine both the extensions: our from this chapter and that from [13] to extend definitions domains of BCRs as much as possible respecting the nature of particular BCRs. And whenever this extension is not defined we can apply the idea of the extension from [13] and transfer the conflicting belief masses to $m(A|A)$. Thus we obtain BCRs which are defined for all BFs and implementations which always produce some resulting bbms.

In the case of BCR12 we obtain the following formulas:

$$m_{BCR12}(X|A) = \sum_{W \cap A \equiv X} m(W) + \frac{m(X)}{Bel(A)} \cdot \sum_{Z \cap A \equiv \emptyset} m(Z),$$

for $X \subseteq A$ when $Bel(A) \neq 0$, and by the formulas

$$\begin{aligned} m_{BCR12}(A|A) &= \sum_{A \subseteq W} m(W) + \sum_{W \in D_{2D}} m(W), \\ m_{BCR12}(X|A) &= \sum_{W \cap A \equiv X} m(W), \end{aligned}$$

for $X \subset A$ when $Bel(A) = 0$,

$m_{BCR12}(X|A) = 0$ for $X \not\subseteq A$ as in the original definition.

In a special case of BFs such that all focal elements are from D_{2D} we obtain $m_{BCR12}(A|A) = 1$, $m_{BCR12}(X|A) = 0$ for $X \neq A$. $D_{2D} = \emptyset$ in the free DSm model \mathcal{M}^f thus the extension remains the same as it was in subsection 10.7.3 in the case of \mathcal{M}^f .

Considering this combined extension we can apply BCR2-BCR11 also in the case of modified example 4 obtaining the following results:

$$m_{BCR2}(R|U \cup R) = 0.7, m_{BCR2}(U \cup R|U \cup R) = 0.3;$$

$$m_{BCR3}(R|U \cup R) = 0.7, m_{BCR3}(U \cap R|U \cup R) = 0.2, m_{BCR2}(U \cup R|U \cup R) = 0.1;$$

$$m_{BCR4}(R|U \cup R) = 0.8, m_{BCR4}(U|U \cup R) = 0.1, m_{BCR2}(U \cup R|U \cup R) = 0.1;$$

$$m_{BCR5}(R|U \cup R) = 0.8, m_{BCR5}(U|U \cup R) = 0.1, m_{BCR2}(U \cup R|U \cup R) = 0.1;$$

$$m_{BCR6}(R|U \cup R) = 0.75, m_{BCR6}(U|U \cup R) = 0.05, m_{BCR6}(U \cap R|U \cup R) = 0.05,$$

$$m_{BCR6}(U \cup R|U \cup R) = 0.15.$$

$Bel(A) = 0$ implies $S(W) = 0$ and that BCR7-BCR11 produce the same results as BCR2-BCR6 do. Analogically we can make conditioning by any other BCR in situations where our extension from Section 10.7 is not defined.

Applying the idea from this section, we obtain extensions of all BCRs to the set of all (generalized) belief functions such that the original ideas of BCRs [12] are conserved as much as possible.

Part II

Applications of DSmT

Chapter 11

Attribute information evaluation in C&C systems

Ksawery Krenc
RS-SD,
R&D Marine Technology Centre,
Gdynia, Poland.
ksawery.krenc@ctm.gdynia.pl

Adam Kawalec
The Institute of Radioelectronics,
WAT Military University of Technology,
Warsaw, Poland.
Adam.Kawalec@wat.edu.pl

Abstract: *This chapter describes what particular pieces of information about a source should be taken into account in order to get a reasonable assessment of an attribute information retrieved based on the sensor data or human originated information. It has been proven that actual sensor weights and hypotheses masses do not change randomly, but they vary in time according to tracked target motion, however not directly to the target position. It is postulated that the knowledge about target position only is insufficient and at least two dynamical coordinates target state vectors are required to reflect the target orientation, which has an influence on actual hypotheses assessment formed, on the basis of the sensor data or visual sightings.*

Scientific work, financed with science means from 2007 to 2010 as an ordered research project.

11.1 Introduction

Maritime Command and Control (C&C) systems, like other information systems need fusion techniques to deal with evidence (of both kinds: kinematic and attribute) gathered from miscellaneous sensors. When the evidence is imprecise and conflicting, DSMT fusion seems to be an excellent choice. However, DSMT requires basic belief assignment defined to perform the conditioning and combining algorithms [7, 8]. Thus the problem arises, namely how to evaluate the information gathered from diverse sources (including human being), to get a reasonable starting point for the DSMT engine?

The research goal is to invent an attribute information evaluation method for C&C systems purposes to reasonably assess the information from diverse sources. The method must deal with specific sensor characteristics, target motion and provide the results usable for DSMT fusion engine, as well.

Thus, the research problem may be decomposed into two problems:

- Finding a method of evaluating the evidence related to target attributes from diverse types of sources;
- Converting the obtained quality of information into a basic belief assignment.

11.2 Assessing information

Assessing the information source is the first step to be taken in the whole information evaluation process. Usually this kind of evaluation includes source characteristics, like detection and classification zones, reliability parameters and other factors like terrain features, for example.

The analysis of marine C&C systems' needs proves that the evaluation of the information source (even regularly updated) is not enough to perform information fusion on the satisfactory level.

Most of applied soft-decision fusion methods (including DSMT) utilize current state of knowledge related to each possible hypothesis. The hypotheses may be assessed in terms of statistics, how observations differ from the expected values, related to subsequent hypotheses.

11.2.1 Evaluation factors

In order to standardize evaluation terminology it is suggested to accept the following distinction of all the elements of the evaluation process, so called evaluation factors:

- Source related:
 - Time invariant factors:

- * The number of sources;
- * Source reliability;
- * Terrain features (not discussed in this chapter);
- Time variant factors:
 - * Quality measure, regarding source characteristics;
 - * Quality measure, regarding target motion parameters;
- Hypotheses related:
 - Time invariant factors:
 - * The total number of hypotheses;
 - Time variant factors:
 - * Hypotheses instantaneous quality value.

11.2.2 Not only distance matters

Many methods rely on the target position when defining source time dependent quality parameter [3, 6]. It is quite natural that the distance between the target and the sensor influences the sensor performance. Some of successfully applied information evaluation algorithms [1, 2] assume that the closer the target, the more precise the measurement. This may be correct for specific types of sources however in general there are situations when applying this rule may bring paradoxical results.

Figure 11.1 shows that the classification of a target via visual sightings or a video camera may be imprecise when the target's heading is closely aligned to its bearing from the sensor (or the source) because fewer of its features may be extracted. As such, it may be easily confused with other vessels. However, when the target's heading and bearing from the sensor substantially differ, then more of the structure of the vessel is typically revealed making its classification simpler, even if it lies at a great distance from the sensor.

According to the authors' knowledge and opinion, information evaluation algorithms should be aware of such problems. This may be done if the evaluation process takes two independent steps:

- utilize the information about source classification zones, usually not identical with detection zones;
- utilize the information about the target course (if possible) or retrieve the aspect angle information taking target state vector consisting of two (at least) dynamical coordinates: position and velocity.

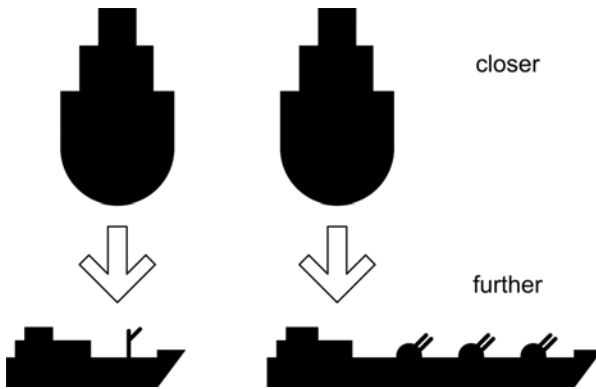

Figure 11.1: Classification problem: not always the distance metric is the best.

That certainly requires state estimation. For the purpose of marine C&C systems that seems not to be problematic for the reason that state estimation is usually performed independently outside attribute information evaluation modules. If that is so, evaluation methods may take advantage of target tracking functions.

11.3 The attribute information evaluation model

Based on observations described in the previous section, the attribute information evaluation process may be expressed with a concept and finally a model is presented below. The basic block scheme of information evaluation process is shown on Figure 11.2.

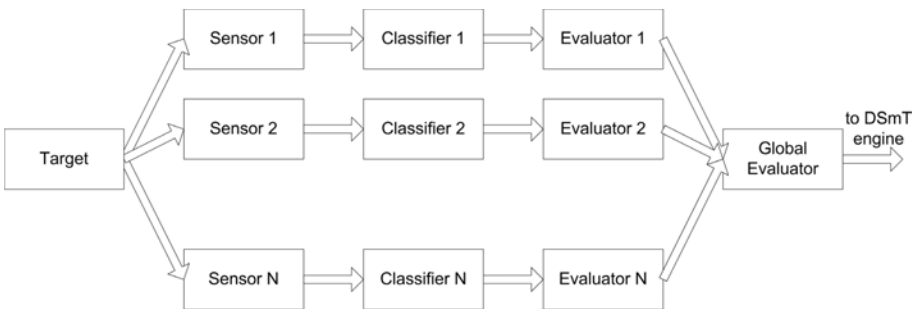

Figure 11.2: Information evaluation basic block scheme.

Target – an object to be detected and classified by subsequent blocks. The target is assumed to be described by a threat attribute and a kinematic state vector.

Sensor – a source of information. There are possible diverse source types, namely radar, video camera and visual sightings, for example. It is assumed that all these types have different characteristics (detection and classification zones) and reliability.

Classifier – a block which associates the sensor data with particular possible hypotheses. Based on primary hypotheses distinguished by the sensor (frame of discernment), the classifier results in creating additional hypotheses using \cup and \cap operators to form an extended set which may be dealt with the DS_mT fusion engine.

Evaluator – a block which assesses the classified information. This is the key part of the whole model. The evaluator uses information concerning:

- Information source (source characteristics, source reliability information);
- Sensor measurements (concerning hypotheses actually supported directly by sensors);
- Target kinematics information (to evaluate exact hypotheses).

Global evaluator – an auxiliary evaluation block which updates local evaluation products with external information about the qualities of the sources (not shared by local evaluators) like bias corrections or human-originated preferences, for example.

A more detailed diagram is depicted on Figure 11.3. Each block of Figure 11.2 has been reconsidered to view its main functions. The arrows show the block interactions on the functional level. In addition, a block of the state estimator has been introduced which provides target kinematic information in real systems.

The blocks of Target and State estimator perform auxiliary functions only, to show the reader the point where the exact information is processed. They will not be discussed in details here.

11.3.1 The types of sensors

For the purpose of the evaluation model, the sensor block is assumed to consist of two components:

- Characteristics;
- Observation process.

The characteristics describe theoretically how a source performance should change depending on the tracked target position. It may be treated as a deterministic component.

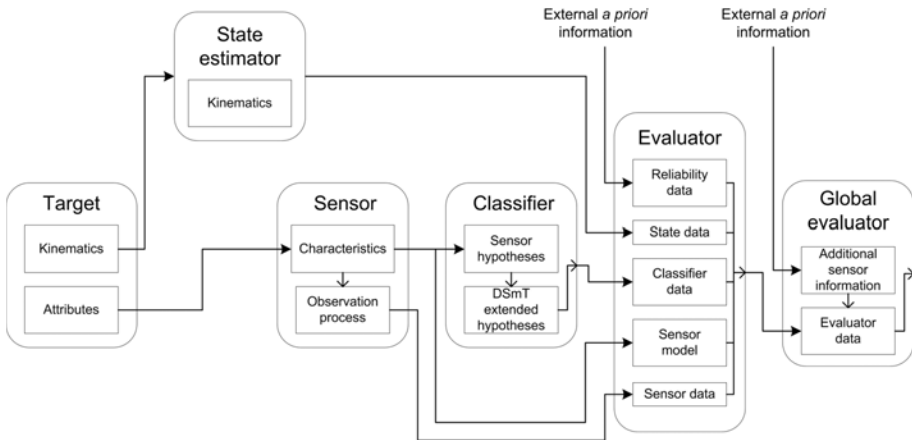

Figure 11.3: Further insight into information evaluation.

The observation process component acts mainly as a stochastic one. It introduces random disturbance noise to model a source imperfection, according to the reliability parameter value;

Such a decomposition of deterministic and stochastic sensor components is required for the reason that sensor performance is going to be modeled in a following (after classifier) block of evaluator. Deterministic information about characteristics is assumed to be possible to share, while stochastic source behavior information is never completely known in the real world, therefore it is assumed to be unknown outside the sensor block.

Concentrating on the characteristics component it is important to notice that one can deal with diverse types of sensors (using diverse ontologies), however it was assumed for simplicity to constrain the sensor model to the classification level.

Therefore, the only two types of zones are to be taken into account:

- Detection zone;
- Classification zones;

The detection zone is a region where the target detection is possible. Any region outside that zone is not taken into account.

The classification zones are the subsets of the detection zone, where the target may be classified with precision determined by its actual kinematic state vector. The classification zones can be distinguished as follows:

- Perfect classification conditions ($F_c = 1$);

- Perfect azimuth and imperfect range conditions;

$$F_c(t) = \omega_\phi(t) \cdot \omega_d(t) \tag{11.1}$$

- Perfect range and imperfect azimuth conditions;

$$F_c(t) = \omega_\phi(t) \cdot \omega_a(t) \tag{11.2}$$

- Imperfect classification conditions;

$$F_c(t) = \omega_\phi(t) \cdot \omega_d \cdot \omega_a(t) \tag{11.3}$$

where F_c (the conditions factor) is a function which summarizes a classification quality and where ω_ϕ , ω_d and ω_a are the target validation weights regarding target aspect, distance and azimuth respectively.

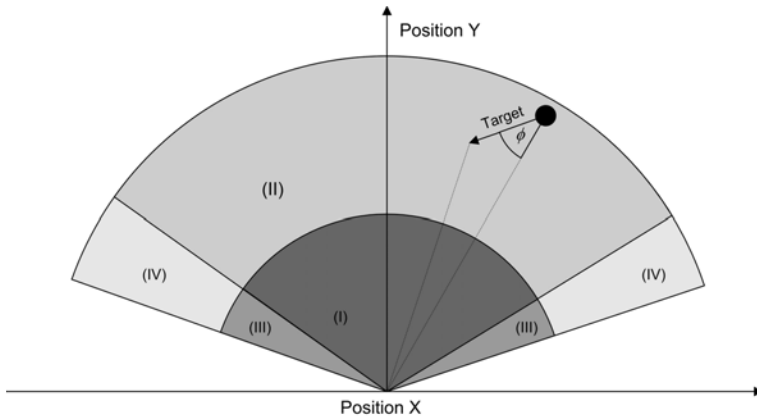

Figure 11.4: Classification zones: (I) perfect classification conditions, (II) – perfect azimuth imperfect range conditions, (III) – perfect range imperfect angle conditions, (IV) imperfect classification conditions.

The observation process disturbance may be modeled using a normal distribution with known mean value, determined by expected undisturbed (simulated) value and standard deviation, depending on the sensor characteristics.

$$\sigma = \sigma_{\min} + \delta(1 - F_c) \tag{11.4}$$

where σ_{\min} is the minimal standard deviation value and δ is a condition dependence coefficient.

11.3.2 Classifier

Wherever a soft-decision fusion approach is applied, the classifier block appears. In the evaluation model presented here the classifier has to carry out two tasks.

- Extracting the primary hypotheses (source frame of discernment);
- Generating additional hypotheses using \cup and \cap operators.

Extracting the primary hypotheses is a classical task for classifiers. For a given type of sensor each possible hypothesis is extracted and established in a hypotheses table for future evaluation.

The hypotheses distinguished by sensors are mostly exclusive and the set of possible value depending on the exact source may not be sufficient for proper classification. For this reason it is suggested to append to the classifier an additional function of generating extensional (middle) hypotheses using union and intersection operators.

If the threat attribute is human-originated the following translation rules should be applied¹:

- SUSPECT = UNKNOWN \cap HOSTILE
- ASSUMED_FRIEND = UNKNOWN \cap FRIEND
- FAKER = FRIEND \cap HOSTILE
- JOKER = SUSPECT \cap FRIEND = UNKNOWN \cap HOSTILE \cap FRIEND

A suspicion that there are two targets within considered area may also be established as union hypothesis, for example: FRIEND \cup HOSTILE.

11.3.3 Evaluator

Some soft-decision fusion models apply the classifier as a module responsible, not only for proper classification (and interpretation) of data obtained from sensors, but also as some kind of evaluator.

Since this chapter refers mainly to attribute information evaluation, the evaluator has been distinguished as a separate block that follows the classifier. However, in the presented model one also receives information directly from other blocks. It is due to the fact that the evaluation process requires a combination of:

- Sensor model: to access the source characteristics information;

¹Presented threats' values are defined in [4]. It is authors' suggestion to put them in terms of hypotheses union or intersection to be easily dealt by DS_mT fusion.

- Classifier information: to acquire information about particular hypotheses to evaluate;
- Target state vector: necessary to utilize the characteristics information;
- Reliability data: to know about how defective the source is;
- Consequently: sensor data to have the basis for the evaluation.

Sensor model information may be easily derived from the deterministic part of the sensor block. If that is so, source related time variant parts may be summarised with one function $F_c(t)$, described as in section 11.3.1.

Considering the distinction presented in section 11.2.1 the evaluation of hypotheses may be expressed by the following formula:

$$m_i(\theta_j) = \frac{\beta R_i F_c(t)}{N_\theta} \cdot \frac{1}{\Delta\Theta_j^2} \tag{11.5}$$

where i is the sensor index; j is the classifier hypotheses index; R_i is the sensor reliability; N_θ number of primary hypotheses; $\Delta\Theta_j$ is the hypothesis weight based distance metric and $\beta \in [2, N_\theta]$ is a compensation coefficient.

The first term acts as a source related component. It consists of conditions factor, source reliability and the number of primary hypotheses². The coefficient β should be treated as a compensator of prior hypotheses number. The second term is related to hypotheses component. For each hypothesis from the set obtained from the classifier, the respective hypothesis weight $\Delta\Theta_j$ is calculated based on the distance metric, as Figure 11.5 shows.

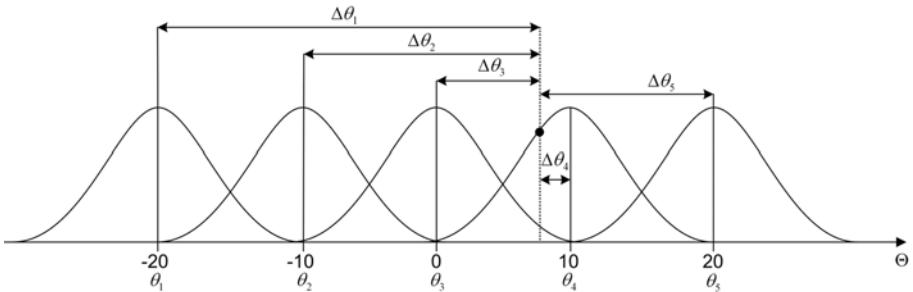

Figure 11.5: Distance metric for calculating hypotheses weights. Numerical values specify distribution distances.

²Number of primary hypotheses (not classifier hypotheses) is taken into account, because unlike primary hypotheses classifier, hypotheses may not be treated as an intrinsic feature of the source.

This rule may be easily applied for each prior hypothesis. Otherwise, if for example the hypothesis is created upon intersection of prior hypotheses, it is suggested to apply another rule described below. The problem that occurs concerns the evaluation of hypotheses related to the target threat parameter. It is assumed that:

- The frame of discernment is defined as:

$$\Theta = \{U \triangleq \text{UNKNOWN}, F \triangleq \text{FRIEND}, H \triangleq \text{HOSTILE}\}$$

- The measurements are performed in three steps:
 - Step I: HOSTILE vs. FRIEND;
 - Step II: HOSTILE vs. UNKNOWN;
 - Step III: UNKNOWN vs. FRIEND
- The first (sensor related) term is omitted for simplicity;

Based on the frame of discernment and rules described in this section additional hypotheses may be formed. Graphical relationship among threat attributes are shown in Figure 11.7.

It is important to realize that the method presented here, if applicable to resolve problems other than those related to the target threat evaluation, requires reconsideration since some of prior classes are specific. The class UNKNOWN is specific because, apart from the fact that it is one of prior classes, it represents the ignorance about the target.

The idea the of three-step measurements comes from the fact that in marine systems the most important is to firstly classify the target either FRIEND or HOSTILE. The rest of the observations may be used to update the degree of evidence that the target is a FRIEND or HOSTILE and to update the target classification accordingly. That also may become the basis to create the following additional hypotheses: JOKER, FAKER etc. Certainly, the following measurements may be treated as completely different sources of evidence and hence the DSMT fusion may be applied. However, in this chapter, it is suggested to consider them related to the same source of information and to utilize some extra knowledge about the definition of threat values, described below. Omitting the first (sensor related) term, as assumed, hypotheses weights may be calculated as follows:

$$m_i(\theta_j) \approx \frac{1}{\omega(\theta_j)} \quad (11.6)$$

The weights ω should be calculated as follows:

$$\omega(\theta_j) = \nu^T(\theta_I) \cdot \nu(\theta_I) \quad (11.7)$$

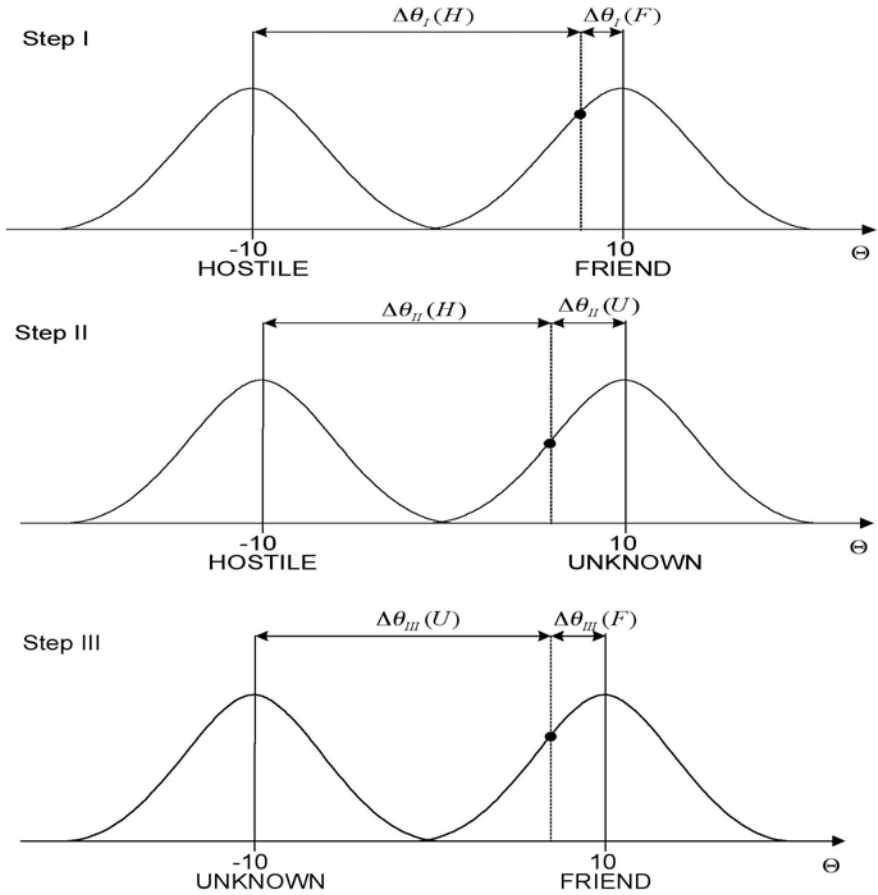

Figure 11.6: Calculating hypotheses weights using distance metric (steps I-III).

where

$$\nu^T(F) = [\Delta\theta_I(F) \ \Delta\theta_{II}(F) \ \Delta\theta_{III}(F)] \tag{11.8}$$

$$\nu^T(H) = [\Delta\theta_I(H) \ \Delta\theta_{II}(H) \ \Delta\theta_{III}(U)] \tag{11.9}$$

$$\nu^T(U) = [D_{HF} \ \Delta\theta_{II}(U) \ \Delta\theta_{III}(U)] \tag{11.10}$$

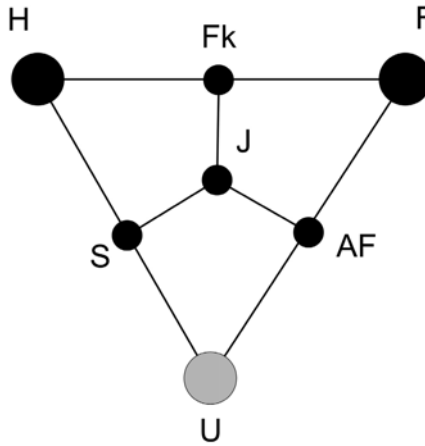

Figure 11.7: Relations among threat values (UNKNOWN is specific) where $Fk \triangleq$ FAKER, $J \triangleq$ JOKER, $S \triangleq$ SUSPECT and $AF \triangleq$ ASSUMED_FRIEND.

$$\nu(F \cap H) = \begin{bmatrix} \Delta\theta_I(F) - \Delta\theta_I(H) \\ \Delta\theta_{II}(U) \\ \Delta\theta_{III}(F) \end{bmatrix} \quad (11.11)$$

$$\nu(F \cap U \cap H) = \begin{bmatrix} \Delta\theta_I(F) - \Delta\theta_I(H) \\ \Delta\theta_{II}(H) - \Delta\theta_{II}(U) \\ \Delta\theta_{III}(U) - \Delta\theta_{III}(F) \end{bmatrix} \quad (11.12)$$

$$\nu(F \cap U) = \begin{bmatrix} \Delta\theta_I(F) \\ \Delta\theta_{II}(U) \\ \Delta\theta_{III}(U) - \Delta\theta_{III}(F) \end{bmatrix} \quad (11.13)$$

$$\nu(H \cap U) = \begin{bmatrix} \Delta\theta_I(H) \\ \Delta\theta_{II}(H) - \Delta\theta_{II}(U) \\ \Delta\theta_{III}(U) \end{bmatrix} \quad (11.14)$$

$$\nu^T(F \cup H) = [D_{HF} \quad \Delta\theta_{II}(H) \quad \Delta\theta_{III}(F)] \quad (11.15)$$

where $\omega(F \cap H)$ is the weight of FAKER; $\omega(F \cap U \cap H)$ is the weight of JOKER; $\omega(F \cap U)$ is the weight of ASSUMED FRIEND; $\omega(H \cap U)$ is the weight of SUSPECT according to the translation rules described in the section and D_{HF} is the distance between distributions HOSTILE and FRIEND.

The weights, generally, consist of three terms which represent how much evidence, retrieved based on every measurement step, is for a particular hypothesis (for example: in equation (11.8) they are distances: $\Delta\theta_I(F)$ and $\Delta\theta_{III}(F)$) or how much it is against the contrary hypothesis ($\Delta\theta_{II}(U)$ - for the same equation). However, when

creating the hypotheses using \cap operator, it is important to notice that the intersection of particular prior hypotheses changes the graphic interpretation to what extent the evidence is for particular hypothesis. For example equation (11.12) shows that JOKER is the most probable if in all three steps measurements will place somewhere in the middle between distributions. Therefore, each term consists of distance differences, not just distances. It must be also mentioned that in equation (11.11) though defined as $F \cap H$ the second term is $\Delta\theta_{II}(U)$ not $\Delta\theta_{II}(H)$. That results from the fact that the target FAKER is always a friendly (for exercise purposes acting as HOSTILE). The high measurement of ‘how much HOSTILE it is’ does not really support the hypothesis of FAKER.

11.4 Numerical experiments

The techniques described in previous sections have been subjected to series of numerical experiments. This section presents details of the experiments and is followed by the discussion of obtained results.

11.4.1 Assumptions

Target simulation:

- The target is described with the threat attribute value, which can be changed by the user and a state vector;
- The target is assumed to be moving (with random or deterministic trajectories) to simulate that it can reside in sensors’ diverse classification zones;

Sensor (of threat attribute):

- There are three types of sensors (radar, visual sighting and video camera) each of which has different detection and classification parameters;
- All types of the sensors uses different ontology;
- It is possible to set sensor reliability parameter, sensor position
- Sensor performance is target state vector dependent, directly as described in section 11.3.1.
- Sensor performance is modeled stochastically by using Gaussian distributions with specified mean values and standard deviations to represent the measuring noise.

Classifier:

- Classifier extends the set of prior hypotheses with some hypotheses created based on prior hypotheses as described in section 11.3.3.

- It is assumed to extend the hypotheses set with fixed predefined values (SUSPECT, FAKER, ASSUMED_FRIEND);

Evaluator:

- Only the hypotheses related factor is assumed to be normalized (the source related factor is assumed to be excluded from the normalization process);
- An additional class of PENDING is created with mass defined as follows: $m(P) = 1 - F_c$, to complete bba;
- β is designed to compensate the prior hypotheses number in the source factor with optimal hypotheses number;
- If the target exceeds the sensor detection range, this results in $m(P) = 1$ and zero for the rest of the values;

Global evaluator:

- It is assumed to utilize here only a priori information about local evaluators (any information about the source quality and reliability should be used in previous stages of evaluation);

11.4.2 Settings and other model information

Three-step measurement enables to identify targets described with the threat attribute outside the sensor ontology. For example if the target is friendly and acts as hostile, the evaluator will place the first step measurement somewhere in between HOSTILE and FRIEND, the second step measurement close to UNKNOWN and the third step measurement close to FRIEND which leads to assigning the FAKER with the biggest mass value, even though, the value of FAKER is not present in the sensor ontology.

Setting the proper value for a ‘beta’ coefficient is very important. In evaluation model particular hypothesis mass is inversely proportional to the number of prior hypotheses. It is due to the fact that diversity of prior hypotheses decreases possible mass value assigned to a particular hypothesis. The value of three seems to be perfect because the basic set consists of {FRIEND, HOSTILE, UNKNOWN}³. This optimal value may be transferred to beta to compensate the real (sensor originated) hypotheses number. Ideally, when the hypotheses number is equal to the optimal hypotheses number (beta), the source related factor depends on the source reliability and the conditions factor only.

³ In some cases (radar equipped with IFF device, distinguishing only HOSTILE and FRIEND) this number should be reduced to the value of two. This seems to be reasonable since the UNKNOWN represents the ignorance thus it may be omitted.

11.4.3 Results

In the first experiment the HOSTILE target track was generated randomly. The threat attribute information evaluation was performed over twenty one samples. The resulting trajectory is shown on Figure 11.8.

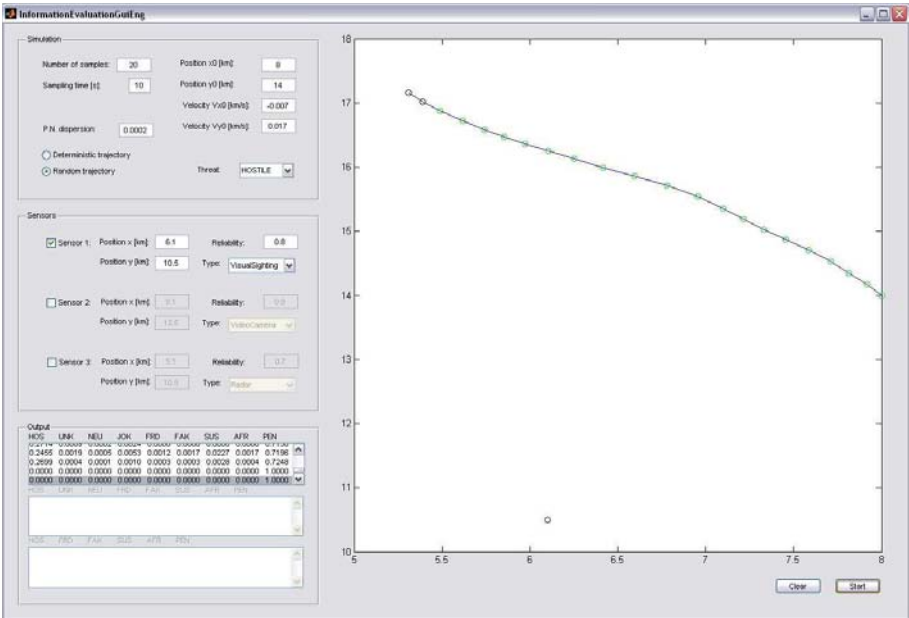

Figure 11.8: Randomly generated target trajectory. Attribute information evaluation performed by a single source - Visual Sighting (VS). Target aspect problem detected.

The figure 11.8 shows that the target was constantly within the sensor range, however some of the measurements have been better conditioned than others. Table 11.1 presents resulting bba calculated for each sample. It is immediately clear from Table 11.1 that in most of cases the bba was mainly distributed between the HOSTILE and the PENDING. It is quite reasonable about the HOSTILE but the PENDING is not so obvious. The reason why the PENDING got relatively high resides in coefficient β , which has been set to three while the prior hypotheses number was five. In all cases where PENDING mass was 0.68, measurements were perfectly conditioned (in terms of $F_c(t)$ function). Starting with 10-th sample PENDING mass began to rise which was caused by the fact that the target passed the perfect classification condition zone (the range condition began to get worse). In last two samples bba was completely transferred to the PENDING which is by default when the target threat attribute

evaluation is not possible. In these particular cases it was caused by the target aspect. This phenomenon perfectly illustrates the problem described in section 11.2.

The next thing concerning the Table 11.1 is how the bba was distributed to the rest of the hypotheses. It must be noticed that each time the FRIEND has the least mass assigned while the SUSPECT was always the second high, after the HOSTILE (excluding the PENDING). The abbreviations used in this tables are: HOS=hostile, UNK=unknown, NEU=neutral, JOK=joker, FRD=friend, FAK=faker, SUS=suspect, AFR=assumed friend and PEN=pending.

<i>HOS</i>	<i>UNK</i>	<i>NEU</i>	<i>JOK</i>	<i>FRD</i>	<i>FAK</i>	<i>SUS</i>	<i>AFR</i>	<i>PEN</i>
0.3027	0.0013	0.0004	0.0034	0.0008	0.0011	0.0093	0.0011	0.6800
0.3145	0.0004	0.0001	0.0010	0.0002	0.0003	0.0031	0.0003	0.6800
0.3119	0.0006	0.0002	0.0016	0.0004	0.0005	0.0041	0.0006	0.6800
0.3131	0.0004	0.0001	0.0012	0.0003	0.0004	0.0040	0.0004	0.6800
0.3066	0.0009	0.0002	0.0024	0.0006	0.0008	0.0077	0.0008	0.6800
0.3106	0.0007	0.0002	0.0017	0.0005	0.0006	0.0051	0.0006	0.6800
0.3001	0.0016	0.0005	0.0043	0.0011	0.0014	0.0095	0.0014	0.6800
0.2996	0.0013	0.0004	0.0033	0.0008	0.0011	0.0124	0.0011	0.6800
0.3178	0.0002	0.0000	0.0004	0.0001	0.0001	0.0012	0.0001	0.6800
0.3088	0.0005	0.0001	0.0014	0.0003	0.0005	0.0042	0.0005	0.6836
0.3060	0.0004	0.0001	0.0011	0.0003	0.0004	0.0032	0.0003	0.6882
0.2977	0.0007	0.0002	0.0017	0.0004	0.0006	0.0059	0.0006	0.6922
0.2860	0.0011	0.0003	0.0029	0.0007	0.0010	0.0109	0.0010	0.6961
0.2921	0.0005	0.0001	0.0014	0.0003	0.0004	0.0046	0.0004	0.7002
0.2937	0.0002	0.0000	0.0004	0.0001	0.0001	0.0012	0.0001	0.7041
0.2841	0.0006	0.0002	0.0017	0.0004	0.0005	0.0042	0.0005	0.7078
0.2754	0.0011	0.0003	0.0028	0.0007	0.0009	0.0066	0.0010	0.7112
0.2714	0.0009	0.0002	0.0024	0.0006	0.0008	0.0080	0.0008	0.7150
0.2455	0.0019	0.0005	0.0053	0.0012	0.0017	0.0227	0.0017	0.7196
0.2699	0.0004	0.0001	0.0010	0.0003	0.0003	0.0028	0.0004	0.7248
0.0000	0.0000	0.0000	0.0000	0.0000	0.0000	0.0000	0.0000	1.0000
0.0000	0.0000	0.0000	0.0000	0.0000	0.0000	0.0000	0.0000	1.0000

Table 11.1: Bba calculated for each of 21 target track sample based on sensor and hypotheses information. The real target is HOSTILE.

The second experiment was meant to show how to retrieve the information the target is of any class, which does not reside in sensor ontology. The real threat attribute value had been set to FRIEND but the measurement was disturbed in such

a way so as to provide the uncertainty whether the target is HOSTILE or FRIEND during first stage of measuring process. The obtained measurement numerical values for a single sample have been depicted in Fig. 11.9.

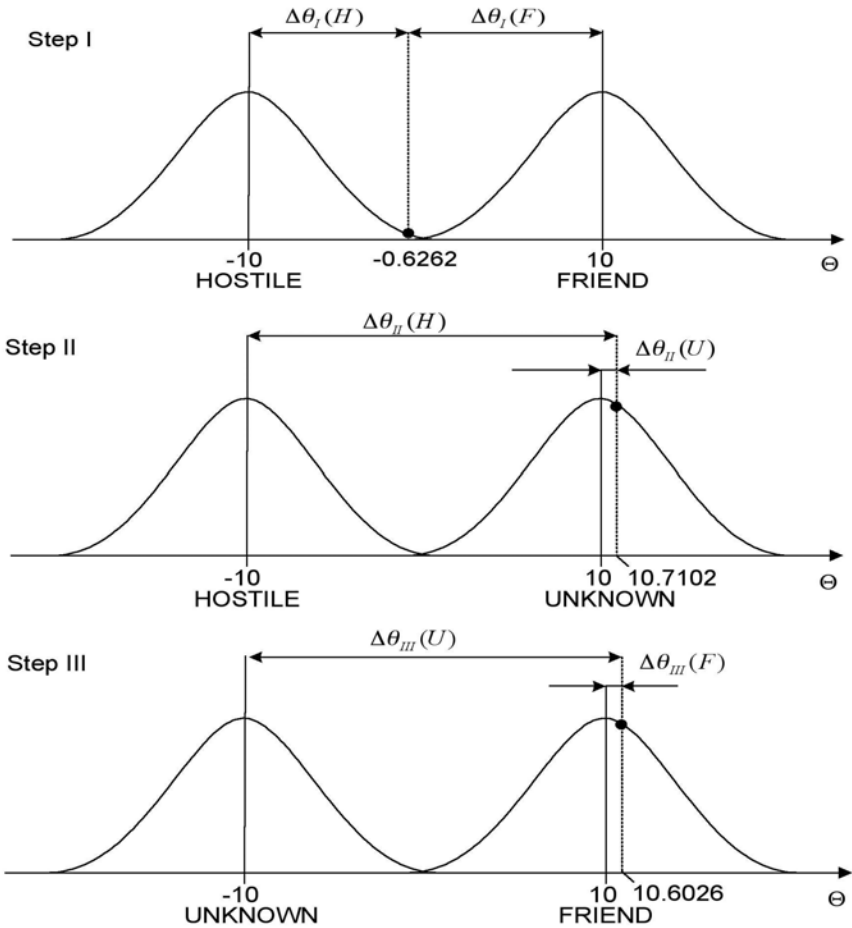

Figure 11.9: The example of hypotheses weights calculation using the distance metric (steps I-III).

The first step measurement places in between the HOSTILE and the FRIEND value, the second step measurement does not prove the hypothesis that the target is HOSTILE and the third step clearly shows the target is FRIEND. Combining these pieces of information it is reasonable to claim that the target is FAKER, which is shown in the resulting Table 11.2.

<i>Threat value</i>	<i>Mass</i>
<i>HOSTILE (i.e HOS)</i>	0.0007
<i>UNKNOWN (i.e UNK)</i>	0.0012
<i>NEUTRAL (i.e NEU)</i>	0.0028
<i>JOKER (i.e JOK)</i>	0.0028
<i>FRIEND (i.e FRD)</i>	0.0056
<i>FAKER (i.e FAK)</i>	0.5125
<i>SUSPECT (i.e SUS)</i>	0.0010
<i>ASSUMED_FRIEND (i.e AFR)</i>	0.0029
<i>PENDING (i.e PEN)</i>	0.4704

Table 11.2: Bba calculated for the chosen test sample.

The next experiment aimed at multi-sensor information evaluation. A FRIEND track has been generated randomly starting between two sources: Visual Sighting (VS) and Video Camera (VC). The resulting trajectory is depicted on Fig. 11.10. In this particular case, applying two sources enabled to keep attribute information evaluation continuity. Table 11.3 presents the bba's of the three chosen samples. JOKER dashes for Video Camera (VC) means that it does not recognise the JOKER.

It must be emphasized that VS and VC compensate each other's performances. The reason why any of them could not make a measurement was the aspect problem. It must be noticed that from the 18th up to 22nd sample, the critical aspect is for the visual sighting despite the fact the target is closer to this very source.

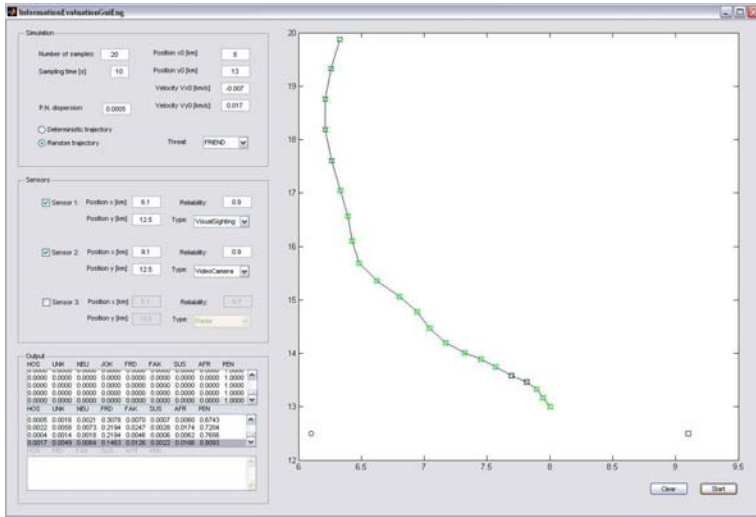

Figure 11.10: Randomly generated target trajectory. Attribute information evaluation performed by two sources: Visual Sighting (o – symbol) and Video Camera (square symbol).

Sample #	5	5	6	6	22	22
Source Type	VS	VC	VS	VC	VS	VC
<i>HOS</i>	0.0019	0	0.0014	0.0024	0	0.0017
<i>UNK</i>	0.0047	0	0.0040	0.0066	0	0.0049
<i>NEU</i>	0.0077	0	0.0038	0.0097	0	0.0064
<i>JOK</i>	0.0075	—	0.0062	—	0	—
<i>FRD</i>	0.2877	0	0.3045	0.3626	0	0.1463
<i>FAK</i>	0.0325	0	0.0206	0.0213	0	0.0126
<i>SUS</i>	0.0025	0	0.0019	0.0030	0	0.0022
<i>AFR</i>	0.0154	0	0.0176	0.0245	0	0.0166
<i>PEN</i>	0.6400	1	0.6400	0.5700	1	0.8093

Table 11.3: Bba’s calculated for chosen samples no. 5, 6 and 22 for Visual Sighting (VS) and Video Camera (VC).

The last experiment meant to check the evaluation model accuracy with deterministically generated target trajectory. The figures 11.11 and 11.12 show the evaluation samples of this track.

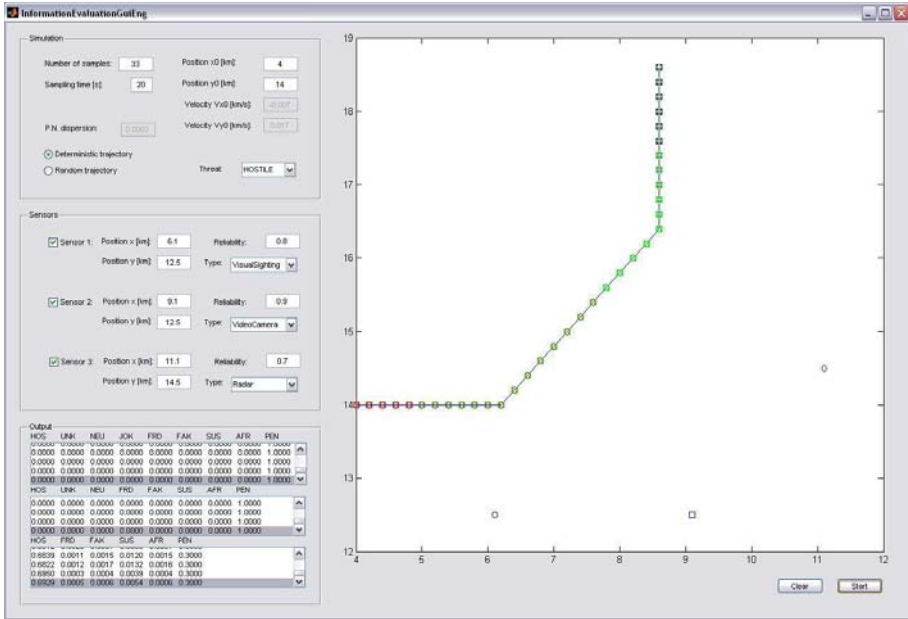

Figure 11.11: Deterministically generated target trajectory. Attribute information evaluation performed by three sources: Visual sighting (o – symbol), Video camera (square symbol) and Radar (diamond symbol).

For a better visualization, the decluttering function has been applied (Fig. 11.12) to spread samples originated from different sources. The figure 11.12 shows that radar attribute evaluation measurements were constrained mainly by the azimuth sector (light symbols), only the upper part of the track is visible (solid symbols). Video camera performance was constrained both by the azimuth sector and the target aspect (dark symbols), while visual sighting measurements were constrained only by the target aspect.

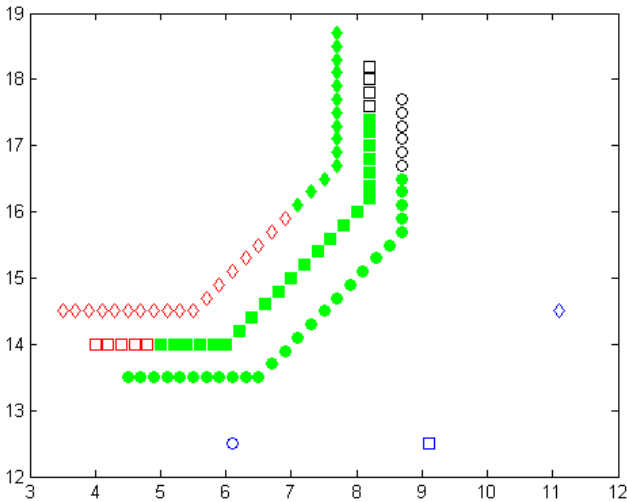

Figure 11.12: Deterministically generated target trajectory as in Fig. 11.11. For better visualization, a decluttering function has been applied.

11.4.4 Discussion

It is worth discussing if a lack of sensor specification, expressed in terms of mass should be transferred to the PENDING or to the UNKNOWN. The UNKNOWN class generally describes the uncertainty of the hypotheses related part. Therefore, the authors decided to transfer the lack of specification to the new class of PENDING, which in terms of [4, 5] means ‘any of the rest of the classes’. A demanding reader may raise a question concerning the ‘acceptance logic’, mentioned in the previous subsection. Why does the target aspect factor act here in a binary manner? Within the perfect classification zone ignores the aspect problem while just after exceeding that zone it completely precludes the whole attribute information evaluation? The answer is very simple: It is not the intention of this model to build as realistic logic as possible. The importance of this evaluation model resides in the fact that calculated masses, resulting from the sensor characteristics and the target motion parameters may be described as reasonable (to be expected in real world). If, for example, the evaluation model assigns the biggest mass to the FAKER it is very unlikely to find the smallest mass assigned to the FRIEND because $\text{FAKER} = \text{FRIEND} \cap \text{HOSTILE}$.

11.5 Latest concepts

In our latest research works, we propose two alternative target threat models. The first one is called an “Activity-oriented model” while the second is a “Threat-oriented model. These two models are based on different definitions of the three stages of threat measurement according to Table 11.4.

Threat	Activity-oriented model			Threat-oriented model		
<i>FRD</i>		$\Delta\theta_I(F)$ $\Delta\theta_{II}(U)$ $\Delta\theta_{III}(F)$			$\Delta\theta_I(F)$ $\Delta\theta_{II}(U)$ $\Delta\theta_{III}(F)$	
<i>HOS</i>		$\Delta\theta_I(H)$ $\Delta\theta_{II}(H)$ $\Delta\theta_{III}(U)$			$\Delta\theta_I(H)$ $\Delta\theta_{II}(H)$ $\Delta\theta_{III}(U)$	
<i>UNK</i>		$\Delta\theta_I(H) - \Delta\theta_I(F)$ $\Delta\theta_{II}(U)$ $\Delta\theta_{III}(U)$			$\Delta\theta_I(H) - \Delta\theta_I(F)$ $\Delta\theta_{II}(U)$ $\Delta\theta_{III}(U)$	
<i>FAK</i>		$\Delta\theta_I(F) - \Delta\theta_I(H)$ $\Delta\theta_{II}(H)$ $\Delta\theta_{III}(F)$			$\Delta\theta_I(F)$ $\Delta\theta_{II}(H)$ $\Delta\theta_{III}(U)$	
<i>JOK</i>		$\Delta\theta_I(F)$ $\Delta\theta_{II}(H) - \Delta\theta_{II}(U)$ $\Delta\theta_{III}(F)$			$\Delta\theta_I(F)$ $\Delta\theta_{II}(H) - \Delta\theta_{II}(U)$ $\Delta\theta_{III}(U)$	
<i>SUS</i>		$\Delta\theta_I(H)$ $\Delta\theta_{II}(H) - \Delta\theta_{II}(U)$ $\Delta\theta_{III}(U)$			$\Delta\theta_I(H)$ $\Delta\theta_{II}(H) - \Delta\theta_{II}(U)$ $\Delta\theta_{III}(U)$	
<i>AFR</i>		$\Delta\theta_I(F)$ $\Delta\theta_{II}(U)$ $\Delta\theta_{III}(U) - \Delta\theta_{III}(F)$			$\Delta\theta_I(F)$ $\Delta\theta_{II}(U)$ $\Delta\theta_{III}(U) - \Delta\theta_{III}(F)$	

Table 11.4: Threat target models comparison.

Fig. 11.13 and Fig. 11.14 show threat relations in activity-oriented model and threat-oriented model respectively. The activity-oriented model in the first measurement stage resolves whether (according to observed target’s activity) the target seems to be more like FRIEND or HOSTILE. In the following two next stages, the degrees of belief of these two hypotheses are defined by the observation of the real target. This means that the real target’s threat description resides in last two measurements whereas the first one influences the possible training type (JOKER or FAKER).

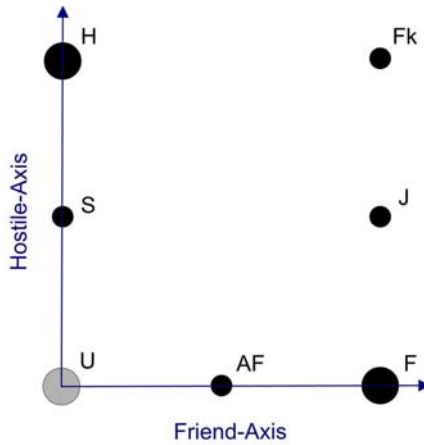

Figure 11.13: Activity-oriented model. Relations among threat values.

The threat-oriented model in the first measurement stage resolves the real threat of the target. In the following two next stages, the degrees of belief (whether the target acts as SUSPECT or HOSTILE) are defined according to the current target's activity. This means that the stage of measurement is the most important from the military point of view due to the fact it clearly shows the real threat. According to this model, JOKER and FAKER types are always described as FRIENDS. Therefore this very model seems to be the most adequate for applicable military solutions.

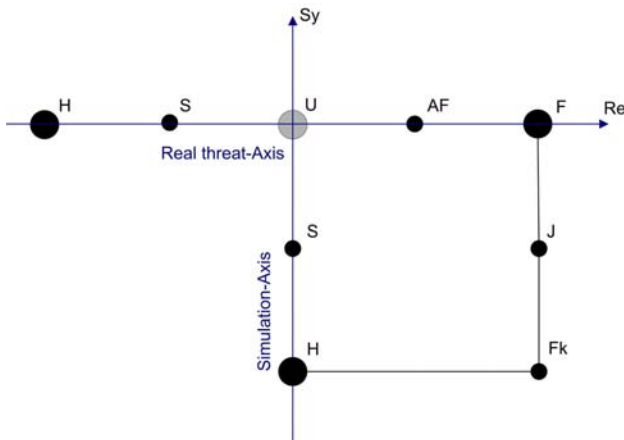

Figure 11.14: Threat-oriented model. Relations among threat values.

11.6 Conclusion

An evaluation of the attribute information plays a very important role in information fusion systems. Among many possible attributes of maneuvering target the threat is one of the most important. Many practical fusion problems proved that this kind of information often happens to be even more important than the precise information about the target position. However, to assess properly the attribute information, the target state vector is necessary, as well as, a specific evaluation method.

Conflicting attribute information needs a reasonable bba calculating method if it is meant to be fused according to DSMT. The research work described in this chapter is a part of extensive works devoted to sensor networks in a NEC environment.

In the near future it is planned to extend the presented evaluation model from the navigation point of view, as well as, from the mathematics (concentrating on attribute-oriented model⁴) and additionally to provide a tool for assessing different attributes (other than the threat) of maneuvering targets.

11.7 References

- [1] K. Krenc, Specyfikacja wymagan na aplikacje uogólniania danych KSL-UOG, 2005
- [2] Marine Corps Tactical Systems Support Activity, Command & Control PC (C2PC) version 5.8.2.0, 2002.
- [3] Navy Center for Tactical Systems Interoperability, Operational specification for over-the horizon targeting gold revision D, 2000.
- [4] NATO Standardization Agreement, Tactical Data Exchange – Link 16, STANAG No. 5516, Ed. 3.
- [5] NATO Standardization Agreement, Tactical data exchange – Link 11/Link 11B, STANAG No. 5511, Ed 6.
- [6] NATO Standardization Agreement, Identification Data Combining Process, STANAG No. 4162, Ed. 2.
- [7] F. Smarandache and J. Dezert (Editors), *Applications and Advances of DSMT for Information Fusion*, Collected Works, Vol.1, American Research Press, 2004.
<http://www.gallup.unm.edu/~smarandache/DSMT-book1.pdf>
- [8] F. Smarandache and J. Dezert (Editors), *Applications and Advances of DSMT for Information Fusion*, Collected Works, Vol.2, American Research Press, 2006.
<http://www.gallup.unm.edu/~smarandache/DSMT-book2.pdf>

⁴Threat-oriented model may be generalized to any attribute model if attributes other than target threat are discussed.

Chapter 12

Utilizing classifier conflict for sensor management and user interaction

Willem L. van Norden
Defence Material Organisation,
CAMS – Force Vision,
P.O. Box 10000,
1780 CA Den Helder,
The Netherlands.
w.l.van.norden@forcevision.nl

Catholijn M. Jonker
Delft University of Technology,
Faculty of EE, Math & CS,
Man-Machine Interaction Group,
2628 CD Delft,
The Netherlands.
c.m.jonker@tudelft.nl

Abstract: *This chapter describes how the conflict encountered by the PCR6 rule can be utilized in sensor management. We therefore discuss the classification model that is used in the fusion problem and two different types of conflict. To enable operators to exert constraints on singletons we propose a (slightly) altered PCR6 rule, dubbed PCR6^a. We show how the algorithm works and we illustrate how the amount of conflict can be used for sensor management and/or for operator feedback by using an example.*

12.1 Introduction

In recent decennia, a need has occurred to develop support functionalities for obtaining and maintaining situation awareness within the combat management system aboard the frigates of the Royal Netherlands Navy. This is due to three factors. Firstly, because the missions have become more complex in several ways. The mission goals are more diverse and the political climate in which these goals need to be met, are more complex compared to the Cold War period. The geographical location where the mission is executed, has shifted to the littoral, which means the meteorological conditions can change rapidly and there is much presence of civilian traffic. The latter makes missions more complex because the threat has shifted from military forces to asymmetrical threats.

Secondly, much more complex and modern sensor systems, like multifunction radar and optical sensor with staring 360 degrees capabilities, are being placed aboard the Dutch frigates. This means that deploying these sensors and combining their information is a difficult and highly knowledge intensive task. Especially in the littoral environment, choosing the right sensor for the right task at the right time, given the meteorological conditions, is quite difficult.

Finally, budget cuts have led to reduced training and education time as well as a tendency for a reduction in ships' complement. This means that the readily available knowledge aboard our frigates is decreasing. This discrepancy between required and available knowledge requires more support from the CMS for gathering and combining sensor information and for sensor management. Work has already been done in the field of automatic classification and how different classifier opinions can be combined, [3, 6]. This chapter describes how the results from the PCR6 rule of combination within the Dezert-Smarandache theory (DSmT) can be used as a feedback mechanism for automated sensor management.

Section 12.2 revisits the general rule of combination from DSmT, [8], and the PCR6 rule described by Martin and Oswald in [4]. Section 12.3 describes how classification and sensor management are related within Command and Control. Furthermore, it discusses the classification space within the military domain and shortly discusses the required interaction with the operator. Section 12.4 introduces how the conflict can be utilized within the PCR6 algorithm. The way this conflict can be used as a feedback to sensor management is discussed in section 12.5. Finally, section 12.6 closes with conclusions and future work.

12.2 Combination rules

Within the DSmT framework, the generalized basic belief that is assigned¹ by k different and independent sources or experts — $\mathcal{E}_1, \mathcal{E}_2, \dots, \mathcal{E}_k$ — can be combined using equation (12.1). This equation holds $\forall X \in D^\Theta$ and $X \notin \emptyset$, where D^Θ denotes the hyper power set of Θ , the belief of each expert \mathcal{E}_i with $i = [1, 2, \dots, k]$ is denoted

¹This is called a generalized belief assignment, or just a *gbba* for short.

$m_i(X)$ and \emptyset denotes the classical empty set. Since this classic rule of combination only assumes exhaustiveness within the frame of discernment, $\Theta = \{\theta_1, \theta_2, \dots, \theta_n\}$, other rules of combination have been proposed to redistribute the conflict that might occur for applications in real fusion problems [9]. One of those rules is the PCR6 rule proposed by Martin and Oswald in [4] and is given in equation (12.2) for $\forall X \in D^\Theta$ and $X \notin \emptyset_{\mathcal{M}}$, where $\emptyset_{\mathcal{M}}$ denotes both the classical empty set and the set containing all elements from D^Θ that are constrained by fusion model \mathcal{M} . In equation (12.2), F_i is defined by equation (12.3). In equation (12.3) properties for the summation are given by equation (12.4) and equation (12.5).

In equation (12.3–12.5), $\varphi(i)$ denotes a function that ensures that i is skipped in a summation and is given by equation (12.6). In [4] this function is denoted σ_i . We use a different notation to prevent notational confusion for the classifiers that assume Gaussian distributions where σ_i denotes the standard deviation in variable i given some measurements. In [4], algorithm 3 gives the implementation of the PCR6 rule.

$$m_c^f(X) = \sum_{\substack{Y_1, Y_2, \dots, Y_k \in D^\Theta \\ Y_1 \cap Y_2 \cap \dots \cap Y_k = X}} \prod_{i=1}^k m_i(Y_i) \tag{12.1}$$

$$m_c^{PCR6}(X) = m_c^f(X) + \sum_{i=1}^k F_i \cdot m_i(X)^2 \tag{12.2}$$

$$F_i = \sum_{\substack{P_1 \\ P_2}} \frac{\prod_{l=1}^{k-1} m_{\varphi_i(l)}(Y_{\varphi_i(l)})}{m_i(X) + \sum_{l=1}^{k-1} m_{\varphi_i(l)}(Y_{\varphi_i(l)})} \tag{12.3}$$

$$P_1 : \bigcup_{j=1}^{k-1} Y_{\varphi_i(j)} \cap X \in \emptyset_{\mathcal{M}} \tag{12.4}$$

$$P_2 : (Y_{\varphi_i(1)}, Y_{\varphi_i(2)}, \dots, Y_{\varphi_i(k-1)}) \in (D^\Theta)^{k-1} \tag{12.5}$$

$$\varphi_i(l) \rightarrow \begin{cases} \varphi_i(l) = l & \text{if } l < i \\ \varphi_i(l) = l + 1 & \text{if } l \geq i \end{cases} \tag{12.6}$$

12.3 Classification and sensor management

This chapter discusses how the conflict in combining classification solutions can be utilized in sensor management. Before modeling the classification model itself and how solutions are combined, this section will first briefly discuss how this may improve automated sensor management performance.

12.3.1 Sensor management

Optimally deploying a total sensor suite requires knowledge about:

- the meteorological and oceanographical conditions;
- the geographical location;
- the available sensor systems and their specifications; and
- the (expected) target characteristics.

The use of the target characteristics is e.g. discussed by Bar-Shalom in [1]. Furthermore, we know that prioritizing sensor functions can be done using risk, as proposed in [2]. This notion of risk requires characteristics of possible objects in the environment. Obtaining a good classification solution is therefore important to execute the process of sensor management.

On the other hand, the classification process itself has a certain need for information provided by the available sensor systems. In order to achieve good classification solutions, the sensor(s) need to be deployed as optimal as possible. This research therefore focuses on the information requirements of the classification process. In order to do this, we need to describe the classification model.

12.3.2 Modeling the classification space

In general, the possible solutions for classification are given by a so-called classification tree, [5, 7]. The drawback of using such trees is that the branching order is fixed. Describing the different classes as sets at different levels of specificity provides more flexibility in reducing the search space [6]. In the case of classification in the maritime military environment, we define three different levels of specificity. At the lowest specificity level we define the set of super classe, $\mathcal{S} = \{\vartheta_1, \vartheta_2, \dots, \vartheta_s\}$ to contain s exhaustive elements. In this set the different domains are represented: air, surface, subsurface, land and sea respectively, therefore $s = 5$ holds.

At the medium specificity level we define generic classes, $\mathcal{G} = \{\gamma_1, \gamma_2, \dots, \gamma_g\}$ with g mutually exclusive and exhaustive elements. At the final level we define the specific classes, $\mathcal{C} = \{\varsigma_1, \varsigma_2, \dots, \varsigma_c\}$, with c mutually exclusive and exhaustive elements. Joined, these three sets define the frame of discernment for classification, $\Theta = \mathcal{S} \bowtie \mathcal{G} \bowtie \mathcal{C}$. We define the operator \bowtie in a way that when $A = \{\alpha_1, \dots, \alpha_a\}$ and $B = \{\beta_1, \dots, \beta_b\}$ are joined then $A \bowtie B = \{\alpha_1, \dots, \alpha_a, \beta_1, \dots, \beta_b\}$.

Throughout this work we assume an example frame of discernment and three classifiers that assign generalized belief, given by tables 12.1–12.3. In these tables, \mathcal{H}_h with $h = [1, 2, \dots, (s + g + c)]$ is used to denote elements from the frame of

discernment Θ . Also, when set $A = \{\alpha_1, \dots, \alpha_a\}$ holds, we define \widehat{A} as:

$$\widehat{A} = \bigcup_{i=1}^a \alpha_i.$$

\mathcal{H}	ϑ_1	ϑ_2	ϑ_3	ϑ_4	ϑ_5
Name	Air	Surface	Subsurface	Land	Sea
$m_1(\mathcal{H})$	0.15	0.1	0	0.01	0.04
$m_2(\mathcal{H})$	0.13	0.12	0.005	0.02	0.025
$m_3(\mathcal{H})$	0.4	0.4	0.2	0	0

Table 12.1: Super classes in the database with their gbba's.

\mathcal{H}	Name	$m_1(\mathcal{H})$	$m_2(\mathcal{H})$	\mathcal{H}	Name	$m_1(\mathcal{H})$	$m_2(\mathcal{H})$
γ_1	<i>Helo</i>	0.25	0.175	γ_4	<i>Frigate</i>	0.041	0.1
γ_2	<i>Fighter</i>	0.002	0.002	γ_5	<i>Tank</i>	0.005	0.01
γ_3	<i>Submarine</i>	0	0.01	γ_6	<i>Airliner</i>	0.002	0.003

Table 12.2: Generic classes in the database with their gbba's.

\mathcal{H}	Name	$m_1(\mathcal{H})$	$m_2(\mathcal{H})$	\mathcal{H}	Name	$m_1(\mathcal{H})$	$m_2(\mathcal{H})$
ς_1	<i>Seahawk</i>	0.15	0.075	ς_6	<i>Apache</i>	0.15	0.075
ς_2	<i>F-16</i>	0.005	0.01	ς_7	<i>M-frigate</i>	0.04	0.0075
ς_3	<i>Walrus</i>	0	0.02	ς_8	<i>Kilo sub</i>	0	0.002
ς_4	<i>7 Provinciën</i>	0.036	0.075	ς_9	<i>F-14 Tomcat</i>	0.005	0.02
ς_5	<i>Leopard II</i>	0.009	0.01	ς_{10}	<i>Boeing 747</i>	0.005	0.02

Table 12.3: Specific classes in the database with their gbba's.

12.3.3 Intersection between elements

The set-up of the classification model with three specificity levels immediately imposes that not all elements in the frame of discernment are mutually exclusive. This, of course, fits well within the DSMT framework. Each element at the most specific level has a *parent* at a higher level. E.g., the Seahawk and the Apache in table 12.3 are *children* of the generic class Helicopter. In turn, the helicopter belongs to the air

domain, $\varsigma_1 \cup \varsigma_6 \subseteq \gamma_1 \subseteq \vartheta_1$, where $a \subseteq b$ is used to denote that a is a subproposition of b which holds if and only if $a \cap b = a$. Due to the helicopter's low-flight capabilities, it can also belong to the surface domain, $\gamma_1 \subseteq (\vartheta_1 \cap \vartheta_2)$. Similar reasoning can be done for all elements at the three specificity levels. From this example, we can already say that elements in \mathcal{S} are not all mutually exclusive. For set \mathcal{S} we know that $\vartheta_1 \cap \vartheta_2 \notin \mathcal{O}_M$, $\vartheta_1 \cap \vartheta_4 \notin \mathcal{O}_M$, $\vartheta_1 \cap \vartheta_5 \notin \mathcal{O}_M$ and that $\vartheta_3 \cap \vartheta_5 \notin \mathcal{O}_M$ holds. Furthermore, we know that $(\vartheta_4 \cup \vartheta_5) \cap \vartheta_2 = (\vartheta_4 \cup \vartheta_5)$ and $\widehat{\mathcal{C}} \subset \widehat{\mathcal{G}} \subset \widehat{\mathcal{S}}$ hold in the classification solution space.

For the intersections between elements of \mathcal{S} and set \mathcal{G} we can say that the following equalities hold: $\vartheta_1 \cap \widehat{\mathcal{G}} = \{\gamma_1, \gamma_2, \gamma_6\}$, $\vartheta_2 \cap \widehat{\mathcal{G}} = \{\gamma_1, \gamma_3, \gamma_4, \gamma_5\}$, $\vartheta_3 \cap \widehat{\mathcal{G}} = \{\gamma_3\}$, $\vartheta_4 \cap \widehat{\mathcal{G}} = \{\gamma_5\}$ and $\vartheta_5 \cap \widehat{\mathcal{G}} = \{\gamma_3, \gamma_4\}$. Furthermore, we can say that the following equalities also hold for the intersections of elements from \mathcal{G} intersected with elements from \mathcal{C} : $\gamma_1 \cap \widehat{\mathcal{C}} = \{\varsigma_1, \varsigma_6\}$, $\gamma_2 \cap \widehat{\mathcal{C}} = \{\varsigma_2, \varsigma_9\}$, $\gamma_3 \cap \widehat{\mathcal{C}} = \{\varsigma_3, \varsigma_8\}$, $\gamma_4 \cap \widehat{\mathcal{C}} = \{\varsigma_4, \varsigma_7\}$, $\gamma_5 \cap \widehat{\mathcal{C}} = \{\varsigma_5\}$ and $\gamma_6 \cap \widehat{\mathcal{C}} = \{\varsigma_{10}\}$.

12.3.4 Interaction with the user

In [3] it was already stated how classifier belief can be combined using the PCR6 rule. Here, we expand the usage of PCR6 by having the user — or operator — as an additional information source. This user-influence can be exerted in two ways:

1. the operator is an information source and
2. the operator can place additional constraints.

Figure 12.1 depicts the resulting system architecture to achieve the required user interaction. The main difference between the user-imposed constraints (denoted \mathcal{O}_U) and the model constraints is that in \mathcal{O}_U singletons can occur as opposed to combinations of elements from D^Θ that occur in \mathcal{O}_M : $\mathcal{O}_M \cap \Theta \in \emptyset$ whereas $\mathcal{O}_U \cap \Theta \notin \emptyset$. This means that the PCR6 rule needs to be adapted slightly to cope with this, section 12.4 describes how this is done. In [10] the Belief Conditioning Rules (BCR) were introduced to perform similar operations. Here however, we use the known structure of the frame of discernment to transfer belief. This has the advantage that we do not need to compute the subsets D_1, D_2 and D_3 , where $\Theta \setminus \emptyset = D_1 \cup D_2 \cup D_3$, where $b \setminus a$ denotes all elements in b that are not in a . The approach mentioned in this chapter can therefore be seen as a specific BCR rule (somewhat similar to BCR17) where the construction of the subsets of Θ is not required since they are already given in the structure of the classification solution space.

Another difference is that the belief conditioning rules are used to indicate where belief should be held and that the methodology presented here indicates where belief should *not* be held. In other words: the operator indicates that what is absolutely not possible given the circumstances. Belief on what can be true is added into the fusion algorithm as just another source. This is done to keep options open as much as possible, following the operational credo: *expect the unexpected!*

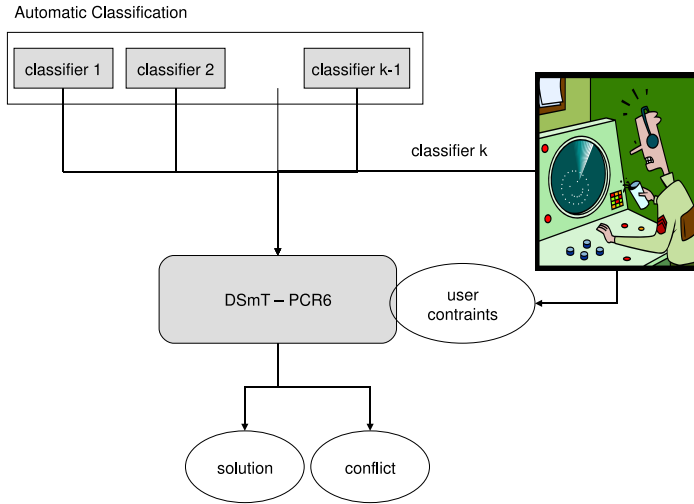

Figure 12.1: System Architecture where the user interacts with the system.

12.4 Conflict

Where belief from different sources is combined, chances are that conflict occurs. This conflict can be utilized in various ways. Firstly, we can look at which of the sources is responsible for most of this conflict. This could indicate that a particular source is malfunctioning. Also, in the case of automated classifiers it could indicate that an object is behaving unexpectedly, an important discovery when dealing with asymmetrical threats. By allowing the user to constrain elements from the frame of discernment, more conflict is introduced. This section describes how the conflict can be tracked within the PCR6 combination rule.

12.4.1 Tracking conflict in PCR6

In order to take the user-imposed constraints into account we say that equation (12.2) holds $\forall X \in D^{\ominus} \setminus (\mathcal{O}_U \cup \mathcal{O}_M)$. Furthermore, the property P_1 of the summation in equation (12.4) is changed to equation (12.7). This adaptation ensures that all constraints are taken into account during combination. Now, suppose an operator indicates that the object under consideration does not belong to the subsurface domain $\mathcal{O}_U = \{\vartheta_3, \gamma_3, \varsigma_3, \varsigma_8\}$. Combining the three sources while taking the user-imposed constraints into account produces the combined gbba's in figure 12.2. However, there is a drawback to this approach. Not all conflict is redistributed due to the fact that

singletons are being constrained, a situation that is usually not taken into account in applications of PCR6. This is illustrated by the fact that the assignments from figure 12.2 sum up to 0.756.

$$P_1 \rightarrow \bigcup_{j=1}^{k-1} Y_{\varphi_i(j)} \cap X \in (\emptyset_M \cup \emptyset_U) \tag{12.7}$$

This does however give us a measure of the conflict, namely 0.244, that is produced by the user constraints. Within the PCR6 algorithm we can track the total conflict from both the model constraints and the user-imposed constraints. Tracking the total conflict — that is conflict from both \emptyset_U and \emptyset_M — to the responsible sources for this conflict, $C_{\mathcal{E}_i}$, produces table 12.4.

Source, i	1	2	3	total
$C_{\mathcal{E}_i}(\cdot)$	0.0777	0.0564	0.2514	0.3855

Table 12.4: Conflict produced by each source.

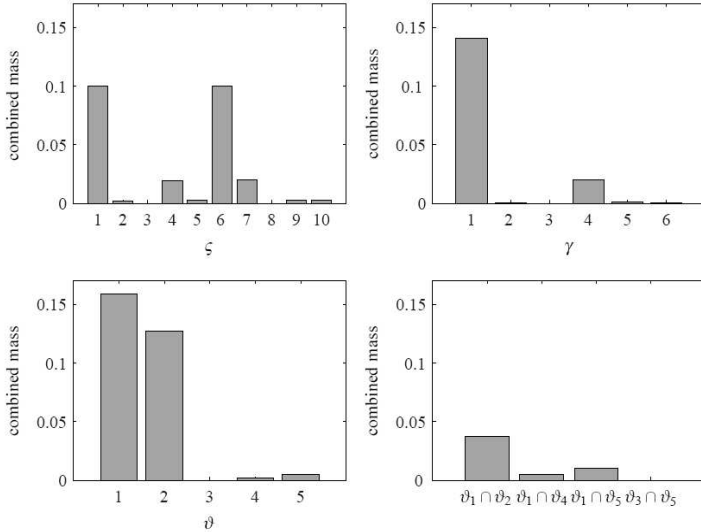

Figure 12.2: Combined generalised belief assignments.

In table 12.4 we see that source three is responsible for a great deal of conflict: an expected result looking at tables 12.1–12.3. However, the total output does not sum

up to 1, which is an undesired result. We therefore use a modified PCR6 rule, denoted $m_c^{PCR6^a}$ that is given by equation (12.8), $\forall X \in D^\Theta \setminus (\emptyset_M \cup \emptyset_U)$. In equation (12.8), equations (12.9) and (12.10) hold. In order to keep track of the conflict on each individual element in \emptyset_U , we define equation (12.11) which holds $\forall X \in (\emptyset_U \cap D^\Theta)$. Within equation 12.11, equations (12.12) and (12.13) are defined. The adaptations on PCR6 proposed here, lead to the algorithm in appendix. In this algorithm the function call `Intersect` is used. This function is based on section 12.3.3.

$$m_c^{PCR6^a}(X) = m_c^f(X) + \sum_{i=1}^k Q_i \cdot m_i(X)^2 \quad (12.8)$$

$$Q_i = \sum_{\substack{P_3 \\ P_2}} \frac{\prod_{l=1}^{k-1} m_{\sigma_i(l)}(Y_{\sigma_i(l)})}{m_i(X) + \sum_{l=1}^{k-1} m_{\sigma_i(l)}(Y_{\sigma_i(l)})} \quad (12.9)$$

$$P_3 \rightarrow \bigcup_{j=1}^{k-1} Y_{\varphi_i(j)} \cap X \in (\emptyset_{\mathcal{M}} \setminus \emptyset_U) \quad (12.10)$$

$$C_{\mathcal{H}}(X) = m_c^f(X) + \sum_{i=1}^k T_i \cdot m_i(X)^2 \quad (12.11)$$

$$T_i = \sum_{\substack{P_4 \\ P_2}} \left(\frac{\prod_{l=1}^{k-1} m_{\varphi_i(l)}(Y_{\varphi_i(l)})}{m_i(X) + \sum_{l=1}^{k-1} m_{\varphi_i(l)}(Y_{\varphi_i(l)})} \right) \quad (12.12)$$

$$P_4 \rightarrow \bigcup_{j=1}^{k-1} Y_{\varphi_i(j)} \cap X \in \emptyset_U \quad (12.13)$$

12.4.2 Redistribution of remaining conflict

For the redistribution of conflict introduced by the assumed model \mathcal{M} , we use the adapted $PCR6^a$ rule. Since,

$$\sum_{\forall X \in D^\Theta \setminus (\emptyset_U \cup \emptyset_{\mathcal{M}})} m_c^{PCR6^a}(X) \neq 1$$

holds, we want to distribute the masses in $C_{\mathcal{H}}$ to the masses on $m_c^{PCR6^a}$ to obtain $m_c^{PCR6^{distr}}$,

$$m_c^{PCR6^{distr}} = \text{ReDistribute}(m_c^{PCR6^a}, C_{\mathcal{H}}, \emptyset_U).$$

Due to the fact that

$$\sum_{\forall X \in D^\Theta \setminus \emptyset_{\mathcal{M}}} (m_c^{PCR6^a}(X) + C_{\mathcal{H}}(X)) = 1$$

holds, the quantity will sum up to 1 after this operation while maintaining the insights in the conflict produced by \mathcal{O}_U and \mathcal{O}_M . The distribution of masses from $C_{\mathcal{H}}$ is done based on the same principles as the general PCR rules. That means that masses are distributed to related elements as much as possible. Therefore, when a element with high specificity is constrained, its gba is distributed to its parent at the next level since that element was involved in calculating $m_c^f(X)$, equation (12.1). A problem occurs when elements at the lowest specificity level are constrained since they have no parent to distribute the mass to. This is solved by looking at the possible intersections of elements in set \mathcal{S} .

from	to
ϑ_1	$\vartheta_2, \vartheta_4, \vartheta_5$
ϑ_2	ϑ_1, ϑ_3
ϑ_3	ϑ_2, ϑ_5
ϑ_4	ϑ_2
ϑ_5	ϑ_2, ϑ_3

Table 12.5: Distributing masses at the highest hierarchical level.

Table 12.5 shows how these transfers should be handled when using this approach. Only when these distributions are no longer possible, are masses distributed to the other non-constrained elements. We already mentioned that masses are distributed based on the principles of PCR, all transfers are therefore done proportionally. Let us look at the example given in tables 12.1–12.3 and place a user constraint on all elements of the air domain, note that this also means all underlying children in sets \mathcal{G} and \mathcal{C} . When combining the sources using equation (12.8) and distributing $C_{\mathcal{H}}$ using the aforementioned method figure 12.3 is produced.

These results are not very intuitive and a change in transferral methodology is required. We expand the distribution scheme in order to transfer masses to other elements on the same specificity levels. To do this, a distribution tree is built based on \mathcal{O}_U to transfer masses from elements in \mathcal{C} to other elements in \mathcal{C} according to its parents and table 12.5, this produces figure 12.4, which corresponds to a more intuitive result.

Since the elements to which the mass is transferred to is not directly involved in the original conflict, one could argue that within this redistribution scheme the transfers do not need to be proportional.

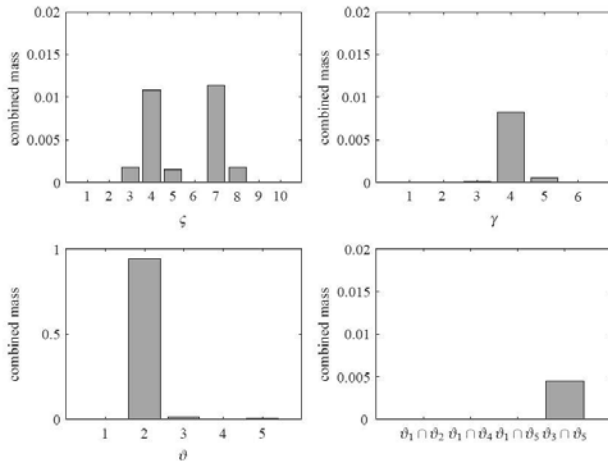

Figure 12.3: Results for $PCR6^a$ after a redistribution of conflict from \emptyset_U when conflict goes to parent elements.

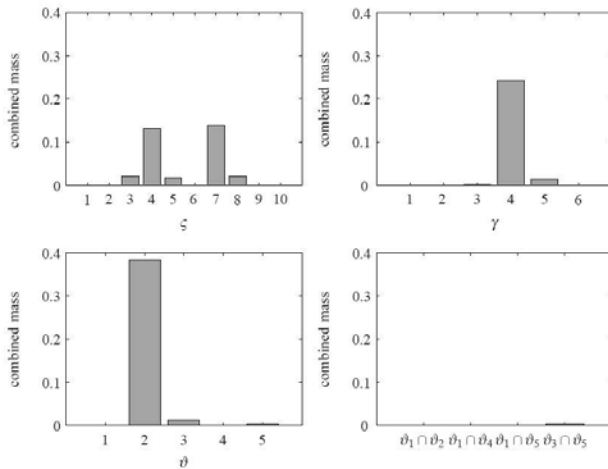

Figure 12.4: Results for $PCR6^a$ after a proportional redistribution of conflict from \emptyset_U .

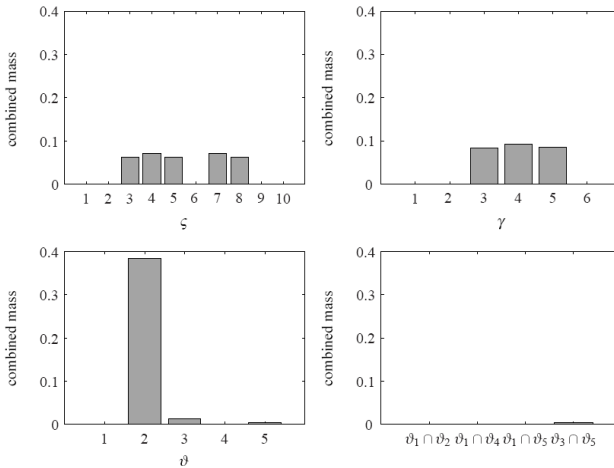

Figure 12.5: Results for $PCR6^a$ after unproportional redistribution of conflict from \emptyset_U .

Figure 12.5 shows the results when masses are not transferred proportionally. The difference with figure 12.4 is the relative difference between the masses assigned to elements is maintained better when transferring proportionally. In figure 12.6 we see the results from the different steps combined, first we see the results when equation (12.1) is used, then the results from $PCR6^a$ and finally the results of the $PCR6^a$ after proportionally redistributing masses from $C_{\mathcal{H}}$.

12.5 Utilizing the conflict in sensor management

In previous sections we have seen how belief on classification solutions from different sources can be combined and how user-imposed constraints on singletons can be taken into account with a slightly altered PCR6 algorithm. The question of course is: *why do we want to track the conflict?*

In essence the answer is simple, once we know where conflict is introduced we can try to reduce it. In this section we will first discuss tracking the conflict per source or expert and we will follow up with the conflict traced back to elements in \emptyset_U .

12.5.1 Conflict per source

Where belief from different sources is combined, conflict occurs. Combined belief is obtained by proportionally redistributing these conflict using by the $PCR6^a$ rule. By tracking the conflicting masses that need to be redistributed, we can say which of the

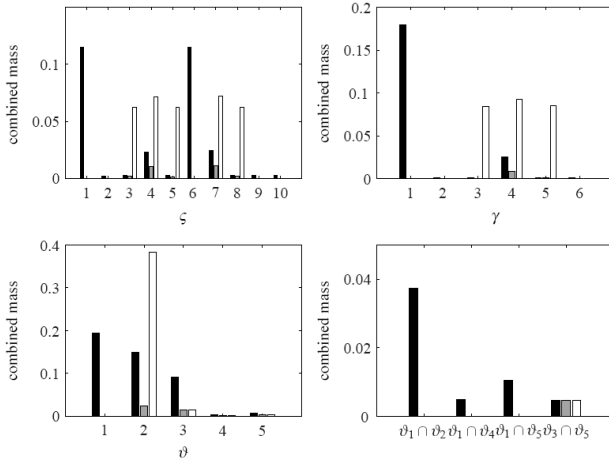

Figure 12.6: Results for unconstrained PCR6 (black), constrained $PCR6^a$ (gray) and after redistribution of conflict from \emptyset_U (white).

sources is responsible for an amount of conflict. When one specific source produces the most conflict this could indicate that:

1. a sensor system that provides information to that source is degraded;
2. the classifier is malfunctioning or ill-trained;
3. the object under consideration is behaving unexpectedly.

Tracking the conflict does not answer the question as to which one of these three is the case, but it gives a trigger to take actions to find out. Especially the case when the classification solution is visually confirmed and all sensors are performing correctly is operational important. Section 12.1 already mentioned the amount of civil traffic in the current mission environments. When the conflict based on a subset of attributes indicates that one of those objects is behaving strangely, this is valuable in situations where asymmetrical threats are expected.

Another option for a large conflicts between different sources occurs when a lot of uncertainty resides in the sensor measurements. By looking at the source that produces most conflicting information and combining that with the knowledge about the source, namely the attributes it uses to find solutions, we know which types of sensor measurements are required to reduce the conflict between sources, which in turn improves the combined classification solution.

12.5.2 Conflict per hypotheses

When the operator imposes constraints, $\mathcal{O}_u \neq \emptyset$, the conflict that each of these constraints introduces can be tracked. When combined with a machine learning algorithm, this conflict can be used to do some online training of automated classification algorithms to have them adapt to the current situation. On the other hand, it can be used to train personnel aboard during transit to the mission area. In order to find out whether the system was mistaken or if the user was mistaken, sensor functions can be requested to reduce the conflict on each of the elements in \mathcal{O}_u . If the newly obtained sensor measurements confirm the combined belief of the sources (the conflict increases) the operator can be alerted to further investigate this conflict and then remove the constraint for instance. When the operator is certain about the constraint, the conflict on the specific hypothesis can indicate a malfunctioning sensor or ill-trained classifiers although this is not very probable if the sources do not have much conflict amongst themselves. The most likely option then is an object that is behaving very unexpectedly.

12.6 Conclusions

This paper shows that it is possible to combine the information of different automated classifiers using the PCR6 rule of combination. By introducing an addition to the PCR6 rule we show that constraints on singletons can be taken into account. By tracking the conflict during the execution of the PCR6, the sources of the conflict can be identified. Furthermore, the quantity of the conflict can be utilised in automated sensor management and provides valuable feedback to the operator.

Future work is to implement more accurate sensor models and objects in order to validate this methodology in more realistic scenarios. After this validation it will be implemented in an actual combat management system in order to further test the system with real operators. In this stage a comparison is planned to validate the improved performance of our system compared to the systems currently in use.

12.7 References

- [1] Y. Bar-Shalom, T. Kirubarajan, C. Gokberk, *Tracking with classification-aided multiframe data association*, IEEE Trans. on AES, Vol. 41, No.3, pp. 868–878, July 2005.
- [2] F. Bolderheij, *Mission Driven Sensor Management: Analysis, design, implementation and simulation*, PhD. Thesis with Delft Univ. of Tech., Nov. 2007.
- [3] A. Martin, C. Oswald, *Generalized proportional conflict redistribution rule applied to Sonar imagery and Radar target classification*, Chap. 11 in [11].
- [4] A. Martin, C. Oswald, *The generalised PCR6 rule stable in terms of solution*, Chap. 2 in [11].

- [5] B. Mertens, *Reasoning with uncertainty in the situational awareness of air targets*, Masters Thesis with the Man-Machine Interaction Group of the Delft University of Technology, Delft, 2004.
- [6] W. van Norden, F. Bolderheij, C. Jonker, *Combining system and user belief on classification using the DSMT combination rule*, Proc. of the 11th Int. Conf. on Inf. Fusion (Fusion 2008), Cologne, Germany, June, 2008.
- [7] K. Scholte, *Dynamic Bayesian networks for reasoning about noisy target data*, Den Helder: Royal Netherlands Naval College, Research Report for the Combat Systems Department, December 2005.
- [8] F. Smarandache, J. Dezert, *An Introduction to the DSMT Theory for the Combination of Paradoxical, Uncertain, and Imprecise Sources of Information*, Proc. 13th Int. Cong. of Cybernetics and Systems, Maribor, July 6-10, 2005 (see also the Chapter 1 of this volume).
- [9] F. Smarandache and J. Dezert, *Proportional Conflict Redistribution Rules for Information Fusion*, Chap. 1 in [11].
- [10] F. Smarandache, J. Dezert, *Belief Conditioning Rules*, Chap. 9 in [11].
- [11] F. Smarandache, J. Dezert (Editors), *Advances and Applications of DSMT for Information Fusion, Collected works, Vol. 2*, Rehoboth, USA, 2006.

Appendix

The PCR6 algorithm with embedded conflict tracking and that enables constraints on singletons.

```

Data      :  $k$  experts  $ex: ex[i], \dots, ex[n]$ 
           : User-imposed constraints  $UC$ 
Results  : Fusion of  $ex$  by PCR6,  $ep$ 
           : Conflict on each hypothesis,  $CH$ 
           : Conflict per expert,  $CE$ 

```

```

for  $i = 1$  to  $k$  do
  foreach  $c$  in  $ex[i]$  do APPEND  $c$  to  $cl[i]$ ;
foreach  $ind$  in  $[1, size(cl[1])] \times \dots \times [size(cl[k])]$  do
   $[c, u] \leftarrow \text{INTERSECT}(s, ind)$ ;
  if  $s \equiv \emptyset$  then

```

```

lconf  $\leftarrow$  1; sum  $\leftarrow$  0;
for i=1 to k do
  lconf  $\leftarrow$  lconf * ex[i](cl[i][ind[i]]);
  sum  $\leftarrow$  sum + ex[i](cl[i][ind[i]]);
for i=1 to k do
  if  $u \cap UC \equiv \emptyset$  then
    ep(ex[i][ind[i]])  $\leftarrow$  ep(ex[i][ind[i]]) +
      ex[i](cl[i][ind[i]]) * lconf/sum;
    if  $u \neq \emptyset$  then
      CE(i)  $\leftarrow$  CE(i) + ex[i](cl[i][ind[i]]) * lconf/sum;
    endif
  else
    CH(u)  $\leftarrow$  CH(u) + (ex[i](cl[i][ind[i]]) * lconf/sum)/size(u);
  endif
else
  lconf  $\leftarrow$  1;
  for i = 1 to k do
    lconf  $\leftarrow$  lconf * ex[i](cl[i][ind[i]]);
    ep(s)  $\leftarrow$  ep(s) + lconf;
  endif

```

Chapter 13

Automatic goal allocation for a planetary rover with DSMT

Massimiliano Vasile, Matteo Ceriotti
Department of Aerospace Engineering,
University of Glasgow,
James Watt South Building,
G12 8QQ, Glasgow, UK
m.vasile@aero.gla.ac.uk, m.ceriotti@aero.gla.ac.uk

Abstract: *In this chapter, we propose an approach for assigning an interest level to the goals of a planetary rover. Assigning an interest level to goals, allows the rover to autonomously transform and reallocate the goals. The interest level is defined by data-fusing payload and navigation information. The fusion yields an interest map, that quantifies the level of interest of each area around the rover. In this way the planner can choose the most interesting scientific objectives to be analyzed, with limited human intervention, and reallocates its goals autonomously. The Dezert-Smarandache Theory of Plausible and Paradoxical Reasoning was used for information fusion: this theory allows dealing with vague and conflicting data. In particular, it allows us to directly model the behavior of the scientists that have to evaluate the relevance of a particular set of goals. This chapter shows an application of the proposed approach to the generation of a reliable interest map.*

13.1 Introduction

Based on the experience gathered with past Mars robotic missions, a number of future space missions envisage the use of robots for the exploration of distant planets [1]. All of them have strong scientific requirements but the poor knowledge of the environment where the robots will operate, makes the definition of specific goals dependent on contingent events and observations. If the allocation the goals is performed entirely on the ground, the robot will have to wait for new instructions every time a new, unforeseen event occurs or a new set of scientific data is available.

Therefore, it would be desirable to have an autonomous system able to make decisions not only on how to reach a given set of goals, but also on which mission goals to select. Furthermore, the persistency of a mission goal may lead the system to repeatedly re-plan in order to meet the goal though the goal is unreachable or has lost its original importance. Goal transformation or goal reallocation is an important feature required in dynamic and rapidly changing environments but can become extremely important also in poorly known environments or when exploration and discovery are the main drivers of a mission [9]. For example, assume that, for a mission to Mars, a set of observations from space is used to define a set of goals for a planetary rover. During the mission, however, the rover may find that the goals are unreachable (e.g. if the goal was to collect a sample of a specific rock, the rock could be unreachable) or not interesting anymore (e.g. a different rock may display more interesting features). Then, the ground control team, together with the scientific community, would have to decide what to do. While the ground control team is devising a new plan and a new set of goals the rover would remain idle waiting for instructions. In order to avoid this waiting time, the idea is to adjust mission goals of the planner in addition to the adjustment of the plans themselves. Previous works on goal transformation addressed terrestrial or military applications [9, 13], and did not include the scientific data coming from the payload in the reallocation process.

In this work, we propose the autonomous generation or reallocation of given mission goals in order to maximize mission return. The aim is to have the most rewarding sequence of goals or the addition, deletion, modification of goals depending on contingent events or discoveries. Payload information is integrated in the planning process in order to make the rover mimicking the behavior of scientists. Goals are generated, modified or reallocated in order to maximize the overall scientific return of the mission. A family of plans is then generated for each set of ordered goals and the most reliable feasible plan of the most interesting set of goals is executed. Reliability is taken into account, together with interest, in the process of choosing the plan to be executed [15]. The planner and the goal transformation algorithm are part of a multi-layer autonomous system called Wisdom. The Wisdom system is a non-deterministic, deliberative-reactive system for rover autonomy in harsh, unknown environments. The system was developed and implemented on a six wheeled prototype rover (named Nausicaa) at Politecnico di Milano, as part of a study, supported by the European Space Agency, for the development of advanced systems for space autonomy [11].

In this chapter, we present specifically the approach used in Wisdom to generate an interest value through the data fusion of navigation and payload data for an autonomous planetary rover. The definition of an interest value avoids wild goal sequences for which only an empty set of actions is feasible (a plan with no steps), since only goals that are interesting for the mission can be generated or transformed. In Wisdom, goals are extracted from a pool of high level conceptual directives and are organized into a sequence by using the STRIPS paradigm for planning [12]. Briefly, goals are distributed in a logical sequence from an initial goal to a final one with preconditions and post-conditions, but are not scheduled unless the time is explicitly part of a goal (e.g. reach a given location in a given time). The sequence can be adjusted during execution and is qualified according to the total level of interest of all the goals. The definition of a pool of high level directives limits the set of goals to those for which the autonomous system was designed but avoids the persistency of unreachable goals.

Previous attempts to model vague concepts such as interest or curiosity for autonomous agents can be found in the work of Schmidhuber [6], who proposed the use of a co-evolutionary algorithm to evolve curiosity in an artificial intelligence system. In this case, however, there is no specific use of instruments or any mission-specific measurements or data to support the decision-making process. Instead, in this chapter, a full exploitation of scientific data is proposed in order to build an interest map of the surroundings. Pieces of scientific data from different sources are fused with navigation one to yield a single value for each point on the map. The map, then, evolves during the mission depending on the available observations.

In general terms, data fusion is the use of independent and/or redundant ancillary data from various sources to improve the data already available. Wald formally defined data fusion as: “A formal framework in which are expressed the means and tools for the alliance of data originating from different sources. It aims at obtaining information of greater quality” [14]. Here we understand data fusion as a way to combined information from different sources in order to obtain a single unambiguous value, useful to make decisions on the interest of a particular set of goals.

The combination of scientific and navigation data requires the fusion of pieces of information coming from physically different sensors. Each sensor measures a different parameter, has its own characteristics, reliability and uncertainty on measurements. Moreover, if each instrument is interpreted as a scientist expressing an opinion, we can associate to each data set an interest level with associated uncertainty. This would mimic the process performed on ground when a new set of scientific data is available. The data fusion process is then required to collect all the different pieces of information, with associated uncertainty, and combine them together [2].

In order to fuse data from the sensors and find the most interesting areas of the surrounding environment, the Dezert-Smarandache theory of plausible and paradoxical reasoning [4] was used. This theory has been successfully applied to many engineering problems, like the estimation of behavior tendencies of a target [10], or the prediction of the land cover change [3]. In those works, it was proven that this modern theory overcomes the limitations of both fuzzy logic and evidence theory.

The main advantage of the paradoxical reasoning is that it allows dealing simultaneously with uncertain and paradoxical data from different, providing a solution even in the case of conflicting information. A conflict leads to a non-decidable situation that would put the rover into idle mode, waiting for instructions. The conflict could arise when different sources (different instruments) are assigning opposite interest values to the same area or when the navigation expert suggests avoiding an area that has a high level of interest. Conflicts on the ground would be resolved through a discussion among the scientists and the mission control team, leading to a new set of goals. An autonomous resolution of conflicts by the rover, would reduce the time spent to wait for instructions from the ground station.

In this chapter, after a brief introduction to the theory of Plausible and Paradoxical Reasoning, the application to modeling interest for the Wisdom system is explained. The way of modeling interest fusing information from different sensors is described, and an application to a synthetic environment is shown. At the end, we will present a brief discussion about the possible use of Dempster-Shafer theory for the assignment of an interest. It should be noted that the key point of this work is not to propose a new theory of information fusion or to present the advantages of one theory over another. The key point is to propose an innovative way to assign a value of interest to mission goals for a planetary rover so that the goals can be autonomously adapted to contingent mission events.

13.2 Plausible and paradoxical reasoning

The theory of plausible and paradoxical reasoning (or Dezert-Smarandache theory, DSmt [4]) is a generalization of the Dempster-Shafer evidence theory [7], which is in turn a generalization of the classical probability. The foundation of the DSmt is to abandon the rigid models of the previous theories, because for some fusion problems it is impossible to define or characterize the problem in terms of well-defined and precise and exclusive elements. Given an experiment, the frame of discernment $\Theta = \{\theta_1, \theta_2, \dots, \theta_n\}$ is the set of all possible events. The model on which the DSmt is based allows dealing with imprecise (or vague) notions and concepts between elements θ_i of the frame of discernment Θ . The DSmt includes the possibility to deal with evidences arising from different sources of information which do not have access to absolute interpretation of the elements θ_i under consideration. This means that some events may also be overlapped and/or not well defined.

If Θ is the frame of discernment, we can define the space D^Θ , called hyper-power set [5], as follows:

1. $\emptyset, \theta_1, \dots, \theta_n \in D^\Theta$;
2. $\forall A, B \in D^\Theta, (A \cup B) \in D^\Theta, (A \cap B) \in D^\Theta$;
3. No other elements belong to D^Θ , except those obtained by using rules 1 and 2.

Once D^Θ is defined, we can apply the map $m(\cdot) : D^\Theta \rightarrow [0, 1]$, called *general basic belief assignment*, or gbba [4], or belief mass, such that:

$$\begin{aligned} m(\emptyset) &= 0, \\ \sum_{A \in D^\Theta} m(A) &= 1. \end{aligned} \tag{13.1}$$

A set of gbba's defined on D^Θ referred to the frame of discernment Θ , is called evidence. This approach allows us to model any source that supports paradoxical (or intrinsically conflicting) information. The theory of Dezert-Smarandache defines a rule of combination for intrinsically conflicting and/or uncertain independent sources. If two experts give their opinions in terms of bodies of evidence m_1 and m_2 , their combination is given by:

$$m_{12}(A) = \sum_{\substack{B, C \in D^\Theta \\ B \cap C = A}} m_1(B)m_2(C), \forall A \in D^\Theta. \tag{13.2}$$

Note that this rule is commutative and associative and requires no normalization procedure. Moreover, it can manage the paradoxical information without any other assumption, thus overtaking some limitations of other probability theories - like the evidence theory - in which the frame of discernment shall be based on a set of exhaustive and exclusive elements. All the pieces of evidence in (13.2) are then used to give two uncertainty values, the belief and the plausibility:

$$\begin{aligned} Bel(A) &= \sum_{\substack{B \in D^\Theta \\ B \subseteq A}} m(B); \\ Pl(A) &= \sum_{B \in D^\Theta | B \cap A \neq \emptyset} m(B). \end{aligned} \tag{13.3}$$

The belief of an event A is the sum of all the propositions that totally agree with event A, while plausibility sums up all the propositions that agree with A totally or partially. An estimation through classical probability theory would fall in the interval defined by the values of belief and plausibility.

13.3 Modeling interest for a planetary rover

The high level of autonomy required to a planetary rover demands for the ability to choose the mission goals, without human intervention, once high level mission objectives are defined, in order to maximize the scientific return of the mission. These objectives, such as “look for water” or “look for traces of life”, do not identify exactly where to go and which experiments to perform. The rover should be able to uniquely define what is interesting, by means of the information gathered during the mission, and make decisions without waiting for instructions from the ground station. The collected pieces of information can be incomplete and uncertain. In particular, the Wisdom system uses different sensors to obtain the pieces of evidence required to

make a decision. Each instrument plays the role of a scientist or of a ground control specialist. DSMT is used to model the following situation: each scientist (or specialist) expresses an opinion on the interest of a given object or portion of the surrounding area; the scientist admits no uncertainty but the one that comes from the instruments. On the other hand, every scientist leaves some margin for discussion, accepting the existence of opposite opinions.

13.3.1 Modeling of sensor information

Nausicaa, the rover used to test the Wisdom system, is equipped with an infrared camera (the scientific payload) and two optical navigation cameras that give a stereographic view of the surrounding environment (the navigation module). The optical stereo images are used to generate an elevation map of the ground, called Digital Elevation Map or DEM. The DEM is a matrix containing the height of the corresponding point on the ground. The DEM can be a partial reconstruction of the surroundings. Some parts of the terrain may not be in sight, because hidden by other parts (e.g. rocks or hills), and thus it is not possible to have any information about them. Furthermore, the algorithm can fail to determine the height of some points, especially if the image quality is poor. For these reasons, a second matrix is stored together with the DEM: it contains the uncertainty on the elevation of each point in the DEM. Values are between 0 and 1, where the former means total certainty on the elevation. Besides giving information on the elevation of the ground, optical images provide information on the texture of objects and surfaces. A texture map is then created by associating to each point in view an integer value identifying a specific material. Since this information might not be accurate or the image could be poor, a map of uncertainty is associated to the texture map. The payload mounted on Nausicaa generates a thermal map of the environment. This map is analogous to the DEM, but contains the temperature of each visible point. An uncertainty map is then associated to the thermal map, in order to take into account partial information due to occultation or the measurement noise of the infrared sensor. The final step consists of fusing the data of the three maps, to generate a single one: the interest map.

13.3.2 Definition of the Interest Map

The interest map is a matrix in which each element represents the belief that a particular spot on the ground is interesting. A frame of discernment $\Theta = \{I, NI\}$ was defined, where I is the hypothesis *interesting* and NI is the hypothesis *not-interesting*. Interest is a vague concept and is subjective in nature. The associated hyper-power set is defined as $D^\Theta = \{\emptyset, I, NI, I \cup NI, I \cap NI\}$, and gbbas are assigned to the interesting and not interesting hypotheses, but also to:

- $I \cup NI$: uncertain hypothesis. Represents the amount of ignorance, or the lack of knowledge of the expert which is dealing with the gbbas assignment. The

expert assigns evidence to this hypothesis when the uncertainty on the data is high, due for example to distance, error on the sensor, or even lack of data.

- $I \cap NI$: paradoxical hypothesis. This is the case in which two distinct scientists disagree on the interest level of a particular area. One of the scientists, according to the readings of his instruments, assigns a very high *gbba* to the interesting hypothesis while the other assigns a very high *gbba* to the not interesting hypothesis.

Note that in the classical probability theory, these two additional hypotheses do not exist. Furthermore, the difference between the uncertain and the paradoxical cases is that the former expresses uncertainty due to lack of knowledge or information, while the latter does not claim any ignorance, but the possibility that both hypotheses could be true at the same time.

As a consequence, the two associated hypotheses are vague, can be overlapped, and cannot be considered as mutually exclusive. The various pieces of information can be conflicting and highly uncertain. These types of information can be effectively handled through DS_mT since it can manage conflicts among various experts and provides a single rule of combination.

The interest map is created point by point (see Fig. 13.1), by fusing all the available pieces of information (or evidence that a point is interesting or not) about each one of the maps as summarized in Fig. 13.2.

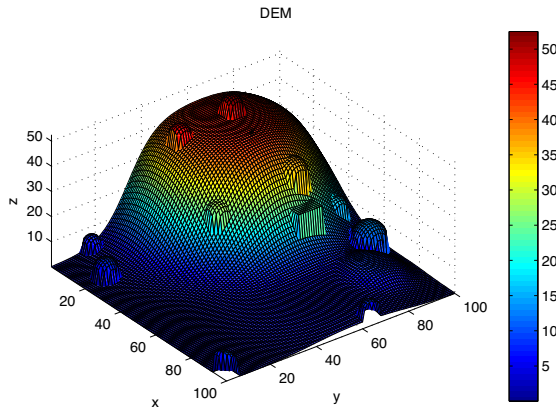

Figure 13.1: The interest map.

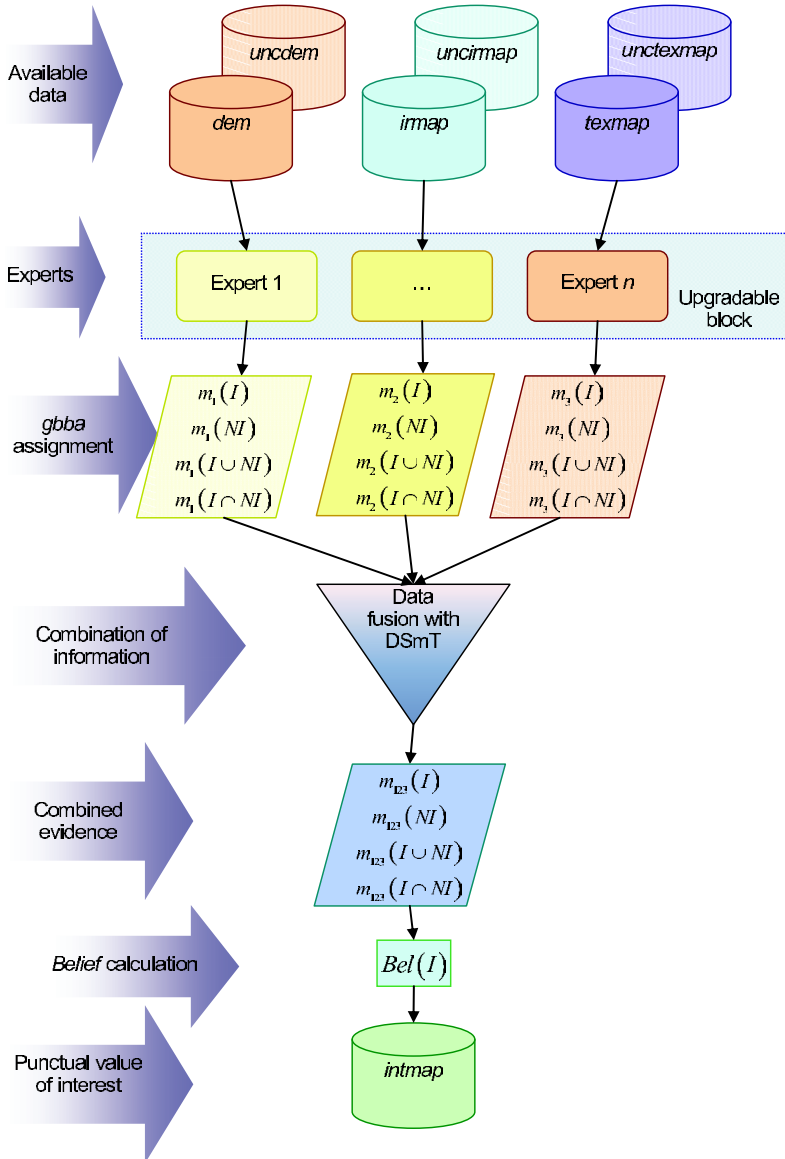

Figure 13.2: Diagram of the procedure to create the interest map.

A set of independent experts (the instruments) creates the bodies of evidence that will be fused. For each point on the map the expert has to express an opinion on whether the point is interesting or not based on some evidence. The opinion is expressed by assigning gbba to each point on the map. The evidence comes from the readings of the navigation and scientific instruments. In particular, three experts were created, one for each map. The gbba that each expert assigns to a point on the map depends on the scientific objectives of the mission and on the available measurements. The measured values are compared against the values in a reference look-up table (the tables for the three experts can be found in Table 13.1 to Table 13.3). For example, in this work, we assume that the expert associated to the DEM is interested in sharp edges and in the lateral surface of the rocks since they are easily accessible. Thus, it assigns much gbba to the interesting case (and little to the not interesting case), when the value of the gradient of the DEM is high, and vice-versa (Table 13.1). In addition, for some values of the gradient, gbba is also assigned to the paradoxical case. This is done not because of lack of knowledge of the roughness of the terrain (in which case, gbba is assigned to the uncertain hypothesis), but because the value of the gradient alone would not be sufficient to completely define whether an area is interesting or not. Assigning gbba to the paradoxical case allows for the integration of the opinions of other experts even if they are conflicting with the one of the DEM expert.

In the same way, the temperature expert assigns interest to some temperatures (Table 13.2), and the texture expert assigns interest to some specific textures (Table 13.3). Non-dimensional units have been used in these tables. As before, gbba is assigned to the paradoxical hypothesis when the values associated to temperature and texture cannot be used to completely establish whether the point is interesting or not.

Modulus of the gradient of the DEM	$m(I \cap NI)$	$m(NI)$	$m(I)$
$[0, 1)$	0.20	0.80	0
$[1, 3)$	0.30	0.60	0.10
$[3, 5)$	0.10	0.10	0.80
$[5, 7)$	0.15	0.05	0.80
$[7, 9)$	0.05	0.05	0.90
$[9, +\infty)$	0.05	0	0.95

Table 13.1: Table for the DEM expert.

At first no gbba is assigned to the uncertain hypothesis $I \cup NI$; subsequently, each expert redistributes part of the basic probability associated to the hypothesis $I \cap NI$, NI , I to the hypothesis $I \cup NI$. The gbba are redistributed proportionally to the value u of the corresponding uncertainty map associated to each expert map,

Temperature	$m(I \cap NI)$	$m(NI)$	$m(I)$
[0, 20)	0.20	0.80	0
[20, 40)	0.40	0.50	0.10
[40, 60)	0.05	0	0.95
[60, 80)	0.15	0.05	0.80
[80, 100)	0.05	0.05	0.90

Table 13.2: Table for the temperature map expert.

Texture	$m(I \cap NI)$	$m(NI)$	$m(I)$
Texture not in database	0.20	0.80	0
1	0.30	0.60	0.10
2	0.10	0.10	0.80
3	0.15	0.05	0.80
4	0.05	0	0.95

Table 13.3: Table for the texture expert.

by using the following classical discounting procedure:

$$\left. \begin{aligned} \delta(i) &\leftarrow m(i) \cdot u \\ m(i) &\leftarrow m(i) - \delta(i) \\ m(I \cup NI) &\leftarrow m(I \cup NI) + \delta(i) \end{aligned} \right\} i = I \cap NI, NI, I \quad (13.4)$$

The value of u depends on the characteristics of the sensor (e.g. measurement errors).

In this work, uncertainty maps will be simulated in order to provide a variety of test cases for the data fusion process. Therefore, the value of u will not be chosen to reproduce the actual measurements but just to test the proposed methodology. Note that, if the instruments are ideal and no uncertainty in their measurements is present, no mass is assigned to the hypothesis $I \cup NI$. The assignment process presented in (13.4) is applied to each point on the DEM. Given the three sets of evidence by each expert, the general combination rule for paradoxical sources of DSmt is applied, and the combined evidence is computed. The following step is to compute the belief in the hypothesis *interesting*, $Bel(I)$. This value gives a pessimistic estimation (lower boundary) of the probability of that point to be actually interesting. Therefore, the interest map will contain, for each point on the DEM, the belief that point is interesting, according to the high level mission goals. The planner will then give more importance to those areas that are more likely to be interesting, and will reallocate the goals in order to maximize the cumulative value of interest with the highest reliability. In the following section, we will present how each maps are generated and how the belief is computed for a specific test case.

13.4 Some results with DSmtT

The proposed approach was initially tested in a simulated environment. A synthetic landscape was generated inserting typical features like rocks with different textures and slopes with different gradients. The algorithm was run simulating the behavior of the two navigation and the infrared cameras mounted on Nausicaa. The aim of this sample test case was to generate an interest map that was consistent with the simulated features. The result was then used by the planner [11] to generate a set of mission goals in order to visit only the spots that are considered to be the most rewarding in terms of science. The synthetic landscape, represented in Fig. 13.3, was converted into a DEM. The x-y plane in the figure represents an ideal horizontal plane, while z is the elevation of each point of the terrain with respect to this plane. Non-dimensional units for distances and temperatures have been used. Assuming that the rover is in the centre of the map, and the height of the camera from the ground is 40 units, it has been possible to calculate whether each point of the map was in sight of the camera or not (Fig. 13.4). As explained above, the module that generates the DEM provides also an uncertainty map based on visibility (partial information about the landscape) and on the intrinsic measurement errors of the digital cameras. The uncertainty map is initially created with values of zero (point in sight, no uncertainty on its elevation) or one (hidden point, no information about its elevation). Then, the uncertainty due to errors of recognition of the disparity maps are simulated by introducing a noise component, with a value in the interval $[0, 0.2]$. The resulting uncertainty map is represented in Fig. 13.5.

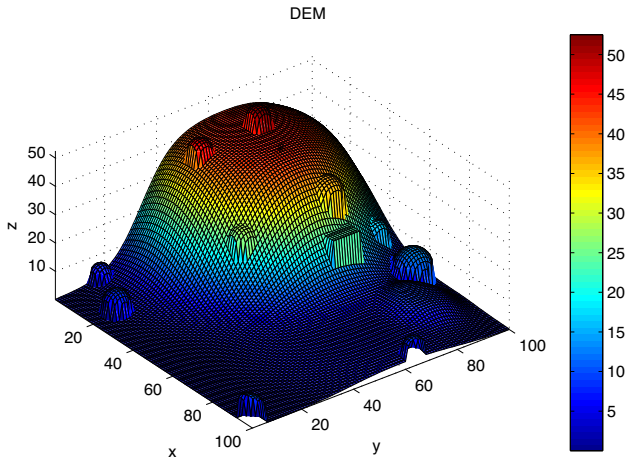

Figure 13.3: DEM of the synthetic landscape: bumped features represent rocks.

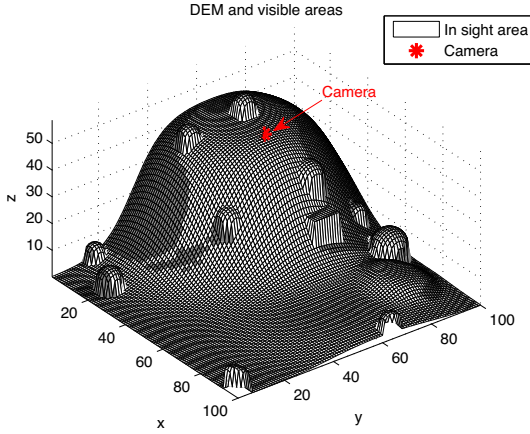

Figure 13.4: Visibility map superimposed on the DEM: in dark grey, surfaces that are not in sight. The camera is in the middle of the map, at a height of 40 units from the ground.

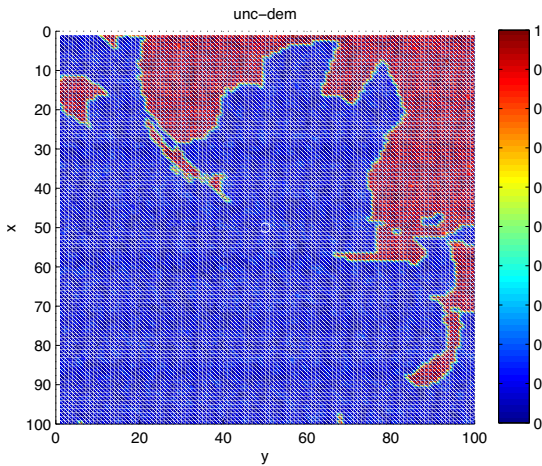

Figure 13.5: The resulting uncertainty map associated to the DEM.

The expert that creates the evidence from the DEM first computes the map of the gradient of the terrain, starting from its elevation; then, it assigns high interest to the points which have a high gradient, and low interest to other points (Table 13.1).

In Fig. 13.6, there is a representation of the absolute value of the gradient of the DEM, as computed by the corresponding expert. The virtual infrared map contains the temperature of the corresponding point on the DEM.

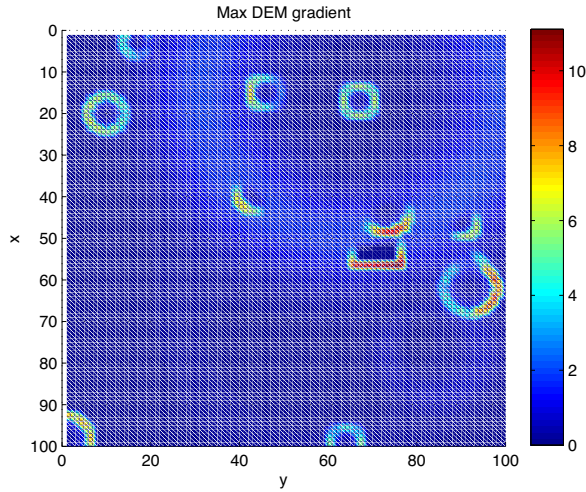

Figure 13.6: Representation of the absolute value of the gradient of the DEM.

The expert associated to the infrared camera assigns high levels of interest to hot areas. The Fig. 13.7 shows the temperature distribution in the virtual environment: the whole terrain as an average temperature below 5 (in the non-dimensional units of temperature) which correspond to a cold terrain, apart from single circular hot area.

The texture distribution is represented in Fig. 13.8: four different patterns have been considered, each one corresponding to one color in the figure. The reference textures with their associated level of interest are stored in a database onboard. The expert of this map assigns the gbba according to the reference values in Table 13.3: it was assumed texture 4 (colored in brown in Fig. 13.8) has the a greatest probability to be interesting for this particular mission.

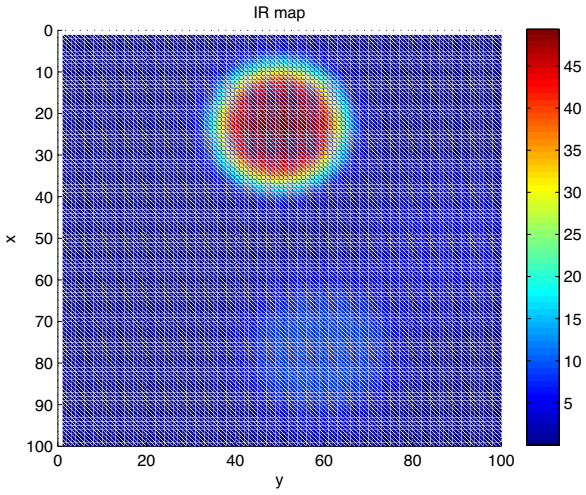

Figure 13.7: The infrared map.

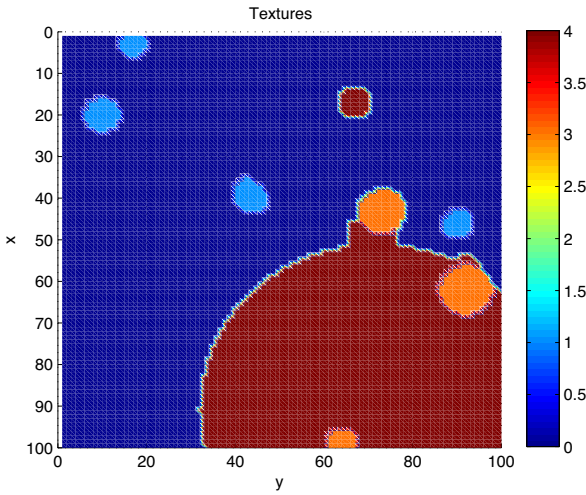

Figure 13.8: The texture map.

The experts associated to the texture and infrared maps generate the corresponding uncertainty maps in a similar fashion as the expert of the DEM: they check for visibility of each point and surface in the map. In fact, if the infrared image and optical image are captured simultaneously, without moving the rover, the unknown areas must be the same. However, this yields the same level of uncertainty for the same points on all the three maps. Therefore it was assumed that the uncertainties for the infrared map grows linearly from the bottom end of the map to the upper end of the map, while the uncertainty on the texture grows linearly from the right end to the left end of the map, as shown in Fig. 13.9. Note that this assumption has no particular physical meaning, but it allows us to have areas with very different and mixed levels of uncertainties, thus testing properly the proposed data fusion framework. A different distribution of uncertainty, though producing different values, does not change the significance of the results presented in this chapter. As stated above, in a real case, the uncertainty map would depend on the properties of the instruments and on the level of confidence of the scientists in their own judgment.

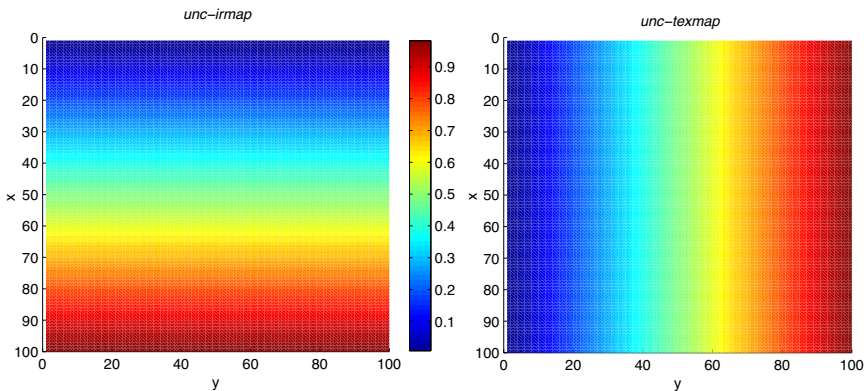

Figure 13.9: The uncertainty associated to the infrared map (left) and to the texture map (right).

Given the maps and the experts, the result of the fusion process, as explained in paragraph 13.3.2, is the interest map shown in Fig. 13.10. The value associated to each point in the map represents the belief that the point is interesting. The areas identified by the letters A, B, C, D, E, F, G, H and I in Fig. 13.10, corresponding to rock borders, are marked as very interesting because of the high gradient value. It shall be noted that only the parts in sight of the cameras are interesting (this is particularly noticeable in the case of spots B, C, D and G). Where the rock is hidden, the gradient is high, but its unreliability is high, as well; thus, the assignment from the expert is uncertain and the associated belief is low. The circular area identified

with letter L is considered interesting mainly by the expert of the infrared map but its visibility is high as well as its reliability. In fact, Fig. 13.7 shows that the temperature is high in that area and Fig. 13.9a shows that for that area, the infrared map has a low uncertainty value; thus the information it gives is considered to be very reliable.

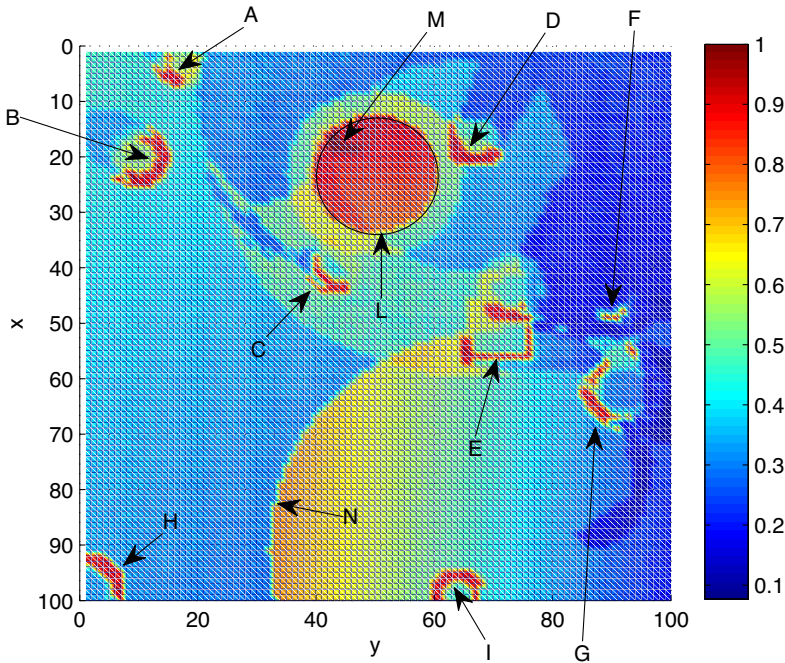

Figure 13.10: Interest map: different colors represent different values of $Bel(I)$.

The small area with letter M is the most interesting of the whole map, with a value close to one. This is due to the synergy between the DEM and the infrared experts: both have certain information, and the gradient and the temperature are very high. The sudden change in the level of interest on area N is a consequence of the discontinuity of the soil texture, as can be seen in Fig. 13.8. Looking at the map, starting from the area N, and moving right, the degree of interest gradually decreases because the texture information is gradually less reliable on the right part of the map, as can be seen in Fig. 13.9b.

Notice how both the infrared and the DEM expert regarded this area as not interesting but both the DEM and the texture experts stated that the reliability of what observed was good while the infrared stated the opposite. Nonetheless, the

fused reliability of the texture and of the DEM maps supports the hypothesis that this area is worth a visit and is safe enough; as a consequence the associated belief is moderately high. Finally a three dimensional representation of the interest map superimposed onto the DEM can be seen in Fig. 13.11.

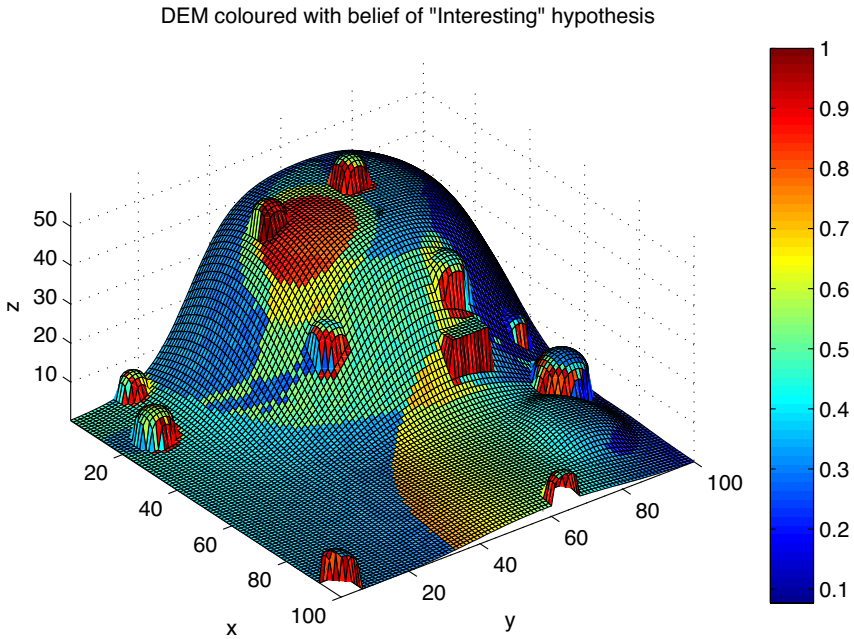

Figure 13.11: Interest map superimposed on the DEM.

13.4.1 DST applied the generation of the Interest Map

The DS_mT can be considered as an extension of the Dempster-Shafer Theory of Evidence (DST), from which it was derived. In fact, the DST is a particular case of the DS_mT, in which all the sets of a given frame of discernment are disjoint (i.e., $\forall A, B \in \Theta, A \neq B \rightarrow A \cap B = \emptyset$). As a consequence, the set of possible hypotheses for a frame of discernment $\Theta = \{\theta_1, \theta_2\}$ is its power set $2^\Theta = \{\emptyset, A, B, A \cup B\}$. As for the DS_mT, we have $m(\emptyset) = 0$ and $\sum_{A \in D^\Theta} m(A) = 1$ but in this case D^Θ reduces to 2^Θ . In the literature, the function $m(\cdot)$ is generally called basic probability assignment (bpa), when referred to the DST framework. There are several different rules for combining bodies of evidence from different experts under this framework.

The classical Dempster's rule, which is associative and commutative, fuses the bpa m_1 and m_2 of two experts referred to the same frame of discernment in the following way:

$$m_{12}(A) = \frac{\sum_{\substack{B, C \in 2^\Theta \\ B \cap C = A}} m_1(B)m_2(C)}{1 - \sum_{\substack{B, C \in 2^\Theta \\ B \cap C = \emptyset}} m_1(B)m_2(C)}, \forall A \in 2^\Theta \quad (13.5)$$

The Belief and Plausibility functions are computed in the same way as in the DSMT, that is using (13.3), given that the power set 2^Θ shall be considered. The different behavior of the two theories is evident when conflicting bba's are given by the experts. In particular, the famous Zadeh's example [4] highlights the counter-intuitive results which the DST can lead to, while the DSMT is able to solve the contradiction in the sources of information quite easily, thank to the presence of the paradoxical hypothesis.

A simple case that brings to quite different results is when the assignments of two different sources are given, as in Table 13.4. In this case, the evidence of the two experts is almost totally conflicting, with a small uncertainty: this situation can happen, for example, when the terrain is flat (then not interesting for the DEM expert) but the texture is very interesting. The fusion through the DST, according to (13.5), leads to the combined bpa shown in the first column of Table 13.5. The DST combination rule assigns the same amount of evidence to both the hypotheses I and NI . In this framework, the value of $Bel(I)$ is the same as $m(I)$. In essence, the DST states that the point has the same probability of being interesting or not interesting, which does not allow the rover to take a decision on whether to investigate that point or not. On the other hand, the DSMT assigns most of the evidence to the paradoxical hypothesis $I \cap NI$, which is contributing in the value of $Bel(I)$.

	Expert 1	Expert 2
$m_i(I)$	0.99	0
$m_i(NI)$	0	0.99
$m_i(I \cup NI)$	0.01	0.01

Table 13.4: Example of conflicting bodies of evidence for two different experts.

To show the different results in fusing the data using either the DST or the DSMT, let us consider the border of the rock D. As an example, we take the point (67, 20): for this point, we have the values for the gradient of DEM, texture and temperature listed in Table 13.6, with corresponding uncertainties.

According to these values, the consequent bba's (or gbba's) are also shown in the same table.

	DST	DSmT
$m_{12}(I)$	0.4975	0.0099
$m_{12}(NI)$	0.4975	0.0099
$m_{12}(I \cup NI)$	0.005	0.0001
$m_{12}(I \cap NI)$	-	0.9801
$Bel(I)$	0.4975	0.99

Table 13.5: Combined evidence and Belief according to DST and DSmT, for evidence provided by the two experts in Table 13.4.

	Value	$m(I \cap NI)$	$m(NI)$	$m(I)$	$m(I \cup NI)$
Gradient of the DEM	6.088	0.15	0.05	0.8	0
Texture	4	0.017	0	0.323	0.66
Temperature	10.23	0.162	0.648	0	0.19

Table 13.6: Values of the three maps at point (67, 20), uncertainties, and corresponding assignments made by the experts.

The result of the combination through the DSmT is shown in Table 13.7. In conclusion, according to the DSmT, the point should be highly interesting, as the belief of the I hypothesis is close to one.

	DSmT Combined Evidence
$m(I \cap NI)$	0.82293004
$m(NI)$	0.02765400
$m(I)$	0.14941600
$m(I \cup NI)$	0
$Bel(I)$	0.97234607

Table 13.7: Combined evidence and Belief using the DSmT combination rule, for bodies of evidence given in Table 13.6.

The use of the DST, instead, leads to a different result. The DST associative rule can be applied to the same point, but considering that in the DST framework, all the sets are disjoint, so $I \cap NI = \emptyset$, it would make no sense to assign bpa to this case. We decided here to reassign the gba of the hypothesis $I \cap NI$ to the hypothesis $I \cup NI$, as in Table 13.8, since a conflict of opinions would lead to a stall in the decision making process, analogous to a lack of information. Note that, for this case, a different choice of the bpa re-assignment would not change substantially the result obtained with the DST. Applying the DST combination rule, we obtain the evidence

in Table 13.9. Then we can state that, using the DST, the belief in the interesting hypothesis is significantly lower than for the DS_mT. The border of the rock will not be a primary objective to analyze for the rover in this case.

	$m(NI)$	$m(I)$	$m(I \cup NI)$
Gradient of the DEM	0.05	0.8	0 + 0.15
Texture	0	0.323	0.66 + 0.017
Temperature	0.648	0	0.19 + 0.162

Table 13.8: Re-assignment of the gbba of the paradoxical hypothesis to the uncertain hypothesis.

	Dempster Combined Evidence
$m(NI)$	0.2296
$m(I)$	0.6881
$m(I \cup NI)$	0.0824
$Bel(I)$	0.6881

Table 13.9: Combined evidence and Belief using the Dempster combination rule, for bodies of evidence given in Table 13.8.

A great number of fusion rules exists, in the DST framework: among those, a set of Proportional Conflict Redistribution rules (PCR) has been studied. The so-called PCR5 is claimed to be the most mathematically exact rule for redistributing the conflicting mass [8]. Since the computation of the combined bba's using the PCR5 becomes quite complicated when more than 2 sources are involved (and in this example they are 3), we decided to show the results of the fusion using the approximated formulation PCR5b. The final masses are obtained in two steps: first, the masses $m_1(\cdot)$ and $m_2(\cdot)$ relative to experts 1 and 2 are combined using the DS_mT classical rule, obtaining $m_{12}(\cdot)$; then the resulting masses are combined again with source 3, giving $m_{123}(\cdot)$. At this point, the conflicting mass $m_{123}(A \cap B)$ is redistributed proportionally to the basic probability assignments of the experts, according to the rule. If we call $m_{PCR5b\{12\}3}(\cdot)$ the combined evidence after the redistribution of the conflict, we have:

$$\begin{aligned}
 m_{PCR5b\{12\}3}(I) &= m_{123}(I) + m_3(I)m_{12}(I \cap NI) + \\
 &\quad m_{12}(I)\frac{m_{12}(I)m_3(NI)}{m_{12}(I) + m_3(NI)} + m_3(I)\frac{m_3(I)m_{12}(NI)}{m_3(I) + m_{12}(NI)} \\
 m_{PCR5b\{12\}3}(NI) &= m_{123}(NI) + m_3(NI)m_{12}(I \cap NI) + \\
 &\quad m_3(NI)\frac{m_{12}(I)m_3(NI)}{m_{12}(I) + m_3(NI)} + m_{12}(NI)\frac{m_3(I)m_{12}(NI)}{m_3(I) + m_{12}(NI)} \\
 m_{PCR5b\{12\}3}(I \cup NI) &= m_{123}(I \cup NI) + m_3(I \cup NI)m_{12}(I \cap NI)
 \end{aligned}
 \tag{13.6}$$

This rule leads to the combined evidence shown in Table 13.10. Although the redistribution of the conflicting masses changed the results slightly with respect to the classical DST combination rule, the difference with the DS_mT remains remarkable.

PCR5b Combined Evidence	
$m(NI)$	0.3482
$m(I)$	0.6104
$m(I \cup NI)$	0.0414
$Bel(I)$	0.6104

Table 13.10: Combined evidence and Belief using the PCR5b combination rule, for bodies of evidence given in Table 13.8.

13.4.1.1 Application of DST to a modified frame of discernment

If the frame of discernment is refined in the following way: $\Theta_{ref} = \{I \cap NI, I/(I \cap NI), NI/(I \cap NI)\}$, then we can apply DST and obtain a result equivalent to the one computed using DS_mT. Given the new refined frame of discernment, the power set is:

$$2^{\Theta_{ref}} = \{\emptyset, X, Y, Z, X \cup Y, X \cup Z, Y \cup Z, X \cup Y \cup Z\}
 \tag{13.7}$$

where:

$$\begin{aligned}
 X &= I \cap NI \\
 Y &= I \cup (I \cap NI) \\
 Z &= NI \cup (I \cap NI)
 \end{aligned}
 \tag{13.8}$$

Let us denote with prime the bba's referred to the refined frame of discernment. If we assign the bba's for each generic expert i in the following way:

$$\begin{aligned}
m'_i(X) &= m_i(I \cap NI) \\
m'_i(X \cup Y) &= m_i(I) \\
m'_i(X \cup Z) &= m_i(NI) \\
m'_i(X \cup Y \cup Z) &= m_i(I \cup NI) \\
m'_i(A \in 2^{\Theta_{ref}}, A \neq X, X \cup Y, X \cup Z, X \cup Y \cup Z) &= 0
\end{aligned} \tag{13.9}$$

and the DST combination rule in (13.5) is applied, we see that the denominator in (13.5) is:

$$1 - \sum_{\substack{B, C \in 2^{\Theta_{ref}} \\ B \cap C = \emptyset}} m'_1(B)m'_2(C) = 1 \tag{13.10}$$

Computing the bba, for example, for $m'_{12}(X)$, we obtain:

$$\begin{aligned}
m'_{12}(X) &= m'_1(X)m'_2(X) + m'_1(X \cup Y)m'_2(X \cup Z) + \\
& m'_1(X \cup Z)m'_2(X \cup Y) + m'_1(X)m'_2(X \cup Y) + \\
& m'_1(X)m'_2(X \cup Z) + m'_1(X)m'_2(X \cup Y \cup Z) + \\
& m'_2(X \cup Y)m'_2(X) + m'_1(X \cup Z)m'_2(X) + \\
& m'_1(X \cup Y \cup Z)m'_2(X)
\end{aligned} \tag{13.11}$$

On the other hand, applying the DSMT combination rule (13.2) to the standard frame $\Theta = \{I, NI\}$, we obtain for $m_{12}(I \cap NI)$:

$$\begin{aligned}
m_{12}(I \cap NI) &= m_1(I \cap NI)m_2(I \cap NI) + \\
& m_1(I)m_2(NI) + m_1(NI)m_2(I) + m_1(I \cap NI)m_2(I) + \\
& m_1(I \cap NI)m_2(NI) + m_1(I \cap NI)m_2(I \cup NI) + \\
& m_1(I)m_2(I \cap NI) + m_1(NI)m_2(I \cap NI) + \\
& m_1(I \cup NI)m_2(I \cap NI)
\end{aligned} \tag{13.12}$$

Eq. (13.11) and (13.12) are equivalent and return the same value. The same happens for $m'_{12}(X \cup Y \cup Z)$, $m'_{12}(X \cup Z)$, $m'_{12}(X)$. Therefore, the fusion obtained using the DST with the refined frame of discernment, and the one obtained with the original model and DSMT are identical. Note that, the refinement of the frame of discernment would require a probability assignment to the hypotheses $I/(I \cap NI)$ and $NI/(I \cap NI)$ that have little physical meaning and are not intuitive. Therefore, although DST can be used to define the interest map, DSMT offers a more direct definition and treatment of the two hypotheses I and NI without the need for an artificial redefinition of the frame of discernment. Furthermore, it should be noted that DSMT allows the direct treatment of a case in which a source is totally sure about its assignment and therefore cannot assign any probability to the hypothesis $I \cup NI$. In this case assigning a probability to the hypothesis $I \cap NI$ would correspond to allowing some room for discussion and opposite opinions as mentioned above.

13.5 Final remarks

In this chapter, an algorithm for the definition of the level of interest of mission goals for a planetary rover was presented. By fusing navigation data and payload data (infrared camera in this specific case), the rover was endowed with the capability to autonomously assign a level of interest to mission goals. The interest level allows the rover to prioritize, reallocate and choose the most appropriate set of goals depending on contingent situations. The modern theory of Plausible and Paradoxical Reasoning was used to generate an interest map by which the rover can reallocate its goals autonomously in order to maximize the scientific return of the mission. The theory gives the possibility of dealing with vague quantities, like the degree of interest of an object. In particular, the advantage of DSMT is the possibility to directly assign a level of interest to hypothesis I and NI for each point of the DEM, leaving room for potential disagreements among the scientists or between the scientists and the ground control team. The results showed that the proposed approach is suitable to uniquely identify the interesting zones, given the high level scientific goals of the mission. The goals can be easily modified or tuned, by changing the experts used into the data fusion process.

13.6 Acknowledgments

This work is a part of the Wisdom project, for the development of a system for rover autonomy. Wisdom was developed under the ESA ITI contract 18693/04/NL/MV at Politecnico di Milano, when all the authors were working or studying there. The authors would like to thank Luc Joudrier of the robotic division of ESA/ESTEC. A special thank also to Flavio Fusco, Beatrice Midollini and Fabrizio Cappelli of Galileo Avionica, Lester Waugh and Ronan Wall of Astrium UK, for the industrial support and for the precious advices. The authors would also like to thank Dr. Jean Dezert and Dr. Florentin Smarandache for their precious suggestions and ideas on how to apply DSMT and DST to our case.

13.7 References

- [1] P. Baglioni, R. Fisackerly, B. Gardini, G. Gianfiglio, A.L. Pradier, A. Santovincenzo, J.L. Vago, M. van Winnendael, *The Mars exploration plans of ESA: The ExoMars mission and the preparatory activities for an international Mars Sample Return mission*, IEEE Robotics and Automation Magazine, 13(2), pp. 83-89, 2006
- [2] M. Ceriotti, M. Vasile, G. Giardini, M. Massari, *A non-deterministic planner for planetary rover autonomy*, Proceedings of the AIAA/AAS Astrodynamics Specialist Conference and Exhibit, Keystone, CO, U.S.A., 2006.

- [3] S. Corgne, L. Hubert-Moy, J. Dezert, G. Mercier, *Land cover change prediction with a new theory of plausible and paradoxical reasoning*, Proceedings of the Sixth International Conference of Information Fusion, Cairns, Australia, 2003.
- [4] J. Dezert, *Foundations for a new theory of plausible and paradoxical reasoning*, Information & Security, An International Journal, edited by Prof. Tzv. Semerdjiev, CLPP, Bulgarian Acad. of Sci., 9, 2002.
- [5] J. Dezert, F. Smarandache, *On the generation of hyper-power sets for the DS_mT*, Proceedings of the Sixth International Conference of Information Fusion, Cairns, Australia, 2003.
- [6] J. Schmidhuber, *Artificial Curiosity Based on Discovering Novel Algorithmic Predictability Through Coevolution*, Proceedings of the Congress on Evolutionary Computation, Lugano, Switzerland, 1999.
- [7] G. Shafer, *A mathematical theory of evidence*, Princeton University Press, Princeton, 1976.
- [8] F. Smarandache, J. Dezert (editors), *Advances and Applications of DS_mT for Information Fusion*, Collected Works, Vol. 2. Available at <http://www.gallup.unm.edu/smarandache/DSmT-book2.pdf>.
- [9] A. Stentz, M. Hebert, *A complete navigation system for goal acquisition in unknown environments*, Autonomous Robots, 2(2), pp. 127-145, 1995.
- [10] A. Tchamova, T. Semerdjiev, J. Dezert, *Estimation of target behavior tendencies using Dezert-Smarandache theory*, Proceedings of the Sixth International Conference of Information Fusion, Cairns, Australia, 2003.
- [11] M. Vasile, M. Massari, G. Giardini, *WISDOM - An advanced intelligent, fault-tolerant system for autonomy in risky environments*, ESA-ITI Final study report, 2005.
- [12] M. Veloso, J. Carbonell, A. Perez, D. Borrajo, E. Fink, J. Blythe, *Integrating planning and learning: the Prodigy architecture*, Journal of Experimental & Theoretical Artificial Intelligence, 7(1), p. 81, 1995.
- [13] M.T. Cox, M.M. Veloso, *Goal transformations in continuous planning*, Proceedings of the 1998 AAAI Fall Symposium on Distributed Continual Planning, Menlo Park, CA, 1998.
- [14] L. Wald, *Some terms of reference in data fusion*, IEEE Transactions on Geoscience and Remote Sensing, 37(3, Pt. 1), pp. 1190-1193, 1999.
- [15] M. Williamson, S. Hanks, *Optimal Planning With a Goal-Directed Utility Model*, proceedings of the Second International Conference on AI Planning Systems, 1994.

Chapter 14

Performance evaluation of a tracking algorithm including attribute data

Jean Dezert

ONERA/DTIM/SIF,
29 Av. Division Leclerc,
92320 Châtillon, France.
jean.dezert@onera.fr

Albena Tchamova, Ludmil Bojilov,
Pavlina Konstantinova

IPP, Bulgarian Academy of Sciences,
"Acad. G. Bonchev" Str., bl. 25-A,
1113 Sofia, Bulgaria.
tchamova,bojilov,pauvlina@bas.bg

Abstract: *The main objective of this work is to investigate the impact of the quality of attribute data source on the performance of a target tracking algorithm. An array of dense scenarios arranged according to the distance between closely spaced targets is studied by different confusion matrices. The used algorithm is Generalized Data Association algorithm for Multiple Target Tracking (GDA-MTT) processing kinematic as well as attribute data. The fusion rule for attribute data is based on Dezert-Smarandache Theory (DSmT). Besides the main goal a comparison is made between the cited above algorithm and an algorithm with Kinematic based only Data Association (KDA-MTT). The measures of performance are evaluated using intensive Monte Carlo simulation.*

14.1 Introduction

Target tracking of closely spaced targets is a challenging problem. The kinematic information is often insufficient to make correct decision which observation to be associated to some existing track. A new approach presented in [15] describes a Generalized Data Association (GDA) algorithm incorporating attribute information. The presented results are encouraging, but it is important to study the algorithm performance for more complex scenarios with more maneuvering targets and different levels of quality of attribute data source. It is important to know the level of quality of the attribute detection used to assure robust target tracking in critical, highly conflicting situations. The goal of this paper is by using Monte Carlo simulation to determine the sufficient level of quality of attribute measurements that for given standard deviations of the kinematic measurements (in our case azimuth and distance) to overcome allowable miscorrelations.

14.2 Problem formulation

Classical target tracking algorithms consist mainly of two basic steps: *data association* to associate proper measurements (usually kinematic measurement $z(k)$) representing either position, distance, angle, velocity, accelerations etc.) with correct targets; *track filtering* to estimates and predict the state of targets once data association has been performed. The first step is very important for the quality of tracking performance since its goal is to associate correctly observations to existing tracks. The data association problem is very difficult to solve in dense multitarget and cluttered environment. To eliminate unlikely (kinematic-based) observation-to-track pairings, the classical validation test [3, 7] is carried on the Mahalanobis distance

$$d_j^2(k) = v_j'(k)S^{-1}v_j(k) \leq \gamma, \quad (14.1)$$

where $v_j(k) = \hat{z}(k) - z_j(k)$ is the difference between the predicted position $\hat{z}(k)$ and the j -th validated measurement $z_j(k)$, S is the innovation covariance matrix, γ is a threshold constant defined from the table of the chi-square distribution [3]. Once all the validated measurements have been defined for the surveillance region, a clustering procedure defines the clusters of the tracks with shared observations. Further the decision about observation-to-track associations *within the given cluster* with n existing tracks and m received measurements is considered. The Converted Measurement Kalman Filter (CMKF) [5] coupled with a classical Interacting Multiple Models (IMM) [1, 4, 8] for maneuvering target tracking is used to update the targets' state vectors.

When CMKF is used, one advantage and one drawback arise. Receiving measurements in (x, y) coordinates allows us to continue our tracking with a simple Linear Kalman Filter (KF) instead of more complicated Extended Kalman Filter (EKF). The more sophisticated calculation of the measurement matrix in EKF is replaced with a more sophisticated calculation of converted measurement covariance at each

recursion of the filter. The drawback is that CMKF accuracy strongly depends not only on the original measurement accuracy but on scenario geometry, as well. In some cases the mean of the errors is significant and unbiased compensation is needed. In [11], a limit of validity is derived when classical linearized conversion in CMKF is used - ($\frac{r\sigma_\theta^2}{\sigma_r} < 0.4$), where σ_θ and σ_r are the standard deviations for azimuth and distance measurements respectively. The quantity from the left-hand side in our scenarios is most often less than 0.01 and, hence, the validity limit is fully satisfied. The GDA-MTT improves data association process by adding attribute measurements, like amplitude information or RCS (radar cross section) [16], or eventually [6], target type decision coupled with the confusion matrix to classical kinematic measurements in order to increase the performance of the MTT system. When attribute data is available, the generalized (kinematic and attribute) likelihood ratios are used to improve the assignment. The Global Nearest Neighbor (GNN) approach is used in order to make a decision for data association on an integral criterion base. The used GDA approach consists in choosing a set of assignments $\{\chi_{ij}\}$ for $i = 1, \dots, n$ and $j = 1, \dots, m$, that assures maximum of the total generalized likelihood ratio sum by solving the classical assignment problem $\min \sum_{i=1}^n \sum_{j=1}^m a_{ij} \chi_{ij}$, where $a_{ij} = -\log(LR_{gen}(i, j))$ with

$$LR_{gen}(i, j) = LR_k(i, j)LR_a(i, j). \quad (14.2)$$

$LR_k(i, j)$ and $LR_a(i, j)$ are kinematic and attribute likelihood ratios respectively, and

$$\chi_{ij} = \begin{cases} 1 & \text{if measurement } j \text{ is assigned to track } i, \\ 0 & \text{otherwise.} \end{cases}$$

When the assignment matrix $A[a_{ij}]$ is constructed its elements a_{ij} take the following values [12]:

$$a_{ij} = \begin{cases} \infty & \text{if } d_{ij}^2 > \gamma, \\ -\log(LR_k(i, j)LR_a(i, j)) & \text{if } d_{ij}^2 \leq \gamma. \end{cases}$$

The solution of the assignment matrix is the one that minimizes the sum of the chosen elements. We solve the assignment problem by realizing the extension of Munkres algorithm, given in [9]. As a result one obtains the optimal measurements-to-tracks association. Once the optimal assignment is found, i.e. the correct association is available, the standard tracking filter is used depending on the dynamics of the tracked targets.

14.2.1 Kinematic likelihood ratios for GDA

The kinematic likelihood ratios $LR_k(i, j)$ involved into a_{ij} are easily to obtain because they are based on the classical statistical models for spatial distribution of false alarms and for correct measurements [5]. $LR_k(i, j)$ is evaluated as:

$$LR_k(i, j) = LF_{true}(i, j)/LF_{false}$$

where $LF_{true}(i, j)$ is the likelihood function that the measurement j originates from a target (track) i and LF_{false} is the likelihood function that the measurement j originates from a false alarm. At any given time k , LF_{true} is defined as:

$$LF_{true} = \sum_{l=1}^r \mu_l(k) LF_l(k)$$

where r is the number of the models used for CMKF-IMM (in our case of two nested models $r = 2$). $\mu_l(k)$ is the probability (weight) of the model l for the scan k , $LF_l(k)$ is the likelihood function that the measurement j originates from target (track) i according to the model l , i.e.

$$LF_l(k) = (1/\sqrt{|2\pi S_l^i(k)|}) \cdot \exp \frac{-d_l^2(i, j)}{2}.$$

LF_{false} is defined as $LF_{false} = \frac{P_{fa}}{V_c}$, where P_{fa} is the false alarm probability and V_c is the resolution cell volume chosen in [6] as $V_c = \prod_{i=1}^{n_z} \sqrt{12R_{ii}}$. In our case, $n_z = 2$ is the measurement vector size and R_{ii} are sensor error standard deviations for azimuth β and distance D measurements.

14.2.2 Attribute likelihood ratios for GDA

The major difficulty to implement GDA-MTT depends on the correct derivation of coefficients a_{ij} , and more specifically the attribute likelihood ratios $LR_a(i, j)$ for correct association between measurement j and target i based only on attribute information. When attribute data are available and their quality is sufficient, the attribute likelihood ratio helps a lot to improve MTT performance. In our case, the target type information is utilized from RCS attribute measurement through a fuzzification interface. A particular confusion matrix is constructed to model the sensor's classification capability.

The approach for deriving $LR_a(i, j)$ within DSMT [10, 14, 15] is based on relative variations of pignistic probabilities for the target type hypotheses, H_j ($j = 1$ for Fighter, $j = 2$ for Cargo), included in the frame Θ_2 conditioned by the correct assignment. These pignistic probabilities are derived after the fusion between the generalized basic belief assignments of the track's old attribute state history and the new attribute/ID observation, obtained within the particular fusion rule. It is proven that this approach outperforms most of the well known ones for attribute data association. It is defined as :

$$\delta_i(P^*) \triangleq \frac{|\Delta_i(P^*|Z) - \Delta_i(P^*|\hat{Z} = T_i)|}{\Delta_i(P^*|\hat{Z} = T_i)}, \quad (14.3)$$

where

$$\begin{cases} \Delta_i(P^*|Z) = \sum_{j=1}^2 \frac{|P_{T_i Z}^*(H_j) - P_{T_i}^*(H_j)|}{P_{T_i}^*(H_j)} \\ \Delta_i(P^*|Z = T_i) = \sum_{j=1}^2 \frac{|P_{T_i Z=T_i}^*(H_j) - P_{T_i}^*(H_j)|}{P_{T_i}^*(H_j)} \end{cases}$$

i.e. $\Delta_i(P^*|\hat{Z} = T_i)$ is obtained by forcing the attribute observation mass vector to be the same as the attribute mass vector of the considered real target, i.e. $m_Z(\cdot) = m_{T_i}(\cdot)$. The decision for the right association relies on the minimum of expression (14.3). Because the generalized likelihood ratio LR_{gen} is looking for the maximum value, the final form of the attribute likelihood ratio is defined to be inversely proportional to the $\delta_i(P^*)$ with i defining the number of the track, i.e. $LR_a(i, j) = 1/\delta_i(P^*)$.

14.3 Scenario of simulations and results

14.3.1 Scenario of simulations

For the simulations, we use an extension of the program package TTTLab developed under MATLABTM for target tracking [13]. This extension takes into account the attribute information. A friendly human-computer interface facilitates the changes of the design parameters of the algorithms.

The simulation scenario consists of twenty five air targets (Fighter and Cargo) moving in three groups from North-West to South-East with constant velocity of 170 *m/sec*. The stationary sensor is at the origin with $T_{scan} = 5$ *sec*, measurement standard deviations 0.3 *deg* and 100 *m* for azimuth and range respectively. The headings of the central group are 135 *deg* from North and for the left and right groups are 150 *deg* and 120 *deg* respectively. During the scans from 15th to 17th and from 48th to 50th the targets of the left and right groups perform maneuvers with transversal acceleration 4.4 *m/sec*². The targets are closely spaced especially in the middle part of their trajectories. The scenario is shown on figure 14.1.

The typical tracking performances for KDA-MTT and GDA-MTT algorithms are shown on figures 14.2 and 14.3 respectively. The Track Purity performance metrics is used to examine the fraction/percent of the correct associations. Track purity is defined as a ratio of the number of correct observation-to-track associations to total number of all possible associations during the process of tracking. Track purity metrics concerns every single target and could be averaged over all targets in the scenario as well as over all Monte Carlo runs.

Our aim in these simulations is to investigate what level of classifier accuracy we need in a particular scenario with the given separation between the closely spaced targets. We have performed consecutive simulations starting with a confusion matrix (CM) corresponding to the highest (prior) accuracy and ending with a matrix close

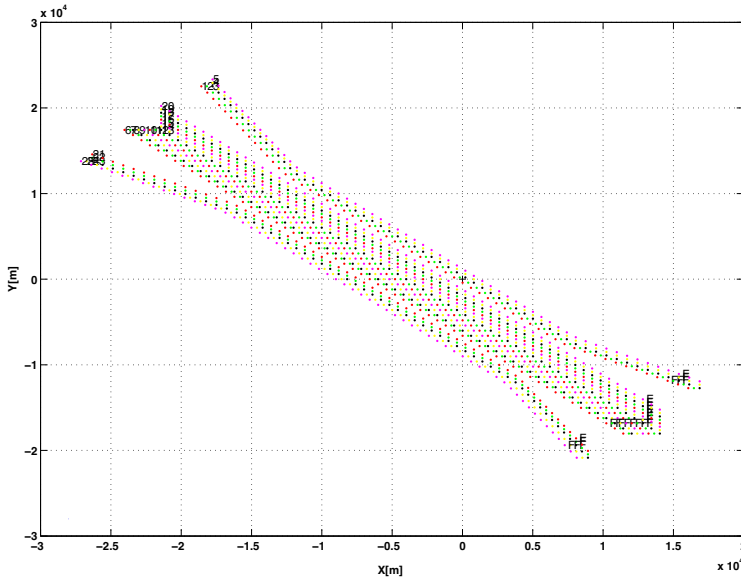

Figure 14.1: Multitarget scenario with 25 targets.

to what is expected in practice with common classifiers.

Before this, we did several simulations with highest accuracy CM and different separations of the targets starting with prohibitively close separation (approximately $d = 1.5 \sigma_{resid}$; here σ_{resid} is the residual standard deviation, ranging from 260 m at the beginning of the trajectory to 155 m) [2]. From these simulations, we try to find out the particular target's separation which insures good results in term of tracks' purity metrics.

14.3.2 Numerical results

We started our experiments with series of runs with different target separation and confusion matrix

$$CM = \begin{bmatrix} 0.995 & 0.005 \\ 0.005 & 0.995 \end{bmatrix}$$

Hereafter, because of symmetry we will show the first row of the matrix only. All the values in the next tables are averaged over the 50 Monte Carlo runs. At a

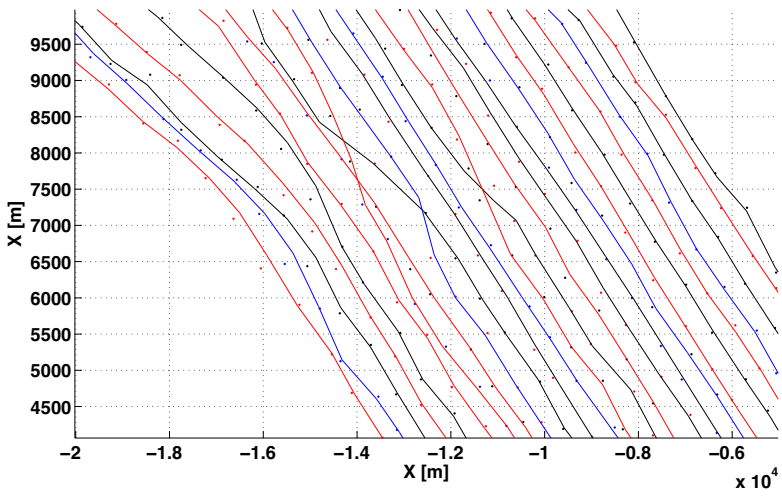

Figure 14.2: Typical performance with KDA-MTT.

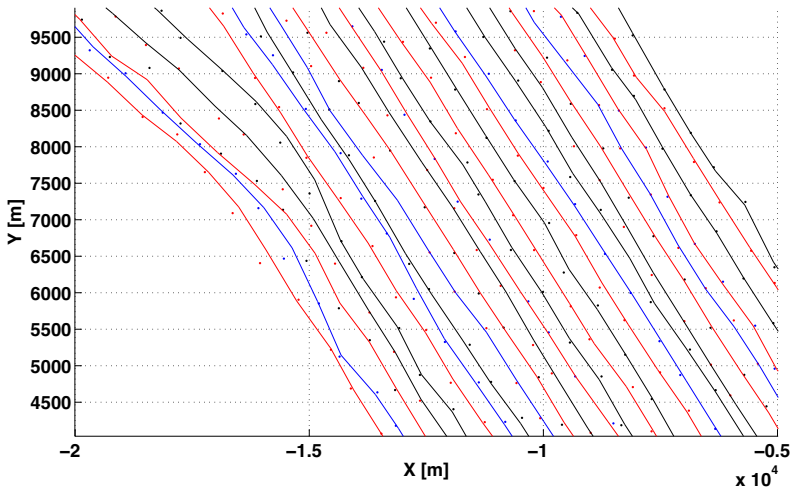

Figure 14.3: Typical performance with GDA-MTT.

distance of 300 m between targets the results are extremely discouraging for both the kinematic only and kinematic and attribute data used (the first row of the Table 14.1). There is no surprise because this separation corresponds to less than $1.5 \sigma_{resid}$. This row stands out with remarkable ratio of 'attribute' to 'kinematic' percents of tracks' purity. In the 'kinematic' case, less than one tenth of tracks are processed properly while with using the attribute data almost two thirds of targets are not lost. Nevertheless, the results are poor and unacceptable from the practical point of view. In the next rows of the table, we have increased gradually the distance between the targets until reaching a separation of 600 m . This distance corresponds to $2.5 \sigma_{resid}$ and the results are good enough especially for the DSMT based algorithm.

Distance in m	Track purity [%]	
	GDA(PCR5)	KDA
300	57.99	8.65
350	74.47	12.43
400	87.45	21.17
450	93.24	35.47
500	95.94	56.12
550	96.74	74.74
600	97.76	86.40

Table 14.1: $P_d = 0.995$, $CM(0.995, 0.005)$.

The next step is to choose this medium separation size which ensures highly acceptable results. We take the distance of 450 m because it is in the middle of the table and its results are very close to that of larger distances. Now we start our runs with confusion matrix $(0.995; 0.005)$ corresponding to highest accuracy and gradually change its elements to more realistic values according to the Table 14.2. In this table, the tracks' purity for the pure data kinematic-based algorithm are omitted because they do not depend on the confusion matrix values. Then we have chosen the threshold of 85% for tracks' purity value since this threshold provides results which are considered as satisfying enough.

Actually, the choice of threshold is a matter of an expert assessment and strongly depends on the particular implementation. It can be seen from the Table 14.2 that the last row from the top with tracks' purity value above the chosen threshold is the row with $CM(0.96; 0.04)$. So that, if our task is to track targets separated at normalized distance approximately $1.5\sigma_{resid}$ to $3\sigma_{resid}$, we have to ensure a classifier with mentioned above confusion matrix. We recall that the value of the tracks' purity ratio for the pure data kinematic-based algorithm for this separation is only 35.47%.

More simulations have been performed by degrading the quality of the classifier/CM for trying to find the values of CM which does not influence the value of tracks' purity ratio, i.e. when the 'attribute' algorithm gives the same results as

Distance $d = 450\ m$		
Confusion Matrix		Track Purity
0.995	0.005	93.24
0.99	0.01	91.51
0.98	0.02	89.53
0.97	0.03	86.83
0.96	0.04	85.26
0.95	0.05	82.48
0.94	0.06	79.41
0.93	0.07	75.38
0.92	0.08	75.25
0.91	0.09	74.27
0.90	0.10	70.69

Table 14.2: Track purity with different CM for a scenario with $d = 450\ m$.

'kinematic' one for the chosen targets separation. The results we have obtained are given in Table 14.3.

Distance $d = 450\ m$		
Confusion Matrix		Track Purity
0.995	0.005	93.24
0.95	0.05	82.48
0.90	0.10	70.69
0.80	0.20	52.04
0.70	0.30	46.90
0.60	0.40	43.01
0.55	0.45	42.20

Table 14.3: Distance = 450 m , PCR5 algorithm.

We can see that even for the values of elements of CM close to the probability mass limit values of (0.5;0.5) the investigated ratio remains slightly better (the last row of table 14.3) than that of 'kinematic' algorithm.

Once the data association is made, the classical IMM Kalman filtering algorithm is used for target state estimation and to reduce position errors. The figures 14.4 and 14.5 show the errors along axes X and Y with and without filtering. It can be seen a significant reduction of the sensor errors after filtering. The figure 14.4 shows the result of the more precise model (model 1), and in the figure 14.2 the result of model 2 with bigger values for errors is presented. The figure 14.6 shows the result for distance errors for the two models. We can verify that we naturally obtain lower

errors when using the most precise model.

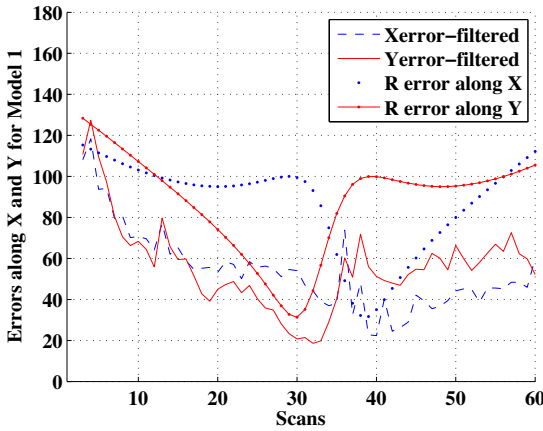

Figure 14.4: Monte Carlo estimation of errors along axes x and y for model 1.

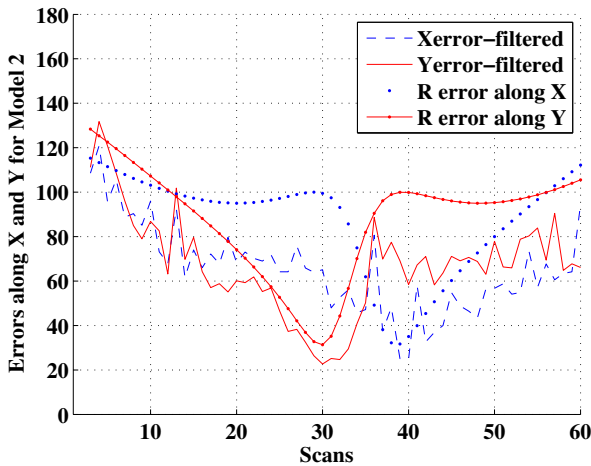

Figure 14.5: Monte Carlo estimation of errors along axes x and y for model 2.

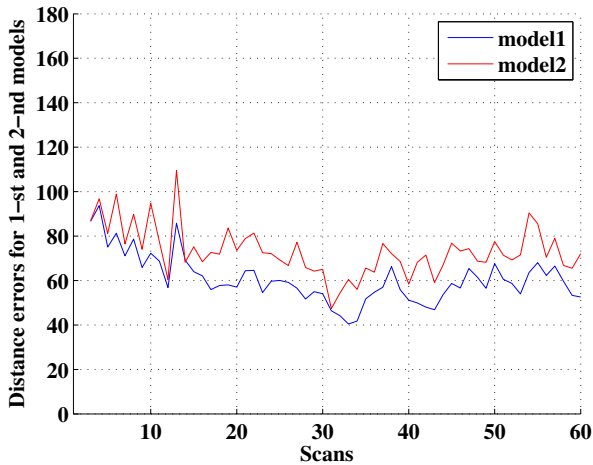

Figure 14.6: Monte Carlo estimation of distance errors for first and second models.

14.4 Conclusions

In this work, we have proposed and evaluated a multiple target tracking algorithm called GDA-MTT dealing with both kinematic and attribute data. GDA-MTT is based on a global nearest neighbour alike approach which uses Munkres algorithm to solve the generalized data association problem. The PCR5 combination rule developed in Dezert-Smarandache Theory has been used for managing efficiently attribute data which allows to improve substantially the tracking performances. Our simulation results show that, even in dense target scenarios and realistic accuracy of attribute data classifier, the GDA-MTT algorithm's performance meets requirements concerning its practical implementation. Our results highlight the advantage of using a tracking algorithm exploiting both kinematic and attribute data over a classical tracking approach based only on kinematic data.

14.5 References

- [1] D. Angelova, B. Vassileva and Tz. Semerdjiev, *Monte Carlo-based Filter for Target Tracking with Feature Measurement*, Proceedings of the Fifth International Conference on Information Fusion, July 8-11, Annapolis, Maryland, U.S.A., pp. 1499–1505, 2002.

- [2] Y. Bar-Shalom (Editor), *Multitarget-Multisensor Tracking: Advanced Applications*, Norwood, Artech House, 1990.
- [3] Y. Bar-Shalom, T. Fortmann, *Tracking and Data Association*, Academic Press, 1988
- [4] Y. Bar-Shalom, X.-R. Li, *Estimation and Tracking: Principles, Techniques and Software*, Artech House, 1993.
- [5] Y. Bar-Shalom, X.-R. Li, *Multitarget-multisensor tracking: Principles and techniques*, YBS Publishing, 1995.
- [6] Y. Bar-Shalom, T. Kirubarajan, C. Gokberk, *Tracking with classification-Aided Multiframe data Association*, Proc. of SPIE Conf. on Signal and Data Processing of Small Targets, Vol. 5204, San Diego, Aug. 2003.
- [7] S. Blackman, *Multitarget tracking with Radar Applications*, Artech House, 1986
- [8] S. Blackman, R. Popoli, *Design and Analysis of Modern Tracking Systems*, Norwood, MA, Artech House, 1999
- [9] F. Bourgeois, J.C. Lassalle, *An Extension of the Munkres Algorithm for the Assignment Problem to Rectangular Matrices*, Communications of the ACM, Vol.14, Dec.1971, pp.802-806.
- [10] J. Dezert, *Foundations for a new theory of plausible and paradoxical reasoning, Information and Security*, An international Journal, edited by Prof. Tzv. Semerdjiev, CLPP, Bulgarian Academy of Sciences, Vol.9, 2002, pp.13-57.
- [11] D. Lerro, Y. Bar-Shalom, *Tracking With Debaised Consistent Converted Measurements Versus EKF*, Trans. On Aerospace and Electronic Systems, vol. 29, No 3, July 1993, pp1015-1022.
- [12] R.L. Popp, K.R. Pattipati, Y. Bar-Shalom, *Dynamically Adaptable m-Best 2-D Assignment Algorithm and Multilevel Parallelization*, IEEE Trans.on Aerospace and Electronic Systems, Vol. 35 No.4, Oct. 1999.
- [13] Tzv. Semerdjiev, Em. Djerassi, L. Bojilov, P. Konstantinova, *Sensor Data Processing for Target Tracking. Algorithms and Applications*, [in Bulgarian] Soft-Trade, 2006.
- [14] F. Smarandache, J. Dezert, (Editors), *Advances and Applications of DSMT for Information Fusion (Collected Works)*, American Research Press, Rehobooth, 2004.
- [15] F. Smarandache, J. Dezert, (Editors), *Advances and Applications of DSMT for Information Fusion (Collected Works)*, vol. 2, American Research Press Rehobooth, 2006.

- [16] G. Watson, W.D. Blair, *Benchmark Problem for Radar Resource Allocation and Tracking Maneuvering Targets in the presence of ECM*, Technical Report NSWCCD/TR-96/10, 1996.

Chapter 15

New fusion rules for solving Blackman's association problem

Albena Tchamova
IPP, Bulgarian Academy of Sciences,
"Acad. G. Bonchev" Str., bl. 25-A,
1113 Sofia, Bulgaria.
tchamova@bas.bg

Jean Dezert
ONERA/DTIM/SIF,
29 Av. Division Leclerc,
92320 Châtillon, France.
jean.dezert@onera.fr

Florentin Smarandache
Chair of Math. & Sciences Dept.,
University of New Mexico,
200 College Road,
Gallup, NM 87301, U.S.A.
smarand@unm.edu

Abstract: *This chapter presents a new approach for solving the paradoxical Blackman's association problem. It utilizes a new class of fusion rules based on fuzzy T-conorm/T-norm operators together with Dezert-Smarandache theory and the relative variations of generalized pignistic probabilities measure of correct associations defined from a partial ordering function of hyper-power set. The ability of this approach to solve the problem against the classical Dempster-Shafer's method, proposed in the literature is proven. It is shown that the approach improves the separation power of the decision process for this association problem.*

15.1 On Blackman's association problem

15.1.0.1 Introduction

Data association with its goal to select the most probable and correct associations between sensors' measurements and target tracks, from a large set of possibilities, is a fundamental and important component for each radar surveillance system. In general, the focus of tracking algorithms has centered on kinematics state estimation. However, targets' attribute information has the potential to not only estimate the identity/type information of the tracking targets, but it may also improve data association and kinematics tracking performance. Attribute data association can become a crucial and challenging problem in case when the sources of information are imprecise, uncertain, even conflicting and paradoxical. The specifics of the data association problem can vary according to both: the different fusion methods and the criteria to estimate the correct associations. There are various methods for combining such information and the choice of method depends on the richness of abstraction and diversity of sensor data. The most used until now Dempster-Shafer Theory (DST) ([2] and [5]) proposes a suitable mathematical framework for representation of uncertainty. Although very appealing, DST presents some weaknesses and limitations, related with the law of the third excluded middle. The Dempster's rule of combination can give rise to some paradoxes/anomalies and can fail to provide the correct solution for some specific association problems. This has been already pointed out by Samuel Blackman in [1], where the famous Blackman Association Problem (BAP) is formulated. In this chapter we focus our attention on the ability of one new, alternative class fusion rule, interpreting the fusion in terms of fuzzy T-Conorm and T-Norm operators (TCN rule), to solve efficiently the paradoxical Blackman's Association Problem on the base of relative variations of generalized pignistics probabilities measure, defined within recently developed Dezert-Smarandache Theory (DSmT) of plausible and paradoxical reasoning ([6] and [7]). It proposes a new general mathematical framework for solving fusion/association problems. This theory overcomes the practical limitations of DST, coming essentially from its inherent constraints, which are closely related with the acceptance of the law of the third excluded middle and can be interpreted as a general and direct extension of probability theory and the DST. We first recall the BAP, then we browse the state-of-the-art to find the correct solution through different approaches available in the literature. After a brief presentation of DSmT, DSmT based Proportional Redistribution Rule number 5 (PCR5), the new TCN combination rule and DSmT based, relative variations of generalized pignistics probabilities measure, we provide a new solution of this problem, which is encountered in modern multisensor multitarget tracking and identification systems involved in defense applications. The last part of the chapter provides a comparison of the performances of all the proposed approaches from Monte-Carlo simulation results.

15.1.1 Blackman's association problem

The main purpose of information fusion/association is to produce reasonably aggregated, refined and/or completed useful pieces of information obtained from a single or multiple sources of information with a consequent adequate reasoning process. It means, that the main problem here consists not only in the way to aggregate correctly the sources of information, which in general are imprecise, uncertain, or/and conflicting, but it is also important to dispose of proper criterion to estimate the correct association. Actually, there is no a single, unique rule to deal simultaneously with such kind of information peculiarities, but a huge number of possible combinational rules, appropriate only for a particular application conditions, as well as a number of criterion to estimate the correct association.

15.1.1.1 Original Blackman's Association Problem

The well known association problem, denoted BAP1, provided by Samuel Blackman considers a very simple frame of discernment according to only two target's attribute types $\Theta = \{\theta_1, \theta_2\}$.

It corresponds to a single attribute observation and two estimated targets tracks T_1 and T_2 associated with two predicted basic belief assignments (bba): $m_{T_1}(\cdot)$ and $m_{T_2}(\cdot)$ respectively:

$$\begin{aligned} m_{T_1}(\cdot) &= \{m_{T_1}(\theta_1) = 0.5; m_{T_1}(\theta_2) = 0.5; m_{T_1}(\theta_1 \cup \theta_2) = 0.0\} \\ m_{T_2}(\cdot) &= \{m_{T_2}(\theta_1) = 0.1; m_{T_2}(\theta_2) = 0.1; m_{T_2}(\theta_1 \cup \theta_2) = 0.8\} \end{aligned}$$

It should be mentioned that both sources of information are independent and share one and the same frame of hypotheses, on which their basic belief assignment are defined. During the next time instant, a single new attribute observation is detected. It is characterized with an associated bba, $m_Z(\cdot)$, described within the same frame of discernments:

$$m_Z(\cdot) = \{m_Z(\theta_1) = 0.5; m_Z(\theta_2) = 0.5; m_Z(\theta_1 \cup \theta_2) = 0.0\}$$

It is evident here, the new observation perfectly fits with the predicted bba of the first track, i.e. $m_Z(\cdot) = m_{T_1}(\cdot)$, whereas $m_Z(\cdot)$ has some disagreement with the predicted bba of the second track $m_{T_2}(\cdot)$. It should lead to a categorical decision about the correct assignment: $m_Z(\cdot) = m_{T_1}(\cdot)$. However, counter-intuitively, the solution, taken on the base of DST is just the opposite one: $m_Z(\cdot) = m_{T_2}(\cdot)$.

15.1.1.2 Second Blackman's association problem.

In order to complete and compare all possible cases, we modify the first association problem into a second one, denoted BAP2, with preserving the same predicted tracks' bbas: $m_{T_1}(\cdot)$ and $m_{T_2}(\cdot)$. In the opposite of the first case, we consider the new attribute measurement to fit with the second track's bba, i.e. $m_Z(\cdot) = m_{T_2}(\cdot)$. Because of perfect fitting, the correct decision here is apparently trivial: $m_Z(\cdot) \Leftrightarrow m_{T_2}(\cdot)$.

15.2 State-of-the-art to find a correct solution

In [6] there are described, examined and discussed several approaches to resolve the BAP. The first group includes approaches based on DST: (i) a minimum conflict criterion; (ii) a relative attribute likelihood function criterion, proposed by Blackman; (iii) minimum distance criterion; (iiii) Shubert's meta-conflict function criterion; (v) entropy-based approaches. The results obtained via Monte Carlo simulations indicate that there is no reliable approach to solve the assignment problem based on DST for both cases described above. The numerical computation of the conflict for BAP1 yields an unexpected, non-adequate, counter-intuitive result. The fusion/association process actually assigns the lower degree of conflict to the incorrect solution: $m_Z(\cdot) \Leftrightarrow m_{T_2}(\cdot)$, providing a larger discrepancy between observation's bba $m_Z(\cdot)$ with the predicted bba $m_{T_1}(\cdot)$, than with the predicted bba $m_{T_2}(\cdot)$, nevertheless $m_Z(\cdot) = m_{T_1}(\cdot)$. Therefore, the search for the minimum conflict between sources cannot be taken as a reliable solution for the general assignment problem since at least one example exists for which the method fails. The meta-conflict approach, proposed by Shubert [4], does not allow getting the optimal efficiency. Blackman's approach gives the same performance. All entropy-based methods are less efficient than the min-conflict approach. The min-distance approach is the least efficient one. According to the combination rule used, it has been already reported in [3, 6], and [4] that the use of DST must usually be done with extreme caution if one has to take a final and important decision from the result of the Dempster's rule of combination. Always there is a need to be added some ad-hoc or heuristic techniques to the association process, in order to manage or reduce the possibility of high degree of conflict between sources. Otherwise, the fusion results lead to non-adequate conclusions, or cannot provide reliable results at all. The second group of approaches rely on the new DSMT of plausible and paradoxical reasoning. Its foundation is to allow imprecise/vague notions and concepts between elements of the frame of discernment. The main approaches to examine and estimate the correct data association within DSMT are based on the generalized pignistic transformation [6]: minimum variation of entropy-like measure, minimum variation of generalized pignistic entropy, minimum of relative variation of pignistic probabilities conditioned by the correct assignment. The results obtained show that the method based on the relative variations of generalized pignistic probabilities conditioned by the correct assignment, yields adequate and proper decisions and outperforms all above approaches examined.

15.3 Basics of Dezert-Smarandache theory

DSMT of plausible and paradoxical reasoning proposes a new general mathematical framework for solving fusion problems and a formalism to describe, analyze and combine all the available information, allowing the possibility for conflicts and paradoxes between the elements of the frame of discernment. DSMT differs from DST because it is based on the free Dedekind lattice. It works for any model (free DSMT model and hybrid models - including Shafer's model as a special case) which fits adequately

with the true nature of the fusion problem under consideration, expressed in terms of belief functions, with static and dynamic fusion problematics. DSMT includes the possibility to deal with evidences arising from different sources of information, which don't have access to absolute interpretation of the elements under consideration and can be interpreted as a general and direct extension of probability theory and the DST.

15.3.1 Free DSMT model

Let $\Theta = \{\theta_1, \theta_2\}$ be a set of elements, which cannot be precisely defined and separated. A free-DSMT model, denoted as $M^f(\Theta)$, consists in assuming that all elements $\theta_i, i=1, \dots, n$ of Θ are not exclusive. The free-DSMT model is an opposite to the Shafer's model $M^o(\Theta)$, which requires the exclusivity and exhaustivity of all elements in Θ .

15.3.2 Hybrid DSMT model

A DSMT hybrid model $\mathcal{M}(\Theta)$ is defined from the free-DSMT model $M^f(\Theta)$ by introducing some integrity constraints on some elements $\theta_i \in D^\Theta$, if there are some certain facts in accordance with the exact nature of the model related to the problem under consideration. An integrity constraint on $\theta_i \in D^\Theta$ consists in forcing θ_i to be empty through the model $\mathcal{M}(\Theta)$, denoted as $\theta_i \equiv \emptyset$. There are several possible kinds of integrity constraints:

- *exclusivity constraints* - when some conjunctions of elements $\theta_i, i=1, \dots, n$ of Θ are truly impossible, i.e. $\theta_i \cap \dots \cap \theta_k \equiv \emptyset$;
- *non-existential constraints* - when some disjunctions of elements $\theta_i, i=1, \dots, n$ of Θ are truly impossible, i.e. $\theta_i \cup \dots \cup \theta_k \equiv \emptyset$;
- *mixture of exclusivity and non-existential constraints* , for example $(\theta_i \cap \theta_j) \cup \theta_k$

The introduction of a given integrity constraint $\theta_i \equiv \emptyset$ implies the set of inner constraints $B \equiv \emptyset$ for all $B \subset \theta_i$. Shafer's model $M^o(\Theta)$ can be considered as the most constrained DSMT hybrid model including all possible exclusivity constraints without non-existential constraint, since all elements in the frame are forced to be mutually exclusive.

15.3.3 Hyper-power set and classical DSMT fusion rule

The hyper-power set D^Θ is defined as the set of all composite possibilities built from Θ with \cup and \cap operators such that:

1. $\emptyset, \theta_1, \dots, \theta_n \in D^\Theta$
2. $\forall A^\Theta, B \in D^\Theta, (A \cup B) \in D^\Theta, (A \cap B) \in D^\Theta$

3. No other elements belong to D^Θ , except those, obtained by the previous rules 1 and 2.

From a general frame of discernment Θ with its free-DSm model, it is defined a mapping $m(\cdot) : D^\Theta \rightarrow [0, 1]$, associated to a given source of evidence, which can support paradoxical, or conflicting information, as follows:

$$m(\emptyset) = 0 \quad \text{and} \quad \sum_{A \in D^\Theta} m(A) = 1$$

The quantity $m(A)$ is called A's general basic belief assignment (gbba) or the general basic belief mass for A. The belief and plausibility functions are defined for $\forall A \in D^\Theta$:

$$\begin{cases} Bel(A) = \sum_{B \in D^\Theta, B \subseteq A} m(B) \\ Pl(A) = \sum_{B \in D^\Theta, B \cap A \neq \emptyset} m(B) \end{cases}$$

The DSm classical rule of combination is based on the free-DSm model. For $k \geq 2$ independent bodies of evidence with gbba's, $m_1(\cdot), m_2(\cdot), \dots, m_k(\cdot)$ over D^Θ becomes:

$$m_{\mathcal{M}^f_\Theta}(A) = \sum_{\substack{X_1, \dots, X_k \in D^\Theta \\ X_1 \cap \dots \cap X_k = A}} \prod_{i=1}^k m_i(X_i) \quad (15.1)$$

with $m_{\mathcal{M}^f_\Theta}(\emptyset) = 0$ by definition. This rule is commutative and associative and requires no normalization procedure.

15.4 Proportional conflict redistribution rule no.5

Instead of distributing equally the total conflicting mass onto elements of power set as within Dempster's rule through the normalization step, or transferring the partial conflicts onto partial uncertainties as within DSm hybrid rule, the idea behind the Proportional Conflict Redistribution rules is to transfer conflicting masses (total or partial) proportionally to non-empty sets involved in the model according to all integrity constraints. The general principle is to :

- calculate the conjunctive rule of the belief masses of sources;
- calculate the total or partial conflicting masses ;
- redistribute the conflicting mass (total or partial) proportionally on non-empty sets involved in the model according to all integrity constraints.

The way the conflicting mass is redistributed yields to several versions of PCR rules [7]. These PCR fusion rules work both in DST and DSmT frameworks and for static or dynamical fusion problematic, for any degree of conflict in $[0, 1]$, for any DSm models (Shafer's model, free DSm model or any hybrid DSm model). The most

sophisticated rule among them is the proportional conflict redistribution rule no. 5 (PCR5). The PCR5 combination rule for only two sources of information is defined by: $m_{PCR5}(\emptyset) = 0$ and for $\forall X \in G^\ominus \setminus \{\emptyset\}$

$$m_{PCR5}(X) = m_{12}(X) + \sum_{\substack{Y \in G^\ominus \setminus \{X\} \\ X \cap Y = \emptyset}} \left[\frac{m_1(X)^2 \cdot m_2(Y)}{m_1(X) + m_2(Y)} + \frac{m_2(X)^2 \cdot m_1(Y)}{m_2(X) + m_1(Y)} \right] \quad (15.2)$$

where G^\ominus is the generalized power set; $m_{12}(X)$ corresponds to the conjunctive consensus on X between the two sources and where all denominators are different from zero. If a denominator is zero, that fraction is discarded. All sets involved in the formula are in canonical form. No matter how big or small is the conflicting mass, PCR5 mathematically does a better redistribution of the conflicting mass than Dempster’s rule and other rules since PCR5 goes backwards on the tracks of the conjunctive rule and redistributes the partial conflicting masses only to the sets involved in the conflict and proportionally to their masses put in the conflict, considering the conjunctive normal form of the partial conflict. PCR5 is quasi-associative and preserves the neutral impact of the vacuous belief assignment. An improvement of PCR5, called PCR6, for the fusion of three sources or more can be found in [7].

15.5 T-conorm/T-norm based combination rules

The TCN rule of combination [8] represents a new class of combination rules based on specified fuzzy T-Conorm/T-Norm operators. This rule takes its source from the T-norm and T-conorm operators in fuzzy logics, where the AND logic operator corresponds in information fusion to the conjunctive rule and the OR logic operator corresponds to the disjunctive rule. In this work we propose to interpret the fusion/association between the sources of information as a vague relation, characterized by the following two characteristics:

- *The way of association between the possible propositions.* It is built on the base of the frame of discernment. It is based on the operations of union and intersection, and their combinations. These sets’ operations correspond to logic operations Conjunction and Disjunction and their combinations.
- *The degree of association between the propositions.* It is obtained as a T-norm (for conjunction) or T-conorm (for disjunction) operators applied over the probability masses of corresponding focal elements. While the logic operators deal with degrees of truth and false, the fusion rules deal with degrees of belief of hypotheses. Within this work, we focus only on the Minimum T-norm based Conjunctive rule. It yields results very close to the conjunctive rule, which is appropriate for identification problems, restricting the set of hypotheses we

are looking for. It has an adequate behavior in cases of total conflict. It is commutative and simply to apply.

The general principle of the TCN rule consists in the following steps:

- *Step 1: Defining the min T-norm conjunctive consensus.* The min T-norm conjunctive consensus is based on the default min T-norm function. The degree of association between particular propositions X, Y of given two sources of information $m_1(\cdot)$ and $m_2(\cdot)$, is defined for $A = X \cap Y$ as $\tilde{m}_{12}(A) = \min\{m_1(X), m_2(Y)\}$, where $\tilde{m}_{12}(A)$ represents the basic belief assignments after the fusion, associated with the given proposition A by using T-norm based conjunctive rule. The TCN combination rule in Dempster Shafer theory framework is defined for $\forall A \in 2^\Theta$ by the equation:

$$m(A) = \sum_{\substack{X, Y \in G^\Theta \\ X \cap Y = A}} \min\{m_1(X), m_2(Y)\} \tag{15.3}$$

- *Step 2: Distribution of the mass, assigned to the conflicts.* To some degree it follows the distribution of conflicting mass in the most sophisticated DS_mT based Proportional Conflict Redistribution rule number 5 (PCR5) proposed in [7], but the procedure here relies on fuzzy operators. The particular partial and total conflicting masses are distributed to all non-empty sets proportionally with respect to the Maximum between the elements of corresponding mass matrix’s columns, associated with the given element of the power set. It means the bigger mass is redistributed towards the element, involved in the conflict and contributing to the conflict with the maximum specified probability mass. If $X \cap Y = \emptyset$, and $m_{12}(X \cap Y) > 0$ then X and Y are involved in a particular partial conflict. One needs to redistribute it to the non-empty sets X and Y with respect to both: $\max\{m_1(X), m_2(Y)\}$ and $\max\{m_1(Y), m_2(X)\}$.
- *Step 3:* The basic belief assignment, obtained as a result of the applied TCN rule becomes:

$$\begin{aligned} \tilde{m}_{12TCN}(A) = & \sum_{\substack{X, Y \in G^\Theta \\ X \cap Y = A}} \min\{m_1(X), m_2(Y)\} + \\ & \sum_{\substack{X \in G^\Theta \\ X \cap A = \emptyset}} (m_1(A) \times \frac{\min\{m_1(A), m_2(X)\}}{\max\{m_1(A), m_2(X)\}} + \\ & m_2(A) \times \frac{\min\{m_2(A), m_1(X)\}}{\max\{m_2(A), m_1(X)\}}) \end{aligned} \tag{15.4}$$

where G^Θ is a DS_m generalized hyper power set, which in case of Shafer’s model becomes reduced to the power set 2^Θ .

- *Step 4: Normalization of the result.* The final step of the TCN fusion rule concerns the normalization procedure:

$$\tilde{m}_{TCN}(A) = \frac{\tilde{m}_{TCN}(A)}{\sum_{A \in G^\theta} \tilde{m}_{TCN}(A)} \tag{15.5}$$

The TCN combinational rule does not belong to the general Weighted Operator Class. The nice features of the new rule could be defined as: very easy to implement, satisfying the impact of neutrality of Vacuous Belief Assignment; commutative, convergent to idempotence, reflecting majority opinion, assuring an adequate data processing and interpretation in case of total conflict. These main features make it appropriate for the needs of temporal data fusion.

15.6 Measure of estimation based on generalized pignistic probabilities

The minimum of relative variation of generalized pignistic probabilities within DSMT, conditioned by the correct assignment $\delta_i(P^*)$ is chosen as a measure of correct data association. It is defined from a partial ordering function of the hyper-power set, which is the base of DSMT. It is proven that this measure outperforms all methods, examined in [6] for correct solving of Blackman's association problem. Our goal is to estimate and compare the performance of the TCN combination rule on the base of the best criterion:

$$\delta_i(P^*) = \frac{|\Delta_i(P^*/Z) - \Delta_i(P^*/\hat{Z} = T_i)|}{\Delta_i(P^*/\hat{Z} = T_i)} \tag{15.6}$$

where

$$\begin{cases} \Delta_i(P^*/Z) = \sum_{j=1}^n \frac{|P_{T_i Z}^*(\theta_j) - P_{T_i}^*(\theta_j)|}{P_{T_i}^*(\theta_j)}, \\ \Delta_i(P^*/\hat{Z} = T_i) = \sum_{j=1}^n \frac{|P_{T_i Z = T_i}^k(\theta_j) - P_{T_i}^*(\theta_j)|}{P_{T_i}^*(\theta_j)}. \end{cases}$$

The term $P^*(.)$ represents a generalized pignistic probability, according to a given proposition; $\Delta_i(P^*)$ defines the relative variations of corresponding pignistic probabilities; $\Delta_i(P^*/\hat{Z} = T_i)$ is obtained as for $\Delta_i(P^*)$ by forcing the new measurement's bba to be equal to the given track's bba, i.e. $m_Z(.) = m_{T_i}(.)$ for pignistic probabilities $P_{T_i Z}^*(\theta_j)$ derivation. In the next section we will test its performance to resolve the BAP on the base of the TCN rule and will compare it with the results, obtained by DST, i.e. $\Delta_i(P^*/\hat{Z} = T_i)$ is obtained by forcing the measurement's attribute mass vector to be the same as the attribute mass vector of the considered target's bba, i.e. $m_Z(.) = m_{T_i}(.)$. The decision for the right association relies on the minimum of $\Delta_i(P^*)$.

15.7 Simulation results

In table 15.1, the performance evaluation of several methods for solving the BAP are shown. We compare the percentage of success in correct BAP resolving by the new TCN combination rule, DSMT based Proportional Conflict Redistribution rule number 5 and Dempster's rule with the corresponding measure of correct association as follows:

- TCN combinational rule and the best criterion based on the relative variations of generalized pignistic probabilities build from DSMT (and the free DSMT model)
- DSMT based Proportional Conflict Redistribution rule number 5 and the criterion based on the relative variations of generalized pignistic probabilities build from DSMT
- Dempster's rule of combination and: (i) Dempster-Shafer theory based Blackman approach; (ii) DST based Min Conflict approach; (iii) DST based Meta conflict approach; (iiii) DST based Min Entropy approach.

The evaluation of methods' performances/efficiency is estimated through Monte-Carlo simulations. They are based on 10.000 independent runs. A basic run consists in generating randomly the two predicted bba: m_{T_1} , m_{T_2} and the new observed bba m_Z according to a random assignment $m_Z(\cdot) \Leftrightarrow m_{T_1}(\cdot)$ or $m_Z(\cdot) \Leftrightarrow m_{T_2}(\cdot)$. Then we evaluate the percentage of right assignments for the given association criterion. The evaluation of the method proposed here for BAP's solving is performed on the base of the association criterion, proven to be the best among the investigated ones in [6]. The results show that all the methods, applied as measures of correct data associations within Dempster-Shafer theory lead to non-adequate and non-reliable decisions. Dempster's rule of combination can give rise to some paradoxes/anomalies and can fail to provide the correct solution for some specific association problems. Monte Carlo simulations show that only methods based on the new TCN combination rule and DSMT based PCR5 rule with the minimum relative variations of generalized pignistic probabilities measure outperform all methods examined in this work.

Rule and Approach for solving BAP	% of success
TCN rule <i>Relative variations of generalized pignistic probabilities build from DSmT (free DSm model)</i>	100
DSmT based PCR5 rule <i>Relative variations of generalized pignistic probabilities build from DSmT (free DSm model)</i>	100
Dempster's rule <i>DST based Blackman approach</i>	70.31
Dempster's rule <i>DST based Min Conflict approach</i>	70.04
Dempster's rule <i>DST based Meta Conflict approach</i>	70.04
Dempster's rule <i>DST based Min Entropy approach</i>	64.50

Table 15.1: Performance Evaluation of Methods for Solving Blackman's Association Problem.

15.8 Conclusions

We focused our attention on the paradoxical Blackman's association problem and propose a new approach to outperform Blackman's solution. The proposed approach utilizes the recently defined new class fusion rule based on fuzzy T-conorm/T-norm operators. It is applied and tested together with a Dezert-Smarandache theory based, relative variations of generalized pignistics probabilities measure of correct association, defined from a partial ordering function of the hyper-power set. The ability of this approach to solve the problem against the classical Dempster-Shafer's method, proposed in the literature, is proven. It is shown that it assures an adequate data processing in case of high conflict between sources of information, when Dempster's rule yields counter-intuitive fusion results and improves the separation power of the decision process for the considered association problem.

15.9 References

- [1] S. Blackman, R. Popoli, *Design and Analysis of Modern Tracking Systems*, Artech House, 1986
- [2] A. Dempster, *Journal of the Royal Statistical Society*, Series B, pp. 205–247, 1968.

- [3] J. Lowrance, T. Garvey, *Evidential reasoning: an implementation for multisensor integration*, Technical Note 307, Artificial Intelligence Center, International, Menlo Park, CA, 1983.
- [4] J. Schubert, *Clustering belief functions based on attracting and conflictiing metalevel evidence*, Proceedings of IPMU conf., Annecy, France, 2002.
- [5] G. Shafer, *A mathematical theory of evidence*, Princeton University Press, 1976.
- [6] F. Smarandache, J. Dezert (Editors), *Applications and Advances of DSMT for Information Fusion*, American Research Press, 2004.
<http://www.gallup.unm.edu/~smarandache/DSMT-book1.pdf>
- [7] F. Smarandache, J. Dezert (Editors), *Applications and Advances of DSMT for Information Fusion, Vol.2*, American Research Press, 2006.
<http://www.gallup.unm.edu/~smarandache/DSMT-book2.pdf>
- [8] A. Tchamova, J. Dezert, F. Smarandache *A new class of fusion rules based on T-Conorm and T-Norm fuzzy operators*, Information & Security, An International Journal, Vol. 20, 2006.

Chapter 16

Target type tracking with DSMP

Jean Dezert
The French Aerospace Lab.,
ONERA/DTIM/SIF,
29 Av. Division Leclerc,
92320 Châtillon, France.
jean.dezert@onera.fr

Florentin Smarandache
Chair of Math. & Sciences Dept.,
Univ. of New Mexico,
200 College Road,
Gallup, NM 87301, U.S.A.
smarand@unm.edu

Albena Tchamova and Pavlina Konstantinova
Institute for Parallel Processing,
Bulgarian Academy of Sciences,
“Acad. G. Bonchev” Str., bl.25-A,
1113 Sofia, Bulgaria.
tchamova@bas.bg, pavlina@bas.bg

Abstract: *In this chapter we analyze the performances of a new probabilistic belief transformation, denoted DSMP, for the sequential estimation of target ID from classifier outputs in the Target Type Tracking problem (TTT). We complicate here a bit the TTT problem by considering three types of targets (Interceptor, Fighter and Cargo) and show through Monte-Carlo simulations the advantages of DSMP over the pignistic transformation which is classically used for decision-making under uncertainty when dealing with belief assignments. Only the Proportional Conflict Redistribution rule and the hybrid fusion rule are considered in this work for their ability to deal consistently with high conflicting sources of evidence with three different belief assignment modelings.*

This work is partially supported by the Bulgarian National Science Fund- grant MI-1506/05.

16.1 Introduction

In order to improve the performances of Generalized Data Association (GDA) in tracking algorithms [12]¹, we investigate here the possibility of using uncertain classifier attribute decisions coupled with a sequential fusion mechanism based either on a Proportional Conflict Redistribution (PCR [12]) fusion rule or on a hybrid (DS_mH [10]) rule. The novelty of this chapter lies (aside the fusion mechanism itself) in the way the decision-making is carried out for tracking the types of targets under observation. In this work we analyze and show the difference of performances obtained for the decision-making support by the classical betting/pignistic probability (BetP) introduced in nineties by Smets [13], and the new probabilistic transformation, denoted DS_mP, developed by Dezert and Smarandache in [5]. We will show that BetP and DS_mP yield to same performances when the optimistic PCR fusion rule is used, but that DS_mP outperforms slightly BetP if the more prudent/cautious DS_mH fusion rule is preferred by the fusion system designer. This chapter extends and improves our previous works on the Target Type Tracking problem (TTT) published in [3] and [12].

In section 16.2 and 16.3, we briefly introduce DS_mT (Dezert-Smarandache Theory) and its two main rules of combination: the PCR rule no. 5 and the DS_m hybrid rule². In section 16.4, we recall the classical pignistic transformation of a belief mass into a subjective probability measure and we also present our new probabilistic transformation DS_mP which provides in general a better Probabilistic Information Content (PIC) than with BetP. In section 16.5, we present the general mechanism for solving the TTT problem and simulations results and comparisons presented and discussed in section 16.6. The section 16.7 concludes this work.

16.2 A short introduction of DS_mT

In Dempster-Shafer Theory (DST) framework [8], one considers a frame of discernment $\Theta = \{\theta_1, \dots, \theta_n\}$ as a finite set of n exclusive and exhaustive elements (*i.e.* Shafer's model denoted $\mathcal{M}^0(\Theta)$). The power set of Θ is the set of all subsets of Θ . The order of a power set of a set of order/cardinality $|\Theta| = n$ is 2^n . The power set of Θ is denoted 2^Θ . For example, if $\Theta = \{\theta_1, \theta_2\}$, then $2^\Theta = \{\emptyset, \theta_1, \theta_2, \theta_1 \cup \theta_2\}$. In Dezert-Smarandache Theory (DS_mT) framework [10, 12], one considers $\Theta = \{\theta_1, \dots, \theta_n\}$ be a finite set of n exhaustive elements only (*i.e.* free DS_m-model denoted $\mathcal{M}^f(\Theta)$). Eventually some integrity constraints can be introduced in this free model depending on the nature of the problem we have to cope with. The hyper-power set of Θ (*i.e.* the free Dedekind's lattice) denoted D^Θ [10] is defined as:

1. $\emptyset, \theta_1, \dots, \theta_n \in D^\Theta$.

¹Chapter 12.

²DS_mH is a natural extension of Dubois and Prade fusion rule [6] for dealing with dynamical frames of discernments.

2. If $A, B \in D^\Theta$, then $A \cap B$ and $A \cup B$ belong to D^Θ .

3. No other elements belong to D^Θ , except those obtained by using rules 1 and 2.

If $|\Theta| = n$, then $|D^\Theta| \leq 2^{2^n - 1}$. Since for any finite set Θ , $|D^\Theta| \geq |2^\Theta|$, we call D^Θ the hyper-power set of Θ . For example, if $\Theta = \{\theta_1, \theta_2\}$, then $D^\Theta = \{\emptyset, \theta_1 \cap \theta_2, \theta_1, \theta_2, \theta_1 \cup \theta_2\}$. The free DSm model $\mathcal{M}^f(\Theta)$ corresponding to D^Θ allows to work with vague concepts which exhibit a continuous and relative intrinsic nature. Such concepts cannot be precisely refined in an absolute interpretation because of the unreachable universal truth. It is clear that Shafer's model $\mathcal{M}^0(\Theta)$ which assumes that all elements of Θ are truly exclusive is a more constrained model than the free-DSm model $\mathcal{M}^f(\Theta)$ and the power set 2^Θ can be obtained from hyper-power set D^Θ by introducing in $\mathcal{M}^f(\Theta)$ all exclusivity constraints between elements of Θ . Between the free-DSm model $\mathcal{M}^f(\Theta)$ and Shafer's model $\mathcal{M}^0(\Theta)$, there exists a wide class of fusion problems represented in term of the DSm hybrid models denoted $\mathcal{M}(\Theta)$ where Θ involves both fuzzy continuous hypothesis and discrete hypothesis. The main differences between DST and DSmT frameworks are (i) the model on which one works with, and (ii) the choice of the combination rule and conditioning rules [10, 12]. In the sequel, we use the generic notation G^Θ for denoting either D^Θ (when working in DSmT with free DSm model) or 2^Θ (when working in DST with Shafer's model).

From any finite discrete frame Θ , we define a generalized basic belief assignment as a mapping $m(\cdot) : G^\Theta \rightarrow [0, 1]$ associated to a given body of evidence \mathcal{B} which satisfies

$$m(\emptyset) = 0 \quad \text{and} \quad \sum_{A \in G^\Theta} m(A) = 1 \tag{16.1}$$

$m(A)$ is the generalized basic belief assignment/mass (bba) of A . The belief and plausibility functions are defined as:

$$\text{Bel}(A) \triangleq \sum_{\substack{B \subseteq A \\ B \in G^\Theta}} m(B) \quad \text{and} \quad \text{Pl}(A) \triangleq \sum_{\substack{B \cap A \neq \emptyset \\ B \in G^\Theta}} m(B) \tag{16.2}$$

These definitions are compatible with the Bel and Pl definitions given in DST when $\mathcal{M}^0(\Theta)$ holds. When the free DSm model $\mathcal{M}^f(\Theta)$ holds, the pure conjunctive consensus, called DSm classic rule (DSmC), is performed on $G^\Theta = D^\Theta$. DSmC of two independent³ sources associated with gbba $m_1(\cdot)$ and $m_2(\cdot)$ is thus given $\forall C \in D^\Theta$ by [10]:

$$m_{DSmC}(C) = \sum_{\substack{A, B \in D^\Theta \\ A \cap B = C}} m_1(A)m_2(B) \tag{16.3}$$

D^Θ being closed under \cup and \cap operators, DSmC guarantees that $m(\cdot)$ is a proper bba.

³While independence is a difficult concept to define in all theories managing epistemic uncertainty, we consider that two sources of evidence are independent (i.e. distinct and noninteracting) if each leaves one totally ignorant about the particular value the other will take.

16.3 DS_mH and PCR5 combination rules

16.3.1 DS_mH combination rule

When $\mathcal{M}^f(\Theta)$ does not hold (some integrity constraints exist), one deals with a proper DS_m hybrid model $\mathcal{M}(\Theta) \neq \mathcal{M}^f(\Theta)$. The DS_m hybrid rule (DS_mH) for $k \geq 2$ independent sources is thus defined for all $A \in D^\Theta$ as [10]:

$$m_{DSmH}(A) \triangleq \phi(A) \cdot [S_1(A) + S_2(A) + S_3(A)] \quad (16.4)$$

where $\phi(A)$ is the characteristic non-emptiness function of a set A , i.e. $\phi(A) = 1$ if $A \notin \emptyset$ and $\phi(A) = 0$ otherwise, where $\emptyset \triangleq \{\emptyset_{\mathcal{M}}, \emptyset\}$. $\emptyset_{\mathcal{M}}$ is the set of all elements of D^Θ which have been forced to be empty through the constraints of the model \mathcal{M} and \emptyset is the classical/universal empty set. $S_1(A) \equiv m_{\mathcal{M}^f(\Theta)}(A)$, $S_2(A)$, $S_3(A)$ are defined by

$$S_1(A) \triangleq \sum_{\substack{X_1, X_2, \dots, X_k \in D^\Theta \\ (X_1 \cap X_2 \cap \dots \cap X_k) = A}} \prod_{i=1}^k m_i(X_i) \quad (16.5)$$

$$S_2(A) \triangleq \sum_{\substack{X_1, X_2, \dots, X_k \in \emptyset \\ [\mathcal{U} = A] \vee [(\mathcal{U} \in \emptyset) \wedge (A = I_t)]}} \prod_{i=1}^k m_i(X_i) \quad (16.6)$$

$$S_3(A) \triangleq \sum_{\substack{X_1, X_2, \dots, X_k \in D^\Theta \\ u(X_1 \cap X_2 \cap \dots \cap X_k) = A \\ (X_1 \cap X_2 \cap \dots \cap X_k) \in \emptyset}} \prod_{i=1}^k m_i(X_i) \quad (16.7)$$

where each element is in the disjunctive normal form (i. e. disjunctions of conjunctions); $\mathcal{U} \triangleq u(X_1) \cup \dots \cup u(X_k)$ where $u(X)$ is the union of all θ_i that compose X , $I_t \triangleq \theta_1 \cup \dots \cup \theta_n$ is the total ignorance. $S_1(A)$ is nothing but the DS_mC rule for k independent sources based on $\mathcal{M}^f(\Theta)$; $S_2(A)$ is the mass of all relatively and absolutely empty sets which is transferred to the total or relative ignorances associated with non existential constraints (if any, like in some dynamic problems); $S_3(A)$ transfers the sum of relatively empty sets directly onto the canonical disjunctive form of non-empty sets. DS_mH generalizes DS_mC and allows to work on Shafer's model. It is definitely not equivalent to Dempster's rule since these rules are different. DS_mH works for any models (free DS_m model, Shafer's model or any hybrid models) when manipulating precise bba and is actually an extension of Dubois and Prade's rule for working with static or dynamic frames as well [10].

16.3.2 PCR5 combination rule

Instead of distributing equally the total conflicting mass onto elements of 2^Θ as within Dempster's rule through the normalization step, or transferring the partial conflicts onto partial uncertainties as within DS_mH rule, the idea behind the Proportional

Conflict Redistribution rules [11, 12] is to transfer conflicting masses (total or partial) proportionally to non-empty sets involved in the model according to all integrity constraints. The general principle of PCR rules is then to :

1. calculate the conjunctive rule of the belief masses of sources ;
2. calculate the total or partial conflicting masses ;
3. redistribute the conflicting mass (total or partial) proportionally on non-empty sets involved in the model according to all integrity constraints.

The way the conflicting mass is redistributed yields actually to several versions of PCR rules. These PCR fusion rules work for any degree of conflict in $[0, 1]$, for any DSMP models (Shafer’s model, free DSMP model or any hybrid DSMP model) and both in DST and DSMT frameworks for static or dynamical fusion problems. We just now present only the most sophisticated proportional conflict redistribution rule no. 5 (PCR5) since this rule that we feel is the most efficient PCR fusion rule proposed so far for sequential fusion problem like in this TTT problem. The PCR5 combination rule for only two sources is defined by: $m_{PCR5}(\emptyset) = 0$ and $\forall X \in G^\Theta \setminus \{\emptyset\}$

$$m_{PCR5}(X) = m_{12}(X) + \sum_{\substack{Y \in G^\Theta \setminus \{X\} \\ X \cap Y = \emptyset}} \left[\frac{m_1(X)^2 m_2(Y)}{m_1(X) + m_2(Y)} + \frac{m_2(X)^2 m_1(Y)}{m_2(X) + m_1(Y)} \right] \quad (16.8)$$

where each element X , and Y , is in the disjunctive normal form. $m_{12}(X)$ corresponds to the conjunctive consensus on X between the two sources. All denominators are different from zero. If a denominator is zero, that fraction is discarded. No matter how big or small is the conflicting mass, PCR5 mathematically does a better redistribution of the conflicting mass than Dempster’s rule and other rules since PCR5 goes backwards on the tracks of the conjunctive rule and redistributes the partial conflicting masses only to the sets involved in the conflict and proportionally to their masses put in the conflict, considering the conjunctive normal form of the partial conflict. PCR5 is quasi-associative and preserves the neutral impact of the vacuous belief assignment.

16.3.3 How to choose between PCR5 and DSMPH

It is important to note that we don’t claim that PCR5 is better than DSMPH, neither the opposite, since they apply differently. All depends actually on the point of view the fusion system designer and the risk he/she is ready to accept. If the fusion system designer is pessimistic (not confident) about the singletons of the frame, then it is safer to use DSMPH and transfer the partial conflicting mass to the corresponding partial ignorance. But if he/she is optimistic (confident) about the singletons of the frame, then he/she can apply PCR5 to transfer the conflicting mass back to the singletons

involved in that conflict for more specificity. In short summary, the main differences between DST and DS_mT are (1) the model on which one works with, and (2) the choice of the combination rule and its possibility to deal with qualitative beliefs as well [12].

16.4 Probabilistic belief transformations

In order to take a decision from a basic belief assignment $m(\cdot)$, a common adopted approach consists in approximating the bba $m(\cdot)$ by a subjective probability measure $P(\cdot)$ through a given probabilistic transformation and then choose the element of the frame which has the highest probability. Several transformations have been proposed in the literature mainly by Smets in the nineties [13, 14], later by Sudano [15–18] and last year by Cuzzolin [1, 2]. In chapter 3, we proposed a new probabilistic transformation, denoted $DSmP(\cdot)$, which outperforms all previous transformations in term of maximum of Probabilistic Information Content (PIC) [15, 16, 18]. In this chapter, we focus our presentation and comparison only on Smets' pignistic transformation, denoted $BetP(\cdot)$ and on our new $DSmP(\cdot)$ since $BetP(\cdot)$ is well known and generally adopted by the community of researchers and engineers working with belief functions. A detailed comparison of all main probabilistic transformations of bba can be found in [5].

16.4.1 Classical and generalized pignistic probabilities

The basic idea of Smets' pignistic transformation [13], denoted $BetP(\cdot)$ consists in transferring the positive mass of belief of each non specific element (also called partial or total ignorance) onto the singletons involved in that element split by the cardinality of the proposition. In Dempster-Shafer framework [8] (when working with normalized basic belief assignments (bba's) and with $m(\emptyset) = 0$), $BetP(\cdot)$ is defined by $BetP(\emptyset) = 0$ and $\forall X \in 2^\Theta \setminus \{\emptyset\}$ by:

$$BetP(X) = \sum_{\substack{Y \in 2^\Theta \\ X \subseteq Y}} \frac{1}{|Y|} m(Y) = m(X) + \sum_{\substack{Y \in 2^\Theta \\ X \subset Y}} \frac{1}{|Y|} m(Y) \quad (16.9)$$

where 2^Θ is the power set of the finite and discrete frame Θ with Shafer's model, i.e. all elements of Θ are assumed truly exclusive. This transformation has been generalized in DS_mT for any model of the frame (free DS_m model, hybrid DS_m model and Shafer's model as well) [10]. It is defined by $BetP(\emptyset) = 0$ and $\forall X \in G^\Theta \setminus \{\emptyset\}$ by

$$BetP(X) = \sum_{Y \in G^\Theta} \frac{\mathcal{C}_{\mathcal{M}}(X \cap Y)}{\mathcal{C}_{\mathcal{M}}(Y)} m(Y) \quad (16.10)$$

where G^Θ corresponds to the hyper-power set including all the integrity constraints of the model (if any); $\mathcal{C}_{\mathcal{M}}(Y)$ denotes the DS_m cardinal of Y , i.e. the number of parts

of Y in the Venn diagram of the model \mathcal{M} of the frame Θ under consideration [10]⁴. The formula (16.10) reduces to (16.9) when G^Θ reduces to classical power set 2^Θ when one adopts Shafer's model.

16.4.2 A new generalized pignistic transformation

In chapter 3 and [5], we have developed a new generalized quantitative pignistic transformation denoted $DSmp(\cdot)$ to avoid confusion with the previous $BetP(\cdot)$ transformation. $DSmp(\cdot)$ has also been extended in [5] to deal with qualitative belief assignments but it is out of the scope of this chapter and this will not be presented here. The new $DSmp(\cdot)$ transformation is straightforward, different from Smets', Sudano's and Cuzzolin's transformations. The two last ones are more refined than Smets' approach but less interesting and efficient in our opinions than $DSmp(\cdot)$ as proved in [5]. The basic idea of our $DSmp(\cdot)$ transformation consists in a new way of proportionalizations of the mass of each partial ignorance such as $A_1 \cup A_2$ or $A_1 \cup (A_2 \cap A_3)$ or $(A_1 \cap A_2) \cup (A_3 \cap A_4)$, etc., and the mass of the total ignorance $A_1 \cup A_2 \cup \dots \cup A_n$, to the elements involved in the ignorances. The main innovation in this new transformation is to take into account both the values of the belief masses and the cardinality of elements in the redistribution process, contrariwise to previous transformations proposed in the literature so far. We first recall what is the Probabilistic Information Content (PIC) of any given discrete probability measure $P(\cdot)$ and then we briefly present the $DSmp(\cdot)$ formula. In the next section, after presenting the Target Type Tracking problem, we will show how $DSmp(\cdot)$ performs with respect to $BetP(\cdot)$ from Monte Carlo simulations based on classifier decisions in a three-targets-type scenario.

16.4.2.1 The probabilistic information content

The probabilistic information content (PIC) is a criterion introduced by John Sudano [16] for depicting the strength of a critical decision by a specific probability distribution. PIC is an essential measure in any threshold-driven automated decision system. A PIC value of one indicates the total knowledge (i.e. minimal entropy) or information to make a correct decision (one hypothesis has a probability value of one and the rest of zero). A PIC value of zero indicates that the knowledge or information to make a correct decision does not exist (all the hypothesis have an equal probability value), i.e. one has the maximal entropy. Mathematically, the PIC of a probability measure $P\{\cdot\}$ associated with a probabilistic source over a discrete frame $\Theta = \{\theta_1, \dots, \theta_n\}$ is defined by:

$$PIC(P) = 1 + \frac{1}{H_{\max}} \cdot \sum_{i=1}^n P\{\theta_i\} \log_2(P\{\theta_i\}) \quad (16.11)$$

⁴Chapter 7.

The PIC is nothing but the dual of the normalized Shannon entropy [9] and thus is actually unit less. $PIC(P)$ takes its values in $[0, 1]$. $PIC(P)$ is maximum, i.e. $PIC_{\max} = 1$ with any deterministic probability and it is minimum, i.e. $PIC_{\min} = 0$, with the uniform probability over the frame Θ . The simple relationships between Shannon's entropy $H(P)$ and $PIC(P)$ are $PIC(P) = 1 - \frac{H(P)}{H_{\max}}$ and $H(P) = H_{\max} \cdot (1 - PIC(P))$ where H_{\max} is the maximum value achievable by Shannon's entropy, i.e. $H_{\max} = -\sum_{i=1}^n \frac{1}{n} \log_2(\frac{1}{n}) = \log_2(n)$.

16.4.2.2 The DS_mP formula

Let's consider a discrete frame Θ with a given model (free DS_m model, hybrid DS_m model or Shafer's model), the DS_mP transformation is defined by $DSmP_{\epsilon}(\emptyset) = 0$ and $\forall X \in G^{\Theta} \setminus \{\emptyset\}$ by

$$DSmP_{\epsilon}(X) = \sum_{Y \in G^{\Theta}} \frac{\sum_{\substack{Z \subseteq X \cap Y \\ \mathcal{C}(Z)=1}} m(Z) + \epsilon \cdot \mathcal{C}(X \cap Y)}{\sum_{\substack{Z \subseteq Y \\ \mathcal{C}(Z)=1}} m(Z) + \epsilon \cdot \mathcal{C}(Y)} m(Y) \tag{16.12}$$

where $\epsilon \geq 0$ is a tuning parameter and G^{Θ} corresponds to the hyper-power set including eventually all the integrity constraints (if any) of the model \mathcal{M} ; $\mathcal{C}(X \cap Y)$ and $\mathcal{C}(Y)$ denote the DS_m cardinals⁵ of the sets $X \cap Y$ and Y respectively.

The parameter ϵ allows to reach the maximum value the Probabilistic Information Content (PIC) of the approximation of $m(\cdot)$ into a subjective probability measure. The smaller ϵ is, the better/bigger PIC value is. In some particular degenerate cases however, the $DSmP_{\epsilon=0}(\cdot)$ values cannot be derived, but the $DSmP_{\epsilon>0}(\cdot)$ values can however always be derived by choosing ϵ as a very small positive number, say $\epsilon = 1/1000$ for example in order to be as close as we want to the maximum of the PIC (see examples in [5]). It is interesting to note also that when $\epsilon = 1$ and when the masses of all elements Z having $\mathcal{C}(Z) = 1$ are zero, the DS_mP formula (16.12) reduces to the formula (16.10), i.e. $DSmP_{\epsilon=1}(\cdot) = BetP(\cdot)$. The passage from a free DS_m model to a Shafer's model involves the passage from a structure to another one, and the cardinals change as well in the DS_mP formula.

16.4.2.3 Advantages of DS_mP

It has been shown in [5] that among all main probabilistic belief transformations proposed so far, only $DSmP(\cdot)$ transformations yields the highest PIC value and its

⁵We have omitted the index of the model \mathcal{M} for notational convenience.

main advantage is that it works for all models (free, hybrid and Shafer's) - while other transformations work for Shafer's model only. In order to apply other transformations we had to first refine the frame Θ (the cases when it is possible!) in order to work with Shafer's model, and then apply their formulas. In the case when it is possible to build a ultimate refined frame, then one can apply the other subjective probabilities on the refined frame. $DSmP_\epsilon(\cdot)$ works on the refined frame as well and gives the same result as it does on the non-refined frame. Thus $DSmP_{\epsilon>0}$ transformation works on any model and so is very general and appealing. $DSmP_\epsilon(\cdot)$ can be seen as a combination of Sudano's $PrBel(\cdot)$ transformation [17] and Smets' $BetP(\cdot)$. The advantages and limitations of Smets [13], ChapterTTTDSMP-Sudano [15–18] and Cuzzolin [1, 2] transformations have been discussed in details in [5].

16.5 The target type tracking problem

The Target Type Tracking Problem can be simply stated as follows [3, 4]:

- Let $k = 1, 2, \dots, k_{max}$ be the time index and consider M possible target types $T_i \in \Theta = \{\theta_1, \dots, \theta_M\}$ in the environment; for example in air target surveillance systems Θ could be $\Theta = \{Interceptor, Fighter, Cargo\}$ and $T_1 \triangleq Interceptor$, $T_2 \triangleq Fighter$, $T_3 \triangleq Cargo$, in ground target surveillance systems Θ could be $\Theta = \{Tank, Truck, Car, Bus\}$ [7], etc.
- at each instant k , a target of true type $T(k) \in \Theta$ (not necessarily the same target) is observed by an attribute-sensor (we assume a perfect target detection probability here).
- the attribute measurement of the sensor (say noisy Radar Cross Section for example) is then processed through a classifier which provides a decision $T_d(k)$ on the type of the observed target at each instant k .
- The sensor is in general not totally reliable and is characterized by a $M \times M$ confusion matrix

$$\mathbf{C} = [c_{ij} = P(T_d = T_j | TrueTargetType = T_i)]$$

We had proposed and analyzed in [3, 4] a method for solving the Target Type Tracking Problem which was based on Shafer's model for the frame of Target Types Θ and the sequential/temporal combination of basic belief assignments (measurements) with prior belief mass available at previous step/scan to update at each current step the belief in each target type. So we gave a solution to estimate $T(k)$ from the sequence of declarations done by the unreliable classifier up to time k , i.e. we built an estimator $\hat{T}(k) = f(T_d(1), T_d(2), \dots, T_d(k))$ of $T(k)$. The decision about the target type was then taken from Smets' $BetP(\cdot)$ transformations of the updated belief assignment/mass. We had shown the efficiency of PCR5 fusion rule with respect to its main alternatives to track efficiently the true target type of the target under

observation at each scan. Our Target Type Tracker consisted in the sequential combination of the current basic belief assignment (drawn from classifier decision, i.e. our measurements) with the prior bba estimated up to the current time from all past classifier declarations and can be sketched by the following steps:

- a) Initialization step (i.e. $k = 0$). Select the target type frame $\Theta = \{\theta_1, \dots, \theta_M\}$ and set the prior bba $m^-(\cdot)$ as vacuous belief assignment, i.e. $m^-(\theta_1 \cup \dots \cup \theta_M) = 1$ since one has no information about the first target type that will be observed.
- b) Generation of current observation: We investigate in this chapter three possible modelings for building $m_{obs}(\cdot)$ from the current decision $T_d(k)$ and the confusion matrix. Let's assume that $T_d(k) = T_j$, $j \in \{1, 2, \dots, M\}$ and let's denote by S_j the sum of the j -th column of the confusion matrix \mathbf{C} , i.e. $S_j = \sum_{i=1, M} c_{ij}$.
 - Modeling #1 (probabilistic bba modeling) : For $i = 1, \dots, M$, one takes $m_{obs}(\theta_i) = c_{ij}/S_j$.
 - Modeling #2: We commit a belief only to θ_j and to the 2D partial ignorances which include θ_j , i.e. one takes $m_{obs}(\theta_i \cup \theta_j) = c_{ij}/S_j$.
 - Modeling #3: We commit a belief only to θ_j and the full ignorance, i.e. one takes $m_{obs}(\theta_j) = c_{jj}/S_j$ and $m_{obs}(\theta_1 \cup \dots \cup \theta_M) = 1 - c_{jj}/S_j$.
- c) Combination of current bba $m_{obs}(\cdot)$ with prior bba $m^-(\cdot)$ to get the estimation of the current bba $m(\cdot)$. Symbolically we will write the generic fusion operator as \oplus , so that $m(\cdot) = [m_{obs} \oplus m^-](\cdot) = [m^- \oplus m_{obs}](\cdot)$. The combination \oplus is done according either with DSMP fusion rule (i.e. $m(\cdot) = m_{DSMP}(\cdot)$) or with PCR5 rule (i.e. $m(\cdot) = m_{PCR5}(\cdot)$) to show what happens in simulation if one adopts a pessimistic or an optimistic point of view of the fusion process.
- d) Estimation of True Target Type is obtained from $m(\cdot)$ by taking the singleton of Θ , i.e. a Target Type, having the maximum of $BetP(\cdot)$ or the maximum of $DSMP(\cdot)$.
- e) set $m^-(\cdot) = m(\cdot)$; do $k = k + 1$ and go back to b).

In this chapter, we follow the same target type tracking approach as in [3, 4] but we complicate a bit the scenario and we want to see how the new proposed $DSMP(\cdot)$ transformation performs with respect to $BetP(\cdot)$ with the different bba modelings for observations. For doing this we examine the PCR5 and DSMP fusion rules for the sequential update of belief mass of target types. The two fusion rules correspond actually to the confidence the fusion system designer has in the singletons of the frame. If the fusion system designer is not confident in the singletons, then he/she would prefer to use DSMP, otherwise he/she would prefer to use PCR5.

16.6 Simulations results

In order to analyze, evaluate and to compare fairly the performances of both probabilistic belief transformations (BetP(.) and the new DSMP(.) one), for the sequential (temporal) estimation of target ID in the Target Type Tracking problem considered here, we did a set of Monte-Carlo simulations, based on an assumed scenario for a 3D Target Type frame, i.e.

$$\Theta = \{(I)nterceptor, (F)ighter, (C)argo\}$$

for a given classifier, corresponding to the following confusion matrix:

$$\mathbf{C} = \begin{bmatrix} 0.7 & 0.2 & 0.1 \\ 0.15 & 0.7 & 0.15 \\ 0.1 & 0.2 & 0.7 \end{bmatrix}$$

The confusion matrix is asymmetric, reflecting the degree of mutual discrimination between the considered target types. In our scenario we consider that there are three closely-spaced targets: one interceptor, one fighter and one cargo. Due to circumstances, attribute measurements received come from one or another target, and all three targets generate actually one single (unresolved kinematically) track.

In the real world, the tracking system should in this case maintain three separate tracks: one for interceptor, one for fighter and one for cargo, and then, based on the classification, allocate the measurement to the proper track. But in a difficult scenario like this one, there is no way in advance to know the true number of targets because they are unresolved and that's why only a single track is maintained. Of course, the single track can further be split into three separate tracks as soon as three different targets are declared based on the attribute tracking. This is not the purpose of our work however since we only want to examine how the new probabilistic belief transformation works, and to compare its performance with the well known BetP transformation for Target Type Tracking.

To simulate such scenario, a true Target Type sequence over 200 scans was generated according to figure 16.1. The target type sequence (Groundtruth) is characterized with variable switches' time steps, starting with the observation of a Cargo Type (called Type 3) during the first 20 scans. Then the observation of the Target Type switches four times: onto Fighter Type (called Type 2) during time duration of 25 scans; again onto Cargo Type during the next 25 scans; onto Interceptor Type (called Type 1) during the next 15 scans and finally, again to Cargo Type during the last 115 scans. As a simple analogy, tracking the target type changes committed to the same (hidden unresolved) track can be interpreted as tracking color changes of a chameleon moving in a tree on its leaves and on its trunk.

Our simulation consists in 500 Monte-Carlo runs and we compute, show and analyze in the sequel the averaged performances of the two probabilistic belief transformations, applied over the results of sequential fusion, performed via PCR5 and

DSmH combinational rules. At each time step k the decision $T_d(k)$ is randomly generated according to the corresponding row of the confusion matrix of the classifier given the true Target Type (known in simulations). Then the algorithm presented in the previous section is applied.

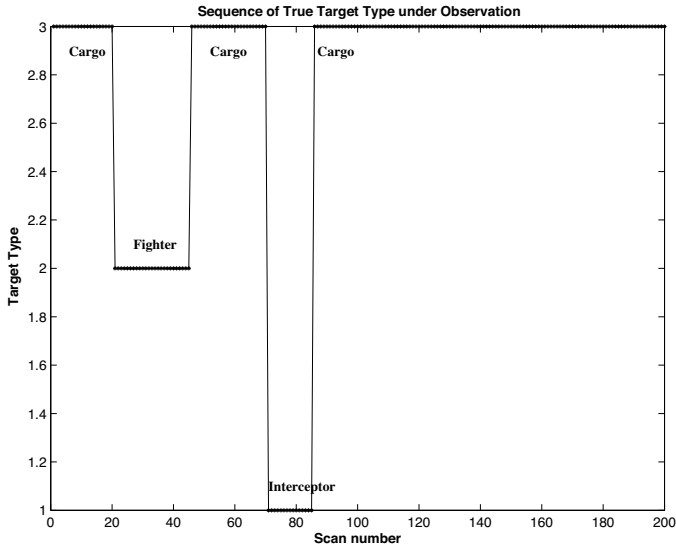
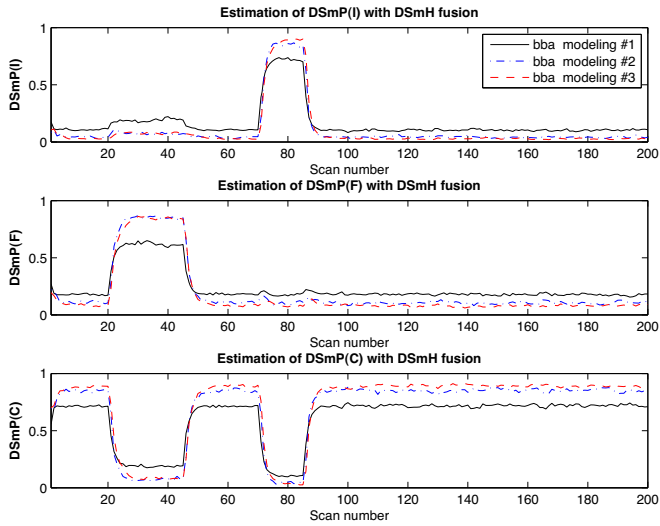
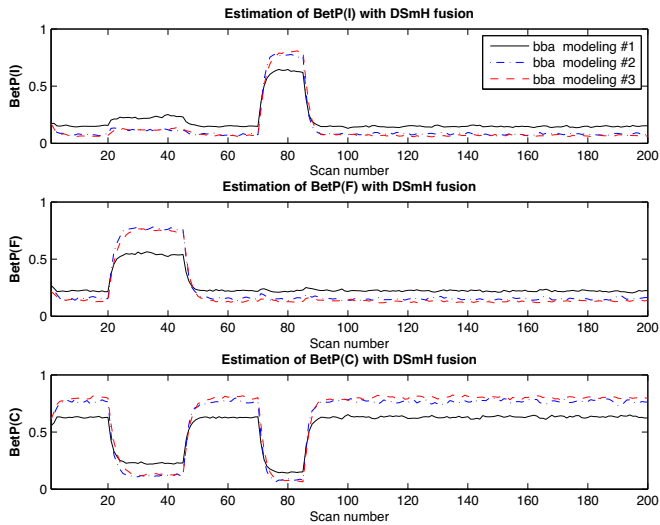

Figure 16.1: Sequence of True Target Type (Groundtruth).

16.6.1 Results based on DSmH fusion

The lack of confidence about the singletons of the frame justifies the application of DSmH combination rule and we test the three modelings for the measurement's basic belief assignment as proposed in step b) of the TTT algorithm described in the section 16.5. Figures 16.2 and 16.3 show the performances of DSMP and BetP probabilistic belief transformations obtained by our Target Type Tracker based on DSmH fusion rule for the three measurement's bba modelings. We have set the tuning parameter $\epsilon = 0.0001$ when applying the DSMP transformation. From these figures, one clearly sees the advantage of DSMP transformation with respect to BetP transformation since the level of probability of the true target type under observation is clearly bigger with DSMP than with BetP. DSMP shows a faster reaction to the target type changes than BetP, shortening that way the time for correct decision-making in comparison to BetP. It is also interesting to note that modelings 2 and 3 provide significantly higher PIC than with modeling 1. This is because modelings 2 and 3 are less strict than modeling 1 and thus offer a better ability to readapt after Target ID switches.

Figure 16.2: $DSmP(\cdot)$ results after using DS mH rule of combination.Figure 16.3: $BetP(\cdot)$ results after using DS mH rule of combination.

16.6.2 Results based on PCR5 fusion

The possible confidence of the fusion system designer about the singletons of the frame justifies the application of PCR5 combination rule of our TTT algorithm. Figures 16.4 and 16.5, show the performances of DS_mP and BetP probabilistic belief transformations obtained by our Target TypeTracker based on PCR5 fusion rule, according to Interceptor, Fighter and Cargo types respectively and for the three measurements' bba modelings considered in this work. Here again $\epsilon = 0.0001$ when applying $DSmP(.)$ transformation.

It had been proven in [3, 4] that the TTT based on PCR5 fusion rule tracks properly the quick changes of target type, with a very short latency delay in order to produce the correct target type decision. Since PCR5 reacts faster to the target target changes, then the mass of ignorance quickly decreases because of the strict redistribution of conflicting mass (total or partial) proportionally on non-empty sets involved in the considered model. In parallel, the mass to be transferred to singletons decreases very fast. Because of this, the behavior of both probabilistic belief transformations (DS_mP and BetP) converge very quickly. When the mass assigned to the ignorance becomes zero, DS_mP and BetP coincide. Here again we see the advantage of using bba modeling 2 and 3 with respect to bba modeling 1, even though the difference between performances is less important than when using DS_mH fusion rule.

16.6.3 Results based on Dempster-Shafer rule

We provide in figures 16.6 and 16.7 the results obtained when applying Dempster-Shafer rule for this scenario with same inputs and bba modelings 1, 2 or 3. We clearly see that this rule under same conditions cannot track correctly the types of targets under observation whichever probabilistic transformation $DSmP(.)$ or $BetP(.)$ is chosen for decision-making.

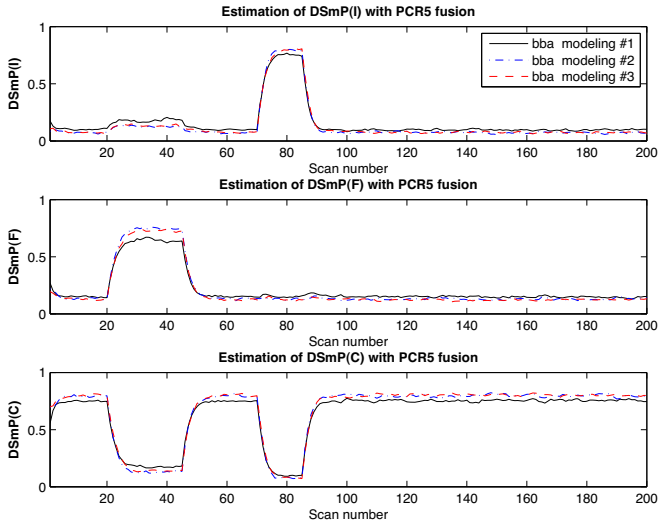

Figure 16.4: $DSmP(\cdot)$ results after using PCR5 rule of combination

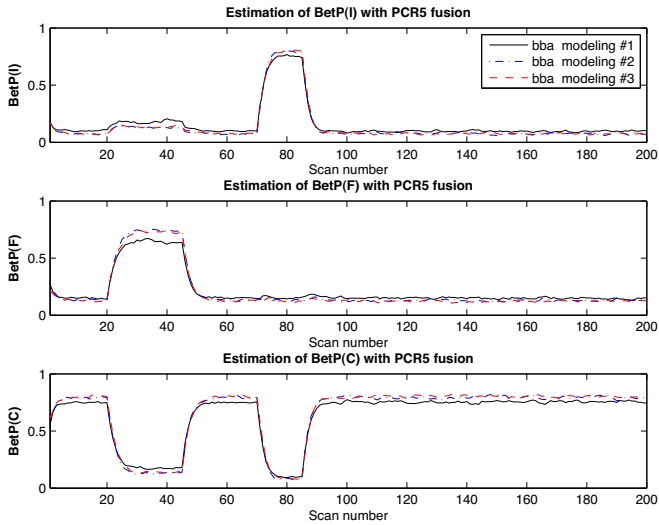

Figure 16.5: $BetP(\cdot)$ results after using PCR5 rule of combination.

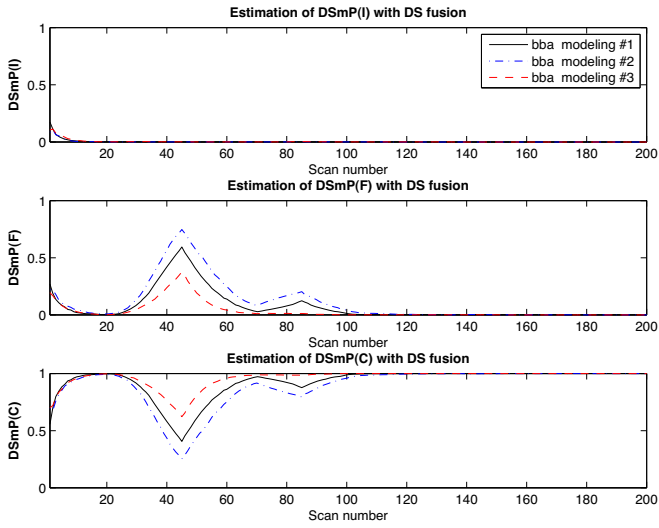

Figure 16.6: $DSmP(.)$ results after using DS rule of combination.

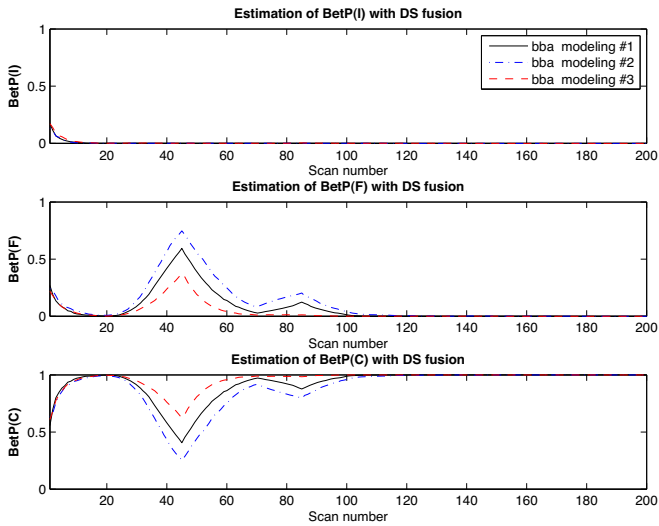

Figure 16.7: $BetP(.)$ results after using DS rule of combination.

16.7 Conclusions

This chapter concerned the application of a new probabilistic belief transformation, denoted DSMP, for solving the Target Type Tracking problem (TTT). We have considered three types of targets (Interceptor, Fighter and Cargo) in our scenario and have shown how the types of each target can be efficiently estimated from the sequential outputs/decisions of a classifier and its confusion matrix when using different belief mass modelings with DSMT fusion rules couples with DSMP. The advantages of DSMP over the classical pignistic transformation have been shown through Monte-Carlo simulations. Based on our previous works for the justification of rules of combination for the TTT problem, only the Proportional Conflict Redistribution rule no. 5 and the DSMP hybrid fusion rules were considered in this work for their ability to deal consistently with high conflicting sources of evidence in an optimistic or a pessimistic/cautious way. From our analysis one can clearly conclude on the advantage of the new DSMP transformation with respect to BetP whenever the cautious DSMP fusion rule is used. When PCR5 fusion rule is preferred, DSMP and BetP provide very quickly almost the same performances because PCR5 reduces efficiently and quickly the masses committed to ignorances (partial or total) and in such case, DSMP and BetP mathematically coincide. We can claim that DSMP provides a stable and faster reacting behavior than BetP and reduces the delay for correct decision-making in comparison with BetP. Our simulation results show also the advantage of using uncertain bba modelings of type 2 and/or 3 over the probabilistic bba modeling 1 in term of higher level of probability of correct ID estimation.

16.8 References

- [1] F. Cuzzolin, *On the properties of the Intersection probability*, submitted to the Annals of Mathematics and AI, Feb. 2007, <http://perception.inrialpes.fr/people/Cuzzolin/pubs.html>.
- [2] F. Cuzzolin, *On the properties of the intersection probability*, submitted to the Int. Conf. on Uncertainty in AI, Vancouver, Canada, July 2007, <http://perception.inrialpes.fr/people/Cuzzolin/pubs.html>.
- [3] J. Dezert, A. Tchamova, F. Smarandache, P. Konstantinova, *Target Type Tracking with PCR5 and Dempster's rules: A Comparative Analysis*, Proc. of Fusion 2006, Florence, Italy, July 2006.
- [4] J. Dezert, A. Tchamova, F. Smarandache, P. Konstantinova, *Target Type Tracking with different fusion rules: A Comparative Analysis*, Chapter 13 of [12].
- [5] J. Dezert, F. Smarandache, *A new probabilistic transformation of belief mass assignment*, in Proc. of Fusion 2008, Cologne, Germany, July 2008.
- [6] D. Dubois, H. Prade, *Representation and combination of uncertainty with belief functions and possibility measures*, Comp. Intelligence, Vol. 4, pp. 244-264, 1988.

- [7] B. Pannetier, J. Dezert and E. Pollard, *Improvement of Multiple Ground Targets Tracking with GMTI Sensor and Fusion of Identification Attributes*, in Proc. of Aeroconf 2008, Big Sky, MT, U.S.A., March 1-9, 2008.
- [8] G. Shafer, *A mathematical theory of evidence*, Princeton University Press, 1976.
- [9] C.E. Shannon, *A Mathematical Theory of Communication*, Bell Syst. Tech. J., 27, pp. 379-423 and 623-656, 1948.
- [10] F. Smarandache and J. Dezert (Editors), *Applications and Advances of DS_mT for Information Fusion*, American Research Press, 2004. <http://www.gallup.unm.edu/~smarandache/DSmT-book1.pdf>.
- [11] F. Smarandache, J. Dezert, *Information Fusion Based on New Proportional Conflict Redistribution Rules*, in Proc. of Fusion 2005, Philadelphia, July 2005.
- [12] F. Smarandache and J. Dezert (Editors), *Applications and Advances of DS_mT for Information Fusion, Vol.2*, American Research Press, 2006. <http://www.gallup.unm.edu/~smarandache/DSmT-book2.pdf>.
- [13] Ph. Smets, *Constructing the pignistic probability function in a context of uncertainty*, Uncertainty in AI, vol. 5, pp. 29-39, 1990.
- [14] Ph. Smets, *The Combination of Evidence in the Transferable Belief Model*, IEEE Trans. on PAMI, vol. 12, no. 5, pp. 447-458, 1990.
- [15] J. Sudano, *Pignistic Probability Transforms for Mixes of Low- and High-Probability Events*, in Proc. of Fusion 2001, Montreal, August 2001.
- [16] J. Sudano, *The system probability information content (PIC) relationship to contributing components, combining independent multi-source beliefs, hybrid and pedigree pignistic probabilities*, in Proc. of Fusion 2002, Annapolis, July 2002.
- [17] J. Sudano, *Equivalence Between Belief Theories and Naive Bayesian Fusion for Systems with Independent Evidential Data - Part I, The Theory*, in Proc. of Fusion 2003, Cairns, July 2003.
- [18] J. Sudano, *Yet Another Paradigm Illustrating Evidence Fusion (YAPIEF)*, in Proc. of Fusion 2006, Florence, July 2006.

Chapter 17

Framework for biometric match score fusion using statistical and belief models

Mayank Vatsa, Richa Singh and Afzel Noore
Lane Department of Computer Science and Electrical Engineering,
West Virginia University, U.S.A.
{mayankv, richas, noore}@csee.wvu.edu

Abstract: *This chapter presents a framework for multi-biometric match score fusion when non-ideal conditions cause conflict in the results of different unimodal biometrics classifiers. The proposed framework uses belief function theory to effectively fuse the match scores and density estimation technique to compute the belief assignments. Fusion is performed using belief models such as Transferable Belief Model and Proportional Conflict Redistribution rule followed by the likelihood ratio based decision making. Two case studies on multiclassifier face verification and multiclassifier fingerprint verification show that the proposed fusion framework with PCR5 rule yields the best verification accuracy even when individual biometric classifiers provide conflicting match scores.*

17.1 Introduction

The performance of the biometric recognition algorithms depends on several factors such as biometric modality, application environment, and database. For example, the performance of fingerprint recognition algorithms depend on the quality of fingerprint to be recognized, the resolution and the type of the fingerprint sensor, and the number of features present in the image. The face recognition algorithms require good quality images with representative training database. Signature biometrics depend on the type of pen and mode of capture. Variation in any of these factors often lead to poor verification performance. To overcome this problem, researchers have proposed the use of multi-biometrics for recognition. Multi-biometrics combines two or more biometric modalities and it has been established that fusion of multiple biometric evidences enhances the recognition performance [12, 19]. Biometric fusion can be performed at data level, at feature level, at match score level, at decision level, or at rank level. Data level fusion combines raw biometric data such as infrared and visible face images. Feature level fusion combines multiple features extracted from the individual biometric data to generate a new feature vector which is subsequently used for recognition. In match score fusion, the features extracted from individual biometric are first matched to compute the corresponding match scores which are then combined to generate a fused match score. In decision level fusion, decisions of individual biometric classifiers are fused to compute a combined decision. Rank level fusion involves combining identification ranks obtained from multiple unimodal identification systems. Further, multi-biometrics can be a multiclassifier system, a multi-unit system, or a multimodal system. In multiclassifier systems, different classifiers are used to extract different types of features to perform matching and fusion. For example, in face biometrics, global and local facial features can be extracted using different classifiers/algorithms and then information can be fused. In multi-unit system, multiple samples of the same biometrics are used for feature extraction and fusion. For example, texture features can be extracted for both left and right iris images and then information from these images are combined. In multimodal system, information from two or more modalities are combined, e.g. face-fingerprint bimodal system.

In this research, we focus on match score fusion to enhance the performance of biometric systems. Existing biometric match score fusion algorithms can be divided into three categories: statistical fusion algorithms, learning based fusion algorithms, and belief function theory based fusion algorithms. Statistical fusion algorithms are based on statistical rules such as AND rule, OR rule, and SUM rule [15]. Learning based fusion algorithms use learning techniques such as support vector machine and neural network to train the fusion algorithm and then use the trained model to decide whether an individual is genuine or an impostor [2]. Belief function theory based fusion algorithms [18, 21] use the match scores to compute the belief assignments and then combine them. Existing evidence based fusion algorithms use Dempster Shafer (DS) theory [16, 33] and Dezert Smarandache (DSm) theory [5, 6] in which match scores are considered as evidence over a frame of discernment.

A major problem with statistical and learning based multi-biometric fusion algorithms occurs when different biometric classifiers generate highly conflicting results for the same individual. Specifically, if one classifier strongly supports one hypothesis and the other classifier strongly rejects the same hypothesis. For example, in a face and fingerprint based bimodal biometric system, variance in image capture, image quality, lighting conditions, facial expressions, and sensor noise could generate a face match score of 0.8 (perfect accept is 1) and a fingerprint match score of 0.2 (perfect reject is 0). Existing fusion algorithms may not be able to handle such conflicting information and degrade the performance drastically. Further, belief function theory based fusion algorithms are computationally expensive. To address these issues and improve the verification performance of a biometric system, we propose a framework for multi-biometric fusion which combines the belief function theory with statistical methods. Further, density estimation technique is used for computing the belief models such as DS theory, Transferable Belief Model (TBM) [23, 25], DS_m fusion, and Proportional Conflict Redistribution (PCR) rule [6] for information fusion, and likelihood ratio for decision making.

Section 17.2 briefly presents the fundamental concepts and notations involved in the belief function theory based fusion algorithms. Section 17.3 describes the proposed biometric match score fusion framework and Section 17.4 describes the algorithms and databases used for evaluation. Sections 17.5 discuss the experimental results of the proposed fusion framework. Section 17.6 briefly presents the concept of a biometric unification framework.

17.2 Overview of belief function theory based fusion algorithms

Belief function theory or the theory of evidence is a theoretical framework for reasoning with imperfect data. It is a generalization of probability theory and includes many approaches of reasoning under uncertainty. Examples of such approaches are Dempster Shafer theory, Transferable Belief Model, Dezert Smarandache fusion, and Proportional Conflict Redistribution rule. In this section, only the main concepts and notations of DS theory, TBM, DS_m fusion, and PCR rule are presented for a two class - two classifier problem. A detailed explanation of belief function theory can be found in [16, 31].

Let $m \in [0, 1]$ be a mapping function and $\Theta = \{\theta_1, \theta_2\}$ be the frame of discernment that represents the finite set of exhaustive and mutually exclusive hypothesis. Probability theory, as mentioned before, is the basis of belief function theory. Belief function, also known as the basic probability assignment, (*bpa*) is defined as $m(\cdot) : \Theta \rightarrow [0, 1]$, such that $m(\theta_1) + m(\theta_2) = 1$. Here, $m(\theta_1)$ represents the belief of data belonging to class θ_1 and $m(\theta_2)$ represents the belief of data belonging to θ_2 .

In the probabilistic framework, basic fusion rule is sum rule as defined in Equations (17.1) and (17.2) (for two information sources).

$$m_{fused}(\theta_1) = \frac{m_1(\theta_1) + m_2(\theta_1)}{2} \quad (17.1)$$

$$m_{fused}(\theta_2) = \frac{m_1(\theta_2) + m_2(\theta_2)}{2} \quad (17.2)$$

The basic sum rule fusion, though effective for simple non-conflicting cases, is not very effective for imprecise, uncertain, and conflicting cases. To address the limitations of the sum rule, approximate reasoning approach based fusion rules including DS theory, TBM and DS_m fusion have been proposed. In DS theory, belief functions have been computed on the power set of Θ (i.e. 2^Θ) and Dempster's rule of combination [16, 33] for fusing two information sources, X and Y , is defined as,

$$m_{DS}(A) = \frac{\sum_{(X, Y \in 2^\Theta), (X \cap Y = A)} m(X)m(Y)}{1 - \sum_{(X, Y \in 2^\Theta), (X \cap Y = \emptyset)} m(X)m(Y)} \quad (17.3)$$

Although DS theory based fusion has been efficiently used for many practical applications, it has some limitations. As presented by Zadeh [34], Dubois and Prade [7], Voorbraak [31], and Dezert and Smarandache [6], DS theory is not reliable when conflict between the sources is very large. To circumvent the limitations of DS fusion algorithm, researchers have proposed several other models. Smets proposed the transferable belief model [23] that quantitatively represents the epistemic uncertainty. According to Smets, the TBM conjunctive combination rule for fusing two information sources, X and Y , can be represented as,

$$m_{TBM}(A) = \sum_{X, Y \in 2^\Theta} m(X)m(Y) \quad (17.4)$$

Recently, Dezert and Smarandache proposed a fusion algorithm using plausible and paradoxical reasoning [6] that addresses the limitations of DS theory and includes Bayes theory and DS theory as special cases. It operates on the hyper-power set defined as $D^\Theta = \{\emptyset, \theta_1, \theta_2, \theta_1 \cup \theta_2, \theta_1 \cap \theta_2\}$. This algorithm uses generalized basic belief assignment (gbbba) on Θ which is defined as $m(\cdot) : D^\Theta \rightarrow [0, 1]$ such that

$$\begin{aligned} m(\emptyset) &= 0 \\ m(\theta_1) + m(\theta_2) + m(\theta_1 \cup \theta_2) + m(\theta_1 \cap \theta_2) &= 1 \end{aligned} \quad (17.5)$$

For fusing two information sources, X and Y , the DS_m rule of combination [5] is defined as,

$$m_{\mathcal{M}(\Theta)}(A) = \psi(A) [S_1(A) + S_2(A) + S_3(A)] \quad (17.6)$$

where, $\mathcal{M}(\Theta)$ is the model over which DS_m theory operates and $\psi(A)$ is the characteristic non-emptiness function of A which is 1 if $A \notin \emptyset$ and 0 otherwise. $S_1(A)$, $S_2(A)$, and $S_3(A)$ are defined as,

$$\begin{aligned}
 S_1(A) &= \sum_{(X, Y \in D^\ominus, X \cap Y = A)} m_1(X) m_2(Y) \\
 S_2(A) &= \sum_{(X, Y \in \Phi, [v=A] \vee [(v \in \Phi) \wedge (A=I_t)])} m_1(X) m_2(Y) \\
 S_3(A) &= \sum_{(X, Y \in D^\ominus, X \cup Y = A, X \cap Y \in \Phi)} m_1(X) m_2(Y)
 \end{aligned} \tag{17.7}$$

where I_t is the total ignorance and is the union of all θ_i ($i = 1, 2$), i.e. $I_t = \theta_1 \cup \theta_2$. $\Phi = \{\Phi, \phi\}$ is the set of all elements of D^\ominus which are empty under the constraints of some specific problem and ϕ is the empty set. $v = u(X) \cup u(Y)$, where $u(X)$ is the union of all singletons θ_i that compose X and Y . Here, $S_1(A)$ corresponds to the classical DSm rule on the free DSm model [5], $S_2(A)$ represents the mass of all relatively and absolutely empty sets which is transferred to the total or relative ignorance, and $S_3(A)$ transfers the sum of relative empty sets to the non-empty sets.

In the DSm fusion algorithm, the partial conflicts are redistributed onto corresponding partial ignorance [5]. However, in some cases this redistribution may yield very non-specific generalized basic belief assignments and thus decrease the performance. Further analysis by Smets [25] suggests that the term S_2 in Equation (17.7) is a “potential source of difficulties” and “seems to be language dependent”. To address this issue, Dezert and Smarandache proposed a set of proportional conflict redistribution rules [6] which consists of five different versions of the PCR rule; PCR1 to PCR5 in order of increasing complexity and correctness. They have reported that among the five rules, PCR5 is the most efficient and precise for information fusion under uncertainty and conflict. In PCR5, redistribution of the partial conflicts is performed only to the elements which are truly involved in each partial conflict and moreover this is done according to the proportion or weight of each source. For a two class - two classifier problem and $\forall X \in D^\ominus \setminus \{\emptyset\}$, the PCR5 rule [6] is defined as

$$\begin{aligned}
 m_{PCR5}(X) &= m_{12}(X) \\
 &+ \sum_{Y \in D^\ominus \setminus \{X\}, X \cap Y = \emptyset} \left[\frac{m_1(X)^2 m_2(Y)}{m_1(X) + m_2(Y)} + \frac{m_2(X)^2 m_1(Y)}{m_2(X) + m_1(Y)} \right]
 \end{aligned} \tag{17.8}$$

In this equation, m_1 and m_2 represent the corresponding belief assignments to the two classifiers; $m_{12}(X)$ corresponds to the conjunctive consensus on X between the two sources and where all denominators are different from zero. If a denominator is zero, that fraction is discarded. All sets involved in the formula are in canonical form.

The PCR5 fusion rule precisely combines and redistributes the information even with conflicting gbba’s. A detailed explanation of the PCR rules can be found in [6].

17.3 Framework for biometric match score fusion

In biometrics, DS theory has been used for match score and decision fusion [4, 18]. However, as mentioned in Section 17.2, DS theory has some limitations and it cannot always provide good results with imprecise, imperfect or uncertain data. In our

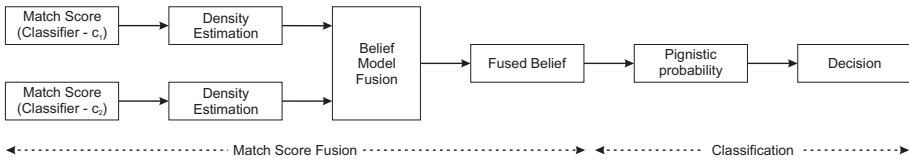

Figure 17.1: Proposed match score fusion framework.

previous research, we proposed the use of DS_m theory for biometrics match score fusion [21, 28]. In our experiments, we found that there are few cases when DS_m theory is not able to yield correct results and sometimes the decisions are not accurate. As discussed in Section 17.2, sometimes DS_m fusion generates non-specific belief assignments which reduce the performance because of the term S_2 in Equation (17.7).

In this chapter, a generalized framework is presented in which the belief theory based fusion approach is combined with the statistical approach. In the proposed framework, the first step is to transform the match scores into belief assignments using density estimation technique. In the next step, a belief theory based algorithm is used for match score fusion and finally a statistical likelihood ratio test is applied for classification. In this manner, the properties of both statistical and belief function theories are combined for biometric match score fusion. Figure 17.1 shows the steps involved in the proposed framework. This fusion framework consists of two steps: (1) match score fusion and (2) classification. In this chapter, the description of the proposed framework uses two class - two classifier approach and the subscript c_1 represents the first biometric classifier and subscript c_2 represents the second biometric classifier.

17.3.1 Match score fusion

Let the frame of discernment $\Theta = \{\theta_{gen}, \theta_{imp}\}$, where θ_{gen} represents the genuine hypothesis and θ_{imp} represents the impostor hypothesis. The first step in the proposed fusion framework is to transform the match scores into belief assignments. We use a density estimation technique for this task assuming that the match scores follow a Gaussian distribution. This method transforms a match score into the probability measure which is helpful in computing belief assignment. Gaussian density estimation [8] can be written as,

$$p(s_i, \mu_{ij}, \sigma_{ij}) = \frac{1}{\sigma_{ij}\sqrt{2\pi}} \exp \left[-\frac{1}{2} \left\{ \frac{s_i - \mu_{ij}}{\sigma_{ij}} \right\}^2 \right] \tag{17.9}$$

where s_i , ($i = 1, 2$) are the two match scores to be fused, μ_{ij} and σ_{ij} are the mean and standard deviation of the i^{th} classifier corresponding to the j^{th} element of z (in

basic sum rule $z = \Theta$, in DS theory $z = 2^\Theta$ and in DSm theory $z = D^\Theta$). Therefore the Gaussian distribution is used to compute the belief $m_i(j)$,

$$m_i(j) = \frac{p(s_i, \mu_{ij}, \sigma_{ij})}{\sum_{j=1}^z p(s_i, \mu_{ij}, \sigma_{ij})} \tag{17.10}$$

The belief assignments of each biometric classifier are then fused using eq. (17.11)

$$m_{fused} = m_{c1} \oplus m_{c2} \tag{17.11}$$

where \oplus represents the fusion rule described in Section 17.2. Note that, in this research, we evaluate the performance of the proposed fusion framework with the basic sum rule, DS theory fusion, TBM conjunctive combination rule, DSm fusion rule, and PCR rule.

17.3.2 Statistical classification

Match score fusion using the proposed framework yields the fused belief and a decision of *accept* or *reject* is made using the statistical classification technique. First, the fused beliefs are converted into probability measure using the pignistic probability, *BetP*, that maps a belief measure to a probability measure [23].

$$BetP(\theta_i) = \sum_{\theta_i \in A \subseteq \Theta} \frac{1}{|A|} \frac{m_{fused}(A)}{1 - m_{fused}(\emptyset)} \tag{17.12}$$

If $m_{fused}(\emptyset) = 0$, Equation (17.12) can be written as,

$$BetP(\theta_i) = \sum_{\theta_i \in A \subseteq \Theta} \frac{m_{fused}(A)}{|A|} \tag{17.13}$$

In this manner, we transform fused belief assignment into probability measure so that we can apply the statistical classification approach for computing the final decision. We perform likelihood ratio test for decision making as shown in Equation (17.14).

$$Decision = \begin{cases} genuine & \text{if } \frac{BetP(\theta_{gen})}{BetP(\theta_{imp})} \geq t \\ impostor & \text{otherwise} \end{cases} \tag{17.14}$$

where t is the decision threshold and is chosen based on a specific false accept rate. The advantage of this statistical classification approach is its simplicity, control over false accept and false reject rates, and it satisfies the Neyman-Pearson theorem [13] for decision making.

17.4 Algorithms and databases used for evaluation

To evaluate the verification performance of the proposed fusion framework described in Section 17.3, we use two case studies: (1) multiclassifier face verification and (2) multiclassifier fingerprint verification. In this section, we briefly describe the algorithms and databases used for evaluation.

17.4.1 Face verification algorithms

The first case study for evaluating the performance of the proposed fusion framework is performed with multiclassifier face verification. The face is first detected from the input images using the triangle based face detection algorithm [17]. Global and local facial features are extracted and match scores are computed from the detected face images using the two face verification algorithms described below.

- **2D Log Polar Gabor Transform:** In the 2D log polar Gabor transform based face recognition algorithm, the face image is transformed into polar coordinates and texture features are extracted using the neural network architecture based 2D log polar Gabor transform [20]. These features are matched using Hamming distance to generate the match scores.
- **Local Binary Pattern:** In this algorithm, a face image is divided into several regions and weighted Local Binary Pattern (LBP) features are extracted to generate a feature vector [3]. Matching of two LBP feature vectors is performed using the weighted Chi-square distance measure.

In this case study, the two face classifiers are represented as c_1 and c_2 , and the match scores computed using these classifiers are combined using the proposed fusion framework.

17.4.2 Fingerprint verification algorithm

Multiclassifier fingerprint verification is used as the second case study for evaluating the performance of the proposed fusion framework. Level-2 minutiae and level-3 pore features based verification algorithms are used to compute the match scores.

- **Level-2 Minutia Verification Algorithm:** A ridge tracing minutiae extraction algorithm [11] is used to extract the level-2 minutia features from a fingerprint image. Gallery and probe minutiae are matched using a dynamic bounding box based matching algorithm [10].
- **Level-3 Pore and Ridge Verification Algorithm:** The level-3 pore and ridge feature extraction algorithm [29] uses Mumford Shah functional curve evolution based fast feature extraction algorithm to efficiently segment contours and extract the intricate level-3 features. Matching of gallery and probe feature sets is performed using the Mahalanobis distance measure.

These minutiae and pore based matching algorithms are used as classifiers c_1 and c_2 and the corresponding match scores are fused using the proposed fusion framework.

17.4.3 Biometric databases used for evaluation

We use two biometric databases for these case studies. These databases are: Notre Dame face database [1, 9] used for evaluating the performance for multiclassifier face verification and high resolution fingerprint database for the experiments related to multiclassifier fingerprint verification.

1. **Notre Dame Face Database** [9]: This database is a part of the NIST Face Recognition Grand Challenge (FRGC). We use collection B of the Notre Dame face database which contains around 35,000 high resolution frontal face images under different lighting conditions and expressions. It is one of the most comprehensive face databases widely used for evaluating the performance of face recognition algorithms.
2. **High Resolution Fingerprint Database** [28]: The high resolution fingerprint database contains 5500 images from 550 classes. For each class, there are 10 fingerprints. The resolution of fingerprint images is 1000 ppi to facilitate the extraction of both level-2 minutiae and level-3 pore features.

17.5 Experimental evaluation

As mentioned before, the proposed fusion framework is evaluated for two multi-biometric scenarios. For each case study, we compute the verification accuracy of the proposed fusion framework with sum rule, DS theory fusion, TBM, DS_m and PCR rule. For performance evaluation, we use cross validation with 20 trials. Three images are randomly selected for training (estimating densities, thresholds, and learning classifiers) and the remaining images are used as the test data to evaluate the algorithms. This train-test partitioning is repeated 20 times and the Receiver Operating Characteristics (ROC) curves are generated by computing the genuine accept rates (GAR) over these trials at different false accept rate (FAR). This section presents the experimental results with their analysis.

To evaluate the performance of the proposed fusion framework, we use multiclassifier face verification using the Notre Dame face database as the first case study. The ROC plot in Figure 17.2 and Table 17.1 show the verification accuracies of this case study. Here classifier 1 is the 2D log polar Gabor transform based verification algorithm that yields an average verification accuracy of 93.1% at 0.01% FAR and classifier 2 is the local binary pattern based verification algorithm that yields an average verification accuracy of 82.3% at 0.01% FAR.

The sum rule based fusion algorithm (using bpa) improves the verification performance by 4.6%. During our experiments, we analyze that the Sum rule fusion

Algorithms	Verification Accuracy (%)			
	Multiclassifier Face Verification		Multiclassifier Fingerprint Verification	
	Average	[Max., Min.]	Average	[Max., Min.]
Classifier 1	93.1	[94.3, 85.7]	88.9	[92.1, 83.6]
Classifier 2	82.3	[90.5, 78.1]	91.5	[93.5, 90.8]
Sum Rule	97.7	[98.8, 92.6]	97.1	[98.2, 93.5]
DS Theory Fusion	98.0	[98.9, 95.7]	97.7	[99.0, 95.4]
TBM Fusion Rule	98.2	[99.0, 96.1]	98.2	[99.1, 96.6]
DSm Fusion Rule	98.5	[99.1, 97.3]	98.7	[99.3, 98.1]
PCR5 Fusion Rule	98.9	[99.8, 98.2]	99.1	[99.9, 98.5]

Table 17.1: Experimental results of fusion algorithms at 0.01% FAR.

algorithm is not able to handle most of the conflicting cases. Furthermore, during different cross validation trials, we also observe that the variance in the verification accuracies obtained by the sum rule is very large. This shows that the Sum rule is not very stable and it depends upon the training images. The proposed fusion framework with DS fusion, TBM, and DSm fusion improves the verification accuracy in the range of 4.9-5.4% and is more stable compared to the Sum rule. Analysis of the experimental results of the proposed fusion framework with DS fusion, TBM rule, and DSm fusion show that these three rules efficiently redistribute the beliefs and fuse the match scores which are not highly conflicting. However, with highly conflicting match scores that are caused due to variations in expression, lighting and time difference between gallery and probe face images, they do not provide reliable decision. The proposed framework with PCR5 rule yields the best verification accuracy of 98.9%. This is because the fusion framework with PCR5 rule first performs efficient redistribution of the partial conflicts according to the proportion/weight of each source. After redistribution, the belief measure is transformed into the probability measure and likelihood ratio test is used for decision. In this manner, it includes the properties of the theory of evidence and satisfies the Neyman-Pearson theorem [13] as well. Finally, the proposed framework with PCR5 fusion is the most stable algorithm across all cross validation trials whereas verification accuracies pertaining to other fusion algorithms vary significantly.

The second case study on multiclassifier fingerprint verification shows similar results. The ROC plot in Figure 17.3 and Table 17.1 show the verification accuracies of this case study. Level-2 minutiae verification algorithm is classifier 1 that yields an average verification accuracy of 88.9% at 0.01% FAR and level-3 pore and ridge verification algorithm is the classifier 2 that yields an average verification accuracy of 91.5% at 0.01% FAR. We evaluate the performance of the fusion algorithms and the results are consistent with multiclassifier face verification. The proposed fusion

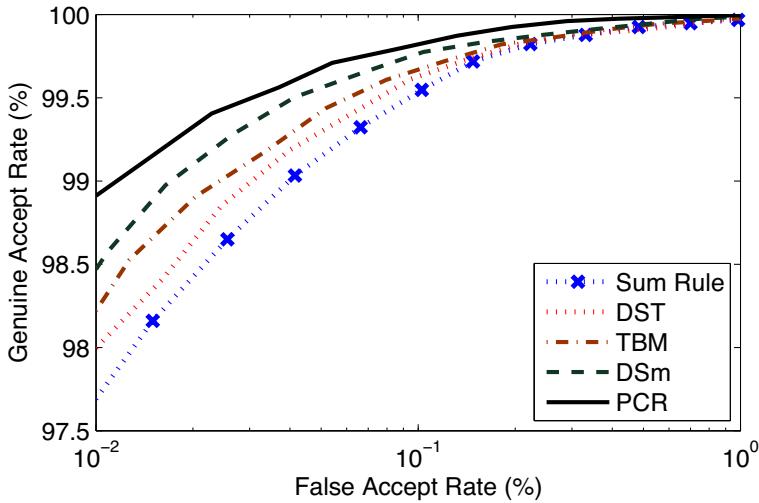

Figure 17.2: ROC of the proposed fusion framework with Sum rule, DS theory fusion, TBM, DS m and PCR rule for *multiclassifier face verification*.

framework with PCR5 rule efficiently handles highly conflicting cases that are caused due to variations in fingerprint image quality compared to other belief model based fusion rules. The proposed framework with PCR5 rule is the most stable fusion algorithm and yields 99.1% average verification accuracy.

17.6 Unification of fusion rules

Existing fusion algorithms, including the proposed fusion framework, may not fulfill all the requirements (i.e. high verification accuracy and low computational time) of a real world biometric system and provide optimal performance for all scenarios. In our recent research paper, we proposed an unification framework to efficiently address both accuracy and time complexity of multimodal biometric fusion [30]. Inspired from Smarandache's theoretical concept [22] and research by Woods *et al.* on dynamic classifier selection [32], the unification algorithm includes a collection of fusion algorithms. For a probe case, the input biometric evidences such as match scores, image quality scores and verification accuracy prior are used to dynamically select the optimal fusion algorithm for information fusion. In [30], we proposed a framework that unifies the sum rule fusion with the DS m fusion rule. The sum rule is simple and effective for cases with minor conflict whereas DS m fusion performs redistribution of conflicting beliefs and yields good performance with highly conflicting information at the

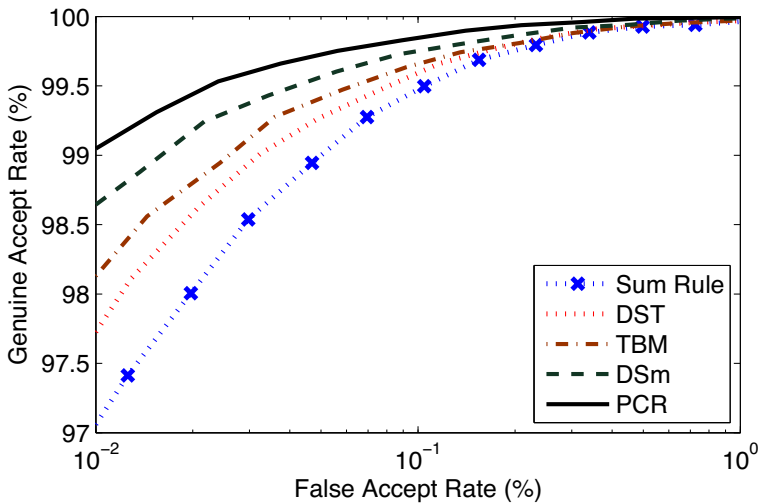

Figure 17.3: ROC of the proposed fusion framework with Sum rule, DS theory fusion, TBM, DSsm and PCR rule for *multiclassifier fingerprint verification*.

expense of computational time. The proposed unification framework, in which sum rule and DSsm fusion algorithms are unified, improves the verification performance both in terms of accuracy and computational time. More details of the unification algorithm can be obtained from [30].

17.7 Conclusion

This chapter presents a framework for multi-biometric match score fusion when non-ideal conditions cause conflict in the results of different classifiers. The proposed framework uses a belief model based fusion algorithm to effectively fuse the match scores. The framework combines statistical model with belief function models by using density estimation technique, belief model fusion rules and statistical classification. Thus, it has the properties of both statistical fusion approaches as well as belief function rules. Experimental results on multiclassifier face verification and multiclassifier fingerprint verification show that the proposed fusion framework with PCR5 rule yields the best verification accuracy even when the individual biometric classifiers provide highly conflicting match scores. As a future work, the fusion framework can be generalized without Gaussian assumption and the recently proposed DSsmP can be included for improved performance.

17.8 Acknowledgments

Portions of the research in this paper use the Notre Dame face database. The authors would like to acknowledge Dr. Smarandache and Dr. Dezert for their valuable suggestions. This research is supported in part through a grant (Award No. 2003-RC-CX-K001) from the Office of Science and Technology, National Institute of Justice, Office of Justice Programs, United States Department of Justice.

17.9 References

- [1] <http://www.nd.edu/~cvrl/UNDBiometricsDatabase.html>
- [2] J.F. Aguilar, J.O. Garcia, J.G. Rodriguez, and J. Bigun, *Discriminative multi-modal biometric authentication based on quality measures*, Pattern Recognition, Vol. 38(5), pp. 777–779, 2005.
- [3] T. Ahonen, A. Hadid, and M. Pietikinen, *Face description with local binary patterns: application to face recognition*, IEEE Transactions on Pattern Analysis and Machine Intelligence, Vol. 28(12), pp. 2037–2041, 2006.
- [4] M. Arif, T. Brouard, and N. Vincent, *A fusion methodology based on Dempster-Shafer evidence theory for two biometric applications*, in Proceedings of 18th International Conference on Pattern Recognition, Vol. 4, pp. 590–593, 2006.
- [5] J. Dezert, *Foundations for a new theory of a plausible and paradoxical reasoning*, Information and Security, Vol. 9, pp. 13–57, 2002.
- [6] J. Dezert, and F. Smarandache, *Introduction to the fusion of quantitative and qualitative beliefs*, Information and Security, Vol. 20, pp. 9–49, 2006.
- [7] D. Dubois and H. Prade, *On the unicity of Dempster rule of combination*, International Journal of Intelligent Systems, Vol. 1, pp. 133–142, 1986.
- [8] R.O. Duda, P.E. Hart, and D.G. Stork, *Pattern classification*, Wiley Interscience 2nd edition, ISBN 0-471-05669-3, 2001.
- [9] P.J. Flynn, K.W. Bowyer, and P.J. Phillips, *Assessment of time dependency in face recognition: an initial study*, in Proceedings of Audio and Video-Based Biometric Person Authentication, pp. 44–51, 2003.
- [10] A.K. Jain, L. Hong, and R. Bolle, *On-line fingerprint verification*, IEEE Transactions on Pattern Analysis and Machine Intelligence, Vol. 19(4), pp. 302–314, 1997.
- [11] X.D. Jiang, W.Y. Yau, and W. Ser, *Detecting the fingerprint minutiae by adaptive tracing the gray level ridge*, Pattern Recognition, Vol. 34(5), pp. 999–1013, 2001.

- [12] J. Kittler, M. Hatef, R.P. Duin, and J.G. Matas, *On combining classifiers*, IEEE Transactions on Pattern Analysis and Machine Intelligence, Vol. 20(3), pp. 226–239, 1998.
- [13] E.L. Lehmann and J.P. Romano, *Testing statistical hypotheses*, Springer, 2005.
- [14] K. Nandakumar, Y. Chen, S.C. Dass and A.K. Jain, *Likelihood ratio based biometric score fusion*, IEEE Transactions on Pattern Analysis and Machine Intelligence, Vol. 30(2), pp. 342–347, 2008.
- [15] A. Ross, K. Nandakumar, and A.K. Jain, *Handbook of multibiometrics*, Springer, 1st edition, ISBN: 0-3872-2296-0, 2006.
- [16] G. Shafer, *A mathematical theory of evidence*, Princeton University Press, 1976.
- [17] S.K. Singh, D.S. Chauhan, M. Vatsa, and R. Singh, *A robust skin color based face detection algorithm*, Tamkang Journal of Science and Engineering, Vol. 6(4), pp. 227–234, 2003.
- [18] R. Singh, M. Vatsa, A. Noore, and S.K. Singh, *DS theory classifier fusion with update rule to minimize training time*, IEICE Electronics Express, Vol. 3(20), pp. 429–435, 2006.
- [19] R. Singh, M. Vatsa, A. Noore, and S.K. Singh, *Dempster Shafer theory based classifier fusion for improved fingerprint verification performance*, in Proceedings of Indian Conference on Computer Vision, Graphics and Image Processing, LNCS 4338, pp. 941–949, 2006.
- [20] R. Singh, M. Vatsa, and A. Noore, *Face recognition with disguise and single gallery images*, Image and Vision Computing, Vol. 37(3), pp. 245–257, 2009.
- [21] R. Singh, M. Vatsa, and A. Noore, *Integrated multilevel image fusion and match score fusion of visible and infrared face images for robust face recognition*, Pattern Recognition, Vol. 43(3), pp. 880–893, 2008.
- [22] F. Smarandache, *An in-depth look at quantitative information fusion rules*, in Advances and Applications of DSMT for Information Fusion, American Research Press, Chapter 8, pp. 205–236, 2006.
- [23] P. Smets and R. Kennes, *The transferable belief model*, Artificial Intelligence, Vol. 66(2), pp. 191–234, 1994.
- [24] P. Smets, *Decision making in a context where uncertainty is represented by belief functions*, Physica-Verlag, pp. 17–61, 2002.
- [25] P. Smets, *Analyzing the combination of conflicting belief functions*, Information Fusion, Vol.8(4), pp. 387–412, 2007.

- [26] Y. Sugie and T. Kobayashi, *Media-integrated biometric person recognition based on the Dempster-Shafer theory*, in Proceedings of 16th International Conference on Pattern Recognition, Vol. 4, pp. 40381–40384, 2002.
- [27] B. Ulery, A.R. Hicklin, C. Watson, W. Fellner, and P. Hallinan, *Studies of biometric fusion*, NIST Technical Report IR 7346, 2006.
- [28] M. Vatsa, R. Singh, A. Noore, and M. Houck, *Quality-augmented fusion of level-2 and level-3 fingerprint information using DSm theory*, International Journal of Approximate Reasoning, (In press), 2009.
- [29] M. Vatsa, R. Singh, A. Noore and S.K. Singh, *Quality induced fingerprint identification using extended feature set*, in Proceedings of IEEE Conference on Biometrics: Theory, Applications and Systems, pp. 1–6, 2008.
- [30] M. Vatsa, R. Singh, and A. Noore, *Unification of evidence theoretic fusion algorithms: A case study in level-2 and level-3 fingerprint features*, In IEEE Transactions on Systems, Man, and Cybernetics-A, Vol. 39(1), pp. 47–56, 2009.
- [31] F. Voorbraak, *On the justification of Dempsters rule of combination*, Artificial Intelligence, Vol. 48(2), pp. 171–197, 1991.
- [32] K. Woods, W.P. Kegelmeyer, and K.W. Bowyer, *Combination of multiple classifiers using local accuracy estimates*, IEEE Transactions on Pattern Analysis and Machine Intelligence, Vol. 19(4), pp. 405–410, 1997.
- [33] R.R. Yager, J. Kacprzyk, and M. Fedrizzi, *Advances in the Dempster-Shafer theory of evidence*, Wiley, 1994.
- [34] L. Zadeh, *On the validity of Dempster's rule of combination*, University of California, Berkeley, Memo M 79/24, 1979.
- [35] Z. Zivkovic and F. van der Heijden, *Recursive unsupervised learning of finite mixture models*, IEEE Transactions on Pattern Analysis and Machine Intelligence, Vol. 26(5), pp. 651–656, 2004.

Chapter 18

Multimodal information retrieval based on DS_mT. Application to computer-aided medical diagnosis

Gwéno \acute{l} e Qu \acute{e} llec^{1,3}, Mathieu Lamard^{2,3}, Guy Cazuguel^{1,3},
B \acute{e} atrice Cochener^{2,3,4}, Christian Roux^{1,3}

1: Institut Telecom; TELECOM Bretagne;
UEB; Dpt ITI, Brest, F-29200 France;

2: Univ. Bretagne Occidentale, Brest, F-29200 France;

3: Inserm, U650, Brest, F-29200 France;

4: CHU Brest, Service d'Ophtalmologie, Brest, F-29200 France;

Abstract: *We propose in this chapter a content-based information retrieval framework to select documents in a database, consisting of several images with semantic information. Information in these documents is not only heterogeneous, but also often incomplete. So, the method we propose may cover a wide range of applications. To select the most relevant cases in the database, for a query, a degree of match between two cases is defined for each case feature, and these degrees of match are fused. Two different fusion models are proposed: a Shafer's model consisting of two hypotheses and a hybrid DS_mT model consisting of N hypotheses, where N is the number of cases in the database. They allow us to model our confidence in each feature, and take it into account in the fusion process, to improve the retrieval performance. To include images in such a system, we characterize them by their digital content. The proposed methods are applied to two multimodal medical databases for computer aided diagnosis; a comparison with other retrieval methods we proposed recently is provided. A mean precision at five of 81.8% and 84.8% was obtained on a diabetic retinopathy and a mammography database, respectively: the methods are precise enough to be used in a diagnosis aid system.*

18.1 Introduction

Case-based reasoning (CBR) [1] was introduced in the early 1980s as a new decision support tool. It is based on the assumption that analogous problems have similar solutions: to help interpreting a new case, similar cases are retrieved from a database and returned to the user. In this chapter, we focus on CBR in multimodal databases. To retrieve heterogeneous information, some simple approaches, based on early fusion [21, 24] or late fusion [14, 26] have been introduced in the literature. Recently, an elaborate retrieval method, based on dissimilarity spaces and relevance feedback, has also been proposed [5]. In the same time, we proposed several other approaches that do not rely on relevance feedback, and can efficiently manage missing information and the aggregation of heterogeneous features (symbolic and multidimensional digital information). The first approach is based on decision trees [15]. The second one is based on Bayesian networks [16]. We introduce in this chapter a third approach, based on DSMT: information coming from each case feature F_i , $i = 1..M$, is used to derive an estimation of the degree of match between a query case and a case in the database. A case feature F_i can be either a nominal variable, an image acquired using a given modality, or any other type of signal. These estimations are then fused, in order to define a consensual degree of match, which is used to retrieve the most relevant cases for the query. In order to model our confidence in the estimation provided by each source of evidence, we propose two fusion models based on DSMT. The first one is based on a Shafer's model consisting of two hypotheses. The second one is based on a hybrid DSMT model consisting of N hypotheses, where N is the number of cases in the database. Finally, the cases in the database maximizing the consensual degree of match with the query are returned to the user.

The proposed approach is applied to computer-aided diagnosis. In medicine, the knowledge of experts is a mixture of textbook knowledge and experience through real life clinical cases. So, the assumption that analogous problems have similar solutions is backed up by physicians' experience. Consequently, there is a growing interest in the development of medical decision support systems based on CBR [4], especially to assist the diagnosis of physicians. Such systems are intended to be used as follows: when a physician has doubts about his diagnosis, he sends the available patient data to the system. The most similar cases, along with their medical interpretations, are retrieved from the database and returned to the physician, who can then compare his case to these retrieved cases. Reasoning by analogy, the physician may so confirm or invalidate his diagnosis.

Medical cases often consist of digital information like images and symbolic information such as clinical annotations. Diabetic retinopathy experts, for instance, analyze multimodal series of images together with contextual information, such as the age, the sex and the medical history of the patient. So, to use all the information available, we have to manage both digital and semantic information. On one hand, there are some medical CBR systems designed to manage symbolic information [6].

On the other hand, some systems, based on Content-Based Image Retrieval [20], have been designed to manage digital images [13]. However, few attempts have been made to merge the two kinds of approaches. Actually, in some systems, it is possible to formulate both textual and digital queries in parallel [2, 11], but the two kinds of information are processed separately. In another system, a text based and an image based similarity measure are combined linearly into a common similarity measure [18]. Nevertheless, in our application, none of those solutions is suitable to use at best the relationships between symbolic and digital information. Our approaches are efficient solutions for information retrieval based on both clinical descriptors and digital image features. More, they take into account the fact that the information is often incomplete and uncertain.

The objectives are detailed in section 18.2. Shafer's model is presented in section 18.3 and the hybrid DSMT model in section 18.4. The proposed approaches are applied to computer-aided diagnosis of diabetic retinopathy and mammography in section 18.5: we provide a comparison with the other two multimodal information retrieval methods we proposed [15, 16]. We end with a discussion and a conclusion in section 18.6.

18.2 Objectives

As mentioned before, we have already proposed methods to manage databases with heterogeneous information. But they do not take into account the uncertainty of information and the possible conflicts between some feature values. We propose to evaluate the contribution of DSMT for medical CBR, in comparison with the other two multimodal retrieval methods we proposed. For this purpose, let us remind the evaluation procedure we use. Let $(x_j)_{j=1..N}$ be the cases in the database and x_q be a case placed as a query to the retrieval system. The system retrieves k cases from the database, where k is chosen by the users. The objective is to maximize the percentage of relevant cases, according to the users, among the k retrieved cases. This percentage is called the precision at k . For each method, we define a degree of match (or a similarity measure) between cases, and the k cases in the database maximizing the degree of match with x_q are retrieved. We tune the definition of the degree of match in order to maximize the percentage of relevant cases among the k retrieved cases, by training these methods. For this purpose, the cases in the database have to be classified by the users, in order to catch their perception of relevance between cases. Then, the database is divided into a training dataset $(x_j^T)_{j=1..NT}$ and an evaluation dataset $(x_j^E)_{j=1..NE}$.

18.3 Shafer's model for information retrieval

In order to select the k cases to retrieve for a query x_q , we compute the similarity of each case x_j in the database, $j = 1..N$, with x_q . For this purpose, we first es-

timate, for each case feature F_i , the degree of match between x_j and x_q according to F_i , denoted $dm_i(x_j, x_q)$. To compute these estimations, we define a finite number of states f_{is} for each feature F_i , $i = 1..M$, and we compute the membership degree of any case y to each state f_{is} of F_i , noted $\alpha_{is}(y)$. y denotes either x_q or x_j , $j = 1..N$. If F_i is a nominal variable, $\alpha_{is}(y)$ is Boolean; for instance, if y is a male then $\alpha^{\text{"sex"}, \text{"male"}}(y) = 1$ and $\alpha^{\text{"sex"}, \text{"female"}}(y) = 0$. If F_i is an image (or any type of signal), the definition of f_{is} and $\alpha_{is}(y)$ is given in section 18.3.1. The estimation of the degree of match between x_j and x_q according to F_i , namely $dm_i(x_j, x_q)$, is computed as described in section 18.3.2.

These estimations are then combined. The frame of discernment used in the fusion process is described in section 18.3.3. A belief mass function is first derived from each estimation of the degree of match, provided by a case feature (see section 18.3.4). It is designed in order to give more importance in the fusion process to sources of evidence in which we have more confidence. These belief mass functions are then fused (see section 18.3.5) and a consensual degree of match between x_j and x_q is derived: this consensual degree of match is used to find the k cases in the database maximizing the similarity with x_q (see section 18.3.6).

18.3.1 Image processing

If the case feature is a nominal variable, defining states f_{is} for F_i is straightforward, it is more difficult for images. To define states for images of a given type, we propose to follow the usual steps of Content-Based Image Retrieval (CBIR) [20], that is: 1) building a signature for each image (i.e. extracting a feature vector summarizing their digital content), and 2) defining a distance measure between two signatures. As a consequence, measuring the distance between two images comes down to measuring the distance between two signatures. Similarly, defining states for images of a given type comes down to defining states for the signatures of the corresponding images. For this purpose, we cluster similar image signatures, as described below, and we associate each cluster with a state. By this procedure, images can be processed by the retrieval method like any other feature.

In previous studies on CBIR, we used a customized wavelet decomposition to extract signatures from images [10]. These signatures characterize the distribution of the wavelet coefficients in each subband of the decomposition. Wouwer [25] showed that the wavelet coefficient distribution, in a given subband, can be modeled by a generalized Gaussian function. We define the signature as the juxtaposition of the maximum likelihood estimators of the wavelet coefficient distribution in each subband. To define a distance measure between signatures, we used a symmetric version of the Kullback-Leibler divergence between wavelet coefficient distributions [8]: the distance between two images is a weighted sum of these symmetrized divergences [10]. The ability to select a weight vector and a wavelet basis makes this image representation highly tunable.

In order to define states for images of a given type F_i , we cluster similar images with an unsupervised classification algorithm, thanks to the image signatures and the associated distance measure above. The Fuzzy C-Means algorithm (FCM) [3] was used for this purpose: each case y is assigned to each cluster s with a fuzzy membership $\alpha_{is}(y)$, $0 \leq \alpha_{is}(y) \leq 1$, such that $\sum_s \alpha_{is}(y) = 1$.

Other features can be discretized similarly: the age of a person, monodimensional signals, videos, etc.

18.3.2 Estimation of the degree of match for a feature F_i

We have to define a similarity measure between two cases from their membership degree to each state of a feature F_i . We could assume that cases with membership degrees close to that of x_q are the most liable to be relevant for x_q . So, a similarity measure between x_j and x_q , according to a case feature F_i , may be $\sum_s \alpha_{is}(x_j)\alpha_{is}(x_q)$. However, this assumption is only appropriate if all cases in a given class tend to be at the same state for F_i . Another model, more general, is used: we assume that cases in the same class are predominantly in a subset of states for F_i . So, to estimate the degree of match, we define a correlation measure S_{ist} between couples of states (f_{is}, f_{it}) of F_i , regarding the class of the cases at these states. S_{ist} is computed using the cases $(x_j^T)_{j=1..NT}$ in the training dataset. Let $c = 1..C$ be the possible classes for a case in the database. We first compute the mean membership D_{isc} (resp. D_{itc}) of cases x_j^T in a given class c to the state f_{is} (resp. f_{it}):

$$D_{isc} = \beta \frac{\sum_j \delta(x_j^T, c) \alpha_{is}(x_j^T)}{\sum_j \delta(x_j^T, c)} \tag{18.1}$$

$$\sum_{c=1}^C D_{isc}^2 = 1, \forall (i, j) \tag{18.2}$$

where $\delta(x_j^T, c) = 1$ if x_j^T belongs to class c , $\delta(x_j^T, c) = 0$ otherwise, and β is a normalizing factor chosen so that equation 18.2 holds. S_{ist} is given by equation 18.3:

$$S_{ist} = \sum_{c=1}^C D_{isc} D_{itc} \tag{18.3}$$

So we estimate the degree of match between the two cases x_j and x_q , with respect to a case feature F_i , as follows:

$$dm_i(x_j, x_q) = \sum_s \sum_t \alpha_{is}(x_j) S_{ist} \alpha_{it}(x_q) \tag{18.4}$$

18.3.3 Designing the frame of discernment

In order to estimate the relevance of a case x_j for the query x_q , as a consensus between all the sources of evidence, we define two hypotheses: $Q = "x_j$ is relevant for

x_q ” and \bar{Q} = “ x_j is not relevant for x_q ”. The following frame of discernment is used in the fusion problem: $\Theta^{(1)} = \{Q, \bar{Q}\}$. To define the belief mass function associated with a given source of evidence, i.e. a feature F_i , we assign a mass to each element in $D^{\Theta^{(1)}} = \{\emptyset, Q, \bar{Q}, Q \cap \bar{Q}, Q \cup \bar{Q}\}$. In fact, it is meaningless to assign a mass to $Q \cap \bar{Q}$, as a consequence, we only assign a mass to elements in $D^{\Theta^{(1)}} \setminus Q \cap \bar{Q} = \{\emptyset, Q, \bar{Q}, Q \cup \bar{Q}\} = 2^{\Theta^{(1)}}$. We are thus designing a Shafer’s model consisting of two hypotheses.

18.3.4 Defining the belief mass functions

To compute the belief mass functions, we define a test T_i on the degree of match $dm_i(x_j, x_q)$: T_i is true if $dm(x_j, x_q) \geq \tau_i$ and false otherwise, $0 \leq \tau_i \leq 1$. The belief masses are then assigned according to T_i :

- if T_i is true:
 - $m_i(Q) = P(T_i | x_j \text{ is relevant for } x_q) \rightarrow$ the sensitivity of T_i
 - $m_i(Q \cup \bar{Q}) = 1 - m_i(Q)$
 - $m_i(\bar{Q}) = 0$
- else
 - $m_i(\bar{Q}) = P(\bar{T}_i | x_j \text{ is not relevant for } x_q) \rightarrow$ the specificity of T_i
 - $m_i(Q \cup \bar{Q}) = 1 - m_i(\bar{Q})$
 - $m_i(Q) = 0$

The sensitivity (resp. the specificity) represents the degree of confidence in a positive (resp. negative) answer to test T_i ; $m_i(Q \cup \bar{Q})$, the belief mass assigned to the total ignorance, represents the degree of uncertainty: the higher this term, the lower our confidence in the case feature F_i . The sensitivity and the specificity of T_i , for a given threshold τ_i , are estimated using each pair of cases (x_a^T, x_b^T) in the training dataset, one playing the role of x_q , the other playing the role of x_j . The sensitivity (resp. the specificity) is estimated by the average number of pairs for which T_i is true (resp. false) among the pairs of cases belonging to the same class (resp. to different classes). T_i is appropriate if it is both sensitive and specific. As τ_i increases, sensitivity increases and specificity decreases. So, we set τ_i as the intersection of the two curves “sensitivity according to τ_i ” and “specificity according to τ_i ”. A binary search is used to find the optimal τ_i .

18.3.5 Fusing the belief mass functions

If the i^{th} case feature is available for both x_j and x_q , the degree of match $dm_i(x_j, x_q)$ is estimated (see section 18.3.2) and the belief mass function is computed according to test T_i (see section 18.3.4). The computed belief mass functions are then fused. Let

$M' \leq M$ be the number of belief mass functions to fuse. Usual rules of combination have a time complexity exponential in M' , which might be a limitation. So we propose a rule of combination for problems consisting of two hypotheses (Q and \bar{Q} in our application), adapted from the Proportional Conflict Redistribution (PCR) rules [19], with a time complexity evolving polynomially with M' (see appendix 18.8).

18.3.6 Identifying the most similar cases

Once the sources available for x_q are fused by the proposed rule of combination, a decision function is used to compute the consensual degree of match between x_j and x_q . We express this consensual degree of match either by the credibility (cf. equation 18.5), the plausibility (cf. equation 18.6), or the pignistic probability of Q (cf. equation 18.7).

$$Bel(A) = \sum_{B \in D^\Theta, B \subseteq A, B \neq \emptyset} m(B) \tag{18.5}$$

$$Pl(A) = \sum_{B \in D^\Theta, A \cap B \neq \emptyset} m(B) \tag{18.6}$$

$$BetP(A) = \sum_{B \in D^\Theta, B \neq \emptyset} \frac{C_{\mathcal{M}}(A \cap B)}{C_{\mathcal{M}}(B)} m(B) \tag{18.7}$$

The notation $B \neq \emptyset$ means that $B \neq \emptyset$ and B has not been forced to be empty through the constraints of the model \mathcal{M} ; $C_{\mathcal{M}}(B)$ denotes the number of parts of B in the Venn diagram of the model $\mathcal{M}(\Theta)$ [7, 22]. It emerges from our applications that using the pignistic probability of Q leads to a higher mean precision at k (more elaborate decision functions might improve the retrieval performance). The pignistic probability of Q , $BetP(Q)$, is computed according to equation 18.8.

$$BetP(Q) = m_f(Q) + \frac{m_f(Q \cup \bar{Q})}{2} \tag{18.8}$$

The k cases maximizing $BetP(Q)$ are then returned to the user.

18.3.7 Managing missing values

The proposed method works even if some features are missing for x_j and x_q : we simply take into account the sources of evidence available for both x_j and x_q . However, it may be more efficient to take also into account information available for only one of the two cases.

A solution is to use a Bayesian network modeling the probabilistic dependencies between the features $F_i, i = 1..M$. The Bayesian network is built from the training dataset automatically [16]. We use it to infer the posterior probability of the features F_i unavailable for x_j , but available for x_q . As a consequence, all the features available for x_j are used to infer the posterior probability of the other features. And all the

features available for x_q are involved in the fusion process: a belief mass function is defined for each feature available for x_q .

18.4 Hybrid DS_m model for information retrieval

In the model presented in section 18.3, we have estimated the probability that each case x_j in the database is relevant for the case x_q placed as a query, $j = 1..N$. In this second model, we slightly reformulate the retrieval problem: we estimate the probability that x_q is relevant for each case x_j in the database, $j = 1..N$. The interest of this new formulation is that we can include in the model the similarity between cases x_j . To find the cases maximizing the similarity with the query in the database, we assess the following hypotheses $X_j = \text{“}x_q \text{ is relevant for } x_j\text{”}$, $j = 1..N$, and we select the k most likely: the k corresponding cases x_j are thus returned to the user. As a consequence, a different frame of discernment is used (see section 18.4.1). The likelihood of each hypothesis X_j , $j = 1..N$, is estimated for each feature F_i , $i = 1..M$. These estimations are based on the same degree of match that was used in the previous model (see section 18.3.2).

Since we use a new frame of discernment, a new belief mass function is defined for each feature F_i (see section 18.4.2). These belief mass functions are then fused (see section 18.4.3). And a consensual estimation of the likelihood of X_j is derived: this consensual estimation of the likelihood is used to find the cases in the database maximizing the similarity with x_q (see section 18.4.4).

18.4.1 Designing the frame of discernment

The following frame of discernment is used in the new fusion problem: $\Theta^{(2)} = \{X_1, X_2, \dots, X_N\}$. The cardinal of $D^{\Theta^{(2)}}$ is hyper-exponential in N . As a consequence, to solve the fusion problem, it is necessary to set some constraints in the model. We are thus designing a hybrid DS_m model. These constraints are also justified from a logical point of view: *a priori*, if two cases x_a and x_b are dissimilar, or if x_a and x_b belong to different classes (as indicated by the users), then the two hypotheses X_a and X_b are incompatible.

To design the frame of discernment, we first build an undirected graph $G_c = (V, E)$, that we call compatibility graph. Each vertex $v \in V$ in this graph represents an hypothesis, and each edge $e \in E$ represents a couple of compatible hypotheses. To build the compatibility graph, each case x_j in the database, $j = 1..N$, is connected in the compatibility graph G_c to its l nearest neighbors. The distance measure we used to find the nearest neighbors is simply a linear combination of heterogeneous distance functions (one for each case feature F_i), managing missing information [24]. The complexity of the fusion process mainly depends on the cardinality of the largest clique in G_c (a clique is a set of vertices V such that for every pair of vertices $(u, v) \in V^2$,

there is an edge connecting u and v). The number l is closely related to the cardinality of the largest clique in G_c and consequently to the complexity of the fusion process. l was set to five in the application (see section 18.5). The Venn diagram of the model $\mathcal{M}(\Theta^{(2)})$ is then built: for this purpose, we identify the cliques in G_c , as described in figure 18.1.

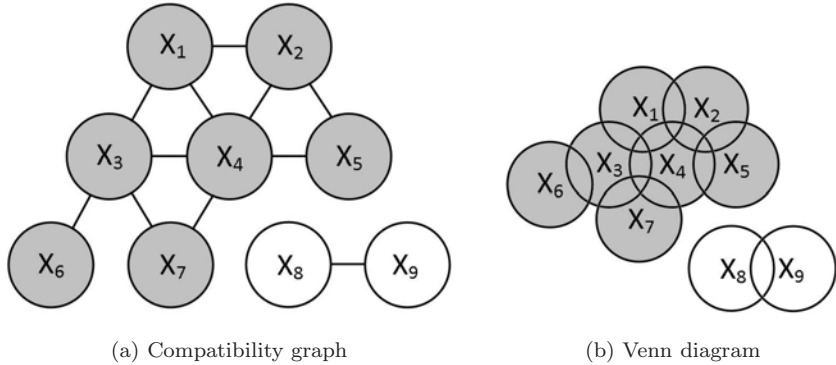

Figure 18.1: Building the frame of discernment from the compatibility graph. Hypotheses associated with cases in the same class are represented with the same color.

18.4.2 Defining the belief mass functions

For each feature F_i , the belief mass function m_i is defined as follows. We first identify the set of cases $(x_j)_{j=1..N' \leq N}$ such that $dm_i(x_j, x_q)$ is greater than a threshold τ'_i , $j = 1..N' \leq N$:

- a belief mass m_{i1} is assigned to the set $\bigcup_{j=1}^{N' \leq N} X_j$,
- and a belief mass $m_{i2} = 1 - m_{i1}$ is assigned to the total ignorance $\bigcup_{j=1}^N X_j$.

τ'_i is searched similarly to threshold τ_i (see section 18.3.4) with the following test: X_j is true if $dm_i(x_j, x_q) \geq \tau'_i$, otherwise X_j is false; we perform a binary search to find the threshold maximizing the minimum of the sensitivity and of the specificity of that test, whatever X_j (a single threshold τ'_i is searched for each case feature). m_{i1} is defined as the sensitivity of that test.

18.4.3 Fusing the belief mass functions

Once the Venn diagram of the model $\mathcal{M}(\Theta^{(2)})$ has been designed, we associate a unique number with each element in this diagram. The belief mass function m_i defined above is then encoded as follows:

- a binary string denoted $e_i(A)$ is assigned to each set $A \in D^{\Theta^{(2)}}$ such that $m_i(A) \neq 0$,
- the j^{th} character in the string $e_i(A)$ is 1 if and only if the j^{th} set in the Venn diagram is included in A .

In memory, the binary strings are encoded as byte strings: we associate each element in the diagram with a bit, and bits are grouped eight by eight into bytes. The elements of the Venn diagram form a partition of $\Omega = \bigcup_{j=1}^N X_j$, as a consequence, the following equation holds:

$$e_i(A \cap B) = e_i(A) \cap e_i(B) \quad (18.9)$$

Let us consider the following three-source problem, illustrated in figure 18.2.

The frame of discernment consists of five elements: $\Theta^{(2)} = \{X_1, X_2, X_3, X_4, X_5\}$, where $X_1 = \{0, 5, 6, 9\}$, $X_2 = \{1, 5, 7, 9\}$, $X_3 = \{2, 6, 7, 9\}$, $X_4 = \{3, 8\}$ and $X_5 = \{4, 8\}$.

These belief mass functions are fused sequentially:

- fusion of m_1 and m_2 by the PCR5 rule $\rightarrow m_{12}$ [19],
- fusion of m_{12} and m_3 by the PCR5 rule $\rightarrow m_{123}$,
- etc.

As we fuse the belief mass functions, the number of elements $A \in D^{\Theta^{(2)}}$ satisfying $m_j(A) \neq 0$ increases. To access these elements and update their mass, we rank them in alphabetical order of $e_i(A)$: we can thus access them quickly with a binary search algorithm.

Detecting conflicts between two sources is made easier with this representation: if $e_i(A) \cap e_i(B) = 0$, $A \in D^{\Theta^{(2)}}$, $B \in D^{\Theta^{(2)}}$, then A and B are conflicting. On the example above, the fused belief mass function we obtain is illustrated in figure 18.3.

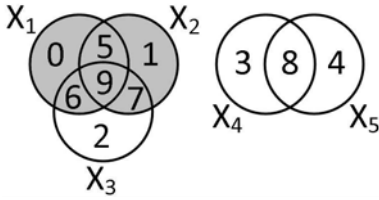

(a) m_1

$$m_1(X_1 \cup X_2) = 0.6, m_1(\Omega) = 0.4$$

$$e_1(X_1 \cup X_2) = 00000010, 11100011$$

$$e_1(\Omega) = 00000011, 11111111$$

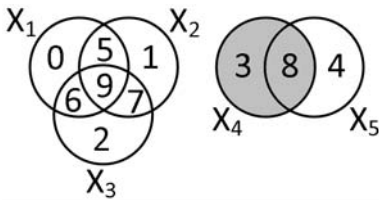

(b) m_2

$$m_2(X_4) = 0.7, m_2(\Omega) = 0.3$$

$$e_2(X_4) = 00000001, 00001000$$

$$e_2(\Omega) = 00000011, 11111111$$

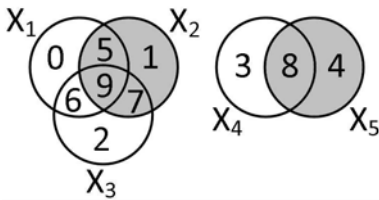

(c) m_3

$$m_3(X_2 \cup X_5) = 0.8, m_3(\Omega) = 0.2$$

$$e_3(X_2 \cup X_5) = 00000011, 10110010$$

$$e_3(\Omega) = 00000011, 11111111$$

Figure 18.2: Encoding the belief mass functions.

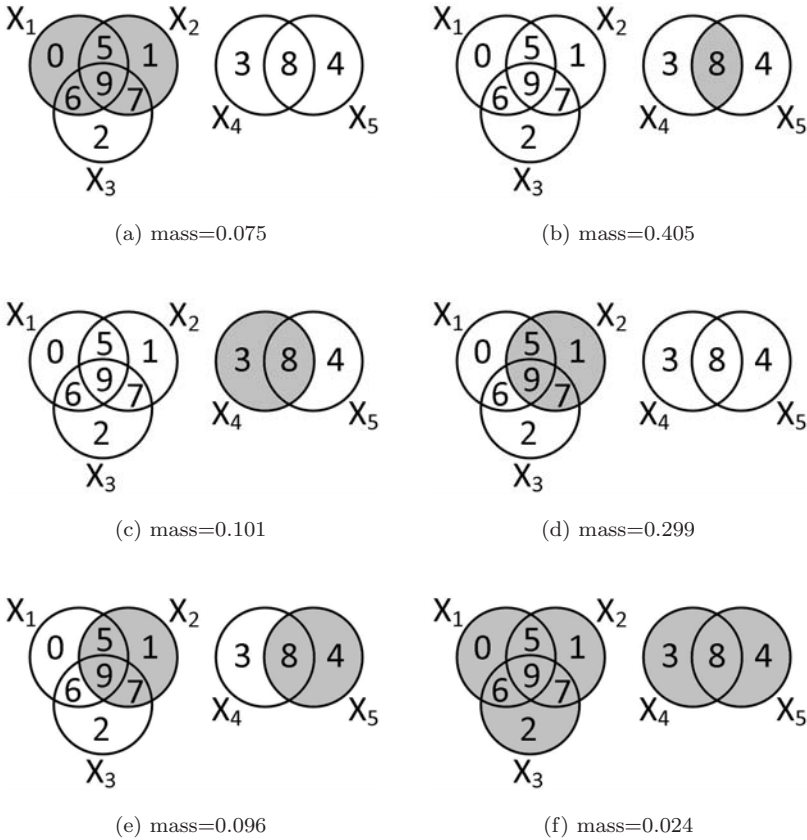

Figure 18.3: Fused belief mass function: this figure represents the sets to which a non-zero belief mass has been assigned.

18.4.4 Identifying the most similar cases

Once the belief mass functions are fused, the pignistic probability of each element $X_j \in \Theta^{(2)}$ is computed (see equation 18.7), like in the previous model (see section 18.3.6): it is used as the consensual estimation of the likelihood of X_j . For instance, the computation of $BetP(X_4)$ is given below:

$$BetP(X_4) = \frac{1}{1} \cdot 0.405 + \frac{2}{2} \cdot 0.101 + \frac{1}{6} \cdot 0.096 + \frac{2}{10} \cdot 0.024 = 0.527 \quad (18.10)$$

Then, the k cases x_j in the database maximizing $BetP(X_j)$ are returned to the user.

18.4.5 Managing missing values

Like in the previous model, we can use a Bayesian network to better manage missing information. The Bayesian network described in section 18.3.7 is used to infer the posterior probability of the features F_i unavailable for the query x_q .

18.5 Application to computer-aided medical diagnosis

The proposed methods have been evaluated on two multimodal medical databases, for computer-aided medical diagnosis. The first one (DRD) is being built at the Inserm U650 laboratory in collaboration with ophthalmologists of Brest University Hospital. The second one (DDSM) is a public access database.

18.5.1 Diabetic retinopathy database (DRD)

The diabetic retinopathy database contains retinal images of diabetic patients, with associated anonymized information on the pathology. Diabetes is a metabolic disorder characterized by a sustained high sugar level in the blood. Progressively, blood vessels are affected in many organs, which may lead to serious renal, cardiovascular, cerebral and also retinal complications. In the latter case, the pathology, namely diabetic retinopathy, can cause blindness. Patients have been recruited at Brest University Hospital since June 2003.

The database consists of 67 patient records containing 1112 photographs altogether. The disease severity level, according to ICDRS classification [23], was assessed by experts for each patient. The distribution of the disease severity among the 67 patients is given in table 18.1. Images have a definition of 1280 pixels/line for 1008 lines/image. They are lossless compressed images, acquired by experts using a Topcon Retinal Digital Camera (TRC-50IA) connected to a computer.

Database	Disease severity	Number of patients
DRD	no apparent diabetic retinopathy	7
	mild non-proliferative	9
	moderate non-proliferative	22
	severe non-proliferative	9
	proliferative	9
	treated/non active diabetic retinopathy	11
DDSM	normal	695
	benign	669
	cancer	913

Table 18.1: Patient disease severity distribution.

An example of image sequence is given in figure 18.4. The contextual information available is the age, the sex and structured medical information about the patient (see table 18.2). Patient records consist of 10 images per eye (see figure 18.4) and 13 contextual attributes at most; 12.1% of these images and 40.5% of these contextual attribute values are missing.

Attributes	Possible values
General clinical context	
family clinical context	diabetes, glaucoma, blindness, misc.
medical clinical context	arterial hypertension, dyslipidemia, proteinuria, renal dialysis, allergy, misc.
surgical clinical context	cardiovascular, pancreas transplant, renal transplant, misc.
ophthalmologic clinical context	cataract, myopia, AMD, glaucoma, unclear medium, cataract surgery, glaucoma surgery, misc.
Examination and diabetes context	
diabetes type	none, type I, type II
diabetes duration	< 1 year, 1 to 5 years, 5 to 10 years, > 10 years
diabetes stability	good, bad, fast modifications, glycosylated hemoglobin
treatments	insulin injection, insulin pump, anti-diabetic drug + insulin, anti-diabetic drug, pancreas transplant
Eye symptoms before the angiography test	
ophthalmologically symptomatic	none, systematic ophthalmologic screening-known diabetes, recently diagnosed diabetes by check-up, diabetic diseases other than ophthalmic ones
ophthalmologically asymptomatic	none, infection, unilateral decreased visual acuity (DVA), bilateral DVA, neovascular glaucoma, intra-retinal hemorrhage, retinal detachment, misc.
Maculopathy	
maculopathy	focal edema, diffuse edema, none, ischemic

Table 18.2: Structured contextual information for diabetic retinopathy patients.

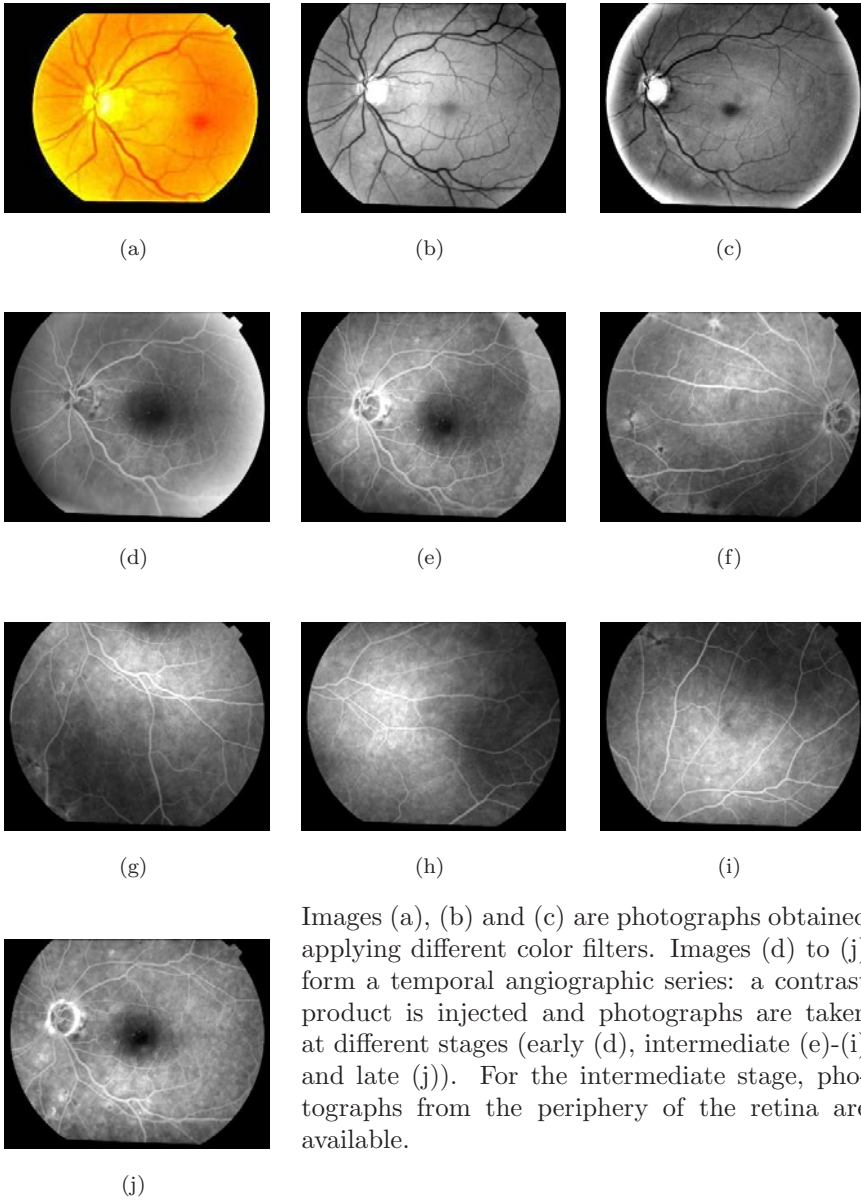

Figure 18.4: Photograph sequence of a patient's eye.

18.5.2 Digital database for screening mammography

The Digital Database for Screening Mammography (DDSM) project [9], involving the Massachusetts General Hospital, the University of South Florida and the Sandia National laboratories, has led to the setting-up of a mammographic image database for research on breast cancer screening. This database consists of 2277 patient records. Each one includes two images of each breast, associated with some information about the patient (the age, rating for abnormalities, American College of Radiology breast density rating and keyword description of abnormalities) and information about images (the scanner, the spatial resolution, etc). The following contextual attributes are taken into account in the system:

- the age of the patient,
- the breast density rating.

Images have a varying definition, of about 2000 pixels/line for 5000 lines/image. An example of image sequence is given in figure 18.5.

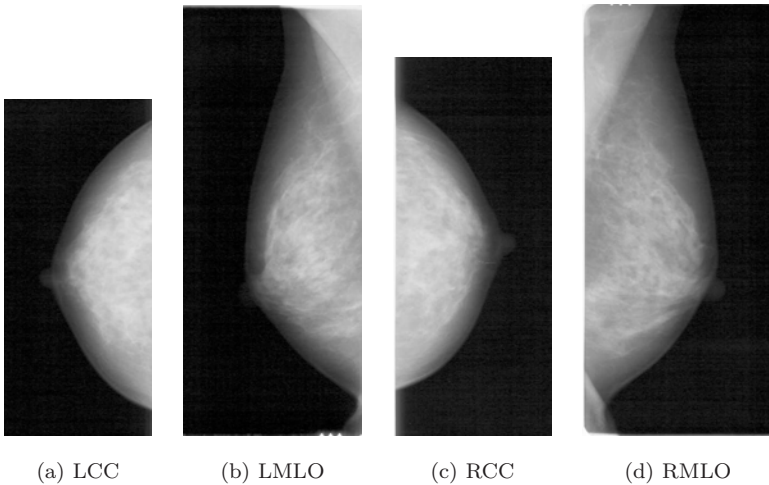

Figure 18.5: Mammographic image sequence of the same patient. (a) and (b) are two views of the left breast, (c) and (d) are two views of the right one.

Each patient record has been graded by a physician. Patients are then classified into three groups: 'normal', 'benign' and 'cancer'. The distribution of grades among the patients is given in table 18.1.

18.5.3 Objective of the computer-aided diagnosis system

For each case placed as a query by a user, we want to retrieve the most similar cases from a given database. In DRD, the number of cases selected by the system is set to $k = 5$, at ophthalmologist's request; they consider this number sufficient for time reasons and in view of the good results provided by the system. For comparison purposes, the same number of cases is displayed in DDSM. The satisfaction of the user's needs can thus be assessed by the precision at five, the percentage of cases relevant for the query among the topmost five results.

18.5.4 Features of the patient records

In those databases, each patient record consists of both digital images and contextual information. Contextual features (13 in DRD, 2 in DDSM) are processed as in the CBR system. Images need to be processed in order to extract digital features. A usual solution is to segment images and extract domain specific information (such as the number of lesions). For DRD, we use the number of microaneurysms (the most frequent lesion of diabetic retinopathy) detected by the algorithm described in [17], in conjunction with other features. However, this kind of approach requires expert knowledge for determining pertinent information in images, and a robust segmentation of images, which is not always possible because of acquisition variability. This is the reason why we characterized images as described in section 18.3.1. An image signature is thus computed for each kind of image (10 for DRD, 4 for DDSM).

18.5.5 Training and evaluation datasets

Both databases are divided randomly into a training dataset (80% of the database) and an evaluation dataset (20% of the database). To assess the system, each case in the evaluation dataset is placed sequentially as a query to the system, and the five closest cases within the training dataset, according to the retrieval system, are retrieved. The precision at five is then computed. Because the datasets are small, especially for DRD, we use a 5-fold cross-validation procedure, so that each case in the database appears once in the evaluation dataset.

18.5.6 Results

The mean precision at five obtained with each method, on the two medical databases, is given in table 18.3; the proposed methods were compared to an early [24] and a late fusion method [14], and to the other two multimodal information retrieval methods we proposed [15, 16], as well. For both databases, we obtain a mean precision at five greater than 80%: it means that, on average, more than four cases out of the five cases retrieved by the system are relevant for the query.

Model	DRD	DDSM
<i>Early fusion</i> [24]	42.8%	71.4%
<i>Late fusion</i> [14]	39.4%	70.3%
<i>Decision trees</i> [15]	81.0%	92.9%
<i>Bayesian networks</i> [16]	70.4%	82.1%
Shafer's model	74.3%	77.3%
Shafer's model + Bayesian networks	80.8%	80.3%
Hybrid DS _m model	78.6%	82.1%
Hybrid DS _m model + Bayesian networks	81.8%	84.8%

Table 18.3: Mean precision at five for each method.

Clearly, simple early or late fusion methods are inappropriate to retrieve patient records efficiently: in the rest of the section, we will focus on the other methods.

The mean computation time required to retrieve the five most similar cases, using each method, is given in table 18.4. All experiments were conducted using an AMD Athlon 64-bit based computer running at 2 GHz. Most of the time is spent during the computation of the image signatures. However, note that, if the wavelet coefficient distributions are simply modeled by histograms, the time required to compute the signatures can be greatly reduced (0.25 s instead of 4.57 s for DRD, 2.21 s instead of 35.89 s for DDSM).

To study the robustness of these methods, with respect to missing values, the following procedure has been carried out:

- for each case x_j in the database, $j = 1..N$, 100 new cases are generated as follows. Let n_j be the number of features available for x_j , each new case is obtained by removing a number of features randomly selected in $\{0, 1, \dots, n_j\}$.
- we plot the precision at five according to the number of available features for each generated case (see figure 18.6).

Database	DRD	DDSM
computing the signatures (for 1 image)	4.57 s	35.89 s
computing the distance with each image signature in the database (for 1 image)	0.033 s	1.14 s
<i>mean retrieval time (decision trees [15])</i>	<i>17.24 s</i>	<i>99.50 s</i>
<i>mean retrieval time (Bayesian networks [16])</i>	<i>40.12 s</i>	<i>148.23 s</i>
mean retrieval time (Shafer's model)	32.21 s	148.13 s
mean retrieval time (Shafer's model + Bayesian networks)	40.58 s	148.27 s
mean retrieval time (Hybrid DS _m model)	33.02 s	149.94 s
mean retrieval time (Hybrid DS _m model + Bayesian networks)	40.77 s	150.01 s

Table 18.4: Computation times.

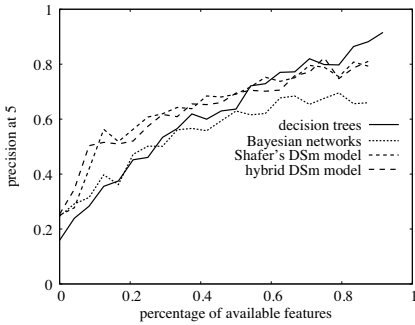

(a) DRD

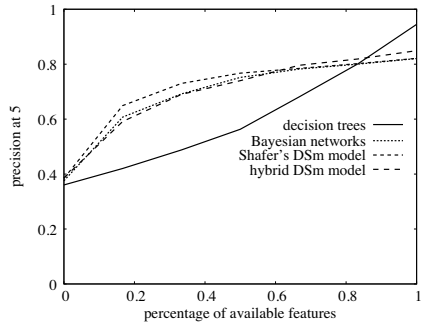

(b) DDSM

Figure 18.6: Robustness with respect to missing values.

We can see from these plots that, using the two DS_mT based methods, a satisfying precision at five can be obtained faster, as new features are available, than if using the decision tree based method. However, when the patient records are complete, the decision tree based method is more efficient. It is the case for DDSM, in which there are no missing information (see table 18.3). With the proposed methods, a sufficient precision can be reached before all the features are inputted by the user. As a consequence, the user can stop formulating his query when the returned results are satisfactory. On DRD for instance, a precision at five of 60% can be reached after inputting less than 30% of the features (see figure 18.6): with this precision, the majority of the retrieved cases (3 out of 5) belong to the right class.

18.6 Discussion and conclusion

In this chapter, we introduced two methods to include image sequences, with contextual information, in a CBR system. The first method is based on a Shafer's model consisting of two hypotheses. It is used to assess the relevance of each case in the database, independently, for the query. The second model is based on a hybrid DS_m model consisting of N hypotheses, one for each case in the database. This model takes into account the similarities between cases in the database, to better assess their relevance for the query. Whatever the model used, the same similarity measure, between any case in the database and the query, is defined for each feature. Then, based on these similarity measures, a belief mass function, modeling our confidence in each feature, is designed. Finally, these belief mass functions are fused, in order to estimate the relevance of a case in the database for the query, as a consensus between all the available case features. For both models, a PCR rule of combination was used to fuse the belief mass functions. For Shafer's model, a new rule of combination, with a time complexity evolving polynomially with the number of sources is introduced in appendix 18.8. For the hybrid DS_m model, a new encoding of the elements in the Dedekind lattice is proposed to allow the computation of the PCR5 rule of combination. The use of a Bayesian network is proposed to improve the management of unavailable features. These methods are generic: they can be extended to databases containing sound, video, etc: the wavelet transform based signature, presented in section 18.3.1, can be applied to any n -dimensional digital signal, using its n -dimensional wavelet transform ($n = 1$ for sound, $n = 3$ for video, etc). The methods are also convenient for they do not require being trained each time a new case is added to the database.

These methods have been successfully applied to two medical image data-bases, for computer aided diagnosis. For this application, the goal of the retrieval system is to select the five patient records, in a database, maximizing the similarity with the record of a new patient, examined by a physician. On both databases, a higher mean precision at five is obtained with the hybrid DSMT model than with Shafer's model. The mean precision at five obtained for DRD (81.8%) is particularly interesting, considering the few examples available, the large number of unavailable features and the large number of classes taken into account. On this database, the methods outperform usual methods [14, 24] by almost a factor of 2 in precision. The improvement is also noticeable on DDSM (84.8% compared to 71.4%). On this database, these DSMT based methods are less precise than a previously proposed decision tree based method [15]. However, we showed that a satisfying precision at five can be obtained faster, as new features are available, using the DSMT based methods: this is interesting in a medical application, where patient records are sometimes incomplete. As a conclusion, the results obtained on both medical databases show that the system is precise enough to be used in a diagnosis aid system.

18.7 References

- [1] A. Aamodt, *Case-Based Reasoning: Foundational Issues, Methodological Variations, and System Approaches*, AI Communications, Vol. 7, No. 1, pp. 39-59, 1994.
- [2] S. Antani, L.R. Long, G.R. Thoma, *A biomedical information system for combined content-based retrieval of spine x-ray images and associated text information*, Proc. of the Indian Conference on Computer Vision, Graphics, and Image Processing, pp. 242-247, Ahmadabad, India, December 16-18, 2002.
- [3] J.C. Bezdek, *Fuzzy Mathematics in Pattern Classification*, Ph.D. thesis, Applied Math. Center, Cornell University, Ithaca, NY, U.S.A., 1973.
- [4] I. Bichindaritz, C. Marling, *Case-based reasoning in the health sciences: What's next?*, Artificial Intelligence in Medicine, Vol. 36, No. 2, pp. 127-135, 2006.
- [5] E. Bruno, N. Moenne-Loccoz, S. Marchand-Maillet, *Design of multimodal dissimilarity spaces for retrieval of video documents*, IEEE Transactions on Pattern Analysis and Machine Intelligence, Vol. 30, No. 9, pp. 1520-1533, 2008.
- [6] J.-M. Cauvin, C. Le Guillou, B. Solaiman, M. Robaszekiewicz, P. Le Beux, C. Roux, *Computer-assisted diagnosis system in digestive endoscopy*, IEEE Transactions on Information Technology in Biomedicine, Vol. 7, No. 4, pp. 256-262, 2003.
- [7] J. Dezert, F. Smarandache, M. Daniel, *A generalized pignistic transformation*, in F. Smarandache and J. Dezert (editors): *Advances and Applications of DSMT*

- for Information Fusion, chapter 7, pp. 143-153, American Research Press, 2004.
<http://www.gallup.unm.edu/~smarandache/DSMT-book1.pdf>.
- [8] M.N. Do, M. Vetterli, *Wavelet-based texture retrieval using generalized Gaussian density and Kullback-Leibler Distance*, IEEE Transactions on Image Processing, Vol. 11, No. 2, pp. 146-158, 2002.
- [9] M. Heath, K. Bowyer, D. Kopans, R. Moore, W.P. Kegelmeyer, *The Digital Database for Screening Mammography*, Proc. of the Fifth International Workshop on Digital Mammography (IWDM 2000), M.J. Yaffe (editor), pp. 212-218, Medical Physics Publishing, 2001.
- [10] M. Lamard, G. Cazuguel, G. Quellec, L. Bekri, C. Roux, B. Cochener, *Content Based image retrieval based on Wavelet Transform Coefficients distribution*, Proc. of the 29th annual international conference of IEEE Engineering in Medicine and Biology Society (EMBS 2007), pp. 4532-4535, Lyon, France, August 23-26, 2007.
- [11] C. Le Bozec, E. Zapletal, M.C. Jaulent, D. Heudes, P. Degoulet, *Towards content-based image retrieval in a HIS-integrated PACS*, Proc. of the Annual Symposium of the American Society for Medical Informatics (AMIA 2000), pp. 477-481, Los Angeles, CA, U.S.A., November 4-8, 2000.
- [12] A. Martin, C. Osswald, *A new generalization of the proportional conflict redistribution rule stable in terms of decision*, in F. Smarandache and J. Dezert (editors): *Advances and Applications of DSMT for Information Fusion II*, chapter 2, pp. 69-88, American Research Press, 2006.
<http://www.gallup.unm.edu/~smarandache/DSMT-book2.pdf>.
- [13] H. Müller, N. Michoux, D. Bandon, A. Geissbuhler, *A review of content-based image retrieval systems in medical applications - clinical benefits and future directions*, International Journal of Medical Informatics, Vol. 73, No. 1, pp. 1-23, 2004.
- [14] R. Nuray, F. Can, *Automatic ranking of information retrieval systems using data fusion*, Information Processing and Management, Vol. 42, No. 3, pp. 595-614, 2006.
- [15] G. Quellec, M. Lamard, L. Bekri, G. Cazuguel, B. Cochener, C. Roux, *Recherche de cas médicaux multimodaux à l'aide d'arbres de décision*, Ingénierie et Recherche BioMédicale (IRBM), Vol. 29, No. 1, pp. 35-43, 2008.
- [16] G. Quellec, M. Lamard, L. Bekri, G. Cazuguel, C. Roux, B. Cochener, *Multimodal Medical Case Retrieval using Bayesian Networks and the Dezert-Smarandache Theory*, Proc. of the Fifth IEEE International Symposium on Biomedical Imaging (ISBI 2008), pp. 245-248, Paris, France, May 14-17, 2008.

- [17] G. Quellec, M. Lamard, P.M. Josselin, G. Cazuguel, B. Cochener, C. Roux, *Optimal wavelet transform for the detection of microaneurysms in retina photographs*, IEEE Transactions on Medical Imaging, Vol. 27, No. 9, pp. 1230-1241, 2008.
- [18] Hong Shao, Wen-Cheng Cui, Hong Zhao, *Medical Image Retrieval Based on Visual Contents and Text Information*, Proc. of the IEEE International Conference on Systems, Man and Cybernetics (SMC 2004), pp. 1098-1103, The Hague, The Netherlands, October 10-13, 2004.
- [19] F. Smarandache, J. Dezert, *Proportional Conflict Redistribution Rules for Information Fusion*, in F. Smarandache and J. Dezert (editors): *Advances and Applications of DSMT for Information Fusion II*, chapter 1, pp. 3-68, American Research Press, 2006. <http://www.gallup.unm.edu/~smarandache/DSMT-book2.pdf>.
- [20] A.W.M. Smeulders, M. Worring, S. Santini, A. Gupta, R. Jain, *Content-based image retrieval at the end of the early years*, IEEE Transactions on Pattern Analysis and Machine Intelligence, Vol. 22, No. 12, pp. 1349-1380, 2000.
- [21] R.K. Srihari, A. Rao, B. Han, S. Munirathnam, X. Wu, *A model for multimodal information retrieval*, Proc. of the IEEE International Conference on Multimedia and Expo (ICME 2000), pp. 701-704, New York City, NY, U.S.A., 30 July - 2 August, 2000.
- [22] J. Venn, *On the Diagrammatic and Mechanical Representation of Propositions and Reasonings*, Dublin Philosophical Magazine and Journal of Science, Vol. 9, No. 59, pp. 1-18, 1880.
- [23] C. Wilkinson, F. Ferris, R. Klein et al., *Proposed international clinical diabetic retinopathy and diabetic macular edema disease severity scales*, Ophthalmology, Vol. 110, No. 9, pp. 1677-1682, 2003.
- [24] D.R. Wilson, T.R. Martinez, *Improved Heterogeneous Distance Functions*, Journal of Artificial Intelligence Research, Vol. 6, pp. 1-34, 1997.
- [25] G.V. Wouwer, P. Scheunders, D.V. Dyck, *Statistical texture characterization from discrete wavelet representations*, IEEE Transactions on Image Processing, Vol. 8, No. 4, pp. 592-598, 1999.
- [26] S. Wu, S. McClean, *Performance prediction of data fusion for information retrieval*, Information Processing and Management, Vol. 42, No. 4, pp. 899-915, 2006.

18.8 Appendix: PCR rule with polynomial complexity

In this appendix, we focus on frames of discernment consisting of two hypotheses $\Theta = \{\theta_1, \theta_2\}$. We make no assumptions on the model used for the fusion problem: it can either be Shafer’s model, the free DS_m model or a hybrid DS_m model. We propose, in section 18.8.1, an algorithm to compute the conjunctive rule $m_{\cap}(X), \forall X \in D^{\Theta}$ (see equation 18.11), whose complexity evolves polynomially with the number of sources s .

$$m_{\cap}(X) = \sum_{(X_1, \dots, X_s) \in (D^{\Theta})^s, X_1 \cap \dots \cap X_s = X} \prod_{i=1}^s m_i(X_i) \tag{18.11}$$

Then we propose a new PCR rule, based on the same principle, in section 18.8.2. Let $k_{12\dots s}$ be the total conflicting mass:

$$k_{12\dots s} = \sum_{(X_1, \dots, X_s) \in (D^{\Theta})^s, X_1 \cap \dots \cap X_s = \emptyset} \prod_{i=1}^s m_i(X_i) \tag{18.12}$$

Each term in this sum is called a partial conflicting mass. The principle of the PCR rules is to redistribute the total conflicting mass $k_{12\dots s}$ (PCR1, PCR2) or the partial conflicting masses (PCR3, ..., PCR6) between the sets $X_c \in D^{\Theta}$ involved in the conflict [12, 19]. The conflict is redistributed to each set X_c proportionally to their belief mass. We illustrate the PCR5 rule on the following problem with two hypotheses and two sources. Suppose for instance that θ_1 and θ_2 are exclusive, as a consequence $m_{PCR5}(\theta_1 \cap \theta_2) = 0$ and $k_{12} = m_1(\theta_1)m_2(\theta_2) + m_1(\theta_2)m_2(\theta_1)$. So $m_1(\theta_1)m_2(\theta_2)$ is redistributed between $m_{PCR5}(\theta_1)$ and $m_{PCR5}(\theta_2)$ proportionally to $m_1(\theta_1)$ and $m_2(\theta_2)$, respectively. Similarly, $m_1(\theta_2)m_2(\theta_1)$ is redistributed between $m_{PCR5}(\theta_1)$ and $m_{PCR5}(\theta_2)$ proportionally to $m_2(\theta_1)$ and $m_1(\theta_2)$, respectively. Indeed, $\theta_1 \cup \theta_2$ is not involved in the conflict. As a consequence, we obtain the following fused mass function:

$$\left\{ \begin{array}{l} m_{PCR5}(\emptyset) = m_{PCR5}(\theta_1 \cap \theta_2) = 0 \\ m_{PCR5}(\theta_1) = m_{\cap}(\theta_1) + \frac{m_1(\theta_1)}{m_1(\theta_1)+m_2(\theta_2)} m_1(\theta_1)m_2(\theta_2) \\ \quad + \frac{m_2(\theta_1)}{m_2(\theta_1)+m_1(\theta_2)} m_2(\theta_1)m_1(\theta_2) \\ m_{PCR5}(\theta_2) = m_{\cap}(\theta_2) + \frac{m_2(\theta_2)}{m_1(\theta_1)+m_2(\theta_2)} m_1(\theta_1)m_2(\theta_2) \\ \quad + \frac{m_1(\theta_2)}{m_2(\theta_1)+m_1(\theta_2)} m_2(\theta_1)m_1(\theta_2) \\ m_{PCR5}(\theta_1 \cup \theta_2) = m_{\cap}(\theta_1 \cup \theta_2) \end{array} \right. \tag{18.13}$$

The algorithms we propose impose a constraint on the belief mass function m_i defined for each source $i = 1..s$ to fuse: only elements $X \in \{\theta_1, \theta_2, \theta_1 \cup \theta_2\}$ can have a non-zero mass. Nevertheless, the set $\theta_1 \cap \theta_2$ is taken into account within the rules of combination. The generalization to problems involving more hypotheses is discussed in section 18.8.3.

18.8.1 Algorithm for the conjunctive rule

Let m_1, m_2, \dots, m_s be the belief mass functions defined for each source of evidence. From the constraint above, a belief mass $m_i(X)$ is assigned to each element $X \in D^\ominus$ for each source $i = 1..s$ according to:

$$\begin{cases} m_i(\theta_1) + m_i(\theta_2) + m_i(\theta_1 \cup \theta_2) = 1 \\ m_i(\theta_1 \cap \theta_2) = 0 \end{cases} \tag{18.14}$$

Consequently, the conjunctive rule is simplified as follows:

$$m_{\cap}(X) = \sum_{(X_1, \dots, X_s) \in \{\theta_1, \theta_2, \theta_1 \cup \theta_2\}^s, X_1 \cap \dots \cap X_s = X} \prod_{i=1}^s m_i(X_i) \tag{18.15}$$

For a two-source problem, we obtain:

$$\begin{cases} m_{\cap}(\theta_1 \cup \theta_2) = m_1(\theta_1 \cup \theta_2)m_2(\theta_1 \cup \theta_2) \\ m_{\cap}(\theta_1) = m_1(\theta_1)m_2(\theta_1) + m_1(\theta_1)m_2(\theta_1 \cup \theta_2) + m_1(\theta_1 \cup \theta_2)m_2(\theta_1) \\ m_{\cap}(\theta_2) = m_1(\theta_2)m_2(\theta_2) + m_1(\theta_2)m_2(\theta_1 \cup \theta_2) + m_1(\theta_1 \cup \theta_2)m_2(\theta_2) \\ m_{\cap}(\theta_1 \cap \theta_2) = m_1(\theta_1)m_2(\theta_2) + m_1(\theta_2)m_2(\theta_1) \end{cases} \tag{18.16}$$

Let us interpret the computation of m_{\cap} graphically. For this purpose, we cluster the different products $p = \prod_{i=1}^s m_i(X_i), (X_1, \dots, X_s) \in \{\theta_1, \theta_2, \theta_1 \cup \theta_2\}^s$ according to:

- the number $n_1(p)$ of terms $m_i(\theta_1), i = 1..s$, in p ,
- the number $n_2(p)$ of terms $m_i(\theta_2), i = 1..s$, in p .

Precisely, we create a matrix T_s in which each cell $T_s(u, v)$ contains the sum of the products $p = \prod_{i=1}^s m_i(X_i), (X_1, \dots, X_s) \in \{\theta_1, \theta_2, \theta_1 \cup \theta_2\}^s$ such that $n_1(p) = u$ and $n_2(p) = v$. In the case $s = 1$ and $s = 2$, we obtain the matrices T_1 and T_2 , respectively, given in figure 18.7.

From figure 18.7 and equation 18.16, we can see that m_{\cap} can be computed from T_s :

$$\begin{cases} m_{\cap}(\theta_1 \cup \theta_2) = T_s(0, 0) \\ m_{\cap}(\theta_1) = \sum_{u=1}^s T_s(u, 0) \\ m_{\cap}(\theta_2) = \sum_{v=1}^s T_s(0, v) \\ m_{\cap}(\theta_1 \cap \theta_2) = \sum_{u=1}^s \sum_{v=1}^s T_s(u, v) \end{cases} \tag{18.17}$$

The structure of matrix T_s is illustrated on figure 18.8.

Equation 18.17 can be explained from equation 18.15 as follows:

- in cell $T_s(0, 0)$, the intersection of the propositions $X_1 \cap \dots \cap X_s$ is $\theta_1 \cup \theta_2$ because the product assigned to this cell does not contain any terms $m_i(\theta_1)$ or $m_i(\theta_2)$,
- in cells $T_s(u, 0), u \geq 1$, the intersection of the propositions $X_1 \cap \dots \cap X_s$ is θ_1 because each product assigned to these cells contains at least one term $m_i(\theta_1)$ (u terms, precisely) and does not contain any term $m_i(\theta_2)$,

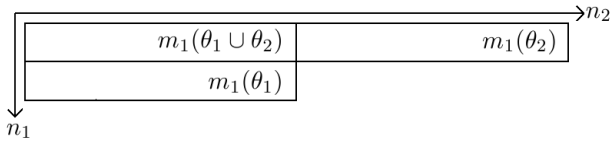

(a) T_1

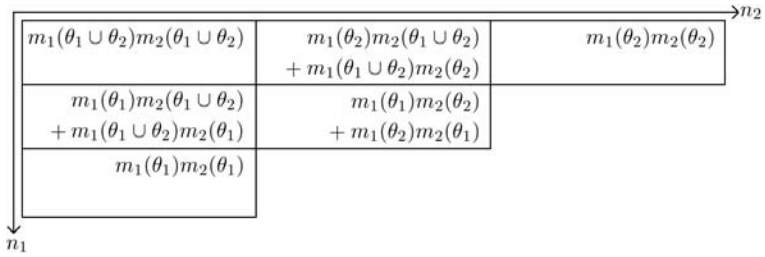

(b) T_2

Figure 18.7: Matrices T_1 and T_2

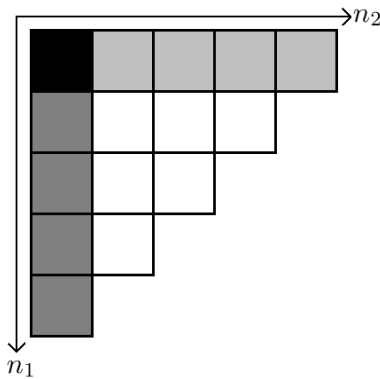

Figure 18.8: Structure of matrix T_s . According to equation 18.17, the black cells, the dark gray cells, the light gray cells and the white cells contain the belief mass assigned to $\theta_1 \cup \theta_2$, θ_1 , θ_2 and $\theta_1 \cap \theta_2$, respectively.

- in cells $T_s(0, v)$, $v \geq 1$, the intersection of the propositions $X_1 \cap \dots \cap X_s$ is θ_2 because each product assigned to these cells contains at least one term $m_i(\theta_2)$ (v terms, precisely) and does not contain any term $m_i(\theta_1)$,
- in cells $T_s(u, v)$, $u, v \geq 1$, the intersection of the propositions $X_1 \cap \dots \cap X_s$ is $\theta_1 \cap \theta_2$ because each product assigned to these cells contains at least one term $m_i(\theta_1)$ (u terms, precisely) and at least one term $m_i(\theta_2)$ (v terms, precisely).

From equation 18.17, we see that if T_s can be built in a time polynomial in s , then m_\cap can also be computed in a time polynomial in s .

We describe below an algorithm to build T_j from T_{j-1} in a time polynomial in j , $j = 2..s$. Its principle is illustrated on figure 18.9, in the case $j = 2$. We first compute three intermediate matrices $T_j^{\theta_1}$, $T_j^{\theta_2}$ and $T_j^{\theta_1 \cup \theta_2}$:

$$T_j^{\theta_1}(u, v) = \begin{cases} T_{j-1}(u-1, v) \times m_j(\theta_1), & u = 1..j, v = 0..j \\ 0, & u = 0, v = 0..j \end{cases} \quad (18.18)$$

$$T_j^{\theta_2}(u, v) = \begin{cases} T_{j-1}(u, v-1) \times m_j(\theta_2), & u = 0..j, v = 1..j \\ 0, & u = 0..j, v = 0 \end{cases} \quad (18.19)$$

$$T_j^{\theta_1 \cup \theta_2}(u, v) = T_{j-1}(u, v) \times m_j(\theta_1 \cup \theta_2), \quad u = 0..j, v = 0..j \quad (18.20)$$

T_j is then obtained as the sum of the three matrices:

$$T_j = T_j^{\theta_1} + T_j^{\theta_2} + T_j^{\theta_1 \cup \theta_2} \quad (18.21)$$

We first check that all the products $\prod_{i=1}^j m_i(X_i)$, $X_1, \dots, X_j \in \{\theta_1, \theta_2, \theta_1 \cup \theta_2\}$ are generated by this procedure (hypothesis $\mathcal{H}_1(j)$). Then we check that these products appear in the correct cell of T_j (hypothesis $\mathcal{H}_2(j)$). Both hypothesis are checked by induction.

1. *Basis*: hypotheses $\mathcal{H}_1(1)$ and $\mathcal{H}_2(1)$ can be easily checked on figure 18.7 (a).
2. Suppose hypothesis $\mathcal{H}_1(j-1)$ is true. Each term $p = \prod_{i=1}^j m_i(X_i)$, $(X_1, \dots, X_j) \in \{\theta_1, \theta_2, \theta_1 \cup \theta_2\}^j$, can be written as the product of a term $q = \prod_{i=1}^{j-1} m_i(X_i)$, $(X_1, \dots, X_{j-1}) \in \{\theta_1, \theta_2, \theta_1 \cup \theta_2\}^{j-1}$, which appears in T_{j-1} , according to hypothesis $\mathcal{H}_1(j-1)$, and a belief mass m : m is either $m_j(\theta_1)$, $m_j(\theta_2)$ or $m_j(\theta_1 \cup \theta_2)$. According to m , p appears either in $T_j^{\theta_1}$, or in $T_j^{\theta_2}$, or in $T_j^{\theta_1 \cup \theta_2}$ (see equations 18.18, 18.19 and 18.20). As a consequence, p appears in T_j (see equation 18.21): hypothesis $\mathcal{H}_1(j)$ is true.
3. Suppose hypothesis $\mathcal{H}_2(j-1)$ is true. Let $p = \prod_{i=1}^j m_i(X_i)$, $(X_1, \dots, X_j) \in \{\theta_1, \theta_2, \theta_1 \cup \theta_2\}^j$. If X_j is θ_1 , then by definition of n_1 and n_2 , $n_1(p) = n_1(\frac{p}{m_j(\theta_1)}) + 1$ and $n_2(p) = n_2(\frac{p}{m_j(\theta_1)})$. According to equation 18.18, p appears in $T_j^{\theta_1}$ (and in T_j , consequently) one row below $\frac{p}{m_j(\theta_1)}$ in T_{j-1} . Since $\frac{p}{m_j(\theta_1)}$ appears in the correct cell of T_{j-1} (hypotheses $\mathcal{H}_2(j-1)$), p appears in the correct cell of T_j . A similar reasoning is applied if X_j is θ_2 (using equation 18.19) or $\theta_1 \cup \theta_2$ (using equation 18.20). As a consequence, hypothesis $\mathcal{H}_2(j)$ is true.

To compute T_j from T_{j-1} , $3\binom{j+1}{2}$ multiplications are required. Therefore, $\frac{3}{2} \sum_{j=1}^s j(j+1) = O(s^3)$ multiplications are required to compute T_s : the complexity of the proposed algorithm is polynomial in s .

18.8.2 Proposed PCR rule of combination

If hypotheses θ_1 and θ_2 are exclusive, then the belief mass assigned to $\theta_1 \cap \theta_2$ by the conjunctive rule is conflicting: $k_{12\dots s} = m_{\cap}(\theta_1 \cap \theta_2)$. $\theta_1 \cup \theta_2$ is not involved in the conflict, as a consequence $k_{12\dots s}$ should be redistributed between θ_1 and θ_2 . In view of the number of partial conflicting masses $\prod_{i=1}^s m_i(X_i)$, $(X_1, \dots, X_s) \in \{\theta_1, \theta_2, \theta_1 \cup \theta_2\}^s$, which is exponential in s , it is impossible to redistribute them individually (according to the PCR5 rule, for instance), if s is large. On the other hand, one could redistribute the total conflicting mass $k_{12\dots s}$ (according to the PCR2 rule, for instance). Anyway a better solution is possible, taking advantage of the algorithm above: the conflicting mass can be redistributed more finely using matrix T_s .

As we build matrix T_s with the algorithm above, we compute in each cell c the percentages $p_1(c)$ and $p_2(c)$ of the belief mass in c that should be assigned to θ_1 and θ_2 , respectively, in case of conflict. These percentages are initialized according to equation 18.22.

$$\begin{cases} p_1(T_1(0, 0)) = p_1(T_1(0, 1)) = 0 \\ p_1(T_1(1, 0)) = 1 \\ p_2(T_1(0, 0)) = p_2(T_1(1, 0)) = 0 \\ p_2(T_1(0, 1)) = 1 \end{cases} \quad (18.22)$$

At iteration j , after computing $T_j^{\theta_1}(u, v) = T_{j-1}(u-1, v) \times m_j(\theta_1)$, we compute for $u+v > 1$ and $u+v \leq j$:

$$\begin{cases} p_1(T_j^{\theta_1}(u, v)) = \frac{p_1(T_{j-1}(u-1, v))T_{j-1}(u-1, v) + m_j(\theta_1)}{T_{j-1}(u-1, v) + m_j(\theta_1)} \\ p_2(T_j^{\theta_1}(u, v)) = \frac{p_2(T_{j-1}(u-1, v))T_{j-1}(u-1, v)}{T_{j-1}(u-1, v) + m_j(\theta_1)} \end{cases} \quad (18.23)$$

Similarly, after computing $T_j^{\theta_2}(u, v) = T_{j-1}(u, v-1) \times m_j(\theta_2)$, we compute for $u+v > 1$ and $u+v \leq j$:

$$\begin{cases} p_1(T_j^{\theta_2}(u, v)) = \frac{p_1(T_{j-1}(u, v-1))T_{j-1}(u, v-1)}{T_{j-1}(u, v-1) + m_j(\theta_2)} \\ p_2(T_j^{\theta_2}(u, v)) = \frac{p_2(T_{j-1}(u, v-1))T_{j-1}(u, v-1) + m_j(\theta_2)}{T_{j-1}(u, v-1) + m_j(\theta_2)} \end{cases} \quad (18.24)$$

Then, after computing $T_j(u, v) = T_j^{\theta_1}(u, v) + T_j^{\theta_2}(u, v) + T_j^{\theta_1 \cup \theta_2}(u, v)$, we compute for $u+v > 1$ and $u+v \leq j$:

$$\left\{ \begin{array}{l} p_1(T_j(u, v)) = \beta(u, v) \left(p_1(T_{j-1}(u, v)) + \frac{p_1(T_j^{\theta_1}(u, v))T_j^{\theta_1}(u, v) + p_1(T_j^{\theta_2}(u, v))T_j^{\theta_2}(u, v)}{T_j^{\theta_1}(u, v) + T_j^{\theta_2}(u, v)} \right) \\ p_2(T_j(u, v)) = \beta(u, v) \left(p_2(T_{j-1}(u, v)) + \frac{p_2(T_j^{\theta_1}(u, v))T_j^{\theta_1}(u, v) + p_2(T_j^{\theta_2}(u, v))T_j^{\theta_2}(u, v)}{T_j^{\theta_1}(u, v) + T_j^{\theta_2}(u, v)} \right) \end{array} \right. \quad (18.25)$$

$\beta(u, v)$ is a normalization factor, chosen so that $p_1(T_j(u, v)) + p_2(T_j(u, v)) = 1 \forall u, v$. Finally, the belief mass in each cell $(T_s(u, v))_{u>0, v>0}$ is redistributed between θ_1 and θ_2 proportionally to $p_1(T_s(u, v))$ and $p_2(T_s(u, v))$, respectively.

Note that, for a two-source problem, the proposed rule of combination is equivalent to PCR5. The only cell of T_2 involved in the conflict is $T_2(1, 1)$ (see figure 18.9 (e)), as a consequence, the mass redistributed to θ_1 and θ_2 is $m'_1 = p_1(T_2(1, 1))(T_2^{\theta_1}(1, 1) + T_2^{\theta_2}(1, 1))$ and $m'_2 = p_2(T_2(1, 1))(T_2^{\theta_1}(1, 1) + T_2^{\theta_2}(1, 1))$, respectively.

$$p_1(T_2^{\theta_1}(1, 1)) = \frac{p_1(T_1(0,1))T_1(0,1) + m_2(\theta_1)}{T_1(0,1) + m_2(\theta_1)} = \frac{m_2(\theta_1)}{m_1(\theta_2) + m_2(\theta_1)} \quad (18.26)$$

$$p_2(T_2^{\theta_1}(1, 1)) = \frac{p_2(T_1(0,1))T_1(0,1)}{T_1(0,1) + m_2(\theta_1)} = \frac{m_1(\theta_2)}{m_1(\theta_2) + m_2(\theta_1)} \quad (18.27)$$

$$p_1(T_2^{\theta_2}(1, 1)) = \frac{p_1(T_1(1,0))T_1(1,0)}{T_1(1,0) + m_2(\theta_2)} = \frac{m_1(\theta_1)}{m_1(\theta_1) + m_2(\theta_2)} \quad (18.28)$$

$$p_2(T_2^{\theta_2}(1, 1)) = \frac{p_2(T_1(1,0))T_1(1,0) + m_2(\theta_2)}{T_1(1,0) + m_2(\theta_2)} = \frac{m_2(\theta_2)}{m_1(\theta_1) + m_2(\theta_2)} \quad (18.29)$$

From equation 18.25 (with $p_1(T_1(1, 1)) = p_2(T_1(1, 1)) = 0$), we obtain the following expression for m'_1 and m'_2 :

$$\left\{ \begin{array}{l} m'_1 = p_1(T_2^{\theta_1}(1, 1))T_2^{\theta_1}(1, 1) + p_1(T_2^{\theta_2}(1, 1))T_2^{\theta_2}(1, 1) \\ m'_2 = p_2(T_2^{\theta_1}(1, 1))T_2^{\theta_1}(1, 1) + p_2(T_2^{\theta_2}(1, 1))T_2^{\theta_2}(1, 1) \end{array} \right. \quad (18.30)$$

$$\left\{ \begin{array}{l} m'_1 = \frac{m_2(\theta_1)}{m_1(\theta_2) + m_2(\theta_1)} m_1(\theta_2) m_2(\theta_1) + \frac{m_1(\theta_1)}{m_1(\theta_1) + m_2(\theta_2)} m_1(\theta_1) m_2(\theta_2) \\ m'_2 = \frac{m_1(\theta_2)}{m_1(\theta_2) + m_2(\theta_1)} m_1(\theta_2) m_2(\theta_1) + \frac{m_2(\theta_2)}{m_1(\theta_1) + m_2(\theta_2)} m_1(\theta_1) m_2(\theta_2) \end{array} \right. \quad (18.31)$$

which is what we obtained for PCR5 (see equation 18.13).

The proposed PCR rule is compared qualitatively with other rules of combination, on a two-source problem supposing hypotheses θ_1 and θ_2 incompatible, in table 18.5.

The number of operations required to compute $p_1(c)$ and $p_2(c)$, for each cell c in T_s , is proportional to the number of operations required to compute T_s . Once p_1 and p_2 have been computed, the number of operations required to redistribute the conflicting mass is proportional to $\frac{s(s-1)}{2}$ (the number of white cells in figure 18.8). As a consequence, the complexity of this algorithm is also polynomial in s . It is thus applicable to a large class of fusion problems: for instance, it is applied to a problem involving 24 sources of evidence in section 18.5.1.

$m_1(\theta_1 \cup \theta_2)$	$m_1(\theta_2)$
$m_1(\theta_1)$	

(a) $T_1(u, v)$

0	0
$m_1(\theta_1 \cup \theta_2)m_2(\theta_1)$	$m_1(\theta_2)m_2(\theta_1)$
$m_1(\theta_1)m_2(\theta_1)$	

(b) $T_2^{\theta_1}(u, v) = T_1(u - 1, v) \times m_2(\theta_1)$

0	$m_1(\theta_1 \cup \theta_2)m_2(\theta_2)$	$m_1(\theta_2)m_2(\theta_2)$
0	$m_1(\theta_1)m_2(\theta_2)$	

(c) $T_2^{\theta_2}(u, v) = T_1(u, v - 1) \times m_2(\theta_2)$

$m_1(\theta_1 \cup \theta_2)m_2(\theta_1 \cup \theta_2)$	$m_1(\theta_2)m_2(\theta_1 \cup \theta_2)$
$m_1(\theta_1)m_2(\theta_1 \cup \theta_2)$	

(d) $T_2^{\theta_1 \cup \theta_2}(u, v) = T_1(u, v) \times m_2(\theta_1 \cup \theta_2)$

$m_1(\theta_1 \cup \theta_2)m_2(\theta_1 \cup \theta_2)$	$m_1(\theta_2)m_2(\theta_1 \cup \theta_2)$ $+ m_1(\theta_1 \cup \theta_2)m_2(\theta_2)$	$m_1(\theta_2)m_2(\theta_2)$
$m_1(\theta_1)m_2(\theta_1 \cup \theta_2)$ $+ m_1(\theta_1 \cup \theta_2)m_2(\theta_1)$	$m_1(\theta_1)m_2(\theta_2)$ $+ m_1(\theta_2)m_2(\theta_1)$	
$m_1(\theta_1)m_2(\theta_1)$		

(e) $T_2(u, v) = T_2^{\theta_1}(u, v) + T_2^{\theta_2}(u, v) + T_2^{\theta_1 \cup \theta_2}(u, v)$

Figure 18.9: Computation of T_2 from T_1 .

set	$\theta_1 \cup \theta_2$	θ_1	θ_2	$\theta_1 \cap \theta_2$
m_1	0.7	0.1	0.2	0
m_2	0.3	0.4	0.3	0
conjunctive rule	0.21	0.35	0.33	0.11
Dempster's rule	0.24	0.39	0.37	0
PCR2	0.21	0.405	0.385	0
PCR5	0.21	0.411	0.379	0
proposed PCR rule	0.21	0.411	0.379	0

Table 18.5: Qualitative comparison with other rules of combination.

The memory requirements for the proposed rule of combination are also interesting compared to PCR5: $\left(7\frac{s(s+1)}{2} + 3\frac{(s-1)s}{2}\right) \times 8$ bytes for the proposed method (which corresponds to the cumulated size of matrices T_s , $p_1(T_s)$, $p_2(T_s)$, $p_1(T_s^{\theta_1})$, $p_2(T_s^{\theta_1})$, $p_1(T_s^{\theta_2})$, $p_2(T_s^{\theta_2})$, T_{s-1} , $p_1(T_{s-1})$ and $p_2(T_{s-1})$: the largest amount of memory needed at the same time), compared to $3^s \times 8$ for PCR5, if we use double precision real numbers.

18.8.3 Conclusion

In this appendix, we proposed an algorithm to compute the conjunctive rule in a time evolving polynomially with the number of sources. From this first algorithm, we derived a new Proportional Conflict Redistribution (PCR) rule of combination with a similar complexity. This rule is equivalent to the PCR5 rule for two-source problems (it is also equivalent to PCR6, in this case [12]). We restricted our algorithms to fusion problems consisting of two hypotheses: our goal was to reduce the complexity regarding the number of sources. However, the same principle could be applied to problems consisting of n hypotheses, using n -dimensional matrices.

Chapter 19

Fusion of ESM allegiance reports using DS_mT

Pascal Djiknavorian
EE Department, Laval University,
Québec, QC, Canada, G1V 0A6.
pascal@djiknavorian.com

Pierre Valin
Defence R&D Canada Valcartier
Québec, QC, Canada, G3J 1X5.
pierre.valin@drdc-rddc.gc.ca

Dominic Grenier
EE Department, Laval University,
Québec, QC, Canada, G1V 0A6.
dominic.grenier@gel.ulaval.ca

Abstract: *Electronic Support Measures consist of passive receivers which can identify emitters coming from a small bearing angle, which, in turn, can be related to platforms that belong to 3 classes: either Friend, Neutral, or Hostile. Decision makers prefer results presented in STANAG 1241 allegiance form, which adds 2 new classes: Assumed Friend, and Suspect. Dezert-Smarandache theory (DS_mT) is particularly suited to this problem, since it allows for intersections between the original 3 classes. In this way, an intersection of Friend and Neutral can lead to an Assumed Friend, and an intersection of Hostile and Neutral can lead to a Suspect. Results are presented showing that the theory can be successfully applied to the problem of associating ESM reports to established tracks, and its results identify when miss-associations have occurred and to what extent. Results are also compared to Dempster-Shafer theory (DST) which can only reason on the original 3 classes. Thus decision makers are offered STANAG 1241 allegiance results in a timely manner, with quick allegiance change when appropriate and stability in allegiance declaration otherwise.*

19.1 Background

Electronic Support Measures (ESM) consists of passive receivers which can identify emitters coming from a small bearing angle, but cannot determine range (although some are in development to provide a rough measure of range). The detected emitters can be related to platforms that belong to 3 classes: either Friend ($F = 1$), Neutral ($N = 2$) or Hostile ($H = 3$), heretofore called ESM-allegiance, within that bearing angle.

In the case of dense targets, ESM allegiance can fluctuate wildly due to miss-associations of an ESM report to established track. Hence, decision makers would like the target platforms to be identified on a more refined basis, belonging to 5 classes: Hostile (or Foe), Suspect (S), Neutral, Assumed Friend (AF), and Friend, since they realize that no fusion algorithm can be perfect and would prefer some stability in an allegiance declaration, rather than oscillations between extremes. This will heretofore be referred to as STANAG 1241 allegiance (or STANAG-allegiance for short).

With this more refined STANAG-allegiance, a decision maker would probably take no aggressive action against either a friend or an assumed friend (although he would monitor an assumed friend more closely). Similarly a decision maker would probably take aggressive action against a foe and send a reconnaissance force (or a warning salvo) towards a suspect. Neutral platforms would correspond to countries not involved in the current conflict, or to commercial airliners.

All incoming sensor declarations correspond to a frame of discernment of 3 classes, and several theories exist to treat a series of such declarations to obtain a fused result in the same frame of discernment, like Bayesian reasoning and Dempster-Shafer (DS) reasoning (often called evidence theory). However, when the output frame of discernment is larger than the input frame of discernment, an interpretation has to be made as to what this could mean, or how that could be generated. This is the subject of the next sub-section.

19.1.1 An interpretation of STANAG 1241

Both Bayes and Dempster-Shafer assume that the universe of discourse remains fixed (at 3 singletons “Hostile”, “Neutral”, and “Friend”), and is the same for the input declarations and the fused output results, after repeated use of their respective combining rules.

However, there exists a new theory called Dezert-Smarandache theory which can coherently, with well-defined fusion rules, lead to an output amongst 5 classes, even though the input classes number only 3, because the theory allows for intersections. For example, “Suspect” might be the result obtained after fusing “Hostile” with “Neutral” (although other possibilities also exist), and “Assumed Friend” might be the result obtained after fusing “Friend” with “Neutral” (although again other possibilities also exist).

This is illustrated in the Venn diagram of Figure 19.1.

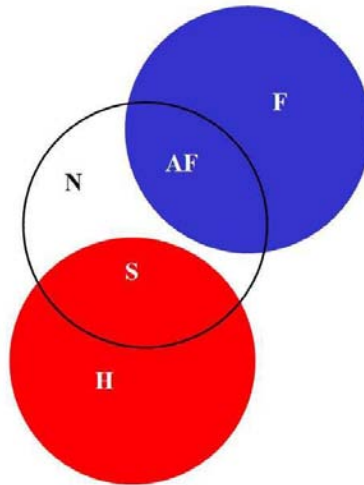

Figure 19.1: Venn diagram for the STANAG allegiances.

19.1.2 Another interpretation of STANAG 1241

The interpretation in the preceding sub-section is a conservative one, namely that there is only one easy way to become suspect. This could correspond to a decision maker being in a non-threatening situation due to the choice of mission, e.g. peace-keeping. There could be situations where there is a need for a more aggressive response. In the case of a combat mission for example, the appropriate Venn diagram might be the one of Figure 19.2, where there are many more ways to become suspect, namely all the intersections bordering Hostile.

Note that for Figure 19.1, the intersection of Friend = θ_1 and Hostile = θ_3 is empty (i.e. not allowed, or $\theta_1 \cap \theta_3 = \emptyset$, the null set), and this corresponds to an interesting constraint situation in Dezert-Smarandache theory, as we shall see. It also corresponds to a more likely mission for Canadian Forces (CF), namely peace-keeping, or general surveillance.

On the other hand, Figure 19.2 corresponds to a combat situation more appropriate for the U.S.A., or to the CF as long as they play an active role in the Kandahar region of Afghanistan. For these reasons, and also because all of the features of Dezert-Smarandache theory will be exercised, without the additional complexity of keeping all the intersections of Figure 19.2, the situation of Figure 19.1 will correspond to the one implemented in this chapter.

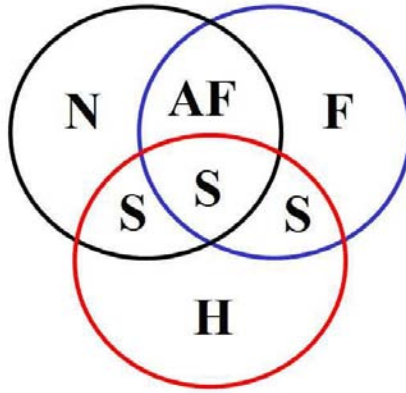

Figure 19.2: Another possible Venn diagram for the STANAG allegiances.

19.2 Dezert-Smarandache theory

19.2.1 Formulae for DST and DS_mT

Since Dempster-Shafer (DS) Theory (DST) has been in use for over 40 years, the reader is assumed to be familiar with it. Only a brief review will be provided here, in order to stress the difference between it and Dezert-Smarandache (DS_m) Theory (DS_mT). DS_mT encompasses DST as a special case, namely when all intersections are null. Both use the language of masses assigned to each declaration from a sensor (in our case the ESM sensor). A declaration is a set made up of singletons of the frame of discernment Θ , and all sets that can be made from them through unions are allowed (this is referred to as the power set 2^Θ). In DS_mT, all unions and intersections are allowed for a declaration, thus forming the much larger hyper-power set D^Θ . For our special case of cardinality 3, $\Theta = \{\theta_1, \theta_2, \theta_3\}$, with $|\Theta| = 3$, D^Θ is still of manageable size:

$$\begin{aligned}
 D^\Theta (|\Theta| = 3) \equiv & \{ \{\emptyset\}, \{\theta_1\}, \{\theta_2\}, \{\theta_3\}, \{\theta_1 \cup \theta_2\}, \{\theta_1 \cup \theta_3\}, \{\theta_2 \cup \theta_3\}, \\
 & \{\theta_1 \cap \theta_2\}, \{\theta_1 \cap \theta_3\}, \{\theta_2 \cap \theta_3\}, \{(\theta_1 \cup \theta_2) \cap \theta_3\}, \{(\theta_1 \cup \theta_3) \cap \theta_2\}, \\
 & \{(\theta_2 \cup \theta_3) \cap \theta_1\}, \{(\theta_1 \cap \theta_2) \cup \theta_3\}, \{(\theta_1 \cap \theta_3) \cup \theta_2\}, \{(\theta_2 \cap \theta_3) \cup \theta_1\}, \\
 & \{\theta_1 \cap \theta_2 \cap \theta_3\}, \{\theta_1 \cup \theta_2 \cup \theta_3\}, \{(\theta_1 \cap \theta_2) \cup (\theta_1 \cap \theta_3) \cup (\theta_2 \cap \theta_3)\} \}.
 \end{aligned}$$

For larger cardinalities, the hyper-power set makes computations prohibitively expensive (in CPU time) as the following table summarizes (the cardinal of D^Θ follows the Dedekind sequence, and both 2^Θ and D^Θ include the null set):

Cardinal of Θ	2	3	4	5	6
Cardinal of 2^Θ	4	8	16	32	64
Cardinal of D^Θ	5	19	167	7580	7828353

Table 19.1: Cardinalities for DST vs DSMT.

This is one of the reasons why this application is well suited to DSMT, because a low cardinality of Θ (three) generates a cardinality in DSMT which is computationally feasible (nineteen).

In DST, a combined “fused” mass is obtained by combining the previous (presumably the results of previous fusion steps) $m_1(A)$ with a new $m_2(B)$ to obtain a new fused result as follows:

$$(m_1 \oplus m_2)(C) = \frac{1}{1 - K_\cap} \sum_{A \cap B = C} m_1(A) m_2(B) \quad \forall C \subseteq \Theta \quad (19.1)$$

The renormalization step using the conflict K_\cap , corresponding to the sum of all masses for which the set intersection yields the null set, is a critical feature of DST, and allows for it to be associative, whereas a multitude of alternate ways of redistributing the conflict (proposed by numerous authors) lose this property. The associativity within the DST is key when the time tags of the sensor reports are unreliable, since associative rules are impervious to a different order of reports coming in, but all others rules can be extremely sensitive to the order of reports. This is the main reason we concentrate only on DST vs. DSMT, but another reason is the ridiculous proliferation of alternatives to DST.

In DSMT, the hybrid rule (called DSMT in [4]) appropriate for constraints such as described previously (corresponding to Figure 19.1) turns out to be much more complicated:

$$m_{\mathcal{M}(\Theta)}(X) \triangleq \phi(X) [S_1(X) + S_2(X) + S_3(X)] \quad (19.2)$$

where all sets involved in formulas are in canonical form and where $\phi(X)$ is the characteristic non-emptiness function of a set X , i.e. $\phi(X) = 1$ if $X \notin \emptyset$ and $\phi(X) = 0$ otherwise, where $\emptyset \triangleq \{\emptyset_{\mathcal{M}}, \emptyset\}$. $\emptyset_{\mathcal{M}}$ is the set of all elements of D^Θ which have been forced to be empty through the constraints of the model \mathcal{M} and \emptyset is the classical/universal empty set. $S_1(X)$, $S_2(X)$ and $S_3(X)$ are defined by

$$S_1(X) \triangleq \sum_{\substack{X_1, X_2 \in D^\Theta \\ X_1 \cap X_2 = X}} \prod_{i=1}^2 m_i(X_i) \quad (19.3)$$

$$S_2(X) \triangleq \sum_{\substack{X_1, X_2 \in \emptyset \\ [\mathcal{U}=X] \vee [(\mathcal{U} \in \emptyset) \wedge (X=I_t)]}} \prod_{i=1}^2 m_i(X_i) \tag{19.4}$$

$$S_3(X) \triangleq \sum_{\substack{X_1, X_2 \in D^\emptyset \\ X_1 \cup X_2 = X \\ X_1 \cap X_2 \in \emptyset}} \prod_{i=1}^2 m_i(X_i) \tag{19.5}$$

with $\mathcal{U} \triangleq u(X_1) \cup u(X_2) \cup \dots \cup u(X_s)$ where $u(X)$ is the union of all θ_i that compose X and $I_t \triangleq \theta_1 \cup \theta_2 \cup \dots \cup \theta_n$ is the total ignorance. The reader is referred to a series of books on DSMT [4, 5] for lengthy descriptions of the meaning of this formula. A three-step approach [3] is proposed in the second of these books [4, 5], which is used in this chapter. From now on, the term “hybrid” will be dropped for simplicity.

If the incoming sensor reports are in DST-space Friend ($F = 1$), Neutral ($N = 2$) or Hostile ($H = 3$), then Figure 19.1 has the interpretation in DSMT fused space (allowing intersections) is:

$$\begin{aligned} \{\theta_1 - \theta_1 \cap \theta_2\} &= \text{Friend} \\ \{\theta_3 - \theta_3 \cap \theta_2\} &= \text{Hostile} \\ \{\theta_1 \cap \theta_2\} &= \text{Assumed Friend} \\ \{\theta_2 \cap \theta_3\} &= \text{Suspect} \\ \{\theta_2 - \theta_1 \cap \theta_2 - \theta_2 \cap \theta_3\} &= \text{Neutral} \end{aligned}$$

As expected, all STANAG-allegiances (masses assigned to the sets mentioned above) sum up to 1. Hence the first line of eq.(19.6)¹, which is the sum for all 5 considered classes of STANAG 1241, yields the second line after using the DSMT cardinality criterion (with a multiplying factor of -1 for each non-null intersection) and since $\theta_1 \cap \theta_3 = \emptyset$ by construction of Figure 19.1.

$$\begin{aligned} \theta_1 - \theta_1 \cap \theta_2 + \theta_3 - \theta_3 \cap \theta_2 + \theta_1 \cap \theta_2 + \theta_2 \cap \theta_3 + \theta_2 - \theta_1 \cap \theta_2 - \theta_3 \cap \theta_2 \\ = \theta_1 + \theta_2 + \theta_3 - \theta_1 \cap \theta_2 - \theta_3 \cap \theta_2 = 1 \end{aligned} \tag{19.6}$$

19.2.2 A typical simulation scenario

In order to compare DST with DSMT, one must list the pre-requisites that the scenario must address. It must:

1. be able to adequately represent the known ground truth,

¹In eq. (19.6), we use a concise notation for the masses, i.e. θ_1 means $m(\theta_1)$, etc.

2. contain sufficient countermeasures (or miss-associations) to be realistic and to test the robustness of the theories,
3. only provide partial knowledge about the ESM sensor declaration, which therefore contains uncertainty,
4. be able to show stability under countermeasures, yet
5. be able to switch allegiance when the ground truth does so.

The following scenario parameters have therefore been chosen accordingly:

1. Ground truth is FRIEND for the first 50 iterations of the scenario and HOSTILE for the last 50.
2. The number of correct associations is 80%, corresponding to countermeasures appearing 20% of the time, in a randomly selected sequence.
3. The ESM declaration has a mass (confidence value in Bayesian terms) of 0.7, with the rest (0.3) being assigned to the ignorance (the full set of elements, namely Θ).

Items 4 and 5 of the first list would translate into stability (item 4) for the first 50 iterations and eventual stability (item 4) for the last 50 iterations after the allegiance switch at iteration 50 (item 5).

This scenario will be the one addressed in the next section, while a Monte-Carlo study is described in the subsequent section. Each Monte-Carlo run corresponds to a different realization using the above scenario parameters, but with a different random seed.

The scenario chosen is depicted in Figure 19.3 below.

Roughly 80% of the time the ESM declares the correct allegiance according to ground truth, and the remaining 20% is roughly equally split between the other two allegiances. There is an allegiance switch at the 50th iteration, and the selected randomly selected seed in the above generated scenario generates a rather unusual sequence of 4 false Friend declarations starting at iteration 76 (when actually Hostile is the ground truth), which will be very challenging for the theories.

19.3 Results for the simulated scenario

Before presenting the results for DST, it should be noted that the original form of DST tends to be overly optimistic. Given enough evidence concerning an allegiance, it will be very hard for it to change allegiances at iteration 50. This is a well-known problem, and a well-known *ad hoc* solution exists, and consists in renormalizing after each fusion step by giving a value to the complete ignorance which can never be below

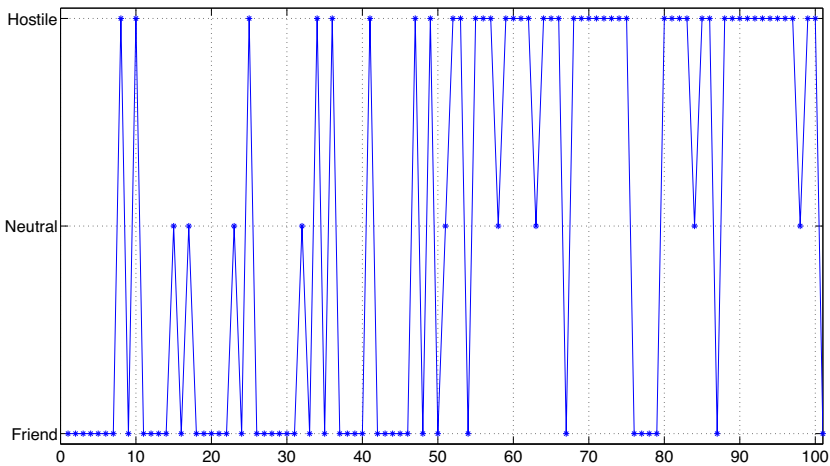

Figure 19.3: Chosen scenario.

a certain factor (chosen here to be 0.02). A comparison will be made with DSMT and the Proportional Conflict Redistribution rule number 5 (PCR5) preferred by Dezert and Smarandache.

19.3.1 DST results

The result for DST is shown in Figure 19.4 below.

DST never becomes confused, reaches the ESM-allegiance quickly and maintains it until iteration 50. It then reacts reasonably rapidly and takes about 6 reports before switching allegiance as it should. Furthermore after being confused for an iteration around the sequence of 4 Friend reports starting at iteration 76, it quickly reverts to the correct Hostile status.

Note that a decision maker could look at this curve and see an oscillation pointing to miss-associations without being able to clearly distinguish between a miss-association with the other two possible allegiances. This fairly quick reaction is due to the 0.02 assigned to the ignorance, which translates to DST never being more than 98% sure of an ESM-allegiance, as can be seen by the curve topping out at 0.98. The Figure 19.4 shows the mass, which is also the pignistic probability for this case, with the latter being normally used to make a decision.

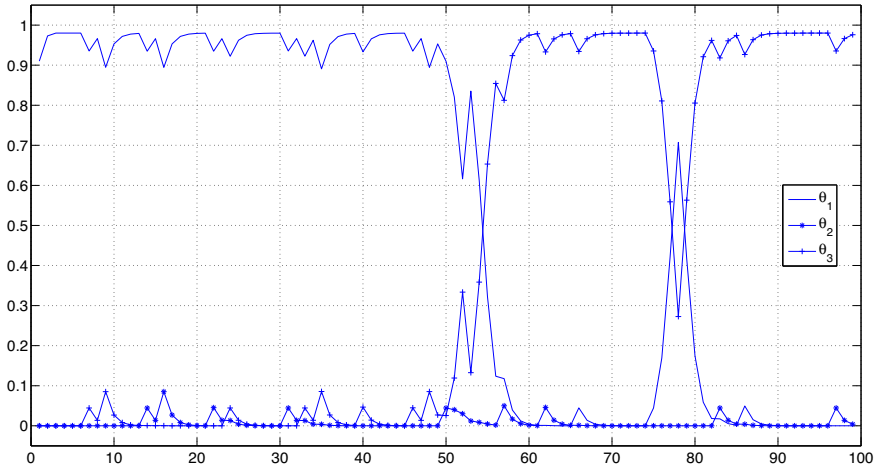

Figure 19.4: DST result for the chosen scenario. Masses in function of time.

19.3.2 DSMT results

For the hybrid rule of the DSMT, it was suggested to use the Generalized Pignistic Probability [4] in order to make a decision on a singleton belonging to the input ESM-allegiance. This seems to cause problems [1]. Since the whole idea behind using DSMT was to present the results to the decision maker in the STANAG-allegiance format, the result of Figure 19.5 would be shown to the decision maker.

The decision maker would clearly be informed that miss-associations have occurred, since Assumed Friend dominates for the first 50 iterations and Suspect for the latter 50. DSMT is more susceptible to miss-associations than DST (the dips are more pronounced), but it has the advantage of giving extra information to the decision maker, namely that the fusion algorithm is having difficulty with associating ESM reports to established tracks.

Just like DST, the 4 Friend declarations starting at iteration 76 cause confusion, as it should. The change in allegiance at iteration 50 is detected nearly as fast as DST. What is even more important is that F and AF are clearly preferred for the first 50 iterations and S and H for the last 50, as they should.

19.3.3 PCR5 results

PCR5 shows a similar behaviour, but is much less sure of what's going on (the peaks are not as pronounced), as seen in Figure 19.6. Again, F and AF are clearly preferred for the first 50 iterations and S and H for the last 50, as they should.

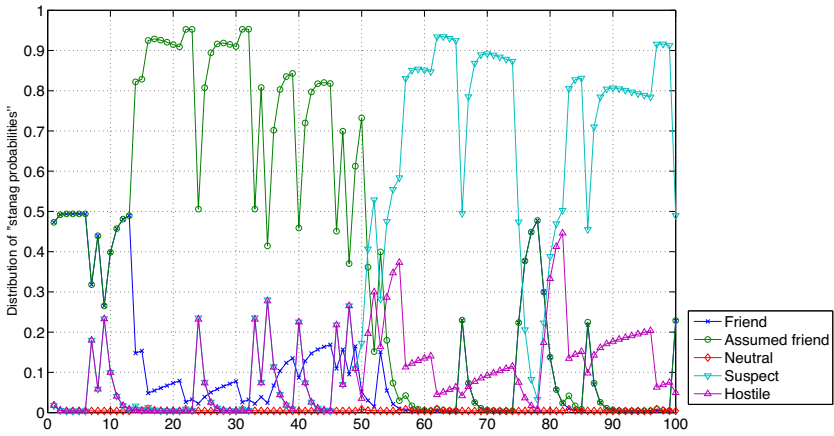

Figure 19.5: DSMT result for the chosen scenario.

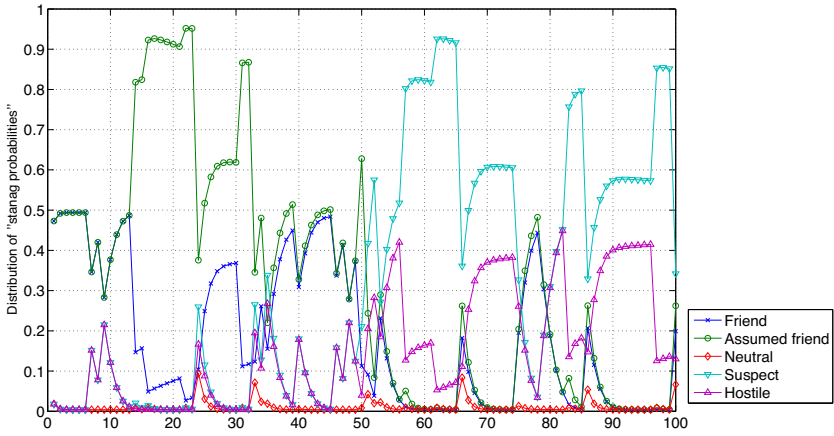

Figure 19.6: PCR5 result for the chosen scenario.

19.3.4 Decision-making threshold

Because of the sometimes oscillatory nature of some combination rules, one has to ask oneself when to make a decision or recommend one to the commander. This is

illustrated in figure 19.7 for DST although the same is applicable for all the others. A threshold at a very secure 90% would result in a longer time for allegiance change, and result in a longer period of indecision around iteration 76, compared to one at 70%.

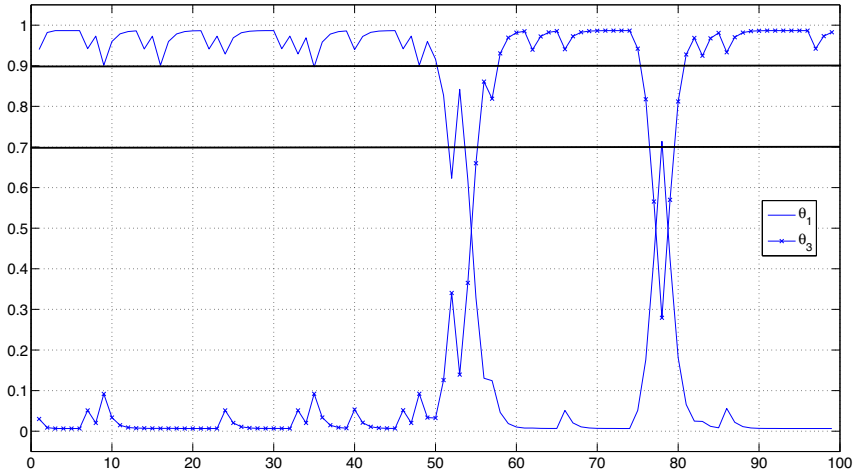

Figure 19.7: Decision thresholds. Masses in function of time.

19.4 Monte-Carlo results

Although a special case such as the one described in the previous section offers valuable insight, one might question if the conclusions from that one scenario pass the test of multiple Monte-Carlo scenarios. This question is answered in this section.

In order to sample the parameter space in a different way, the simulations below correspond to 90% correct associations (higher than the previous 80%), an ESM confidence at 60% (lower than the previous 70%) and an ignorance threshold at 0.02 as before. The number of Monte-Carlo runs was set to 100.

19.4.1 DST results

The result for DST is shown in Figure 19.8. As expected, since DST reasons over the 3 input classes, Suspect and Assumed Friend are not involved. Naturally, since Assumed Friend and Suspect do not exist in DST, these are calculated as zero. Friend, Neutral and Hostile have the expected behaviour. One sees the same response times,

after an average over 100 runs, as was seen in the selected scenario of the previous section.

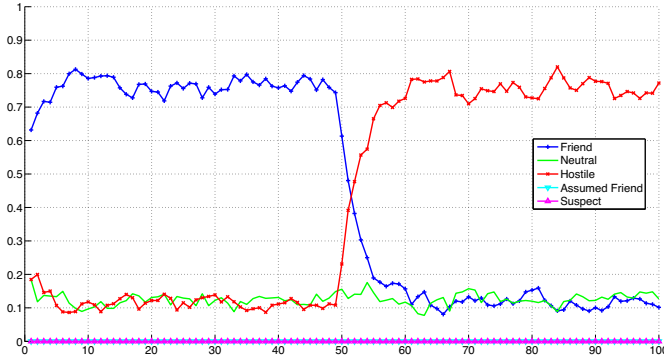

Figure 19.8: DST result after 100 Monte-Carlo runs. *Stanag* probabilities in function of time.

19.4.2 DSMT results

The similar result for DSMT is shown in Figure 19.9. In this case, AF dominates for the first 50 iteration, on average (over 100 runs) and S for the last 50, confirming that the chosen scenario was representative of the behaviour of DSMT. The response times are similar on average also. DSMT is slightly less sure (plateau at 70%) than DST (plateau at 80%), but this can be adjusted by lowering the decision threshold accordingly.

19.4.3 PCR5 results

Finally, the PCR5 result is shown in Figure 19.10. In this case also, AF dominates for the first 50 iterations, on average (over 100 runs), and S for the last 50, confirming that the chosen scenario was representative of the behaviour of PCR5. The response times are similar on average also. PCR5 is slightly less sure (plateau at 60%) than DST (plateau at 80%) or DSMT (plateau at 70%).

19.4.4 Effect of varying the ESM parameters

In order to study the effects of varying the ESM parameters, the simulations below correspond to an ESM confidence at 80% (higher than the previous 60%) and an ignorance threshold at 0.05 (higher than the 0.02 used previously). The number of

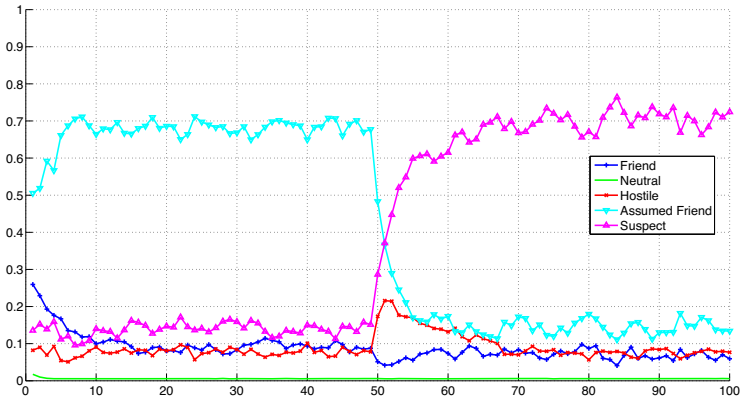

Figure 19.9: DSMT result after 100 Monte-Carlo runs. *Stanag* probabilities in function of time.

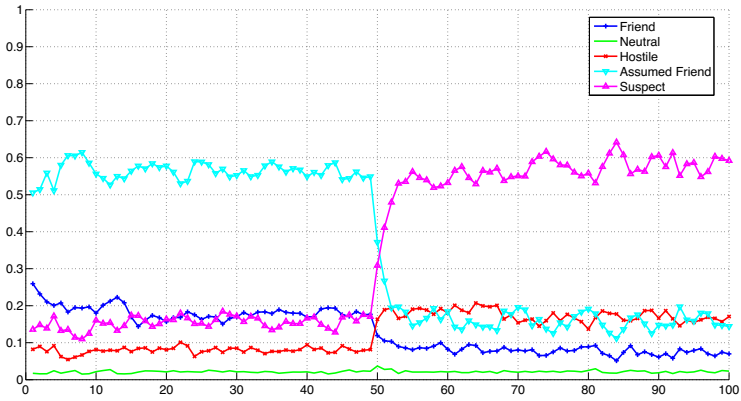

Figure 19.10: PCR5 result after 100 Monte-Carlo runs. *Stanag* probabilities in function of time.

Monte-Carlo runs was again set to 100.

A filter was also applied to the input ESM declarations over a window of 4 iterations then assigns lesser confidence to ESM reports which are not well represented in the window. The results are shown in Figure 19.11 for DST, Figure 19.12 for DSMT and Figure 19.13 for PCR5. From these figures, one can see the smoothing effect of the filter, but more importantly all of the conclusions of the previous Monte-Carlo

runs, as well as the selected scenario of the previous section hold in their totality.

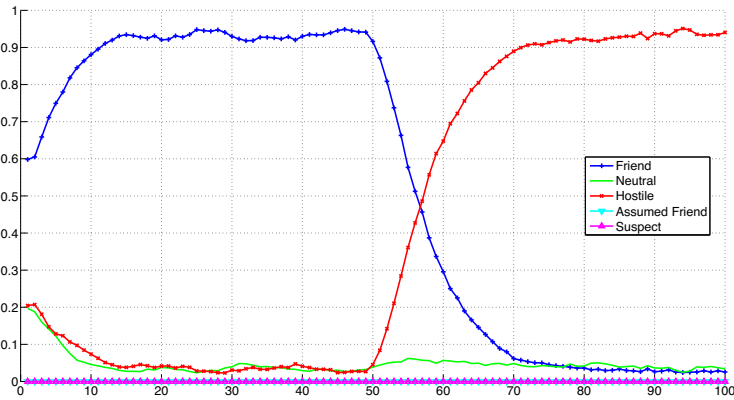

Figure 19.11: DST result after 100 Monte-Carlo runs and input filter. *Stanag* probabilities in function of time.

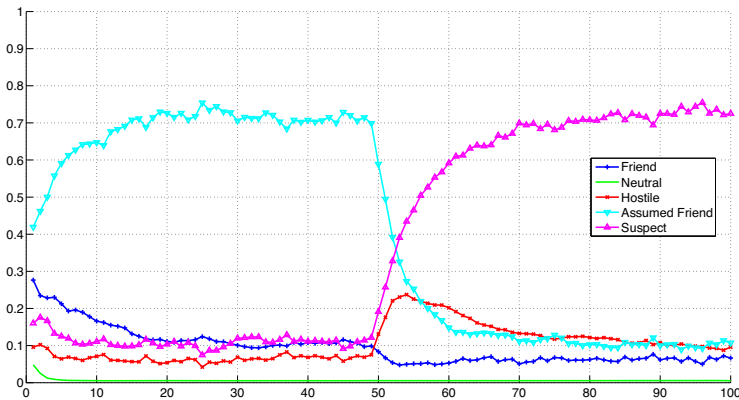

Figure 19.12: DS_mH result after 100 Monte-Carlo runs and input filter. *Stanag* probabilities in function of time.

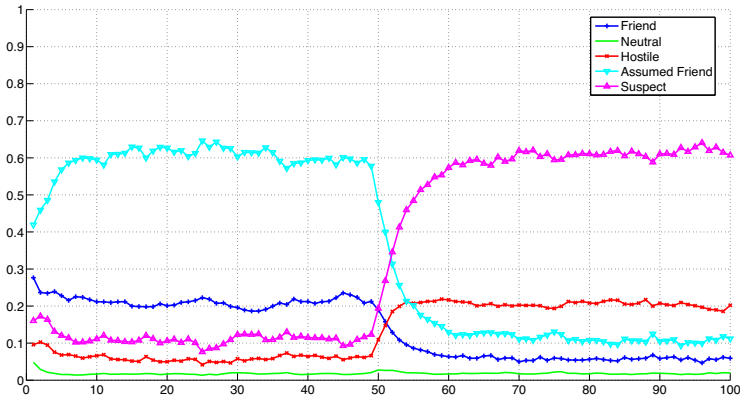

Figure 19.13: PCR5 result after 100 Monte-Carlo runs and input filter. *Stanag* probabilities in function of time.

19.5 Conclusions

Because of the nature of Electronic Support Measures which consist of passive receivers that can identify emitters coming from a small bearing angle, and which, in turn, can be related to platforms that belong to 3 classes: either Friend, Neutral, or Hostile, and to the fact that decision makers would prefer results presented in STANAG 1241 allegiance form, which adds 2 new classes: Assumed Friend, and Suspect, Dezert-Smarandache theory was used instead, but also compared to Dempster-Shafer theory. In DSMT an intersection of Friend and Neutral can lead to an Assumed Friend, and an intersection of Hostile and Neutral can lead to a Suspect. Recent results were presented showing that the theory can be successfully applied to the problem of associating ESM reports to established tracks confirming the work published in [2]. Results are also compared to Dempster-Shafer theory which can only reason on the original 3 classes. Thus decision makers are offered STANAG 1241 allegiance results in a timely manner, with quick allegiance change when appropriate and stability in allegiance declaration otherwise. In more details, results were presented for a typical scenario and for Monte-Carlo runs with the same conclusions, namely that Dempster-Shafer works well over the original 3 classes, if a minimum to the ignorance is applied. The same can be said for Dezert-Smarandache hybrid rule, and to a lesser extent for a popular Proportional Conflict Redistribution rule, but with the added benefit that Dezert-Smarandache theory identifies when miss-associations occur, and to what extent.

19.6 References

- [1] P. Djiknavorian, *Fusion d'informations dans un cadre de raisonnement de Dezert-Smarandache appliquée sur des rapports de capteurs ESM sous le STANAG 1241*, Mémoire de maîtrise, Université Laval, 2008.
- [2] P. Djiknavorian, D. Grenier, P. Valin, *Analysis of information fusion combining rules under the DSMT theory using ESM input*, ISIF Fusion 2007 Conference, Québec, Canada, July 2007.
- [3] P. Djiknavorian, D. Grenier, *Reducing DSMT hybrid rule complexity through optimisation of the calculation algorithm*, Chapter 15 in [5], 2006.
- [4] F. Smarandache, J. Dezert (Editors), *Advances and Applications of DSMT for Information Fusion.*, Vol. 1, American Research Press, 2004.
- [5] F. Smarandache, J. Dezert (Editors), *Advances and Applications of DSMT for Information Fusion.*, Vol. 2, American Research Press, 2006.

Chapter 20

Object identification using T-conorm/norm fusion rule

Albena Tchamova¹
IPP, Bulgarian Academy of Sciences,
"Acad. G. Bonchev" Str., bl. 25-A,
1113 Sofia, Bulgaria.
tchamova@bas.bg

Jean Dezert
ONERA/DTIM/SIF,
29 Avenue de la Division Leclerc,
92320 Châtillon, France.
jean.dezert@onera.fr

Florentin Smarandache
Chair of Math. & Sciences Dept.,
University of New Mexico, 200 College Road,
Gallup, NM 87301, U.S.A.
smarand@unm.edu

Abstract: *This small chapter presents an approach providing fast reduction of total ignorance in the process of target identification. It utilizes the recently defined fusion rule based on fuzzy T-conorm/T-norm operators, as well as all the available information from the adjoint sensor and additional information obtained from the a priori defined objective and subjective considerations, concerning relationships between the attribute components at different levels of abstraction. The approach performance is estimated on the base of the pignistic probabilities according to the nature of the objects considered here. The method shows better efficiency in comparison to the pure Dempster-Shafer theory based approach. It also allows to avoid the application of the Bayesian principle of indifference and improves the separation power of the decision process.*

1 - This work is partially supported by MONT grant MI-1506/05.

20.1 Introduction

Object identification is an important problem of considerable interest to many civilian and military sectors. In this chapter the process of object state recognition by an IFF (Identification Friend/Foe) sensor is examined. The information received from the sensor pertains to a single attribute: '*friend target*' (F). The absence of evidence (so-called response), however, does not a priori ensure 100 percents reliability for the hypothesis '*hostile target*' (H) and the problem of possible wrong target recognition arises. This problem is especially complicated when the moment of decision-making cannot be postponed. In this case, the total ignorance presence renders the probability of alternative hypotheses of '*friendly target*' or '*hostile target*' equally ambiguous and plausible. As a result, alternative decisions made on this basis pose an equal degree of risk. From the point of view of Dempster-Shafer theory (DST) [2, 4, 9], the proposition ought to be supported is: '*an availability of full ignorance*', i.e. $m(\Theta) = 1$. In Bayesian theory [1], according to the principle of indifference, this problem is handled by setting equal a priori probabilities to each alternative hypothesis. One way out of the described problem is to incorporate additional attribute information at a different level of abstraction from another disparate sensor [3, 5, 14]. For this reason, the IFF sensor is often adjoined with a radar or infrared sensor (IRS). Evidence from the additional sensor should help to resolve this dilemma. The measurement coordinates originating from a target moving in an air-traffic corridor is an example for such evidence. The measurement's spatial and spectral signal parameters are another example. Unfortunately, this information does not always provide an implicit answer at the time the question is posed (due to the sensors' technical particularities). A more expensive solution is to increase the number of sensors [3], but this often leads to increased conflicts between them. In such cases Dempster's rule yields unfortunately unexpected, counter-intuitive results [11].

In this work, one utilizes a new class of fusion rules introduced in [13] in the framework of Dezert-Smarandache Theory (DSmT) of plausible and paradoxical reasoning [11, 12]. Our approach is based on fuzzy T-conorm/T-norm operators and on all the available information - from the adjoint sensor (radar) and additional information obtained from a priori defined objective and subjective considerations concerning relationships between the attribute components at different levels of abstraction. In the next section we present briefly the main principles of fuzzy based T-Conorm/Norm (TCN) fusion rule. Then the proposed approach for object identification is described, tested and evaluated. Concluding remarks are given in the last section.

20.2 Approach description

- *The a priori dataBase definition.* The a priori database is realized as a fuzzy relation [7]. It takes into account the defined objective considerations connecting the components of some attributes expressed at different levels of abstraction (for example the fuzzy relation '*target type - target nature*'). For this purpose, it is defined:

- The set $X = \{x_1, x_2, \dots, x_{2^n-1}\}$, relating to the level of abstraction of the adjoint sensor (the object type $O_i, i = 1, 2, \dots, n$) corresponds to the Dempster-Shafer Theory power set 2^Θ .

$$x_1 = O_1, x_2 = O_2, \dots, X_n = O_n$$

$$x_{n+1} = O_1 \cup O_2, \dots$$

$$x_{2^n-1} = O_1 \cup O_2 \cup \dots \cup O_n$$

- The set Y corresponds to the level of abstraction of the base sensor ($Y = \{y_1 = \mathbf{F}(riend), y_2 = \mathbf{H}(ostile)\}$).
- The matrix $R : X \Rightarrow Y$ is a fuzzy relation with a membership function (MF): $\mu_R(x_k, y_l) \in [0, 1]; k = 1, 2, \dots, 2^n - 1; l = 1, 2$, where n is the number of considered object's types. The conditions that MF must satisfy according to the DSMT and DST are:

$$\sum_{k=1}^{2^n-1} \mu_R(x_k, y_l) = 1, l = 1, 2$$

- *Semantic transformation.* The information granule m_X pertaining to the object's type is transformed in a corresponding fuzzy set S_X :

$$\mu_{S_X}(x_k) = m_X(x_k), k = 1, \dots, (2^n - 1)$$

- *Application of Zadeh's compositional rule.* The image of the fuzzy set S_X through the particular mapping [15–17] is received. The output fuzzy set T_Y corresponds to the target's nature by means of:

$$\mu_{T_Y}(y_l) = \sup_{x_k \in X} \{ \min[\mu_R(y_l, x_k), \mu_{S_X}(x_k)] \}$$

where T_Y represents the non-implicit attribute information extracted from the measurement.

- *Inverse semantic transformation.* The fuzzy set T_Y is transformed into an information granule m_{Y_R} through a normalization of membership values with respect to the unity interval.
- *Application of the TCN rule of combination.* The TCN fusion rule introduced in [13] is described in section 15.5 of chapter 15 in this book and therefore it will not be presented in details here. It is used to combine two evidences: $m_X(\cdot)$ and m_{Y_R} . This aggregation immediately reduces the total ignorance with regard to the target's nature.
- *Decision making based on the pignistic probabilities.* The Generalized Pignistic Transformation [11] is used to take a rational decision about the target's nature within the DSMT framework:

$$P\{A\} = \sum_{X \in D^\Theta} \frac{C_M(X \cap A)}{C_M(X)} \cdot m(X), \forall A \in D^\Theta$$

The decision is taken by the maximum of the pignistic probability function P .

20.3 Simulation scenario and results

Sensor evidence defines a frame of discernment for the target's type: $\Theta = O_1, O_2, O_3$, where object O_1 means 'fighter', O_2 means 'airlift cargo', O_3 means 'bomber', and the target's nature: $H \subset O_1, O_3$ (Hostile), $F \subset O_2$ (Friend). The attribute components corresponding to these objects' types are the angular sizes A of objects' blips measured on the radar screen. In order to define the influence of these components on this problem, it is sufficient to know the specific features of their probabilistic 'behavior' and to assign fuzzy values to them. It is supposed that:

- the average \bar{A}_1 of the angular size A_1 corresponding to O_1 is the minimal value (\bar{A}_1 depends on the size of the elementary radar's volume A_V);
- the probability of the event this angular size will exceed the elementary radar's volume can be neglected (i.e. $P(A_1 > A_V) \approx 0$);
- the average \bar{A}_2 of the angular size A_2 , corresponding to target O_2 is the maximal one;
- the probability of the event that some realization of this stochastic variable A_2 will be lower than the angular size of the elementary radar's volume A_V can be neglected too (i.e. $P(A_2 < A_V) \approx 0$);
- the average \bar{A}_3 of the angular size A_3 , corresponding to the target O_3 , obeys to the relation $\bar{A}_1 < \bar{A}_3 < \bar{A}_2$;
- the probabilities $P(A_3 < A_V)$, $P(A_3 > A_2)$ cannot be neglected.

The worst case is when a hostile target is observed and the obtained respective radar blip has a medium angular size. It can originate from a target of any type, i.e. $\Theta = O_1 \cup O_2 \cup O_3$. This is the case, when the approach proposed here demonstrates its advantages in comparison with the DST based approach. The information granule is defined as:

$$\mathbf{m}_X = \{m_X(O_1) = 0.2 \quad m_X(O_2) = 0.2 \quad m_X(O_3) = 0.3 \quad m_X(\Theta) = 0.3\}$$

Also, the 'worst' evidence is obtained from the IFF-sensor (it has not received a response from the observed target):

$$\mathbf{m}_Y = \{m_Y(F) = 0 \quad m_Y(H) = 0 \quad m_Y(\Theta) = 1.0\}$$

If the DS rule of combination ($\mathbf{m}_X \oplus \mathbf{m}_Y$) is used to fuse these two sources of evidence, the result will not change the target nature estimate because of the effect of vacuous belief assignment.

- *Step 1.* For the considered example, the sets X and Y are:

$$X = \{O_1, O_2, O_3, O_1 \cup O_2, O_1 \cup O_3, O_2 \cup O_3, \Theta\}, \quad Y = \{F, H\}$$

R	$y_1 = F$	$y_2 = H$
$x_1 = O_1$	$\mu_R(O_1, F) = 0$	$\mu_R(O_1, H) = 0.3$
$x_2 = O_2$	$\mu_R(O_2, F) = 0.8$	$\mu_R(O_2, H) = 0.3$
$x_3 = O_3$	$\mu_R(O_3, F) = 0$	$\mu_R(O_3, H) = 0.3$
...	0	0
$x_5 = \Theta$	$\mu_R(\Theta, F) = 0.2$	$\mu_R(\Theta, H) = 0.1$

Table 20.1: Fuzzy relation for the database definition.

The a priori defined relation $R : X \Rightarrow Y$ (the particular database) is described in Table 20.1.

This relation is not arbitrarily chosen [10]. It is presumed that the information obtained from some particular schedule of civilian and military aircraft flights excludes flights of friendly fighters and bombers but allows planned flights of friendly civil passenger aircrafts and friendly military airlift operations. It is possible (but as it follows from the example, it is not recommendable) to make general inferences by using only this a priori information, because of the significant cost of the wrong decision 'target is friend'.

On the other hand, the uncertainty with respect to the hostile intentions imposes an equal distribution of the probabilities, concerning propositions for:

- a reconnaissance mission performed by a hostile fighter;
- an assault dropped by a hostile cargo aircraft;
- a strike mission performed by a hostile bomber.

Obviously, it is not realistic to expect an appearance of hostile targets, while the proposition for the alternative event possesses a high degree of probability

- *Step 2.* The evidence \mathbf{m}_X from the radar sensor is transformed in a fuzzy set S_X .
- *Step 3.* The image T_Y of the fuzzy set S_X , defined through the mapping R infers an information concerning target's nature as follows:

$$\mu_{T_Y}(y_1 = F) = 0.2 \quad \mu_{T_Y}(y_2 = H) = 0.3$$

- *Step 4.* The normalization procedure yields:

$$\mu_{T_Y}(y_1 = F) = 0.4 \quad \mu_{T_Y}(y_2 = H) = 0.6$$

It contains the non-implicit information about the target's nature in the radar measurement.

- *Step 5.* TCN fusion rule is used to combine the evidence \mathbf{m}_X and \mathbf{m}_{Y_R} . In accordance with the true nature of the problem (Shafer's model), the following integrity constraints are introduced:

$$O_1 \cap O_2 = \emptyset, \quad O_2 \cap O_3 = \emptyset, \quad O_1 \cap O_3 = \emptyset, \quad F \cap H = \emptyset$$

The conjunction of propositions gives:

$$O_1 \cap F = O_1 \cap O_2 = \emptyset$$

$$O_2 \cap F = O_2 \cap O_2 = O_2$$

$$O_3 \cap F = O_3 \cap O_2 = \emptyset$$

$$\Theta \cap F = O_2$$

$$O_1 \cap H = O_1$$

$$O_2 \cap H = F \cap H = \emptyset$$

$$O_3 \cap H = O_3$$

$$\Theta \cap H = H$$

By applying TCN fusion rule, the updated vector of masses of belief $\tilde{\mathbf{m}}_{upd}(\cdot)$ concerning both levels of abstraction (target's type and target's nature) is obtained below:

$$\tilde{\mathbf{m}}_{upd}(\cdot) = \begin{cases} \tilde{m}_{upd}(O_1) = 0.13 & \tilde{m}_{upd}(O_2) = 0.44 & \tilde{m}_{upd}(O_3) = 0.22 \\ \tilde{m}_{upd}(H = O_1 \cup O_3) = 0.21 \end{cases} \quad (20.1)$$

- *Step 6.* Finally, the pignistic probabilities are calculated in order to take decisions about the object's nature: $P(H) = 0.56$ $P(F) = 0.44$. Other pignistic probabilities of interest are: $P(O_1) = 0.235$ $P(O_3) = 0.355$. It is obvious that the evidence supporting propositions 'target type is O_1 ' and 'target type is O_3 ' increase the support for proposition 'Hostile target'. But the evidence for a target being 'Hostile target' does not increase the support for the proposition 'target type is O_1 ' or 'target type is O_3 '. These results illustrate and confirm the benefits we can expect from the application of the proposed approach.

For the completion of this study and to demonstrate its efficiency, two other possible radar measurements are considered: the possible presence of target type 'fighter' (and related to it 'bomber') or the possible presence of target type 'airlift cargo' (and related to it 'bomber'):

$$\mathbf{m}'_{X'}(\cdot) = \begin{cases} m_X(O_1) = 0.3 \\ m_X(O_2) = 0.2 \\ m_X(O_3) = 0.2 \\ m_X(O_1 \cup O_3) = 0.3 \\ m_X(\Theta) = 0 \end{cases} \quad \text{and} \quad \mathbf{m}''_{X''}(\cdot) = \begin{cases} m_X(O_1) = 0.2 \\ m_X(O_2) = 0.3 \\ m_X(O_3) = 0.2 \\ m_X(O_1 \cup O_3) = 0.3 \\ m_X(\Theta) = 0 \end{cases}$$

The measurement $\mathbf{m}'_{X'}(\cdot)$ supports the probability for 'hostile fighter', additionally increasing the corresponding pignistic probability $P(H) = 0.65$ and decreasing the opposite one $P(F) = 0.35$. The measurement $\mathbf{m}''_{X''}(\cdot)$ supports 'friend's airlift cargo', additionally increasing the pignistic probability $P(F) = 0.41$ and decreasing $P(H) = 0.59$. It can be noted that both probabilities tend toward each other due to the lack of more categorical evidence supporting 'Hostile'. The small difference remaining between them is due to the ambiguous evidence $O_2 \cap O_3$. The considered sub-case illustrates the single inefficient application of the proposed approach (but there is no reason to make categorical decisions if the available information does not provide any support for this).

In the alternative case of this example, when the target 'Friend' is considered, the numerical results remain the same. They support the wrong decision, but have to be ignored because of the obvious conflict with the air-traffic control's schedule. This schedule excludes the appearance of a 'friend's fighter' or a 'friend's bomber'. Generalizing, there is no reason to check these propositions due to the lack of IFF-sensor's answer and because of the arising serious conflict with the air-traffic control rules. The case of arriving measurement $\mathbf{m}''_{X''}(\cdot)$ is commented above as the single inefficient approach application.

The benefits of the proposed approach are also demonstrated in comparing the results with those obtained by the direct utilization of the mentioned database and TCN rule. For this purpose, the database consists of two separate databases (m^H_{DB} and m^F_{DB}) related with the propositions H and F respectively. Each database contains two columns (1,2 and 1,3 respectively). These granules can be used for the direct updating of $\mathbf{m}_X(\cdot)$ so as to check both alternatives: $\mathbf{m}_{X'} \oplus \mathbf{m}^H_{DB} = \mathbf{m}^H_{upd}$ and $\mathbf{m}_{X''} \oplus \mathbf{m}^F_{DB} = \mathbf{m}^F_{upd}$. The pignistic probabilities obtained for both alternatives are:

$$P^H_{upd}(H) = 0.61, P^H_{upd}(F) = 0.39, P^F_{upd}(H) = 0.41, P^F_{upd}(F) = 0.59$$

The obtained probabilities thus show some improvement from the initial total ignorance, however this improvement does not suffice in practical application due to the high similarity of the results for the pignistic probabilities $P^H_{upd}(H)$ and $P^F_{upd}(F)$.

20.4 Conclusions

A new approach for a fast reduction of the uncertainty in the process of object identification has been proposed. The new class of fusion rules based on fuzzy T-conorm/T-norm operators is used for reducing ignorance according to the object's nature. This approach which combines fuzzy set theory and DSMT, utilizes the information from the adjoint sensor and additional information obtained from a priori defined objective and subjective considerations. This forms a database representing a set of fuzzy relations, correlating some measurement components expressed at different levels of abstraction. This approach generates its results from all available information about the stochastic events considered in the database and it improves the separation power of the decision process which is based on the generalized pignistic transformation.

20.5 References

- [1] T. Bayes, *Essay toward solving a problem in the doctrine of changes*, Philosophical transactions on the royal society, London, 1763.
- [2] S. Blackman, R. Popoli, *Design and Analysis of Modern Tracking Systems*, Artech House, 1986.
- [3] Ph.L. Bogler, *Dempster-Shafer reasoning with applications to multisensor target identification systems*, IEEE Transactions on Systems, Man, and Cybernetics, SMC-17 (6), pp. 968–977, 1987.
- [4] A. Dempster, *A generalization of Bayesian inference*, Journal of the Royal Statistical Society, Series B, Vol. 30, pp. 205–247, 1968.
- [5] D. Hall, *Mathematical techniques in multisensor data fusion*, Artech house, 1992.
- [6] J. Lowrance, T. Garvey, *Evidential reasoning: an implementation for multisensor integration*, Technical Note 307, Artificial Intelligence Center, International, Menlo Park, CA, 1983.
- [7] J. Mendel, *Fuzzy Logic Systems for Engineering: A Tutorial*, in Proceedings of IEEE, pp. 345–377, 1995.
- [8] J. Schubert, *Clustering belief functions based on attracting and conflicting metalevel evidence*, Proceedings of IPMU conf., Annecy, France, 2002.
- [9] G. Shafer, *A mathematical theory of evidence*, Princeton University Press, 1976.
- [10] R.P. Singh, W.H. Bailey, *Fuzzy logic applications to multisensors-multitarget correlations*, IEEE Trans. on Aerospace and Electronic Systems, 33(3), 1997.
- [11] F. Smarandache, J. Dezert (Editors), *Applications and Advances of DSMT for Information Fusion*, Vol. 1, American Research Press, Rehoboth, 2004. <http://www.gallup.unm.edu/~smarandache/DSMT-book1.pdf>.

- [12] F. Smarandache and J. Dezert (Editors), *Applications and Advances of DSMT for Information Fusion*, Vol. 2, American Research Press, Rehoboth, 2006. <http://www.gallup.unm.edu/~smarandache/DSMT-book2.pdf>.
- [13] A. Tchamova, J. Dezert, F. Smarandache, *A new class of fusion rules based on T-Conorm and T-Norm fuzzy operators*, Information and Security, An International Journal, Vol. 20, 2006.
- [14] E. Waltz, J. Llinas, *Multisensor data fusion*, Artech House, 1990.
- [15] L.A. Zadeh, *Fuzzy sets*, Informat. Contr., Vol.8, pp. 338–353, 1965.
- [16] L.A. Zadeh, *Outline of a new approach to the analysis of complex systems and decision processes*, IEEE Trans. on Systems, Man and Cybernetics, SMC-3., 1973.
- [17] L.A. Zadeh, *Fuzzy sets and applications*, Selected papers, Wiley, 1987.

Chapter 21

Map regenerating forest stands based on DST and DS_mT combination rules

Brice Mora¹, Richard A. Fournier¹, Samuel Foucher²,

1: Centre d'Application et de Recherche en Télédétection (CARTEL),
Université de Sherbrooke, Québec, Canada.

2: Centre de Recherche en Informatique de Montréal, Québec, Canada.
{brice.mora,richard.fournier}@usherbrooke.ca,samuel.foucher@crim.ca

Abstract: *Our results demonstrated the ability of the Free Dezert-Smarandache (DS_m) model to improve thematic classification of forest regeneration over the use of Dempster-Shafer Theory (DST) and a classical Maximum Likelihood Algorithm (MLA). Overall, a classification accuracy of 82.75% was obtained with the reference method, MLA but it was improved by 7.4% by applying the fusion method DST (90.14%). Further improvement of 1% (to 91.13%), compared to those from the DST, was modest but noticeable when using the free DS_m model. The study also showed the critical aspect of the design of the mass functions of each ancillary source and the difficulty to model the associated vagueness and uncertainty. Finally, the ability of the algorithms to take advantage of data fusion provided an excellent tool to test various combinations. After testing series of potential inputs, we found that drainage and surface deposit were the two best ancillary inputs in addition to spectral information to improve classification on the growth potential of regenerating forest stands in Southern Québec.*

21.1 Introduction

This impetus of our work spurred from the necessity to improve map accuracy in the regenerating forest stands of the Province of Québec in Canada to facilitate forest management in general and more specifically field operations. Current forest inventory maps divide the landscape into polygons of uniform characteristics based on stand type, tree density and average height as delineated by an experienced photo-interpret. The polygon dimensions are larger than 2ha and we wish to develop a method that provides information at a finer resolution. Another limitation is the update frequency of the maps: inventory cycles imply production of a new map every 8 years. We wish to develop a method that can provide information between inventory update.

The Maximum Likelihood Algorithm (MLA) is commonly used in forest mapping context [5, 14] and thus can be used as a reference result for the fusion algorithms. The limitation of the MLA for thematic classification lies with its incapacity to deal with heterogeneous data (nominal and ordinal data). Thus, only satellite imagery is usually used to produce such maps. We selected the Dempster-Shafer Theory (DST) and the Dezert-Smarandache Theory (DSmT) with its free DSm model to improve mapping accuracy of regeneration for their ability to fuse satellite imagery with heterogeneous and complementary data but also for their ability to deal with data uncertainty and vagueness. We therefore compared the results from the DST and those when free DSm model was used. Results obtained in [18, 19] suggested that free DSm model was more adapted to deal with conflicting fusion cases compared with DST and we felt it needed to be tested further for our purpose.

The main objective of our study is to test if DST and DSmT based on the free DSm model allow improving map accuracy for area under regeneration. In such case, specific objectives are included to compare results with MLA and also to assess the best supplementary input for data fusion to improve the results. This work was extracted from a study with extended objectives which will be submitted by Mora *et al.* [11]. This chapter below focused only on the fusion case that provided the best results.

21.2 Reasoning theories

21.2.1 Dempster-Shafer theory (DST)

Unlike the theory proposed by Bayes [1], the works from Dempster [4] and Shafer [17] allows fusing sources of information. Data fusion using DST takes into account the uncertainty and the vagueness linked to the data and the knowledge that we have about their influence on a given purpose. The following description is a reminder of the theoretical bases of the fusion method.

The first step of data fusion with DST involves defining the frame of discernment Θ that includes all the classes of the stratification:

$$\Theta = \{\theta_1, \theta_i, \dots, \theta_n\}. \tag{21.1}$$

Then a power set 2^Θ is deduced from Θ including all the subsets of Θ and the empty set \emptyset . For instance, for 3 singleton hypotheses we have :

$$2^\Theta = \{\theta_1, \theta_2, \theta_3, \theta_1 \cup \theta_2, \theta_1 \cup \theta_3, \theta_2 \cup \theta_3, \theta_1 \cup \theta_2 \cup \theta_3, \emptyset\}. \tag{21.2}$$

In DST, Dempster’s combination rule allows fusing information sources with mass functions describing all states of each source. These mass functions can be equated to a confidence level given to each focal element, i.e. each element of 2^Θ with a non null mass. Thus, the mass functions $m(\cdot)$ of each hypothesis of 2^Θ will comply with the following requirements, for a given source:

$$\begin{aligned} m: 2^\Theta &\rightarrow [0,1], \\ \sum_{A \in 2^\Theta} m(A) &= 1, \\ m(\emptyset) &= 0. \end{aligned} \tag{21.3}$$

The combination rule (21.4) combines the sources two by two according to the mass functions defined at the previous step. If we fuse three sources, a second iteration will fuse the third source with the results of the first combination. The same process can be expanded to larger number of sources. The combination rule is associative and commutative. This means that the order for which the sources are combined is not important. Thus for two distinct sources characterized by their belief masses $m_1(\cdot)$ and $m_2(\cdot)$, the combination rule is written as $m(\emptyset) = 0$ and $\forall C \in 2^\Theta \setminus \{\emptyset\}$:

$$m(C) = [m_1 \oplus m_2](C) = \frac{\sum_{A \cap B = C} m_1(A)m_2(B)}{1 - \sum_{A \cap B = \emptyset} m_1(A)m_2(B)}. \tag{21.4}$$

The denominator of (21.4), also represented by the letter K , equals zero if the sources are completely contradictory. In such case it means that conflict between sources, symbolized by k , equals 1 knowing that:

$$K = 1 - k. \tag{21.5}$$

Zadeh [20] showed that in the case of highly conflicting combinations, the DST can provide counterintuitive results. Some authors proposed different solutions to solve this problem. We decided to test the DS_mT which has been designed specifically to assess conflicting cases.

21.2.2 Dezert-Smarandache theory (DSmT)

DSmT is a generalization of the DST for dealing with conflicts and/or paradoxical hypotheses [18, 19]. This generalization brings a more adapted framework to take into account conflicts existing between sources. There is a suite of DSm models available according to the application [18, 19]. Among all the different adaptations of DSm models we selected the free DSm model for our study because of its ability to deal with conflicts and for its simplicity of implementation.

The classic DSm combination rule (DSmC) works with the free DSm model and keeps the properties of commutativity and associativity of the DST. A hyper-power set is now derived from the frame of discernment Θ . This set is built with disjunctive and conjunctive operators \cup and \cap . Consequently for the frame of discernment presented in (21.1), the derived hyper-power set D^Θ will be as follows:

$$D^\Theta = \{\theta_1, \theta_2, \theta_1 \cup \theta_2, \theta_1 \cap \theta_2, \emptyset\}. \tag{21.6}$$

The requirements to build mass functions for each focal element of D^Θ are identical to what was presented for the DST. The DSmC rule of combination for two distinct sources is defined as $m(\emptyset) = 0$ and $\forall C \in D^\Theta \setminus \{\emptyset\}$:

$$m(C) = [m_1 \oplus m_2](C) = \sum_{A, B \in D^\Theta, A \cap B = C} m_1(A)m_2(B). \tag{21.7}$$

As we can see in (21.7), the parameter k representing the conflict in the DST combination rule (21.4) disappeared. Now the conflict (or the paradox) is represented by every composed class resulting in the intersection of two singleton hypothesis.

21.2.3 Decision rule

Various decision rules are proposed in the literature. The most common are the maximum credibility and maximum plausibility and the pignistic probability. For our study we choose to deal only with two singletons hypotheses. Consequently, the maximum credibility decision rule was chosen for its simplicity of implementation. Indeed in this case, all the other common decision rules cited above will provide the same decision. For a hypothesis A , it is computed as:

$$Cr(A) = \sum_{B \subseteq A} m(B). \tag{21.8}$$

21.3 Information used in this work

21.3.1 Study area

The study area is located in the Watopeka forest located in Southern Québec, Canada with a center latitude and longitude at 45°35'00" N 71°46'00" W. The study area can

be delimited by a square of 50km² in which 2.5km² is occupied by regenerating forest stands. This forest is mainly composed of maple species, yellow birch and coniferous species like balsam fir, jack pine and black spruce. Due to this species composition, this forest is dedicated to wood production for a paper factory. The local climate can be defined as "continental, sub-humid". The mean altitude of the area varies from 250 to 400m above sea level. The growth season varies from 170 to 190 days per year and the cumulative number of day degrees varies from 2400 to 3400°C.

21.3.2 Satellite imagery

We used a multispectral SPOT-5 HRG image taken on September 9 2002 and covering the study area. The image was orthorectified using a DEM (Digital Elevation Map) which was interpolated with the Spline method applied to contour lines (1:20 000) extracted from the Québec topographic database. The SPOT-5 image was composed of pixels with 10m spatial resolution. Such spatial resolution is a good compromise between the lower resolution provided by Landsat images at 30m and the very high spatial resolution images (e.g. QuickBird, IKONOS) ranging from 0.6 to 4m. Landsat images do not provide sufficient spatial resolution to identify efficiently spatial patterns of regenerating forest often in stripes. In contrast, very high spatial resolution satellite images at the level of 1 to 4m provide a sufficient level of details but are far more complex to process. In addition to supplying with a suitable spatial resolution to identify regeneration areas, multispectral SPOT-5 image also offers a good compromise between cost and total surface covered.

21.3.3 Sample plots

We collected field sample plots for the three classes of stand regeneration: Deciduous commercial species, Non commercial, Conifers. The main commercial deciduous found in the study area were maple sugar and yellow birch. Non commercial species included shrubs, ferns and typical species from humid sites like lycopods, horsetails. The conifer class included balsam fir, jack pine and black spruce. For each of the three classes, plot localization was chosen at random inside known areas having regenerating stands in the study area. During the field visit, a GPS reference value was taken at the center of each sample plot for location and the following attributes were recorded as an average considering all trees in the plot: species composition, density, age, and height, approximate radius of stand homogeneity from the center. Sample plots diameter could vary depending on the homogeneity of the species distribution. This did not add any difficulty in the analysis as we did not need to compare these plot diameter and all plots had a minimum radius of 12m which allowed all plots to be used in the analysis. We superimposed the satellite image over the sample plots to assigned pixels that corresponded to each plots. Table 21.1 provides the number of sample plots and their associated number of pixels obtained for each class.

	Commercial deciduous	Non Commercial	Conifers
Sample plots	61	53	36
Pixels	334	168	164

Table 21.1: Numerical description of each class of the stratification.

The spectral separability of the three classes was evaluated by using the pixel radiometric values at the location of each plot. We first applied the Jarque-Bera test [9] which examined the normality of radiometric values of each class. Each class was evaluated for each of the four bands of the satellite image. Half of the combinations were proved to be normal. The others were rejected with an alpha coefficient of 5 or 1%. Then we computed the Bhattacharyya distance to examine the separability of the class distributions. Results provided a good separability between classes from 1.31 to 1.46 (Table 21.2) knowing that a perfect separability is equal to 2. According to these tests we decided to use the maximum likelihood algorithm (MLA) as the first reference test to compare its results from those of the fusion algorithms. We divided randomly the datasets into two parts in order to obtain first a dataset for the training of the MLA (66% of the sample plots) and second another dataset to evaluate the results of the classification (34% remaining).

	Commercial deciduous	Non Commercial
Non Commercial	1.43	/
Conifers	1.31	1.46

Table 21.2: Bhattacharyya distance on the sample plots distributions.

21.3.4 Drainage and surface deposit

In our first series of tests to map regeneration of forest stands, we only considered two pedological attributes, surface deposit and drainage, among all the potential biophysical parameters involved in the growth potential of forest stands. The value of these two attributes will be added to the spectral values as input of the classification methods using evidential reasoning. We focused on these two pedological attributes because they have been identified in the scientific and professional literature as the major explanatory variables for the stand growth for ecosystems. Roy *et al.* [15, 16], Gagnon and Roy [6], Robitaille [13] and MRNQ [12] provide more details on the importance of surface deposit and drainage on the spatial distribution of the species in Eastern Canada. Both attributes were available from the maps published by the provincial government of Québec which served as a base for forest inventory. These maps are produced from the interpretation of aerial photography taken at a scale of 1 : 15000.

21.4 Methods

A flowchart of the steps required to apply our method is given in Figure 21.1. Before applying the classification methods we identified the areas with regenerating stands from the interpreted provincial forest inventory and created a spatial mask to apply the analysis over that area only. Then we processed to image classification using the MLA. The result of this reference method allowed mapping the coniferous areas in the regenerating stands. We therefore identified pixels of the image and in the regeneration stands that were dominated by conifer trees. These pixels can therefore be treated separately in the analysis. Once the delimitation of regeneration area is completed, we start the analysis for belief assignment, i.e., we defined the mass functions for the two remaining classes: Commercial deciduous and Non commercial. Then we processed the data fusion according to the DST and DS_mT with the decision rule of the maximum credibility. The results are validated by comparing with a reference method (MLA) or with the validation plots.

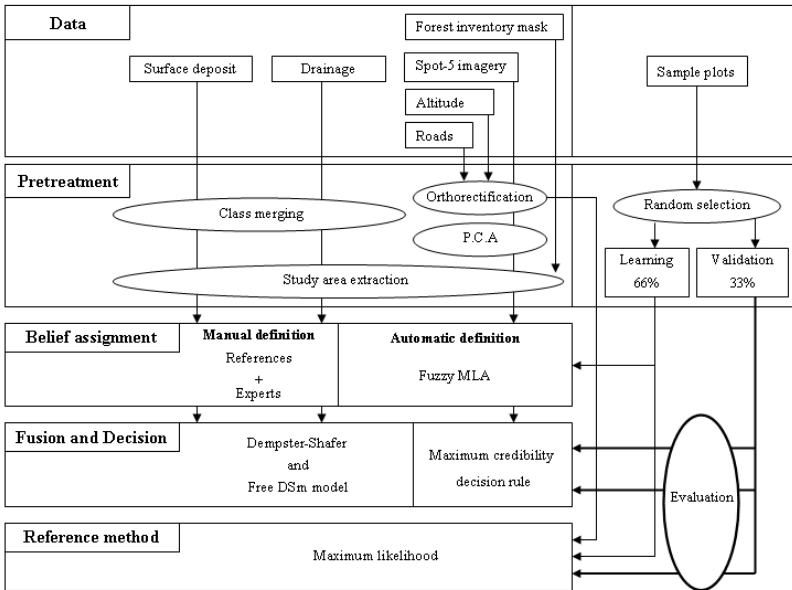

Figure 21.1: Flowchart of the methodology.

21.4.1 Reference methods

The first step of the process consisted in pre-identifying the regenerating stands with the provincial forest inventory. This allowed reducing the number of classes including only the regeneration stands to be considered in the study area. Then we were able to mask the satellite image only on these areas which were relevant for the analysis. We applied the MLA on the masked image by using the training sample plots. The results were not only used as a reference to evaluate the performance of the fusion methods but were also used to identify the coniferous pixels in the regenerating stands.

21.4.2 Data fusion methods

We were not able to define mass functions for the conifer class of the stratification because of a lack of references leading to support mass function values. Therefore the fusion process was applied only to pixels of the two other remaining parts of the regenerating stands identified as "Commercial deciduous" or "Non commercial".

The belief assignment was processed according two specific ways, one for the satellite image and one for the ancillary sources. We used the Fuzzy Statistical Expectation Maximization algorithm (FSEM) [7] to define the mass functions for the satellite image. This supervised multi-iterative method is based on Gaussian distribution classes and compute posterior probabilities. The use of the FSEM requires having strictly independent sources. Consequently we used as data input the first two principal components (90% of the variance) of a principal component analysis (PCA) applied to the four spectral bands of the satellite imagery. The FSEM has the ability to produce fuzzy classes. This automatic way to design the mass functions was only applied to the satellite image because it was not possible to obtain normal distributions with the other two ancillary sources of input: surface deposit and drainage.

We designed the mass functions of the two ancillary sources manually according to the references and some expert interviews. Corgne [3] and Cayuela *et al.* [2] also adopted this way to define mass functions of their models. Firstly, the references indicated in what way each source had a positive influence on the growth development of the deciduous species of interest. This focuses mostly on the sugar maple, the most common species of interest in the area. Secondly, we designed the mass functions so that the sum of all masses of pure classes was equal to 1. A normalization occurred later in order to integrate the mass of fuzzy classes to follow the rule defined by (21.3). Thus, at this step we have the following relationship for two pure classes:

$$m(\theta_2) = 1 - m(\theta_1). \quad (21.9)$$

In the case of our study, we can replace the class name "Deciduous species" by θ_1 and "Non commercial species" by θ_2 . At this point we had values for mass functions only for pure classes. However the next step impose that we define new masses for union classes or fuzzy classes and that we renormalize with these new mass values.

We defined the mass functions for fuzzy classes in the discounting framework [10, 17]. This helps also to weaken the bba's associated with sources believed to be less reliable or of lesser importance for the fusion procedure. The discounting method is defined in our 2D case as follows:

$$m'(\theta_1) = \alpha \cdot m(\theta_1), \quad (21.10)$$

$$m'(\theta_2) = \alpha \cdot m(\theta_2),$$

$$m'(\theta_1 \cup \theta_2) = (1 - \alpha) + \alpha \cdot m(\theta_1 \cup \theta_2). \quad (21.11)$$

Given the vagueness and uncertainty related to the sources (scale digitization, quality of the manufacturing process), we fixed the coefficient α to a value of 0.5 empirically. According to (21.11), this is equivalent to considering the mass of the fuzzy class as the mean of the masses of the pure classes before the normalization. On the one hand this choice appeared as the best compromise to model the vagueness and the uncertainty of the sources. On the other hand, we were not able to define the masses of the fuzzy class manually on a scientific basis. Then we applied a linear normalization to follow the requirement of (21.3).

References from the scientific literature provided the necessary information to define the influence of each state of the sources on the growth development of the deciduous species. In other words, we were able to design the general shape of the mass functions. Then, we had to interpret numerically the specific influence of each source when the reference did not provide such information. This was done empirically so we applied a sensitivity analysis to assess the influence of the variation of the mass values on the quality of the fusion.

- *Drainage*

Roy *et al.* [16] established a curve linking the drainage with dieback rate of forty deciduous forest stands in Southern Québec. We used this curve to quantify the influence of soil drainage on growth development of the sugar maple (see Table 21.3). We noticed that the two levels 'Excessive' and 'Fast' were not found in our study area. The codes of Table 21.3 correspond to the provincial forest inventory standards.

- *Surface deposit*

According to Roy *et al.* [15, 16], Gagnon and Roy [6], Robitaille [13] and MRNQ [12] and also to expert interviews, we translated the influence of the amount of clay and the thickness of the soils on the growth of sugar maple as indicated in Table 21.4. These codes also corresponded to the Québec provincial forest inventory standards.

- *Data fusion*

As motivated above, the fusion model did not consider conifer pixels. Identification of conifer pixels was accomplished with the MLA. When applying

Level	Code	Mass of θ_1	Mass of θ_2
Excessive	0	0	1
Fast	1	0.69	0.31
Good	2	0.77	0.23
Moderate	3	0.77	0.23
Imperfect	4	0.60	0.40
Bad	5	0	1
Very poor	6	0	1

Table 21.3: Mass values for the drainage.

Type	Code	Mass of θ_1	Mass of θ_2
Thin organic deposits	7T	0.15	0.85
Thin glacial deposits	1aM	0.3	0.7
Medium thickness glacial deposits	1aY	0.4	0.6
Thick glacial deposits	1a	0.5	0.5
Juxtaglacial deposits, Proglacial deposits, Ancient fluvial deposits	2A, 2B, 3AN	0.7	0.3
Glaciolacustral deposits	4GS	0.9	0.1

Table 21.4: Mass values for the surface deposit.

the DST algorithm we tested the possible combinations of the results of the PCA from the SPOT-5 image with one and two ancillary sources. The results from data fusion using the DST were compared with those from the reference method (MLA).

We applied a Hill-Smith test [8] to study the link between the masses, the quality of the result obtained by the DST and the conflict level (Figures 21.2 and 21.3). The result shows a positive correlation between the conflict and the misclassified pixels which justified the use of DSMT with the free DSMT model to fuse the sources. In the application of the free DSMT model we followed the same procedure as the DST fusion process. Here, we fused the sources with a total transfer of fuzzy masses to the paradoxical class as in Corgne [3].

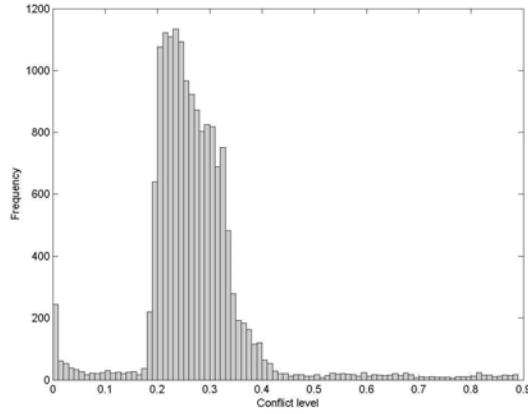

Figure 21.2: Histogram of the conflict for the best source combination.

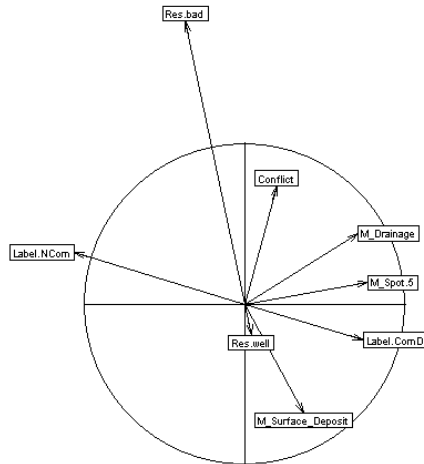

Figure 21.3: Correlation circle of the Hill-Smith test on the best DST fusion parameters. The prefix "Res" means "Result", "NCom" refers to the Non commercial class and "ComD" refers to the Commercial deciduous class.

21.5 Results and their interpretation

21.5.1 Results based on the maximum likelihood algorithm

Table 21.5 presents the correct classification results obtained using the MLA with the three classes of the original stratification and those obtained after adding the conifers to the mask. These results served as a base of comparison for those that were obtained with the fusion algorithms. The "two classes" case provided better results (82.75%) than the "three classes" case (70.03%). This can be explained by the reduction of the confusion produced by the removal of the Conifers class. For the "two class" case both classes were well classified; above 90% for the Commercial deciduous class and above 70% for the Non commercial class. Such good results were expected in view of the normality of spectral values within the sample plots and the Bhattacharrya distance obtained for the classes (Table 21.2).

	ComD	NCom	Conifers	Mean
"three classes" case	85%	40.96%	81.48%	70.03%
"two classes" case	90.83%	71.08%	/	82.75%

Table 21.5: Results of the MLA with according to the number of classes. "NCom" refers to the Non commercial class and "ComD" refers to the Commercial deciduous class.

21.5.2 Results based on the fusion in DST framework

Comparison of results obtained with the MLA with those obtained with the FSEM (Table 21.6), shows that the FSEM was less efficient than the MLA to classify the satellite image. Consequently we decided to stop the FSEM after one iteration in order to obtain a fuzzy MLA classification. In fact the first iteration of the FSEM fixed the prior probabilities for each of the n classes at $1/n$ which is equivalent to applying the MLA. When compared to the FSEM (Table 21.6), the fuzzy MLA provided an improvement of 6.4% on the overall accuracy. The result provided by the MLA used as a reference result was lower than the one obtained with the fuzzy MLA by about 1%. This can be explained by the fact that the last method computed the masses for a third class (the fuzzy class). This induced a new distribution of mass values which led to a new hierarchy between the singleton classes. Moreover when using the fuzzy MLA, the input data were not the spectral bands but the bands provided by a PCA. Therefore this can lead to a slight difference in the results from the MLA applied to the spectral bands of the satellite image.

	Commercial deciduous	Non commercial	Mean
MLA	90.83%	71.08%	82.75%
FSEM	96.67%	49.40%	77.34%
Fuzzy MLA	85%	81.93%	83.74%

Table 21.6: Results obtained by the MLA and the FSEM.

Table 21.7 presents the results obtained when the satellite image was fused with one and both ancillary sources. The fusion of the satellite image with the Surface deposit or the Drainage provided better results compared with those from the MLA and the fuzzy MLA, respectively by +3.94% and +3.45%. The best results were obtained with the fusion of Surface deposit with the PCA values of the SPOT-5 image. Adding the second ancillary source (Drainage) to the combination provided a small but noticeable improvement of +2.46% on the overall accuracy.

	Commercial deciduous	Non commercial	Mean
Drainage	95%	75.90%	87.19%
Surface deposit	90%	84.34%	87.68%
Drainage / Surface deposit	95.83%	81.93%	90.14%

Table 21.7: Results obtained using DST framework.

Table 21.8 provides information about the conflict level for the whole area and within the validation sample plots for the fusion of the satellite image and both ancillary sources. As shown in Figure 21.2 the mean conflict level in the image is not high (0.27) but some pixels have high values (until 0.89). The Hill-Smith test showed a positive correlation between the conflict level and the misclassified pixels. From the table we noticed that the validation sample plots were not within the highest conflicting areas (maximum conflict value of 0.42). Nonetheless, the fusion with DSmT and the free DSm model remains relevant. Next section presents the results obtained with this fusion method.

	Minimum	Mean	Standard deviation	Maximum
Whole area	0	0.27%	0.1	0.89
Validation sample plots	0	0.24%	0.07	0.42

Table 21.8: Conflict levels for the fusion with both ancillary sources.

21.5.3 Results based on the fusion in DS_mT framework

Table 21.9 presents the results obtained for the fusion of the satellite image with the ancillary sources. The use of the free DS_m model induced a small improvement of 0.49% of the overall accuracy for the DST fusion using the combination of the satellite image with the Drainage. Applying the free DS_m model using only Surface deposit with the PCA bands provided worse results for the Commercial deciduous class and also induced a slight decrease of the overall accuracy by 0.49%. The best results were obtained with the combination of the PCA values of satellite image with the Drainage and the Surface deposit. It induced an improvement of 1% on the overall accuracy compared to the DST.

	Commercial deciduous	Non commercial	Mean
Drainage	93.33%	79.51%	87.68%
Surface deposit	89.16%	84.33%	87.19%
Drainage / Surface deposit	95%	85.54%	91.13%

Table 21.9: Best results obtained using DST framework and the free DS_m model.

21.6 Sensitivity analysis

21.6.1 Mass functions of the ancillary sources

Because some mass function values were determined empirically, we decided to apply sensitivity tests. This analysis implied varying the mass values through their potential range to study the impact of the initial choice. We aimed at preserving the shape of the curves which represents the hierarchy between the state values of the source. Figure 21.4 represents the evolution of the overall accuracy according to the mass variations. Note that the mass variation displayed in the x-axis is the variation of the Commercial deciduous class. When the mass values of one hypothesis are increased, this automatically leads to an improvement of the overall accuracy of the class, and a decrease in the other one. Figure 21.4 also shows that the initial mass values provided the best overall accuracy which is the best compromise for the quality of the detection of both classes.

21.6.2 Discounting coefficient

Previously we justified why we chose to fix the α coefficient at a value of 0.5. Nonetheless we studied the variation of this parameter that could influence the overall accu-

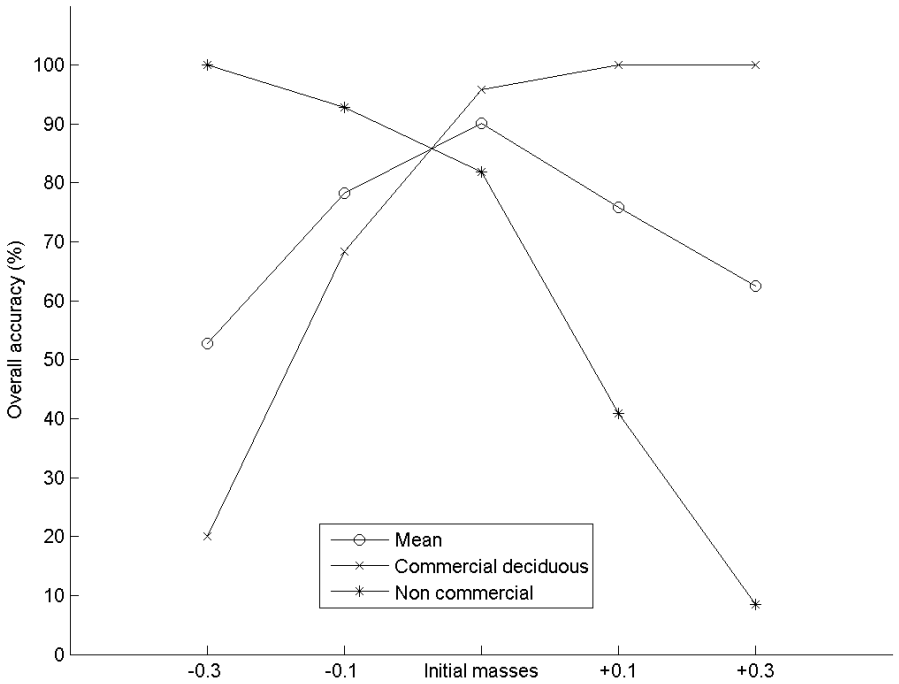

Figure 21.4: Evolution of the overall accuracy according to the variation of the masses for the combination with two ancillary sources.

racy. Figure 21.5 represents the evolution of the results according to the variation of this coefficient. A zero value for α means that the discounted mass functions will be equivalent to a Bayesian belief structure and will be very specific whereas a value equals to 1 will transform the mass functions to a non-informative belief structure. It shows the small influence of the discounting coefficient on the overall accuracy. Only a slight improvement is obtained with the highest values ($\alpha = 0.8$ and 0.9) of the coefficient. With a value of $\alpha = 0.8$, the identification of the Non commercial class is improved by 1.35%. With a value of $\alpha = 0.9$, the identification of the Non commercial class is improved by 4% and the ability to identify Commercial deciduous decreased by a value of -0.82%. Thus we realized the small impact of the discounting coefficient on the overall results for our study.

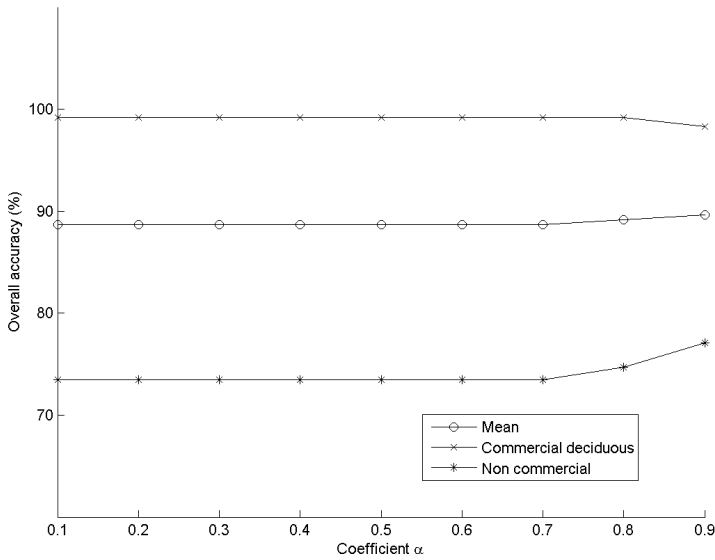

Figure 21.5: Evolution of the overall accuracy according to the value of α for the combination with two ancillary sources.

21.7 Discussion

From our preliminary runs of the algorithms we quickly realized that results from multiple iteration of the FSEM were not as useful as using only the first iteration (which is equivalent to the fuzzy MLA). It seems to be an interesting way to compute automatically the masses of the spectral bands of a satellite image. We think that this automatic way is preferable than an empirical one. However the normality of the spectral information within the training samples has to be considered. Also, the classification resulting from the fuzzy MLA gave an interesting overall accuracy (83.74%) and balanced results for each class (both above 80%). This also confirmed the interest of the fuzzy MLA.

Our study also showed the difficulty to establish the mass functions of the ancillary sources. This is due to the lack of scientific knowledge about the influence of the attributes on the growth potential of regenerating forest stands. Moreover the sensitivity tests showed the high sensitivity of the results to the design of the mass functions. We also showed the low influence of the discounting coefficient on the global quality of the fusion but we still think the way we used the discounting frame

by fixing α at a value of 0.5 is a best way to deal with the lack of knowledge we have about the influence of each ancillary source and their quality. This value is a compromise because it equals the mean of the masses of the pure hypotheses before the linear normalization that considers the mass of the fuzzy class. Nonetheless, we advise to test different α values for each source to be fused according to its quality and the uncertainty about the design of the mass functions. For example the scale of each source could be considered for this. We could not test this in our study because all the sources had the same scale.

Note that for this first study about the regenerating forest stands, we only considered pedological attributes. Some references and experts, also cite topographic and hydrographical information as attributes of interest for our purpose. Thus, in order to improve the results, we should review all potential sources of information. Also, on a technical point of view, a way to improve the results may be to condition the transfer of the fuzzy mass to the "intersection class" according to conflict level encountered during the DST fusion. Lastly we benefited in our study from only modest improvements while applying the free DS_m model. This might be partially due to the fact that validation plots were not taken in high conflict areas (see Table 21.8). This situation shows the importance of plot distribution to make sure they are also present in areas presenting high conflict. Therefore, the level of conflict should always be tested as a prior indication to choose the most relevant fusion method.

21.8 Conclusion

Our study showed the ability of DS_mT and the free DS_m model to improve the classification results (91.14%) compared to those from DST (90.14%) and also those from reference method like MLA that is typically used in forestry (82.75%). DS_mT using the free DS_m model gave better results than the DST but only with a small improvement of 1% which indicates that the DST provided most of the improvements in accuracy that was expected for the purpose of mapping stand regeneration. Traditional methods like MLA use satellite image as their only source of information. Data fusion methods proposed in DST and DS_mT allow the inclusion of other parameters that are known to explain forest regeneration. In our case it allowed to model the influence of surface deposit and drainage which are both known by forester to influence the growth potential of regenerating forest stands in Southern Québec. As a continuation of this contribution, further studies should focus on the mass function structuring prior to the fusion. This is a recurring issue for any project wishing to adopt DST model framework. An adapted uncertainty to each source should provide better results. This would be done according to the quality of the data (statistics about its accuracy, the scale . . .).

21.9 References

- [1] T. Bayes, *An Essay towards solving a Problem in the Doctrine of Chances*, By the late Rev. Mr. Bayes, communicated by Mr. Price, in a letter to John Canton, M. A. and F. R. S, Philosophical Transactions of the Royal Society of London, 53, 370-418, 1763.
- [2] L. Cayuela, J.D. Golicher, J. Salas Rey, J.M. Rey Benayas, *Classification of a complex landscape using Dempster-Shafer theory of evidence*, International Journal of Remote Sensing. Vol. 27, No. 10, pp. 1951-1971, 2006.
- [3] S. Corgne, *Modélisation prédictive de l'occupation des sols en contexte agricole intensif : application à la couverture hivernale des sols en Bretagne*, Thèse de doctorat, Université de Rennes 2 & Haute Bretagne, 2004.
- [4] A.P. Dempster, *A generalization of Bayesian inference*, Journal of the Royal Statistical Society, Series B 30, pp. 205-247, 1968.
- [5] D. Ducrot, *Méthodes d'analyse et d'interprétation d'images de télédétection multi-sources - Extraction de caractéristiques du paysage*, Habilitation à diriger des recherches, INP Toulouse, France, 2005. http://www.cesbio.ups-tlse.fr/data/_all/theses/HDR/_DD/_2005.pdf.
- [6] G. Gagnon, G. Roy, *Le dépérissement de l'érablé à sucre (Acer saccharum Marsh.) au Québec*, Revue Forestière Française (Nancy) 46(5), pp. 512-521, 1994.
- [7] M. Germain, M. Voorons, J.M. Boucher, G.B. Benie, *Fuzzy statistical classification method for multiband image fusion*, Proceedings of the Fifth International Conference on Information Fusion, Vol. 1, pp. 178-184, 2002.
- [8] M.O. Hill, A.J.E. Smith, *Principal component analysis of taxonomic data with multistate discrete characters*, Taxon, 25, pp. 249-255, 1976.
- [9] C.M. Jarque, A.K. Bera, *A test for normality of observations and regression residuals*, International Statistical Review 55, pp. 163-172, 1987.
- [10] D. Mercier, T. Denoeux, M.H. Masson, *General Correction Mechanisms for Weakening or Reinforcing Belief Functions*, 9th International conference on Information fusion, pp. 1-7, Florence, Italy, 2006.
- [11] B. Mora, R.A. Fournier, S. Foucher, *Application of evidential reasoning to improve regenerating forest stands mapping*, to be submitted.
- [12] MRNQ, *Rapport de classification écologique - Érablière à tilleul de l'Est*, Programme de connaissance des écosystèmes forestiers du Québec méridional, Service de l'évaluation de l'offre/Service de la recherche appliquée/Direction des inventaires forestiers/Direction de la recherche forestière/Forêt Québec. Ministère des Ressources Naturelles du Québec, Février 1999.

- [13] A. Robitaille, J.P. Saucier, *Paysages régionaux du Québec méridional*, Direction de la gestion des stocks forestiers et la direction des relations publiques du ministère des Ressources naturelles du Québec, 220 pages, 1998.
- [14] J. Rogan, S.R. Yool, *Mapping fire-induced vegetation depletion in the Peloncillo Mountains, Arizona and New Mexico*, International Journal of Remote Sensing, Vol. 22, No. 16, pp. 3101–3121, 2001.
- [15] G. Roy, A. Sauvesty, F. Pagé, R. Van Hulst, C. Ansseau, *A comparison of soil fertility and leaf nutrient status of sugar maples (*Acer saccharum*) in relation to microrelief in two forests in Québec*, Canadian Journal of Soil Science, 82 (1), pp. 23–31, 2002.
- [16] G. Roy, L. Robitaille, G. Gagnon, *Étude des principaux facteurs du dépérissement des érablières au Québec*, Phytoprotection, 66, pp. 91–99, 1985.
- [17] G. Shafer, *A mathematical theory of evidence*, Princeton University Press, Princeton, NJ, 1976.
- [18] F. Smarandache, J. Dezert (Editors), *Advances and Applications of DSMT for Information Fusion, (Collected Works)*, American Research Press, Rehoboth, June 2004.
<http://fs.gallup.unm.edu/DSMT-book1.pdf>.
- [19] F. Smarandache, J. Dezert (Editors), *Advances and Applications of DSMT for Information Fusion, (Collected Works)*, American Research Press, Rehoboth, 2006.
<http://fs.gallup.unm.edu/DSMT-book2.pdf>.
- [20] L.A. Zadeh, *On the Validity of Dempster's rule of Combination of Evidence*, Memo M79/24, Univ. of California, Berkeley, 1979.

Chapter 22

Satellite image fusion using Dezert-Smarandache theory

Abdenour Bouakache, Aichouche Belhadj-Aissa
Image Processing and Radiation Laboratory,
University of Science and Technology Houari Boumediene,
BP. 32, El Alia, Bab Ezzouar,
16111, Algiers, Algeria.
abbouakache@lycos.com, h.belhadj@lycos.com

Grégoire Mercier
Institut Telecom, Telecom Bretagne,
CNRS UMR 3192 Lab-STICC/CID,
Technopole Brest-Iroise CS 83818,
29238 Brest Cedex3, France.
Gregoire.Mercier@telecom-bretagne.eu

Abstract: *Free and hybrid models of multisource satellite images fusion are developed using the plausible and paradoxical reasoning theory of Dezert-Smarandache. The aim of this work is to show the contribution of these fusion models for improving the thematic classification and the quantification of change. The maps obtained by the free model are composed by simple classes and compound classes. Nevertheless, they contain no significant thematic classes and require an important computing time. In the other hand, the hybrid model with a constraint introduced using a prior knowledge relatively of the study area, can have maps composed of more realistic classes in a reduced time. These models are implemented and tested on images acquired by SPOT HRV and Landsat ETM+ sensors.*

22.1 Introduction

Recently, the number of satellite sensors is growing. Information acquired by the various satellite sensors is very rich and complementary. The combination or the fusion of different types of information become very interesting. It must take into account the sources of information increasingly numerous and varied. Information fusion resulting from different sources remains an open and important problem. The difficulty of this process is due to both uncertain and conflicting information available.

In this context, several approaches and theories have been developed [2, 5, 13, 17]. The probabilistic approach which is the oldest and most widespread, it can represent well the uncertainty in the information but does not represent its imprecision [2]. Moreover, it reasons on only simple classes that represent different hypothesis. However, the Dempster-Shafer Theory (DST) can be an alternative to the probabilistic approach, it is often recommended and used by some authors [2, 3, 10–12] because it can also put up with the uncertain nature of information through a solid mathematical formalism and Dempster combination rule.

Nevertheless, this theory has certain weaknesses when the combined evidence sources become very conflicting (conflict close to the unit) and when the problem to be processed cannot be directly described within the frame of discernment of this theory due the paradoxical nature of information. Consequently a new theory which can be considered as a generalization of DST was elaborate, it is the plausible and paradoxical reasoning theory of Dezert-Smarandache (DSmT) [6, 7, 13, 14], it was applied in the field of remote sensing by [3, 4]. This theory can solve some delicate problems where DST is usually fails.

DSmT starts with the notion of free DSm model. This model is free because no other assumption is done on the hypotheses. When the free DSm model holds, the classic commutative and associative DSm rule of combination is performed. In this free model, the rule of combination takes into account both uncertain and paradoxical information. Thus, it generates a frame of discernment more general. But, if the cardinal of this frame increases the computing time increases and moreover some classes of the power set are not significant. Therefore, a integrity constraints are explicitly and formally introduced into the free DSm model in order to adapt it properly to fit as close as possible with the reality and permit to construct the hybrid model. There exist actually many possible hybrid models between the two extreme models (Shafer model and free model) for the frames depending on the real intrinsic nature of elements. The hybrid DSm rule works in any model and is involved in calculating the combined mass of any number of information sources, no matter how big is the conflict/paradoxism of sources, and on any frame (exhaustive or non-exhaustive, with elements which may be exclusive or non-exclusive or both) [13].

The aim of our work is the improvement of the thematic classification and the quantification of changes by a fusion process of optical satellite images using two models of DSmT (the free and the hybrid models). These images are covering a zone of study located at the east of Algiers.

The remainder of the paper is organized as follows. In the next section, we recall the mathematical basis of DSmT and its application to fusion process. Section 22.3 is devoted to the presentation and the implementation of the free model and the hybrid model of DSmT. In section 22.4, the two models of DSmT will be applied to the fusion of two multisource and multitemporal images. Finally, section 22.5 gathers our conclusions and the possible prospects to this work.

22.2 Dezert Smarandache theory basis

The DSmT of plausible, uncertain and paradoxical reasoning [6, 8, 9, 13, 15] is a generalization of the classical DST [5, 16] which allows to formally combine any types of sources of information (rational, uncertain or paradoxical). The DSmT is able to solve complex data/information fusion problems where the DST usually fails, especially when conflicts (paradoxes) between sources become large and when the refinement of the frame of discernment Θ is inaccessible because of the vague, relative and imprecise nature of Θ elements. The foundation of DSmT is based on the definition of the hyper-power set D^Θ (Dedekind's lattice) of a general frame of discernment Θ [8, 9]. The foundation of DSmT is based on the definition of the hyper-power set D^Θ [8, 9] which detailed in section 1.2.1 of the chapter 1, in the beginning of this book.

22.2.1 Mass functions

The determination of mass functions in DSmT represents a crucial step in a fusion process and remains a largely unsolved problem, which did not yet find a general answer. In image processing, Bloch [2] describes three different levels from where a mass function may be derived: at the highest level where information representation is used in a way similar to that in artificial intelligence and masses are assigned to propositions; at an intermediate level, masses are computed from attributes, and may involve simple geometrical models; at the pixel level, mass assignment is inspired from statistical pattern recognition. Recall that the difficulty increases when we are interested on the compound hypotheses and their mass functions. The most widely used approach is to assign to simple hypotheses masses that are computed from conditional probabilities. Then a transfer model is introduced to distribute the initial masses over all compound hypotheses (union and intersection of classes). This transfer operation is done through a coarsening (discounting) factor and/or a conditioning factor applying to the conditional probabilities (initial masses).

In this paper, the mass functions are estimated using a dissonant model of Appriou that was initially developed for only two classes [1] and we have generalized and extrapolated for more than two classes as follows [3]. In the following equations, x_s^b stands for the value of a pixel of the SPOT or Landsat image at spectral band b and

spatial location s .

$$\forall i = 1, \dots, k \quad m_i^b[x_s^b](\theta_i) = \frac{\alpha_i^b R^b P(x_s^b|\theta_i)}{1 + R^b P(x_s^b|\theta_i)} - \frac{|D^\Theta| - k - 2}{k} \varepsilon \quad (22.1)$$

$$\forall r = 1, \dots, k; r \neq i; k \neq 1 \quad m_i^b[x_s^b](\theta_r) = \frac{\frac{\alpha_i^b}{k-1}}{1 + R^b P(x_s^b|\theta_i)} - \frac{|D^\Theta| - k - 2}{k} \varepsilon$$

$$m_i^b[x_s^b](\theta_1 \cup \theta_2) = m_i^b[x_s^b](\theta_1 \cup \theta_3) = \dots = m_i^b[x_s^b](\theta_1 \cup \dots \cup \theta_{k-1}) = \varepsilon$$

$$m_i^b[x_s^b](\theta_1 \cap \theta_2) = m_i^b[x_s^b](\theta_1 \cap \theta_3) = \dots = m_i^b[x_s^b](\theta_1 \cap \dots \cap \theta_{k-1}) = \varepsilon$$

$$m_i^b[x_s^b](\Theta) = 1 - \alpha_i^b,$$

where k is the number of the considered classes, ε is a sensitivity factor that weighted the mass functions in order to have their sum over all the hypothesis equal to 1, $P(x_s^b|\theta_i)$ is the conditional probability, α_i^b is a coarsening factor, and R^b represents a normalization factor that is introduced in the axiomatic approach in order to respect the mass and plausibility definitions, and is given by:

$$R^b = \frac{1}{\max_{i=1, \dots, k} P(x_s^b|\theta_i)}.$$

To fuse paradoxical or rational sources of information (bodies of evidence), we have used in this paper the DSM classical rule and the DSM hybrid rule. These rules are detailed in the sections 1.2.4 and 1.2.5 of the chapter 1 in this book.

For a future work, we plan to test the PCR5 for the multi-source satellite image fusion. This rule redistributes every partial conflict only to propositions only which are truly involved in it and proportionally to their masses put in the conflict [15].

22.2.2 Decision Rule

After the combination of different sources, a decision is made according to a certain criteria. Several decision rules have been proposed:

1. maximum of plausibility which is advocated by some authors [2–4, 11, 12],
2. maximum of belief over the simple hypothesis which is the most used [11],
3. maximum of belief without overlapping of belief intervals which is very strict and called absolute decision rule [3, 11, 12],
4. maximum of pignistic probability [13, 17].

22.3 Implementation of the free and hybrid models

22.3.1 Implementation of the free model

The fusion process with the free model $\mathcal{M}^f(\Theta)$ is given in Fig. 22.1.

The fusion process is detailed by the following steps:

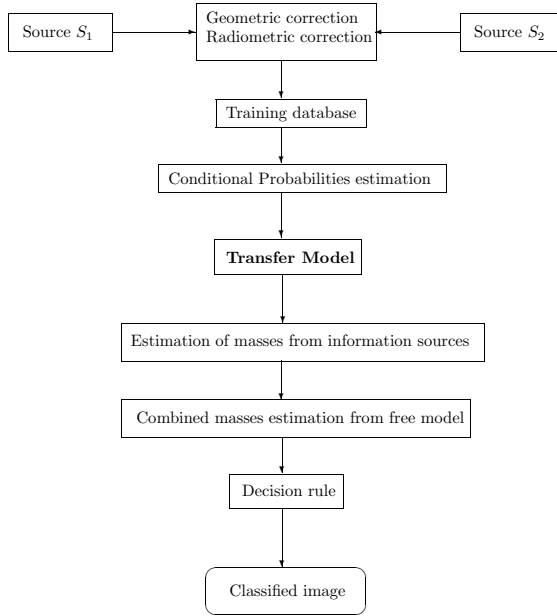

Figure 22.1: Multi-source fusion process using the free model.

1. A geometrical correction in the same reference frame using the interpolation by the polynomial model.
2. A radiometric corrections for both images.
3. According to an *a priori* knowledge, two data bases are constructed: a training base to be used in a supervised classification process, and a test base to be used during the assessment of the classification accuracy.
4. A Bayesian classification is performed using a maximum likelihood algorithm.
5. A confusion matrix is established between a Bayesian classification result and a test data base.
6. For each class, a coarsening factor is obtained from the confusion matrix and it can be seen as the accuracy of that class which is computed by dividing the total number of correct pixels in that class by each of the total number of pixels in that category as derived from the test data base.
7. The mass function is estimated using transfer model of Appriou, detailed in sec. 22.2.1.

8. The mass function is estimated one more time by using transfer model of Ap-priou.
9. A combination rule of DSmT between sources is applied to obtain the combined mass S_1 given by:

$$S_1(A) \triangleq \sum_{\substack{X_1, X_2, \dots, X_k \in D^\Theta \\ X_1 \cap X_2 \cap \dots \cap X_k = A}} \prod_{i=1}^k m_i(X_i) \tag{22.2}$$

10. The combined mass S_1 is saved.
11. The belief and the plausibility functions are deduced from the combined mass function.
12. The uncertainty for each pixel is calculated.
13. Finally, a multispectral classification is released according to a decision rule.

22.3.2 Implementation of the hybrid model

The fusion process with the hybrid model $\mathcal{M}(\Theta)$ is given in Fig. 22.2 and detailed by the following steps.

1. Introduction of the combined mass S_1 calculated in the free model $\mathcal{M}^f(\Theta)$.
2. Introduction of the constraints by forcing some elements of D^Θ to be empty.
3. Determination of the characteristic non-emptiness function $\phi(A)$ and the total empty set $\emptyset \triangleq \{\emptyset_{\mathcal{M}}, \emptyset\}$.
4. Calculation of the sum based on the technique of absorption, transferred the mass from each empty element to total or relative ignorance using the expression of S_2 (see section 1.2.5 in chapter 1) given by:

$$S_2(A) \triangleq \sum_{\substack{X_1, X_2, \dots, X_k \in \emptyset \\ [U=A] \vee [(U \in \emptyset) \wedge (A=I_t)]}} \prod_{i=1}^k m_i(X_i) \tag{22.3}$$

5. Calculation of the sum transferred the masses of relative empty sets to nonempty sets using the following expression of S_3 (see section 1.2.5 in chapter 1):

$$S_3(A) \triangleq \sum_{\substack{X_1, X_2, \dots, X_k \in D^\Theta \\ X_1 \cup X_2 \cup \dots \cup X_k = A \\ X_1 \cap X_2 \cap \dots \cap X_k = \emptyset}} \prod_{i=1}^k m_i(X_i) \tag{22.4}$$

6. Calculation of the combined masses using the general rule of hybrid combination of DSm [7] defines as follows:

$$\forall A_i \in D^\Theta, \quad m_{\mathcal{M}(\Theta)}(A_i) = \phi(A_i) [m_{Mf(\Theta)}(A_i) + S_2(A_i) + S_3(A_i)].$$

7. The belief and the plausibility functions are deduced from the combined mass function.
8. The uncertainty for each pixel is calculated.
9. Finally, a multispectral classification is released according to a decision rule.

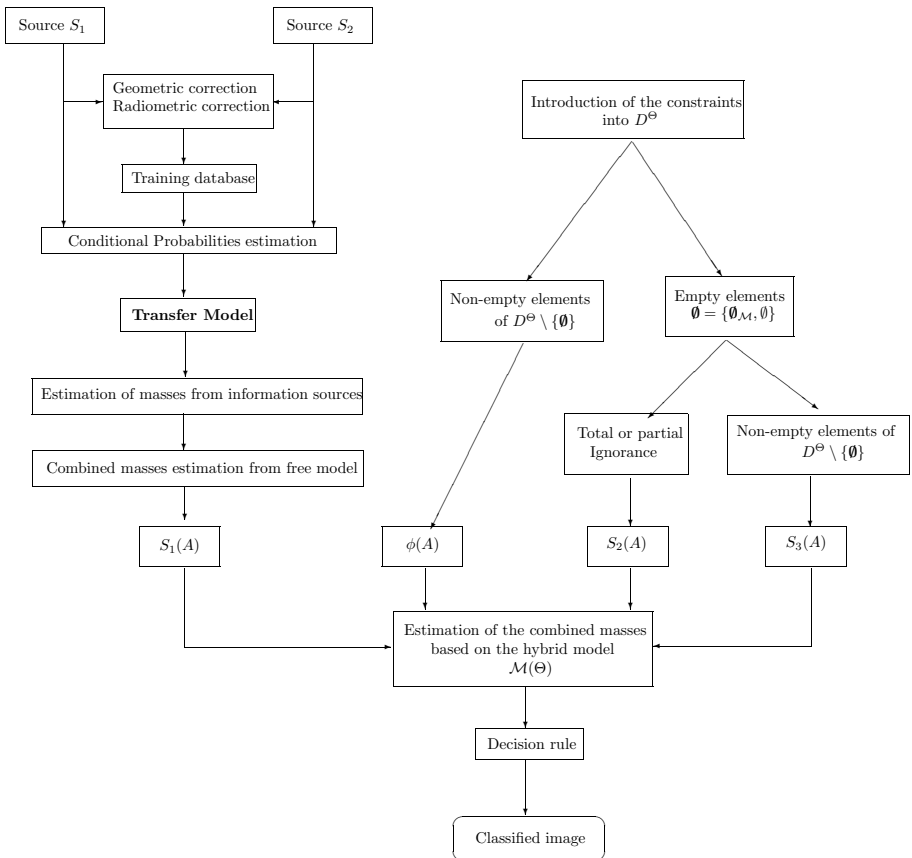

Figure 22.2: Multi-source fusion process using the hybrid model.

22.4 Application

22.4.1 Site of study and data used

The methodology proposed is tested on an area located approximately at 10km to the east of Algiers. This area is characterized by high urban concentration and a very dense road network in the north of the airport and an agricultural area with bare soil in the south of the airport.

For a multisource study of the site, we often used a data set acquired by different satellite sensors at the same date on the same study area and for a multitemporal study of the site, it is preferable to use a data set acquired by the same sensor on different times on the same scene. However, currently we do not have this ideal data set. Therefore, two multisource and multitemporal images were put at contribution in this study: a multispectral image acquired on April 1st, 1997 by the sensor HRV1 of SPOT-1 satellite, a multispectral image acquired on June 3rd, 2001 by the sensor ETM+ of Landsat-7 satellite. The joint exploitation of these images requires a step of geo-referencing through a method of geometric correction.

In our case, we applied the polynomial method through a second order polynomial. Then, we proceeded to the resampling of HRV image at a resolution of 30 m using the method of Nearest Neighbour. Thus, the RGB compositions of the two images corrected are shown in Fig. 22.3.

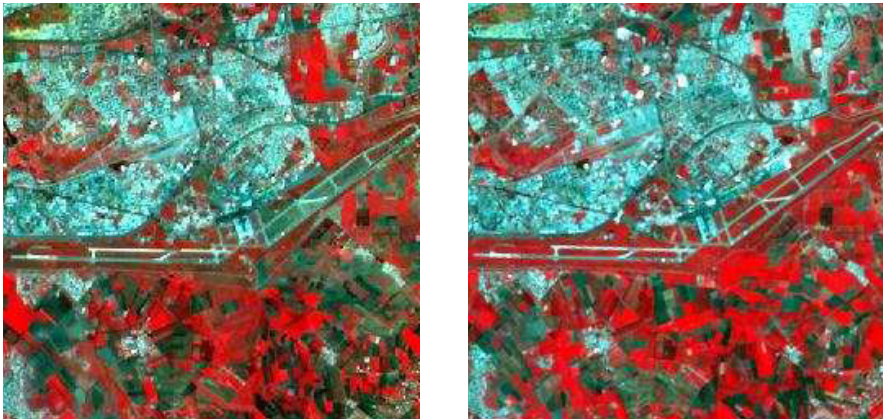

(a) SPOT HRV 1997

(b) Landsat ETM+ 2001

Figure 22.3: RGB composition of the Algiers scene, Algeria.

The methodology of fusion and classification adopted in this work is supervised based on a prior knowledge on the study site and the various themes which are there. Then, we extracted a training base and a test base for each image. These bases contain three thematic classes: Dense Urban (DU), Bare Soil (BS) and Vegetation (V) that have been identified and defined by an expert knowing well this area of study.

The validity of the choice of the three classes for the steps of training and evaluation is carried out and justified in [10]. Indeed, for the two images, we notice that the difference between the envelope of the three normal distributions associated with the three classes and the form of the real histogram is very negligible. This means that the two images are dominated by the three classes considered.

22.4.2 Fusion based on the free model

In a multitemporal study of a site, it is preferable to use a multitemporal data set acquired by the same satellite sensor on the same study area. However, we do not have this data set. Therefore, two multisource and multitemporal images were used in this study.

The improvement of the land cover maps obtained is based on the joint exploitation of the two essential characteristics of the sensors which provide the images. The first characteristic is the wealth of the spectral information of the image acquired by sensor ETM+ (six spectral bands) which allows a better identification and discrimination of the themes on the ground, and the second characteristic is the wealth of the spatial information of the image acquired by the sensor HRV (spatial resolution of 20 m) which allows a more detailed description of the objects.

The result of multisource classification and fusion obtained by the free model is given by Fig. 22.4.

The evaluation of this result will focus only on the invariant sites between the two dates of acquisition (1997 and 2001). The airport's runways are considered as invariant site and have not undergone any changes between the two dates of acquisition.

We note, from Fig. 22.4, that the multisource image obtained by the free model and more exactly the sites invariant of the airport's runways, constitute of the simple classes DU on which the two sensors of acquisition (ETM+ and HRV) give the same opinion with certainty, and of the compound classes (intersection of classes) like the classes $U \cap V$, $(BS \cup V) \cap U$ and $BS \cap V$, on which the two sensors give different opinions, *i.e.*, there is a confusion between the two sensors.

By taking a pixel located in the airport's runways, belonging to the class of intersection $U \cap V$ generated by the free model, we note that its spectral signature in image HRV corresponds to the signature of the class U, and that its signature in image ETM+ thus corresponds to the signature of the class V, the attribution of this

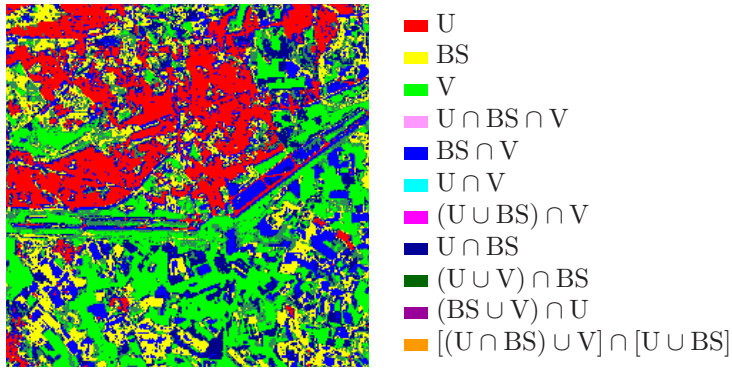

Figure 22.4: Result of multi-source fusion based on the free model. U: Urban area, V: Vegetation, BS: Bare soil.

pixel to the class $U \cap V$ is well justified (see Fig.22.5).

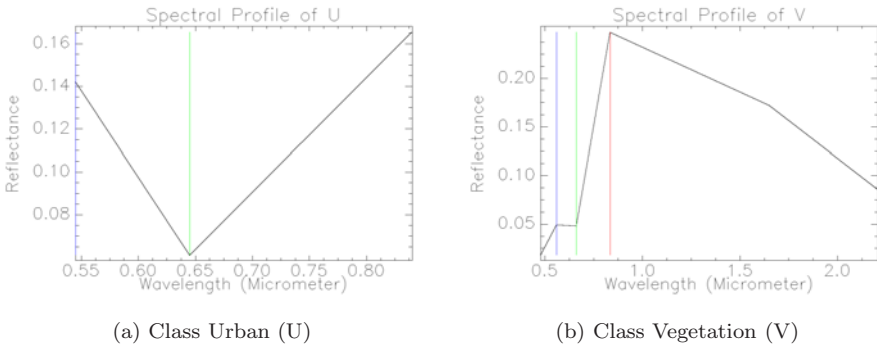

Figure 22.5: Spectral signatures of the classes Urban (HRV 1997) and Vegetation (ETM+ 2001) in the invariant site of airport’s runways by the free model.

The evaluation of the result in the case of multitemporal fusion will carry only on the sites varying between the two dates (1997 and 2001). We take as an example of variant sites, an agricultural zone located at the south of the airport.

We note that the multitemporal image obtained by the free model in more exactly the variant sites, constitute of simple classes representing the stable zones as the class V not having undergone any change, and of the compound classes representing the zones of changes during the time considered, as the class of intersection $BS \cap V$ which is an unstable zone.

By taking a pixel, located in the agricultural zone, belonging to the class $BS \cap V$ generated by our methodology, we notice that its spectral signature in image HRV corresponds to the signature of the class BS, and that its signature in image ETM+ corresponds to the signature of the class V (Fig. 22.6). Therefore, the attribution of this pixel which changed class BS towards V to the class $BS \cap V$ is well justified.

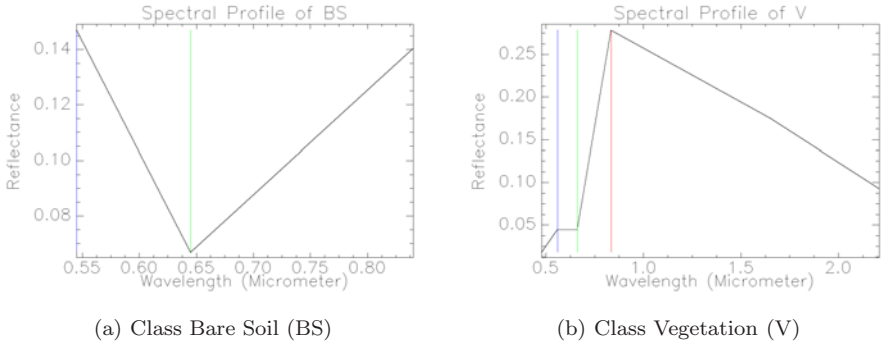

Figure 22.6: Spectral signatures of the classes Bare soil (HRV 1997) and Vegetation (ETM+ 2001) in the variant site of the agricultural zone by the free model.

The result of the binary changes detection between 1997 and 2001 by multisource and multitemporal classification and fusion using the free model is given in Fig. 22.7. The simple classes represent the no change (in black), on the other hand the compound classes represent the change (in white).

From a qualitative evaluation of this image, we see that there are a great dynamics in the study area between the two dates considered, an evolution of the thematic classes “bare soil” and “vegetation” in the south of the airport which is due one side, to the clearing of the land agricultural and another side to the farm of the bare areas and a dense urbanization in the north of the airport, in particular in the area of El Hamiz.

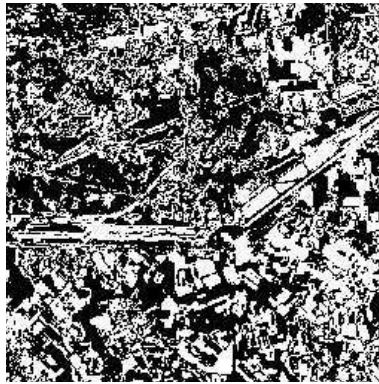

Figure 22.7: Binary changes image between 1997 and 2001 obtained by the free model.

22.4.3 Fusion based on the hybrid model

From a prior knowledge on the study area, we take as constraint, the proposition: $U \cap V$. Therefore, the set of the focal elements of D^Θ is reduced to the following set:

$$\{U, BS, V, U \cup BS, U \cup V, BS \cup V, U \cup BS \cup V, U \cap BS, BS \cap V, (U \cup V) \cap BS, (U \cap BS) \cup V, (BS \cap V) \cup U\}.$$

Decision making will be done on the simple classes and the classes of intersection, by neglecting the masses associated to the unions of classes which are very weak. These classes are:

$$\{U, BS, V, U \cap BS, BS \cap V, (U \cup V) \cap BS\}.$$

The result of multisource classification and fusion based on the hybrid model is given by Fig. 22.8.

The evaluation of the result obtained by multisource fusion using the hybrid model will always focus to the invariant sites between the dates 1997 and 2001. We note that the multisource image obtained by the hybrid model $M(\Theta)$ and more exactly in the airport's runways constitutes of pure classes as the class U on which the two sensors give a common opinion and the class of intersection as the class $BS \cap V$ on which the two sensors give a different opinion. This result is well illustrated by the trace of the spectral signatures (Fig. 22.9) of a pixel of airport's runways the belonging to the class of intersection $BS \cap V$.

In multitemporal fusion, we see that there is a change of themes which has occurred on the agricultural zone in the south of the airport. A great change of the Bare Soil (origin) towards Vegetation (destination). The validation of this result is

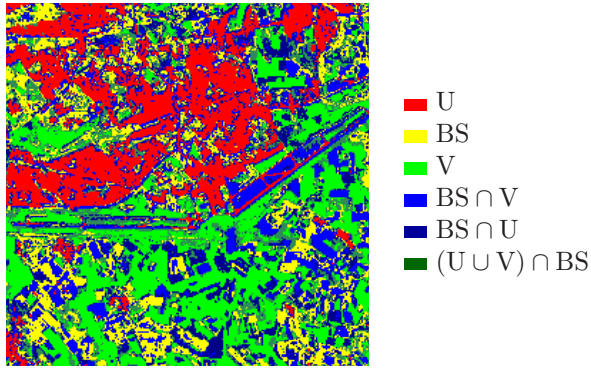

Figure 22.8: Result of multi-source fusion based on the hybrid model.

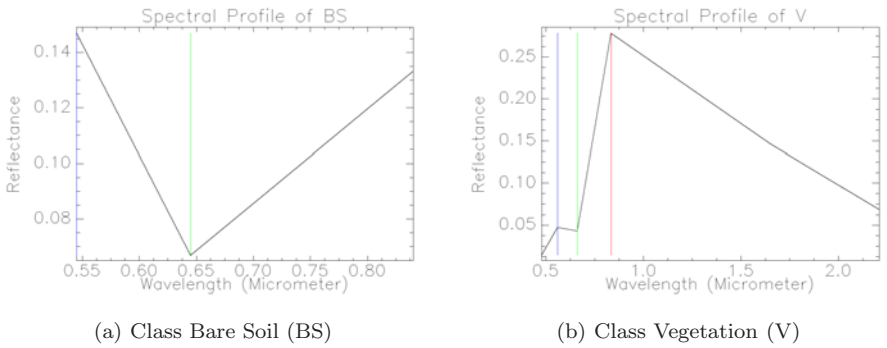

Figure 22.9: Spectral signatures of the classes bare Soil (HRV 1997) and Vegetation (ETM+ 2001) in the invariant site of the airport’s runway by the hybrid model.

done by taking a pixel belonging to the class $BS \cap V$ and then, to observe its variation between 1997 and 2001.

From the spectral signatures of Fig. 22.10, we see that a pixel of the class “Bare Soil” in this variant site in 1997 changed class after four years towards the simple class “Vegetation”.

In the multisource and multitemporal fusion using the hybrid model, the binary changes map obtained is the same one as for the free model, that is due to the decision

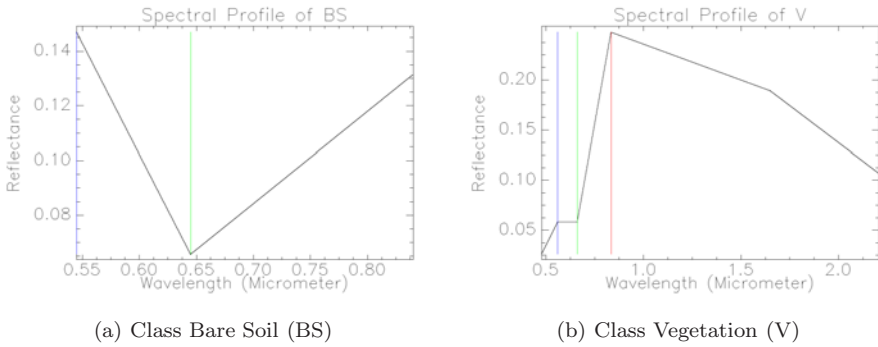

Figure 22.10: Spectral signatures of the classes Bare Soil (HRV 1997) and Vegetation (ETM+ 2001) in the variant site of the agricultural zone by the hybrid model.

rule which we applied. The pixels which represent no change (simple classes) are the pixels which belong to the same simple class in the two results obtained by Maximum Likelihood (ML). On the other hand, the pixels which represent the change are the pixels which belong to compound classes.

The only difference between both change maps is at the level of the compound classes. In case of the free model, the number of change classes is greater than the number of change classes in case of the hybrid model.

22.4.4 Comparison between the free and hybrid models

After having obtained the land cover map and changes map using the free and hybrid models of DSMT, we carried out a comparative study between these two models. The various results of this study are listed on Table 22.1.

22.5 Conclusion

Multisource classification using the free model of DSMT presents an image composed from simple classes on which both acquisition sensors (ETM + and HRV) express the same opinion, and compound classes (intersection of classes) on which the two sensors express different opinions, relatively to the multitemporal classification that provides a changes map composed of simple classes representing stable areas which have not undergone any change, and compound classes represent the change areas

	Free model	Hybrid model
Cardinality of hyper-power set	Important, according to the number of Dedekind	Reduced, according to the introduced constraints
Computing time	Important and for $n \geq 6$ very important	Acceptable
Size of memory needed	Important and for $n \geq 6$ insufficient	Sufficient
Obtained image	Includes non-significant classes	Includes more realistic classes

Table 22.1: Comparison between the free model and the hybrid model.

during the time considered. To obtain these results, we require much computing time. On the other hand, the hybrid model allows to have maps composed of classes more significant and concordant with the ground reality. The results obtained will be exploited in cartography.

We propose as possible prospects for our work: the integration within the fusion/classification process different types of satellite data known as heterogeneous for example: the contextual information or a satellite image from SAR (Synthetic Aperture Radar) to include topographic information or relief of the surface to classify for a more realistic and optimal, the use of the recent data and the update of the training base, the use of other rules of combination such as the PCR5 (Proportional Conflict Redistribution), URR (Uniform Redistribution Rule), PURR (Partially Uniform Redistribution Rule).

22.6 References

- [1] A. Appriou, *Probabilités et incertitude en fusion de données multi-senseurs*, Revue Scientifique et Technique de la Défense, Vol. 11, pp. 27–40, 1991.
- [2] I. Bloch, *Fusion d'informations en traitement du signal et des images*, IC2. Hermès Science, Paris, France, 2003.
- [3] A. Bouakache, *Fusion des images satellitaires par la théorie d'évidence et la théorie du raisonnement plausible et paradoxal*, Mémoire de magister en électronique, spécialité traitement du signal et d'images, Université des Sciences et de la Technologie Houari Boumediene, Bab Ezzouar, Alger, Algeria, 2005.
- [4] S. Corgne, L. Hubert-Moy, J. Dezert and G Mercier, *Land cover change prediction with a new theory of plausible and a pradoxical reasoning*, in [13].
- [5] A. P. Dempster, *Upper and lower probabilities induced by a multivalued mapping*, Annals of Mathematical Statistics, Vol. 38, no. 2, pp. 325–339, 1976.

- [6] J. Dezert, *An introduction to the theory of plausible and paradoxical reasoning*, in Proc. of NM&A 02, pp. 20–24, Borovetz, Bulgaria, Aug. 2002.
- [7] J. Dezert, *Fondations pour une nouvelle théorie du raisonnement plausible et paradoxal: Application à la fusion d'informations incertaines et conflictuelles*, Tech. Rep. 1/06769 DTIM, ONERA Tech. Rep., 2003.
- [8] J. Dezert, F. Smarandache, *On the generation of hyper-power sets for DS_mT*, in Proc. of Int. Information Fusion Conf., pp. 1118–1125, Cairns, Australia, 2003.
- [9] J. Dezert and F. Smarandache, *Partial ordering of hyper-power sets and matrix representation of belief functions within DS_mT*, in Proc. of Int. Information Fusion Conf., pp. 1230–1238, Cairns, Australia, 2003, .
- [10] R. Khedam, A. Bouakache, G. Mercier and A. Belhadj-Aissa, *Fusion multirate à l'aide de la théorie de Dempster-Shafer pour la détection et la cartographie des changements : application aux milieux urbain et périurbain de la région d'alger*, Télédétection, Vol. 6, no. 4, pp. 359–404, 2006.
- [11] S. Le Hégarat-Masclé, I. Bloch and D. Vidal-Madjard, *Application of Dempster-Shafer evidence theory to unsupervised classification in multisource remote sensing*, IEEE Trans. Geosci. Remote Sensing, vol. 35, no. 4, pp. 1018–1031, 1997.
- [12] S. Le Hégarat-Masclé, D. Richards and C. Ottlé, *Multi-scale data fusion using Dempster-Shafer evidence theory*, Integrated Computer-Aided Engineering, IOS press, 2003.
- [13] F. Smarandache, J. Dezert (Editors), *Advances and Applications of DS_mT for Information Fusion (Collected works)*, American Research Press, Rehoboth, U.S.A., 2004.
- [14] F. Smarandache, J. Dezert (Editors), *Advances and Applications of DS_mT for Information Fusion (Collected works)*, vol. 2, American Research Press, Rehoboth, U.S.A., 2006.
- [15] F. Smarandache, J. Dezert, *Fusing uncertain, imprecise and paradoxical information (DS_mT)*, Information & Security an international journal, Vol. 20, pp. 06–152, 2006.
- [16] G. Shafer, *A Mathematical Theory of Evidence*, Princeton University Press, Princeton (NJ), 1976.
- [17] Ph. Smets, *The combination of evidence in the transferable belief model*, IEEE Trans. Pattern Anal. Machine Intell., Vol. 12, no. 5, pp. 447–458, 1990.

Chapter 23

Information fusion for natural hazards in mountains

Jean-Marc Tacnet
CEMAGREF,
2 rue de la Papéterie,
38402 St Martin d'Hères,
France.
jean-marc.tacnet@cemagref.fr

Mireille Batton-Hubert
ENMSE,
158 cours Fauriel
42023 Saint-Etienne,
France.
batton@emse.fr

Jean Dezert
ONERA,
29 Av. Div. Leclerc,
92320 Châtillon,
France.
jean.dezert@onera.fr

Abstract: *From a real case application based on snow-avalanche risk management, an integrated framework mixing evidential reasoning and multi-criteria decision analysis (ER-MCDA) is proposed. This methodology considers a simplified decision sorting problem based on qualitative and quantitative criteria on which more or less reliable sources provide uncertain and imprecise evaluations. The Analytical Hierarchy Process (AHP) is used both to model the problem in a conceptual way and to elicit preferences between key criteria. Fuzzy Sets and Possibilities theories are used to transform quantitative and qualitative criteria into a common frame for Dempster-Shafer Theory (DST) and Dezert-Smarandache Theory (DSmT). It is shown that DSmT offers an interesting framework to take incomplete information into account and we use it for decision-making. Evidential reasoning allows merging different uncertain and incomplete pieces of information to identify the sensitivity of an avalanche prone area and to determine an avalanche hazard map. This approach emphasizes some implementation guidelines based on a Unified Modeling Language (UML) of the problem. We point out also some important issues of information fusion such as basic belief assignment elicitation, conflict identification, fusion rules choice and results validation.*

23.1 Introduction

23.1.1 Natural hazards in mountains

How and why expertise is needed in the risk management process?

Natural hazards in mountains such as snow avalanches or floods threaten human or material stakes with sometimes dramatic consequences including damages for people and material assets (see FIG. 23.1).

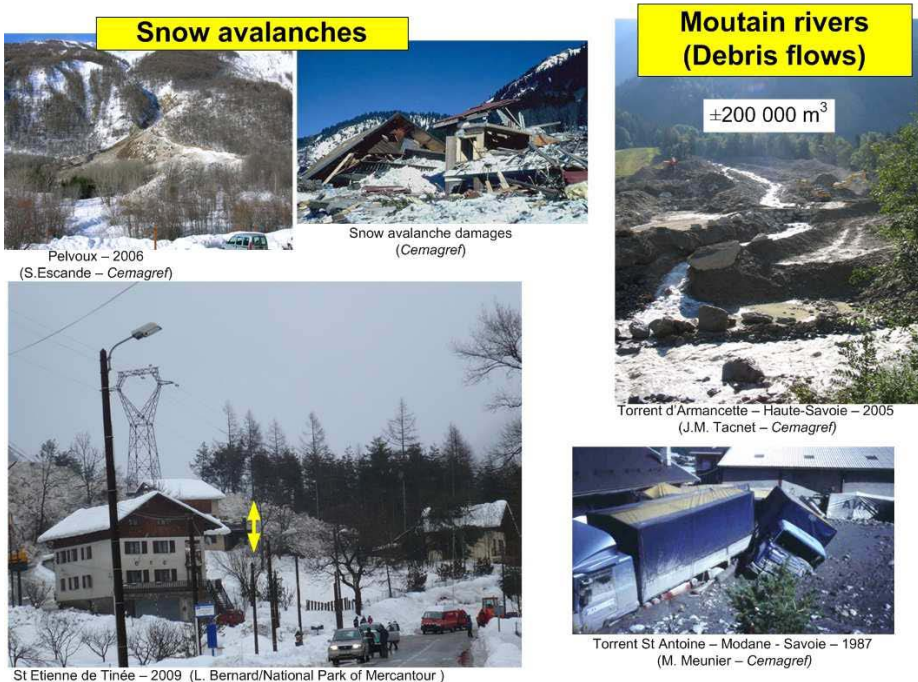

Figure 23.1: Examples of natural hazards in mountains.

The effects of physical phenomenon on existing stakes such buildings, persons, infrastructures are cross-analyzed with their temporal occurrence. In a classical way, risk can be considered as a combination of *Hazard level* and *Vulnerability* (see FIG. 23.2):

- Hazard level** represents the physical effects of a natural phenomenon described through its intensity and frequency. This produces a hazard level factor mixing frequency and intensity. For a snow avalanche, the effects can be snow deposition, impacts of avalanche and/or blocks, trees carried by the flow, etc. For debris flows, the effects can be the static and/or dynamic pressure due to the height of fluid, the impacts of blocks, etc. The more intense and frequent is the phenomenon, the higher will be the hazard level. A same hazard level can be due either to a very frequent phenomenon with low-medium intensity or to a rare event with high intensity (potential effects);
- Vulnerability** represents the consequences due to the direct physical or indirect effects of the phenomenon on people, material assets, organization. These consequences correspond to losses or damages which are first described in a physical way and then valued according to their economic value for material assets and evaluate a risk level.

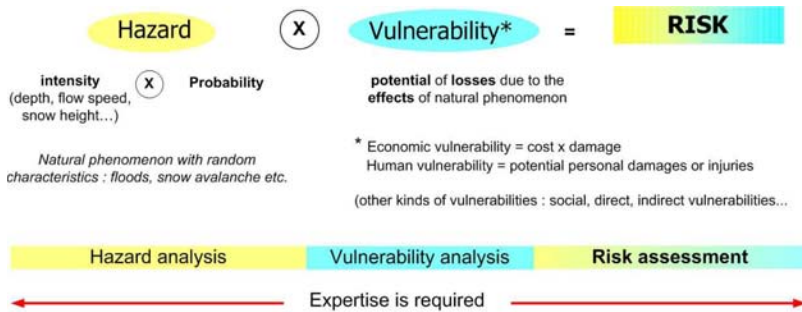

Figure 23.2: Risk is a combination of hazard and vulnerability.

Risk management can be also viewed as a decision process : in a given situation, several strategies do exist to reduce the level of risk [Tacnet and Richard 2008]. Prioritization and choice have always to be done by the decision-makers (ministries, local authorities, private companies or technical staff involved in risk management). The *risk management process* can be considered as a combination of decisions related both to the temporal steps of the physical process and to the functional steps of the risk management framework in itself. Therefore, decision support systems are helpful to propose synthesis of the different criteria involved in the decision. To a certain extent, the decision process when it dysfunctions can also induce disasters [Weichselgartner and Bertens 2000].

23.1.2 Experts are expected to manage and integrate the overall uncertainty

In a natural hazard context, the practical implementation of these principles will concern approaches going from physical phenomenon description (the risk analysis) to risk evaluation and management. Risk analysis begins with the hazard assessment. It requires first to identify the phenomena and the physical processes such as triggering, propagation and deposition. These processes correspond to the successive temporal steps of phenomena. This begins with a qualitative description of the different phenomenon that have already occurred or that may occur in the risk basin. For each step, different characteristics related to the possible effects are analyzed by the experts. For avalanche risk analysis, experts collect and choose parameters that are used to define the intensity and characteristics of the reference phenomena: the expertise process can be seen as a serial of decisions related to the different parameters (see FIG. 23.3). In a second step, frequency of the phenomena is evaluated. Data sources are historical information, pictures, hydrological chronicles, topographic information. Risk analysis consists afterwards in the estimation of consequences on exposed people and assets.

All over this expertise process, uncertainty arises both from expert basic knowledge of the different phenomena, the intermediate tools such as models, the expert evaluations for data collection and finally from the decision step. In most of cases, choosing limits on continuous physical values does not make much sense: if a natural slope is supposed to highly contribute to the sensitivity level of an exposed site and if its inclination is over 30%, what should we think of a 28% slope? Reasoning on classes with artificial thresholds does not correspond to the reality. In the natural hazards risk management context, there is a great need for tools and methodologies that allow considering both uncertain and imprecise information. Specific needs and developments about uncertainty in natural hazards risk management processes concern floods [Apel et al. 2004, Van Der Most and Wehrung 2005], rock-falls in relation with spatial data accuracy [Dorren and Heuvelink 2004], debris-flows [Lin et al., 2004] or snow-avalanches [Barbolini and Savi 2001].

This justifies the development of general framework to consider decision and uncertainty.

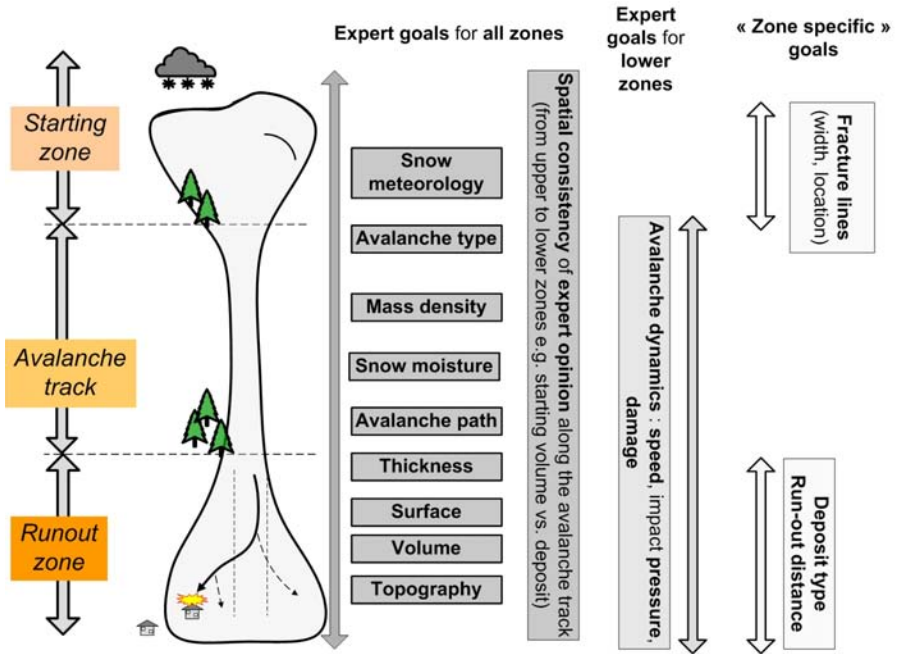

Figure 23.3: Expertise required during the hazard analysis step.

The problem complexity requires using different approaches to analyze the risk situation: descriptive and qualitative approaches are used as well as numerical modeling. In many cases, they must be considered as complementary [Ancey 2006]. Involving experts whose backgrounds, methods are different is as useful as necessary to capture all the complexity of the studied phenomena [Lacroix 2006]. Natural hazards expertise consists in a complex framework involving several decision levels based on incomplete and uncertain information (see FIG. 23.4). Expertise is required to fill the gap between the needs and the available knowledge. This lack of knowledge can exist at different stages of the *risk management process* and can be due to incomplete historical information describing the extension area [Tacnet et al. 2006], lack of scientific knowledge, unknown phenomenon scenarios but also to insufficient means (time, money) for risk analysis and evaluation, etc.

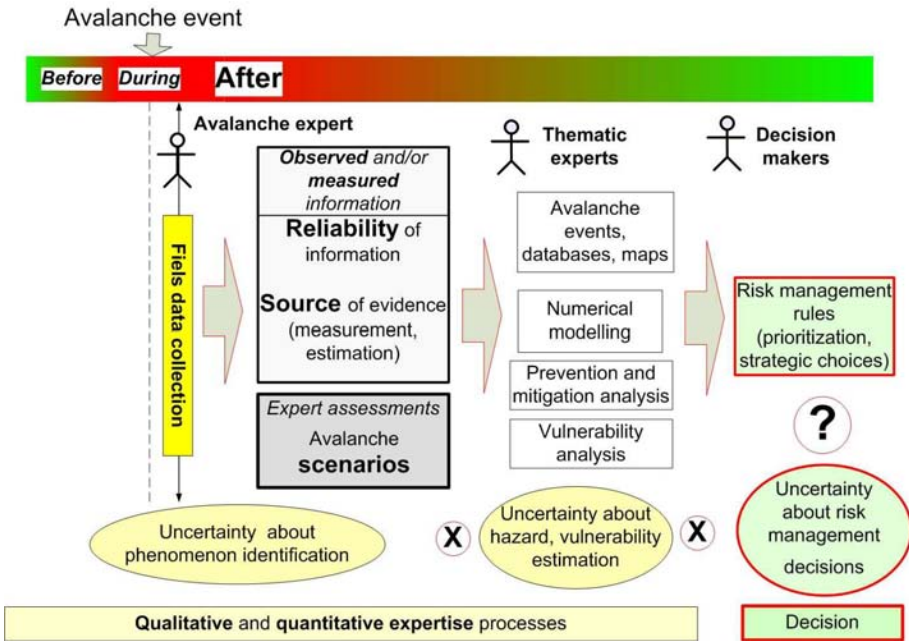

Figure 23.4: The uncertainty comes from the different steps of the expertise.

Expertise is therefore the result of multiple thematic evaluations based on more or less reliable and conflicting sources. All the different steps of the expertise are based on uncertainties that will influence the final result. At the end, the whole expertise process appears as a sequential process ranging from primary and more or less uncertain data to the processed data (or decision) is quite difficult to trace in a detailed way. It is therefore possible to settle decision on very uncertain hypothesis without being really able to know it precisely (see FIG. 23.5). Even when advanced tools such as numerical modeling are used for hazard and risk assessment, the experts always never consider the results directly as decisions but always interpret to provide an operational result [Tacnet et al. 2005a]. This reality corresponds to the difference between decision-aid and decision-making [Roy 1990].

23.1.3 A more realistic description of the expertise process

Expertise is expected to help for decision-making in poor available knowledge conditions but appears as a very paradoxical and difficult exercise. Uncertainty and imprecision do exist on their main steps because of lack of data and knowledge without being clearly elicited. Final results often come from various sources whose reliability and mutual conflict are not easily traced all along the technical decision process.

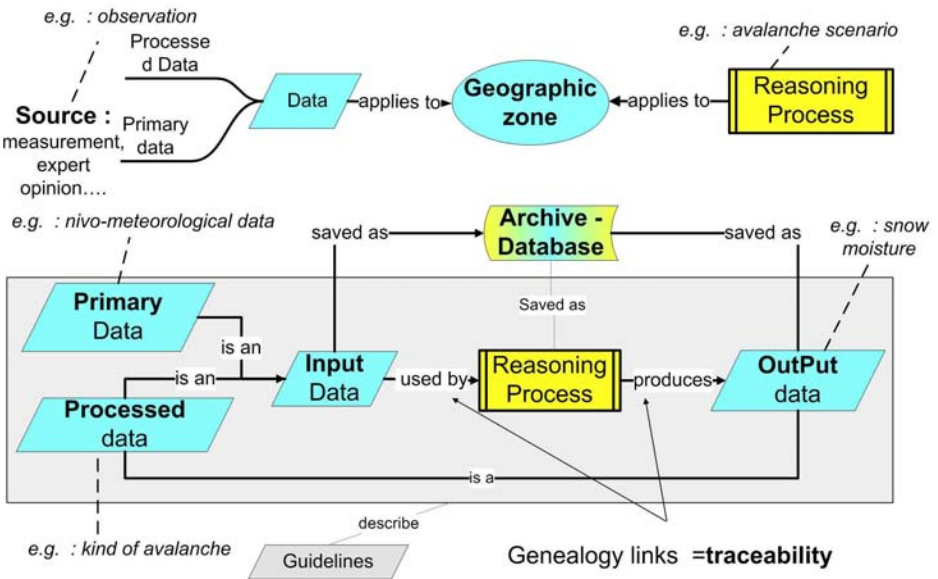

Figure 23.5: From primary data to processed data in the expertise process.

Uncertainty does not affect equally all the decision parameters which are themselves known to be more or less important.

Three main questions can therefore be pointed out:

- Can we find theoretical frameworks that would help decision-making and would be able to represent in a more realistic way the available knowledge level, the reliability of sources and the uncertainty of their evaluations?
- How far can we be confident in the expertise results? How can we make a link between a decision and the way it was obtained: what is the global confidence in the result? do all the sources agree with this result (in particular when results come from contradicting positions and criteria)?
- Assuming that we are able to describe and evaluate the uncertainty sources, how can we make a decision that would be considered?

This chapter proposes an alternative methodology to the classical risk evaluation method used in the natural hazards mountains management. It is based on a combination of a multi-criteria hierarchical method and Evidence Theory based approaches. We present a mixed framework involving both information fusion and multi-criteria decision analysis (MCDA) in the context of natural hazards in mountains. In the next

sections, we focus on the different ways to introduce evidential reasoning in a multi-criteria decision analysis model. In Section 23.2, we briefly remind of formal theories to manage uncertainty insisting on the advantages of the DST and DS_mT. We also present multi-criteria methods and the way they can use or consider uncertainty in the DST context. Section 23.3 focuses on methodology used to mix multi-criteria approach and information fusion. Section 23.4 deals with two applications. The first one is a simplified version of a global framework to analyze the exposure level of a snow-avalanche prone area. The second one relates to the risk zoning methodology and focuses on specific points related to spatial applications. Section 23.5 is a general discussion and section 23.6 is the conclusion.

23.2 Backgrounds on MCDA and evidential reasoning

Managing uncertainty requires being able to analyze its sources, to evaluate it and to propagate it through the evaluation process. This section briefly presents existing approaches for decision based either on multi-criteria decision analysis (MCDA) and evidential reasoning (ER).

23.2.1 Multi-criteria decision analysis

23.2.1.1 MCDA methods

MCDA is usually used in cases where optimization is not efficient.

In the decision theory, the first theory developed in Economics [Von Neumann and Morgenstern 1967], the concept of *decision under risk* corresponds to situations where objective probabilities of events can be calculated. In that context, the decision relies on the maximum of expected utility. Due to the complexity of real-life problems and the limited rationality of human decision, the concept of utility and optimum for decision have been criticized [Scharlig 1985, Roy 1989, Climaco 2004] leading to the development of alternative methods for decision-making known as multi-criteria methods. Decision support systems based on multi-criteria paradigm try to reach a compromise through various aggregation methods. Several methods are available to produce an evaluation of solutions or alternatives but none of the numerous existing multi-criteria decision aid methods can be considered as a perfect and universal method that would be appropriate for any decision problem. A comparative analysis has been handled by [Guitouni and Martel 1998] to propose some guidelines for choosing the ad-hoc method. Another review is proposed by [Linkov et al. 2006] in the context of environmental comparative risk assessment.

Multi-criteria decision analysis mainly focuses on reaching a compromise between those sources. Most of existing methods have been initially developed to consider only one decision maker [Jabeur and Martel 2005]. Others approaches related to group-decision making consider the case of several decision-makers. In such cases, compromises are searched between at the valuation level.

A complete review of all the MCDA methods would be difficult. Two main classes of methods can be distinguished: those whose final evaluation is the result of a complete aggregation process as *Analytic Hierarchy Process* (AHP), *Multi Attribute Utility Theory* (M.A.U.T.) and those based on an incomplete aggregation process or outranking methods such as *ELECTRE* or *PROMETHEE*. The first category of methods is widely used in Anglo-Saxon community which is sometimes described as the "MCDA¹ American school" (MCDA). The second class corresponds to the so-called "MCDA European school". The complete aggregation methods have been criticized notably because they do not consider un-comparability and preferences un-transitivity. [Guitouni and Martel 1998] proposes some guidelines to choose a MCDA framework between all the existing methods. We only cite here elements of comparison between three advanced MCDA methods [Linkov et al. 2006, Guitouni and Martel 1998]:

- **MAUT or MAVT:** The Multi-Attribute Utility Theory (MAUT) [Keeney and Raiffa 1976] or Multi-Attribute Value Theory (MAVT) is certainly the MCDA method which looks like the classical decision theory in a closer way. MAUT relies on the hypothesis that decision-maker is rational (he prefers more an higher utility level than a lower one), that he has perfect knowledge and that he is consistent in his judgments. For each attribute, the decision maker must be able to propose a utility function (using as example indirect methods such as UTA);
- **AHP:** The Analytic Hierarchy Process (AHP) [Saaty 1980] is a single synthesizing criterion approach. It uses pairwise comparisons with a semantic and ratio scale to assess the decision maker preferences. The axiomatic foundations suppose that there must be outer and inner independence between the different hierarchical levels.
- **ELECTRE:** This outranking synthesizing method [Roy 1968] is based on the principle that one alternative may have a degree of dominance over another. Dominance occurs when one option performs better than another on at least one criterion and not worse than the other on all criteria. These methods accept and manage potential un-comparability between different criteria through as an example, the principle of discordance in ELECTRE methods.

¹multi-criteria decision analysis

Three main problematics are identified to describe the MCDA methods which are presented in FIG. 23.6 below.

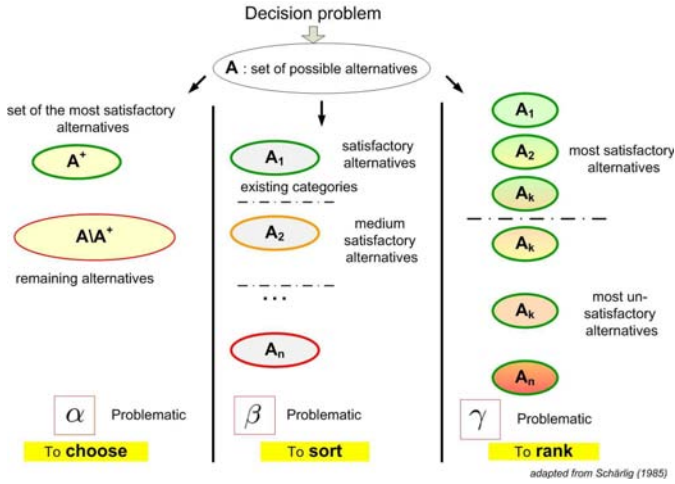

Figure 23.6: Main problematics addressed by MCDA methods [Scharlig 1985].

The main steps of a multi-criteria analysis can be summarized as follows:

1. decision purpose identification;
2. criteria identification;
3. preferences between criteria;
4. evaluation;
5. sensitivity analysis with regard to weights, thresholds, ...

MCDA: an useful tool to aid decision and elicit the natural hazard expert reasoning process.

From a conceptual point of view, Risk evaluation is based on a combination of hazard and vulnerability. In most cases, this combination appears more as an expert choice than a real deterministic process based on a precise quantification. This is due both to the uncertainty attached to the two parts of the global risk equation. In Risk Prevention Plans, expert choices are often the main sources for risk zoning. A so-called risk equation is supposed to be used but in fact its terms are not evaluated on the same scale. Some recent progress does exist with the use of deterministic

modeling in connection with protection works. A risk level can be calculated and optimized using Bayesian probabilistic framework. The risk level is optimized on the basis of a utility economic function.

23.2.1.2 The original Analytic Hierarchy Process (AHP)

The Analytic Hierarchy Process (AHP) method is world-wide used in almost all applications related with decision-making [Vaidya and Kumar 2006]. AHP is a special case of complete aggregation method and can be considered as an approximation of multi-attribute preference models [Dyer 2005]. Its principle is to arrange the factors considered as important for a decision in a hierarchic structure descending from an overall goal to criteria, sub-criteria and finally alternatives in successive levels (see FIG. 23.7). It is therefore based on three basic principles: decomposition of the problem, comparative judgments and hierarchic composition or synthesis of priorities.

At each level, a preference matrix is built up with pairwise comparison between the criteria of each level [Saaty 1982, Saaty 1990]. Through the AHP pairwise comparison process, weights and priorities are derived from a set of judgments that can be expressed either verbally, numerically or graphically [Forman and Selly 2002]². It can be considered as a kind of conjunctive consensus between different criteria evaluation. The original AHP method uses an additive preference aggregation.

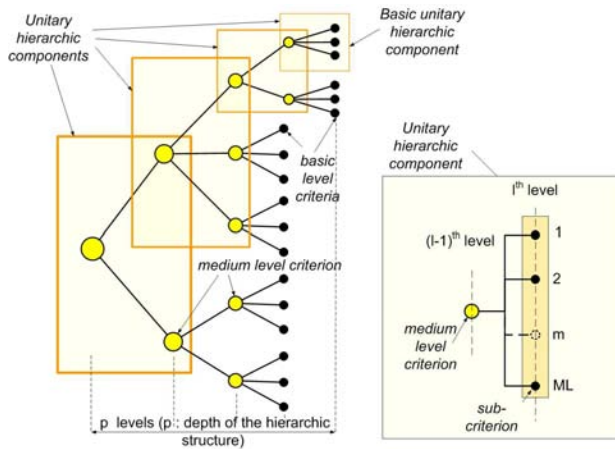

Figure 23.7: A multi-criteria hierarchical structure is broken down into unitary hierarchic components.

²p.45

The final evaluation index is the result of a sum of products of weights from the tree root to the leaves (see FIG. 23.8). At the leaf level, the evaluation expert has to choose in an exclusive way between several classes.

To implement the AHP method, two different strategies can be used to provide valuations of alternatives on which we want to make a decision. The original AHP process consists in comparing the solutions from one to each other in a so-called "Criterion-alternative approach". This implies to make pairwise comparisons between all the solutions or alternatives in order to obtain preferences levels between these alternatives. A methodology based on a relative verbal scale is provided to calibrate the numeric scale for measurement of quantitative as well as qualitative performances (see FIG. 23.9). When dealing with great amount of data, this becomes quickly quite difficult. The preferences are here the result of a comparative approach of solutions according to criteria. It is impossible to calculate an index or a rating value for a unique solution.

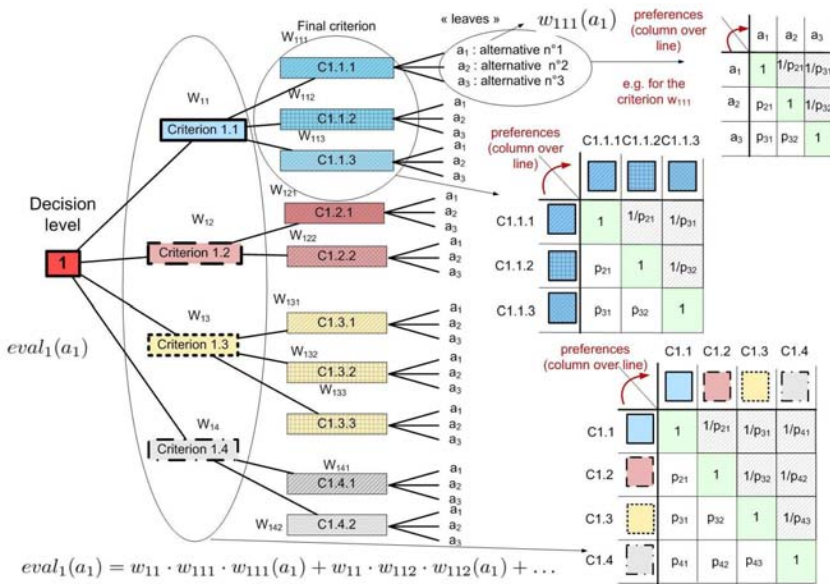

Figure 23.8: Principle of the Analytic Hierarchy Process (AHP).

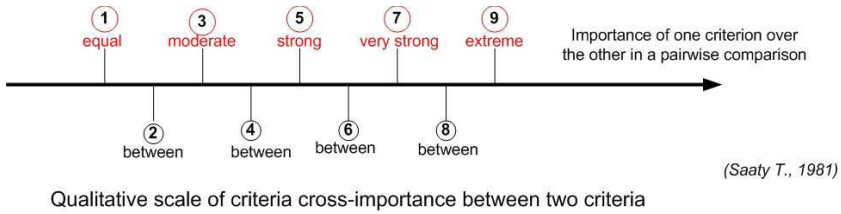

Figure 23.9: Saaty’s verbal scale for pairwise comparison.

A second approach so-called "Criterion-index (or estimator)-alternative" can be imagined (see FIG. 23.10). Instead of comparing all the alternatives, the decision analyst proposes classes for each criterion. To a certain extent, these classes correspond to an increasing or decreasing level of satisfaction of a given criterion. These classes code some kind of ordinal levels corresponding to a low, medium or strong contribution (or satisfaction) to (or of) the criterion. For example, the criterion *human vulnerability* exposed to natural hazards can be assessed according to three classes based on a number of existing and exposed buildings. This approach prevents from the well-known "Rank reversal" problem of the AHP method [Wang and Elhag 2006]: introducing twice the same alternative modify its relative rank compared to all the others unchanged alternatives. In that way, the AHP method, despite the known issues of complete aggregation methods, fits quite well to decision ranking problems where the alternatives are not all known.

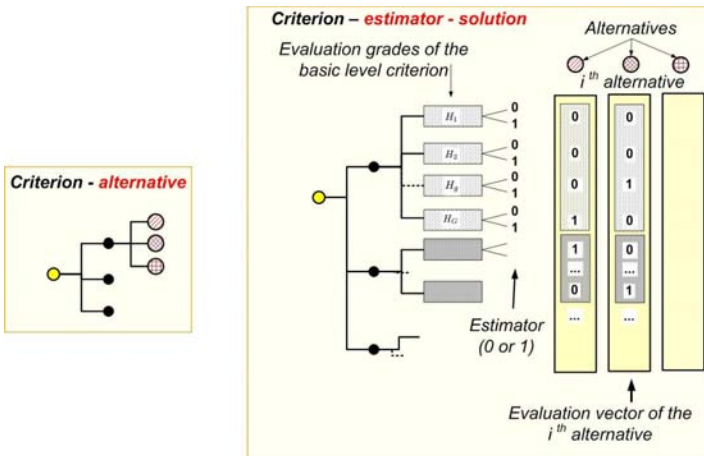

Figure 23.10: Criterion-Alternative and Criterion-Estimator-Solution approaches.

23.2.1.3 Uncertainty and MCDA methods

Uncertainty and imprecision in multi-criteria decision models has been early considered [Roy 1989]. Different kinds of uncertainty can be considered: on the one hand the internal uncertainty is linked to the structure of the model and the judgmental inputs required by the model, on the other hand the external uncertainty refers to lack of knowledge about the consequences about a particular choice. Formal modeling of uncertainties is necessary when risk and uncertainties are as critical as the issue of conflicting management goals [Stewart 2005].

Several different techniques have been used to manage uncertainty in the MCDA process. Fuzzy approaches have been introduced either in the *analytic hierarchy process* (AHP) context [Salo and Hamalainen 1995, Salo 1996], in the multi attribute value theory (MAVT or MAUT) preferences ratios based methods [Salo and Haimailaiinen 2001]. Interval judgments are introduced as an easy way to handle imprecise information [Mustajoki et al. 2005].

Fuzzy sets theory is used to consider, according to [Fenton and Wang 2006], risk and confidence of a decision maker in a multi-criteria decision making problem. Fuzzy number are then used to evaluate the performance index (weights) of the criteria ("risk attitude" depending on the decision attitude of the decision maker ranging from an optimistic to pessimistic) and to evaluate the alternatives denoted as a "confidence" level. Fuzzy approaches have been introduced into the AHP to evaluate the alternatives [Kuo et al. 2006, Pan 2008, Dweiri 1999]. This method can be (has already been) criticized [Linkov et al. 2006]³ notably on the basis of the aggregation issues and its ability to deal with uncertainty [Forman 1993]. [Saaty and Vargas 1987] has studied the way to consider uncertainty in the AHP process but considers that such an approach of fuzzifying the numerical judgments used in AHP has no interest since the numerical values used for pairwise comparisons already correspond to some fuzzy evaluation by the decision-maker [Saaty and Tran 2007]. Taking perturbations or catastrophes into account in the decision process was an earlier issue recognized by [Saaty 1990]⁴. He suggested to always including a criterion that would gather all what is unknown and represent a cluster of unforeseen threats in the decision model. He also considers that the AHP is able to manage uncertainty through its ability to elicit the subjective probabilities [Ozdemir and Saaty 2006].

More recently, the question of decision under risk has been addressed by Matos in [Matos 2007]. He suggests a two-step decision method. The first step consists in the evaluation of the alternatives according to their uncertainty level using different theories such as classical probabilities, fuzzy sets theory. The second step uses multi-criteria methods to interpret the result. He advocates that the "*transformation of a decision problem under uncertainty into a deterministic multi-criteria problem provides more meaningful information to the Decision maker*".

³p. 1076

⁴p.23, §10

The integration of multiple criteria decision analysis and scenario planning is presented as a future way of development. Scenario planning is a *“technique for facilitating the process of identifying uncertain and uncontrollable factors that may impact the consequence of decision in a strategic management context”*. Integration of external uncertainties in a mixed approach using MCDA and scenario planning is still a research challenge [Stewart 2005]. On this basis, the methodology proposed in the following sections tries to follow the main previous guidelines and principles:

- to evaluate the uncertainty about input evaluation (using the different theories for uncertainty and imprecision) and inject those results into a decision-aid method;
- to propose a scenario-based approach that would remain understandable for decision-makers. This scenario planning approach fits perfectly to the context of natural hazards where knowledge and objective probabilities are often lacking.

23.2.2 Evidential reasoning (ER)

Several theoretical frameworks exist to handle uncertainty in human reasoning and decision processes.

Three main theories are mainly used to handle uncertain and incomplete information in a decision process: probabilities, possibilities and evidence theories. Classical probabilities are the traditional tool for situations of incomplete information. Most of time, the decision processes used for risk evaluation supposes that objective probabilities are available for each component of the risk. This principle is considered as imperfect since probabilities and data used for numerical modeling often result from expert assessments. Moreover, these expert opinions in an uncertain context are known to be influenced by cognitive biases leading to different types of risk aversion [Ellsberg 1961]. For environmental or sustainable development related problems, other decision models are required: they should consider, from one hand, the risk evaluation step and from the other hand, the decision process itself [Magne and Vasseur 2006]⁵.

Probabilities are criticized especially when they are known to be highly subjective. Recent developments have studied the use of probability-possibility to improve decision making under uncertainty in the classical decision theory framework [Gajdos et al. 2008]. Subjective approaches of probability have been recently proposed according to Bayesian approaches (probability on probability law parameters). This Bayesian framework can take this subjectivity into account in a rigorous and axiomatically based framework. Soundappan et al. [Soundappan et al. 2004] states that Bayesian framework and evidential reasoning can be used to model uncertainty

⁵Chapter 12, p.397

and safety of a model when the available evidence consists of intervals bounding the values of input variables. Bayesian approach has recently been applied to snow avalanches context using large available data bases about avalanches extension to optimize the size of a passive avalanche defense structure [Eckert et al. 2008, Eckert et al. 2008a]. The decision application is based on (mostly economic) optimization principle. This "optimum" resulting from a complex calculation process is proposed as a unique result to the decision maker.

When data are not available, when experts judgments are essential part of the expertise process or to capture the reasoning hypotheses, this powerful probabilistic framework is not fully adapted. Alternative methods may be useful to complete this approach. Though probabilities remain the traditional tool and powerful tool for uncertainty management (as long as data are certain and available), others theories for uncertainty fit quite well to the context of expertise for natural hazards in mountains. *Fuzzy Sets*, *Possibilities* and *Belief Functions* theories can be used in the natural hazards management context to consider information at its effective level including uncertainty, imprecision, heterogeneity and reliability of sources. Nevertheless, evidential reasoning which has already been widely used in domains such as classification, cartography, expert systems, decision-making, . . . , as reviewed by [Sentz and Ferson 2002], has quite few applications in the natural hazards context [Binaghi et al. 1998].

Our methodology explores a way to introduce evidential reasoning and its more recent developments such as DS_mT theory in decision processes related to natural hazards management. Main goals are to make decision but also to trace the reasoning process used by the experts to build their judgments in the complex and uncertain context of natural hazards in mountains. The following section presents some notions about evidential reasoning. Basic principles of the belief function theory, and specifically *Dempster-Shafer* (DST) and *Dezert-Smarandache* (DS_mT) theories are widely and extensively described in the others chapters of this volume, and will not be described again. We will only focus on some interesting features and specificities of these theories in relations with our application context. Secondly, the fusion rules still work even in a high level of conflict between sources. The DS_mT theoretical framework appears as quite versatile but in fact it is quite difficult to find applications based on a non-exhaustive frame of discernment.

What is fusion?

Information fusion consists of merging or exploiting conjointly, several sources of information so as to answer questions of interest and make proper decisions [Dubois and Prade 2004]. The following definition was proposed: *”Fusion consists in conjoining or merging information that stems from several sources and exploited that conjoined or merged information in various tasks such as answering questions, making decisions, numerical estimation, ...”* from European working group *FUSION* cited in [Bloch et al. 2001].

In practice, fusion is operated through fusion rules that allow aggregating the more or less uncertain information issued from the different sources. The DST framework is based on exhaustive and exclusive hypotheses while DSmT framework does not require such constraints (e.g. in FIG. 23.33). In comparison with other theories, DST and DSmT offer a wide and powerful range of fusion methods to aggregate the different basic belief assignments (bba). An exhaustive review of the fusion rules has been proposed by [Sentz and Ferson 2002]. Their analysis also provide a valuable summary of the elements under consideration in a combination problem in DST context (see FIG. 23.11).

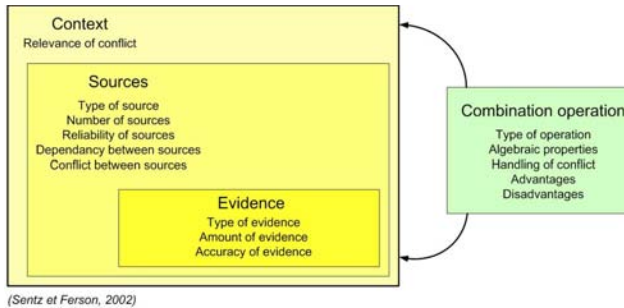

Figure 23.11: Elements under consideration for the fusion with DST.

For [Haenni 2002], there is no need for alternative fusion rules to classical Dempster’s fusion rule, refining the model is sufficient. Such argumentation doesn’t hold because the refinement becomes very hard to do when the cardinality of the frame of discernment and the number on non-empty intersections increases (the model’s complexity increases), and the elements of the refined space can have no physical sense/meaning/existence at all and finally they cannot truly be considered as useful finer exclusive information granules. Moreover, several authors such as [Smarandache and Dezert 2006b] and [Martin and Osswald 2006] show that alternative fusion rules perform better than the classical Dempster’s fusion rule in high conflict situation. For this reason, we will compare in our applications the classical normalized Dempster fusion rule with proportional conflict redistribution rule such as PCR6 rule. To illus-

trate the conflict level, we will also use in our application Smets' rule which transfers conflict on the empty set. From a general point of view, the fusion process depends on a great number of elements (see FIG. 23.11). A fusion approach used in a decision context implies four steps: modeling (often considered as the most difficult step), parameters estimation (depending on the model), combination and decision [Martin and Osswald 2006]. In the following section, we briefly analyze the existing approaches that use both MCDA and evidential reasoning.

23.2.3 Mixing MCDA and evidential reasoning

Trying to mix multi-criteria decision analysis (MCDA) and evidential reasoning (ER) quickly leads the question of the difference between aggregation of preferences and information fusion and therefore to the validity of an analogy between aggregation of preferences and data fusion. Data fusion is considered as a way to extract the truth between a set of hypothesis evaluated by different sources. Those two problems are considered as different: aggregation problem consists in deriving a global preference profile corresponding to a consensus between the preference profiles induced by the various sources [Dubois and Prade 2004]⁶. Fusion and aggregation should be considered as mainly different problems [Dubois and Prade 2006] while some applications do not make such a difference between the two application domains [Dubois et al. 2001]. Despite of these analysis, many authors have already introduced evidential reasoning (fusion) in MCDA frameworks (based on aggregation of preferences).

23.2.3.1 Existing approaches

Evidential reasoning and multi-criteria decision analysis have already been used in a common framework. In these approaches, data fusion is mainly applied either to the criteria considered as sources of a fusion process. Our analysis briefly focuses here on four main points: How do these models consider the complexity and the implicit hierarchy between criteria? How does the analyst extract the basic belief assignment elicitation? How is considered the difference between the importance and the uncertainty level linked to each criterion? Which fusion rules are used? Do they consider conflict? ER has been already combined with multiple attribute decision analysis (MADA) problems of both qualitative and quantitative nature [Yang 2001, Yang and Xu 2002, Yang et al. 2006]. Basic belief assignments (bba's) are derived directly from utility functions. A specific process, based on Dempster's rule of combination is used to mix criteria without specific consideration of conflict between sources (criteria). This methodology is applied to environmental problems [Wang et al. 2006].

Using Belief function theory and multi-criteria decision analysis requires evaluating all the criteria on the basis of the same frame of discernment. Including DST

⁶§5.2

or DSmT in a multi-criteria approach requires adopting a common frame of discernment. Total aggregation methods such as MAUT⁷ or AHP⁸ gather in a unique index the result of the evaluation of alternative. For the partial aggregation methods, such as *outranking methods*, un-comparability and intransitivity of preferences are basic paradigms: alternatives are compared to each other without aggregating all the criteria into one and only value. If we consider total aggregation methods, the attempt to mix multi-criteria approaches and evidence theory using a unique common frame of discernment for all the criteria does not sound initially so illegitimate.

Such an approach has been proposed by [Beynon et al. 2000] in a mixed framework called DS-AHP. His decision problem consists in choosing the best alternative between a complete set of alternatives according several criteria. Belief function theory is used essentially to reduce the high number of pairwise comparisons required when the number of alternatives increase. DS-AHP was first proposed as a way to compare sets of alternatives instead of unique alternatives [Beynon et al. 2000]. Preferences of each criterion are calculated according the classical pairwise comparison method. For each criterion, basic belief assignments are calculated on singletons or sets of alternatives on the basis of the perceived amount of favorable information in comparison with a total ignorance (i.e. the whole set of alternatives). The basic belief assignment (bba) on each evaluation grade or alternative is assessed through an indirect analysis of the "favorability" of knowledge. Each criterion is always compared to the whole set of hypothesis using a very specific pairwise comparison matrix. Some issues can be identified in its process:

- The mass elicitation mixes to different kinds of concepts: in the Belief function Theory, putting bba on a group of alternatives does not mean that all the included alternatives have the same level of information. On the contrary, it implies that knowledge is shared between all the groups without being able to put some more precise probability (of satisfying the criterion) on each of them. Reasoning on sets in the *Evidential reasoning* framework is not a faster way to put masses on singletons;
- As this principle mixes preferences and uncertainty in a unique bba, classical preference weights are then applied to reduce this bba without assigning any additional bba;
- Despite of the presumed ability to consider high number of alternatives, exposed examples only deal with rather small numbers of alternatives. With a high number of alternatives, reasoning with sets do not facilitate the decision since assigning basic belief assignments on sets mean that we are not able to share the knowledge between all the elements included inside. Taking a decision resulting from a fusion process is not that easy to interpret;

⁷Multi Attribute Utility Theory

⁸Analytic Hierarchy Process

- Decision rules used only use minimum or maximum of credibility and plausibility. In fact, the decision is possible only if some focal elements exist;
- Because of the use of the (grouped) pairwise comparison matrix, mass elicitation is sensitive to the number of levels in the evaluation scale [Beynon 2002]: a residual mass is always put on the total ignorance even whatever the choices of the decision analyst;
- Only a basic one level hierarchic model is considered. Criteria are considered as the only sources to be fused while several experts may proceed to evaluation;
- The fusion process is only based on the classical *Dempster's rule* known as a failure cause when the level of conflict increases.

This approach is presented as extended by [Hua et al. 2008] for the case where information is incomplete. However, we can consider here that *Beynon's* approach had only not emphasized this intrinsic ability of the belief function theory. Another extension of this method was proposed to consider a multi-expert environment [Beynon 2005].

23.2.3.2 Requirements for an ER-MCDA methodology

If the belief function theory appears as a powerful framework to consider both uncertainty and imprecision, one of its main drawback consists of choosing bba's to be used in the fusion process, especially when information only comes from expert judgments. Many different methods have been proposed to elicit those bba [Bryson et al. 1994, Wong and Lingras 1994]. Using a common scale in order to describe a reasoning process can consist of some kinds of correspondence tables between a common numerical or ordinal scale and evaluation made by the experts as used as an example to evaluate the damage level of dams: each failure piece of evidence is rated in a numerical scale corresponding to an increasing level of gravity [Curt 2008]. This difficulty does exist in our framework: at least, our proposition introduces a way to fully describe the decision process (from its design to the evaluation steps) in a less ambiguous and more complete manner.

Face to the problematic of expertise of natural hazards in mountains, our goal is a methodology that would allow to make decision such as determining the most dangerous areas, the best prevention strategy, ... according to the following requirements: on the one hand, the decision framework should allow and trace a multi-expert analysis of the criteria importances, on the other hand, the model should allow to gather the more or less uncertain, imprecise evaluations provided by more or less reliable different sources (data sensors, data-sets, expert judgments). Many combinations related to the nature and quality of information can be observed. A secondary criterion can be assessed in a very precise and certain way by a fully reliable source. On the contrary, an important criterion can be evaluated precisely, in a certain way by a not

reliable source. Our model aims to support decision in an uncertain context where several sources provide information about the problem. Its initial main purposes are not only to provide a help for decision but also to consider the way the decision is reached considering the reliability of sources and the uncertainty of information. The system must be able to model a complex hierarchical decision framework (some criteria are more important than others), different kinds of criteria (either qualitative or quantitative criteria). This versatile system (see FIG. 23.12) should therefore consider importance, uncertainty, imprecision and reliability in a multi-sources environment.

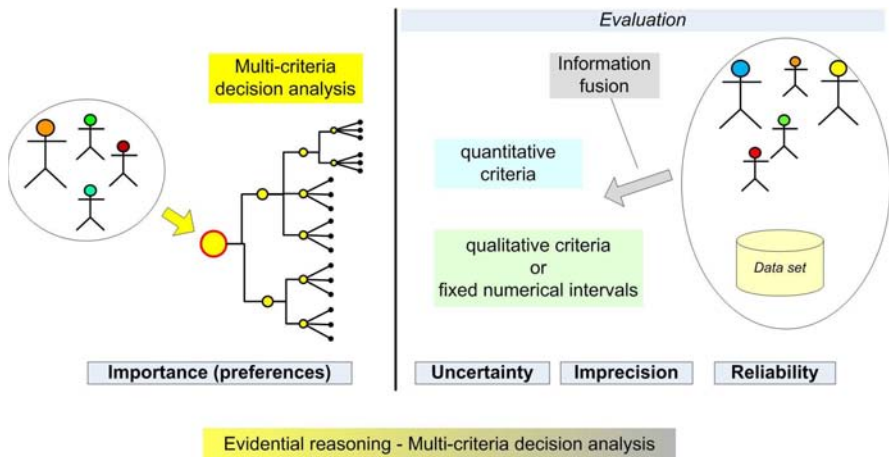

Figure 23.12: Principle of a versatile ER-MCDA.

We will use one of the most simple multi-criteria decision analyses (MCDA) method denoted as AHP recognized as a powerful and easy framework to help decision and reduce complexity in real-case decision situations. Our goal is to help decision but also to trace reasoning process. Evidential reasoning through *Dempster-Shafer* and *Dezert-Smarandache* theories is used to consider uncertainty and imprecision. The global methodology is presented in section 23.3 and a simplified application case in section 23.4.

23.3 ER-MCDA methodology

This section describes the global ER-MCDA framework and its two main parts: the multi-criteria model and the evaluation and fusion step. The proposed global methodology mixes those theories with an evidential reasoning (ER) process, known as a more general, versatile and integrating framework. These approaches are used in a multi-criteria decision framework. Many solutions do exist and we discuss in following sections some issues related to class level belonging, fusion order, etc.

What and how should we fuse?

Several *alternatives* or *actions* are evaluated according to different criteria through a preference relation. In addition to this, the evidential reasoning theories and their associated fusion rules are used to evaluate and propagate an uncertainty level in the decision process. This methodology considers both experts and criteria used in the hierarchic approach as sources in the fusion process. Different strategies to aggregate or fuse information are analyzed according to fusion rules, fusion order.

The methodology can be summarized as following:

- Identification and prioritization of criteria in a hierarchic MCDA framework;
- Definition of the frame of discernment considering either exclusive hypotheses (*Dempster-Shafer model*) or non exclusive hypotheses (*DSmT framework*).

In our problem, both quantitative (mainly related to physical data) and qualitative criteria are used in the model. Quantitative criteria are evaluated with some imprecision (corresponding to intervals values) and uncertainty (corresponding to a confidence level linked to these evaluations). The number of sources can also be different from one source to another. In that way, this model offers a versatile framework where several criteria are valued by several sources whose reliability and kinds of valuation (precise or imprecise way) may also change.

23.3.1 Possibility and Evidence Theory: why and what for?

In our context, expert evaluations often deal with continuous factors such as slope, surface, etc. These quantitative values are then linked to class levels according to a common qualitative scale enabling the fusion and/or aggregation process. A numerical value becomes correspond to a linguistic such as *high sensitive*, *sensitive*, *low sensitive*. This means that, for a given alternative (avalanche site), a numerical value would respectively, according to their relative importance in the whole process, induce a global evaluation at the levels *high sensitive*, *sensitive* and *low sensitive*. Change of sensitivity level correspond to a fuzzy relation: let us suppose that the expert evaluation is 6% and that the two different classes of slopes are *between 5% and 10%* (low sensitive) and *between 10% and 15%* (sensitive). From a strict point of view, a 6% value belongs to the class *sensitive* but everybody has got the feeling that it is not so far from the *low sensitive* level. This *relative belonging strength* must be valued. Expert evaluations can also result from an imprecise evaluation. An expert may be unable to fix a unique value for a slope inclination. In many cases, the only result that expert can provide is an interval with some confidence values: as an example, the expert would be able to say that the slope inclination is between 4% and 7%. For those reasons, it appears that the mixed use of fuzzy set and possibilities theories is useful to take into account the real knowledge that the expert is able to put inside the decision process.

23.3.2 AHP and ER within uncertain and complex context

23.3.2.1 Description of AHP-ER framework

The global framework is based on a combination of multi-criteria decision analysis (MCDA) techniques and evidential reasoning (ER) through the use of the theory of belief functions which is implemented in a classical way through DST framework and also in the new DSMT framework. The global framework considers both importance, uncertainty and imprecision in criteria assessment. Uncertainty and imprecision are considered through Belief Functions, Fuzzy Sets [Zadeh 1978] and Possibility theories [Dubois et al. 2000]. Importance is assessed according to the multi-criteria framework and especially through the classical pairwise comparison matrix using Saaty's scale. As recommended in literature [Saaty and Tran 2007], we do not introduce some additional fuzziness on the comparison rates in this matrix. Such attempts to mix different approaches related to uncertainty management already exist. As an example Omnari et al. [Omrani et al. 2007] have proposed a model for transportation strategies evaluation.

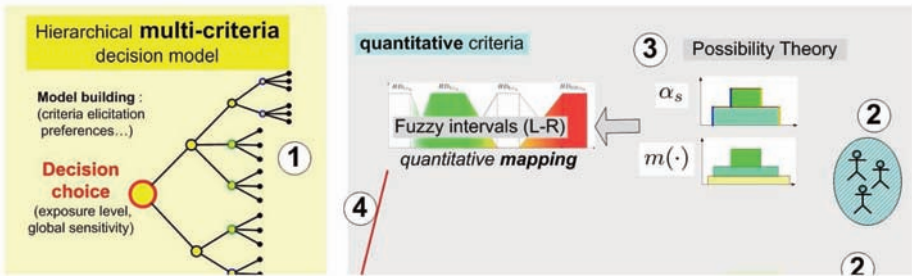

This framework implies the following steps (see FIG. 23.13):

- Hierarchical model implementation with the experts of the domain (criteria elicitation, qualitative and quantitative criteria identification);
- Choice of decision model (criteria-solution) or (criteria-estimator-solution);
- Choice of the common decision frame of discernment (*criteria-solution framework* implies that the frame consists of solutions while *criteria-estimator-solution* implies that the frame consists of a common scale for every criterion);
- Mapping process to transform the evaluations of the basic level criteria (handled according the hierarchical decision framework) into a common frame of discernment allowing a fusion process;
- Choice of fusion strategy (fusion of the different experts choices at the criterion level or at the evaluation stage);
- Choice of decision rule.

The fuzzy mapping for qualitative and quantitative criteria.

The second step of the ER-MCDA framework (see FIG. 23.13) consists of setting up, for each criterion c_j , a fuzzy mapping process that enables to transform uncertain evaluation of the criteria into bba's according to the common frame of discernment. This mapping process proposes a correspondence between the evaluation of the criteria and the elements of common frame of discernment used for the fusion process and the decision. A mapping model is a set of fuzzy numbers (see FIG. 23.14) or fuzzy intervals (see FIG. 23.15).

Since the evaluation of criteria can be uncertain and imprecise, the fuzzy intervals used for this mapping process may differ from one source to another. Therefore, $nbModels$ mapping models $mapModel_{x,c_j}$ (for $x = 1$ to $nbModels$) can exist depending from one hand on the experts involved in the model building and from the other hand on the theory used to represent the decision (DST or DSMT mapping). Two different mapping rules are used depending from one hand on the qualitative or quantitative nature of the criteria and on the other hand from the nature of the evaluation (numerical or membership assessment). For quantitative criteria, the mapping process transforms a possibility distribution, derived from necessity inputs, into bba's. For a given quantitative criterion c_j , each source s provide $nbInt_s$ numerical evaluation intervals described by a minimum, a maximum and a necessity value. This necessity value represents the minimum confidence of the source in the proposition "the value of the criterion c_j belongs to the interval". For qualitative criterion, the fuzzy number are defined according to credibility values defined on each class.

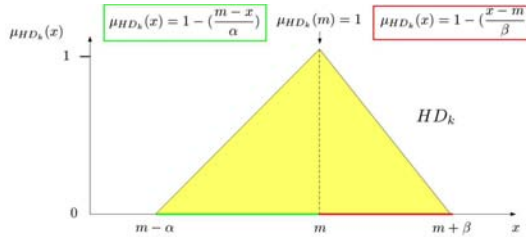

Figure 23.14: Fuzzy number $L - R$.

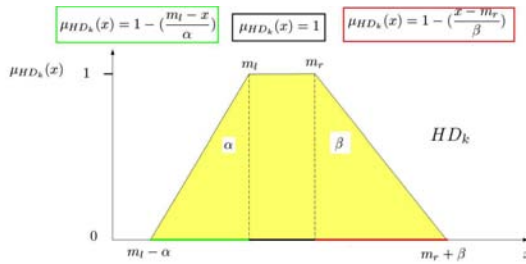

Figure 23.15: Fuzzy interval $L - R$.

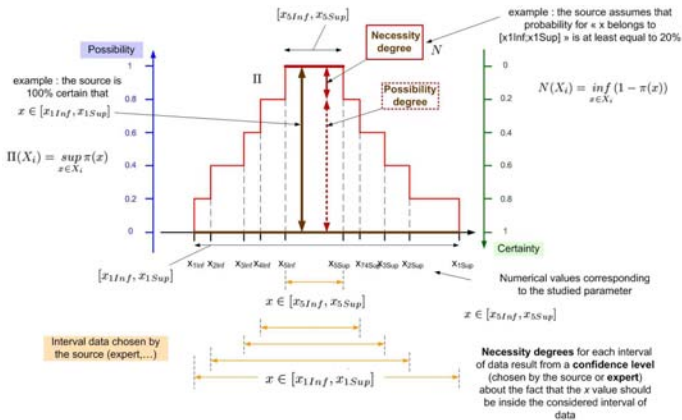

Figure 23.16: Possibility and necessity distributions.

Valuations of the criteria: from possibility to bba.

In [Dubois and Prade 2006]⁹, the authors describe relations between Possibility theory and Belief function theory. Given a bba m defined on a finite set S , the possibility distribution π resulting from m is defined by $\pi(s) = Pl(\{s\})$ (singletons plausibility). For different consonant focal elements E_i such as $E_1 \subset E_2 \subset \dots E_n$, with $E_i = \{s_1, \dots, s_i\}$, the possibility measure Π and the necessity measure N correspond to plausibility and credibility functions (see FIG. 23.16).

Example [Baudrit et al. 2005a, Baudrit et al. 2005b, Baudrit et al. 2007]: An expert provides n evaluation intervals of a quantitative criterion and assigns a confidence level λ_i to each of them. E_i corresponds to the i^{th} interval chosen by the expert (considered as a source) with $i \in \{1, 2, \dots, n\}$. λ_i is the confidence degree associated to the interval E_i with $\lambda_i = N(E_i)$ (see FIG. 23.17).

$$\forall x \in \mathbb{R}, \pi(x) = \min_{i \in \{1, 2, \dots, n\}} (\max(1 - \lambda_i, \mathfrak{X}_{E_i}(x))) \tag{23.1}$$

with

$$\mathfrak{X}_{E_i}(x) = \begin{cases} 1 & \text{if } x \in E_i \\ 0 & \text{if } x \ni E_i \end{cases} \tag{23.2}$$

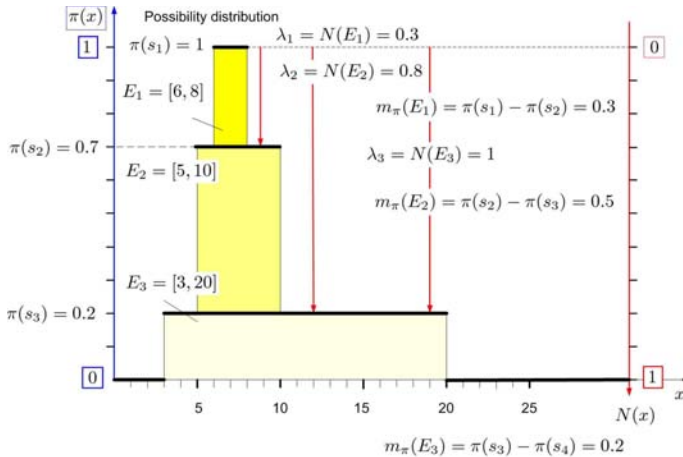

Figure 23.17: From expert necessity values to bba: numerical example.

⁹vol. 1, p. 140.

23.3.3 Step 1: Problem modeling

Risk management process is a complex framework in itself. Faced to any decision problem, the decision analyst always begins with a modeling phase which is an essential part and a main difficulty of the methodology. In our context, the modeling both concerns and cumulates known difficulties related both to the multi-criteria approach [Roy 1985] and to the evidential reasoning process [Martin and Osswald 2006]. To a certain extent, one of the more natural and intuitive way to cope with the complexity of the problem is very often to break its components down into several smaller ones. This approach is used in the hierarchical analysis proposed in AHP [Saaty 1982] but also in reliability and safety models through failure trees [Wang et al. 1996] or any systemic-like models. In [Forman and Selly 2002], Forman considers that hierarchical analysis is equivalent to the well-known cause tree or *Ishikawa* diagram. As a standard language, the *Unified Modeling Language (UML)* [Rumbaugh et al. 1999, Fowler 2000] is used to model the problem. This language is widely used in Computer Sciences and Information systems design to elicit the initial requirements, to represent the data model. In comparison with any other graphical flowcharts or diagrams, it represents a normalized framework that can be understood in the same way by all of its possible users: every graphical software is able to provide flow-charts diagrams that are not always interpreted in the same way. In our context, building conceptual models is one of the first and essential step to describe to consider the different types of sources, including both experts, databases or criteria evaluation involved in the fusion process. This approach allows building a link with calculation tools such as PCR5, PCR6 or DS_mH routines.

The modeling step concerns on the one hand the decision problem description (through a hierarchical decision structure) and, on the other hand, the fusion problem modeling.

In a criterion-estimator-solution framework, the decision consists of choosing an evaluation grade for a given alternative. The common Decision Frame of discernment used in our *ER-MCDA* framework consists of a set of evaluation grades denoted $\Theta_{Decision} = \{HD_1, HD_2, \dots, HD_k, \dots, HD_{GD}\}$ with $k \in \{1, 2, \dots, GD\}$. The decision is broken down into qualitative and/or quantitative criteria (see FIG. 23.18 and FIG. 23.19).

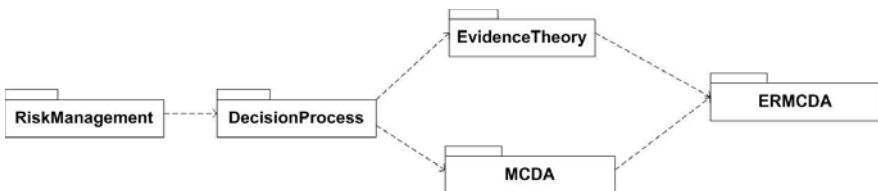

Figure 23.18: ER-MCDA framework - UML modeling - Main packages.

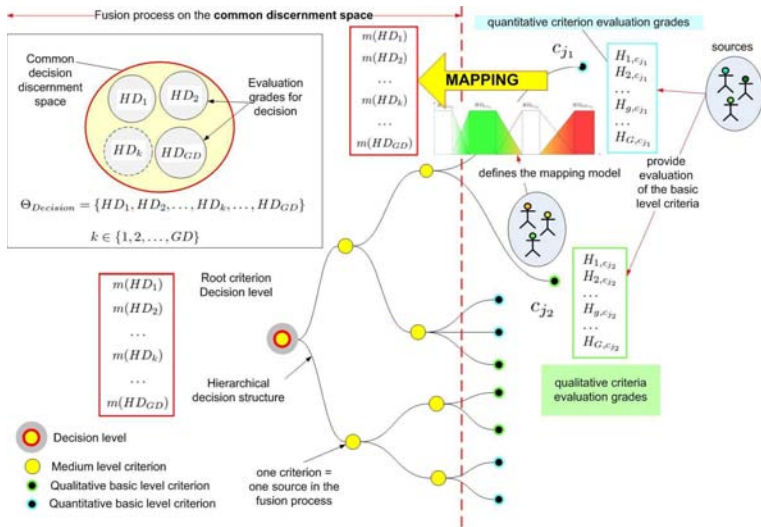

Figure 23.19: Principle of the AHP based ER-MCDA framework.

23.3.3.1 The multi-criteria analytical hierarchical model

The real problem is first analyzed through the hierarchical decision framework used a conceptual support for criteria and preferences identification. Criteria are ranked and weighted according to their importance in the decision process. The basic level criteria are assessed according either quantitative (numerical) evaluation grades. The criterion *Human vulnerability*, as an example of quantitative criterion, is assessed through the number of winter occupants. This number can be a single integer or an interval with a minimum and a maximum value such as [1, 5]. The *Living places/infrastructures*, as an example of qualitative classes, is assessed through a membership level for each class.

Unitary Hierarchic Component.

The Hierarchic Structure is composed of *Unitary Hierarchic Components* such as described in FIG. 23.7

$$SubC_j = SubC_{[r_1, r_2, \dots, r_l]} = \{C_{[r_1, r_2, \dots, r_l, 1]}, C_{[r_1, r_2, \dots, r_l, 2]}, \dots, C_{[r_1, r_2, \dots, r_l, k]}, \dots, C_{[r_1, r_2, \dots, r_l, n]}\} \quad (23.3)$$

For a given medium level criterion C_j or for the general attribute of the hierarchic structure, $SubC_j$ is the set of its *ML* sub-criteria.

Criterion Identification Vector (CIV).

A practical and simple codification is used to identify any criterion in the hierarchical structure and to implement the software application. For the criterion number j , at the level l of the hierarchy, the *Criterion Identification Vector* denoted as CIV_j is defined as $CIV_j = \underbrace{[r_1, r_2, \dots, r_k, \dots, r_{l-1}, r_l]}_{l \text{ terms}}$ where $CIV_j(l) = r_l$ is the l^{th} term of CIV_j .

By definition, the general attribute of the hierarchic structure is the first criterion of any *Criterion Identification Vector*: $\forall j \in \{1, 2, \dots, M\}, CIV_1 = [1]$. It is also called the root of the hierarchic structure. $CIV_j(k)$ is the k^{th} term of CIV . $CIV_j(k) = r_k$ means that the rank of the given criterion is r_k relatively to its parent-criterion in the unitary hierarchic component whose root criterion is the criterion denoted as $CIV = [r_1, r_2, \dots, r_{l-1}]$ which has $l - 1$ terms.

Example: Let's consider a criterion defined by its identification vector $CIV = [1, 3, 2, 2]$. Its vector length is 4. This criterion is the 2^{nd} sub-criterion of the criterion whose CIV is $[1, 2, 3]$. The criterion c_j is described by CIV_j . $ML(CIV_j) = ML([(r_1, \dots, r_k, \dots, r_l)])$ is the number of sub-criteria of the criterion described by its identification vector CIV_j . The sub-criteria of c_j are referenced by *Criterion Identification Vector* such as $[(r_1, r_2, \dots, r_k, \dots, r_l, r_{l+1})]$ with $r_{l+1} \in \{1, 2, \dots, ML(CIV_j)\}$ (see FIG. 23.20). For any criterion, ML is a function of a vector whose length ranges from 1 to D (maximal depth of the hierarchic structure) defined by $ML : C_j \rightarrow \mathbb{N}$ and $CIV_j \rightarrow ML(CIV_j)$.

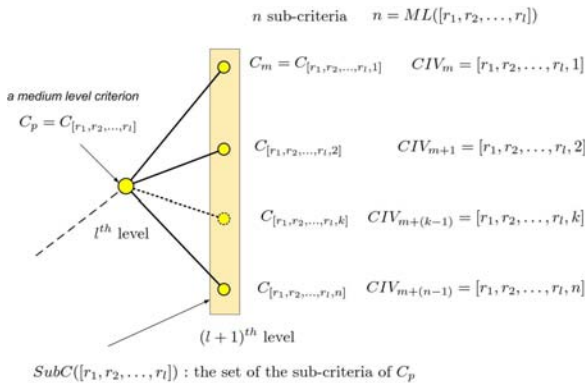

Figure 23.20: Criterion and sub-criteria codification in the hierarchical structure.

An UML class diagram using a composite pattern diagram [Gamma et al. 1995] can represent this hierarchical structure as described in (see FIG. 23.21).

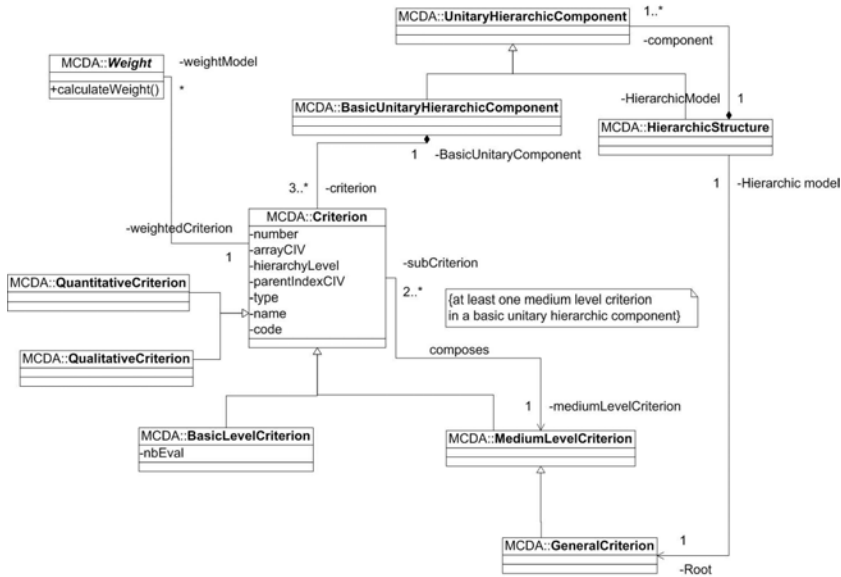

Figure 23.21: ER-MCDA framework - UML Class diagram - Decision hierarchical structure.

Evaluation of the basic level criteria.

For each basic level criterion (or attribute), S sources provide an evaluation of the criterion based on a common evaluation scale $H = \{H_1, H_2, \dots, H_G\}$ with G corresponding to the number of levels of the scale. H is the frame of discernment on which the evaluation is done.

23.3.3.2 A sample decision model

We introduce here a simplified model to illustrate the coupled use of fusion process and MCDA approaches. This model is derived from a real decision-aid model that calculates the sensitivity level of a natural site exposed to avalanches.

A common frame of discernment is required for decision.

Any fusion problem requires defining a common frame of discernment. Its definition is closely linked to the nature of decision such as choosing a sensitivity or exposure level for a site in a natural hazards prone area, choosing the more important areas to protect, choosing the level of confidence for an expertise. The fusion process will provide basic belief assignments on each or combination of the elements of the frame of discernment. We can obviously question ourselves about the interest of using the DS_mT framework (allowing non-empty intersections) instead of the classical DST framework based on exhaustive and exclusive hypotheses.

Two frames of discernment Θ are considered in this work:

- in the DST framework (see FIG. 23.22), the frame Θ is composed of 4 exclusive elements defined by $HD_1 =$ 'No sensitivity', $HD_2 =$ 'Low sensitivity', $HD_3 =$ 'Medium sensitivity' and $HD_4 =$ 'High sensitivity';

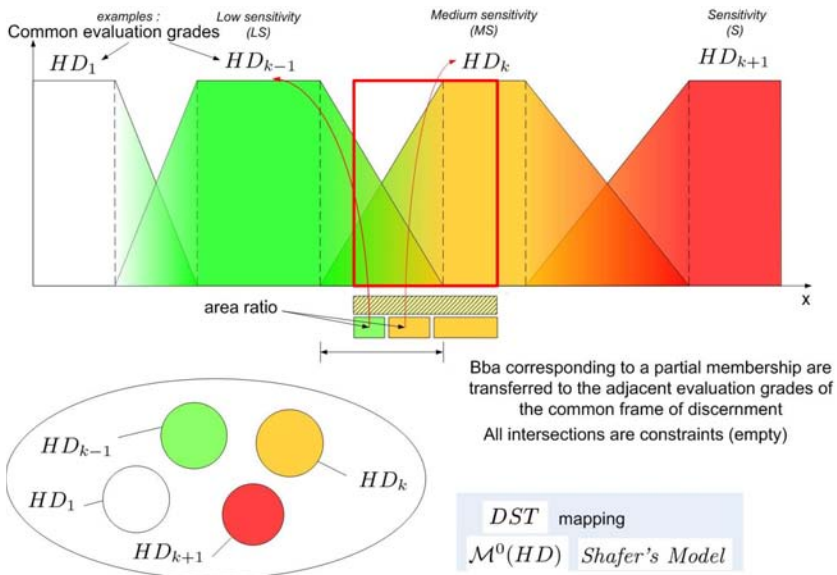

Figure 23.22: Modeling the common evaluation grades in a DST framework.

- in the DS_mT framework (see FIG. 23.23), the frame Θ is composed of 3 elements defined by $HD_1 =$ 'No sensitivity', $HD_2 =$ 'Low sensitivity' and $HD_3 =$ 'High sensitivity';

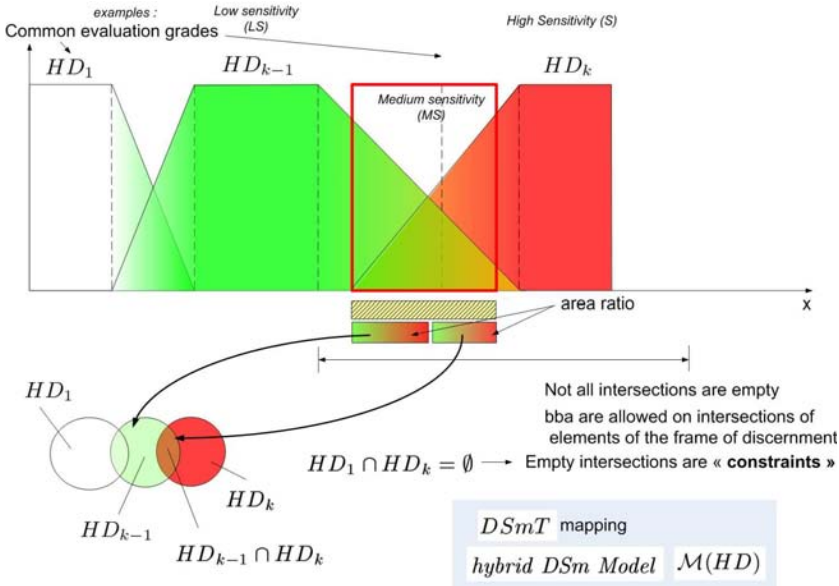

Figure 23.23: Modeling the common evaluation grades in a DS_mT framework: simplified version.

23.3.4 Step 2: Mapping quantitative criterion into a common frame

This section describes the transformation of the evaluations provided by the different sources on quantitative criteria into the common frame of discernment.

23.3.4.1 Mapping quantitative criteria

For a given quantitative criterion c_j , the mapping process $mapModel_x$ transforms a quantitative evaluation into bba defined in the common frame of discernment (see FIG. 23.24):

$$\begin{cases} mapModel_{(x,c_j)} : [0, 1] \rightarrow [0, 1] \\ mapModel_{(x,c_j)}(I_{(s,int_j)}) = \{m_{s,I_{(s,int_j)}}(HD_1), \dots, m_{s,I_{(s,int_j)}}(HD_{GD})\} \end{cases}$$

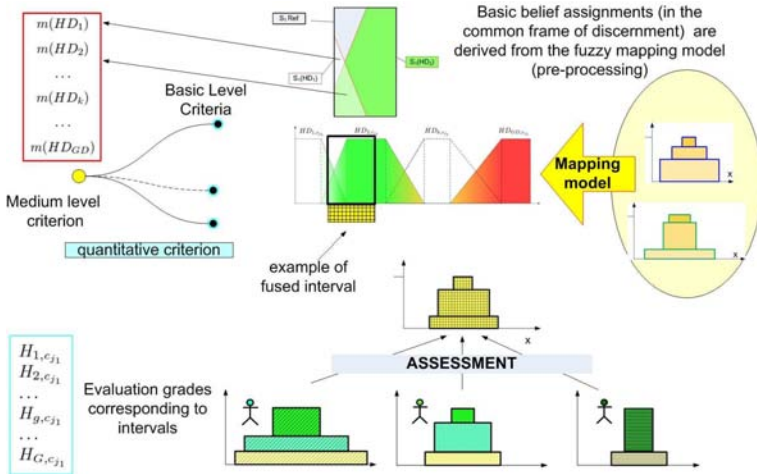

Figure 23.24: Mapping from quantitative criterion assessment to the common frame of discernment.

For a quantitative criterion c_j , the evaluation by a source s (an expert) can be either a single value (e.g. x_1) or numerical intervals. Different consonant intervals, corresponding to different levels of confidence can be proposed by the source. The evaluation of the source s is therefore a possibility distribution whom we are able to extract intervals denoted $I_{(s,int_j)}$ and corresponding basic belief assignments denoted $m_s(I_{(s,int_j)})$ [Dubois and Prade 2006]. For each interval $I_{(s,int_j)}$, the fuzzy mapping function of the x^{th} mapping model, for the criterion c_j distributes $m_s(I_{(s,int_j)})$ on the elements of the common frame of discernment $\Theta_{Decision} = \{HD_1, HD_2, \dots, HD_k, \dots, HD_{GD}\}$ on which the global decision is taken. The distribution of $m_s(I_{(s,int_j)})$ on HD_k ($k \in \{1, 2, \dots, GD\}$) is proportional to the intersection of the following areas (see FIG. 23.25):

- a rectangle whose width is equal to the length of the interval $m_s(I_{(s,int_j)})$ and height is equal to 1;
- intersection of the previous rectangle with the areas of fuzzy intervals defined in the mapping model $mapModel_{x,c_j}$, denoted $A_{mapModel_{x,c_j}}(HD_k)$.

The evaluation source is described through:

- its confidence, resulting from its own assessment and valued by a necessity value attached to each interval;
- its reliability, resulting from an external assessment, and valued through a discounting factor.

Different cases are considered depending on the nature and number of evaluations provided by one source for a given criterion (numerical intervals or single discrete values).

23.3.4.2 Case of one source with one evaluation

- Case of one totally reliable source with one imprecise evaluation** This case corresponds to a source s which evaluates the quantitative criterion with a unique interval ($nbInt_s = 1$) whose necessity value equals to 1. The bba of the interval ($m_s(I_{s,1}) = 1$) is transferred to the elements of the common frame of discernment (see FIG. 23.25). The interval $I_{(s,1)} = [x_{Inf(s,1)}, x_{Sup(s,1)}]$ corresponds to a total area of

$$A_{I_{(s,1)}} = length(I_{(s,1)}) = x_{Sup(s,1)} - x_{Inf(s,1)}.$$

$A_{I_{(s,1)}}$ represents the total membership area of the interval with $A_{I_{(s,1)}} = A_{I_{(s,1)}}(HD_{k-1}) + A_{I_{(s,1)}}(HD_k)$. The bba transferred on HD_{k-1} is

$$m_{s,I_{(s,1)}}(HD_{k-1}) = \frac{A_{I_{(s,1)}}(HD_{k-1})}{A_{I_{(s,1)}}} \cdot m_s(I_{(s,1)}).$$

The bba transferred on HD_k is

$$m_{s,I_{(s,1)}}(HD_k) = \frac{A_{I_{(s,1)}}(HD_k)}{A_{I_{(s,1)}}} \cdot m_s(I_{(s,1)}).$$

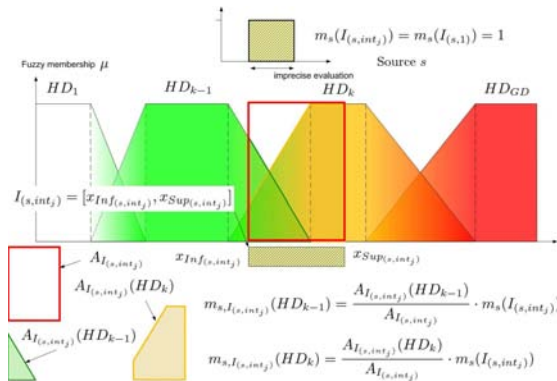

Figure 23.25: Quantitative criterion mapping: One totally reliable source with imprecise evaluation.

- **Case of one partially reliable source with imprecise evaluation**

The source s is assumed partially reliable. A discounting factor is applied to the bba corresponding to the evaluated intervals (see FIG. 23.26).

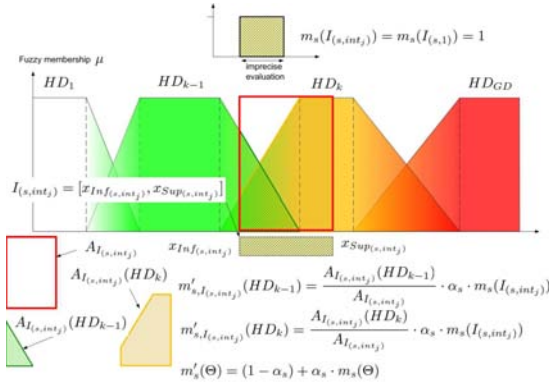

Figure 23.26: Quantitative criterion mapping: One partially reliable source with imprecise evaluation.

- **Case of a partially reliable source with precise evaluation**

The source s provides a single discrete evaluation x_1 of the quantitative criterion c_j . $m(x_1)$ is derived from the fuzzy mapping intervals by the intersection of a vertical line with these fuzzy intervals (see FIG. 23.27). The reliability of the source is taken into account by a discounting factor $\alpha_s \in [0, 1]$.

23.3.4.3 Case of one source with two evaluation intervals

Based on the necessity-possibility functions inputs, one transfers the initial bba to a bba related to the common frame of discernment chosen for decision. This transfer uses the proportion of intersected areas of the whole area of the interval with each fuzzy $L - R$ interval of the mapping model (see FIG. 23.28).

We consider here a source s that provides two evaluation intervals ($nbInt_s = 2$). The first evaluation of the source s is interval $I_{(s,1)} = [x_{Inf(s,1)}, x_{Sup(s,1)}]$. The membership area (see FIG. 23.29) of this interval equals to

$$A_{I_{(s,1)}} = A_{I_{(s,1)}} = A_{I_{(s,1)}}(HD_{k-1}) + A_{I_{(s,1)}}(HD_k).$$

The bba's transferred respectively on HD_{k-1} and on HD_k are: $m_{s, I_{(s,1)}}(HD_{k-1}) = (A_{I_{(s,1)}}(HD_{k-1}) / A_{I_{(s,1)}}) \cdot m_s(I_{(s,1)})$ and $m_{s, I_{(s,1)}}(HD_k) = (A_{I_{(s,1)}}(HD_k) / A_{I_{(s,1)}}) \cdot m_s(I_{(s,1)})$.

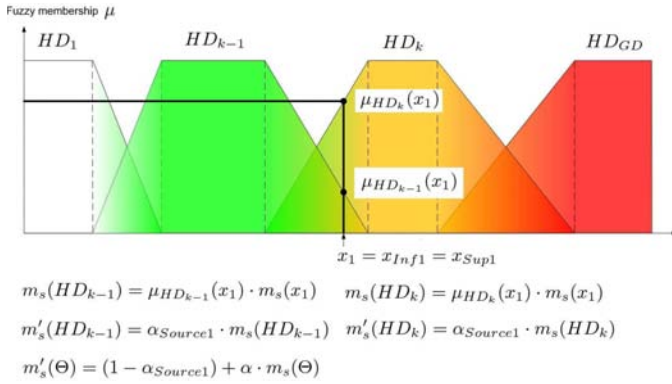

Figure 23.27: Quantitative criterion mapping: One partially reliable source with precise evaluation.

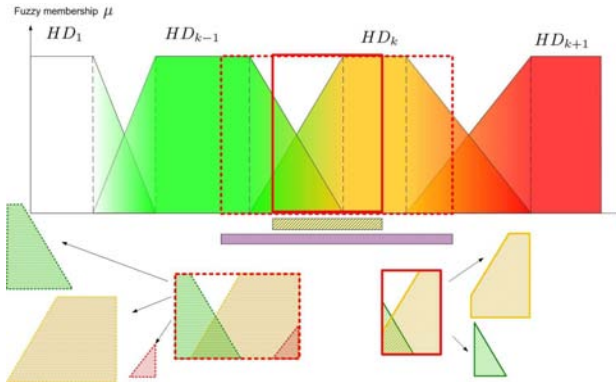

Figure 23.28: Quantitative criterion mapping: Two imprecise evaluations - Principle of area mapping calculation.

The second evaluation of the source s is $I_{(s,2)} = [x_{Inf(s,2)}, x_{Sup(s,2)}]$. The membership area (see FIG. 23.30) of the interval equals to

$$A_{I_{(s,2)}} = A_{I_{(s,2)}} = A_{I_{(s,2)}}(HD_{k-1}) + A_{I_{(s,2)}}(HD_k) + A_{I_{(s,2)}}(HD_{k+1}).$$

The bba's transferred on HD_{k-1} , on HD_k and on HD_{k+1} are respectively given by:

$$m_{s,I_{(s,2)}}(HD_{k-1}) = \frac{A_{I_{(s,2)}}(HD_{k-1})}{A_{I_{(s,2)}}} \cdot m_s(I_{(s,2)})$$

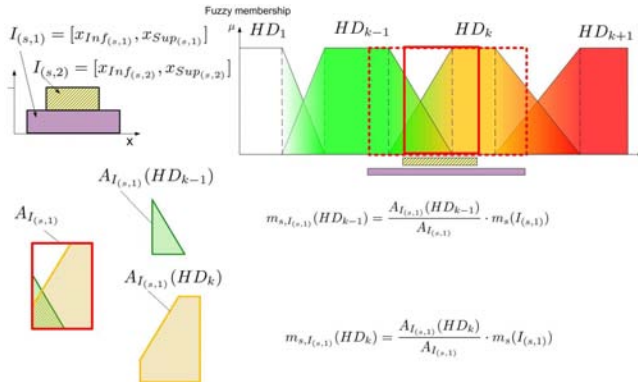

Figure 23.29: Quantitative criterion mapping: One partially confident source and a totally reliable source - interval 1.

$$m_{s,I(s,2)}(HD_k) = \frac{A_{I(s,2)}(HD_k)}{A_{I(s,2)}} \cdot m_s(I_{(s,2)})$$

$$m_{s,I(s,2)}(HD_{k+1}) = \frac{A_{I(s,2)}(HD_{k+1})}{A_{I(s,2)}} \cdot m_s(I_{(s,2)})$$

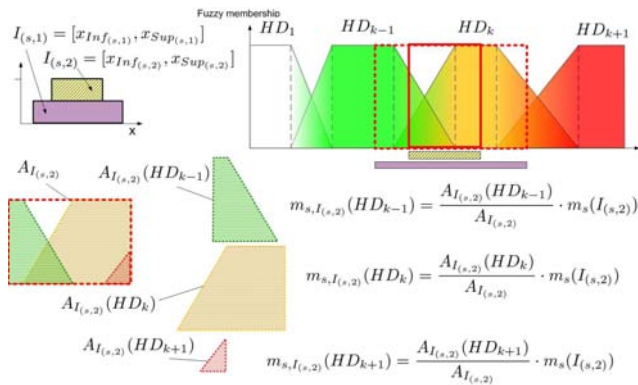

Figure 23.30: Quantitative criterion mapping: One partially confident source and a partially reliable source - interval 2.

23.3.4.4 Generalization: evaluation of one source s with $nbInt$ numerical intervals

- One totally reliable source with $nbInt$ imprecise evaluations

We consider here the source s that provides $nbInt$ evaluation intervals. The j^{th} interval is defined by $I_{(s,Int_j)} = [x_{Inf(s,Int_j)}, x_{Sup(s,Int_j)}]$ with the index $j \in \{1, 2, \dots, nbInt_s\}$. The length of the interval is $length(I_{(s,Int_j)}) = x_{Sup(s,Int_j)} - x_{Inf(s,Int_j)}$. The membership area of the interval $A_{I_{(s,Int_j)}}$ depends on the length of the considered interval with $h_{A_{I_{(s,Int_j)}}}$ corresponding to the height of the area ($h_{A_{I_{(s,Int_j)}}} = 1$ corresponds to a full membership) as shown in eq. (23.4).

$$A_{I_{(s,Int_j)}} = length(I_{(s,Int_j)}) * h_{A_{I_{(s,Int_j)}}} \quad (23.4)$$

The whole area $A_{I_{(s,Int_j)}}$ is the sum of the intersected areas of intervals with the fuzzy intervals of the mapping model.

$$A_{I_{(s,Int_j)}} = \sum_{j=1}^{nbInt_s} A_{I_{(s,Int_j)}}(HD_k)$$

with k such as $A_{I_{(s,Int_j)}} \cap A_{model_x}(HD_k) \neq \emptyset$.

The bba transferred on HD_k results from the intersection of the interval $I_{(s,Int_j)}$ with the mapping model A_{model_x} - see eq. (23.5) - with:

- $A_{I_{(s,Int_j)}}$ corresponding to the intersection area of the interval with the mapping model A_{model_x} (as an example DST or DSMT mapping models as described in applications section;
- $A_{I_{(s,Int_j)}}(HD_k)$ corresponding to the intersection of the interval $A_{I_{(s,Int_j)}}$ with the fuzzy $L - R$ interval coding for the k^{th} element of the frame of discernment Θ .

$$m_{s,I_{(s,Int_j)}}(HD_k) = \frac{A_{I_{(s,Int_j)}}(HD_k)}{A_{I_{(s,Int_j)}}} \cdot m_s(I_{(s,Int_j)}) \quad (23.5)$$

For each element of the frame of discernment HD_k , we sum the bba transferred by each interval. Finally, the resulting mapped bba of the source s for $nbInt_s$ evaluation intervals is defined by eq. (23.6):

$$m_s(HD_k) = \sum_{j=1}^{nbInt_s} m_{s,I_{(s,Int_j)}}(HD_k) \quad (23.6)$$

• **A partially reliable source with $nbInt$ imprecise evaluations**

For a partially reliable source, the bba are discounted according the classical reliability discounting process. $m'_s(HD_k) = \alpha_s \cdot m_s(x_1)$ and $m'_s(\Theta) = (1 - \alpha_s) + \alpha_s \cdot m_s(\Theta)$. In case of a partially reliable source, the bba transferred on each element HD_k of the considered frame of discernment (corresponding to a given mapping model A_{model_x} is

$$m'_{s,I(s,Int_j)}(HD_k) = \frac{A_{I(s,Int_j)}(HD_k)}{A_{I(s,Int_j)}} \cdot \alpha_s \cdot m_{s,I(s,Int_j)}$$

A synthetic view of the quantitative mapping process from evaluation intervals to the mapped bba is described in FIG. 23.31 for $nbInt_s = 2$.

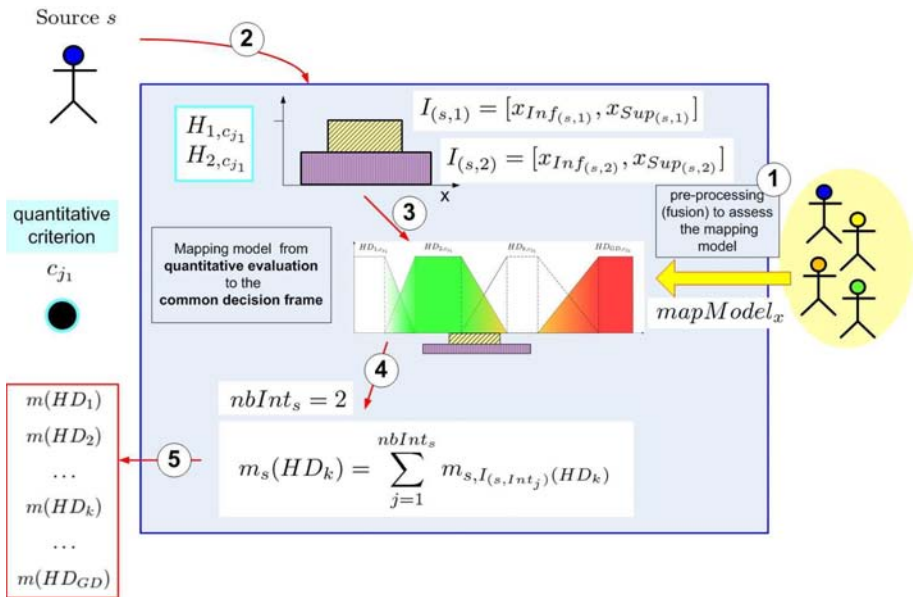

Figure 23.31: Quantitative criterion mapping: One partially confident source and a partially reliable source - Fusion

23.3.5 Step 3: Mapping qualitative criterion into a common frame

Qualitative mapping transforms an evaluation of a qualitative criterion into basic belief assignments (bba's) expressed on the common frame of discernment. At the end

of the *scaling process*, the result of the evaluation of qualitative criterion c_j by the source s is summarized in a belief interval $belInt_{(s,c_j)}$ and a weighted discounted factor α_s .

Instead of choosing only one evaluation grade, the expert can distribute his confidence between different combinations depending on the model used. Therefore, he can express the strength of his belief in the different classification levels. He can even notify that he has no information about the evaluation of the criterion by assigning his confidence to the whole set of classes (corresponding to the *total ignorance*).

Qualitative criteria correspond to criteria whose evaluation is carried out in a Boolean way. For a given criterion c_j and its g^{th} evaluation grade H_{Qualg,c_j} , a given alternative belongs or does not belong to the evaluation grade. A numerical interval $[x_{Inf}, x_{Sup}]$ can be considered as a qualitative criterion as soon as its limits cannot change. The qualitative mapping process transforms an uncertain evaluation of qualitative criteria into basic belief assignments and discounting factor compliant with the global fusion process.

The basic belief assignment elicitation for qualitative criteria is a two steps process. We consider a qualitative criterion c_j , for which a given expert or source, has to provide an evaluation according to the evaluation grades of the common frame of discernment $\Theta = \{HD_1, HD_2, \dots, HD_k, \dots, HD_{GD}\}$. The criterion c_j is evaluated according to the qualitative evaluation grades $\{H_{Qual1,c_j}, H_{Qual2,c_j}, \dots, H_{Qualg,c_j}, \dots, H_{Qual_{GD},c_j}\}$. A qualitative (DST or DSMT based) *mapping model* is used to link expert's evaluation to the evaluation grades of the common frame Θ . The belief is calculated for each qualitative evaluation grade using the *importance bba* (see FIG. 23.32) and the *comparative confidence qualitative discounting factor* using a (DST or DSMT based) scaling model.

23.3.5.1 Global mapping process for qualitative criterion

As for quantitative criteria, the global process aims at build links between evaluation grades related to qualitative criteria and the element of the common frame of discernment. Each evaluation grade is assessed first according to its importance according to the decision to take (e.g. the sensitivity level) and secondly to the confidence level related to its assessment by the source. As for qualitative criteria, two frames of discernment and mapping models are considered as shown on FIG. 23.33.

The mapping process corresponds to the following steps:

- Choice of evaluation grades scaling model with regard to the acceptance (DSMT scaling model) or non-acceptance (DST scaling model) of non empty intersections between the evaluation grades;

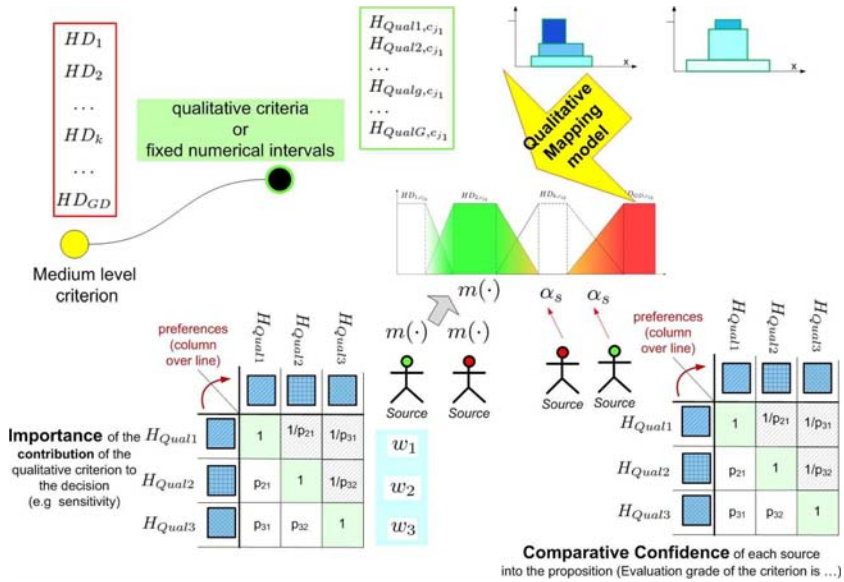

Figure 23.32: Mapping from qualitative criterion assessment to the common frame of discernment.

- Importance assessment of each evaluation grade (to calculate weights considered as equivalent to basic belief assignments);
- Confidence level assessment for the evaluation by a given source s ;
- Gathering of these evaluation into a common belief interval with lower and an upper limits;
- mapping of this belief interval to the common frame of discernment.

23.3.5.2 Importance of each qualitative evaluation grade: DST or DSmt scaling

A qualitative criterion c_j is assessed according to a set of g evaluation grades denoted as $H_{(Qualg,c_j)}$ with $g \in \{1, 2, \dots, G\}$. These evaluation grades correspond to real situations that the source may encounter while trying to assess a real problem. As an example, the criterion $C_{[112]}$ coding for the part of global sensitivity due to the living places or infrastructures is described by a set of evaluation grades corresponding to industrial equipments ($\{Ind\}$), collectivities ($\{Col\}$) or rescue equipments ($\{Resc\}$). They respectively correspond to an increasing level of sensitivity: rescue equipment

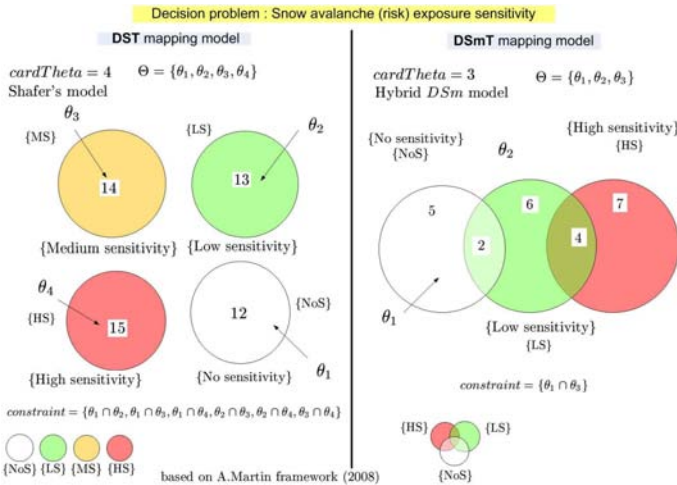

Figure 23.33: Frame of discernment corresponding to DST and DSMT mapping models.

is considered as more important than a collective equipment which is itself more important than an industrial equipment. Ranking the different evaluation grades according to their importance is handled through an AHP based pairwise comparison matrix. For each evaluation grade, weights are considered as basic belief assignments. As focal elements are singletons, according to the modeling principles, these bba's are equivalent to beliefs following eq. (23.7).

$$w_{(H_{Qualg,c_j,s})} = m_{(H_{Qualg,c_j,s})} = Bel_{(H_{Qualg,c_j,s})} \tag{23.7}$$

In a real-case application, different combinations of these equipments can exist: industrial equipments such as telephonic exchanges, power plants, roads, bridges can also be considered as rescue equipments. A finest gradation in term of sensitivity can be proposed. An equipment whose contribution to sensitivity is multiple will be more sensitive than as many separate equipments: such an equipment concentrating different functions on a unique geographical point represents an higher potential of damage. The evaluation model should be able to consider this case. Therefore, two models are proposed:

- A DST based model considers that the evaluation grades are totally exclusive. This model cannot take into account the intersection of two evaluation grades;
- A DSMT based model allows intersection between the evaluation grades. Basic belief assignments put on these empty intersections correspond to the situations where equipments belong to several evaluation grades.

We could have obviously imagined modeling the intersection cases through a refinement of the initial DST model. To our point of view, the DS_mT model fits in a closer way to the real case application. In such a model, the case of an equipment that would be both an industrial and an rescue equipment corresponds to an evaluation of the elements $\{Ind\}$, $\{Col\}$ and $\{Ind \cap Col\}$.

23.3.5.3 Confidence level of qualitative evaluation grade

Once the source s has chosen whether an evaluation grade was existing on the studied area, it must valuate its confidence related to its valuation. For a given qualitative criterion c_j , its evaluation grades can be partially assessed by the source s . Any evaluation attempt by the source s of the evaluation grade g of the criterion c_j corresponds to a Boolean factor denoted as $input_{(HQual_g, c_j, s)}$. This factor is important to calculate the weighted discounted factor depending on the evaluated grades.

For each evaluation grade of the criterion c_j , the source s has to valuate its confidence level through a confidence ranking interval $confRankInt$ defined in eq. (23.8) with its minimum and maximum values chosen in a "Saaty-like" ordinal scale ranging from $confRank_{min} = 1$ (no confidence at all in the valuation) to $confRank_{max} = 9$ (total confidence in the valuation).

$$confRankInt = [inputConfRank_{min}, inputConfRank_{max}] \quad (23.8)$$

These rankings are normalized to calculate lower and upper confidence index following as follows:

$$conf_{min} = \frac{inputConfRank_{min} - confRank_{min}}{confRank_{max} - confRank_{min}}$$

$$conf_{max} = \frac{inputConfRank_{max} - confRank_{min}}{confRank_{max} - confRank_{min}}$$

$$conf_{mean} = \frac{conf_{min} + conf_{max}}{2}$$

with $inputConfRank = inputConfRank_{(HQual_g, c_j, s)}$.

23.3.5.4 Belief interval

For each evaluation grade g of the criterion c_j by the source s , a belief interval $BelInt_{(HQual_g, c_j, s)}$ is derived from the confidence ranking interval $confRankInt$ and the importance bba $m_{(HQual_g, c_j, s)}$. The confidence level associated to this belief interval $\alpha_{c_j, s}$ the ratio between the importance bba weighted by the mean confidence and the maximum belief value. The final data used to map the qualitative criterion c_j are $\alpha_{c_j, s}$ and $BelInt_{c_j} = [BelInt_{min, c_j}, BelInt_{max, c_j}]$, $BelInt_{min, g} = conf_{min, g} \cdot Bel_g$, $BelInt_{max, g} = conf_{max, g} \cdot Bel_g$, $BelInt_{min, c_j} = \sum_{g=1, \dots, G} input_g \cdot BelInt_{min, g}$, $BelInt_{max, c_j} = \sum_{g=1, \dots, G} input_g \cdot BelInt_{max, g}$ with $input_g = input_{(HQual_g, c_j, s)}$, $Bel_g = Bel_{(HQual_g, c_j, s)}$, $\alpha_g = \alpha_{(HQual_g, c_j, s)}$ and $BelInt_{min, g} = BelInt_{(min, HQual_g, c_j, s)}$,

(similarly with max), $BelInt_{min,c_j} = BelInt_{(min,c_j,s)}$ (similarly with max), $conf_{min,g} = conf_{(min,HQual_g,c_j,s)}$ (similarly with max and mean).

23.3.5.5 Fusion order

The fusion process can be different from the hierarchical decision model. These fusion orders are parts of the description of the fusion processes in the model. Several strategies can be imagined depending whether the decision is taken by one source (see FIG. 23.34) or by several sources (see FIG. 23.35).

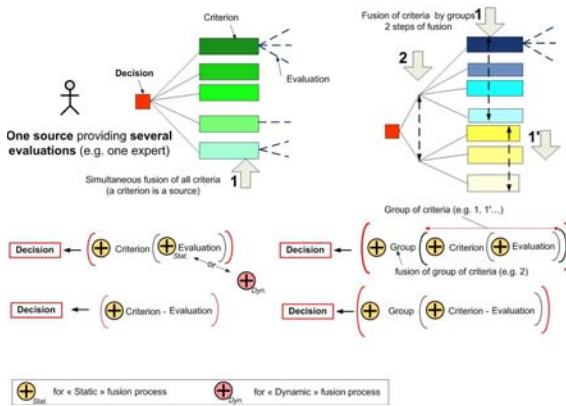

Figure 23.34: How far does the fusion process must follow the hierarchical decision model (case of one source)?

In this work, the implemented model corresponds to $(\oplus_{Stat} Criterion (\oplus_{Stat} Source - Evaluation))$ depicted in FIG. 23.36) below.

23.3.5.6 Fusion of mapped bba of nbSources sources

A given criterion is identified by its criterion identification vector $CIV = [r_1, r_2, \dots, r_n]$. s sources, denoted as s_i with $i \in \{1, 2, \dots, s\}$, provide $nbEval_{s_i}$ interval-based evaluations. Each evaluation by the source s , denoted as $eval_{j,s}$, consists of $nbInt_{j,s}$ intervals. $nbFusedSources$ represents the total number of all the sources that are fused for the criterion (sum of all the evaluations of the sources for the given criterion) (Eq. 23.9). Several fusion processes can be proposed. The following equations concern the $(\oplus_{Stat} Criterion (\oplus_{Stat} Source - Evaluation))$ process. An example is given for the criterion $C_{[111]}$ for which two sources s_1 and s_2 provide each one evaluation (Eq. 23.10).

$$nbFusedSources_{CIV} = \sum_{s_i=1}^s \left(\sum_{j=1}^{nbEval_{s_i}} j \right) \tag{23.9}$$

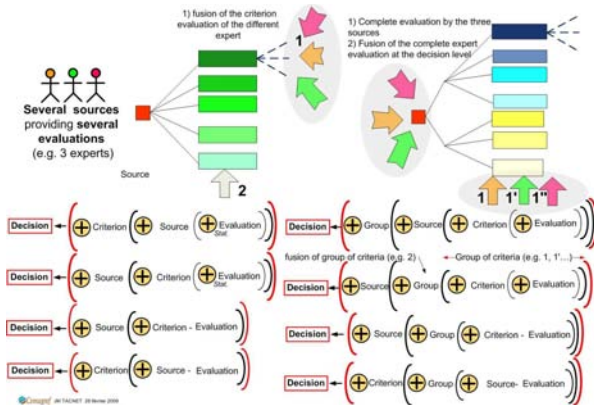

Figure 23.35: How far does the fusion process must follow the hierarchical decision model (case of several sources)?

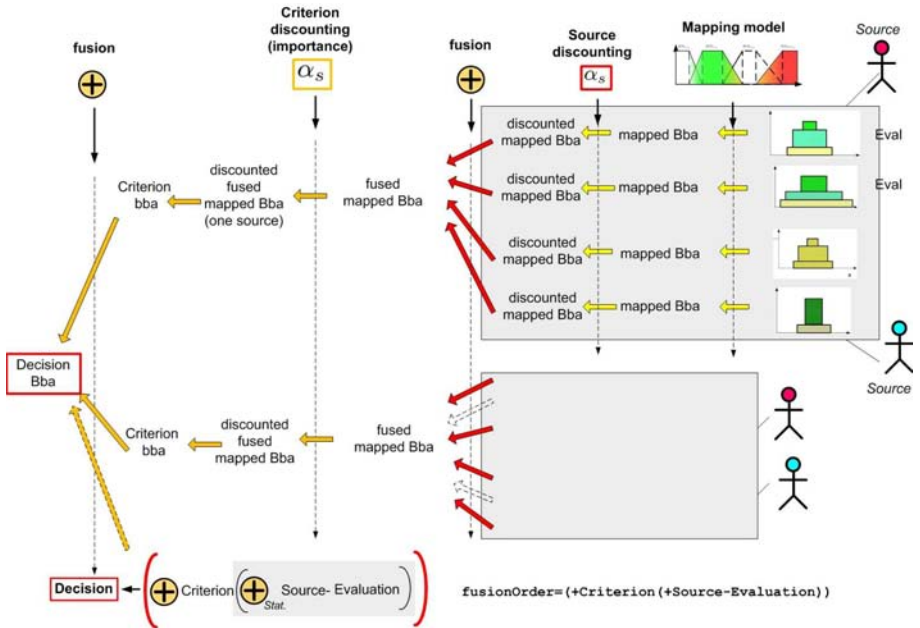

Figure 23.36: Description of the implemented fusion process.

$$m_{(C_{[111]})}(HD_k) = (m_{(C_{[111]},s_1,eval_1)} \oplus m_{(C_{[111]},s_2,eval_1)})(HD_k) \quad (23.10)$$

In a UML standard, the fusion process can partially be represented as in FIG. 23.37 below.

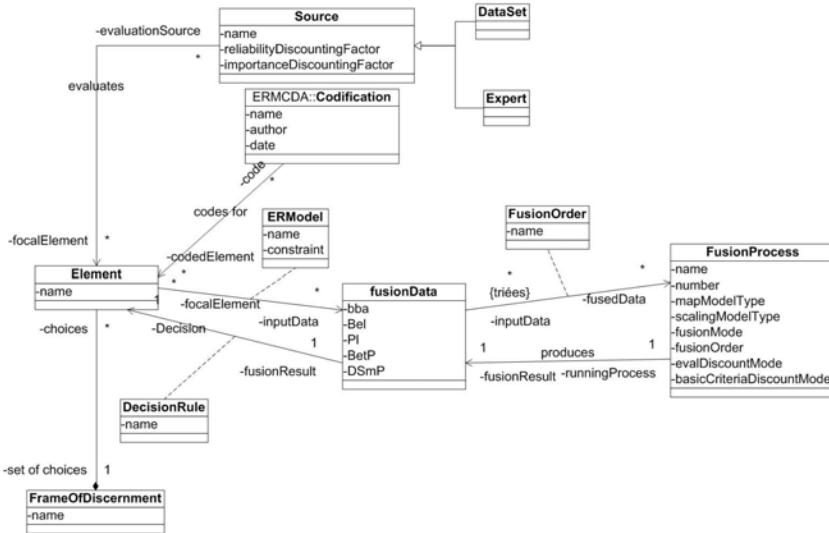

Figure 23.37: ER-MCDA framework - UML Class diagram - Principle of the fusion process.

23.3.5.7 Discounting factors for reliability and importance assessment

The classical reliability discounting factor

In a classical way, discounting factors are used to take into account the reliabilities of the sources. For each source of evidence, α_r with $r \in \{1, 2, \dots, S\}$ represents the confidence given by the system to this source. $\alpha_r = 1$ corresponds to a totally reliable source of evidence and $\alpha_r = 0$ corresponds to totally unreliable source of evidence [Dezert 2003]¹⁰.

The AHP method can be used to calculate the discounting factors. A preference matrix using pairwise comparisons gives the relative weight of importance w_r of each source. After a normalization step based on the maximum of the weights, the discounting factor α_r can be defined as [Beynon 2005]¹¹:

¹⁰ p.21

¹¹ p.1891

$$\alpha_r = \frac{w_r}{\max(w_k)} \text{ with } k \in \{1, 2, \dots, S\} \tag{23.11}$$

In our ER-MCDA framework, discounting factors are used at many different steps of the process:

- following the classical approach, a discounting factor is applied to the different sources providing an evaluation for qualitative or quantitative criteria. Normalization factor is used at the evaluation step of qualitative criterion to evaluate the confidence of the assessor in its judgment (*confidence qualitative discounting factor*);
- normalized weights of the basic level criteria are transformed in discounting factors (with a maximum based normalization instead of a direct use of weights – see FIG. 23.38).

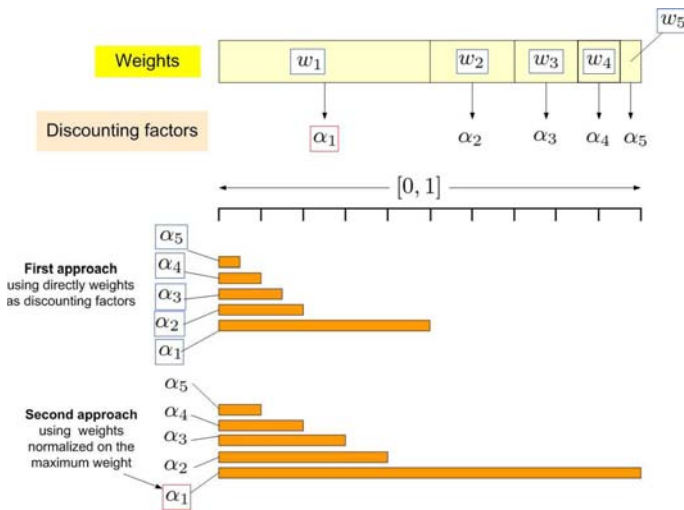

Figure 23.38: From preference weights to discounting factors for $S = 5$ sources.

The last situation may appear as a misunderstanding of the concept of discounting factor. In fact, we consider here that the evaluation of a criterion results both from its importance in the decision process and from the evaluation uncertainty. For a given criterion c_j , the pairwise comparison of qualitative evaluation grades produce weights considered as basic belief assignment related to their contribution to the sensitivity: they are named *importance bba*. This principle justifies the fact that they are used to calculate the bba in the common frame of discernment. For this criterion, the evaluator has some variable confidence about its evaluation: *“Does this evaluation*

grade really belong to the site that I am evaluating?". The singletons (extended with intersections in a DSMT framework) are considered to compare the levels of confidence on each of these evaluation grades. The weights are then considered as discounting factors as they reduce the importance of the previous evaluation. A fusion would not have any sense since the discernment frame and the meaning is different.

Can importance be assessed by a (new) discounting factor?

Mixing fusion and multi-criteria decision approaches can lead to the difficulty of making a difference between uncertainty and importance. This also corresponds to a classical discussion about difference between aggregation of preferences and information fusion. In an ideal framework, we do consider that fusion should mainly concern uncertain pieces of evidence and not the preferences between criteria. The final fusion step of mapped basic level criteria should be compared to an aggregation method based on the result of fusion. Nevertheless, we propose in the following section, an experimental approach to take importance into account through a new discounting factor.

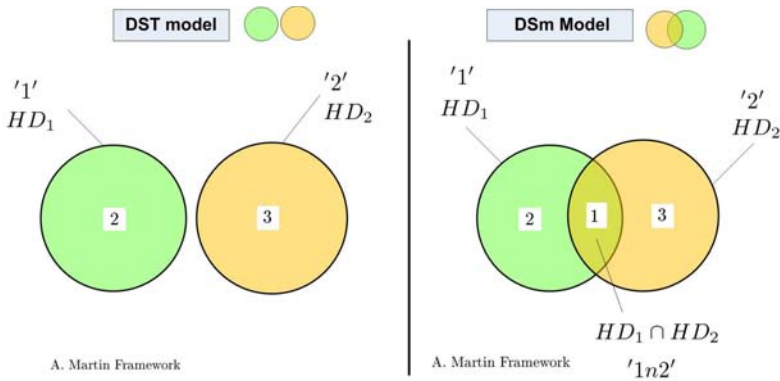

Figure 23.39: DST and DSMT models for importance discounting model.

The classical discounting method transforms a basic belief assignment $m(\cdot)$ through a discounting factor α that reduces the basic belief assignment for each focal element and increases the basic belief assignment assigned to the total ignorance Θ . In our ER-MCDA framework, the mapping process leads to mapped basic belief assignments taking into account the reliability of the different sources. During that first step (so-called mapping and scaling steps), the classical discount method is appropriate since it really corresponds to a variable level of confidence for each evaluation.

The second step of the process aims at fuse the basic level criteria evaluation according to their importance. This last fusion step produces the final basic belief assignment that can be analyzed to make a decision according different rules such as

maximum of bba, maximum of credibility, etc. The question is to represent the preferences weights issued from MCDA model in a fusion model. The weights represent relative importance from one criterion to another and not relative uncertainty: a lower importance basic level criterion can be assessed in a certain way while a very important criterion can be very uncertain. Using the classical discounting factor [Beynon 2005] cannot represent this difference since it only corresponds to a reduction of the reliability.

Definition (importance discounting factor): To represent the relative importance of the basic level criteria in a same way than in a multi-criteria decision problem, we propose (following more or less some principles proposed by Smets), a specific (and experimental) importance discounting factor denoted as α_{Imp} and defined as follows: For a source \mathcal{B} described by a bba $m(\cdot)$ relatively to the frame of discernment Θ and used in an ER-MCDA¹² process, the importance discounting factor $\alpha_{Imp, \mathcal{B}}$ is defined as $\alpha_{Imp} \in]0, 1]$ such as for any subset $A \subset \Theta$, the importance discounted bba $m'_{Imp}(\cdot)$ is defined by the following eq. (23.12):

$$\begin{cases} m(A) \\ m(\emptyset) \end{cases} \longrightarrow \begin{cases} m'_{Imp}(A) = \alpha_{Imp} \cdot m(A), & \forall A \neq \emptyset \\ m'_{Imp}(\emptyset) = (1 - \alpha_{Imp}) + \alpha_{Imp} \cdot m(\emptyset) \end{cases} \quad (23.12)$$

The case where $\alpha_{Imp} = 1$ corresponds to a source \mathcal{B} that has the maximum reachable relative importance value. The principle of this importance discounting factor is to reduce the basic belief assignment related to a given basic level criterion without increasing the total ignorance corresponding to $m(\Theta)$. It is therefore possible to discount a source according by using both to its reliability and its importance.

As it involves basic belief assignment on the empty set, this double discounting method should be used with fusion rules that are able to redistribute conflict and with models that make a difference between the real conflict between hypotheses and the basic belief assignment put on the empty set. The classical Dempster's rule is known to fail when conflict increases: we can expect that it will not be the best choice in our experimental model that consists in artificially transfer bba's on the empty set at the final stage of fusion.

The following examples show the principle of using this importance discounting factor in a very simple case ($Card(\Theta) = 2$) in DST and DSMT frameworks. The source c_1 is supposed to be poor reliable ($\alpha_{Rel,1} = 0.1$) but very important in the decision process ($\alpha_{ImpRel,1} = 1$) while the source c_2 is considered as fully reliable ($\alpha_{Rel,2} = 1$) but not very important in the decision process ($\alpha_{ImpRel,2} = 0.1$). Basic belief assignments correspond to the highest possible level of conflict between sources (see FIG. 23.40).

¹²Evidential reasoning - Multi-criteria decision analysis

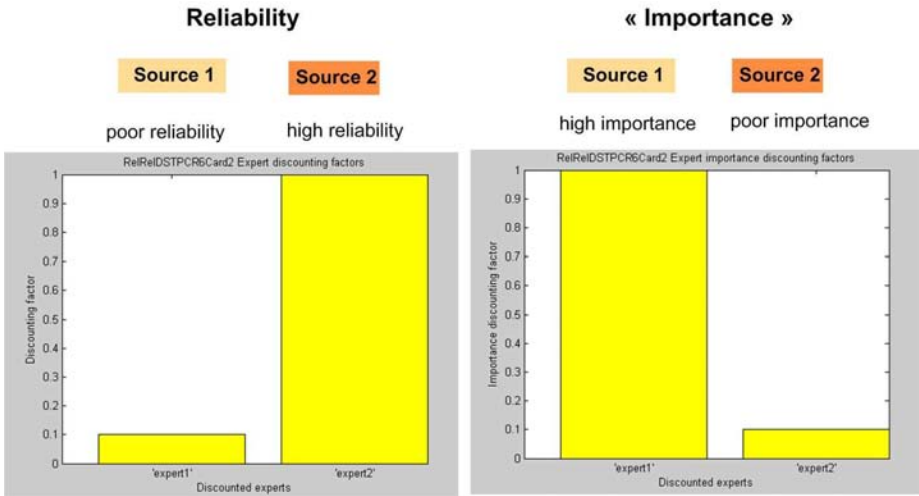

Figure 23.40: Reliability and importance of sources (experts) c_1 and c_2 .

First approach: The classical discounting factor is applied twice (successively)

The Table 23.1 (for DST framework) and the Table 23.2 (for DSMT framework) of discounted criteria using a double successive reliability discounting show that no usable difference appears between the different hypotheses.

Using the classical discounting process to represent the relative importance of a criterion compared to another does not seem to be efficient to make a decision. We therefore introduce a new importance discounting factor in that simple test case.

Second (experimental) approach: The classical discounting factor is first applied, a new discounting factor is applied

The Tables 23.3 (for DST framework) and 23.4 (for DSMT framework) of discounted criteria using first a classical reliability discounting and then an importance discounting. The figure 23.41 shows the comparison with a successive discounting process based on the classical discounting factor.

Conclusion and interpretation

In our opinions, using twice the classical discounting factor to represent both reliability and importance does not provide any valuable information for decision (see left side of FIG. 23.41): the bba resulting from fusion are equal for any elements of the frame of discernment. The fusion process fails here to take importance or preference into account. Note also that the bba have been voluntarily chosen with "extreme"

			$\Theta = \{HD_1, HD_2\}$			
			Discounted bba			
Discounting steps	Source	discounting factor	\emptyset	HD_1	HD_2	Θ
initialization: None	c_1	none	0	0	1	0
	c_2	none	0	1	0	0
Step 1: Reliability	c_1	$\alpha_{Rel,1} = 0.1$	0	0	0.1	0.9
	c_2	$\alpha_{Rel,2} = 1$	0	1	0	0
Step 2: Reliability	c_1	$\alpha_{ImpRel,1} = 1$	0	0	0.1	0.9
	c_2	$\alpha_{ImpRel,2} = 0.1$	0.9	1	0	0
Fusion rule: Dempster's rule						
Result of fusion	$c_1 \oplus c_2$	bba	0	0.0909	0.0909	0.8182
		<i>Bel</i>	0	0.0909	0.0909	1
		<i>Pl</i>	0	0.9091	0.9091	1
		<i>BetP</i>	0	0.5	0.5	1
		<i>DSmP</i>	0	0.5	0.5	1
Fusion rule: Smets rule						
Result of fusion	$c_1 \oplus c_2$	bba	0.01	0.09	0.09	0.81
		<i>Bel</i>	0.01	0.1	0.1	1
		<i>Pl</i>	0.01	0.9	0.9	0.99
		<i>BetP</i>	0.01	0.5050	0.505	1
		<i>DSmP</i>	0.01	0.4950	0.495	0.99
Fusion rule: PCR6 rule						
Result of fusion	$c_1 \oplus c_2$	bba	0	0.095	0.095	0.81
		<i>Bel</i>	0	0.095	0.095	1
		<i>Pl</i>	0	0.905	0.905	1
		<i>BetP</i>	0	0.5	0.5	1
		<i>DSmP</i>	0	0.5	0.5	1

Table 23.1: ER-MCDA framework - **double reliability** discounting of two criteria c_1 and c_2 - **DST framework**.

			$\Theta = \{HD_1, HD_2\}$				
			Discounted bba				
Discounting steps	Source	discounting factor	\emptyset	HD_1	$HD_1 \cap HD_2$	HD_2	Θ
initialization: None	c_1	none	0	0	0	0.1	0.9
	c_2	none	0.9	0.1	0	0	0
Step 1: Reliability	c_1	$\alpha_{Rel,1} = 0.1$	0	0	0	0.1	0.9
	c_2	$\alpha_{Rel,2} = 1$	0	1	0	0	0
Step 2: Reliability	c_1	$\alpha_{ImpRel,1} = 1$	0	0	0	0.1	0.9
	c_2	$\alpha_{ImpRel,2} = 0.1$	0.9	0.1	0	0	0
Fusion rule: DSm, Smets or PCR6 rules							
Result of fusion	$c_1 \oplus c_2$	bba	0	0.09	0.01	0.09	0.81
		<i>Bel</i>	0	0.1	0.01	0.1	1
		<i>Pl</i>	0	1	1	1	1
		<i>BetP</i>	0	0.685	0.37	0.685	1
		<i>DSmP</i>	0	0.99	0.9982	0.999	1

Table 23.2: ER-MCDA framework - **double reliability** discounting of two criteria c_1 and c_2 - **DSmT framework**.

values in our example. In such a case, only the partial conflict redistribution rules

			$\Theta = \{HD_1, HD_2\}$			
			Discounted bba			
Discounting steps	Source	discounting factor	\emptyset	HD_1	HD_2	Θ
initialization: None	c_1	none	0	0	1	0
	c_2	none	0	1	0	0
Step 1: Reliability	c_1	$\alpha_{Rel,1} = 0.1$	0	0	0.1	0.9
	c_2	$\alpha_{Rel,2} = 1$	0	1	0	0
Step 2: Importance	c_1	$\alpha_{Imp,1} = 1$	0	0	0.1	0.9
	c_2	$\alpha_{Imp,2} = 0.1$	0.9	1	0	0
Fusion rule: Dempster's rule						
Result of fusion	$c_1 \oplus c_2$	bba	0	1	0	0
		<i>Bel</i>	0	1	0	0
		<i>Pl</i>	0	1	0	0
		<i>BetP</i>	0	1	0	0
		<i>DSmP</i>	0	1	0	0
Fusion rule: Smets rule						
Result of fusion	$c_1 \oplus c_2$	bba	0.91	0.09	0	0
		<i>Bel</i>	0.91	1	0	0
		<i>Pl</i>	0.91	0.09	0	0
		<i>BetP</i>	0.91	1	0	0
		<i>DSmP</i>	0	0.09	0	0
Fusion rule: PCR6 rule						
Result of fusion	$c_1 \oplus c_2$	bba	0.486	0.095	0.014	0.4050
		<i>Bel</i>	0.486	0.5810	0.5	1
		<i>Pl</i>	0.486	0.5	0.419	0.514
		<i>BetP</i>	0.486	0.7835	0.7025	1
		<i>DSmP</i>	0	0.448	0.066	0.5140

Table 23.3: ER-MCDA framework - **Reliability** and **importance** discounting of two criteria c_1 and c_2 - **DST framework**.

manage to provide a result that can be interpreted for a decision. The analysis of the results when using the importance discounting factor at the second step of the fusion process allow to make the following conclusions (see right side of FIG. 23.41):

- the input bba issued from sources c_1 (or expert 1) and c_2 (or expert 2) are transferred on the empty set and on Θ accordingly to their relative reliability and importance;
- the bba resulting from fusion are distributed on the empty set, Θ and the focal elements. The repartition of bba on those elements provides information about information used in the fusion process. They must be interpreted in a relative way. The respectively very high value assigned to the empty set and Θ correspond to the fact that the two sources have respectively "conflicting" or "very different" importance, while the bba assigned to Θ can be classically interpreted as a comparative level of ignorance. Some limits values can probably be identified. Distance between those limits values and the calculated bba would represent the differential importance or reliability of sources;
- in that case of two highly different sources (full reliable but not important versus poor reliable but important source), the fusion process proposes to choose the most important source which is consistent in a decision context. The absolute

			$\Theta = \{HD_1, HD_2\}$				
			Discounted bba				
Discounting steps	Source	discounting factor	\emptyset	HD_1	$HD_1 \cap HD_2$	HD_2	Θ
initialization: None	c_1	none	0	0	0	0.1	0.9
	c_2	none	0.9	0.1	0	0	0
Step 1: Reliability	c_1	$\alpha_{Rel,1} = 0.1$	0	0	0	0.1	0.9
	c_2	$\alpha_{Rel,2} = 1$	0	1	0	0	0
Step 2: Importance	c_1	$\alpha_{Imp,1} = 1$	0	0	0	0.1	0.9
	c_2	$\alpha_{Imp,2} = 0.1$	0.9	0.1	0	0	0

Fusion rule: DS <i>m</i> rule							
Result of fusion	$c_1 \oplus c_2$	bba	0	0.9	0.1	0	0
		<i>Bel</i>	0	1	0.1	0	0
		<i>Pl</i>	0	1	1	0	0
		<i>BetP</i>	0	1	0.55	0	0
		<i>DS<i>m</i>P</i>	0	1	0.999	0	0

Fusion rule: Smets rule							
Result of fusion	$c_1 \oplus c_2$	bba	0.9	0.09	0.01	0	0
		<i>Bel</i>	0.9	1	0.91	0	0
		<i>Pl</i>	0.9	0.1	0.1	0	0
		<i>BetP</i>	0.9	1	0.955	0	0
		<i>DS<i>m</i>P</i>	0	1	0.099	0	0

Fusion rule: PCR6 rule							
Result of fusion	$c_1 \oplus c_2$	bba	0.486	0.09	0.01	0.009	0.4050
		<i>Bel</i>	0.486	0.586	0.496	0.505	1
		<i>Pl</i>	0.486	0.514	0.514	0.514	0.514
		<i>BetP</i>	0.486	0.8605	0.6805	0.82	1
		<i>DS<i>m</i>P</i>	0	0.5136	0.5131	0.5135	0.514

Table 23.4: ER-MCDA framework - Reliability and importance discounting of two criteria c_1 and c_2 - DS*m*T framework.

value of the bba (here a very low value) and the relative bba assigned to the empty set and Θ provides additional information to interpret this result: the decision is clearly not the result from a complete consensus between sources.

This proposition must obviously be discussed and analyzed in a further way from a practical and theoretical way.

23.3.6 Decision-making

This final step corresponds to the ultimate goal of the whole process. All the more or less uncertain evaluations, provided by more or less reliable sources are fused in a unique decision criteria that has to be analyzed to make a decision. In our framework, the decision is analyzed according to the fusion parameters such as basic belief assignments, credibility, plausibility, pignistic probability assigned to the different hypotheses of the frame of discernment.

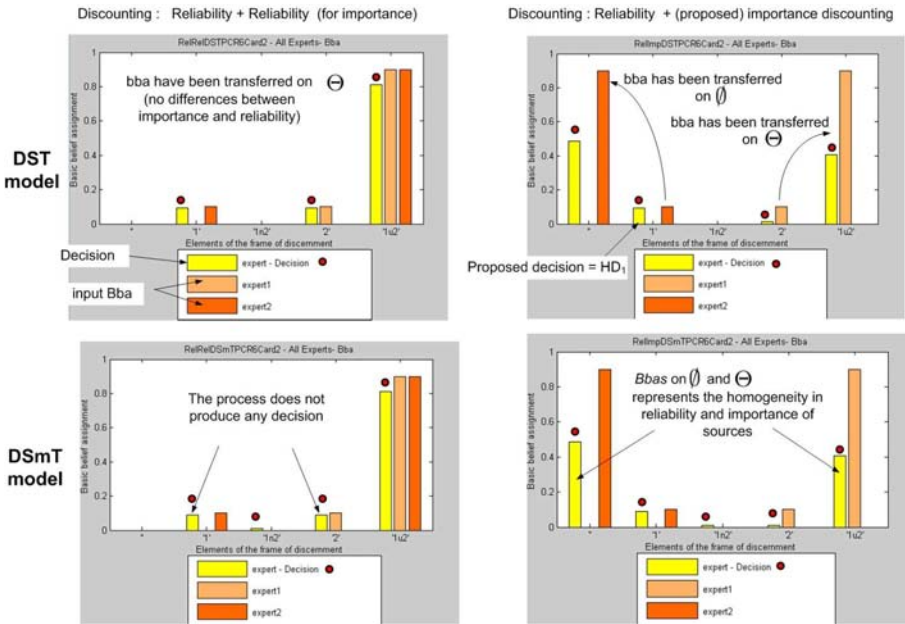

Figure 23.41: Comparison of discounting method: reliability–reliability and reliability–importance (DST and DSMT frameworks).

Making a decision on the basis of these values is a well-known problem for fusion applications [Martin and Quidu 2008, Bloch et al. 2001]. The existing applications mixing evidential reasoning and multi-criteria decision analysis also use these functions to choose a solution once the fusion is done: [Beynon et al. 2000] interprets the results according to the interval between credibility and plausibility: the smaller interval, the more certain is the alternative. There is still some place for proposition of some methods allowing to interpret the results of fusion in a more operational way with one essential objective: the decision must remain understable by the decision-makers themselves !

23.4 Applications: Sensitivity index in a multi-experts environment

We present here two applications cases:

- the first one is a simplified model corresponding to an evaluation of a sensitivity index for snow avalanches in a multi-expert framework. This case is illustrated through numerical examples applied to examples of (quantitative and qualitative) basic level criteria. The process from the evaluations to the mapped bba is illustrated through partial results.
- the second case deals with a geographic application of risk zoning maps, introducing the problem and the specificity for spatial extent of the method without any numerical results.

23.4.1 Sensitivity index in a multi-experts environment

23.4.1.1 Implementation

The DSMT framework allows coping with uncertain and imprecise information. Its main drawback is the complexity in calculations due to the huge number of elements in D^Θ (e.g. with $|\Theta| = 3$ we already get $|D^\Theta| = 19$ elements, with $|\Theta| = 3$ we get $|D^\Theta| = 167$, etc). However, not all the elements of the hyper-power set D^Θ have to be filled in and some automated routines and programs have been proposed either to encode the -power set or to implement the DSMT rule of combination [Djignavorian and Grenier 2006].

In our application, we use a new and powerful calculation framework that allows to consider in an easy and versatile way the different models *free DSMT Model* denoted $(\mathcal{M}^f(\Theta))$, the *hybrid DSMT Model* $\mathcal{M}(\Theta)$ or *Shafer's Model* $\mathcal{M}^0(\Theta)$ [Martin 2009]. These different models correspond to an increasing level of constraints between the different hypotheses of the frame of discernment. Fusion routines have been encapsulated in a global framework that evaluates the multi-criteria decision model and then operates fusion of the basic level criteria. Although it was developed in MATLABTM, this tool has been designed according to object-oriented development principles. An UML conceptual model has been designed to describe the global process. All data are saved in hierarchical structures allowing an easy access to all steps of calculation. The data structures and internal functions can be modified to deal with other hierarchical model. Some graphical functions have been developed to help the user to interpret results.

23.4.1.2 Description of the hierarchic model

In mountainous areas and in France in particular, snow-avalanches are known to be important risks. Face to numerous avalanches prone areas, decision-makers try to determine an exposure level for any site and secondly to propose a classification based on this sensitivity level: this ranking, based on the evaluation of the hazard and vulnerability levels (FIG. 23.42) can then be used to prioritize prevention strategies implementation.

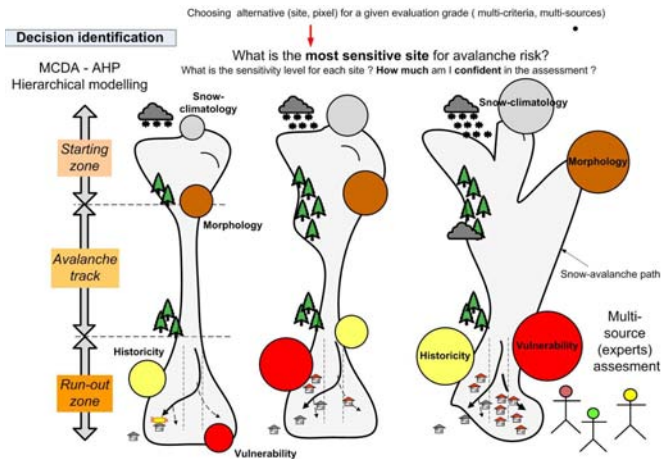

Figure 23.42: Decision context: ranking avalanche prone areas according to hazard and vulnerability related criteria.

We present here a simplified version of the real existing decision support system which consists of a 6-level hierarchy [Rapin 2007] called *SSA* for *Sites Sensible Avalanches* (sensitive avalanche paths). In comparison with the original and existing framework, this application aims at merge several expert evaluations to determine the sensibility index of a snow-avalanche prone-area including imprecise and uncertain evaluations of both qualitative and quantitative criteria. The root of this 3-level hierarchical model (FIG. 23.43) corresponds to the sensitivity level of the avalanche-prone area ($C_{[1]}$). Its principles is based on the classical risk equation as presented in FIG. 23.2. This sensitivity is evaluated according to two sub-criteria corresponding to vulnerability ($C_{[11]}$) and hazard ($C_{[12]}$). The vulnerability criterion is broken down into two basic-level criteria corresponding to a permanent winter occupants ($C_{[111]}$) and living places/infrastructures ($C_{[112]}$). The hazard criterion is broken down into three basic-level criteria corresponding to morphology ($C_{[121]}$), history ($C_{[122]}$) and Snow-climatology ($C_{[123]}$). In the original model, each basic level criterion is evaluated according to a *criterion-estimator-solution* model (FIG. 23.10).

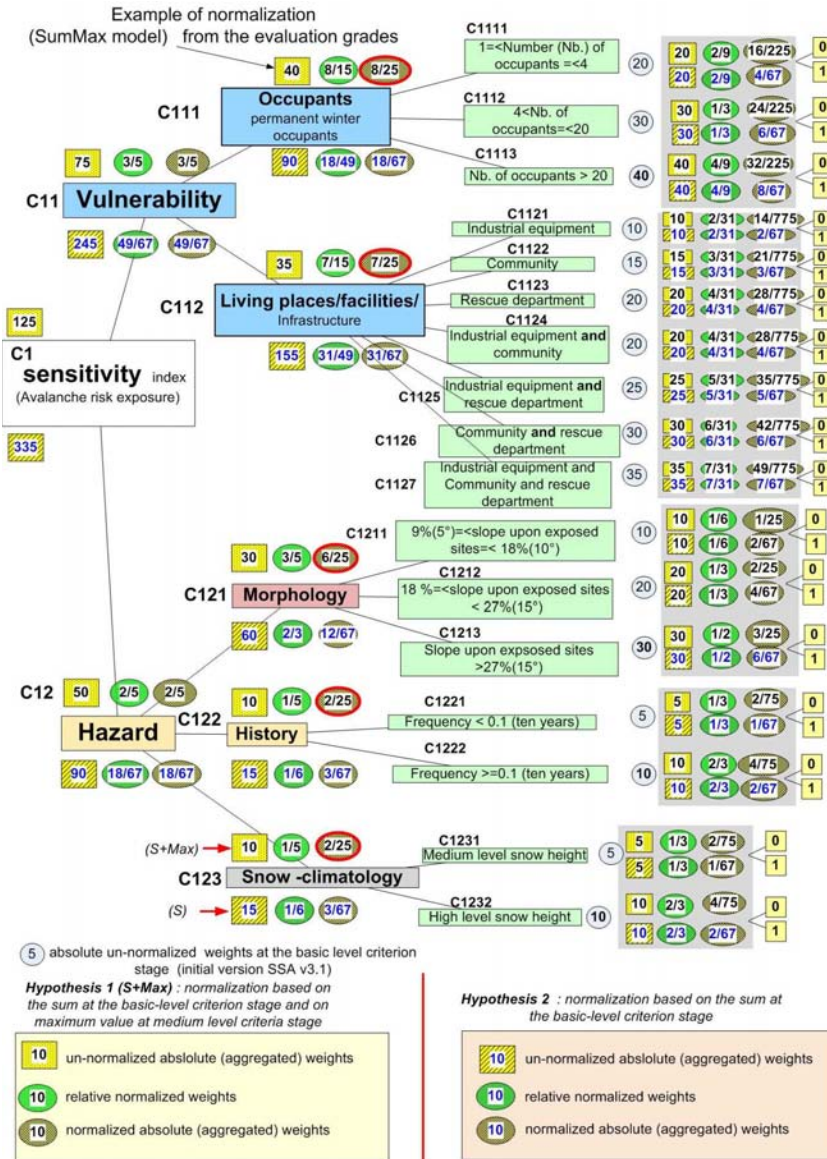

Figure 23.43: Sample simplified model of the Avalanche sensitivity framework.

Note that numerical values used in this sample model are fictive and do not correspond to real numerical intervals used in the original model. The evaluation of five basic-level criteria is done accordingly to the following hypothesis:

- Winter occupants ($C_{[111]}$): this quantitative criterion is evaluated according to the number of winter occupants with 3 evaluation grades in the initial version;
- Living places ($C_{[112]}$): this qualitative criterion is evaluated according to seven evaluation grades corresponding to existing facilities or infrastructures in the studied area;
- Morphology ($C_{[121]}$): this quantitative criterion is evaluated according the slope angle;
- History ($C_{[122]}$): this quantitative criterion is evaluated to an empirical frequency;
- Snow-Climatology ($C_{[123]}$): this quantitative criterion is evaluated according snow-height.

The initial evaluation classes are used as a basis to build the mapping model used in the ER-MCDA model. In that model, classes do not exist anymore for quantitative criteria: the expert provide an evaluation on real numerical values which are then mapped into the elements of the common frame of discernment. For qualitative criteria, a specific method is proposed to consider the level of confidence of the evaluation. In a classical hierarchical AHP approach, weights are calculated for each criterion according to pairwise comparisons from the root criterion to the basic level criterion level. This principle requires having an equal number of evaluation grades for each criterion: increasing the number of evaluation grades for a given basic level criterion induces an higher weight of the basic level criterion with a classical normalization method based on sum. The initial model from which is derived our sample model had not been designed according to this principle. It was not described as a hierarchical structure and un-normalized weights had been defined directly by the experts for each evaluation grade of the basic-level criteria (e.g. 20 for the evaluation grade $C_{[111]}$ corresponding to a class of winter occupants ranging from 1 to 4 persons). To transform these values into normalized weights and propagate them to the different levels of the hierarchy, different normalization principles can be used. In our application, based on a criterion-estimator-solution framework, we use a so-called SumMax method which is based on the following principle: un-normalized weights (at the evaluation grade) are normalized using the sum. The absolute weight of basic level criteria corresponds to the maximum of un-normalized weights of the evaluation grades. Normalization is then done on a sum basis for the other criteria levels up to the root level. The normalized weights are then calculated from the root to the basic level criteria: they are then used to calculate the importance discounting criteria (FIG. 23.44).

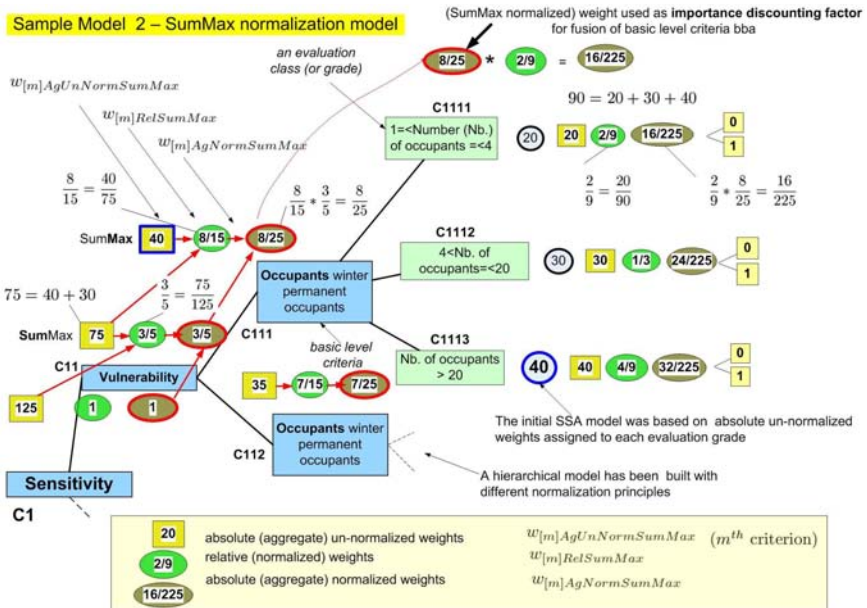

Figure 23.44: From hierarchical model to importance discounting factor.

In our context, we need to build a link between the criteria and the common frame of discernment. The first step of the process consists of mapping the evaluation of basic level criteria by the sources. For each criterion, the mapped bba of those evaluations are then fused together to get a mapped bba for each basic level criterion (FIG. 23.36). Examples of results are described in detail for an example of quantitative criterion ($C_{[111]}$) and for an example of a qualitative criterion ($C_{[112]}$) in the following sections. Only evaluation interval data and a summary table is given for the others criteria.

23.4.1.3 Example of results for the quantitative criterion $C_{[111]}$

The criterion $C_{[111]}$ is a quantitative basic level criterion which corresponds to the vulnerability due to permanent winter occupants in the area. The evaluation provided by the sources consists of numerical intervals corresponding to the number of occupants. First, each source defines numerical intervals with necessity levels (FIG. 23.45).

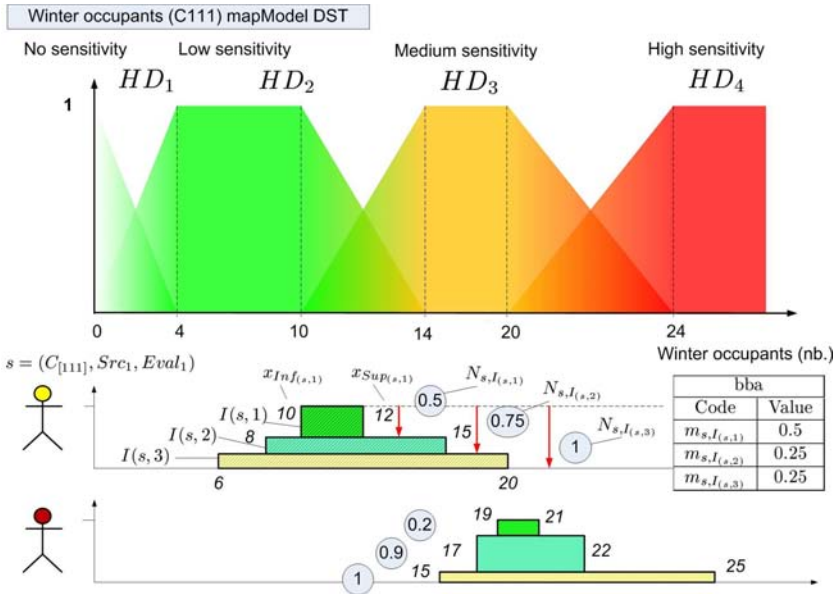

Figure 23.45: From evaluation intervals to mapped bba of intervals.

These necessity levels, interpreted as confidence levels are transformed into bba (FIG. 23.17). The bba corresponding to each evaluation interval are then transferred to each element of the frame of discernment corresponding to the chosen mapping model (DST or DSMT mapping model) according to their areas. The mapped bba for the first evaluation (including 3 intervals) of the source no. 1 is compiled in the Table 23.5 and described in a graphical way in FIG. 23.46. The principle of this calculation as it can be checked in the implemented software application is presented on (FIG. 23.47). For a given source and its evaluations intervals, different mapping processes can be applied. We only present here partial results for a DST *mapping model*.

		source s coded by $(C_{[111]}, Src_1, Eval_1)$			
		Frame of discernment - DST - $\Theta = \{NoS, LS, MS, HS\}$			
		<i>NoS</i>	<i>LS</i>	<i>MS</i>	<i>HS</i>
Int.	Code	$m_{s,I(s,Int)}(HD_1)$	$m_{s,I(s,Int)}(HD_2)$	$m_{s,I(s,Int)}(HD_3)$	$m_{s,I(s,Int)}(HD_4)$
1	$I(s, 1)$	0	0.375	0.125	0
2	$I(s, 2)$	0	0.1429	0.1071	0
3	$I(s, 3)$	0	0.1071	0.1429	0

Table 23.5: Mapped Basic belief assignment (bba)- Criterion $C_{[111]}$ - Source 1 - Evaluation 1 - Fusion process no. 1 - DST framework.

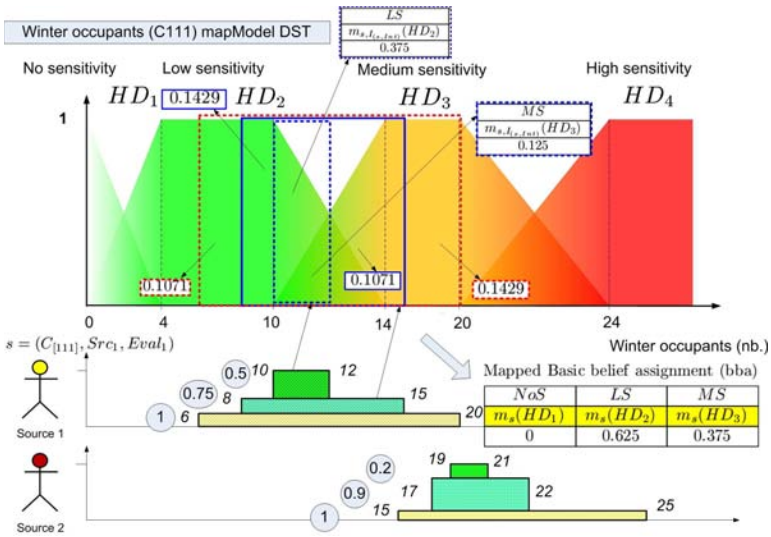

Figure 23.46: From mapped bba of evaluation to mapped bba of criterion $C_{[111]}$.

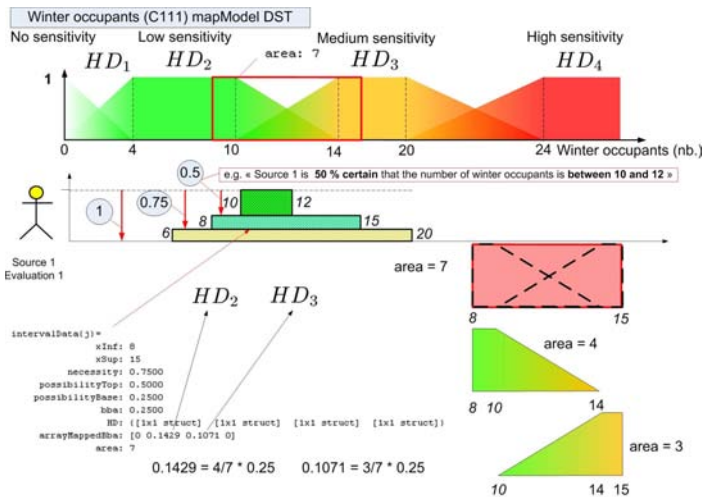

Figure 23.47: Results of mapping process of criterion $C_{[111]}$.

Frame of discernment - DST - $Card(\Theta) = 4$						
α	\emptyset	HD_1	HD_2	HD_3	HD_4	Θ
Discounting factor	empty set	No sensitivity (NoS)	Low sensitivity (LS)	Medium sensitivity (MS)	High sensitivity (HS)	Θ
$m_1 = m_{(C_{[111]}, Src_1, Eval_1)}$	0	0	0.3125	0.1875	0	0.5
$m_2 = m_{(C_{[111]}, Src_2, Eval_1)}$	0.7	0	0	0.621	0.079	0.3
<i>Fusion process no. 1 - Dempster-Shafer (normalized rule)</i>						
$m_{(C_{[111]})} = m_1 \oplus m_2$	0	0	0.1223	0.6306	0.0514	0.1957
<i>Fusion process no. 2 - Smets rule</i>						
$m_{(C_{[111]})} = m_1 \oplus m_2$	0.2335	0	0.0937	0.4834	0.0394	0.15
<i>Fusion process no. 3 - PCR6 rule</i>						
$m_{(C_{[111]})} = m_1 \oplus m_2$	0	0	0.1784	0.6229	0.0487	0.15

Table 23.6: Criterion $C_{[111]}$ - Discounted (evaluation) sources - DST Framework - Fusion order ($\oplus Criterion(\oplus Source - Evaluation)$).

Fusion of mapped bba for $C_{[111]}$

A comparison of different combination rules (DST-normalized, Smets and PCR6 rules) in a DST mapping framework can be done using the same input data taking into account un-discounted or discounted evaluation sources (see the Table 23.6) according to the user choice.

23.4.1.4 Example of results for the qualitative criterion $C_{[112]}$

The evaluation of a qualitative criterion uses both a *scaling model* to produce a belief (credibility) interval and a *mapping model* to transform this credibility interval into the common frame of discernment. The criterion $C_{[112]}$ is a qualitative criterion which corresponds to the vulnerability due to the infrastructures, facilities and collective equipments such as schools in the area. Three main categories corresponding to industrial equipment, collective or community equipments and rescue equipments. Two different scaling models (DST *scaling model* or DSMT *scaling model*) can be used to transform the evaluation provided by the source into a belief interval that will be further used in the qualitative mapping process (see FIG. 23.48).

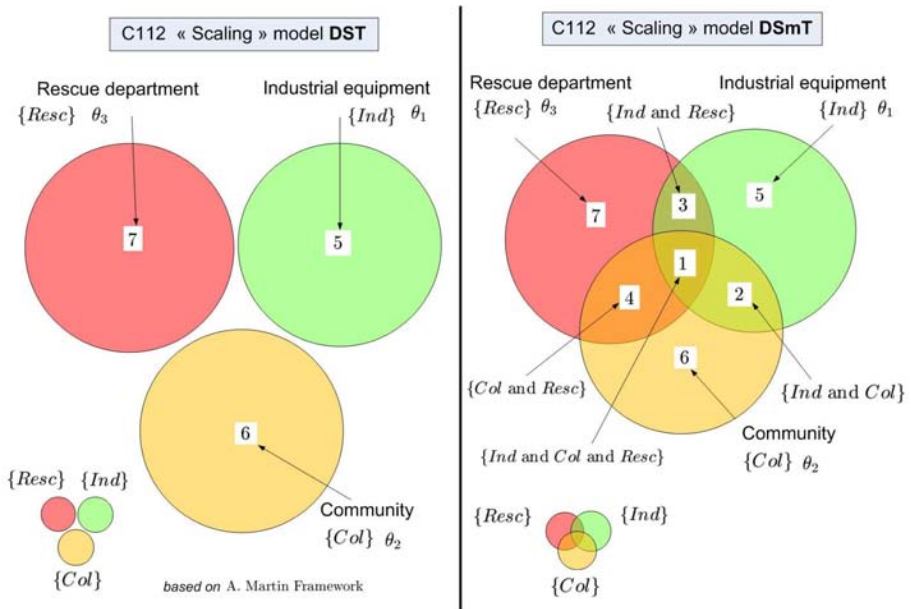

Figure 23.48: Two models for quantitative criterion "Living places" $C_{[112]}$.

We only present here partial results for a DS_mT scaling model and a DST mapping model. The choice of the scaling model depends on the nature of the infrastructures that exist on the site. Some infrastructures may belong to the same time to several categories. To take this into account, we can imagine a DS_mT scaling model which will be presented here. Each qualitative category is analyzed according to its importance (contribution) to the vulnerability using a pairwise comparison approach.

The weights are directly interpreted as bba's. For each combination of types of infrastructures, credibility values are calculated as shown in FIG. 23.49.

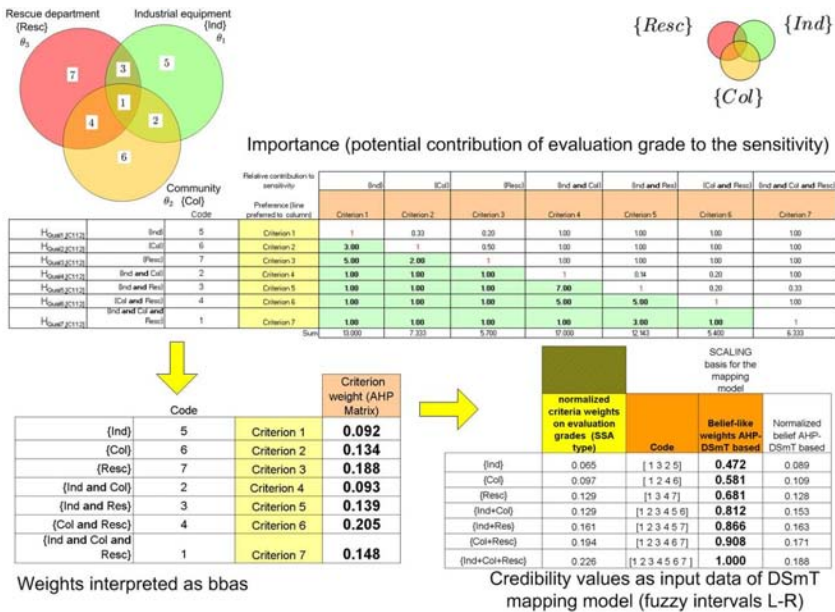

Figure 23.49: Qualitative criterion $C_{[112]}$ - DS_mT scaling - Importance of the evaluation grade for mapping model.

The qualitative mapping model is built to establish a correspondence between an interval evaluation (with a lower and an higher value of credibility) and the common frame of discernment according to the chosen mapping model (for a DST mapping model and a DS_mT scaling model, see FIG. 23.50).

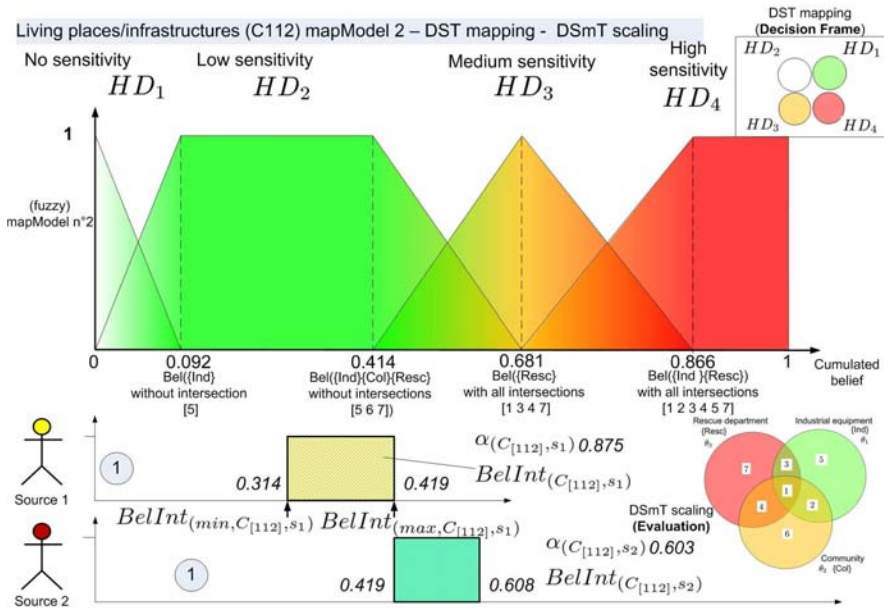

Figure 23.50: Qualitative criterion $C_{[112]}$ - DST mapping - DS_mT scaling - Evaluation intervals for sources 1 and 2.

To provide an evaluation, the user chooses an input value that indicates if the chosen category exists in the zone and then a rating of its confidence level about its evaluation (FIG. 23.51). Results are a weighted belief interval and a discounting factor about this belief interval. These values are then used in the qualitative mapping process using the same principle than as described for quantitative criterion.

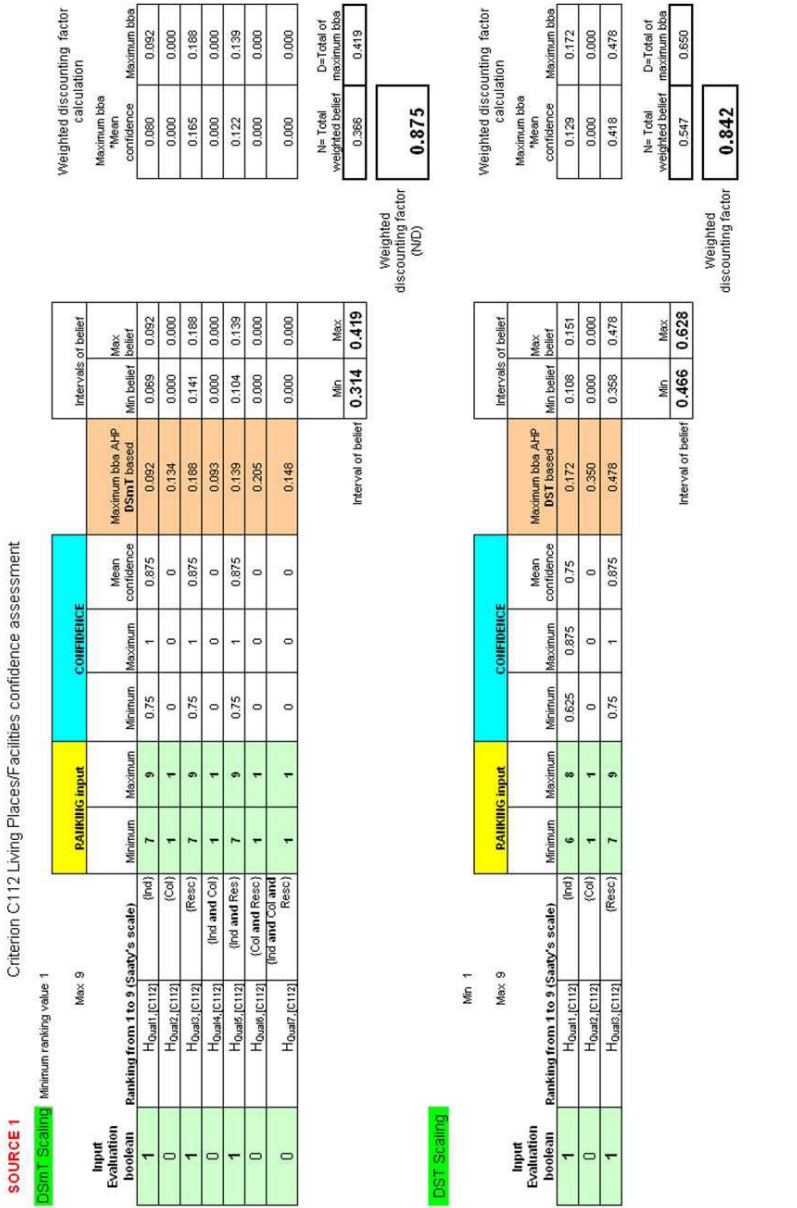

Figure 23.51: Qualitative criterion $C_{[112]}$ - DST and DSMT mapping - confidence levels - source 1.

$input_g$	Evaluation grades	Definition	Ranking	Confidence	Max. bba	Belief interval
1	$H_{Qual_1, C_{[112]}}$	$\{Ind\}$	$inputConfRank_{max}$ 9	$conf_{mean}$ 0.875	0.092	$BelInt_{max,g}$ 0.092
0	$H_{Qual_2, C_{[112]}}$	$\{Col\}$	1	0	0.134	0
1	$H_{Qual_3, C_{[112]}}$	$\{Resc\}$	9	$conf_{min}$ 0.875	0.188	0.188
0	$H_{Qual_4, C_{[112]}}$	$\{Ind\}$ and $\{Col\}$	1	0	0.093	0
1	$H_{Qual_5, C_{[112]}}$	$\{Ind\}$ and $\{Resc\}$	9	$conf_{min}$ 0.875	0.139	0.139
0	$H_{Qual_6, C_{[112]}}$	$\{Col\}$ and $\{Resc\}$	1	0	0.205	0
0	$H_{Qual_7, C_{[112]}}$	$\{Ind\}$ and $\{Col\}$ and $\{Resc\}$	1	0	0.148	0
						0.314 0.419

Table 23.7: Qualitative criterion c_j - Source 1 - interval of beliefs and weighting discounting factor elicitation - DSmT scaling.

Belief interval: from scaling to mapping

A belief interval resulting from the scaling process is used as data in the mapping process of the qualitative criterion. An example of user inputs for confidence levels is given for the criterion $C_{[112]}$ in a context of so-called DSMT scaling where the evaluation grades can have non empty intersections (see the Table 23.7) and in a context of so-called DST scaling where the evaluation grades are considered as exclusive from one to each other (see Table ??). In our application case, for a DST scaling, we get $BelInt_{(C_{[112]},s_1)} = [0.466, 0.628]$ and $\alpha_{(C_{[112]},s_1)} = 0.842$. For a DSMT scaling, we get $BelInt_{(C_{[112]},s_1)} = [0.314, 0.419]$ and $\alpha_{(C_{[112]},s_1)} = 0.875$.

23.4.1.5 Partial results for quantitative criteria: $C_{[121]}$, $C_{[122]}$ & $C_{[123]}$

The following figures describe the evaluation data interval provided by two sources for each of the basic level criteria related to the hazard evaluation in a DST mapping model for the morphology criterion $C_{[121]}$ (FIG. 23.52), the history criterion $C_{[122]}$ (FIG. 23.53) and the snow-meteorology criterion $C_{[123]}$ (FIG. 23.54). The resulting mapped bba for each criterion and each source are then discounted and injected in a fusion process that produces a mapped bba for each criterion.

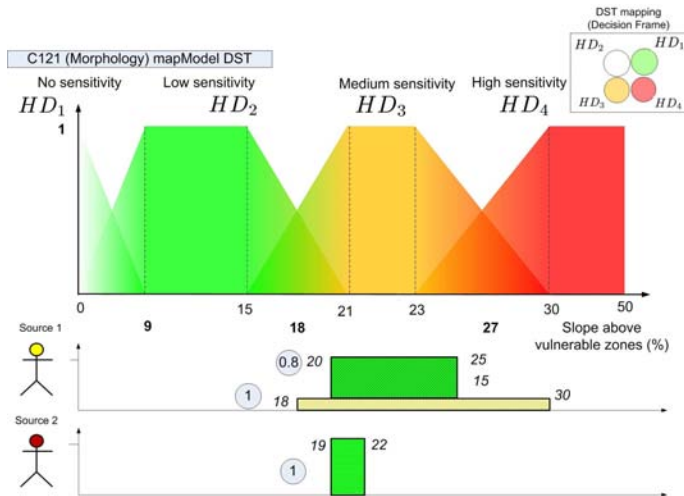

Figure 23.52: Quantitative criterion $C_{[121]}$ - DST mapping - Evaluation intervals for sources 1 and 2.

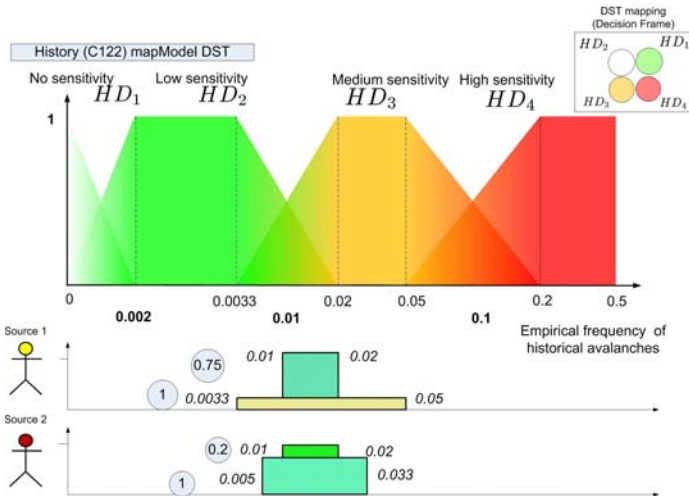

Figure 23.53: Quantitative criterion $C_{[122]}$ - DST mapping - Evaluation intervals for sources 1 and 2.

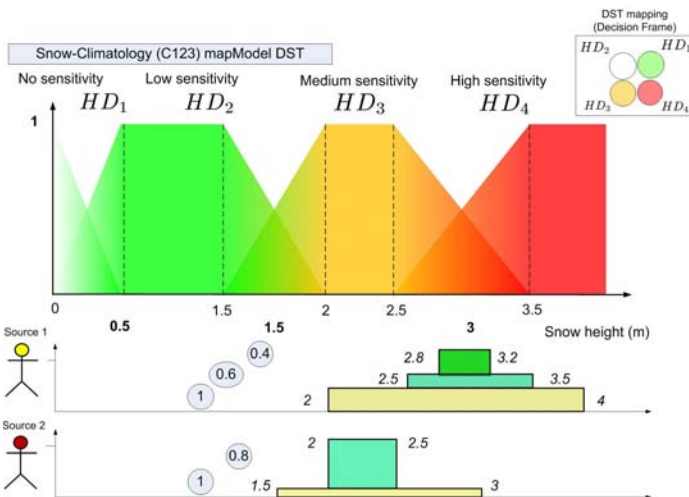

Figure 23.54: Quantitative criterion $C_{[123]}$ - DST mapping - Evaluation intervals for sources 1 and 2.

23.4.1.6 Decision level-criterion $C_{[1]}$

Fusion processes are described in an extensive way according to all the parameters chosen for fusion. On the basis on the same input data set, different simulations can be done to compare fusion rules, mapping models, ... (see FIG. 23.55). This section presents results at the decision level for different examples corresponding to a DST mapping model (fusion processes no. 1 and 3) and a DSMT mapping model (fusion processes no. 7 and 9). These results compare two different mapping models with the same fusion rule (e.g processes 1 and 7 or 3 and 9), the same mapping model with different fusion rules (e.g. processes 1 and 3 or 7 and 9).

Decision level - Fusion process - DST framework

The following tables present the results of fusion of discounted basic-level criteria:

- For the fusion process no. 1, see Table 23.8;
- For the fusion process no. 3, see Table 23.9.

The bba's in the following tables correspond to un-discounted values. The result of fusion comes from discounted bba 's. For each basic level criterion (e.g. $C_{[111]}$), the basic belief assignments correspond to the result of fusion of the discounted evaluations of the different sources (for $C_{[111]}$), this corresponds to the fusion of $m_1 = m_{(C_{[111]}, Src_1, Eval_1)}$ and described in the table of FIG. 23.6. The importance discounting factors are deduced from the hierarchical decision model depending on the normalization and evaluation data input. In that example, we use the *SumMax* model (FIG. 23.43).

Decision level - Fusion process - DSMT framework

The following tables present the equivalent results to fusion process no. 1 and 3 with only changes in the mapping model (from DST model to DSMT model):

- For the fusion process no. 7, see Table 23.10;
- For the fusion process no. 9, see Table 23.11.

Note that in a DSMT model, results are the same for DST rule (to be understood as *DSm* rule) and PCR6 rules since the conflict does not exist.

Decision Model		Name	SampleModel2
		Number of (basic-level)criteria File	5 sampleModel2.mat
Fusion Process	Number Name	1	Fusion process 1
Evidential reasoning (ER) framework	Frame	NoS - LowS-MediumS- HighS	NoS - LowS- MediumS-HighS
	cardTheta	4	4
	ER Theory	DST	DST
Criteria and evaluations discounting	Evaluation discounting mode	discounted evaluation	discounted evaluation
	Basic criteria discounting mode	discounted basic level CriteriaSumMax	discounted basic level CriteriaSumMax
Mapping and scaling process	Mapping model type	DST map	DST map
	Scaling model type (for qualitative criteria)	DST scaling	DST scaling
Fusion parameters	Fusion rule	DST (normalized) Static	PCR6 Static
	Fusion Order Calculation framework	(+Crit(+Src-Eval)) A. Martin @ 2008	(+Crit(+Src-Eval)) A. Martin @ 2008
Decision	Decision Rule Element of decision	Max. pignistic probability Singletons Combination and decision	Max. pignistic probability Singletons Combination and decision
	Display mode	decision	decision
Fusion Process	Number Name	3	Fusion process 3
Evidential reasoning (ER) framework	Frame	NoS - LowS-MediumS- HighS	NoS - LowS- MediumS-HighS
	cardTheta	4	4
	ER Theory	DST	DST
Criteria and evaluations discounting	Evaluation discounting mode	discounted evaluation	discounted evaluation
	Basic criteria discounting mode	discounted basic level CriteriaSumMax	discounted basic level CriteriaSumMax
Mapping and scaling process	Mapping model type	DST map	DST map
	Scaling model type (for qualitative criteria)	DST scaling	DST scaling
Fusion parameters	Fusion rule	DST (normalized) Static	PCR6 Static
	Fusion Order Calculation framework	(+Crit(+Src-Eval)) A. Martin @ 2008	(+Crit(+Src-Eval)) A. Martin @ 2008
Decision	Decision Rule Element of decision	Max. pignistic probability Singletons Combination and decision	Max. pignistic probability Singletons Combination and decision
	Display mode	decision	decision
Fusion Process	Number Name	7	Fusion process 7
Evidential reasoning (ER) framework	Frame	NoS - LowS-HighS	NoS - LowS-HighS
	cardTheta	3	3
	ER Theory	DsmT	DsmT
Criteria and evaluations discounting	Evaluation discounting mode	discounted evaluation	discounted evaluation
	Basic criteria discounting mode	discounted basic level CriteriaSumMax	discounted basic level CriteriaSumMax
Mapping and scaling process	Mapping model type	DsmT map	DsmT map
	Scaling model type (for qualitative criteria)	DST scaling	DST scaling
Fusion parameters	Fusion rule	DST (normalized) Static	PCR6 Static
	Fusion Order Calculation framework	(+Crit(+Src-Eval)) A. Martin @ 2008	(+Crit(+Src-Eval)) A. Martin @ 2008
Decision	Decision Rule Element of decision	Max. pignistic probability Singletons and focal elements Combination and decision	Max. pignistic probability Singletons and focal elements Combination and decision
	Display mode	decision	decision

(+Crit(+Src-Eval)) corresponds to the fusion order (+Criterion(+Source-Evaluation))

Figure 23.55: Description of the fusion processes no. 1, 3, 7 and 9.

Frame of discernment - DST - $Card(\Theta) = 4$						
α	\emptyset	HD_1	HD_2	HD_3	HD_4	Θ
Importance discounting factor (AHP SumMax Model)	empty set	No sensitivity (NoS)	Low sensitivity (LS)	Medium sensitivity (MS)	High sensitivity (HS)	Θ
$m_1 = m_{(\oplus C_{1111})}$	0	0	0.1223	0.6306	0.0514	0.1957
$m_2 = m_{(\oplus C_{1121})}$	0	0	0.0011	0.9164	0.0238	0.0587
$m_3 = m_{(\oplus C_{1211})}$	0	0	0.0293	0.9536	0.005	0.012
$m_4 = m_{(\oplus C_{1221})}$	0	0	0.1633	0.8194	0	0.0172
$m_5 = m_{(\oplus C_{1231})}$	0	0	0.0125	0.9224	0.0453	0.0198
<i>Fusion process no. 1 - Dempster-Shafer (normalized rule)</i>						
$m_{(\oplus C_{11})} = m_1 \oplus m_2 \oplus m_3 \oplus m_4 \oplus m_5$	0	0	0.0059	0.9842	0.0031	0.0068

Table 23.8: Decision criteria $C_{[1]}$ - Fusion Process no. 1 - Discounted basic level criteria - Discounted evaluation sources DST Framework - Fusion order ($\oplus Criterion(\oplus Source - Evaluation)$) - DST mapping - DST scaling.

Frame of discernment - DST - $Card(\Theta) = 4$						
α	\emptyset	HD_1	HD_2	HD_3	HD_4	Θ
Discounting factor (AHP SumMax Model)	empty set	No sensitivity (NoS)	Low sensitivity (LS)	Medium sensitivity (MS)	High sensitivity (HS)	Θ
$m_1 = m_{(\oplus C_{1111})}$	0	0	0.1784	0.6229	0.0487	0.15
$m_2 = m_{(\oplus C_{1122})}$	0	0	0.001	0.9102	0.0368	0.052
$m_3 = m_{(\oplus C_{1211})}$	0	0	0.0393	0.9363	0.0143	0.01
$m_4 = m_{(\oplus C_{1222})}$	0	0	0.1902	0.7973	0	0.0125
$m_5 = m_{(\oplus C_{1233})}$	0	0	0.0098	0.8386	0.1392	0.0125
<i>Fusion process no. 3 - PCR6 Rule</i>						
$m_{(\oplus C_{11})} = m_1 \oplus m_2 \oplus m_3 \oplus m_4 \oplus m_5$	0	0	0.0196	0.8279	0.0047	0.1478

Table 23.9: Decision criteria $C_{[1]}$ - Fusion Process no. 3 - Discounted basic level criteria - Discounted evaluation sources DST Framework - ($\oplus Criterion(\oplus Source - Evaluation)$) - DST mapping - DST scaling.

Frame of discernment - DSmT - $Card(\Theta) = 3$									
α	\emptyset	HD_1	$HD_1 \cap HD_2$	HD_2	$HD_2 \cap HD_3$	HD_3	Θ		
Discounting factor (AHP SumMax Model)	empty set	No sensitivity (NoS)	NoS \cap LS	Low sensitivity (LS)	LS \cap HS	High sensitivity (HS)	Θ		
$m_1 = m_{(\oplus C_{111})}$	1	0	0	0.3337	0.2238	0.2925	0.15		
$m_2 = m_{(\oplus C_{112})}$	0.875	0	0	0.3068	0.2995	0.3417	0.052		
$m_3 = m_{(\oplus C_{121})}$	0.75	0	0	0.3706	0.3841	0.2354	0.01		
$m_4 = m_{(\oplus C_{122})}$	0.25	0	0	0.8638	0.0989	0.0248	0.0125		
$m_5 = m_{(\oplus C_{123})}$	0.25	0	0	0.2752	0.3986	0.3138	0.0125		
<i>Fusion process no. 7 - Dempster-Shafer (normalized rule)</i>									
$m_{(\oplus C_{11})} = m_1 \oplus m_2 \oplus m_3 \oplus m_4 \oplus m_5$	0	0	0	0.0868	0.8563	0.0532	0.0037		

Table 23.10: Decision criteria $C_{[1]}$ - Fusion Process no. 7 - Discounted basic level criteria - Discounted evaluation sources DSmT Framework - Fusion order $(\oplus Criterion)(\oplus Source - Evaluation)$ - DSmT mapping - DST scaling.

Frame of discernment - DSMT - Card(Θ) = 3									
α	\emptyset	HD_1	$HD_1 \cap HD_2$	HD_2	$HD_2 \cap HD_3$	HD_3	Θ		
Discounting factor (AHP SumMax Model)	empty set	No sensitivity (NoS)	NoS \cap LS	Low sensitivity (LS)	LS \cap HS	High sensitivity (HS)	Θ		
$m_1 = m_{(\oplus C_{111})}$	0	0	0	0.3337	0.2238	0.2925	0.15		
$m_2 = m_{(\oplus C_{112})}$	0	0	0	0.3068	0.2995	0.3417	0.052		
$m_3 = m_{(\oplus C_{121})}$	0	0	0	0.3706	0.3841	0.2354	0.01		
$m_4 = m_{(\oplus C_{122})}$	0	0	0	0.8638	0.0989	0.0248	0.0125		
$m_5 = m_{(\oplus C_{123})}$	0	0	0	0.2752	0.3986	0.3138	0.0125		
<i>Fusion process no. 9 - PCR6 rule</i>									
$m_{(\oplus C_{11})} = m_1 \oplus m_2 \oplus m_3 \oplus m_4 \oplus m_5$	0	0	0	0.0868	0.8563	0.0532	0.0037		

Table 23.11: Decision criteria $C_{[1]}$ - Fusion Process no. 9 - Discounted basic level criteria - Discounted evaluation sources DSMT Framework - (\oplus Criterion(\oplus Source - Evaluation)) - DSMT mapping - DST scaling.

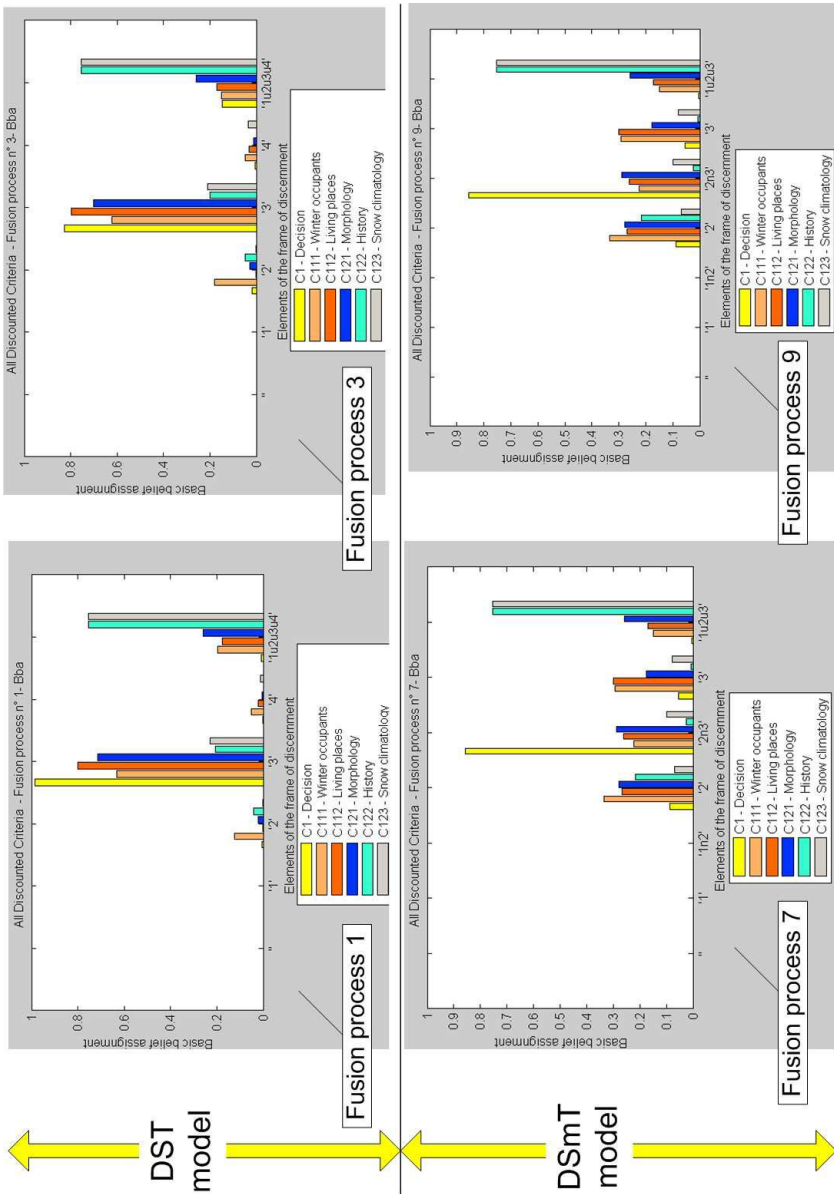
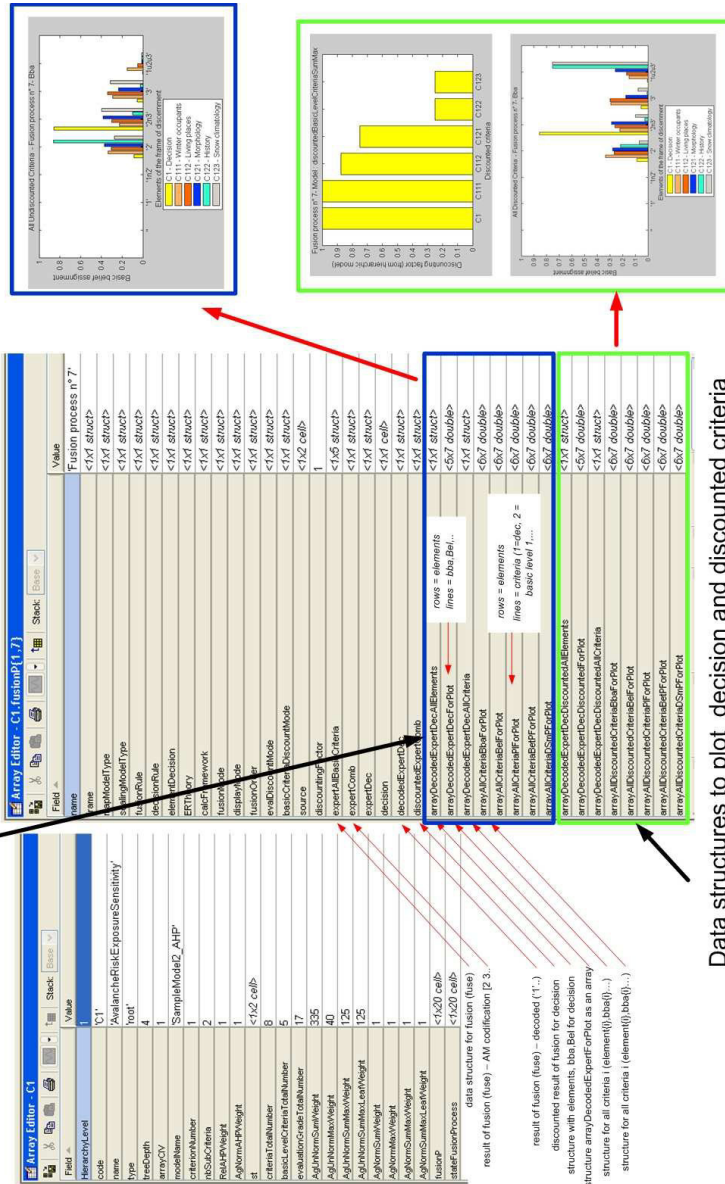

Figure 23.57: Comparison of results for the fusion processes no. 1, 3, 7 and 9.

Data structures to plot decision and undiscounted criteria



Data structures to plot decision and discounted criteria
 Data structure for sample model2
 C1 – Root criterion - Decision level
 (only plot, decision is based on discounted criteria)

Figure 23.58: Root decision criterion $C_{[1]}$ - Fusion process no. 7 - Data structures for results plot.

23.5 Discussion

23.5.1 Mixing uncertainty, imprecision, importance and traceability

Considering both uncertainty, imprecision, importance and traceability of the expertise process is the ultimate goal of a mixed ER-MCDA framework based on decision-aid methods and formal theories for uncertainty management. The purpose is both to aid decision and to describe how far the different sources and evaluations contribute to the final result: is the decision based on certain evaluations of non important criteria and/or based on uncertain evaluations of important criteria?

Through the literature review, two main approaches can be identified. From one hand, decision-aid science and specially the multi-criteria decision analysis community introduces uncertainty management in its traditional framework. This mainly consists of considering uncertain assessment of decision criteria through interval-based, fuzzy or evidence theory based approaches. On the other hand, "new" uncertainty theories (possibilities, evidence theory) develop applications with obvious decision purposes. Criterion decision based on fused information are proposed in those different frameworks.

In our approach, the Analytic Hierarchy Process (AHP) is used as a conceptual tool to model the problem, to elicit preferences and subjective basic belief assignments (bba) to be used in the fusion process. Using information fusion in a multi-criteria decision analysis framework requires that the model analyst should be able to assess each criterion according to common scale and/or evaluation grades. In the proposed model, these evaluation grades are considered as elements of the frame of discernment. Under this assumption of a common frame of discernment, the information fusion and specially its new developments such as DS_mT and fusion rules for conflict situations offer interesting abilities to help to make a decision in the natural hazard context. Uncertain evaluations of quantitative criteria are fused either at the design model stage or at the evaluation stage (fusing the different experts sources). As decision depends on fusion process, choosing ad-hoc combination rules is essential: the combination rules must remain efficient when the conflict level is very high, e.g. when the classical combination rules of DST fails to propose acceptable results.

Our approach has explored some developments of these ideas while trying to consider limits and drawbacks of each of methods and theories. Indeed, if the principle of a joined application of evidential reasoning and Multi-Criteria Decision Analysis (MCDA) is an interesting perspective, some questions remain, as described in the following section.

23.5.2 Advantages and lacks of the ER-MCDA framework

In comparison with existing approaches, we consider that this framework offer the following advantages:

- First, it allows to trace uncertainty and imprecision for both quantitative and qualitative criteria. In comparison with existing approaches mixing multi-criteria decision analysis and evidential reasoning, the information sources, mainly resulting from expert assessment, are fully described. The expert judgements are identified both for modeling and evaluation steps. Links between criteria evaluation and the fusion process an specially the choice of the frame of discernment are elicited through so-called quantitative and qualitative mapping processes;
- A formal description and conceptual modeling are proposed. They describe both the decision model design and the belief function theory framework. A comparison is proposed to model the same problem using the classical Dempster-Shafer framework (DST) based on exhaustive and exclusive hypothesis, and the more recent Dezert-Smarandache framework (DSmT) which relaxes those constraints;
- In our application, using advanced and recent fusion rules (such as PCR6 rule) allow more realistic decisions. "Ad-hocity" of fusion rules depending on the class problem is still a research question;
- Importance (related to the preference concept) and reliability should be considered as two different concepts in any model. A method of a specific discounting method is proposed but has to be studied in a theoretical way.

The lacks or remaining questions related to the proposed framework are described as following:

- The difference between fusion and aggregation of preferences remains an important subject of debate. Fusion and multi-criteria decision analysis cannot be used in the same conditions. In that sense, some hypothesis of pre-existing models mixing MCDA and evidential reasoning such as DS-AHP Beynon2000 and other variants can immediatly be criticized according to the way in which they mix weights (corresponding to preferences) and fusion process. The fusion process should be compliant with the nature of combined information: it is recognized that aggregating preferences and fusing pieces of uncertain evidence should involve different fusion methods Bloch2001 but no definitive and practical classification is available;
- Basic belief assignment elicitation is an essential part of process. The subjective evaluation of *bba* for qualitative criteria using the AHP process can be criticized. At least, it allows to trace the hypothesis and choices of the evaluating experts;

- At the present stage of development, reliability of sources are chosen in a very arbitrary and subjective way. Multi-criteria approaches can be imagined upstream from the fusion process to characterize this expert reliability according to experience, backgrounds ... Tacnet2006b;
- The fact that we consider a unique frame of discernment is also questionable: with such a principle, we force the sources to provide an evaluation that will be compliant with the common frame of discernment through a so-called mapping process. It may also be argued that the decision is too strongly influenced by the chosen hierarchical model. This framework requires to define mapping processes to evaluate all the criteria in the chosen frame of discernment. Sensitivity analysis should be done to analyze whether the choice of this mapping models influences the final result for fusion;
- In this present version, the framework provide information for decision but not a real decision. Different alternatives or choices are described in a finer way than with usual MCDA methods with regards to their uncertainty level. The final result has still to be analyzed to produce a decision as in any fusion problem. The further development will probably involve decision-aid method (total aggregation or outranking methods) using result of fusion to make a decision;

23.5.3 The question of the validation

As it involves a fusion process, the proposed ER-MCDA framework does not avoid the difficult question of validation. How can a fusion system be validated and evaluated (what does it mean) ? Bloch2001 analyse the way to propose such a validation as following. The validation should concern the problem modeling, the data input, the fusion in itself and the outputs of the system. In most applications, the proposed decision-aid systems propose solutions but do not check with a real and pre-existing choice. This situation also includes applications dealing with simplified testing cases without any real need for decision (choosing a car, a master course, a candidate). Nevertheless, this remains an important question and we humbly recognize that no satisfying answer exists in our application domain of natural hazards at the moment. We only describe here some principles to implement such a validation.

Testing the sources is the first necessary step to evaluate the experts reliability according to, as an example, their tendency toward overconfidence. Finally, in order to judge the value of the outputs, the easiest situation corresponds to cases where it is possible to make a comparison between a collection of input examples for which expected answers of the fusion process are known by experience or expertise. When validation results arrive after the fusion was done, it is much more difficult to make a conclusion and decide whether the process is inappropriate or the information provided is not sufficient. Finally, the last but not the least way to validate the global decision and/or fusion results is to check that its principles are understood and useful for the end-users who are supposed to use it as a decision tool

From a thematic point of view related to natural hazards management, validation in a decision context (normative vs. empirical approach) also remains a problem. In industrial contexts, experimental data are more easily available to validate models and decision-aid tools. When dealing with expert approaches, it remains quite difficult to validate the result of the proposed methodology since the solution is never unique and fully certain. Should we consider the existing result as the target for the decision-aid system, given that all the hypotheses are not always fully argued and justified in an explicit way ? For risk zoning maps, we cannot consider one result as a reference that should be obtained by the compared method. The intrinsic value of such a map is in fact difficult to establish. A satisfactory zoning map would correspond to a situation where no unexpected damage occur. A zoning map can be considered as right as long as no event has occurred in a way that had not been planned during its design. Therefore, a way to validate the process can consist of making a list of required quality criteria for expertise processes and to analyze if the proposed methodology is able to improve the existing implementation framework. We are able to measure the validity of the result only when the reference event (considered as rare most of time) occurs. A priori validation is therefore quite difficult. In our case, we consider than a formal elicitation of the reasoning process and the uncertainty level linked to these information in a recognized theoretical framework is already a valuable result. Being able to explicit how the decision was taken (with or without conflicts between experts) and on which initial basis (scientific hypothesis, field data, historical data . . .) it was founded are already two important step towards the validation of an expertise result.

23.5.4 Towards an improved ER-MCDA framework

Neither the framework based on multi-criteria decision analysis or fusion seem able to propose alone an ideal framework to make a decision when several more or less reliable sources provide uncertain and imprecise evaluations on heterogeneous and conflicting criteria. Reaching a compromise respecting the preferences of decision-makers seems as necessary than evaluating and considering the truth associated to their evaluations. At the end, despite of some known difficulties, mixing evidential reasoning and multi-criteria decision-aid methods remains a promising perspective. For further developments, we think at the end that an improved decision framework should use fusion results as inputs data for a multi-criteria partial aggregation method (or outranking method) such as ELECTRE Roy1985 and its more recent variants (Fig. 23.59).

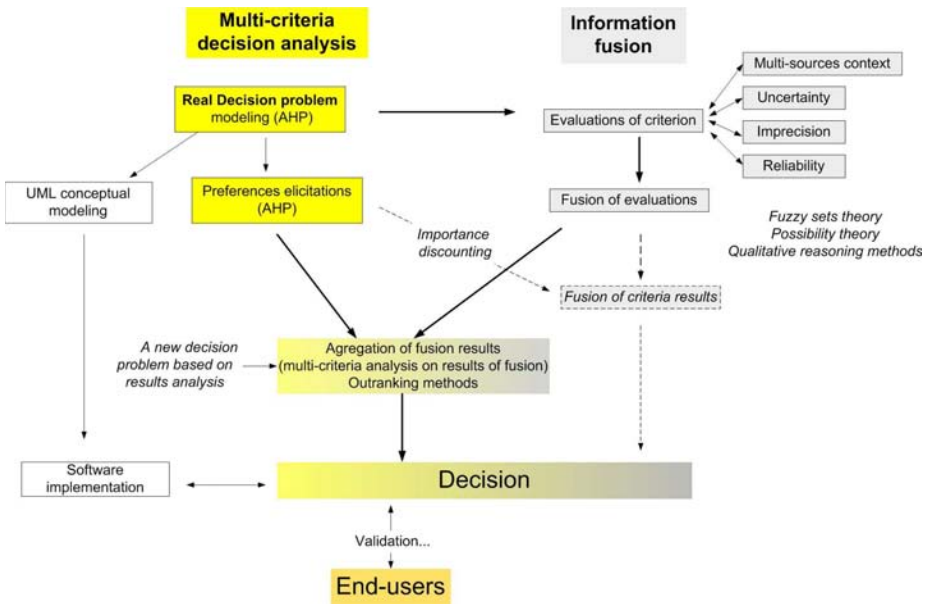

Figure 23.59: The ideal ER-MCDA framework: fusion at the evaluation level, multi-criteria decision analysis for problem modeling and decision making.

23.6 Conclusion

Searching for the best of MCDA and evidential reasoning

The natural hazards risk management process is indeed a real complex decision framework where uncertainty and imprecision come both from the different steps of the risk analysis, its actors and the information sources. Mixing multi-criteria decision analysis (MCDA) and evidential reasoning (ER), using some recent developments such as new fusion rules and theoretical framework such as Dezert-Smarandache Theory (DSmT) is a very attractive objective. This first link between the belief function theory, multi-criteria decision making for natural risks management in mountains areas appears as an encouraging research development direction. From one side, multi-criteria methods consider (more or less depending on their hypothesis) the complexity of the real world, the non-rational behaviour of decision maker, the un-comparability of choices to help the decision-maker. On the other side, belief function (or Evidence) theory is a powerful and versatile framework for human reasoning under uncertainty. Departing from a real, therefore complex, decision problem, this work proposes an operational methodology to integrate those two approaches at different steps of the reasoning process. Improving the elicitation of these levels of imprecision and uncertainty obviously induce more complexity in the risk management framework. As against, it is a possible way to increase the risk awareness in the population and decision makers: experts judgements are not the absolute truth.

Implementation is possible: a first practical framework to improve

A dilemma when trying to imagine a framework that deals with decision and uncertainty is to propose an application whose principles, input and results can be understood by the decision makers. On this basis, introducing an uncertainty level in existing decision-aid methods could be roughly and immediately considered as useless according to the previous objective since fusion calculation can quickly induce high complexity. Though its recognized abilities to represent human theory under uncertainty, the belief function theory (or Evidence Theory) still remains difficult to implement. This applies to the classical Dempster-Shafer Theory (DST) but also to the recent DSmT. Last developments on fusion calculation moderate these traditional drawbacks. From a software programming implementation point of view, this framework implies to handle a great amount of data which needs to be structured. Mixing multi-criteria decision analysis and fusion applications produce more informational results than the classical individual approaches. Data models and conceptual modeling of this kind of problem have been proposed as a basis for further development. The formal description of both hierarchical model and uncertain evaluation also allows to make some links with information systems. Such methodologies issued from software engineering appear as valuable tools to describe the problematic, its components but also to prepare a further integration in a database management system (DBMS). The global methodology contributes therefore to help decision but also to improve the traceability of reasoning process which is an important requirement and

domain of progress in the natural hazards risk management context. The principles of the method remain quite simple and we consider that it can be easily understood by the decision-makers and experts. Graphical synthetic results are proposed as examples to help the decision. All this remain a prototype and for decision purposes, there are still work to be done to design and realize a full friendly-user application. To our point of view, one of the advantage of this framework is first to elicit the reasoning hypothesis chosen by the experts along their decision process with respect to the conflict and ignorance levels associated to their evaluations. This concern as much the alternatives evaluations than the models used to make transformation from one framework to another (e.g. the so-called "scaling" and "mapping" models used to transform qualitative and quantitative evaluations into a common frame of discernment).

Remaining issues and further developments

Main issues to use DST and DS_mT in the natural hazards expertise context remain:

- the use of the results for decision purpose with optimistic, pessimistic or compromise point of views;
- fusion order according to (or not) the hierarchical framework of the multi-criteria approach;
- choice of fusion rules according to their ability to take conflict into account;
- choice and evaluation of discounting factors related to the different information sources. A multi-criteria approach can be useful to determine these discounting factors;
- results validation.

Main difficulties come from the choice of the frame of discernment, the conflict management and aggregation techniques. This approach extends some existing mixed application of evidential reasoning and multi-criteria decision models. We show that DS_mT provides a versatile tool able to consider imprecise and uncertain information with some advantages such as conflict management and paradoxical information. In our framework, deterministic models such as snow-avalanches modeling tools would be considered as common sources. Assessing the reliability of such model corresponds to an important research issue: it comes as much from the modeling hypotheses than from data uncertainty. To handle this uncertainty, some new approaches mixing probabilistic and possibilistic frameworks and called "hybrid methods" have been proposed by Baudrit et al. recently. In the natural hazards context, data are often lacking or incomplete. Those approaches should be developed to characterize the uncertainty coming from modeling in the global expertise process. Other multi-criteria decision frameworks could be tested in order to compare this framework with partial aggregation techniques such as Electre-based method. Outranking methods

should be used to produce a decision. This could include comparison between differences of credibility, plausibility, pignistic probability, etc. An improved ER-MCDA framework, and a further way for development, could include fusion process at the evaluation level and multi-criteria decision analysis at the initial stage of problem modeling and at the ultimate stage for decision making.

Guidelines for further developments

From a theoretical point of view, the question of ad-hocity of fusion or aggregation methods according to the problem still requires additional research. Efficient fusion techniques are necessary to have a global assessment of situation and to help to take the right decision, and an efficient decision-making support system will help in the risk prevention against natural hazards. The model proposed in this work is a first attempt to introduce the global problematic of information fusion for natural hazards risk assessment. Of course, some developments for improving these frameworks in relationship with the fusion and decision-aid methods community are under progress in several directions. For example, a deep parametric analysis must be carried out to precisely estimate the importance discounting and reliability factors of all the sources before extending this ER-MCDA approach to the full-criteria real case application. From a thematic point of view, the global methodology is not strictly limited to the snow-avalanche domain: it can be used in others contexts of natural hazards where expertise is required such as torrential floods, rockfalls, etc, as well. Many ways are possible to improve this approach, say by a better choice and comparative analysis of decision rules and on the model choices specially for geographical aspects. To be used in a practical way, numeric tools will be also required. The model has to be plugged with DBMS systems that use information. New developments about qualitative combination rules proposed in DS_mT have not yet been tested and could also be used.

23.7 Acknowledgments

We would like to thank especially Arnaud Martin from ENSIETA, France and Pascal Djiknavorian from DRDC Valcartier, Canada who kindly accepted to provide their MATLABTM routines allowing numerical implementation and model building. On the expert side of the problem, we also thank François Rapin for his expert view on snow-avalanche engineering problems and information provided as a main designer of the initial snow-avalanche sensitivity method. Finally, we also thank Laure Barral and Eric Maldonado for her help in UML modeling of the ER-MCDA.

23.8 References

- [Allais 1953] M. Allais, *Le comportement de l'homme rationnel devant le risque: critique des postulats et axiomes de l'école américaine*, *Econometrica*, Vol. 21, pp. 503–546, 1953.
- [Ancey 2006] C. Ancey, *Dynamique des avalanches*, Presses polytechniques universitaires romandes (Lausanne, Suisse) - Cemagref (Antony, France), 2006.
- [Apel et al. 2004] H. Apel, A. Thieken, B. Merz and G. Blöschl, *Flood risk assessment and associated uncertainty*, *Natural Hazards and Earth System Science*, pp. 295–308, 2004.
- [Barbolini and Savi 2001] M. Barbolini, F. Savi, *Estimate of uncertainties in avalanche hazard mapping*, *Annals of Glaciology*, pp. 299–305, 2001.
- [Baudrit et al. 2005a] C. Baudrit, D. Guyonnet and D. Dubois, *Postprocessing the hybrid method for addressing uncertainty in risk assessments*, *Journal of Environmental Engineering*, 131(12):1750–1754, 2005.
- [Baudrit et al. 2007] C. Baudrit, D. Guyonnet and D. Dubois, *Joint propagation of variability and imprecision in assessing the risk of groundwater contamination*, *Journal of Contaminant Hydrology*, 93(1-4):72–84, 2007.
- [Baudrit et al. 2005b] C. Baudrit, C. Mercat-Rommens and E. Chojnacki, *Influence de la représentation mathématique de la connaissance sur les résultats de calcul de risque*, rapport de/secure no. 2005-14, Technical report, IRSN (Institut de Radioprotection et de Sécurité Nucléaire), Le Vesinet, 2005.
- [Beynon et al. 2000] M. Beynon, B. Curry and P. Morgan, *The Dempster-Shafer theory of evidence: an alternative approach to multicriteria decision modelling*, *Omega*, 28(1):37–50, 2000.
- [Beynon 2002] M. Beynon, *DS/AHP method: A mathematical analysis, including an understanding of uncertainty*, *European Journal of Operational Research*, 140(1):148–164, 2002.
- [Beynon 2005] M. Beynon, *Understanding local ignorance and non-specificity within the DS/AHP method of multi-criteria decision making*, *European Journal of Operational Research*, 163(2):403–417, 2005.
- [Binaghi et al. 1998] E. Binaghi, L. Luzi, P. Madella, F. Pergalani and A. Rampini, *Slope instability zonation: A comparison between certainty factor and fuzzy Dempster-Shafer approaches*, *Natural Hazards*, 17(1):77–97, 1998.
- [Bloch et al. 2001] I. Bloch et al., *Fusion: General concepts and characteristics*, *International Journal of Intelligent Systems*, 16(10):1107–1134, 2001.

- [Brans et al. 1984] J.-P. Brans, B. Mareschal and P. Vincke, *Promethee, a new family of outranking methods in multicriteria analysis*, Operations research '84', pp. 408–421, Elsevier Science Publishers, North Holland, 1984.
- [Bryson et al. 1994] N. Bryson, O. K. Ngwenyama and A. Mobolurin, *A qualitative discriminant process for scoring and ranking in group support systems*, Information Processing and Management, 30(3):389–405, 1994.
- [Climaco 2004] J. C. Nclimaco, *A critical reflection on optimal decision*, European Journal of Operational Research Management of the Future MCDA: Dynamic and Ethical Contributions, 153(2):506–516, 2004.
- [Corgne et al. 2006] S. Corgne, L. Hubert-Moy, J. Dezert and G. Mercier, *Application of DSMT for Land Cover Change Prediction*, Chapter 17 in [Smarandache and Dezert 2004], pp. 371–382, 2006.
- [Curt 2008] C. Curt, *Evaluation de la performance des barrages en service basée sur une formalisation et une agrégation des connaissances - Application aux barrages en remblai- Thèse de doctorat*, Ph.D. thesis, Université Blaise Pascal - Clermont 2, Clermont-Ferrand, 2008
- [Dezert 2003] J. Dezert, *Fondations pour une nouvelle théorie du raisonnement plausible et paradoxal. application à la fusion d'informations incertaines et conflictuelles*, Rapport no RT 1/06769/DTIM, Technical report, ONERA, Département Traitement de l'Information et Modélisation, 2003.
- [Dezert and Smarandache 2006a] J. Dezert, F. Smarandache, *Introduction to the fusion of quantitative and qualitative beliefs*, Information & Security An International Journal, 20:9–49, 2006.
- [Dezert and Smarandache 2009] J. Dezert, F. Smarandache, *Chapter 1: An introduction to DSMT*, in Advances and applications of DSMT for Information Fusion, Collected works, Volume 3, 2009.
- [Djiknavorian and Grenier 2006] P. Djiknavorian, D. Grenier, *Chapitre 15: Reducing DSMT hybrid rule complexity through optimization of the calculation algorithm*, in [Smarandache and Dezert 2006a], pp. 365–430, 2006.
- [Dorren and Heuvelink 2004] L. Dorren, G. Heuvelink, *Effect of support size on the accuracy of a distributed rockfall model*, International Journal of Geographical Information Science, pp. 595–609, 2004.
- [Dubois et al. 2000] D. Dubois, H. NGuyen and H. Prade, *Possibility theory, probability and fuzzy sets: Misunderstandings, bridges and gaps*, The Handbook of Fuzzy Sets Series, Kluwer Academic Publishers, Boston, MA, U.S.A., pp. 343–438, 2000.

- [Dubois et al. 2001] D. Dubois, M. Grabisch, H. Prade and Ph. Smets, *Using the transferable belief model and a qualitative possibility theory approach on an illustrative example: The assessment of the value of a candidate*, International Journal of Intelligent Systems, 16(11):1245–1272, 2001.
- [Dubois and Prade 2004] D. Dubois, H. Prade, *On the use of aggregation operations in information fusion processes*, Fuzzy Sets and Systems, 142(1):143–161, 2004.
- [Dubois and Prade 2006] D. Dubois, H. Prade, *Chapitre 3 - Représentations formelles de l'incertain et de l'imprécis*, in Concepts et méthodes pour l'aide à la décision 1 - Outils de modélisation, Hermès - Lavoisier, Paris, France, 2006.
- [Dyer 2005] J. Dyer, *Maut - Multiattribute Utility theory*, International Series in Operations Research and Management Science, Springer, New-York, 2005.
- [Dweiri 1999] F. Dweiri, *Fuzzy development of crisp activity relationship charts for facilities layout*, Computers & Industrial Engineering, 36(1):1–16, 1999.
- [Ellsberg 1961] D. Ellsberg, *Risk, ambiguity and the savage axioms*, Quarterly Journal of Economics, (no. 75):643–669, 1961.
- [Eckert et al. 2008a] N. Eckert, E. Parent, T. Faug and M. Naaim, *Bayesian optimal design of an avalanche dam using a multivariate numerical avalanche model*, Stochastic Environmental Research and Risk Assessment, pages 1–19, 2008.
- [Eckert et al. 2008] N. Eckert, E. Parent, T. Faug and M. Naaim, *Optimal design under uncertainty of a passive defense structure against snow avalanches: From a general Bayesian framework to a simple analytical model*, Natural Hazards and Earth System Science, 8(5):1067–1081, 2008.
- [Fenton and Wang 2006] N. Fenton, W. Wang, *Risk and confidence analysis for fuzzy multicriteria decision making*, Knowledge-Based Systems, 19(6):430–437, 2006
- [Forman 1993] E. H. Forman, *Facts and fictions about the analytic hierarchy process*, Mathematical and Computer Modelling, 17(4-5):19–26, 1993.
- [Forman and Selly 2002] E. Forman, M. A. Selly, *Decision by Objectives*, World Scientific Publishing, Singapore, 2002.
- [Fowler 2000] M. Fowler, *UML Distilled, Second Edition*, Addison-Wesley, 2000.
- [Gajdos et al. 2008] T. Gajdos, H. Takashi, J.-M Tallon and J.-C. Vergnaud, *Attitude toward imprecise information*, Journal of Economic Theory, 140:27–65, 2008.
- [Gamma et al. 1995] E. Gamma, R. Helm, R. Johnson and J. Vlissides, *Design Patterns: Elements of reusable Object-Oriented Software*, Addison-Wesley, 1995.

- [Guitouni and Martel 1998] A. Guitouni, J.-M. Martel, *Tentative guidelines to help choosing an appropriate mcdm method*, European Journal of Operational Research, 109(2):501–521, 1998.
- [Haenni 2002] R. Haenni, *Are alternatives to Dempster's rule of combination real alternatives? comments on "About the belief function combination and the conflict management problem"* - Lefevre et al., Information Fusion, 3(3):237–239, 2002.
- [Hua et al. 2008] Z. Hua, B. Gong and X. Xu, *A DS-AHP approach for multi-attribute decision making problem with incomplete information*, Expert Systems with Applications, 34(3):2221–2227, 2008.
- [Jabeur and Martel 2005] K. Jabeur, J.-M. Martel, *La décision de groupe: application de méthodes de surclassement de synthèse*, Bulletin du Groupe de Travail Européen "Aide multicritère à la décision", Série no. 3 (no. 11 - Printemps 2005), 2005.
- [Jabeur and Martel 2006] K. Jabeur, J.-M. Martel, *An ordinal sorting method for group decision-making*, European Journal of Operational Research, Corrected Proof, 2006.
- [Keeney and Raiffa 1976] R. Keeney, H. Raiffa, *Decisions with multiple objectives; preferences and values trade-offs*, J. Wiley and Sons, New York, 1976.
- [Klinke and Renn 2002] A. Klinke, O. Renn, *A new approach to risk evaluation and management: Risk-based, precaution based, and discourse based strategies*, Risk Analysis, 22(6):1071–1094, 2002.
- [Kuo et al. 2006] M.-S. Kuo, G.-S. N. Liang and W.-C. Huang, *Extensions of the multicriteria analysis with pairwise comparison under a fuzzy environment*, International Journal of Approximate Reasoning, 43(3):268–285, 2006.
- [Lacroix 2006] F. Lacroix, *Préface*, in Dynamique des avalanches, Presses polytechniques universitaires romandes - Cemagref, Lausanne, Suisse - Antony, France, 2006.
- [Lin et al., 2004] G. F. Lin, L. H. Chen and J. N. Lai, *Reliability-based delineation of debris-flow deposition areas*, Natural Hazards, 32(3):395–412, 2004.
- [Linkov et al. 2006] I. Linkov et al., *From comparative risk assessment to multicriteria decision analysis and adaptive management: Recent developments and applications*, Environment International Environmental Risk Management - the State of the Art, 32(8):1072–1093, 2006.
- [Magne and Vasseur 2006] L. Magne, D. Vasseur, *Chapitre 9: le risque et sa gestion entre incertitude et ajustement de règles*, in Risques industriels. complexité, incertitude et décision: une approche interdisciplinaire, Collection EDF R&D, Lavoisier, Paris, 2006.

- [Martin and Quidu 2008] A. Martin, I. Quidu, *Decision support with belief functions theory for seabed characterization*, In Proc. of the 11th International Conference on Information Fusion, FUSION 2008, Cologne, Germany, July 2008.
- [Martin and Osswald 2006] A. Martin, C. Osswald, *A new generalization of the proportional conflict distribution rule stable in terms of decision*, in [Smarandache and Dezert 2006a], 2006.
- [Martin 2009] A. Martin, *Implementing general belief function framework with a practical codification for low complexity*, in Advances and Applications of DSmT for Information Fusion, Volume 3, 2009.
- [M.A.T.E. and M.E.T.L. 1997] M.A.T.E. and M.E.T.L., *Plans de prévention des risques naturels prévisibles (ppr) - guide général*, Technical report, Ministère de l'Aménagement du Territoire et de l'Environnement - Ministère de l'Équipement, des Transports et du Logement, 1997.
- [Matos 2007] M. A. Matos, *Decision under risk as a multicriteria problem*, European Journal of Operational Research, 181(3):1516–1529, 2007.
- [Merad et al. 2004] M. M. Merad, T. Verdel, B. Roy and S. Kouniali, *Use of multicriteria decision-aids for risk zoning and management of large area subjected to mining-induced hazards*, Tunnelling and Underground Space Technology, 19(2):125–138, 2004.
- [Mortureux 2001] Y. Mortureux, *La sûreté de fonctionnement: méthodes pour maîtriser les risques*, Ref. AG 4 670 - 17 p., 2001.
- [Mustajoki et al. 2005] J. Mustajoki, R. Haimailainen and A. Salo, *Decision support by interval smart/swing - incorporating imprecision in the smart and swing methods*, Decision Sciences, 36(2):317–339, 2005.
- [Omrani et al. 2007] H. Omrani, L. Ion-Boussier and P. Trigano, *A new approach for impacts assessment of urban mobility*, WSEAS Transactions on Information Science and Applications, 4(3):439–444, 2007.
- [Ozdemir and Saaty 2006] M. S. Ozdemir, T. L. Saaty, *The unknown in decision making: What to do about it*, European Journal of Operational Research, 174(1), pp. 349–359, 2006.
- [Pan 2008] N. F. Pan, *Fuzzy AHP approach for selecting the suitable bridge construction method*, Automation in Construction, 17(8), pp. 958–965, 2008.
- [Parsons 2001] S. Parsons, *Qualitative approaches for reasoning under uncertainty*, Massachusetts Institute of Technology Press, Cambridge, MA, U.S.A., 2001.
- [Pigeon, 2005] P. Pigeon, *Geographie critique des risques*, Economica, Paris, 2005.

- [Rapin 2007] F. Rapin, *Outils de classification des sites à risques d'avalanche - manuel pour le renseignement - ref: Manuel - v 3.1 - 4 avril 2007*, Technical report, Cemagref - Unité ETNA (Erosion Torrentielle Neige Avalanches), Grenoble, 2007.
- [Roy 1968] B. Roy, *Classement et choix en présence de points de vue multiples (la méthode electre)*, Revue Frand'Informatique et de Recherche Opérationnelle, Vol. 8, pp. 57–75, 1968.
- [Roy 1985] B. Roy, *Méthodologie Multicritère d'Aide à la Décision*, Collection Gestion - Série Production et techniques quantitatives appliquées à la gestion, Economica, Paris, 1985.
- [Roy 1989] B. Roy, *Main sources of inaccurate determination, uncertainty and imprecision in decision models*, Mathematical and Computer Modelling, 12(10-11):1245–1254, 1989.
- [Roy 1990] B. Roy, *Decision-aid and decision-making*, European Journal of Operational Research, 45(2-3):324–331, 1990.
- [Rumbaugh et al. 1999] J. Rumbaugh, G. Booch and I. Jacobson, *The Unified Modelling Language Reference Manual*, Addison-Wesley, Pearson Education, Inc., 1999.
- [Saaty 1980] T. L. Saaty, *The analytic hierarchy process*, McGraw-Hill, New York, 1980.
- [Saaty 1982] T. L. Saaty, *Decision-Making for leaders: the analytical hierarchy process for decisions in a complex word*, Life-time learning publications, Belmont, CA, 94002 U.S.A., 1982.
- [Saaty 1990] T. L. Saaty, *How to make a decision: The analytic hierarchy process*, European Journal of Operational Research, 48(1):9–26, 1990.
- [Saaty and Tran 2007] T. L. Saaty, L. T Tran, *On the invalidity of fuzzifying numerical judgments in the analytic hierarchy process*, Mathematical and Computer Modelling, 46(7-8):962–975, 2007.
- [Saaty and Vargas 1987] T. L. Saaty, L. G.Vargas, *Uncertainty and rank order in the analytic hierarchic process*, European Journal of Operational Research, 32(1):107–117, 1987.
- [Salo and Haimailainen 2001] A. A Salo, R. P. Haimailainen, *Preference ratios in multiattribute evaluation (prime)-elicitation and decision procedures under incomplete information*, IEEE Transactions on Systems, Man, and Cybernetics Part A: Systems and Humans, 31(6), pp. 533–545, 2001.

- [Salo and Hamalainen 1995] A. A. Salo, R. P. Haimailainen, *Preference programming through approximate ratio comparisons*, European Journal of Operational Research, 82(3):458–475, 1995.
- [Salo 1996] A. A. Salo, *On fuzzy ratio comparisons in hierarchical decision models*, Fuzzy Sets and Systems, 84(1):21–32, 1996.
- [Scharlig 1985] A. Scharlig, *Décider sur plusieurs critères - Panorama de l'aide à la décision multicritère*, Diriger l'entreprise, Presses polytechniques et universitaires romandes, Lausanne, 3 ème edition, 1985.
- [Sentz and Ferson 2002] K. Sentz, S. Ferson, *Combination of evidence in Dempster-Shafer theory*, SAND TR 2002-0835, Technical report, Sandia National Laboratories, U.S.A., 2002.
- [Shafer 1976] G. Shafer, *A mathematical theory of Evidence*, Princeton University Press, 1976.
- [Smarandache and Dezert 2004] F. Smarandache, J. Dezert, (Editors), *Advances and Applications of DS_mT for Information Fusion (Collected Works)*, Vol. 1, American Research Press, Rehoboth, U.S.A., 2004.
- [Smarandache and Dezert 2006a] F. Smarandache, J. Dezert, (Editors), *Advances and Applications of DS_mT for Information Fusion (Collected Works)*, Vol. 2, American Research Press, Rehoboth, U.S.A., 2006.
- [Smarandache and Dezert 2006b] F. Smarandache, J. Dezert, *Proportional Conflict Redistribution Rules for Information Fusion*, in [Smarandache and Dezert 2006a], 2006.
- [Soundappan et al. 2004] P. Soundappan et al., *Comparison of evidence theory and Bayesian theory for uncertainty modeling - alternative representations of epistemic uncertainty*, Reliability Engineering & System Safety, 85 (1-3), pp. 295–311, 2004.
- [Stewart 2005] T. J. Stewart, *Dealing with uncertainties in MCDA - chapter 11*, Vol. 78 of International Series in Operations Research and Management Science, Springer, 2005.
- [Tacnet et al. 2005a] J.-M. Tacnet, D. Laigle, F. Berger, L. Dorren and J. Nedelec, *Expertise des risques naturels gravitaires en montagne et estimation du risque résiduel: un exemple de contribution et des limites actuelles des systèmes d'information*, In Colloque SIRNAT (Systèmes d'information et risques naturels), Montpellier, France, March 10-11, 2005.
- [Tacnet et al. 2005] J.-M. Tacnet, R. Burnet, P. Ravel, P. Maurel and J. Lievois, *Information systems and avalanche risk prevention plans (p.p.r.): contribution*

to improvement of data and reasoning processes traceability, Technical report (in French), Cemagref - ONF/RTM - Ministry for Ecology and Sustainable development (MEDD) / Directorate for risks and pollution prevention (DPPR), 2005.

- [Tacnet et al. 2006] J.-M. Tacnet, S. Escande, F. Rapin, R. Burnet, M. and Batton-Hubert, *Methodology of snow avalanche post-event field investigations: tools, difficulties and perspectives*, In International Snow Science Workshop Proceedings (ISSW) 2006, pp. 530–539, Telluride, CO, U.S.A., Sept. 30 – Oct. 6, 2006.
- [Tacnet and Richard 2008] J.-M. Tacnet, D. Richard, *Irasmus european project - wp5 - risk management framework in France*, Technical report, Cemagref, 2008.
- [Vaidya and Kumar 2006] O. S. Vaidya, S. Kumar, *Analytic hierarchy process: An overview of applications*, European Journal of Operational Research, 169(1):1–29, 2006.
- [Van Der Most and Wehrung 2005] H. VanNder Most, M. Wehrung, *Dealing with uncertainty in flood risk assessment of dike rings in the Netherlands*, Natural Hazards, 36(1-2):191–206, 2005.
- [Veyret 2004] Y. Veyret, *Géographie des risques naturels en France - De l'aléa à la gestion*, HATIER, Paris, 2004.
- [Von Neumann and Morgenstern 1967] J. Von Neumann, O. Morgenstern, *Theory of games and economic behavior*, Princeton University Press, Third Edition, 1967.
- [Vrijling et al. 1998] J. K. Vrijling, W. Van Hengel and R. J. Houben, *Acceptable risk as a basis for design*, Reliability Engineering & System Safety, 59(1):141–150, 1998.
- [Wadsworth and Hall 2007] R. Wadsworth, J. Hall, *Setting site specific critical loads: An approach using endorsement theory and Dempster-Shafer*, Water, Air, and Soil Pollution: Focus, 7(1-3):399–405, 2007.
- [Wang et al. 1996] J. Wang, J. B. Yang and P. Sen, *Multi-person and multi-attribute design evaluations using evidential reasoning based on subjective safety and cost analyzes*, Reliability Engineering and System Safety, 52(2):113–128, 1996.
- [Wang and Elhag 2006] Y.-M. Wang, T. M. S. Elhag, *An approach to avoiding rank reversal in AHP*, Decision Support Systems, 42(3):1474–1480, 2006.
- [Wang et al. 2006] Y.-M. Wang, J. B. Yang and D. L. Xu, *Environmental impact assessment using the evidential reasoning approach*, European Journal of Operational Research, 174(3):1885–1913, 2006.

- [Weichselgartner and Bertens 2000] J. Weichselgartner, J. Bertens, *Natural disasters: Acts of god, nature or society? on the social relation to natural hazards*, In Congrès Risk analysis II - International conference on computer simulation in risk analysis and hazard mitigation No; 2, pp. 3–12, Bologna, Italy, October, 2000.
- [Wong and Lingras 1994] S. Wong, P. Lingras, *Representation of qualitative user preference by quantitative belief functions*, IEEE Transactions on Knowledge and Data Engineering, 6(1):72–78, 1994.
- [Yang 2001] J. B. Yang, *Rule and utility based evidential reasoning approach for multiattribute decision analysis under uncertainties*, European Journal of Operational Research, 131(1):31–61, 2001.
- [Yang et al. 2006] J. B. Yang, Y. M. Wang, D. L. Xu and K. S. Chin, *The evidential reasoning approach for mada under both probabilistic and fuzzy uncertainties*, European Journal of Operational Research, 171(1):309–343, 2006.
- [Yang and Xu 2002] J. B. Yang, D. L. Xu, *On the evidential reasoning algorithm for multiple attribute decision analysis under uncertainty*, IEEE Transactions on Systems, Man, and Cybernetics Part A: Systems and Humans, 32(3):289–304, 2002.
- [Zadeh 1965] L. A. Zadeh, *Fuzzy sets*, Information and Control, 8:338–353, 1965.
- [Zadeh 1978] L. A. Zadeh, *Fuzzy sets as a basis for a theory of possibility*, Fuzzy Sets and Systems, 1:3–28, 1978.

Chapter 24

Improvement of multiple ground targets tracking with fusion of identification attributes

Benjamin Pannetier, Jean Dezert
The French Aerospace Lab.,
ONERA/DTIM/SIF,
29 Avenue de la Division Leclerc,
92320 Châtillon, France.
benjamin.pannetier@onera.fr, jean.dezert@onera.fr

Abstract: *Multiple ground targets (MGT) tracking is a challenging problem in real environment. Advanced algorithms include exogenous information like road network and terrain topography. In this chapter, we develop a new improved VS-IMM (Variable Structure Interacting Multiple Model) algorithm for GMTI (Ground Moving Target Indicator) and IMINT (IMagery INTelligence) tracking which includes the stop-move target maneuvering model, contextual information (on-off road model, road network constraints), and ID (Identification) information arising from classifiers coupled with the GMTI sensor. The identification information is integrated to the likelihood of each hypothesis of our SB-MHT (Structured Branching - Multiple Hypotheses Tracking). We maintain aside each target track a set of ID hypotheses with their committed beliefs which are updated on real time with classifier decisions through target type tracker based on a proportional conflict redistribution fusion rule developed in DSmT. The advantage of such a new approach is to deal precisely and efficiently with the identification attribute information available as it comes by taking into account its inherent uncertainty/non-specificity and possible high auto-conflict.*

24.1 Introduction

Data fusion for ground battlefield surveillance is more and more strategic in order to create the situational assessment or improve the precision of fire control system. The challenge of data fusion for the theatre surveillance operation is to know where are the targets, how they evolve (maneuvers, group formations,...) and what are their identities. For the first two questions, we develop new ground target tracking algorithms adapted to GMTI (Ground Moving Target Indicator) sensors. In fact, GMTI sensors are able to cover a large surveillance area during few hours or more if several sensors exist. However, ground target tracking algorithms are used in a complex environment due to the high traffic density and the false alarms that generate a significant data quantity, the terrain topography which can provoke non-detection areas for the sensor and the high maneuverability of the ground targets which yields to the data association problem. Several references exist for the MGT (Multiple Ground Targets) tracking with GMTI sensors [6, 9] which fuse contextual informations with MTI reports. The main results are the improvement of the track precision and track continuity. Our algorithm [13] is built with several reflexions inspired with this literature. Based on road segment positions, dynamic motion models under road constraint are built and an optimized projection of the estimated target states is proposed to keep the track on the road. A VS-IMM (Variable Structure Interacting Multiple Models) filter is created with a set of constrained models to deal with the target maneuvers on the road. The set of models used in the variable structure is adjusted sequentially according to target positions and to the road network topology.

Now, we extended the MGT with several sensors. In this chapter, we first consider the centralized fusion between GMTI and IMINT (IMagery INTelligence) sensors reports. The first problem of the data fusion with several sensors is the data registration in order to work in the same geographic and time referentials. This point is not presented in this chapter. However, in a multisensor system, measurements can arrive out of sequence. Following Bar-Shalom and Chen's works [3], the VS-IMMC (VS-IMM Constrained) algorithm is adapted to the OOSM (Out Of Sequence Measurement) problem, in order to avoid the reprocessing of entire sequence of measurements. The VS-IMMC is also extended in a multiple target context and integrated in a SB-MHT (Structured Branching - Multiple Hypotheses Tracking). Despite of the resulting track continuity improvement for the VS-IMMC SB-MHT algorithm, unavoidable association ambiguities arise in a multi-target context when several targets move in close formation (crossing and passing). The associations between all constrained predicted states are compromised if we use only the observed locations as measurements. The weakness of this algorithm is due to the lack of good target state discrimination.

One way to enhance data associations is to use the reports classification attribute. In our previous work [14], the classification information of the MTI segments has been introduced in the target tracking process. The idea was to maintain aside each target track a set of ID hypotheses. Their committed beliefs are revised in real time with the

classifier decision through a very recent and efficient fusion rule called proportional conflict redistribution (PCR). In this chapter, in addition to the measurement location fusion, a study is carried out to fuse MTI classification type with image classification type associated to each report. The attribute type of the image sensors belongs to a different and better classification than the MTI sensors. The counterpart is the short coverage of image sensors that brings about a low data quantity. In section 24.2, the motion and measurement models are presented with a new ontologic model in order to place the different classification frames in the same frame of discernment. After the VS-IMMC description given in section 24.4, the PCR fusion rule originally developed in DSmT (Dezert-Smarandache Theory) framework is presented in section 24.5 to fuse the target type information available and to include the resulting fused target ID into the tracking process. The last part of this chapter is devoted to simulation results for a multiple target tracking scenario within a real environment.

24.2 Motion model

24.2.1 Introduction

Usual target tracking algorithms are based on the Kalman filter. Since several years, in ground target tracking domain, the Kalman filter has been improved to take into account the contextual information in the tracking process. For instance, Kirubarajan *et al.* proposed to use the road segment location in order to modelize the dynamic of a target moving on the road [9]. The road network is considered here as *a priori* information to be integrated in the tracking system. The map information comes from a GIS (Geographic Information System) which contains information about the road network location and the DTED (Digital Terrain Elevation Data). In the following, the GIS description, the stochastic target constrained and the measurement models are presented.

24.2.2 GIS description

The GIS used in this work contains the following information: the segmented road network and DTED. Each road segment is expressed in the WGS84 system. The road network is connected and each road segment is indexed by the road section it belongs to. A road section $Ro(p)$ is defined by a connected road segments set delimited by a road end or a junction in the manner that $Ro(p) = \{s_0, s_1, \dots\}$.

At the beginning of a surveillance battlefield operation, a Topographic Coordinate Frame (TCF) and its origin O are chosen in the manner that the axes X , Y and Z are respectively oriented in the East, North and Up local directions. The target tracking process is carried out in the TCF.

24.2.3 Target state under constraint

24.2.3.1 Constrained motion model

The target state at the current time k is defined in the local coordinate frame by¹:

$$\mathbf{x}(k) = [x(k) \dot{x}(k) y(k) \dot{y}(k)]' \quad (24.1)$$

where the couples $(x(k), y(k))$ and $(\dot{x}(k), \dot{y}(k))$ define respectively the target location and velocity. The dynamics of the targets evolving on the road network are modeled by a first-order system.

The target state under the road segment s is defined by

$$\mathbf{x}_s(k) = [x_s(k) \dot{x}_s(k) y_s(k) \dot{y}_s(k)]' \quad (24.2)$$

where the target position $(x_s(k), y_s(k))$ belongs to the road segment and the corresponding velocity vector $(\dot{x}_s(k), \dot{y}_s(k))$ is in the road segment s direction. Therefore, the target constraint state $\mathbf{x}_s(k)$ is defined by the following constraint:

$$\begin{cases} a \cdot x_s(k) + b \cdot y_s(k) + c = 0 \\ \langle [\dot{x}(k) \dot{y}(k)]' | \vec{n}_s \rangle = 0 \end{cases} \quad (24.3)$$

where a , b and c are the coefficients of the line associated to the road segment s and \vec{n}_s is the normal vector to the road segment s . The constraint can be expressed as follows:

$$\tilde{\mathbf{D}} \cdot \mathbf{x}_s(k) = \mathbf{L} \quad (24.4)$$

with $\tilde{\mathbf{D}} = \begin{bmatrix} a & 0 & b & 0 \\ 0 & a & 0 & b \end{bmatrix}$ and $\mathbf{L} = [-c \ 0]'$.

The event that the target is on the road segment s is noted $e_s(k) = \{(x(k), y(k)) \in s\}$. Knowing the event $e_s(k)$ and according to a motion model M_i the dynamics of the target can be improved by considering the road segment s . Due to the precision of the GMTI sensor and the long time scan period, the chosen motion models are quite simple. They consist in r constant velocity motion models having different process noise statistics (standard deviations). However the proposed approach is valid for much more complicated motion models like the constant acceleration or coordinated turn ones. It follows that:

$$\mathbf{x}_s(k) = \mathbf{F}_{s,i}(\Delta_k) \cdot \mathbf{x}_s(k-1) + \mathbf{\Gamma}(\Delta_k) \cdot \boldsymbol{\nu}_{s,i}(k) \quad (24.5)$$

where Δ_k is the time of sampling; the matrix $\mathbf{F}_{s,i}(k) \triangleq \mathbf{F}_{s,i}(\Delta_k)$ is the state transition matrix associated to the road segment s (described in [12]) and is adapted to a motion model M_i ; The matrix $\mathbf{\Gamma}(\Delta_k)$ is defined in [1] and the variable $\boldsymbol{\nu}_{s,i}(k)$ is a white noise Gaussian process. Its associated covariance $\mathbf{Q}_{s,i}(k)$ is built in the manner that the

¹ \mathbf{x}' denotes the transposition of the vector (or the matrix) \mathbf{x} .

standard deviation σ_n along the road segment is higher than the standard deviation σ_d in the orthogonal direction. Consequently the covariance matrix $\mathbf{Q}_{s,i}$ is defined by:

$$\mathbf{Q}_{s,i}(k) = \mathbf{R}_{\vartheta_s} \cdot \begin{bmatrix} \sigma_d^2 & 0 \\ 0 & \sigma_n^2 \end{bmatrix} \cdot \mathbf{R}'_{\vartheta_s} \quad (24.6)$$

where the matrix \mathbf{R}_{ϑ_s} is the rotation matrix associate to the s road segment direction ϑ_s defined in the plane (O, X, Y) . The predicted target state and covariance are defined respectively by:

$$\hat{\mathbf{x}}_{s,i}(k|k-1) = \mathbf{F}_{s,i}(k) \cdot \hat{\mathbf{x}}_{s,i}(k-1|k-1) \quad (24.7)$$

$$\mathbf{P}_{s,i}(k|k-1) = \mathbf{F}_{s,i}(k) \cdot \mathbf{P}_{s,i}(k-1|k-1) \cdot \mathbf{F}'_{s,i}(k) + \mathbf{Q}_{s,i}(k) \quad (24.8)$$

24.2.3.2 Adjustment of the process noise at the road extremities

Since the previous constraint on the motion model is specific only to a given segment s , it does not take into account the whole road network² and thus it omits the possibility for the target to switch onto another road segment when reaching the extremity of the segment it is moving on. Such modeling is too simplistic and the ground-target tracking based on it provides in general poor performances. To improve modeling for targets moving on a road network, we propose to adapt the level of the dynamic model's noise depending on the length of the road segment s and on the location of the target on this segment with respect to its extremities. This allows to relax gradually the on-segment constraint as soon as the target approaches the extremity of the road segment and/or a junction. If we omit the road segment length in the motion model, the tracking algorithm may not associate the predicted track with a measurement when the predicted state is near the road segment extremity. In fact, if a measurement is originated from a target moving on the road segment $s+1$, the measurement won't be in the validation gate (defined in [5]), because of the road segment s constraint that generates a directive predicted covariance with a small standard deviation in the road segment s orthogonal direction. That is why, we propose to increase the standard deviation σ_d when the target approaches the road extremity, in the manner that the standard deviation in the orthogonal road segment direction becomes equal to the standard deviation in the road segment direction. For this, we use the *prior* probability $P\{e_s(k)|\mathbf{Z}^{k-1,n}\}$ in order to relax the constraint when the target approaches the road segment s extremity. The white noise Gaussian process $\nu_{s,i}(k)$ in (24.5) is modified in the manner that the covariance $\mathbf{Q}_{s,i}$ is replaced by $\tilde{\mathbf{Q}}_{s,i}$:

$$\tilde{\mathbf{Q}}_{s,i}(k) = \mathbf{R}_{\vartheta_s} \cdot \begin{bmatrix} \sigma_d^2 & 0 \\ 0 & q_{22} \end{bmatrix} \cdot \mathbf{R}'_{\vartheta_s} \quad (24.9)$$

²*i.e.* the possibility of several other road segments connected at extremity of each road segment of the network.

where $q_{22} = \sigma_n^2 \cdot P\{e_s(k)|\mathbf{Z}^{k-1}\} + \sigma_d^2 \cdot (1 - P\{e_s(k)|\mathbf{Z}^{k-1}\})$ and \mathbf{Z}^{k-1} is the sequence of measurements up to time $k - 1$.

The probability that the target belongs to the road segment s is based on the derivations proposed by Ulmke and Koch [19] and Herrero *et al.* [8], but we do not consider the road width and our modelization is done in the 2D space only. So the predicted road segment s belonging probability is expressed as:

$$P\{e_s(k)|\mathbf{Z}^{k-1,n}\} = \begin{cases} 0, & \text{if } \Pi_s(\mathbf{x}(k)) \leq 0 \text{ or } \Pi_s(\mathbf{x}(k)) \geq l_s, \\ P\{\Pi_s(\mathbf{x}(k)) \leq l_s | \mathbf{Z}^{k-1,n}\}, & \text{otherwise.} \end{cases} \quad (24.10)$$

where $\Pi_s(x(k))$ is the projection operator on the road segment s modulo the road segment length l_s . According to the Gaussian assumption, the probability can be rewritten as follows:

$$\begin{aligned} P\{e_s(k)|\mathbf{Z}^{k-1,n}\} &= \int_0^{l_s} \mathcal{N}(u, \Pi_s(\mathbf{x}(k)), \sigma_s^2) du \\ &= f\left(\frac{l_s - \Pi_s(\mathbf{x}(k))}{\sigma_s}\right) - f\left(\frac{-\Pi_s(\mathbf{x}(k))}{\sigma_s}\right) \end{aligned} \quad (24.11)$$

The variance σ_s^2 is the variance obtained after the projection Π_s on the road segment s and is given in [19]. The function $f(\cdot)$ is the integral of the Gaussian distribution with zero mean and variance of $1/2$:

$$f(t) = \frac{1}{\sqrt{2\pi}} \cdot \int_{-\infty}^t e^{-\frac{t^2}{2}} dt \quad (24.12)$$

Finally, we obtain a constrained motion model which takes into account the uncertainty that the target belongs to the road segment. This uncertainty is modeled by an additive noise process.

24.2.3.3 Constrained state estimation

We define $M_s^i(k) = \{M^i(k) \cap e_s(k)\}$ the event that the target is following a dynamic according to the motion model M^i and moves on the road segment s . So, the state probability density function (*i.e.* pdf) given the measurements set \mathbf{Z}^k and the event $M_s^i(k)$ is denoted :

$$p(\mathbf{x}(k)|\mathbf{Z}^k, \theta^{k,l}, M_s^i(k)) \quad (24.13)$$

The state $\mathbf{x}_i(k)$ is a Gaussian random vector defined by its estimated mean $\hat{\mathbf{x}}_i(k|k)$ and its estimated covariance $\mathbf{P}_i(k|k)$ (both obtained using a model based filter). Under the road constraint, the estimated state $\hat{\mathbf{x}}_{s,i}(k|k)$ is therefore obtained by the maximization of pdf (24.3) given the event M_s^i . Finally, under the Gaussian assumption of the Kalman filter, the analytic expression of the constrained estimate state associate with the motion model M^i is obtained by calculating the Lagrangian

of (24.3) under the constraint (24.4). The expressions of the constrained estimated state and its covariance are given in [13]:

$$\hat{\mathbf{x}}_{i,s}(k|k) = \hat{\mathbf{x}}_i(k|k) - \mathbf{P}_i(k|k) \cdot \tilde{\mathbf{D}} \cdot (\tilde{\mathbf{D}}\mathbf{P}_i(k|k)\tilde{\mathbf{D}}')^{-1} \cdot (\tilde{\mathbf{D}}\hat{\mathbf{x}}_i(k|k) - \mathbf{L}) \quad (24.14)$$

$$\mathbf{P}_{i,s}(k|k) = (\mathbf{Id} - \mathbf{W}(k)) \cdot \mathbf{P}_i(k|k) \cdot (\mathbf{Id} - \mathbf{W}(k))' \quad (24.15)$$

where the matrix \mathbf{Id} is the identity matrix and $\mathbf{W}(k)$ is defined by:

$$\mathbf{W}(k) = \mathbf{P}_i(k|k) \cdot \tilde{\mathbf{D}}' \cdot (\tilde{\mathbf{D}} \cdot \mathbf{P}_i(k|k) \cdot \tilde{\mathbf{D}}') \cdot \tilde{\mathbf{D}} \quad (24.16)$$

Since the road network is composed of several road segments and a ground target has several motion models, we consider an IMM (Interacting Multiple Model) with a variable structure [1] to adapt the constraint motion models set to the road network configuration. This VS-IMMC is presented in the section 24.4.

24.3 Measurement model

24.3.1 GMTI model

24.3.1.1 MTI report model

According to the NATO GMTI formats, the MTI reports are expressed in WGS84 coordinates system [11]. All MTI reports are converted for each tracking station into the TCF. A (noise-free) MTI measurement vector $\mathbf{z}_{mti}(k)$ at the current time k is given in the TCF by:

$$\mathbf{z}_{mti}(k) = [x(k) \ y(k) \ \dot{\rho}(k)]' \quad (24.17)$$

where $(x(k), y(k))$ are the x and y MTI coordinates in the local frame $(0, X, Y)$ and $\dot{\rho}_m$ is the associated range-rate expressed in the TCF as:

$$\dot{\rho}(k) = \frac{(x(k) - x_c(k)) \cdot \dot{x}(k) + (y(k) - y_c(k)) \cdot \dot{y}(k)}{\sqrt{(x(k) - x_c(k))^2 + (y(k) - y_c(k))^2}} \quad (24.18)$$

where $(x_c(k), y_c(k))$ is the sensor location at the current time in the TCF. The range radial velocity is correlated to the MTI location components, so the use of an extended Kalman filter (EKF) is not adapted. In literature, there exist several techniques to uncorrelate the range-rate from the location components like for example, the SEKF from Wang *et al.* [21] based on Cholesky's decomposition. Nevertheless, we prefer to use the AEKF (Alternative Extended Kalman Filter) presented by Bizup and Brown [4]. This last one is very simple to compute because the authors propose only to use an alternative linearization of the EKF (Extended Kalman Filter). Moreover, AEKF working in the sensor referential/frame remains invariant by translation. Then, the measurement equation is given according to the AEKF, by:

$$\mathbf{z}_{mti}(k) = \mathbf{H}_{mti}(k) \cdot \mathbf{x}(k) + \boldsymbol{\nu}_{mti}(k) \quad (24.19)$$

where $\mathbf{v}_{mti}(k)$ is a zero-mean white Gaussian noise vector and $\mathbf{H}(k)$ is given by:

$$\mathbf{H}_{mti}(k) = \begin{bmatrix} 1 & 0 & 0 & 0 \\ 0 & 0 & 1 & 0 \\ 0 & \frac{\partial \hat{\rho}(k)}{\partial \hat{x}} & 0 & \frac{\partial \hat{\rho}(k)}{\partial \hat{y}} \end{bmatrix} \quad (24.20)$$

The explicit expression of (24.20) is given in [4].

24.3.1.2 MTI Classification segment

An issue to improve the multiple target tracking algorithm is to combine the kinematic data association with the attribute data association. In the STANAG 4607 [11], each MTI report is associated to the location and velocity information (described in the previous part) in addition to the attribute information with its probability that it is correct. We denote $C_{MTI} = \{c_0, c_1, \dots, c_u\}$, the frame of discernment of our target classification problem. C_{MTI} is assumed to be constant over time (*i.e.* target ID does not change with time) and consists of a finite set of u exhaustive and exclusive elements representing the possible states of the world for target classification. In the STANAG 4607 the set C_{MTI} is defined by :

$$C_{MTI} = \left\{ \begin{array}{l} \textit{No Information}, \\ \textit{Tracked Vehicle}, \\ \textit{Wheeled Vehicle}, \\ \textit{Rotary Wing Aircraft}, \\ \textit{Fixed Wing Aircraft}, \\ \textit{Stationary Rotator}, \\ \textit{Maritime}, \\ \textit{Beacon}, \\ \textit{Amphibious} \end{array} \right\} \quad (24.21)$$

In addition to the classification or attribute information, the STANAG allows to use the probability $P\{c(k)\}$, ($\forall c(k) \in C_{MTI}$), but it does not specify the way these probabilities are obtained because $P\{c(k)\}$ are actually totally dependent on the algorithm chosen for target classification. In this chapter, we do not focus on the classification algorithm itself, but rather on how to improve multiple ground targets tracking with attribute information and target classification. Hence, we consider the probabilities $P\{c(k)\}$ as input parameters of our tracking system characterizing the global performances of the classifier. In other words, $P\{c(k)\}$, ($\forall c(k) \in C_{MTI}$), represent the diagonal terms of the confusion matrix C_{MTI} of the classification algorithm assumed to be used. The modified/extended measurement $\mathbf{z}_{mti}^*(k)$ including both kinematic part and (classification) attribute part is defined as:

$$\mathbf{z}_{mti}^*(k) = \{z_{mti}(k), c(k), P\{c(k)\}\} \quad (24.22)$$

24.3.2 IMINT model

For the imagery intelligence (IMINT), we consider two sensor types : a video EO/IR sensor carried by a Unmanned Aerial Vehicle (UAV) and a EO sensor fixed on a Unattended Ground Sensor (UGS).

24.3.2.1 EO/IR report model

We assume that the video information given by both sensor types are processed by their own ground stations and that the system provides the video reports of target detections with their classification attributes. Moreover, a human operator selects targets on a movie frame and is able to choose its attribute with a HMI (Human Machine Interface). In addition, the operator is able with the UAV to select *several targets* on a frame. On the contrary, the operator selects *only one target* with the frames given by the UGS. There is *no false alarm* and a target cannot be detected by the operator (due to terrain mask for example). The video report on the movie frame is converted in the TCF. The measurement equation is given by:

$$\mathbf{z}_{video}(k) = \mathbf{H}_{video}(k) \cdot \mathbf{x}(k) + \mathbf{w}_{video}(k) \quad (24.23)$$

where \mathbf{H}_{video} is the observation matrix of the video sensor

$$\mathbf{H}_{video} = \begin{bmatrix} 1 & 0 & 0 & 0 \\ 0 & 0 & 1 & 0 \end{bmatrix} \quad (24.24)$$

The white noise Gaussian process $\mathbf{w}_{video}(k)$ is centered and has a known covariance $\mathbf{R}_{video}(k)$ given by the ground station.

24.3.2.2 EO/IR classification segment

Each video report is associated to the attribute information $c(k)$ with its probability $P\{c(k)\}$ that it is correct. We denote C_{video} the frame of discernment for an EO/IR source. As C_{MTI} , C_{video} is assumed to be constant over the time and consists of a finite set of exhaustive and exclusive elements representing the possible states of the target classification. In this chapter, we consider only eight elements in C_{video} as follows:

$$C_{video} = \left\{ \begin{array}{l} \textit{Civilian Car}, \\ \textit{Military Armoured Car}, \\ \textit{Wheeled Armoured Vehicle}, \\ \textit{Civilian Bus}, \\ \textit{Military Bus}, \\ \textit{Civilian Truck}, \\ \textit{Military Armoured Truck}, \\ \textit{Helicopter} \end{array} \right\} \quad (24.25)$$

Let $\mathbf{z}_{video}^*(k)$ be the extended video measurements including both kinematic part and attribute part expressed by the following formula among $m(k)$ measurements

$(\forall c(k) \in C_{video})$:

$$\mathbf{z}_{video}^*(k) \triangleq \{\mathbf{z}_{video}(k), c(k), P\{c(k)\}\} \quad (24.26)$$

24.3.3 Ontologic model

In our work, the symbology APP-6A [18] is used to describe the links between the different classification sets (24.21) and (24.25). The figure 24.1 represents a short part of the APP-6 A used in this chapter. Each element of both sets can be placed in 24.1. For example, the wheeled vehicle of the set C_{MTI} is placed at the level 1.X.3.1.1.2.2 and the military armoured truck of the set $video$ is placed at the level 1.X.3.1.1.2.1. Finally, all attribute elements are committed to a level in the APP-6A.

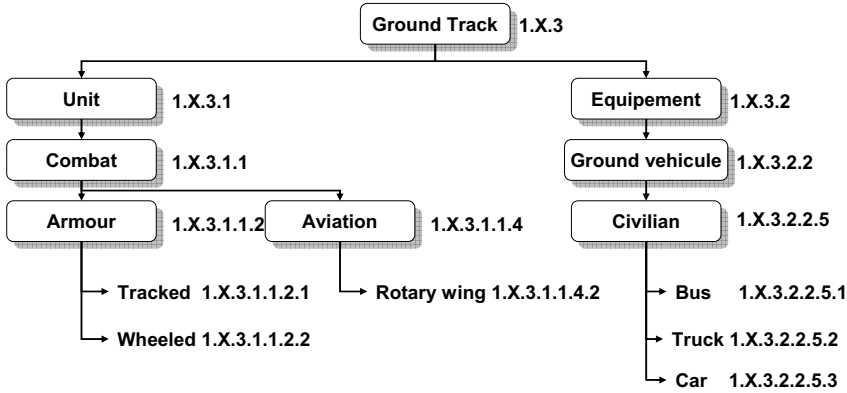

Figure 24.1: APP-6A (light version).

24.4 VS-IMM with road constraints (VS-IMMC)

24.4.1 Track definitions and notations

Let's denote $\mathcal{T}(k)$ the set of all tracks present at the current time. In the following of the article, the event $\theta^{k,l}$ is associated to the l^{th} sequential measurements $\mathbf{Z}^{k,l}$ and represents the set of measurements generated by the target. In addition, it exists a subsequence n and a measurement j ($\forall j \in \{1, \dots, m_k\}$) in the manner that $\mathbf{Z}^{k,l} = \{\mathbf{z}^{k-1,n}, \dots, \mathbf{z}_j(k)\}$ is the measurements sequence associates to the track $\mathbf{T}^{k,l}$. We recall that a track is an estimated states sequence expressed by the following expression: $\forall l \in \{1, \dots, |\mathcal{T}(k)|\}, \exists! s \in \{1, \dots, |\mathcal{T}(k-1)|\}$, such that

$$\mathbf{T}^{k,l} = \{(\hat{\mathbf{x}}^l(k|k), \mathbf{P}^l(k|k)), \mathbf{T}^{k-1,s}\} \quad (24.27)$$

A track family $\tau_n(k)$ at the current time k represents a data collection of tracks $\mathbf{T}^{k,l}$ ($\exists l \in \{1, \dots, |\mathcal{T}(k)|\}$) generated by the same measurement $\mathbf{z}_j(k_0)$ at time t_{k_0} . A track family must be associated to only one target and represents the different association hypotheses. $\forall i \in \{1, \dots, m_k\}$, one has

$$\tau_n(k) = \{\mathbf{T}^{k,l}, \mathbf{Z}^{k,l} = \{\mathbf{z}_j(k_0), \dots, \mathbf{z}_i(k)\}\} \quad (24.28)$$

24.4.2 IMM with only one road segment constraint

The IMM is an algorithm for combining states hypotheses from multiple filter models to get a better state estimate when the target is maneuvering. IMM is near optimal with a reasonable complexity. In section 24.2.3, a constrained motion model i to segment s , noted $M_s^i(k)$, is defined. Here we extend the segment constraint to the different dynamic models (among a set of $r + 1$ motion models) that a target can follow. The model indexed by $r = 0$ is the stop model. The transition between the models is a Markovian process. It is evident that when the target moves from one segment to the next, the set of dynamic models changes. In a conventional IMM estimator [1], the likelihood function of a model i is given, for a track $\mathbf{T}^{k,l}$, associated with the j -th measurement, $j \in \{0, 1, \dots, m_k\}$ by:

$$\Lambda_i^l(k) = p\{\mathbf{z}_j(k) | M_s^i(k), \mathbf{Z}^{k-1,n}\}, \quad i = 0, 1, \dots, r \quad (24.29)$$

where $\mathbf{Z}^{k-1,n}$ is the subsequence of measurements associated with the track $\mathbf{T}^{k,l}$.

Using the IMM estimator with a stop motion model, we get the likelihood function of the moving target mode for $i = 1, \dots, r$ and for $j \in \{0, 1, \dots, m_k\}$ by:

$$\Lambda_i^l(k) = P_D \cdot p\{\mathbf{z}_j(k) | M_s^i(k), \mathbf{Z}^{k-1,n}\} \cdot (1 - \delta_{m_j,0}) + (1 - P_D) \cdot \delta_{m_j,0} \quad (24.30)$$

while the likelihood of the stopped target mode (*i.e.* $r = 0$) is:

$$\Lambda_0^l(k) = p\{\mathbf{z}_j(k) | M_0^i(k), \mathbf{Z}^{k-1,n}\} = \delta_{m_j,0} \quad (24.31)$$

where $\delta_{m_j,0}$ is the Kronecker function defined by $\delta_{m_j,0} = 1$ if $m_j = 0$ and $\delta_{m_j,0} = 0$ whenever $m_j \neq 0$.

The combined/global likelihood function $\Lambda(k)$ of a track including a stop-model is then given by:

$$\Lambda^l(k) = \sum_{i=0}^r \Lambda_i^l(k) \cdot \mu_i(k|k-1) \quad (24.32)$$

where $\mu_i(k|k-1)$ is the predicted model probabilities [2].

The steps of the IMM under road segment s constraint are the same as for the classical IMM :

1. Step 1. Under the assumption of several possible models for segment s as defined previously, the mixing probabilities are given for i and j in $\{0, 1, \dots, r\}$ by:

$$\mu_{i|j}(k-1|k-1) = \frac{p_{ij} \cdot \mu_i(k-1)}{\bar{c}_j} \quad (24.33)$$

where \bar{c}_j is a normalizing factor. The probability of model switch depends on the Markov chain according to the transition probability p_{ij} . It is important to note that the transition probability does not depend on the constraint s .

2. Step 2. The mixing probabilities above are used to weight the initial state estimates in order to present to the model filters the mixed estimates. The mixed estimate of the target state under the road segment s constraint is defined for $i = 0, 1, \dots, r$ by:

$$\hat{\mathbf{x}}_{i,s}^{0,l}(k-1|k-1) = \sum_{j=0}^r \hat{\mathbf{x}}_{j,s}^l(k-1|k-1) \cdot \mu_{i|j}(k-1|k-1) \quad (24.34)$$

The covariance corresponding to the estimation error is:

$$\begin{aligned} \mathbf{P}_{i,s}^{0,l}(k-1|k-1) = & \sum_{j=0}^r \mu_{i|j}(k-1|k-1) \cdot [\mathbf{P}_{j,s}^{0,l}(k-1|k-1) + \\ & (\hat{\mathbf{x}}_{j,s}(k-1|k-1) - \hat{\mathbf{x}}_{i,s}^{0,l}(k-1|k-1)) \cdot \\ & (\hat{\mathbf{x}}_{j,s}(k-1|k-1) - \hat{\mathbf{x}}_{i,s}^{0,l}(k-1|k-1))^T] \quad (24.35) \end{aligned}$$

Despite of the constraint on local estimated states, the mixed estimated states do not belong to the road section s . Nevertheless, the state transition (24.5) matrix projects the mixed estimate on the road section.

3. Step 3. The motion models are constrained to the associated road segment. Each constrained mixed estimate (24.34) is predicted and associated to one new segment or several (in crossroad case) new ones, therefore the dynamics are modified according to the new segments. The mixed estimates (24.34) and (24.35) are used as inputs to the filter matched to $M_{s_j}^i$, which uses the MTI report associated to the track $\mathbf{T}^{k,l}$ to yield $\hat{\mathbf{x}}_{i,s}^l(k|k)$, $\mathbf{P}_{i,s}^l(k|k)$ and the corresponding likelihood (24.32).

4. Step 4. The model probability update is done for $i = 0, 1, \dots, r$ as follows:

$$\mu_i(k) = \frac{1}{c} \cdot \Lambda_i^l(k) \cdot \bar{c}_i \quad (24.36)$$

where c is a normalization coefficient and \bar{c}_i is given in (24.33).

5. Step 5. The combined state estimate, called global state estimate, is the sum of each constrained local state estimate weighted by the model probability, i.e.

$$\hat{\mathbf{x}}^l(k|k) = \sum_{i=0}^r \mu_i(k) \hat{\mathbf{x}}_{i,s}^l(k|k) \quad (24.37)$$

Here, one has presented briefly the principle of the IMM algorithm constrained to only one road segment s . However, a road section is composed with several road segments. When the target is making a transition from one segment to another, the problem is to choose the segments with the corresponding motion models that can better fit the target dynamics. The choice of a segment implies the construction of the directional process noise. That is why the IMM motions model set varies with the road network configuration and VS-IMM offers a better solution for ground target tracking on road networks as explained in next sections.

24.4.3 Variation of the set of constrained motion models

In the previous subsection, we have proposed an IMM with a given/fixed motion model set. We have noted that the predicted state could give a local estimate on another road segment than the segment associated to the motion model (a road turn for example). The change to another road segment causes the generation of a new constrained motion models. In literature, several approaches are proposed to deal with the constrained motion models [9, 15]. In [13], we have proposed an approach to activate the most probable road segments sets. Based on the work of Li [1], we consider $r + 1$ oriented graphs which depend on the road network topology. For each graph i , $i = 0, 1, \dots, r$, each node is a constrained motion model M_s^i . The nodes are connected to each other according to the road network configuration. For instance, if we consider a road section composed by three road segments s_1, s_2, s_3 , the i^{th} associated graph is composed by three nodes ($M_{s_1}^i, M_{s_2}^i$ and $M_{s_3}^i$) where the nodes $M_{s_1}^i$ and $M_{s_3}^i$ are connected with the node $M_{s_2}^i$. In [13], the activation of the motion model at the current time depends on the local predicted states $\hat{\mathbf{x}}_{i,s}^l(k|k-1)$ location of the track $\mathbf{T}^{k,l}$. Consequently, we obtain a finite set of $r + 1$ motion models constrained to a road section Ro_p (we recall that a road section is a set of connected road segments).

However, an ambiguity arises when there are several road sections (*i.e.* when the target approaches a crossroad). In fact, the number of constrained motion models grows up with the number of road sections present in the crossroad/junction. If we consider the $r + 1$ graphs, the activation of the constrained motion model is done according to the predicted states location. Consequently the number of motion models increases with the number of road sections. We obtain several constrained motion model sets. Each set is composed of $r + 1$ models constrained to road segments which belong to the road section. In order to select the most probable motion model set (*i.e.* in order to know on which road section the target is moving on), a sequential

probability ratio test named RSS-SPRT is proposed in [13] in order to select the road section taken by the target.

We consider that a hypothesis corresponds to one road section involved in the crossroad. At the current time k , if there are N_k road sections RO_p at the intersection, we consider all N_k hypotheses. So for each hypothesis h , associated to a given road section, there is one IMM with an appropriate constrained motion models set. The IMM outputs are sequentially evaluated. However, one measurement iteration is not sufficient to choose the right hypothesis. The probability $\mu_h(k)$ of h is derived based on the likelihood function and the transition matrix between the road segments. The combined likelihood (24.32) of a constrained models set and for a hypothesis h , $h = 1, \dots, N_k$ is denoted Λ_h . Mathematically, $\mu_h(k)$ is defined according to the road section probability [13] for $h = 1, \dots, N_k$ by:

$$\mu_h(k) = \frac{1}{c} \cdot \Lambda_h(k) \cdot \sum_{\bar{h} \in \{1, \dots, N_{k-1}\}} \Omega_{\bar{h}, h}(k-1) \cdot \mu_{\bar{h}}(k-1) \quad (24.38)$$

The matrix component $\Omega_{\bar{h}, h}$ represents the probability transition between the roads associated respectively to the hypotheses h and \bar{h} . In fact, if the road is a highway and the road section is also a highway, the transition probability is high. On the contrary, if the road is a highway and the road section is a byway the transition probability is small. The probability $\mu_{\bar{h}}(k-1)$ is the probability of hypothesis \bar{h} at the time $k-1$ (*i.e.* the probability of the previous road section where the target was moving on). Wald's sequential probability ratio test [20] (SPRT) for choosing the adequate road segment and activate the correct constrained motion model set at current time k is the following:

- Accept hypothesis h if for all $h' \neq h$, $h' \in \{1, \dots, N_k\}$:

$$\frac{\mu_h(k)}{\mu_{h'}(k)} \geq B \quad (24.39)$$

- Reject hypothesis h if for all $h' \neq h$, $h' \in \{1, \dots, N_k\}$:

$$\frac{\mu_h(k)}{\mu_{h'}(k)} \leq A \quad (24.40)$$

- Go to the next cycle and wait for one more measurement and continue the test until one hypothesis is accepted by the SPRT. The thresholds A and B are given in [5, 20]. For a faster test see the MSP-SPRT [1] based on probabilities classification.

24.4.4 VS-IMMC within the SB-MHT

We briefly describe the main steps of the VS-IMMC SB-MHT. More details can be found in chapter 16 of [5].

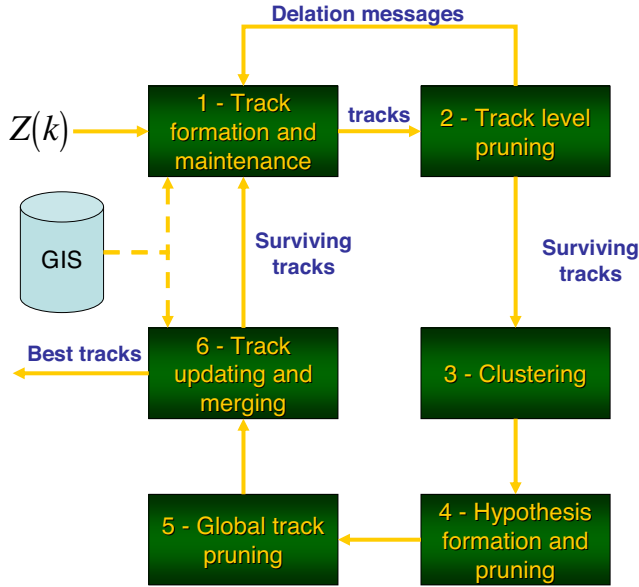

Figure 24.2: Track-oriented MHT logic flowchart with GIS.

1. The first functional block of the SB-MHT shown in figure 24.2 is the track confirmation and the track maintenance. When the new set $\mathbf{Z}(k)$ of measurements is received, a standard gating procedure [2] is applied in order to determine the viable MTI reports to track pairings. The existing tracks are updated with VS-IMMC and extrapolated confirmed tracks are formed. When the track is not updated with MTI reports, the stop motion model is activated.
2. In order to palliate the association problem, we need a probabilistic expression for the evaluation of the track formation hypotheses that includes all aspects of the data association problem. It is convenient to use the log-likelihood ratio (LLR) or track score of a track $\mathbf{T}^{k,l}$ which can be expressed at current time k in the following recursive form [5]:

$$L^l(k) = L^s(k-1) + \Delta L^l(k) \tag{24.41}$$

with

$$\Delta(k) = \ln\left(\frac{\Lambda^l(k)}{\lambda_{fa}}\right) \tag{24.42}$$

and

$$L(0) = \ln\left(\frac{\lambda_{fa}}{\lambda_{fa} + \lambda_{nt}}\right) \tag{24.43}$$

where λ_{fa} and λ_{nt} are respectively the false alarm rate and the new target rate per unit of surveillance volume. After the track score calculation of the track $\mathbf{T}^{k,l}$, the SPRT is used to set up the track status either as deleted, tentative or confirmed track. The tracks that fail the test are deleted and the surviving tracks are kept for the next stage.

3. The process of clustering is the collection of all tracks that are linked by a common measurement. The clustering technique is used to limit the number of hypotheses to generate and therefore to reduce the complexity. The result of clustering is a list of tracks that are interacting. The next step is to form hypotheses of compatible tracks.
4. For each cluster, in the fourth level, multiple coherent hypotheses are formed to represent the different compatible tracks scenarios. Each hypothesis is evaluated according to the track score function associated to the different tracks. Then, a technique is required in order to find the hypotheses set that represents the most likely tracks collection. The unlikely hypotheses and associated tracks are deleted by a pruning process and only the N_{Hypo} best hypotheses are conserved.
5. For each track, the *a posteriori* probability is computed and a well known *N-Scan* pruning approach [5] is used to select and delete the confirmed tracks. With this approach the most likely track is selected to reduce the number of tracks. But the *N-Scan* technique combined with the constraint implies that other tracks hypotheses (*i.e.* constrained on other road segments) are arbitrary deleted. That is why, we must modify the *N-Scan* pruning approach in order to select the N_k best tracks on each N_k road sections.
6. Wald's SPRT proposed in section 24.4.3 is used to delete the unlikely hypotheses among the N_k hypotheses. The tracks are then updated and projected on the road network. In order to reduce the number of track to keep in the memory of the computer, a merging technique (selection of the most probable tracks which have common measurements) is also implemented.

24.4.5 OOSM algorithm

The data fusion that operates in a centralized architecture suffers of delayed measurement due to communication data links, time algorithms execution, data quantity, ... In order to avoid reordering and reprocessing an entire sequence of measurements for real-time application, the delayed measurements are processed as out-of-sequence

measurements (OOSM). The algorithm used in this work is described in [3]. In addition, according to the road network constraint, the state retrodiction step is done on the road.

24.5 Target type tracking

In [6], Blasch and Kahler fused identification attribute given by EO/IR sensors with position measurement. The fusion was used in the validation gate process to select only the measurement according to the usual kinematic criterion and the belief on the identification attribute. Our approach is different since one uses the belief on the identification attribute to revise the LLR (24.42) with the *posterior* pignistic probability on the target type. We recall briefly the Target Type Tracking (TTT) principle and explain how to improve VS-IMMC SB-MHT with target ID information. TTT is based on the sequential combination (fusion) of the predicted belief of the type of the track with the current "belief measurement" obtained from the target classifier decision. Results depends on the quality of the classifier characterized by its confusion matrix (assumed to be known at least partially as specified by STANAG). The adopted combination rule is the so-called Proportional Conflict Redistribution rule no 5 (PCR5) developed in the DSMT (Dezert Smarandache Theory) framework since it deals efficiently with (potentially high) conflicting information. A detailed presentation with examples can be found in [7, 16]. This choice is motivated in this typical application because in dense traffic scenarios, the VS-IMMC SB-MHT only based on kinematic information can be deficient during maneuvers and crossroads. Let's recall first what the PCR5 fusion rule is and then briefly the principle of the (single-sensor based) Target Type Tracker.

24.5.1 PCR5 combination rule

Let $C_{Tot} = \{\theta_1, \dots, \theta_n\}$ be a discrete finite set of n exhaustive elements and two distinct bodies of evidence providing basic belief assignments (bba's) $m_1(\cdot)$ and $m_2(\cdot)$ defined on the power set³ of C_{Tot} . The idea behind the Proportional Conflict Redistribution (PCR) rules [16] is to transfer (total or partial) conflicting masses of belief to non-empty sets involved in the conflicts proportionally with respect to the masses assigned to them by sources. The way the conflicting mass is redistributed yields actually several versions of PCR rules, but PCR5 (i.e. PCR rule # 5) does the most exact redistribution of conflicting mass to non-empty sets following the logic of the conjunctive rule and is well adapted for a sequential fusion. It does a better redistribution of the conflicting mass than other rules since it goes backwards on the tracks of the conjunctive rule and redistributes the conflicting mass only to the sets involved in the conflict and proportionally to their masses put in the conflict. The PCR5 formula for $s \geq 2$ sources is given in [16]. For the combination of only two

³In our MTT applications, we will assume Shafer's model for the frame C_{Tot} of target ID which means that elements of Θ are assumed truly exclusive.

sources (useful for sequential fusion in our application) when working with Shafer's model, it is given by $m_{PCR5}(\emptyset) = 0$ and $\forall X \in 2^{C_{Tot}} \setminus \{\emptyset\}$

$$m_{PCR5}(X) = m_{12}(X) + \sum_{\substack{Y \in 2^{C_{Tot}} \setminus \{X\} \\ X \cap Y = \emptyset}} \left[\frac{m_1(X)^2 m_2(Y)}{m_1(X) + m_2(Y)} + \frac{m_2(X)^2 m_1(Y)}{m_2(X) + m_1(Y)} \right] \quad (24.44)$$

where $m_{12}(X)$ corresponds to the conjunctive consensus on X between the two sources (i.e. our a priori bba on target ID available at time $k - 1$ and our current *observed* bba on target ID at time k) and where all denominators are different from zero. If a denominator is zero, that fraction is discarded.

24.5.2 Principle of the target type tracker

To estimate the true target type, denoted $type(k)$, at time k from the sequence of declarations $c(1), c(2), \dots, c(k)$ done by the unreliable classifier⁴ up to time k . To build an estimator $\widehat{type}(k)$ of $type(k)$, we use the general principle of the Target Type Tracker (TTT) developed in [7] which consists in the following steps:

- a) Initialization step (*i.e.* $k = 0$). Select the target type frame $C_{Tot} = \{\theta_1, \dots, \theta_n\}$ and set the prior bba $m^-(\cdot)$ as vacuous belief assignment, i.e. $m^-(\theta_1 \cup \dots \cup \theta_n) = 1$ since one has no information about the first observed target type.
- b) Generation of the current bba $m_{obs}(\cdot)$ from the current classifier declaration $c(k)$ based on attribute measurement. At this step, one takes $m_{obs}(c(k)) = P\{c(k)\} = C_{c(k)c(k)}$ and all the unassigned mass $1 - m_{obs}(c(k))$ is then committed to total ignorance $\theta_1 \cup \dots \cup \theta_n$. $C_{c(k)c(k)}$ is the element of the known confusion matrix \mathbf{C} of the classifier indexed by $c(k)c(k)$.
- c) Combination of current bba $m_{obs}(\cdot)$ with prior bba $m^-(\cdot)$ to get the estimation of the current bba $m(\cdot)$. Symbolically we write the generic fusion operator as \oplus , so that $m(\cdot) = [m_{obs} \oplus m^-](\cdot) = [m^- \oplus m_{obs}](\cdot)$. The combination \oplus is done according to the PCR5 rule, *i.e.* $m(\cdot) = m_{PCR5}(\cdot)$.
- d) Estimation of True Target Type is obtained from $m(\cdot)$ by taking the singleton of C_{Tot} , *i.e.* a Target Type, having the maximum of belief (or eventually the maximum Pignistic Probability⁵).

$$\widehat{type}(k) = \underset{A \in C_{Tot}}{argmax} (BetP\{A\}) \quad (24.45)$$

⁴Here we consider only one source of information/classifier, say based either on the EO/IR sensor, or on a video sensor by example. The multi-source case is discussed in section 24.5.3.

⁵The maximum of the pignistic probability has been used in this preliminary work, but the maximum of $DSmP(\cdot)$ presented in the Chapter [?] in this volume will be tested in further developments.

The Pignistic Probability is used to estimate the probability to obtain the type $\theta_i \in C_{Tot}$ given the previous target type estimate $\widehat{type}(k-1)$.

$$BetP\{\theta_i\} = P\{\widehat{type}(k) = \theta_i | \widehat{type}(k-1)\} \quad (24.46)$$

- e) set $m^-(.) = m(.)$; do $k = k + 1$ and go back to step b).

Naturally, in order to revise the LLR (24.42) in our MTT systems for taking into account the estimation of belief of target ID coming from the Target Type Trackers, we transform the resulting bba $m(.) = [m^- \oplus m_{obs}](.)$ available at each time k into a probability measure. In this work, we use the classical pignistic transformation defined by [17]:

$$BetP\{A\} = \sum_{X \in 2^{\Theta}} \frac{|X \cap A|}{|X|} m(X) \quad (24.47)$$

24.5.3 Working with multiple sensors

Since in our application, we work with different sensors (*i.e.* MTI and Video EO/IR sensors), one has to deal with the frames of discernment C_{MTI} and C_{video} defined in section 24.4. Therefore we need to adapt the (single-sensor based) TTT to the multi-sensor case. We first adapt the frame C_{MTI} to C_{video} and then, we extend the principle of TTT to combine multiple bba's (typically here $m_{obs}^{MTI}(.)$ and $m_{obs}^{video}(.)$) with prior target ID bba $m^-(.)$ to get finally the updated global bba $m(.)$ at each time k . The proposed approach can be theoretically extended to any number of sensors. When no information is available from a given sensor, we take as related bba the vacuous mass of belief which represents the total ignorant source because this doesn't change the result of the fusion rule [16] (which is a good property to satisfy). For mapping C_{MTI} to C_{video} , we use a (human refinement) process such that each element of C_{MTI} can be associated at least to one element of C_{video} . In this work, the delay on the type information provided by the video sensor is not taking into account to update the global bba $m(.)$. All type information (delayed or not provided by MTI and video sensors) are considered as bba $m_{obs}(.)$ available for the current update. The explicit introduction of delay of the out of sequence video information is under investigations.

24.5.4 Data attributes in the VS IMMC

To improve the target tracking process, the introduction of the target type probability is done in the likelihood calculation. For this, we consider the measurement $\mathbf{z}_j^*(k) (\forall j \in \{1, \dots, m_k\})$ described in (24.22) and (24.26). With the assumption that the kinematic and classification observations are independant, it is easy to prove that the new combined likelihood Λ_N^l associated with a track $\mathbf{T}^{k,l}$ is the product of the kinematic likelihood (24.32) with the classification probability in the manner that:

$$\Lambda_N^l(k) = \Lambda^l(k) \cdot P\{\widehat{type}(k) | \widehat{type}(k-1)\} \quad (24.48)$$

where the probability $P\{\widehat{type}(k)|\widehat{type}(k-1)\}$ is chosen as the pignistic probability value on the declared target type $\widehat{type}(k)$ derived from the updated mass of belief $m(\cdot)$ according to our target type tracker.

24.6 Simulations and results

24.6.1 Scenario description

To evaluate the performances of the VS-IMMC SB-MHT with the attribute type information, we consider 10 maneuvering (acceleration, deceleration, stop) targets on a real road network (see figure 24.3). The 10 target types are given by (24.25).

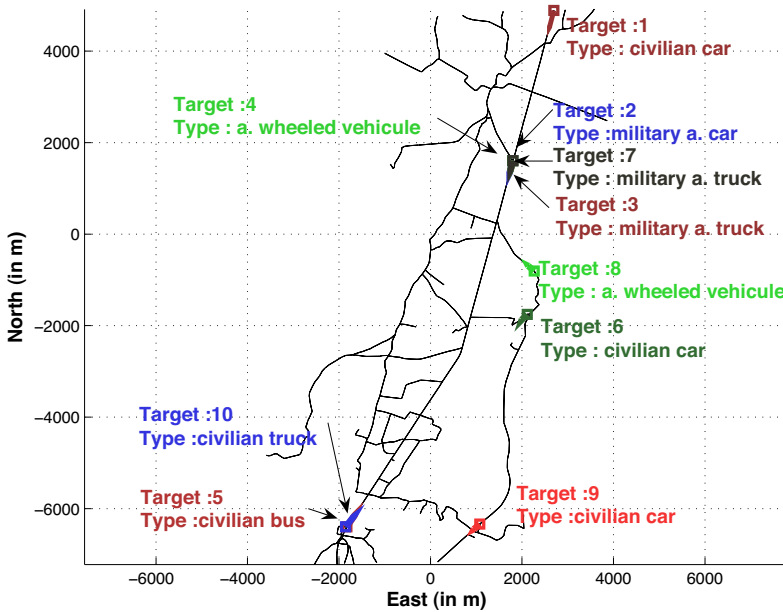

Figure 24.3: Targets trajectories.

The target 1 is passing the military vehicles 2, 3, 4 and 7. Targets 2, 3, 4 and 7 start from the same starting point. The target 2 is passing the vehicles 3 and 7 in the manner that it places in front of the convoy. The targets 5, 6, 9 and 10 are civilian vehicles and are crossing the targets 1, 2, 3 and 7 at several junctions. The goal of this simulation is to reduce the association complexity by taking into account the road network topology and the attribute types given by heterogeneous sensors. In this scenario, we consider one GMTI sensor located at $(-50km, -60km)$ at $4000m$ in elevation (figure 24.4) and one UAV located at $(-100m, -100m)$ (figure 24.5) at $1200m$ in elevation and 5 UGS distributed on the ground (figure 24.6).

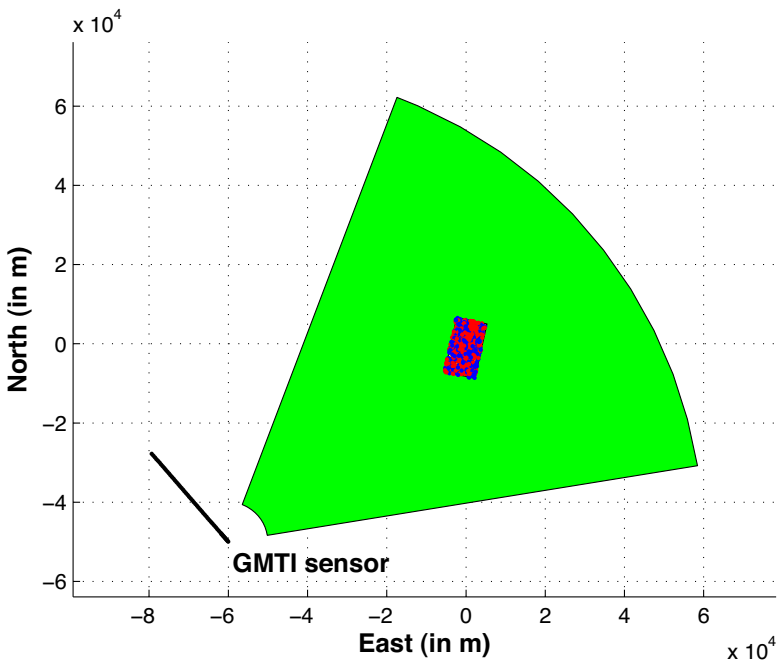

Figure 24.4: GMTI sensor trajectory and cumulated MTI reports.

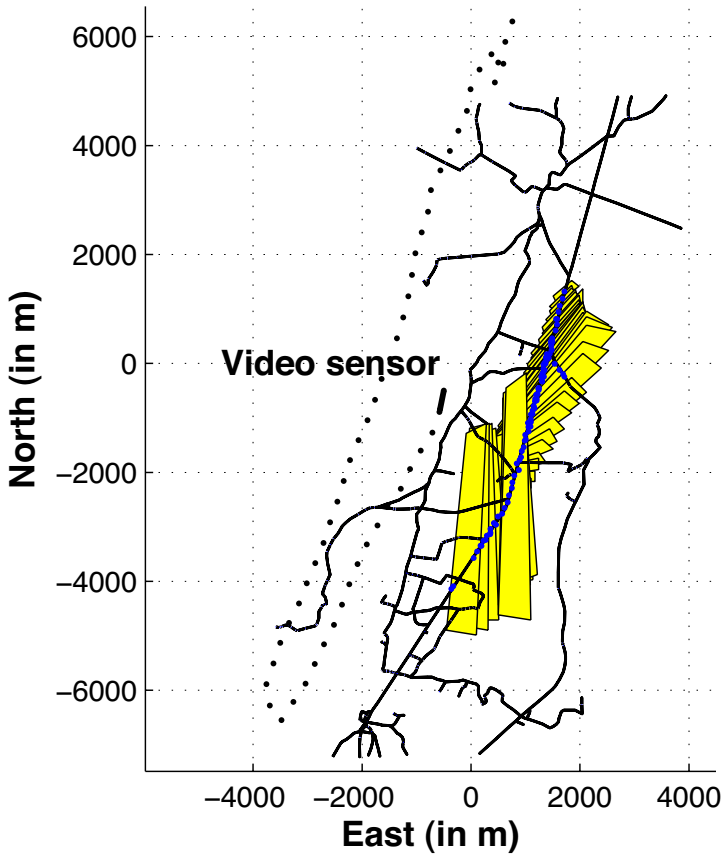

Figure 24.5: UAV trajectory with video sensor ground coverage.

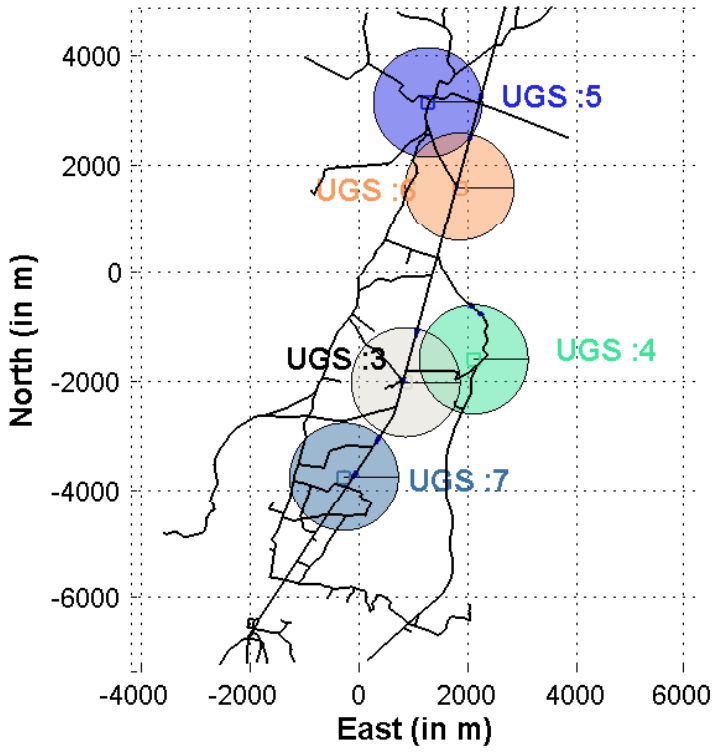

Figure 24.6: UGS positions with field of view.

The GMTI sensor tracks the 10 targets at every 10 seconds with 20 m , 0.0008 rad and $1m \cdot s^{-1}$ range, cross-range and range-rate measurements standard deviation respectively. The detection probability P_D is equal to 0.9 and the MDV (Minimal Detectable Velocity) fixed at 1 m/s . The false alarms density is fixed ($\lambda_{fa} = 10^{-8}$). The confusion matrix described in part 24.5.2 is given by:

$$\mathbf{C}_{MTI} = \text{diag}([0.8 \ 0.7 \ 0.9]) \quad (24.49)$$

This confusion matrix is only used to simulate the target type probability of the GMTI sensor. The data obtained by UAV are given at 10 seconds with 10 m standard deviation in X and Y direction from the TCF. The time delay of the video data is constant and equal to 11 seconds. The detection probability P_D is equal to 0.9. The human operator only selects for each video report a type defined by (24.25). In our simulations, the target type probability depends on the sensor resolution. For this, we consider the volume V_{video} of the sensor area surveillance on the ground. The diagonal terms of the confusion matrix \mathbf{C}_{video} are equal to $P\{c(k)\}$ where $P\{c(k)\}$ is defined by:

$$P\{c(k)\} = \begin{cases} 0.90 & \text{if } V_{video} \leq 10^6 m^2 \\ 0.75 & \text{if } 10^6 m^2 < V_{video} \leq 10^8 m^2 \\ 0.50 & \text{if } V_{video} > 10^8 m^2 \end{cases} \quad (24.50)$$

For the UGS, the target detection is done if only the target is located under the minimal range detection (MRD). The MRD is fixed for the 5 UGS at 1000 m and each sensor gives delayed measurement every seconds. The time delay is also equal to 11 seconds. The UGS specificity is to give only one target detection during 4 seconds in order to detect another target. We recall that there is no false alarm for this sensor. Based on [6], the target type probability depends on α (*i.e.* the target orientation towards the UGS). The more the target orientation is orthogonal to the sensor line of sight, the more the target type probability increases. The diagonal terms of the confusion matrix \mathbf{C}_{UGS} are equal to $P\{c(k)\}$ where $P\{c(k)\}$ is defined by:

$$P\{c(k)\} = \begin{cases} 0.90 & \text{if } \frac{5\pi}{6} \leq \alpha \leq \frac{\pi}{6} \\ 0.50 & \text{otherwise} \end{cases} \quad (24.51)$$

For each detected target, a uniform random number $u \sim U([0, 1])$ is drawn. If u is greater than the true target type probability of the confusion matrix, a wrong target type is declared for the ID report and used with its associated target type probability. The targets are scanned at different times by the sensors (figure 24.7).

24.6.2 Filter parameters

We consider three motion models M^i , $i = 0, 1, 2$ which are respectively a stop model M_0 when the target is assumed to have a zero velocity, a constant velocity model M^1 with a low uncertainty, and a constant velocity model M^2 with a high uncertainty (modeled by a strong noise). The parameters of the IMM are the following: for the

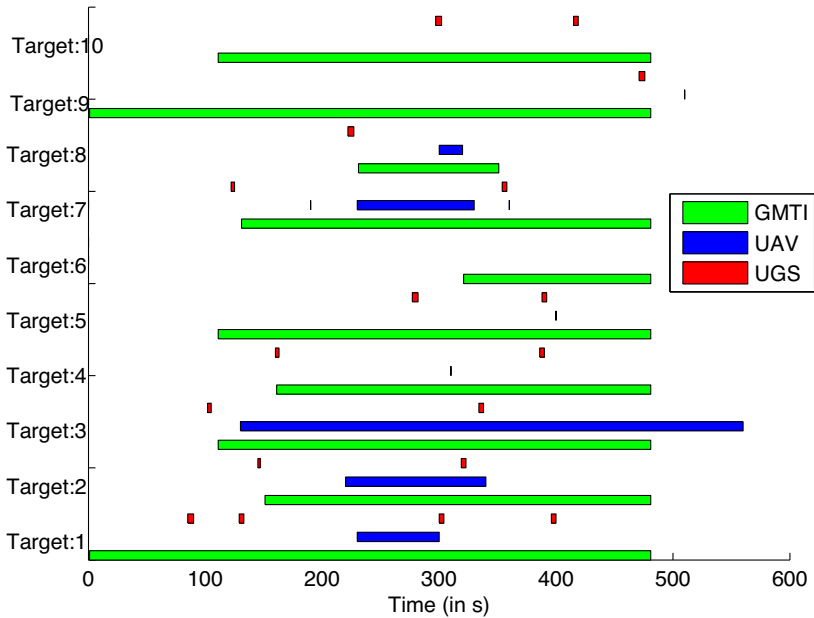

Figure 24.7: Target's sensor illumination.

motion model M^1 , standard deviations (along and orthogonal to the road segment) are equals to $0.05 \text{ m} \cdot \text{s}^{-2}$), the constrained constant velocity model M^2 has a high standard deviation to adapt the dynamics to the target maneuver (the standard deviation along and orthogonal to the road segment are respectively equal to $0.8 \text{ m} \cdot \text{s}^{-2}$ and $0.4 \text{ m} \cdot \text{s}^{-2}$) and the stop motion model M^0 has a standard deviation equals to zero. These constrained motion models are however adapted to follow the road network topology. The transition matrix and the SB-MHT parameters are those taken in [14].

24.6.3 Results

For each confirmed track given by the VS-IMMC SB-MHT, a test is used to associate a track to the most probable target. The target tracking goal is to track as long as possible the target with one track. To evaluate the track maintenance, we use the track length ratio criterion, the averaged root mean square error (noted ARMSE) for each target and the track purity and the type purity (only for the tracks ob-

tained with PCR5) [14]. We obtain for each target the averaged track length ratio ($\forall n \in \{1, \dots, 10\}$):

$$R_n = \sum_{k=1}^{N_{mc}} \frac{l_n}{N_{mc} \cdot L_n} \tag{24.52}$$

where N_{mc} is the number of Monte-Carlo runs, l_n is the mean track length associated the target n and L_n is the length of the true target trajectory.

In addition to the track length ratio criterion, we calculate the ARMSE for each target, the track purity and the type purity (only for the tracks obtained with PCR5). The ARMSE is the root mean square error averaged on the time. The track purity is the ratio between the sum of correct association number on the track length and the type purity is the ratio between the sum of true type decision number on the track length. These measures of performances are averaged on the number Monte-Carlo runs. In this simulation we have used $N_{mc} = 50$ Monte-Carlo runs.

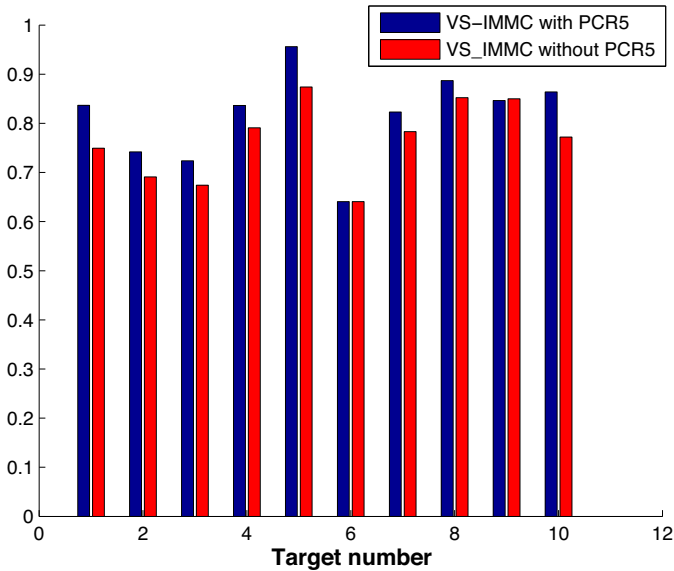

Figure 24.8: Track length ratio.

On the figure 24.8, one sees that the track length ratio becomes better with the PCR5 than without as expected for the target 6. When the targets 1 and 2 are passing the targets 3, 4 and 7, an association ambiguity arises to associate the tracks

with the correct measurements. This is due to the close formation between targets with the GMTI sensor resolution and the road network configuration with junctions. Sometimes tracks are lost with the VS IMMC SB-MHT without the PCR5. Then new tracks for each targets are built. That is why, the track purity of the VS IMMC SB-MHT without PCR5 (see Table 24.1) is smaller than the track purity with PCR5 (see Table 24.2). So, the track precision, given by the ARMSE criterion, is better with the PCR5. For the target 6 results, this target is only scanned by the GMTI sensor and its associated performances are equivalent for both algorithms. Then, if there is no IMINT information and no interaction between targets, the performances of the algorithm with PCR5 are the same as without PCR5.

Despite of the PCR5 improvement on the target tracking, the difference of performances between the algorithms is not significant. If there is an interaction between IMINT and GMTI information, we can see a gain on the track length ratio or track purity of 10% with PCR5. This small difference is due to the good constrained state estimation. The estimated target states have a good precision because the target tracking is done by taking into account the road segments location and the good performances of the OOSM approach. So, it implies a substantial improvement of the target-to-track association. In addition, on Table 24.2, the type purity based on PCR5 is derived from the maximum of $BetP$ criterion. But $BetP$ is computed according the set C_{video} (24.25) and if the track receives only MTI reports the choice on the target type is arbitrary for the tracked vehicles of C_{MTI} (24.21). In fact, a tracked vehicle can be 6 elements of (24.25). So the probability $BetP$ on the 6 tracked vehicles of (24.25) is the same. The selection of the maximum of $BetP$ has no meaning because in such case the maximum becomes arbitrary. This explains the bad track purity of targets 6 and 9.

Target	ARMSE	Track purity	Type purity
1	14.82	0.70	none
2	16.62	0.62	none
3	15.61	0.61	none
4	22.54	0.77	none
5	16.25	0.85	none
6	18.68	0.64	none
7	14.45	0.72	none
8	17.51	0.84	none
9	19.23	0.85	none
10	17.40	0.75	none

Table 24.1: Tracking results (VSIMMC without PCR5).

Target	ARMSE	Track purity	Type purity
1	14.37	0.78	0.64
2	15.77	0.66	0.62
3	15.60	0.61	0.59
4	21.10	0.81	0.81
5	15.88	0.94	0.55
6	18.68	0.64	0.02
7	14.22	0.76	0.76
8	17.38	0.87	0.87
9	19.20	0.85	0.05
10	17.17	0.83	0.46

Table 24.2: Tracking results (VSIMMC and PCR5).

24.7 Conclusion

In this chapter, we have presented a new approach to improve VS IMMC SB-MHT by introducing the data fusion with several heterogeneous sensors. Starting from a centralized architecture, the MTI and IMINT reports are fused by taking into account the road network information and the OOSM algorithm for delayed measurements. The VS IMMC SB-MHT is enlarged by introducing in the data association process the type information defined in the STANAG 4607 and an IMINT attribute set. The estimation of the Target ID probability is done from the updated/current attribute mass of belief using the Proportional Conflict Redistribution rule no. 5 developed in DSMT framework and according to the Target Type Tracker (TTT) recently developed by the authors. The Target ID probability once obtained is then introduced in the track score computation in order to improve the likelihoods of each data association hypothesis of the SB-MHT. Our preliminary results show an improvement of the performances of the VS-IMMC SB-MHT when the type information is processed by our PCR5-based Target Type Tracker. In this work, we did not distinguish undelayed from delayed sensor reports in the TTT update. This problem is under investigations and offers new perspectives to find a solution for dealing efficiently with the time delay of the identification data attributes and to improve the performances. One simple solution would be to use a forgetting factor of the delayed type information but other solutions seem also possible to explore and need to be evaluated. Some works need also to be done to use the operational ontologic APP-6A for the heterogeneous type information. Actually, the frame of the IMINT type information is bigger than the one used in this chapter and the IMINT type information can be given at different granularity levels. As a third perspective, we envisage to use both the type and contextual information in order to recognize the tracks losts in the terrain masks which represent the possible target occultations due to the terrain topography in real environments.

24.8 References

- [1] Y. Bar-Shalom, D. Blair, *Multitarget multisensor tracking: Applications and Advances*, Vol. III, Artech House, 2000.
- [2] Y. Bar-Shalom, X. R. Li and T. Kirubarajan, *Estimation with applications to tracking and navigation: algorithms and software for information extraction*, Wiley, New York, 2001.
- [3] Y. Bar-Shalom, H. Chen, *IMM estimator with out-of-sequence measurements*, IEEE Trans. on AES, Vol. 41, No. 1, pp. 90–98, January 2005.
- [4] D.F. Bizup, D.E. Brown, *The over-extended Kalman filter - Don't use it!*, Proc. of ICIF, Fusion 2003, Cairns, Australia, July 2003.
- [5] S.S. Blackman, R. Popoli, *Design and analysis of modern tracking systems*, Artech House, 1999.
- [6] E. Blasch, B. Kahler, *Multiresolution EO/IR target tracking and identification*, Proc. of ICIF, Fusion 2005, Philadelphia, PA, USA, pp. 275–282, July 2005.
- [7] J. Dezert, A. Tchamova, F. Smarandache and P. Konstantinova, *Target Type Tracking with PCR5 and Dempster's rules: A Comparative Analysis*, Proc. of ICIF, Fusion 2006, Firenze, Italy, July 2006.
- [8] J. G. Herrero, J. A. B. Portas and J. R. C. Corredara, *Use of Map Information for target tracking on airport surface*, IEEE Trans., on AES, Vol. 39, no. 2, pp. 675–693, April 2003.
- [9] T. Kirubarajan, Y. Bar-Shalom, K.R. Pattipati and I. Kadar, *Ground target tracking with topography-based variable structure IMM estimator*, Proc. of SPIE, signal and data processing of small targets, Vol. 3373, pp. 222–233, Jul. 1998.
- [10] T. Kirubarajan, Y. Bar-Shalom, *Tracking evasive move-stop-move targets with an MTI radar using a VS-IMM estimator*, IEEE Trans. on AES, Vol. 39, No. 3, pp. 1098–1103, July 2003.
- [11] NATO, *STANAG 4607 JAS (Edition 2) - NATO ground moving target indicator GMTI format*, NSA0749(2007)-JAS/4607, August 2007.
- [12] B. Pannetier, K. Benameur, V. Nimier and M. Rombaut, *Ground target tracking with road constraint*, Proc. of SPIE, sensor fusion and target recognition XIII, Volume 5429, April 2004.
- [13] B. Pannetier, V. Nimier and M. Rombaut, *Multiple ground target tracking with a GMTI sensor*, Proc. of MFI 2006, pp. 230–236, September 2006.

- [14] B. Pannetier, J. Dezert and E. Pollard, *Improvement of multiple ground targets tracking with GMTI sensors and fusion identification attributes*, IEEE Aerospace Conference, pp. 1–13, March 2008.
- [15] P.J. Shea, T. Zadra, D. Klamer, E. Frangione and R. Brouillard, *Improved state estimation through use of roads in ground tracking*, Proc.of SPIE, Signal and Data Processing of Small Targets, Vol. 4048, pp. 321–332, July 2000.
- [16] F. Smarandache, J. Dezert, (Editors), *Advances and Applications of DSMT for Information Fusion (Collected Works)*, Vol. 2, American Research Press, Rehoboth, U.S.A, 2006.
- [17] Ph. Smets, *Data Fusion in the Transferable Belief Model*, Proc. of ICIF, Fusion 2000, pp. PS21–PS33, Paris, France, July 10-13, 2000.
- [18] D.U. Thibault, *Commented APP-6A - Military symbols for land based systems*, Technical Note, DRDC Val Cartier, TN 2005-222, September 2005.
- [19] M. Ulmke, W. Koch, *Road-map assisted ground moving target tracking*, IEEE Trans. on AES, Vol. 42, No. 4, pp. 1264–1274, October 2006.
- [20] A. Wald, J. Wolfowitz, *Optimum character of the sequential probability ratio test*, Ann. Math. Stat., Vol. 19, pp. 326–339, 1948.
- [21] J. G. Wang, T. Long and P.K. He, *A New Method of Incorporating Radial Velocity Measurement into Kalman Filter*, Proc. of SPIE, no. 18, pp. 414–416, 2002.

Chapter 25

Multiple cameras fusion based on DSMT for tracking objects on ground plane

Esteban Garcia, Leopoldo Altamirano
National Institute for Astrophysics, ,
Optics and Electronics,
Puebla, Mexico.
eomargr@inaoep.mx, robles@inaoep.mx

Abstract: *This chapter presents comparative results of a model for multiple cameras fusion, which is based on Dezert-Smarandache theory of evidence. Our architecture works at the decision level to track objects on a ground plane using predefined zones, producing useful information for surveillance tasks such as behavior recognition. Decisions from cameras are generated by applying a perspective-based basic belief assignment function, which represent uncertainty derived from cameras perspective while tracking objects on ground plane. Results obtained from applying our tracking model to computer-generated-imagery (CGI) animated simulations and real sequences are compared to the ones obtained by Bayesian fusion, and show how DSMT theory of evidence overcomes Bayesian fusion for this application.*

This chapter has been published as a paper in the Proceedings of Fusion 2008 Int. Conf., Cologne, Germany in July 2008.

25.1 Introduction

Computer vision uses information from more than one camera to develop several tasks, such as 3D reconstruction or complementing fields of view to increase surveillance areas, among others. Using more than one camera has some advantages, even if information is not fused. A simple instance might be having a multi-camera system where it is possible to cover wider area, and at the same time is more robust to failures where cameras overlap.

There exists a tendency, in computer vision, to work on high level tasks [5, 9, 10, 13], where moving objects position is not useful when it is given in image plane coordinates, instead of it, it is preferred when position is described according to predefined regions on ground plane. This sort of information can be used for behavior recognition where people behavior is described by mean of predefined zones of interest on scene.

In [13] a tracking system using predefined regions is used to analyze behavioral patterns. In the same work, only one camera is used and no considerations are taken on distortions due to camera perspective. In [10] a Hierarchical Hidden Markov Model is used to identify activities, based on tracking people on a cell divided room. Two static cameras cover scene, but information coming from them is used separately, their purpose is to focus on different zones, but not to refine information.

As cameras work by transforming information from 3D space into 2D space, there is always uncertainty involved. In order to estimate object position related to ground plane, it is necessary to find out its position in image plane and then estimate that position on ground plane. For surveillance tasks where objects position has to be given according to ground plane, it is possible to apply projective transform in order to estimate objects position on ground plane, however, this process might carry errors from perspective.

In [4] we presented a decision level architecture to fuse information from cameras, reducing uncertainty derived from perspective on cameras. The stage of the processing at which data integration takes place allows an interpretation of information which describes better the position of objects being observed and at the same time is useful for high level surveillance systems. In our proposal, individual decisions are taken by means of an axis-projection-based *generalized basic belief assignment* (gbba) function and finally fused using Dezert-Smarandache (DS_m) hybrid rule. In this work, we present a theoretical and practical comparison between DS_m and a Bayesian module applied to computer-generated-imagery (CGI) and real multicamera sequences.

This chapter is organized as follows: in section 25.2, Dezert-Smarandache theory is briefly described as mathematical framework. In section , our architecture is described altogether with the gbba function we used. A comparison between Bayesian and DS_m hybrid combination rule is presented in section 25.4. Finally in section 25.5 conclusions are presented.

25.2 DSm hybrid model

The DSmT defines two mathematical models used to represent and combine information [3]: free and hybrid.

The *Free DSm model*, denoted as $\mathcal{M}^f(\Theta)$, defines $\Theta = \{\theta_1, \dots, \theta_n\}$ as a set or frame of n non exclusive elements and an hyper-power set D^Θ as the set of all composite possibilities obtained from Θ in the following way:

1. $\emptyset, \theta_1, \dots, \theta_n \in D^\Theta$
2. $\forall A \in D^\Theta, B \in D^\Theta, (A \cup B) \in D^\Theta, (A \cap B) \in D^\Theta$
3. D^Θ is formed only by elements obtained by rules 1 or 2

Function $m(A)$ is called general basic belief assignment or mass for A , defined as $m(\cdot) : D^\Theta \rightarrow [0, 1]$, and is associated to a source of evidence.

A DSm hybrid model introduces some integrity constraints on elements $A \in D^\Theta$ when there are known facts related to those elements in the problem under consideration. In our work, exclusivity constraints are used to represent those regions on ground plane which are not adjacent. The restricted elements are forced to be empty in the hybrid model $\mathcal{M}(\Theta) \neq \mathcal{M}^f(\Theta)$ and the mass is transferred to the non restricted elements. When DSm hybrid model is used, combination rule for two or more sources is defined for $A \in D^\Theta$ with these functions:

$$m_{\mathcal{M}(\Theta)}(A) = \phi(A) [S_1(A) + S_2(A) + S_3(A)] \tag{25.1}$$

$$S_1(A) = \sum_{\substack{X_1, X_2, \dots, X_k \in D^\Theta \\ X_1 \cap X_2 \cap \dots \cap X_k = A}} \prod_{i=1}^k m_i(X_i) \tag{25.2}$$

$$S_2(A) = \sum_{\substack{X_1, X_2, \dots, X_k \in \emptyset \\ [\mathcal{U} = A] \vee [[\mathcal{U} \in \emptyset] \wedge [A = I_t]]}} \prod_{i=1}^k m_i(X_i) \tag{25.3}$$

$$S_3(A) = \sum_{\substack{X_1, X_2, \dots, X_k \in D^\Theta \\ X_1 \cup X_2 \cup \dots \cup X_k = A \\ X_1 \cap X_2 \cap \dots \cap X_k \in \text{emptyset set}}} \prod_{i=1}^k m_i(X_i) \tag{25.4}$$

where $\phi(A)$ is called the characteristic emptiness function of a set A ($\phi(A) = 1$ if $A \notin \emptyset$ and $\phi(A) = 0$ otherwise). $\emptyset = \{\emptyset_{\mathcal{M}}, \emptyset\}$ where $\emptyset_{\mathcal{M}}$ is the set of of all elements of D^Θ forced to be empty. \mathcal{U} is defined as $\mathcal{U} = u(X_1) \cup u(X_2) \cup \dots \cup u(X_k)$, where $u(X)$ is the union of all singletons $\theta_i \in X$, while $I_t = \theta_1 \cup \theta_2 \cup \dots \cup \theta_n$.

25.3 Multiple cameras fusion

In order to have a common space reference system, spatial alignment is required. Homography is used to relate information from cameras. It is possible to recover homography from a set of static points on ground plane [12] or dynamic information in scene [2]. Correspondence between objects detected in cameras might be achieved by features matching techniques [8] or geometric ones [1, 7].

Once the homography matrix has been calculated, it is possible to relate information from one camera to others. While object is being tracked by a camera, its vertical axis is obtained and its length is estimated as $\lambda = l\cos(\alpha)$, where l is the maximum length for axis when projected on ground plane and α is the angle of the camera respect to the ground plane.

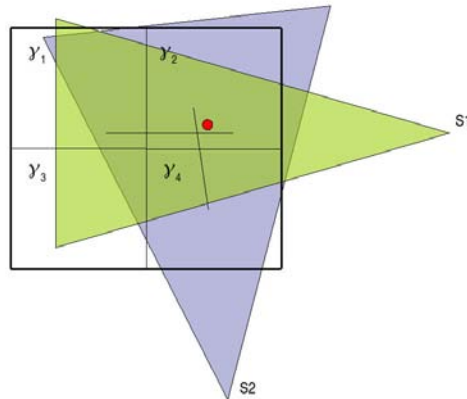

Figure 25.1: Example of vertical axis obtained by two cameras, projected on ground plane.

Let $\Gamma = \{\gamma_1, \dots, \gamma_n\}$ denote ground plane partition, where each γ_x is a predefined region on ground plane, which might be an special interest zone, such as corridor or parking area.

For each moving object i , it is created a frame $\Theta_i = \{\theta_1, \dots, \theta_k\}$. Each element θ_x represents a zone γ_y where the object i might be located, according to information from cameras. Θ_i is built dynamically considering only the zones for which there exist some belief provided by at least one camera.

Multiple cameras fusion, in the way it is used in this work, is a tool for high level surveillance systems. Behavior recognition models might use information in the form of beliefs, such as fuzzy logic classifiers or probabilistic models do. Therefore,

it is allowed for the camera to assign mass to elements in D^\ominus in the form of $\theta_i \cap \theta_j$, because this might represent an object in the border of two regions on ground plane. For couples of hypotheses which represent non-adjacent regions of the ground plane, it does not make sense consider such belief assignments, therefore elements in D^\ominus representing non-adjacent regions of ground plane, are included to $\emptyset_{\mathcal{M}}$.

Each camera behaves as an expert, assigning mass to each one of the unconstrained elements of D^\ominus . The assignment function is simple, and has as its main purpose to consider perspective influence on uncertainty. It is achieved by means of measuring intersection area between γ_x and object's vertical axis projected on ground plane, centered on the object's feet. The length of the axis projected on ground plane is determined by the angle of the camera respect to the ground plane, taking object's ground point as the vertex to measure the angle. So if the camera were just above the object, its axis projection would be just one pixel long, meaning no uncertainty at all. We consider three cases to cover mass assignation showed in figure 25.2.

When projected axis is within a region of the ground plane, camera assigns full belief to that hypothesis. When axis crosses two regions it is possible to assign to composed hypotheses of the kind $\theta_i \cup \theta_j$ and $\theta_i \cap \theta_j$, depending on the angle of the camera.

Let ω_c denotes the vertical axis obtained by camera c , projected on ground plane, and $|\omega_c|$ its area. Following functions are used as gbba model.

$$v = |\omega_c| \cos(\alpha_c) \tag{25.5}$$

$$m_c(\theta_i) = \frac{|\omega_c \cap \gamma_x|}{v + |\omega_c|} \tag{25.6}$$

$$m_c(\theta_i \cup \theta_j) = \frac{|\omega_c| \cos^2(\alpha_c)}{v + |\omega_c|} \tag{25.7}$$

$$m_c(\theta_i \cap \theta_j) = \frac{v(1 - \cos(\alpha_c))}{v + |\omega_c|} \tag{25.8}$$

When axis intersects more than two regions on ground plane, functions become:

$$v = |\omega_c| \cos(\alpha_c) \tag{25.9}$$

$$m_c(\theta_i) = \frac{|\omega_c \cap \gamma_x|}{v + |\omega_c|} \tag{25.10}$$

$$m_c(\theta_i \cup \theta_j \cup \dots \cup \theta_k) = \frac{v}{v + |\omega_c|} \tag{25.11}$$

$v + |\omega_c|$ is used as a normalizer in order to satisfy $m_c(\cdot) \rightarrow [0, 1]$ and Each camera can provide belief to elements $\theta_x \cap \theta_y \in D^\ominus$, by considering couples γ_i and γ_j (represented by θ_x and θ_y respectively) crossed by axis projection. Elements $\theta_x \cup \dots \cup \theta_x$ can have an associated gbba value, which represents local or global ignorance. We also restrict elements in $\theta_x \cap \dots \cap \theta_y \in D^\ominus$ for which there is not a direct basic assignation made by one of the cameras, thus they are included in $\emptyset_{\mathcal{M}}$, and calculations are simplified. That is possible because of the hybrid DSm model definition. Decision fusion is used to combine the outcomes from cameras, making a final decision. We apply hybrid DSm rule of combination over D^\ominus in order to achieve a final decision.

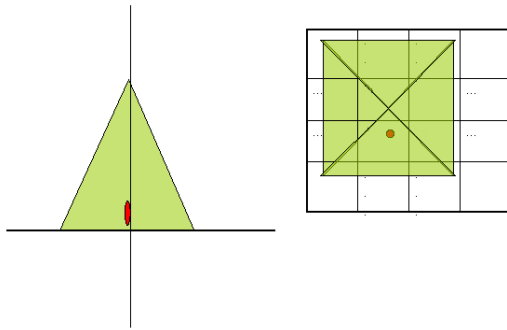

(a) Belief is assigned to θ_i

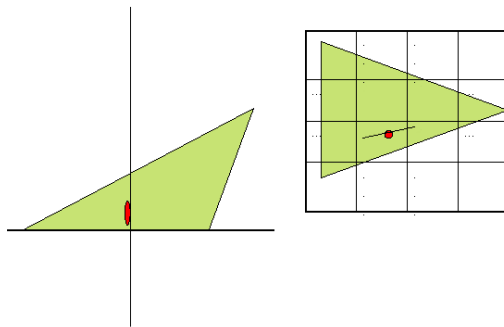

(b) Belief is assigned to $\theta_i, \theta_j, \theta_i \cup \theta_j$ and $\theta_i \cap \theta_j$

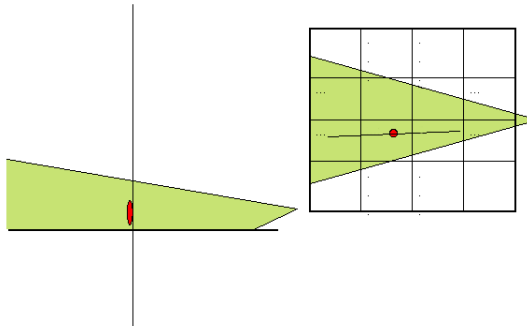

(c) Belief is assigned to $\theta_i, \dots, \theta_k$ and $\theta_i \cup \dots \cup \theta_k$

Figure 25.2: Cases considered for belief assignment.

25.4 Results and discussion

To test the proposed architecture for fusion, we used computer-generated-imagery sequences (figure 25.3) and real sequences from the Performance Evaluation of Tracking and Surveillance dataset [6].

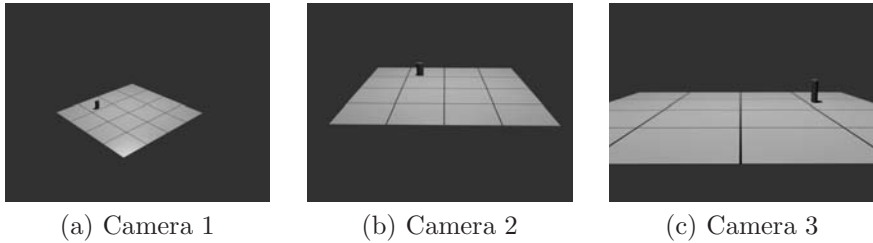

Figure 25.3: Example of CGI sequences.

In CGI sequences, three cameras were simulated. We considered a squared scenario with a grid of sixteen regular predefined zones. 3D modeling was done using Blender with Yafray as rendering machine. All generated images for sequence are in a resolution of 800x600 pixels. Examples of images generated by rendering are shown in figure 25.3, where division lines were outlined on ground plane to have a visual reference of zones, but they are not required for any other task.

As real sequences, PETS repository was used (figure 25.4). In this data set, two cameras information is provided, in a resolution of 768x576 pixels in JPEG format. Our architecture and gbba function was applied to track people, cars and bicycles.

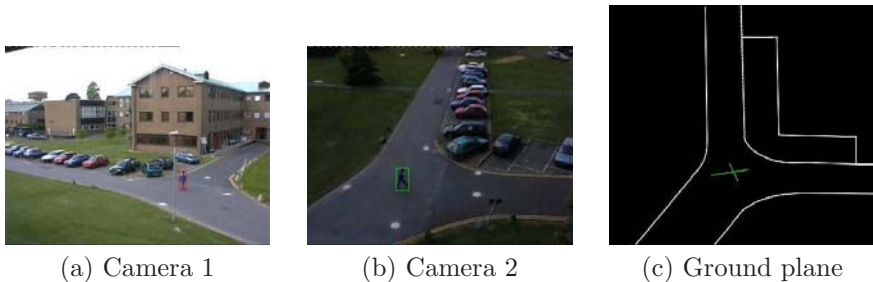

Figure 25.4: Example of real sequences from PETS.

As part of the results, it is interesting to show the differences between DS_m and a probabilistic model to fuse decisions. For this application, hypotheses have a geometric meaning, and we found that this has to be taken in consideration during fusion.

25.4.1 Probabilistic fusion module

For comparison purposes, a Bayesian classifier was developed for each of the regions on ground plane, as showed in figure 25.5. *A priori* probability is assumed the same for each of the regions, while conditional probability is taken from masses generated by cameras, being normalized.

$$p(\gamma_i | S_1, \dots, S_n) = \frac{p(\gamma_i)p(S_1, \dots, S_n | \gamma_i)}{p(S_1, \dots, S_n)}$$

$$\begin{aligned} p(\gamma_i | S_1, \dots, S_n) &\propto p(\gamma_i)p(S_1 | \gamma_i)p(S_2 | \gamma_i)p(S_3 | \gamma_i) \dots \\ &= p(\gamma_i) \prod_{i=1}^n p(S_i | \gamma_i) \end{aligned}$$

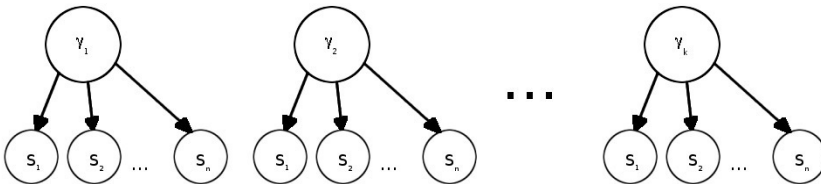

Figure 25.5: Bayesian classifiers as fusion module.

Ignorance from cameras means that a camera does not have a good point of view to generate its information. If a probabilistic model is applied ignorance is not considered and that might derive wrong results. Let's consider the following numerical example: suppose two cameras assign following beliefs:

$$m_1(A) = 0.35 \quad m_1(B) = 0.6 \quad m_1(A \cup B) = 0.05$$

$$m_2(A) = 0.3 \quad m_2(B) = 0.1 \quad m_2(A \cup B) = 0.6$$

Probabilistic model generates following decisions:

$$p(A) \propto 0.5 \cdot \frac{0.35}{0.35 + 0.6} \cdot \frac{0.3}{0.3 + 0.1} = 0.13$$

$$p(B) \propto 0.5 \cdot \frac{0.6}{0.35 + 0.6} \cdot \frac{0.1}{0.3 + 0.1} = 0.07$$

DSm model results:

$$m_{DSm}(A) = 0.35 \cdot 0.3 + 0.35 \cdot 0.6 + 0.05 \cdot 0.3 = 0.33$$

$$m_{DSm}(B) = 0.6 \cdot 0.1 + 0.6 \cdot 0.6 + 0.05 \cdot 0.1 = 0.42$$

In decisions generated by cameras, first sensor assign higher mass to the hypothesis B , while second sensor assigns higher belief to hypothesis A . If ignorance is considered, it is clear that as result from fusion one must have a higher value for hypothesis B , because second sensor is in a better position. However, in probabilistic fusion decision hypothesis A is higher. This shows how considering ignorance may improve results from fusion applied to multi-cameras tracking.

Positions obtained by fusion of the decisions of the cameras are showed in figures 25.6 and 25.7. Graphics show how DSm gets higher decision values than Bayesian fusion.

In tables 25.4.1 and 25.4.1 metrics TRDR (Tracker Detection Rate) and FAR (False Alarm Rate) are showed from data collected from 2 CGI sequences and 5 real sequences. We also propose *Similarity to Truth* measure, to evaluate how close in values is the result of fusion to truth data.

TRDR and *FAR* are evaluated with following equations:

$$TRDR = \frac{TP}{TG} \quad (25.12)$$

$$FAR = \frac{FP}{TP + FP} \quad (25.13)$$

where TG is the total number of regions by each image where there are objects in motion according to ground truth. According to this metrics, it is desirable to have the highest value in *TRDR* while the lowest in *FAR*.

Similarity to Truth (ST) is a measure to quantify the differences between positions obtained by fusion modules compared to ground truth. When there exists belief assigned to certain position, and also there exists an object on that position in ground truth, the amount of belief is summed, but when there is not object in ground truth,

Source	TRDR	FAR	Similarity to Truth
Camera 1	99.5%	52.9%	65.2%
Camera 2	93.9%	43.0%	69.7%
Camera 3	84.4%	45.3%	23.0%
DS _m	93.9%	5.6%	84.1%
Probabilistic	93.3%	5.2%	24.9%

Table 25.1: Results on CGI animations.

Source	TRDR	FAR	Similarity to Truth
Camera 1	68.1%	21.7%	31.6%
Camera 2	71.0%	2.7%	67.5%
DS _m	82.8%	10.2%	75.9%
Probabilistic	82.8%	10.2%	67.9%

Table 25.2: Results on real sequences.

this amount of belief is subtracted, and finally, the amount obtained is normalized to be showed as percentage.

Results from tables show how DS_m reduces uncertainty from perspective and complements information where cameras lost object or fields of view do not overlap. Bayesian fusion behaves similar to DS_m, however, hybrid combination rule takes in consideration information assigned to ignorance, which may refine information such as in example from section 25.4.1. *ST* quantifies how close is belief assigned to regions to ground truth. From *ST* values, one sees that DS_m has higher values, closer to ground truth.

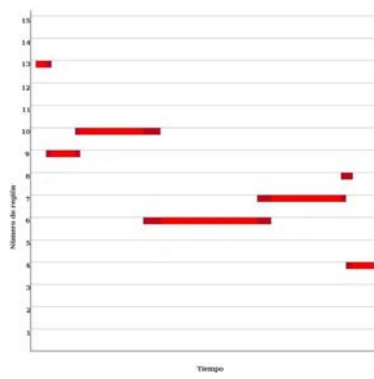

(a) True position.

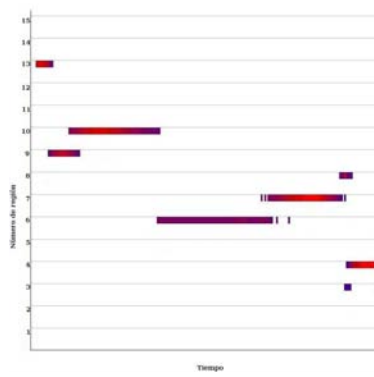

(b) Decisions by DSm.

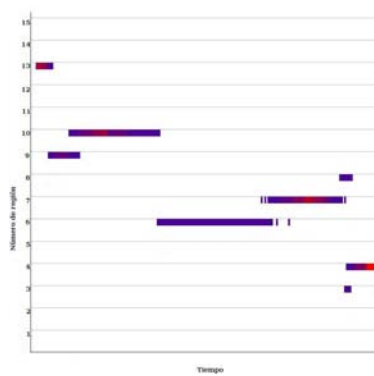

(c) Decisions by Bayesian fusion.

Figure 25.6: Example of positions obtained in 3D animations. Belief value is plotted from blue to red, blue meaning low belief and red meaning 1.

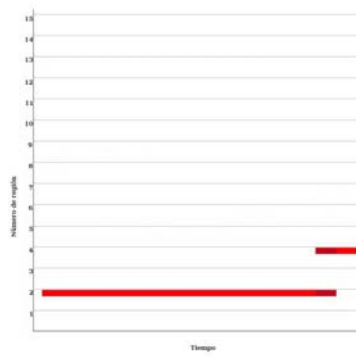

(a) True position.

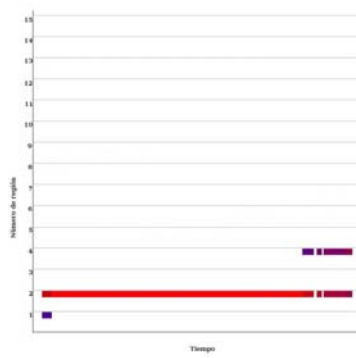

(b) Decisions by DS_m.

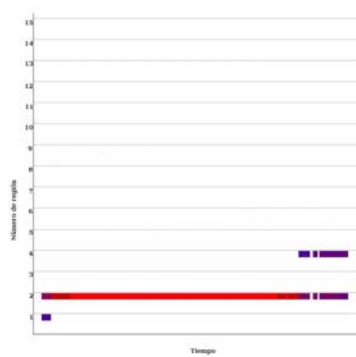

(c) Decisions by Bayesian fusion.

Figure 25.7: Example of positions obtained in real sequences. Belief value is plotted from blue to red, blue meaning low belief and red meaning 1.

25.5 Conclusions

Using cameras as experts at high level for processing objects position, allows to apply Dezert-Smarandache Theory to combine beliefs. Beliefs correspond to objects locations on ground plane, given in relation to predefined regions.

Test showed how DSMT Theory of evidence generates higher values as results and a better approximation to ground truth. In addition to this, DSMT allows belief to be assigned to intersection of hypotheses, which might be interpreted as an object in the border of two regions, and might be useful information for behavior recognition based on fuzzy logic, while probabilistic approaches does not allow this kind of information because of exclusivity constraints. For the fusion of objects position, DSMT showed better results than Bayesian fusion.

Even good results were obtained using DSMT, it is known that when conflicting sources are combined the masses committed to partial ignorances are increased and after a while this ends up to get the vacuous belief assignment. It is expected that DSMT-PCR5 fusion rule yields better results.

25.6 References

- [1] J. Black, T. Ellis, *Multi camera image tracking*, Image Vision Comput., vol. 24, no. 11, pp. 1256–1267, 2006.
- [2] K. J. Bradshaw, I. D. Reid, D. W. Murray, *The active recovery of 3d motion trajectories and their use in prediction*, IEEE Trans. Pattern Anal. Mach. Intell., Vol. 19, no. 3, pp. 219–234, 1997.
- [3] J. Dezert, F. Smarandache, *An introduction to DSMT*, Chapter 1 of [11].
- [4] E. Garcia, L. A. Robles, *Decision level multiple cameras fusion using Dezert-Smarandache theory*, in CAIP, ser. Lecture Notes in Computer Science, W. G. Kropatsch, M. Kampel, and A. Hanbury, Eds., Vol. 4673, Springer, pp. 117–124, 2007.
- [5] R. Green, L. Guan, *Quantifying and recognizing human movement patterns from monocular video images - part i: A new framework for modeling human motion*, 2003.
citeseer.ist.psu.edu/article/green03quantifying.html
- [6] Internet Reference, *Performance evaluation of tracking and surveillance dataset*, 2001.
http://www.cvg.cs.rdg.ac.uk/PETS2001/pets2001_dataset.html
- [7] S. Khan, M. Shah, *Consistent labeling of tracked objects in multiple cameras with overlapping fields of view*, IEEE Trans. on Pattern Analysis and Machine Intelligence, Vol. 25, no. 10, pp. 1355–1360, 2003.

- [8] J. Krumm, S. Harris, B. Meyers, B. Brumitt, M. Hale, S. Shafer, *Multi-camera multiperson tracking for easy living*, in Proc. of the Third IEEE International Workshop on Visual Surveillance, pp. 3–10, July 2000.
- [9] F. Lv, J. Kang, R. Nevatia, I. Cohen, and G. Medioni, *Automatic tracking and labeling of human activities in a video sequence*, IEEE Int. Workshop on Performance Evaluation of Tracking and Surveillance In conjunction with ECCV'04, 2004.
<http://citeseer.ist.psu.edu/lv04automatic.html>
- [10] N. T. Nguyen, D. Q. Phung, S. Venkatesh, H. Bui, *Learning and detecting activities from movement trajectories using the hierarchical hidden Markov models*, in Proceedings of the 2005 IEEE Comp. Soc. Conf. on Computer Vision and Pattern Recognition (CVPR'05) - Vol. 2, Washington, DC, U.S.A., IEEE Computer Society, pp. 955–960, 2005.
- [11] F. Smarandache, J. Dezert, (Editors), *Advances and Applications of DSMT for Information Fusion (Collected Works)*, Vol. 3, American Research Press, Rehoboth, U.S.A., 2009.
- [12] G. Stein, L. Lee, R. Romano, *Monitoring activities from multiple video streams: Establishing a common coordinate frame*, IEEE Trans. Pattern Anal. Mach. Intell., Vol. 22, no. 8, pp. 758–767, 2000.
- [13] W. Yan, D. A. Forsyth, *Learning the behavior of users in a public space through video tracking*, in Proc. of the 7th IEEE Workshops on Application of Computer Vision (WACV/MOTION'05) - Vol. 1, Washington, DC, USA, IEEE, Computer Society, pp. 370–377, 2005.

Biographies of contributors

Leopoldo Altamirano was born in Mexico. He got his Bachelor and Master degrees in Computer Science in Puebla and Mexico city. His Ph.D. in Computer Sciences was obtained at the Technical University of Munich, Germany. Since 1997, he is at the National Institute of Astrophysics, Optics and Electronics at the Computer Sciences Department. He is the Head of the Computer Vision Laboratory at INAOE. His research fields include image processing, sensor fusion and industrial applications of the computer vision.

Address: National Institute for Astrophysics, Optics and Electronics (INAOE), Computer Sciences Department, Luis Enrique Erro No. 1, Sta Ma. Tonantzintla, Pue., CP 72760, Puebla, Pue, Mexico.

Web page: <http://ccc.inaoep.mx/en/>, E-mail: robles@inaoep.mx

Mireille Batton-Hubert is Associate Professor in Environmental Information Systems and administrator of the IDEE Information, Decision and Environmental Evaluation Department at Ecole Nationale Supérieure des Mines de Saint-Etienne, France. Her research activities focus on computational methods for analysis of geo-referenced data dealing with continuous phenomena (air-water) for controlling located environmental impacts. These activities concern forecasting (impact studies, health monitoring, etc) with regard to rivers and atmosphere as well as landfill sites or polluting sites. Her research team develops tools used for control, supervision, risk assessment and real-time decision applied to living and eco-industrial processes. The research topics concern: Aerodynamics - hydrodynamics and groundwater - impacts hydro territorial adjustments - simultaneous analysis of hazards operating on drinking water supply network - time distribution of air quality in urban areas - atmospheric pollution and odour prediction - information fusion for natural risk analysis.

Address: Ecole Nationale Supérieure des Mines de Saint-Etienne - Centre SITE, 158 cours Fauriel, 42023 Saint-Etienne cedex 2, France.

Web page: <http://www.emse.fr/en/>, E-mail: batton@emse.fr

Aichouche Belhadj-Aissa obtained her engineering degree in electronics from National Polytechnic School, Algiers, Algeria in 1980, her magister degree in Image Processing in 1985 from the Institute of Electronics, University of the Sciences and Technology Houari Boumediene (USTHB), Algiers and her Ph.D. in image processing and remote sensing in 1998 at USTHB. She is now Professor in electronics, image processing, remote sensing and Geographic Information Systems (GIS), responsible for post-graduate "signal and image processing", and Head of the research team "GIS and integration of geo-referenced data". Her research interests include satellite image processing, modeling, analysis of textures and forms, fusion and classification of objects, interferometry and SAR polarimetry radar and GIS.

Address: Image Processing and Radiation Laboratory, Univ. of Sciences and Technology Houari Boumediene, BP. 32, El Alia, Bab Ezzouar, 16111, Algiers, Algeria.

E-mail: h.belhadj@lycos.com

Ljudmil Bojilov was born in 1944 in Sofia, Bulgaria. He received his MSc. in nuclear physics in 1968. From 1972 to 1991 he worked in the field of Computer Aided Design. In 1991 he received Ph.D. degree in this field. From 1991 to 2005 he was involved in the Target Tracking Group in Institute for Parallel Processing – division of Bulgarian Academy of Sciences. Since 2005 he continues his research activities on image processing problems. Currently, he is Associate Professor in the Institute for Parallel Processing.

Address: Institute for Parallel Processing, Bulgarian Academy of Sciences, “Acad. G. Bonchev” Str., bl.25-A, 1113 Sofia, Bulgaria.

E-mail: bojilov@bas.bg

Abdenour Bouakache was born in Bouira, Algeria in 1978. He obtained his engineering degree in automatics from National Polytechnic School, Algiers, Algeria in 2002. He received the magister degree in Signal and Image Processing from the Institute of Electronics, University of the Sciences and Technology Houari Boumediene (USTHB), Algiers, Algeria, in 2005. He is currently Ph.D. student at the same university. His main research is in satellite images classification and fusion using DST and DSMT.

Address: Image Processing and Radiation Laboratory, Univ. of Sciences and Technology Houari Boumediene, BP. 32, El Alia, Bab Ezzouar, 16111, Algiers, Algeria.

E-mail: abbouakache@lycos.com

Guy Cazuguel was born in Morlaix (Brittany, France) in 1952. He graduated as engineer from the Ecole Nationale de l’Aviation Civile in 1975, and received a M.Sc. in Advanced Automatics from the Ecole Nationale Supérieure de l’Aéronautique et de l’Espace (Toulouse, France) in 1976. He received the Ph.D. Degree in Signal Processing and Telecommunications in 1994 from the University of Rennes I (France). He is a Professor in the Image and Information Processing department of TELECOM Bretagne, a graduate engineering school and international research centre in the field of information technologies. His research interests are primarily in the field of Image analysis and Content Based Image Retrieval, especially in Medical applications, with the LATIM (Medical Information Processing Lab, INSERM U650). He is also involved in telemedicine projects. He participates actively to the biomedical engineering community’s life: member of the organizing Committee of the International IEEE EMBS International Summer Schools on Biomedical Imaging (Berder, France), in charge of the secretary of the French National Research Network for Health Technologies (RNTS) for four years, then of the Support Unit of RNTS 2005, active member of the SFGBM, the French biomedical engineering Society, and member of the Organizing Committee of the 29th International Conference of the IEEE Engineering in Medicine and Biology Society (Lyon 2007, France).

Address: ITI Dpt, TELECOM Bretagne, CS 83818 29238 Brest Cedex, France.

Web page: <http://international.telecom-bretagne.eu/welcome/>

E-mail: Guy.Cazuguel@telecom-bretagne.eu

Francis Celeste received the French diploma of engineering at the ENSIETA (Ecole Nationale Supérieure des Ingénieurs des Etudes et Techniques d'Armement) - specialized in embedded and autonomous systems - and the M.Sc. degree in signal processing and telecommunication from the University of Brest, France in 2002. In 2002, he joined the technical expertise directorate of the Délégation Générale pour l'Armement, France where he works in the field of image processing, data fusion, robotics and sensor management. He is currently prepared a Ph.D. in the field of optimization and robotics. His main interests are in optimal planning, computer vision and data & sensor fusion.

Address: Délégation Générale pour l'Armement, DGA/CEP/EORD/FAS, 16 Bis, Avenue Prieur de la Côte d'Or, Arcueil, F 94114, France.

E-mail: francis.celeste@etca.fr

Matteo Ceriotti was born near Milan, Italy, on June 15, 1980. He received the M.Sc. summa cum laude from Politecnico di Milano in 2006 with a thesis on "Non Deterministic Planning and Data Fusion with the Evidence Theory". The thesis was part of a study for planetary rover autonomy in collaboration with the European Space Agency. At present, he is a Ph.D. candidate at the Department of Aerospace Engineering of the University of Glasgow, United Kingdom. His study is focused on global optimisation for multi-gravity assist interplanetary trajectories. His research interests are space mission analysis, global optimisation, spacecraft autonomy and artificial intelligence.

Address: Department of Aerospace Engineering, University of Glasgow, James Watt South Building, G12 8QQ, Glasgow, UK.

E-mail: m.ceriotti@aero.gla.ac.uk

Béatrice Cochener is Professor and Head of the University Eye Clinic in Brest, France. Together with Joseph Colin, she developed a very active anterior segment surgery practice. She is currently involved in imaging research, clinical evaluation, and anterior segment surgery teaching. Vice president of the SAFIR, the French implant and refractive surgery society, and president of the SFO (Société Française d'Ophthalmologie), editorial board member of the Journal Français d'Ophthalmologie, she is a specialist of refractive technics in vision correction. She participated in three books on surgical techniques, and has published 32 peer reviewed journal articles.

Address: CHU de Brest Service d'Ophthalmologie, 5 avenue Foch 29609 Brest Cedex, France.

E-mail: Beatrice.Cochener-Lamard@chu-brest.fr

Frédéric Dambreville studied mathematics, logic, signal and image processing. He received the Ph.D. degree in signal processing and optimization, from the Univ. of Rennes, France, in 2001. He enjoyed a stay in California, U.S.A., and worked as a postdoctorate in the Naval Postgraduate School at Monterey in 2001/2002. In 2002, he joined the dept. image, perception and robotic of the CTA Lab, (Délégation Générale pour l'Armement), France. His main interests are in optimization, optimal

planning, game theory, simulation methods, data & sensor fusion, Markov models & Bayesian networks, logic & conditional logic. His recent works are about rare event simulation (*e.g.* cross-entropy optimization), optimal decision with partial observation, hierarchical system optimization, scheduling, modal & Bayesian logic, and evidence theories.

Address: Délégation Générale pour l'Armement, DGA/CEP/EORD/FAS, 16 Bis, Avenue Prieur de la Côte d'Or, Arcueil, F 94114, France.

Web page: <http://www.FredericDambreville.com>

E-mail: <http://email.FredericDambreville.com>

Milan Daniel was born in Prague in 1962. He graduated in the Faculty of Mathematics and Physics of Charles University Prague in 1985. He defended his Ph.D. thesis in the Institute of Computer Science of the Academy of Sciences of the Czech Republic in 1993. His research activities have been always related to the Institute, the department of Theoretical Computer Science, formerly the department of Knowledge Based Systems. Author's current main scientific interests are belief functions, namely combination of belief functions, probabilistic transformations and conflicts of belief functions. The other interests are uncertainty processing, fuzzy logic and knowledge based systems.

Address: Institute of Computer Science, Academy of Sciences of the Czech Republic, Pod vodárenskou věží 2, CZ - 182 07 Prague 8, Czech Republic.

Web page: <http://www.cs.cas.cz>, E-mail: milan.daniel@cs.cas.cz

Jean Dezert was born in l'Hay les Roses, France, on August 25, 1962. He received the electrical engineering degree from the Ecole Française de Radioélectricité Electronique and Informatique (EFREI), Paris, in 1985, the D.E.A. degree in 1986 from the University Paris VII (Jussieu), and his Ph.D. from the University Paris XI, Orsay, in 1990, all in Automatic Control and Signal Processing. During 1986-1990 he was with the Systems Department at the Office National d'Études et de Recherches Aérospatiales (ONERA), Châtillon, France, and did research in tracking. During 1991-1992, he visited the Dept. of Elec. and Syst. Eng., Univ. of Connecticut, Storrs, U.S.A. as an European Space Agency (ESA) Postdoctoral Research Fellow. During 1992-1993 he was teaching assistant in Elec. Eng. at the Univ. of Orléans, France. Since 1993, he is senior research scientist the Information, Modeling and Processing Department (DTIM) at ONERA. His current research interests include autonomous navigation, estimation and stochastic systems theory and its applications to multisensor-multitarget tracking (MS-MTT), information fusion, plausible reasoning and non-standard Logics. Dr. Jean Dezert is developing since 2001 with Prof. Smarandache a new theory of plausible and paradoxical reasoning for information fusion (DSmT) and has edited two textbooks (collected works) devoted to this new emerging research field published by American Research Press, Rehoboth in 2004 and 2006. He owns an international patent in the autonomous missile navigation and has published several papers in international conferences and journals. He serves as reviewer several International Journals and collaborates for the development of the

International Society of Information Fusion (ISIF - <http://www.isif.org>) since 1998. He has served as Local Arrangements Organizer for FUSION 2000 Int. Conf. in Paris and has been involved in the Technical Program Committees of several FUSION International Conferences. Since 2001, he is a member of the board of the ISIF and served also as executive vice-president of ISIF in 2004.

Address: Office National d'Études et de Recherches Aérospatiales (ONERA), Dépt. du Traitement de l'Information et Modélisation, BP-72, 29 Avenue de la Division Leclerc, 92322 Châtillon Cedex, France.

Web page: <http://www.gallup.unm.edu/~smarandache/DSmT.htm>

E-mail: jean.dezert@onera.fr, jdezert@gmail.com

Pascal Djiknavorian obtained a B.Eng. in Computer Engineering and a certificate in Business Administration in 2005 from Laval University. He also completed in 2008 an M.Sc. in Electrical Engineering on information fusion within the DSMT framework applied on ESM reports under STANAG 1241. He was also admitted in 2007, at the same university, for a Ph.D. also in information fusion. His research in information fusion is supervised by Prof. Dominic Grenier and Prof. Pierre Valin. Pascal Djiknavorian has 3 publications on his master's research. His research interests include evidential theory, DSMT, approximations algorithms, optimization methods, information fusion and information theory.

Address: Département de Génie Électrique et de Génie Informatique, Université Laval, Québec, QC, Canada, G1V 0A6.

E-mail: pascal@djiknavorian.com

Li Duan was born in Jiangxi, China, on October, 1976. He received the B.E. degree from Naval Electronic and Eng. College, Nanjing, China, in 1998, the M.E. degree in pattern recognition and intelligence system from Naval Univ. of Eng., Wuhan, China, in 2001. After graduation, he became a lecturer in the Dept. of command and control, Naval Univ. of Eng. Currently he is pursuing his Ph.D. degree in Dept. of Control Science and Eng., Huazhong Univ. of Science and Technology. He has worked in the areas of target tracking, neural networks and automatic target recognition. His current research interests include distributed data fusion, situation awareness and cooperative engagement.

Address: Department of Control, Sciences and Engineering, Huazhong University of Sciences and Technology, Wuhan, 430074, Hubei, China.

E-mail: duanlidragon@126.com

Samuel Foucher was born in Nantes, France, in 1969. He received the B.S. degree in physics from the University of Nantes in 1989, the telecommunication engineering degree from the Ecole Nationale des Télécommunications de Bretagne, France, and the M.S. degree in image processing from the University of Rennes, Rennes, France, in December 1996. In 2001, he received his Ph.D. degree from both Sherbrooke and Rennes Universities in Remote Sensing and Signal Processing. He is now researcher in the computer vision team of the Computer Research Institute of Montréal.

Address: Maison des hautes technologies, 550 rue Sherbrooke Ouest, Bureau 100, Montréal (Québec) H3A 1B9, Canada.

E-mail: samuel.foucher@crim.ca

Richard Fournier received in 1986 an undergraduate degree (BSc) in Physics specialized in Atmospheric physics at the Université du Québec, Montréal, Canada. He completed a Master (MSc) at York University (Canada) in Physics of Remote Sensing in 1989 and then worked for five years at the Canada Centre for Remote Sensing in Ottawa before completing his Ph.D. in Geomatics at Laval University (Canada) in 1997. He worked five years as a research scientist at the Canadian Forest Service and started in 2001 as a Professor at Department of Applied Geomatics of the Université de Sherbrooke (Canada) where he currently works.

Address: Département de géomatique appliquée, Faculté des lettres et sciences humaines, Université de Sherbrooke, 2500, boul. de l'Université, Sherbrooke J1K2R1, Québec, Canada.

E-mail: richard.fournier@usherbrooke.ca

Dominic Grenier received the M.Sc. and Ph.D. degrees in electrical engineering in 1985 and 1989, respectively, from the Université Laval, Quebec City, Canada. From 1989 to 1990, he was a Postdoctoral Fellow in the radar division of the Defense Research Establishment in Ottawa (DREO), Canada. In 1990, he joined the Department of Electrical Engineering at Université Laval where he is currently a Full Professor since 2000. He was also co-editor for the Canadian Journal on Elec. and Comp. Eng. during six years. Recognized by the undergraduate students in Elec. and Comp. Eng. at Univ. Laval as the electromagnetism and RF specialist, and in recognition for his excellence in teaching, he got the "Best Teacher Award" many times. His research interests include inverse synthetic aperture radar imaging, antenna array processing for high resolution direction of arrivals and data fusion for identification. Prof. Grenier has 24 publications in refereed journals and 59 more in conf. proceedings. In addition, to the 35 graduate students who have completed their thesis under his direction since 1992, he supervised three post-doc fellows during more than two years each. Currently Prof. Grenier supervises eight graduate students. among them, three students work directly on data fusion.

Address: Département de Génie Électrique et de Génie Informatique, Université Laval, Québec, QC, Canada, G1V 0A6.

E-mail: dominic.grenier@gel.ulaval.ca

Esteban Garcia received the BS degree in computer science from Autonomous University of Puebla in 2005, the MS degree in Computer Sciences from National Institute for Astrophysics, Optics and Electronics in Puebla, Mexico in 2007. His research interests include computer vision, computer graphics, and robotics. He is a researcher in the Computer Vision Laboratory at the National Institute for Astrophysics, Optics and Electronics in Mexico.

Address: National Institute for Astrophysics, Optics and Electronics (INAOE), Computer Sciences Department, Luis Enrique Erro No. 1, Sta Ma. Tonantzintla, Pue., CP 72760, Puebla, Pue, Mexico.

Web page: <http://ccc.inaoep.mx/en/>

E-mail: eomargr@inaoep.mx

Xinhan Huang was born in Hubei province, China, on August 21, 1946. He graduated from Huazhong University of Science and Technology (HUST), Wuhan, China in 1969. He is Faculty member of the Department of Control Science and Engineering of HUST. He joined the Robotics Institute of Carnegie-Mellon University at Pittsburgh, U.S.A. as a visiting scholar from 1985 to 1986 and the Systems Engineering Division of Wales University at Cardiff, UK as a senior visiting scholar in 1996. He is currently a Professor and Head of the Intelligent Control and Robotics Laboratory of HUST. The Chinese National Natural Science Foundation and the National High Technique Research Developing Plan award Professor Huang for his research projects from 1988 to 2008. His research interests are the areas of robotics, sensing techniques, information fusion and intelligent control. He has more than 300 research publications to his credit. Professor Huang is a senior member of Chinese Association for Artificial Intelligence (CAAI) and Chairman of the Speciality Committee of Intelligent Robotics.

Address: Department of Control, Sciences and Engineering, Huazhong University of Sciences and Technology, Wuhan, 430074, Hubei, China.

E-mail: xhhuang@mail.hust.edu.cn

Catholijn M. Jonker obtained her MSc in Computer Science from the University Utrecht in 1990 after which she obtained her PhD in Artificial Intelligence from the same university in 1994. After positions at various universities, she currently is full Professor Man-Machine Interaction with the faculty of Electrical Engineering, Mathematics and Computer Science at the Delft University of Technology. In 2005 and 2006 Prof. Catholijn Jonker was chair of the Young Academy (De Jonge Acedemie) of the Royal Netherlands Academy for Sciences (KNAW) in the Netherlands. In 2008 Catholijn Jonker was granted a prestigious national VICI innovation grant for her project called The Pocket Negotiator.

Address: Delft University of Technology, Faculty of Electrical Engineering, Mathematics and Computer Science, Man-Machine Interaction Group, 2628 CD Delft, the Netherlands.

Web page: www.mmi.tudelft.nl

E-mail: c.m.jonker@tudelft.nl

Adam Kawalec was born in Poland in 1949. He received his M.Sc. degree in solid state electronics and his Ph.D degree from the Dept. of Technical Physics, and his D.Sc. degree in electronics, acoustoelectronics from the Dept. of Electronics, Military Univ. of Tech., Warsaw, Poland in 1974, 1980, 2002, respectively. In 1974, he joined the Military Univ. of Tech., Dept. of Technical Physics, Warsaw, Poland,

where he was involved in surface acoustics waves convolvers research. Since 1979, he has tested SAW dispersive delay lines applied in radar pulse compression systems and SAW sensors. He is currently an Associate Professor of the Department of Electronics, Military University of Technology, Warsaw, Poland, where he teaches courses in acoustoelectronics and the basic of telecommunications. Professor Kawalec is a Head of the Institute of Radioelectronics, Department of Electronics, Military University of Technology, Warsaw, Poland. He is the author and co-author of more than 120 scientific papers published in international and national journals and conference proceedings and co-inventor of five patents.

Address: The Institute of Radioelectronics, WAT Military University of Technology, Warsaw, Poland.

E-mail: Adam.Kawalec@wat.edu.pl

Pavlina Dimitrova Konstantinova received her M.Sc. and Ph.D. degrees in Computers and Computer-Aided Transient and Steady State Analysis of Nonlinear Electronic Circuits from Technical University of Sofia in 1967 and 1987, respectively. From 1971 to 1989 she was research assistant at the Radio Electronics Research Institute. Since 1989 she is assistant research Professor at the Dept. of Math. Methods for Sensor Information Processing, Institute for Parallel Processing, BAS. She is a member of the Bulgarian Union of Automation and Information, member of Image Recognition Society, BAS. Her research interests include sensor data processing, data association, mathematical modeling, parallel algorithms and object-oriented programming.

Address: Institute for Parallel Processing, Bulgarian Academy of Sciences (BAS), "Acad. G. Bonchev" Str., bl.25-A, 1113 Sofia, Bulgaria.

E-mail: pavlina@bas.bg

Ksawery Krenc was born in Poland in 1975. He received his M.Sc. in Automatics and Robotics, Faculty of Electronics Telecommunication and Informatics from The Technical University of Gdansk in 2001. In 2002, he joined RD Marine Technology Centre, as a program writer. In 2004, he got promoted to the analyst position. He elaborated the specification of data collecting and data fusion applications for Leba-3 (Polish Marine C&C system). Since 2006, he has been publishing solutions related to data (and information) fusion for C&C systems' purposes. In 2007, he got promoted to the senior analyst position. Since 2007 up to now, he has been the Sensor Networks research team manager in Polish NEC consortium. He is currently working towards Ph.D. degree. His current research interests focus on information fusion for the purpose of C&C systems with a particular emphasis on DST and DSMT.

Address: RS-SD, R&D Marine Technology Centre, Gdynia, Poland.

E-mail: ksawery.krenc@ctm.gdynia.pl

Mathieu Lamard was born on may 18, 1968, in Bordeaux, France. He received the Master degree in applied mathematics from the University of Bordeaux, France (1995) and the Ph.D. Degree in Signal Processing and Telecommunication (1999) from the University of Rennes, France after 3 years of research on the ophthalmology field. In

2000 he joined the laboratory LaTIM INSERM U650 (Laboratoire de Traitement de l'Information médicale). His research interests are related to image processing, 3D reconstruction, content-based image retrieval and data fusion for medical applications. Address: CHU de Brest LaTIM Bat. 2 Bis, 5 avenue Foch 29609 Brest Cedex, France. E-mail: Mathieu.Lamard@univ-brest.fr

Xinde Li was born in Shandong province, China, on September 30, 1975. He graduated from Shenyang institute of chemistry technology, Shenyang, China in 1997 and he received his Master degree from Shandong University, Jinan, China in 2003 and his Ph.D. degree from Huazhong University of Science and Technology, Wuhan, China, in 2007. Currently, he works as a Lecturer in the School of Automation, Southeast University, China. His main research interests include information fusion, robot perception, computer vision, pattern recognition, robot's map building and localization and multi-robot system.

Address: Institute of Intelligent Robot and Intelligent Control, School of Automation, Southeast University, Si Pai Lou 2#, Nanjing 210096, China.

E-mail: xindeli@seu.edu.cn

Arnaud Martin was born in Bastia, France in 1974. He received the Ph.D. degree in Signal Processing (2001), and the Master degree in Probability (1998) from the University of Rennes, France. Dr. Arnaud Martin worked on speech recognition during three years (1998-2001) at France Telecom R&D, Lannion, France. He worked in the department of statistic and data mining (STID) of the IUT of Vannes, France, as temporary Assistant Professor (ATER) during two years (2001-2003). In 2003, he joined the laboratory E³I²: EA3876 at the ENSIETA, Brest, France, as a teacher and researcher. Dr. Arnaud Martin teaches mathematics, data fusion, data mining, signal processing and computer sciences. His research interests are mainly related to the belief functions for the classification of real data and include data fusion, data mining, signal processing especially for sonar and radar data.

Address: ENSIETA E³I² Laboratory, 2, rue François Verny, 29806 Brest Cedex 9, France.

Web page: <http://www.ensieta.fr/e3i2/Martin>

E-mail: Arnaud.Martin@ensieta.fr

Grégoire Mercier was born in France in 1971. He received the Engineer Degree from the Institut National des Télécommunications, Evry, France in 1993, his Ph.D. degree from the University of Rennes I, Rennes, France in 1999 and his Habilitation à Diriger des Recherches from the University of Rennes I in 2007. Since 1999, he has been with the Ecole Nationale Supérieure des Télécommunications de Bretagne, where he is currently an Associate Professor in the Image and Information Processing department. His research interests are in remote sensing image compression and segmentation, especially in hyperspectral and Synthetic Aperture Radar. Actually, his research is dedicated to change detection and combating pollution. He was a visiting researcher at DIBE (University of Genoa, Italy) from March to May 2006

where he developed change detection technique for heterogeneous data. He was also a visiting researcher at CNES (France) from April to June 2007 to take part of the Orfeo Toolbox development. He is an Associate Editor for the IEEE Geoscience and Remote Sensing Letters.

Address: Telecom Bretagne, CNRS UMR 3192 Lab-STICC/CID, Technopole Brest-Iroise CS 83818, 29238 Brest Cedex3, France.

Web page: <http://www.gregoire-mercier.fr>

E-mail: Gregoire.Mercier@telecom-bretagne.eu

Brice Mora was born in France in 1979. He studied Biology and Earth Sciences in Pau (Bsc) and Toulouse III (Msc). He received a Master in GIS in 2004 at the University of Rennes 2. He worked as a photo interpreter for the French National Interbranch Office for Cereals and as an engineer in some French research laboratories (CNRS). He started a Ph.D. in 2005 at the Cartel Lab. in the Université de Sherbrooke, Québec, Canada.

Address: Département de géomatique appliquée, Faculté des lettres et sciences humaines, Université de Sherbrooke, 2500, boul. de l'Université, Sherbrooke J1K2R1, Québec, Canada.

E-mail: brice.mora@usherbrooke.ca

Afzel Noore received the Ph.D. degree in electrical engineering from West Virginia University, Morgantown. He was a Digital Design Engineer with Philips, India. From 1996 to 2003, he was the Associate Dean for Academic Affairs and Special Assistant to the Dean with the College of Engineering and Mineral Resources, West Virginia University, where he is currently a Professor with the Lane Department of Computer Science and Electrical Engineering. His research has been funded by NASA, the National Science Foundation, Westinghouse, General Electric, Electric Power Research Institute, the U.S. Department of Energy, and the U.S. Department of Justice. He serves on the editorial boards of Recent Patents on Engineering and the Open Nanoscience Journal. He has over 95 publications in refereed journals, book chapters, and conferences. His research interests include computational intelligence, biometrics, software reliability modeling, machine learning, hardware description languages, and quantum computing. Dr. Noore is a member of the Phi Kappa Phi, Sigma Xi, Eta Kappa Nu, and Tau Beta Pi honor societies. He was the recipient of four best paper awards.

Address: Lane Department of CSEE, West Virginia University, Morgantown, WV 26506, U.S.A.

Webpage: www.csee.wvu.edu/~noore

E-mail: noore@csee.wvu.edu

Christophe Osswald was born in Orléans, France, in 1975. He received the Ph.D. degree in Mathematics and Computer Science (2003) from the EHESS – École des Hautes Études en Sciences Sociales – after three years of research on classification, similarity analysis and hypergraphs at the laboratory IASC of the TELECOM Bre-

tagne. He is an engineer graduated from the *École Polytechnique* (1997) and the TELECOM Bretagne (1999), and he received the Master degree in Mathematics and Computer Science applied to Social Sciences. He is a teacher and researcher at the ENSIETA in the laboratory E³I²: EA3876, Brest, France. His research interests are related to data fusion, mostly through belief functions, and also to classification, graphs and hypergraphs theory, algorithmic complexity and decision support.

Address: ENSIETA E³I² Laboratory, 2, rue François Verny, 29806 Brest Cedex 9, France.

Web page: <http://www.ensieta.fr/e3i2/>

E-mail: Christophe.Osswald@ensieta.fr

Benjamin Pannetier was born in Paris on November 30th, 1979. He received his B.Sc. in math from the University of Marne la Vallée, and his Ph.D. in Automatic Control and Signal Processing from the University of Grenoble in 2006. Since 2005, he is a research engineer at the French Aerospace Lab (ONERA). His research interests include target tracking, detection/estimation theory and data fusion for battlefield surveillance systems for the French army. He is working on a new approach for the abnormal behaviour detection.

Address: Office National d'Études et de Recherches Aérospatiales (ONERA), Information Processing and Modeling Dept., BP-72, 29 Avenue de la Division Leclerc, 92322 Châtillon Cedex, France.

Web page: <http://www.onera.fr>

E-mail: benjamin.pannetier@onera.fr

Gwénolé Quellec was born in Saint-Renan, France, on Nov. 29, 1982. He received the engineering degree in computer science and applied mathematics from the Institut Supérieur d'Informatique de Modélisation et de leurs Applications (ISIMA), Clermont-Ferrand, France, and the Master degree in image processing from the University Clermont-Ferrand II, in 2005. He received his Ph.D. in signal processing from TELECOM Bretagne, a graduate engineering school and international research center in the field of information technologies, in Brest, France, in 2008. His research interests include image processing, content-based image retrieval and data fusion for medical applications.

Address: CHU de Brest LaTIM Bat. 2 Bis, 5 Avenue Foch 29609 Brest Cedex, France.

E-mail: gwenole.quellec@telecom-bretagne.eu

Christian Roux received the Agregation degree in physics from the Ecole Normale Supérieure, Cachan, France, in 1978, and the Ph.D. degree from the Institut National Polytechnique, Grenoble, France, in 1980. He joined the Institut TELECOM, TELECOM Bretagne, Brest, France, in 1982, became an Associate Professor in 1987, and then a Professor from 1987 onwards. He has been a Visiting Professor with the Medical Image Processing Group, Department of Radiology, University of Pennsylvania during 1992–1993, and a Distinguished International Research Fellow with the Dept.

of Electrical Engineering, University of Calgary, Calgary, AB, Canada, in 1996 and 2003. He is currently the Head of the Laboratoire de Traitement de l'Information Médicale (LaTIM), INSERM U650, Brest. He is the author or coauthor of more than 100 papers, the author of four book chapters, and has edited three books. He is the holder of two patents. His current research interests include advanced medical information processing, and spatial and functional information modeling and analysis in medical images, with applications in various medical domains including orthopedics, gastroenterology, ophthalmology, and cardiology. Prof. Roux was an Associate Editor for the IEEE Transactions on Medical Imaging during 1993–2000, and is a member of the Editorial board of the IEEE Trans. on Information Technology and of the Proceedings of the IEEE.

Address: ITI Dpt, TELECOM Bretagne, CS 83818 29238 Brest Cedex, France.

Web page: <http://international.telecom-bretagne.eu/welcome/>

E-mail: Christian.Roux@telecom-bretagne.eu

Richa Singh received the M.S. and PhD degree in computer science in 2005 and 2008 respectively from the West Virginia University, Morgantown. She had been actively involved in the development of a multimodal biometric system which includes face, fingerprint, signature, and iris recognition at the Indian Institute of Technology Kanpur, India, from July 2002 to July 2004. Her current areas of interest are pattern recognition, image processing, machine learning, granular computing, biometric authentication, and data fusion. She has more than 75 publications in refereed journals, book chapters, and conferences. Dr. Singh is a member of the IEEE Computer Society and the Association for Computing Machinery. She is also a member of the Golden Key International, Phi Kappa Phi, Tau Beta Pi, Upsilon Pi Epsilon, and Eta Kappa Nu honor societies. She was the recipient of four best paper awards.

Address: Lane Department of CSEE, West Virginia University, Morgantown, WV 26506, U.S.A.

Webpage: www.csee.wvu.edu/~richas

E-mail: richas@csee.wvu.edu

Florentin Smarandache was born in Balcesti, Romania, in 1954. He got a M. Sc. Degree in both Mathematics and Computer Science from the University of Craiova in 1979, received a Ph.D. in Mathematics from the State University of Kishinev in 1997, and continued postdoctoral studies at various American Universities (New Mexico State Univ. in Las Cruces, Los Alamos National Lab.) after emigration. In 1988 he escaped from his country, pasted two years in a political refugee camp in Turkey, and in 1990 emigrated to U.S.A. In 1996 he became an American citizen. Dr. Smarandache worked as a Professor of mathematics for many years in Romania, Morocco, and United States, and between 1990-1995 as a software engineer for Honeywell, Inc., in Phoenix, Arizona. In present, he teaches mathematics at the University of New Mexico, Gallup Campus, U.S.A.. Very prolific, he is the author, co-author, and editor of 75 books, over 100 scientific notes and articles, and contributed to about 50 scientific and 100 literary journals from around the world (in mathematics, informatics,

physics, philosophy, rebus, literature, and arts). He wrote in Romanian, French, and English. Some of his work was translated into Spanish, German, Portuguese, Italian, Dutch, Arabic, Esperanto, Swedish, Farsi, Chinese. He was so attracted by contradictions that, in 1980s, he set up the "Paradoxism" avant-garde movement in literature, philosophy, art, even science, which made many advocates in the world, and it's based on excessive use of antitheses, antinomies, paradoxes in creation - making an interesting connection between mathematics, engineering, philosophy, and literature and led him to coining the neutrosophic logic, a logic generalizing the intuitionistic fuzzy logic that is able to deal with paradoxes. In mathematics there are several entries named Smarandache Functions, Sequences, Constants, and especially Paradoxes in international journals and encyclopedias. He organized the "First International Conference on Neutrosophics" at the University of New Mexico, Dec. 1-3, 2001. Small contributions he had in physics and psychology too. Much of his work is held in "The Florentin Smarandache Papers" Special Collections at the Arizona State Univ., Tempe, and Texas State Univ., Austin (U.S.A.), also in the National Archives (Rm. Vâlcea) and Romanian Literary Museum (Bucharest), and in the Musée de Bergerac (France). In 2003, he organized with Jean Dezert, the first special session devoted to plausible and paradoxical reasoning for information fusion at the Fusion 2003 Int. conf. on Information Fusion in Cairns, Australia.

Address: Dept. of Math., Univ. of New Mexico, 200 College Road, Gallup, NM 87301, U.S.A.

Web page: <http://www.gallup.unm.edu/~smarandache/>

E-mail: smarand@unm.edu

Jean-Marc Tacnet was born in Cannes, France in 1965. He received a Master Engineering Degree from *E.N.G.E.E.S* (National School for Environment and Water management of Strasbourg, France) in 1987, a Master Engineering Degree from *E.N.G.R.E.F.* (National School member of Paris Institute of Technology for Life, Food and Environmental Sciences) and a M.Sc. degree in Applied Computer Science (Grenoble University) in 2003. He has first worked as a technical engineer in charge of Water and waste water disposal engineering before joining the *Cemagref* (Institute for Agricultural and Environmental Engineering Research). In the Snow Avalanche engineering and Torrent Control research unit (E.T.N.A.), he was research engineer specialized in civil engineering applied to protection works against mountain rivers floods. He then became manager of a research group dealing with "Techniques and Strategies of protection against natural risks". Since 2003, his activities focus on integrated risk management and expertise processes. In collaboration with the *Ecole des Mines de St Etienne* and in parallel with his other professional activities such as expertise, he has started a new challenge through a Ph.D. Thesis whose subject concerns "An integrated approach of expertise and uncertainty for natural hazards in mountains".

Address: Cemagref, E.T.N.A. Research unit, 2 rue de la papétrie, B.P. 76, 38402 Saint Martin d'Hères, France.

Web page: <http://cemagref.fr>, E-mail: jean-marc.tacnet@cemagref.fr

Albena Tchamova is Associate Professor at the Department of Mathematical Methods for Sensor Information Processing, Institute for Parallel Processing, Bulgarian Academy of Sciences. She received M.Sc. degree in Microelectronics and Ph.D. degree in Radiolocation and Radionavigation (Target Attributes Identification and Classification on the base of Evidence Reasoning Theory and Fuzzy Logic) from the Technical University of Sofia, Bulgaria, in 1978 and 1998 respectively. She worked as a researcher in numerous academic and industry projects (Bulgarian and international) in the area of Multisensor Multitarget Tracking (MS-MTT) and Data Fusion. She is a member of the IEEE, member of International Society for Information Fusion (ISIF), Association of European Operational Research Societies on Fuzzy Sets (EUROFUSE), Image Recognition Society, BAS. Dr. Tchamova's current research interests include MS-MTT, Target Identification, Dezert-Smarandache Theory of Plausible and Paradoxical Reasoning, Information Fusion, Decision Making under Uncertainty.

Address: Institute for Parallel Processing, Bulgarian Academy of Sciences, "Acad. G. Bonchev" Str., bl.25-A, 1113 Sofia, Bulgaria.

E-mail: tchamova@bas.bg

Pierre Valin: After graduating from Harvard (PhD, 1980) under Nobel Laureate Sheldon Lee Glashow, Dr. Pierre Valin taught and conducted research in theoretical physics at various universities for over 12 years. He then spent over 10 years at Lockheed Martin Canada as a Senior Member of Engineering R&D. In 2004 he joined DRDC Valcartier, where he is now Group Leader for "Future C2 Concepts and Structures", and Thrust Leader for Air Command. He is also an adjunct Professor at Université Laval (and McMaster University) for the co-supervision of graduate students. His main interests are in Multi-Sensor Data Fusion requirements and design, Command and Control decision aids, use of a priori information databases, imagery classifiers and their fusion, reasoning frameworks, neural networks, fuzzy logic, SAR image processing, algorithmic benchmarking, situation, threat and intent assessment, distributed information fusion and dynamic resource management, amongst others. Dr. Valin has been involved in information fusion from its early stages and was President of the International Society of Information Fusion (ISIF) in 2006, which holds annual conferences, with the 2007 conference having been organized by DRDC Valcartier and held in Québec City.

Address: Defence R&D Canada Valcartier, 2459 Pie-XI Blvd. North, Québec, QC, Canada, G3J 1X5.

E-mail: pierre.valin@drdc-rddc.gc.ca

Willem L. van Norden obtained his MSc Media and Knowledge Engineering in 2005 with the Delft University of Technology. During his active career in the Royal Netherlands Navy he was commissioned on an Air Defense and Command frigate as a System Responsible Officer and Lt. Wilbert van Norden is now commissioned as Business Analyst at Force Vision, the centre for automation of mission-critical system of the Defense Material Organization in the Netherlands. He works in the

Planning and Decision Support department, where he focusses on sensor management concepts and automated classification support. For his MSc thesis titled *Intelligent task scheduling in sensor networks: Introducing three new scheduling methodologies* Wilbert van Norden received the best thesis award 2005 from the The Hague chapter of the Armed Forces Communications and Electronics Association (AFCEA).

Address: CAMS – Force Vision, MPC 10A, P.O. Box 10000, 1780 CA, Den Helder, the Netherlands.

Web page: www.forcevision.nl, E-mail: w.l.van.norden@forcevision.nl

Massimiliano Vasile received his Master and Ph.D. degrees from the Department of Aerospace Engineering of Politecnico di Milano, Italy, in 1996 and 2000 respectively. From 2001 to 2003 he worked as Research Fellow in the Advanced Concepts Team of the European Space Agency (ESA), on new methods for Space Mission Analysis and Design and Trajectory Optimization. From 2004 to 2005 he worked as a lecturer in Space System Engineering in the Department of Aerospace Engineering of Politecnico di Milano. From 2005 to 2008, he was a Lecturer in the Department of Aerospace Engineering, since august 2008 he is a Senior Lecturer in the same department. Since 2005 he has been Head of Research for the Space Advanced Research Team at the University of Glasgow (<http://www.aero.gla.ac.uk/Research/SpaceArt>). His main research interests are: Space Mission Analysis and Design, Global and Multi-objective Optimization, Bio-inspired Optimization Methods, Asteroids, Evolutionary Computation, Concurrent Engineering, Multidisciplinary Design, Swarm Intelligence, Formation Flying, Autonomous Robotic Systems. He is member of the IEEE, AIAA and AIRO.

Address: Department of Aerospace Engineering, University of Glasgow, James Watt South Building, G12 8QQ, Glasgow, UK.

E-mail: m.vasile@aero.gla.ac.uk

Mayank Vatsa received the M.S. and PhD degree in computer science in 2005 and 2008 respectively from the West Virginia University, Morgantown, U.S.A. He was actively involved in the development of a multimodal biometric system which includes face, fingerprint, signature, and iris recognition at the Indian Institute of Technology Kanpur, India, from July 2002 to July 2004. He has more than 75 publications in refereed journals, book chapters, and conferences. His current areas of interest are pattern recognition, image processing, uncertainty principles, biometric authentication, watermarking, and information fusion. Dr. Vatsa is a member of the IEEE Computer Society and Association for Computing Machinery. He is also a member of the Golden Key International, Phi Kappa Phi, Tau Beta Pi, Sigma Xi, Upsilon Pi Epsilon, and Eta Kappa Nu honor societies. He was the recipient of four best paper awards.

Address: Lane Department of CSEE, West Virginia University, Morgantown, WV 26506, U.S.A.

Webpage: www.csee.wvu.edu/~mayankv, E-mail: mayankv@ieee.org

List of Figures

1	Data Fusion Information Group (DFIG) Model.	iv
1.1	Venn diagram of a free DSm model for a 2D frame.	13
1.2	Venn diagram of the free DSm model for a 3D frame.	15
1.3	Venn diagram of a DSm hybrid model for a 3D frame.	20
1.4	Hybrid model for $\Theta = \{A, B, C\}$	52
1.5	Free DSm model for a 3D frame for example 9 in Chapter 3.	53
1.6	Venn Diagram for the hybrid model for this example.	67
2.1	Ordered set of labels in $[0, 1]$	76
3.1	Hybrid DSm model for example 3.8.4	120
3.2	Refined 3D frame	120
3.3	Free DSm model for a 3D frame.	128
4.1	p-PCR6 fusion versus Bayesian fusion (theoretical).	149
4.2	p-PCR6 fusion versus Bayesian fusion (theoretical).	149
4.3	p-PCR6 fusion versus Bayesian fusion (based on 10000 samples).	150
4.4	Estimated trajectories using different tracking methods.	154
4.5	Particle clouds for whitened p-PCR6 in the last curve.	155
4.6	Estimated trajectories using different tracking methods. Poor initialization: null speed and 10 units away starting position.	156
4.7	The real mobile starts at $(200, 0)$ and moves upward at constant speed $(0, 1)$; poor filters initialization.	157
4.8	The real mobile starts at $(200, 0)$ and moves upward at constant speed $(0, 1)$; <i>bad</i> filters initialization.	158
4.9	Using mean instead of p-PCR6. Red dots are the positions of the particles after fusion. The real mobile starts from $(200, 0)$ at time step 0 and moves at the constant speed $(0, 1)$	159
5.1	Hybrid model.	170
7.1	Codification for $\Theta = \{\theta_1, \theta_2, \theta_3\}$	222
7.2	Codification for $\Theta = \{\theta_1, \theta_2, \theta_3, \theta_4\}$	223
7.3	Smarandache's codification for $\Theta = \{\theta_1, \theta_2, \theta_3\}$	224
7.4	DSm cardinality $\mathcal{C}_{\mathcal{M}}(X)$, $\forall X \in D^{\Theta}$ with $ \Theta = 3$	227
7.5	DSm cardinality $\mathcal{C}_M(X)$, $\forall X \in D^{\Theta}$ with $ \Theta = 4$	228
7.6	Number of elements of D^{Θ} for $ \Theta = 5$, with the same DSm cardinality.	229
7.7	DSm cardinality $\mathcal{C}_{\mathcal{M}}(X)$, $\forall X \in D_r^{\Theta}$ with $ \Theta = 4$ and $\theta_1 \cap \theta_2 \equiv \emptyset$	230
7.8	Number of elements of D_r^{Θ} for $ \Theta = 5$ and $\theta_1 \cap \theta_2 \equiv \emptyset$, with the same positive DSm cardinality.	232
9.1	Non-distributivity.	313

9.2	Dealing with hierarchies.	315
11.1	Classification problem: not always the distance metric is the best.	350
11.2	Information evaluation basic block scheme.	350
11.3	Further insight into information evaluation.	352
11.4	Classification zones: (I) perfect classification conditions, (II) – perfect azimuth imperfect range conditions, (III) – perfect range imperfect angle conditions, (IV) imperfect classification conditions.	353
11.5	Distance metric for calculating hypotheses weights. Numerical values specify distribution distances.	355
11.6	Calculating hypotheses weights using distance metric (steps I-III).	357
11.7	Relations among threat values (UNKNOWN is specific) where $F_k \triangleq$ FAKER, $J \triangleq$ JOKER, $S \triangleq$ SUSPECT and $AF \triangleq$ ASSUMED_FRIEND.	358
11.8	Randomly generated target trajectory. Attribute information evaluation performed by a single source - Visual Sighting (VS). Target aspect problem detected.	361
11.9	The example of hypotheses weights calculation using the distance metric (steps I-III).	363
11.10	Randomly generated target trajectory. Attribute information evaluation performed by two sources: Visual Sighting (o – symbol) and Video Camera (square symbol).	365
11.11	Deterministically generated target trajectory. Attribute information evaluation performed by three sources: Visual sighting (o – symbol), Video camera (square symbol) and Radar (diamond symbol).	366
11.12	Deterministically generated target trajectory as in Fig. 11.11. For better visualization, a decluttering function has been applied.	367
11.13	Activity-oriented model. Relations among threat values.	369
11.14	Threat-oriented model. Relations among threat values.	369
12.1	System Architecture where the user interacts with the system.	377
12.2	Combined generalised belief assignments.	378
12.3	Results for $PCR6^a$ after a redistribution of conflict from \emptyset_U when conflict goes to parent elements.	381
12.4	Results for $PCR6^a$ after a proportional redistribution of conflict from \emptyset_U	381
12.5	Results for $PCR6^a$ after unproportional redistribution of conflict from \emptyset_U	382
12.6	Results for unconstrained $PCR6$ (<i>black</i>), constrained $PCR6^a$ (<i>gray</i>) and after redistribution of conflict from \emptyset_U (<i>white</i>).	383
13.1	The interest map.	393
13.2	Diagram of the procedure to create the interest map.	394
13.3	DEM of the synthetic landscape: bumped features represent rocks.	397
13.4	Visibility map superimposed on the DEM: in dark grey, surfaces that are not in sight. The camera is in the middle of the map, at a height of 40 units from the ground.	398

13.5	The resulting uncertainty map associated to the DEM.	398
13.6	Representation of the absolute value of the gradient of the DEM.	399
13.7	The infrared map.	400
13.8	The texture map.	400
13.9	The uncertainty associated to the infrared map (left) and to the texture map (right).	401
13.10	Interest map: different colors represent different values of $Bel(I)$	402
13.11	Interest map superimposed on the DEM.	403
14.1	Multitarget scenario with 25 targets.	416
14.2	Typical performance with KDA-MTT.	417
14.3	Typical performance with GDA-MTT.	417
14.4	Monte Carlo estimation of errors allong axes x and y for model 1.	420
14.5	Monte Carlo estimation of errors allong axes x and y for model 2.	420
14.6	Monte Carlo estimation of distance errors for first and second models.	421
16.1	Sequence of True Target Type (Groundtruth).	448
16.2	$DSmP(.)$ results after using DS _m H rule of combination.	449
16.3	$BetP(.)$ results after using DS _m H rule of combination.	449
16.4	$DSmP(.)$ results after using PCR5 rule of combination.	451
16.5	$BetP(.)$ results after using PCR5 rule of combination.	451
16.6	$DSmP(.)$ results after using DS rule of combination.	452
16.7	$BetP(.)$ results after using DS rule of combination.	452
17.1	Proposed match score fusion framework.	460
17.2	ROC of the proposed fusion framework with Sum rule, DS theory fusion, TBM, DS _m and PCR rule for <i>multiclassifier face verification</i>	465
17.3	ROC of the proposed fusion framework with Sum rule, DS theory fusion, TBM, DS _m and PCR rule for <i>multiclassifier fingerprint verification</i>	466
18.1	Building the frame of discernment from the compatibility graph. Hypotheses associated with cases in the same class are represented with the same color.	479
18.2	Encoding the belief mass functions.	481
18.3	Fused belief mass function: this figure represents the sets to which a non-zero belief mass has been assigned.	482
18.4	Photograph sequence of a patient's eye.	486
18.5	Mammographic image sequence of the same patient. (a) and (b) are two views of the left breast, (c) and (d) are two views of the right one.	487
18.6	Robustness with respect to missing values.	490
18.7	Matrices T_1 and T_2	497
18.8	Structure of matrix T_s . According to equation 18.17, the black cells, the dark gray cells, the light gray cells and the white cells contain the belief mass assigned to $\theta_1 \cup \theta_2$, θ_1 , θ_2 and $\theta_1 \cap \theta_2$, respectively.	497
18.9	Computation of T_2 from T_1	501

19.1	Venn diagram for the STANAG allegiances.	505
19.2	Another possible Venn diagram for the STANAG allegiances.	506
19.3	Chosen scenario.	510
19.4	DST result for the chosen scenario. Masses in function of time.	511
19.5	DSmH result for the chosen scenario.	512
19.6	PCR5 result for the chosen scenario.	512
19.7	Decision thresholds. Masses in function of time.	513
19.8	DST result after 100 Monte-Carlo runs. <i>Stanag</i> probabilities in function of time.	514
19.9	DSmH result after 100 Monte-Carlo runs. <i>Stanag</i> probabilities in function of time.	515
19.10	PCR5 result after 100 Monte-Carlo runs. <i>Stanag</i> probabilities in function of time.	515
19.11	DST result after 100 Monte-Carlo runs and input filter. <i>Stanag</i> probabilities in function of time.	516
19.12	DSmH result after 100 Monte-Carlo runs and input filter. <i>Stanag</i> probabilities in function of time.	516
19.13	PCR5 result after 100 Monte-Carlo runs and input filter. <i>Stanag</i> probabilities in function of time.	517
21.1	Flowchart of the methodology.	535
21.2	Histogram of the conflict for the best source combination.	539
21.3	Correlation circle of the Hill-Smith test on the best DST fusion parameters. The prefix "Res" means "Result", "NCom" refers to the Non commercial class and "ComD" refers to the Commercial deciduous class.	539
21.4	Evolution of the overall accuracy according to the variation of the masses for the combination with two ancillary sources.	543
21.5	Evolution of the overall accuracy according to the value of α for the combination with two ancillary sources.	544
22.1	Multi-source fusion process using the free model.	553
22.2	Multi-source fusion process using the hybrid model.	555
22.3	RGB composition of the Algiers scene, Algeria.	556
22.4	Result of multi-source fusion based on the free model. U: Urban area, V: Vegetation, BS: Bare soil.	558
22.5	Spectral signatures of the classes Urban (HRV 1997) and Vegetation (ETM+ 2001) in the invariant site of airport's runways by the free model.	558
22.6	Spectral signatures of the classes Bare soil (HRV 1997) and Vegetation (ETM+ 2001) in the variant site of the agricultural zone by the free model.	559
22.7	Binary changes image between 1997 and 2001 obtained by the free model.	560
22.8	Result of multi-source fusion based on the hybrid model.	561
22.9	Spectral signatures of the classes bare Soil (HRV 1997) and Vegetation (ETM+ 2001) in the invariant site of the airport's runway by the hybrid model.	561

22.10 Spectral signatures of the classes Bare Soil (HRV 1997) and Vegetation (ETM+ 2001) in the variant site of the agricultural zone by the hybrid model.	562
23.1 Examples of natural hazards in mountains.	566
23.2 Risk is a combination of hazard and vulnerability.	567
23.3 Expertise required during the hazard analysis step.	569
23.4 The uncertainty comes from the different steps of the expertise.	570
23.5 From primary data to processed data in the expertise process.	571
23.6 Main problematics addressed by MCDA methods [Scharlig 1985].	574
23.7 A multi-criteria hierarchical structure is broken down into unitary hierarchical components.	575
23.8 Principle of the Analytic Hierarchy Process (AHP).	576
23.9 Saaty's verbal scale for pairwise comparison.	577
23.10 Criterion-Alternative and Criterion-Estimator-Solution approaches.	577
23.11 Elements under consideration for the fusion with DST.	581
23.12 Principle of a versatile ER-MCDA.	585
23.13 The six steps of ER-MCDA framework.	587
23.14 Fuzzy number $L - R$	589
23.15 Fuzzy interval $L - R$	589
23.16 Possibility and necessity distributions.	589
23.17 From expert necessity values to bba: numerical example.	590
23.18 ER-MCDA framework - UML modeling - Main packages.	591
23.19 Principle of the AHP based ER-MCDA framework.	592
23.20 Criterion and sub-criteria codification in the hierarchical structure.	593
23.21 ER-MCDA framework - UML Class diagram - Decision hierarchical structure.	594
23.22 Modeling the common evaluation grades in a DST framework.	595
23.23 Modeling the common evaluation grades in a DS _m T framework: simplified version.	596
23.24 Mapping from quantitative criterion assessment to the common frame of discernment.	597
23.25 Quantitative criterion mapping: One totally reliable source with imprecise evaluation.	598
23.26 Quantitative criterion mapping: One partially reliable source with imprecise evaluation.	599
23.27 Quantitative criterion mapping: One partially reliable source with precise evaluation.	600
23.28 Quantitative criterion mapping: Two imprecise evaluations - Principle of area mapping calculation.	600
23.29 Quantitative criterion mapping: One partially confident source and a totally reliable source - interval 1.	601
23.30 Quantitative criterion mapping: One partially confident source and a partially reliable source - interval 2.	601

23.31	Quantitative criterion mapping: One partially confident source and a partially reliable source - Fusion	603
23.32	Mapping from qualitative criterion assessment to the common frame of discernment.	605
23.33	Frame of discernment corresponding to DST and DSMT mapping models. 606	
23.34	How far does the fusion process must follow the hierarchical decision model (case of one source)?	608
23.35	How far does the fusion process must follow the hierarchical decision model (case of several sources)?	609
23.36	Description of the implemented fusion process.	609
23.37	ER-MCDA framework - UML Class diagram - Principle of the fusion process.	610
23.38	From preference weights to discounting factors for $S = 5$ sources.	611
23.39	DST and DSMT models for importance discounting model.	612
23.40	Reliability and importance of sources (experts) c_1 and c_2	614
23.41	Comparison of discounting method: reliability–reliability and reliability–importance (DST and DSMT frameworks).	618
23.42	Decision context: ranking avalanche prone areas according hazard and vulnerability related criteria.	620
23.43	Sample simplified model of the Avalanche sensitivity framework.	621
23.44	From hierarchical model to importance discounting factor.	623
23.45	From evaluation intervals to mapped bba of intervals.	624
23.46	From mapped bba of evaluation to mapped bba of criterion $C_{[111]}$	625
23.47	Results of mapping process of criterion $C_{[111]}$	625
23.48	Two models for quantitative criterion "Living places" $C_{[112]}$	627
23.49	Qualitative criterion $C_{[112]}$ - DSMT scaling - Importance of the evaluation grade for mapping model.	628
23.50	Qualitative criterion $C_{[112]}$ - DST mapping - DSMT scaling - Evaluation intervals for sources 1 and 2.	629
23.51	Qualitative criterion $C_{[112]}$ - DST and DSMT mapping - confidence levels - source 1.	630
23.52	Quantitative criterion $C_{[121]}$ - DST mapping - Evaluation intervals for sources 1 and 2.	632
23.53	Quantitative criterion $C_{[122]}$ - DST mapping - Evaluation intervals for sources 1 and 2.	633
23.54	Quantitative criterion $C_{[123]}$ - DST mapping - Evaluation intervals for sources 1 and 2.	633
23.55	Description of the fusion processes no. 1, 3, 7 and 9.	635
23.56	Quantitative criterion $C_{[111]}$ - Fusion process no. 7 - Data structures from global identification to evaluation level.	640
23.57	Comparison of results for the fusion processes no. 1, 3, 7 and 9.	641
23.58	Root decision criterion $C_{[1]}$ - Fusion process no. 7 - Data structures for results plot.	642

23.59	The ideal ER-MCDA framework: fusion at the evaluation level, multi-criteria decision analysis for problem modeling and decision making. . . .	647
24.1	APP-6A (light version).	670
24.2	Track-oriented MHT logic flowchart with GIS.	675
24.3	Targets trajectories.	680
24.4	GMTI sensor trajectory and cumulated MTI reports.	681
24.5	UAV trajectory with video sensor ground coverage.	682
24.6	UGS positions with field of view.	683
24.7	Target's sensor illumination.	685
24.8	Track length ratio.	686
25.1	Example of vertical axis obtained by two cameras, projected on ground plane.	694
25.2	Cases considered for belief assignment.	696
25.3	Example of CGI sequences.	697
25.4	Example of real sequences from PETS.	697
25.5	Bayesian classifiers as fusion module.	698
25.6	Example of positions obtained in 3D animations. Belief value is plotted from blue to red, blue meaning low belief and red meaning 1.	701
25.7	Example of positions obtained in real sequences. Belief value is plotted from blue to red, blue meaning low belief and red meaning 1.	702

List of Tables

1.1	Correspondence between operations on subsets and on propositions. . . .	7
1.2	Cardinalities of 2^Θ , D^Θ and S^Θ	14
1.3	Inputs of the fusion with imprecise bba's.	31
1.4	Fusion result with the DS _m C rule.	32
1.5	Fusion result with DS _m H rule for \mathcal{M}	33
1.6	Quantitative inputs for example 4 in Chapter 3.	51
1.7	Results for example 4 in Chapter 3.	51
1.8	Quantitative inputs for example 8 in Chapter 3.	52
1.9	Results for example 8 in Chapter 3.	52
1.10	Quantitative inputs for example 9 in Chapter 3.	53
1.11	Results for example 9 in Chapter 3.	53
3.1	Quantitative input for example 3.7.1	96
3.2	Results for example 3.7.1.	99
3.3	Vacuous belief mass for example 3.7.2	100
3.4	Results for example 3.7.2.	101
3.5	Uniform probabilistic mass for example 3.7.3	102
3.6	Results for example 3.7.3.	102
3.7	Quantitative input for example 3.7.4	103
3.8	Results for example 3.7.4.	103
3.9	Quantitative input on the original frame Θ	104
3.10	Quantitative equivalent input on the refined frame Θ^{ref}	104
3.11	Results for example 3.7.5.	108
3.12	Quantitative input for example 3.8.1	111
3.13	Results for example 3.8.1.	114
3.14	Quantitative input for example 3.8.2	115
3.15	Results for example 3.8.2.	117
3.16	Quantitative input for example 3.8.3	118
3.17	Results for example 3.8.3.	118
3.18	Quantitative input for example 3.8.4	119
3.19	Results for example 3.8.4.	119
3.20	Quantitative input for example 3.8.5	120
3.21	Quantitative equivalent input on refined frame for example 3.8.5	121
3.22	Derivation of $BetP\{A \cap B\}$, $BetP\{A\}$, $BetP\{B\}$ and $BetP\{C\}$	121
3.23	Derivation of $BetP\{A \cup B\}$, $BetP\{A \cup C\}$ and $BetP\{B \cup C\}$	122
3.24	Results for example 3.8.5.	127
3.25	Quantitative input for example 3.8.6	127
3.26	Results for example 3.8.6.	131
4.1	Initialization data.	157
5.1	Weighting function w when $X \cap Y = \emptyset$	177

5.2	Weighting function w when $X \cap Y \neq \emptyset$	177
5.3	Weighting function w when $X \cap Y \neq \emptyset$	178
5.4	Weighting function w when $X \cap Y \neq \emptyset$	178
5.5	Weighting function w when $\bigcap_{j=1}^s Y_j = \emptyset$	180
5.6	Weighting function w when $\bigcap_{j=1}^s Y_j \neq \emptyset$	181
8.1	Precise qualitative belief assignments given by the sources.	292
8.2	Imprecise qualitative belief assignments given by the sources.	294
10.1	Relocation/redistribution of bbm $m(W)$	339
11.1	Bba calculated for each of 21 target track sample based on sensor and hypotheses information. The real target is HOSTILE.	362
11.2	Bba calculated for the chosen test sample.	364
11.3	Bba's calculated for chosen samples no. 5, 6 and 22 for Visual Sighting (VS) and Video Camera (VC).	365
11.4	Threat target models comparison.	368
12.1	Super classes in the database with their gbba's.	375
12.2	Generic classes in the database with their gbba's.	375
12.3	Specific classes in the database with their gbba's.	375
12.4	Conflict produced by each source.	378
12.5	Distributing masses at the highest hierarchical level.	380
13.1	Table for the DEM expert.	395
13.2	Table for the temperature map expert.	396
13.3	Table for the texture expert.	396
13.4	Example of conflicting bodies of evidence for two different experts.	404
13.5	Combined evidence and Belief according to DST and DS _m T, for evidence provided by the two experts in Table 13.4.	405
13.6	Values of the three maps at point (67, 20), uncertainties, and corresponding assignments made by the experts.	405
13.7	Combined evidence and Belief using the DS _m T combination rule, for bodies of evidence given in Table 13.6.	405
13.8	Re-assignment of the gbba of the paradoxical hypothesis to the uncertain hypothesis.	406
13.9	Combined evidence and Belief using the Dempster combination rule, for bodies of evidence given in Table 13.8.	406
13.10	Combined evidence and Belief using the PCR5b combination rule, for bodies of evidence given in Table 13.8.	407
14.1	$P_d = 0.995$, $CM(0.995, 0.005)$	418
14.2	Track purity with different CM for a scenario with $d = 450$ m.	419
14.3	Distance = 450 m, PCR5 algorithm.	419

15.1	Performance Evaluation of Methods for Solving Blackman's Association Problem.	435
17.1	Experimental results of fusion algorithms at 0.01% FAR.	464
18.1	Patient disease severity distribution.	484
18.2	Structured contextual information for diabetic retinopathy patients.	485
18.3	Mean precision at five for each method.	489
18.4	Computation times.	490
18.5	Qualitative comparison with other rules of combination.	502
19.1	Cardinalities for DST vs DSMT.	507
20.1	Fuzzy relation for the database definition.	523
21.1	Numerical description of each class of the stratification.	534
21.2	Bhattacharrya distance on the sample plots distributions.	534
21.3	Mass values for the drainage.	538
21.4	Mass values for the surface deposit.	538
21.5	Results of the MLA with according to the number of classes. "NCom" refers to the Non commercial class and "ComD" refers to the Commercial deciduous class.	540
21.6	Results obtained by the MLA and the FSEM.	541
21.7	Results obtained using DST framework.	541
21.8	Conflict levels for the fusion with both ancillary sources.	541
21.9	Best results obtained using DST framework and the free DSMT model.	542
22.1	Comparison between the free model and the hybrid model.	563
23.1	ER-MCDA framework - double reliability discounting of two criteria c_1 and c_2 - DST framework	615
23.2	ER-MCDA framework - double reliability discounting of two criteria c_1 and c_2 - DSMT framework	615
23.3	ER-MCDA framework - Reliability and importance discounting of two criteria c_1 and c_2 - DST framework	616
23.4	ER-MCDA framework - Reliability and importance discounting of two criteria c_1 and c_2 - DSMT framework	617
23.5	Mapped Basic belief assignment (bba)- Criterion $C_{[111]}$ - Source 1 - Evaluation 1 - Fusion process no. 1 - DST framework.	624
23.6	Criterion $C_{[111]}$ - Discounted (evaluation) sources - DST Framework - Fusion order (\oplus Criterion(\oplus Source - Evaluation)).	626
23.7	Qualitative criterion c_j - Source 1 - interval of beliefs and weighting discounting factor elicitation - DSMT scaling.	631

23.8	Decision criteria $C_{[1]}$ - Fusion Process no. 1 - Discounted basic level criteria - Discounted evaluation sources DST Framework - Fusion order ($\oplus Criterion(\oplus Source - Evaluation)$) - DST mapping - DST scaling. 636	
23.9	Decision criteria $C_{[1]}$ - Fusion Process no. 3 - Discounted basic level criteria - Discounted evaluation sources DST Framework - ($\oplus Criterion(\oplus Source - Evaluation)$) - DST mapping - DST scaling. . . 637	
23.10	Decision criteria $C_{[1]}$ - Fusion Process no. 7 - Discounted basic level criteria - Discounted evaluation sources DSMT Framework - Fusion order ($\oplus Criterion(\oplus Source - Evaluation)$) -DSMT mapping - DST scaling. 638	
23.11	Decision criteria $C_{[1]}$ - Fusion Process no. 9 - Discounted basic level criteria - Discounted evaluation sources DSMT Framework - ($\oplus Criterion(\oplus Source - Evaluation)$) - DSMT mapping - DST scaling. . 639	
24.1	Tracking results (VSIMMC without PCR5).	687
24.2	Tracking results (VSIMMC and PCR5).	688
25.1	Results on CGI animations.	700
25.2	Results on real sequences.	700

Index

- CuzzP* (Cuzzolin's intersection probability), 89
- G^\ominus , 14, 20, 21, 91
- 1-tuple label, 76, 280
- 1-tuple linguistic model, 280
- 2-tuple label, 83, 282–285, 287, 290
- 2-tuple linguistic model, 282
- AEKF (Alternative Extended Kalman Filter), 667
- AHP (Analytical Hierarchy Process), 565, 573, 575, 576, 578, 583, 585, 587, 591, 606, 610, 622, 643, 644
- AIL (Auto-Indenting Labels), 307
- alabras, 319, 321
- anti-chain, 304
- Appriou's model, 551, 553, 554
- ARMSE (Averaged Root Mean Square Error), 685–687
- assignment problem, 413
- averaging rule, 191, 199
- BAP (Blackman's Association Problem), 426, 427, 433, 435
- Bayesian fusion, 147
- bba, 6, 20, 139, 189, 218, 278, 301, 430, 439, 458, 596
- BCR17, 64
- belief assignment, 20, 218, 278, 480, 481, 483
- belief conditioning rule (BCR), 62, 63, 323–326, 329, 331, 334, 376
- belief function, 20, 189, 220, 301, 391, 430, 477
- BetP, 46, 86, 442, 461
- binary clustering systems, 316
- binary pattern, 462, 463
- Boolean algebra, 12, 186–188
- bounded lattice, 188
- C&C (Command and Control), 348, 350
- canonical form, 7
- CBIR (Content-Based Image Retrieval), 474
- CBR (Case-Based Reasoning), 472, 473, 491
- CGI (computer-generated-imagery), 691, 692, 697, 699
- classic DSm rule, 21, 278
- classification space, 374
- closed world, 301
- CMKF (Converted Measurement Kalman Filter), 412
- codification, 221
- compatibility graph, 478, 479
- complement, 12, 161, 162
- conditional arbitrament, 192, 196
- conjunctive operator, 302
- conjunctive rule, 172, 190, 225
- CRSC (Class of Redistribution rules to Subsets or Complements), 43, 167, 169
- data association, 412
- DDSM (Digital Database for Screening Mammography), 483, 487–489, 491, 492
- Dedekind's lattice, 9, 278
- DEM (Digital Elevation Map), 392, 395–397, 399, 401, 402, 404, 409, 533
- Dempster's rule, 27, 190, 197, 218
- Dempster's rule of conditioning (DRC), 328, 332, 333, 337, 338, 340
- disjunctive operator, 302
- disjunctive rule, 172, 190, 197, 225
- distributive lattice, 188
- DRD (Diabetic Retinopathy Database), 483, 488, 489, 491, 492
- DSm cardinality, 46, 220, 227, 228, 230
- DSmC, 21, 430, 532

- DSmH, 28, 30, 279, 438, 440, 441, 448, 507, 510, 511, 514, 515, 693, 703
- DSmP, 48, 50, 85, 91, 92, 437, 444
- DTED (Digital Terrain Elevation Data), 663
- Dubois and Prade's rule, 28, 172, 190, 198, 303
- ELECTRE, 573, 647
- ER-MCDA (Evidential Reasoning MCDA), 565, 572, 582, 584, 585, 588, 591, 612, 613, 643–645, 647, 650
- ESM (Electronic Support Measures), 503, 504, 506, 509, 511, 514, 517
- FAR (False Alarm Rate), 463, 699
- field, 321
- fingerprint, 462–464, 466
- FLARL, 132, 277, 295
- FLARL (Field and Linear Algebra of Refined Labels), 55, 56, 66, 76, 77, 305
- focal element, 218, 224, 301
- focal set, 301
- free DSm model, 18, 53, 103, 127, 278, 324, 326, 328, 330, 333–338, 342, 429, 693
- Gabor transform, 462
- GAR (Genuine Accept Rate), 463
- gbba, 20, 391
- GDA-MTT (Generalized Data Association Multiple Target Tracker), 411, 413, 414, 421
- generalized belief functions, 20, 332, 335, 339
- generalized data association, 411
- generalized pignistic transformation, 45, 86, 220
- generic notation, 14, 20
- GIS (Geographic Information System), 663, 675
- GMTI (Ground Moving Target Indicator), 661, 662, 664, 667, 681, 684, 687
- GNN (Global Nearest Neighbor), 413
- GPT, 45, 46, 220
- hierarchies, 314
- HPSD (Hyper-Power Set Decomposition), 62, 63
- hybrid DSm model, 19, 52, 119, 429, 693
- hybrid DSm rule, 22, 28, 693
- hyper-power set, 9, 162, 219, 230, 278, 301, 324, 332, 390, 429, 693
- IBS (Interval-valued Belief Structure), 284
- IMINT (IMagery INTelligence), 661, 662, 669, 687, 688
- IMM (Interacting Multiple Models), 412
- importance discounting factor, 613
- imprecise 2-tuple label, 285–287
- imprecise 2-tuple linguistic model, 284
- imprecise bba, 30
- imprecise belief, 29
- imprecise labels, 83
- imprecise PCR5, 38
- imprecise qualitative belief, 294
- imprecise qualitative DSmC, 290
- information retrieval, 473
- interval arithmetic, 310
- interval masses, 310
- interval of labels, 83
- Jacobi identity, 81
- KDA-MTT, 411
- Landsat image, 549, 551
- lattice, 186, 187, 304, 320
- lattice labels, 309
- likelihood ratio, 413, 414
- linguistic label, 54, 58, 67
- logical refinement, 14

- Möbius transform, 218
- Mahalanobis distance, 412, 462
- Match score fusion, 460
- MAUT (Multi-Attribute Utility Theory), 573, 578, 583
- MAVT (Multi-Attribute Value Theory), 573, 578
- Max-Min algebra, 306
- MCDA (Multi-Criteria Decision Analysis), 565, 571–574, 578, 579, 582, 585, 587, 594, 613, 622, 643–645, 648
- mean membership, 475
- mean operator, 302
- MGT (Multiple Ground Targets), 661, 662
- mixed operators, 81
- MLA (Maximum Likelihood Algorithm), 529, 530, 534–537, 541, 545
- multiple cameras fusion, 691, 694
- non-dogmatic mass, 218
- OOSM (Out-Of-Sequence Measurements), 677, 687
- open world, 301
- order, 319
- ordered set, 311
- ordinary label, 76
- p-PCR6, 137, 139, 142–144, 146, 147, 150, 152–154, 158, 159
- partial order, 319
- partitions, 313
- PCR, 33, 34, 495, 499
- PCR \sharp , 203, 206
- PCR5, 34, 139, 142, 173, 279, 281, 303, 406, 421, 426, 430–432, 434, 440, 441, 450, 459, 464–466, 510, 511, 514, 515, 552, 677, 678, 686–688, 703
- PCR6, 34, 137–143, 147, 150, 173, 191, 200, 203, 225, 303, 371–373, 376, 378–380, 382, 384
- PIC, 49, 86, 91, 96
- PIC (Probabilistic Information Content), 49, 443
- pignistic probability, 86, 87, 414, 477
- plausibility function, 20, 189, 301, 391, 477
- plausibility function, 220, 430
- poset, 319
- power set, 7, 162
- Probabilistic Information Content, 96
- PROMETHEE, 573
- Proportional Conflict Redistribution, 33
- PURR (Partially Uniform Redistribution Rule), 41
- qBCR17, 66, 67
- qualitative belief, 54–57, 76, 280, 287
- qualitative belief conditioning rule (qBCR), 66
- qualitative Conjunctive Rule, 56
- qualitative Dempster's rule, 289
- qualitative DS m C, 56, 288
- qualitative DS m H, 57
- qualitative DS m P, 60, 131, 133
- qualitative mass, 57, 280
- qualitative operators, 54, 77, 280
- qualitative PCR5, 288
- qualitative PCR5 rule, 58
- qualitative PIC, 61, 132, 133
- referee function, 185, 186, 191–193, 195–200, 202, 203, 205, 207, 213
- refined label, 77
- refinement, 12, 14, 15, 17, 162
- rejection case, 192
- reliability, 172, 176, 180
- ring, 320
- ring structure, 306
- RSC (Redistribution rules to Subsets or Complements), 162–166
- SAIL (Soft Auto-Indenting Labels), 308
- sampling, 146, 186, 195, 196, 200, 208
- SB-MHT (Structured Branching - Multiple Hypotheses Tracking),

- 661, 662, 674, 675, 677, 680, 685, 687, 688
- semantic assertions, 316
- semi-ring, 320
- Shafer's conditioning rule (SCR), 62
- Shafer's model, 11, 18, 51, 96, 100, 102, 103, 111, 114, 118
- Shannon entropy, 49, 95
- Smarandache's codification, 16, 223, 224, 231
- Smets' rule, 27
- specificity, 228
- SPOT image, 533, 538, 541, 549, 551, 556
- SPRT (Sequential Probability Ratio Test), 674, 676
- ST (Similarity to Truth), 699
- STANAG, 503–505, 508, 517, 668, 677, 688
- super-power set, 12, 162, 168, 301
- symbolic translation, 283

- T-conorm, 431, 435, 520
- T-norm, 431, 432, 435, 520
- TBM (Transferable Belief Model), 29, 40, 457, 458, 463, 464
- TCF (Topographic Coordinate Frame), 663, 667, 669, 684
- TCN fusion rule, 431, 520, 521, 524
- TNSM (Total Non Specific Mass), 89
- track filtering, 412
- TRDR (Tracker Detection Rate), 699
- TTA150, 309
- TTT (Target Type Tracking), 437, 438, 441, 445, 677–679, 688

- UAV (Unmanned Aerial Vehicle), 669, 681, 684
- UGS (Unattended Ground Sensor), 669, 681, 684
- URR (Uniform Redistribution Rule), 41

- vacuous belief function, 325
- vector space, 321

- Venn diagram, 13, 15, 67, 120, 128, 170, 223
- VS-IMM (Variable Structure Interacting Multiple Model), 661, 662, 673
- VS-IMMC (VS-IMM Constrained), 662, 667, 674, 677, 680, 685, 688

- whitened p-PCR6, 151–154, 156, 158, 159

- Yager's rule, 27
- Yamada's rule, 168

- Zadeh's example, 25, 39

This volume has about 760 pages, split into 25 chapters, from 41 contributors. First part of this book presents advances of Dezert-Smarandache Theory (DSmT) which is becoming one of the most comprehensive and flexible fusion theory based on belief functions. It can work in all fusion spaces: power set, hyper-power set, and super-power set, and has various fusion and conditioning rules that can be applied depending on each application. Some new generalized rules are introduced in this volume with codes for implementing some of them. For the qualitative fusion, the DSm Field and Linear Algebra of Refined Label (FLARL) is proposed which can convert any numerical fusion rule to a qualitative fusion rule. When one needs to work on a refined frame of discernment, the refinement can be done using Smarandache's algebraic codification. New interpretations and implementations of the fusion rules based on sampling techniques and referee functions are proposed, including the probabilistic proportional conflict redistribution rule. A new probabilistic transformation of mass of belief is also presented which outperforms the classical pignistic transformation in term of probabilistic information content. The second part of the book presents applications of DSmT in target tracking, in satellite image fusion, in snow-avalanche risk assessment, in multi-biometric match score fusion, in assessment of an attribute information retrieved based on the sensor data or human originated information, in sensor management, in automatic goal allocation for a planetary rover, in computer-aided medical diagnosis, in multiple camera fusion for tracking objects on ground plane, in object identification, in fusion of Electronic Support Measures allegiance reports, in map regenerating forest stands, etc.

