



**HAL**  
open science

## A review of energy storage technologie sfor marine current energy systems

Zhibin Zhou, Mohamed Benbouzid, Jean-Frederic Charpentier, Franck Sculler, Tianhao Tang

### ► To cite this version:

Zhibin Zhou, Mohamed Benbouzid, Jean-Frederic Charpentier, Franck Sculler, Tianhao Tang. A review of energy storage technologie sfor marine current energy systems. Renewable and Sustainable Energy Reviews, 2013, 18, pp.390-400. hal-01073025

**HAL Id: hal-01073025**

**<https://hal.science/hal-01073025>**

Submitted on 8 Oct 2014

**HAL** is a multi-disciplinary open access archive for the deposit and dissemination of scientific research documents, whether they are published or not. The documents may come from teaching and research institutions in France or abroad, or from public or private research centers.

L'archive ouverte pluridisciplinaire **HAL**, est destinée au dépôt et à la diffusion de documents scientifiques de niveau recherche, publiés ou non, émanant des établissements d'enseignement et de recherche français ou étrangers, des laboratoires publics ou privés.

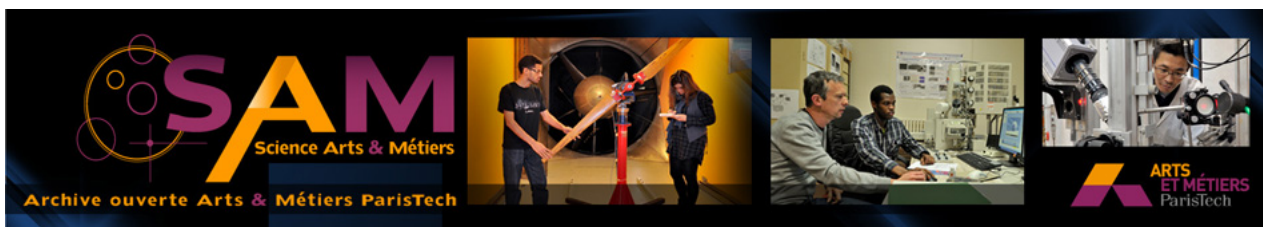

## Science Arts & Métiers (SAM)

is an open access repository that collects the work of Arts et Métiers ParisTech researchers and makes it freely available over the web where possible.

This is an author-deposited version published in: <http://sam.ensam.eu>  
Handle ID: <http://hdl.handle.net/10985/8703>

### To cite this version :

Zhibin ZHOU, Mohamed BENBOUZID, Jean-Frederic CHARPENTIER, Franck SCUILLER, Tianhao TANG - A review of energy storage technologie sfor marine current energy systems - Renewable and Sustainable Energy Reviews - Vol. 18, p.390-400 - 2013

Any correspondence concerning this service should be sent to the repository

Administrator : [archiveouverte@ensam.eu](mailto:archiveouverte@ensam.eu)



## A Review of Energy Storage Technologies for Marine Current Energy Systems

Z. Zhou<sup>a,b,c</sup>, M.E.H. Benbouzid<sup>a,\*</sup>, J.F. Charpentier<sup>b</sup>, F.Scuiller<sup>b</sup>, T.Tang<sup>c</sup>

<sup>a</sup>University of Brest, EA 4325 LBMS, 29238 Brest Cedex 03, France

<sup>b</sup>French Naval Academy, EA 3634 IRENav, 29240 Brest Cedex 9, France

<sup>c</sup>Logistics Engineering College, Shanghai Maritime University, 201306 Shanghai, China

### Abstract

Increasing concerns about the depletion of fossil resources and the issue of environment lead to a global need for producing more clean energy from renewable sources. Ocean is appreciated as a vast source of renewable energies. Considering marine renewable energies, it can be noticed that significant electrical power can be extracted from marine tidal currents. However, the power harnessed from marine tidal currents is highly fluctuant due to the swell effect and the periodicity of the tidal phenomenon. To improve the power quality and make the marine generation system more reliable, energy storage systems can play a crucial role. In this paper, an overview and the state of art of energy storage technologies are presented. Characteristics of various energy storage technologies are analyzed and compared for this particular application. The comparison shows that high-energy batteries like sodium-sulphur battery and flow battery are favorable for smoothing the long-period power fluctuation due to the tide phenomenon while supercapacitor and flywheel are more suitable for eliminating short-period power disturbances due to swell or turbulence phenomena. This means that hybrid storage technologies are needed for achieving optimal results in tidal marine current energy applications.

*Keywords:* Energy storage; Marine current energy; Power fluctuation; Battery; Flywheel; Supercapacitor

## 1. Introduction

More and more renewable energies are required for reducing pollution, carbon dioxides emission, and the fossil energy part in global energy production. Huge quantities of renewable energies can be extracted from oceans. These energies can be classified into various categories such as marine tidal current energy, wave energy, ocean thermal energy, salinity osmotic energy and marine biomass energy. Considering technology availability and economics, marine current energy might become the most promising candidate for some particular sites.

One of the main advantages of marine current energy is related to the predictability of the resource. Exploitable marine currents are mostly driven by the tidal phenomenon, which cause seawater motion twice each day with a period of approximately 12 h and 24 min (a semidiurnal tide), or once each day in about 24 h and 48 min (a diurnal tide). The astronomic nature of tides makes marine tidal currents highly predictable with 98% accuracy for decades [1]. Marine current energy is in first order independent of season and weather conditions which would affect and deteriorate the performances of solar and wind power generation. This characteristic is favorable for integration marine current energy into power grid. Harnessing marine current energy is based on the conversion of a fluid motion into electricity power. In first approach it is supposed that similar technologies used in wind power application can be transferred for marine current energy applications. However these well known technologies are not always adapted to the particularly severe underwater maritime environment constraint. This is why various original horizontal axis and vertical axis marine current turbines have been developed around the world [2].

The main challenge for marine current energy system is power fluctuation phenomenon both on short-time and long-time scales. Integration variable and fluctuating renewable sources to power grid increase the difficulty of stabilizing the power network and balancing the supply and demand. Energy storage system (ESS) is assumed to be a good solution to smooth the power fluctuations, improve the system reliability and provide auxiliary services to the grid such as frequency regulation, energy shifting and load leveling [7,18]. In this work, an overview on state of art of the most important energy storage technologies is carried out. The ideal application environment and storage scale for each technology can be quite different due to their

particular specification. Basic understanding of each ESS technology and comparisons among different ESSs can help to make a better choice for marine current energy application.

In Section 2, the two kinds of power fluctuation phenomenon in marine current energy system are described. In Section 3, battery storage technologies including conventional batteries and high-energy batteries (NaS and flow batteries) are presented and compared. In Section 4, flywheel technologies are illustrated and in Section 5, supercapacitor technologies are discussed. In Section 6, pumped hydro and compressed air energy storage technologies are presented. Applications for energy storage technologies are summarized and the conclusions are given in Section 7.

## 2. Power fluctuations in marine current energy system

To facilitate grid integration and to optimize the economical efficiency of marine current energy systems, one challenge is to minimize fluctuations in the power extracted by Marine Current Turbines (MCTs). The power harnessed by a horizontal marine current turbine can be calculated by the following equation,

$$P = \frac{1}{2} \rho C_p \pi R^2 V^3 \quad (1)$$

In this equation, sea water density  $\rho$  and turbine radius  $R$  are considered as constants;  $V$  represents the total marine current speed (including tidal current speed and swell-induced current speed);  $C_p$  is the power capture coefficient and is related to the tip top speed ratio and the marine current speed when the blade pitch angle is fixed. For typical MCTs,  $C_p$  is estimated to be in the range of 0.35-0.5 [2,3]. When a Maximal Power Point Tracking (MPPT) strategy is used, the turbine rotor speed is able to be controlled to keep  $C_p$  at its optimal value. That means in first order, the power produced by the MCT is proportional to the cubic of current speed in the turbine cross section. It can be obviously seen from Eq. (1) that the power produced by a MCT would fluctuate severely when there are fluctuations in the marine current speed.

Two main kinds of power fluctuations can be identified: on a large time scale the generated power fluctuates with a period of 6 or 12 hours which is related to tidal astronomical phenomenon; on a small time scale it can fluctuate with a period of a few seconds. These short-time fluctuations characterize long wavelength swells which are

considered as the main disturbance for the marine current speed. High potential sites for marine current systems are often shallow water sites with typical sea depth about 30-50 meters, therefore the marine current speed fluctuation caused by underwater propagation of swell is not negligible.

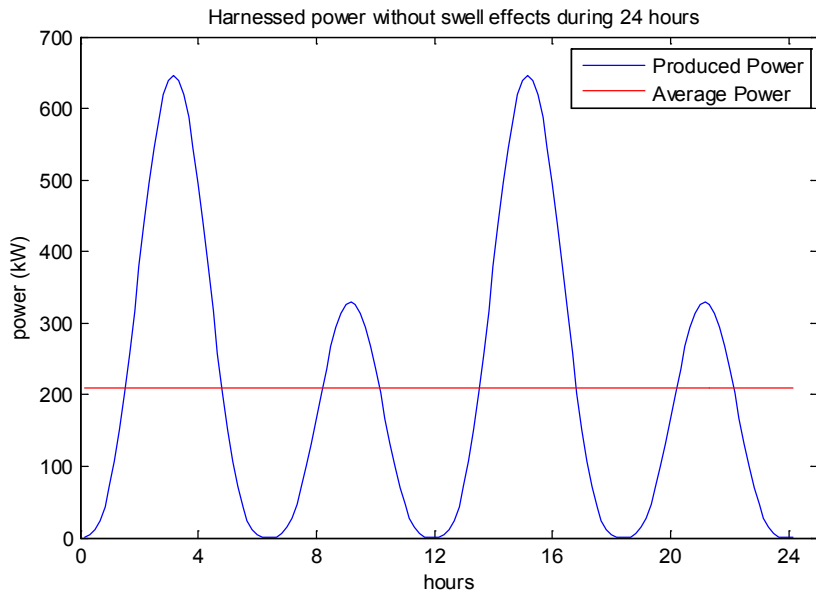

(a)

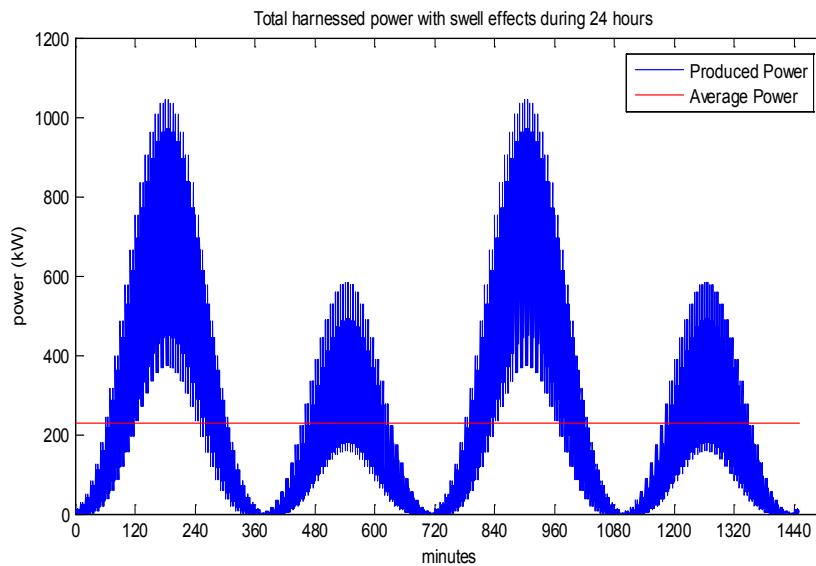

(b)

Fig. 1. Power produced by a MCT: (a) without swell, (b) with swell.

Fig. 1 gives an example of the power produced by a MCT for one day period. This simulation is based on the tidal data provided by the SHOM (French Navy

Hydrographic and Oceanographic Service, Brest, France) for a specific site. In the simulation, the  $C_p$  is set at 0.4 and the radius of the MCT is 8 meters. Fig.1a (not considering swell effect) shows the long-time power variation caused by tidal astronomic nature, which are highly predictable on hourly periods for one given site. Fig. 1b shows the power profile when considering swell effect, which introduces short-time (high frequency) fluctuations in the power profile and makes the power far away from the prediction.

Underwater propagation of the swell is the main disturbance for marine current speed and the main cause of the short-time fluctuations in a MCT. This is the reason why the swell effect should be considered in modeling the marine current speed, Fig. 2 illustrates the swell characteristics including swell length  $L$ , swell height  $H$  and sea depth  $d$ .

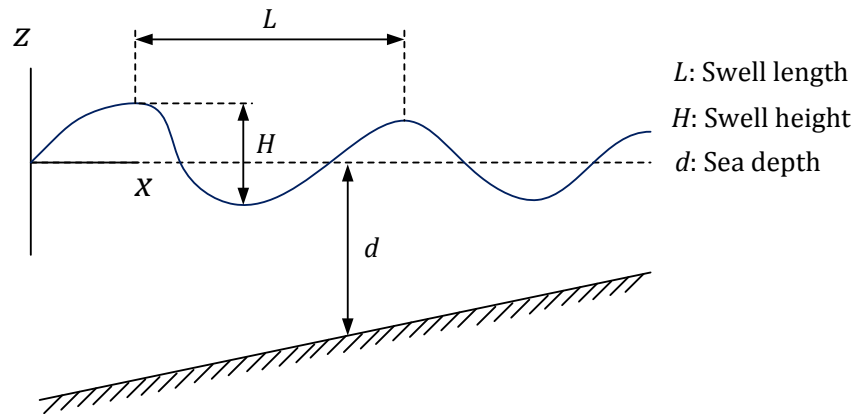

Fig. 2. Swell characteristic.

Another important parameter for swell is the swell period  $T$ , which can be calculated from the dispersion relation,

$$L = \frac{gT^2}{2\pi} \tanh\left(2\pi \frac{d}{L}\right) \quad (2)$$

Additional swell effects on the marine current speed can be estimated in first order by Stokes model [4,5]. Considering this model, the horizontal speed (which is in the  $x$ -axis direction of Fig. 2) can be calculated using Eq. (3) and Eq. (4),

$$V_x(t) = \frac{\pi H}{T} \frac{\cosh\left(2\pi \frac{z+d}{L}\right)}{\sinh\left(2\pi \frac{d}{L}\right)} \cos 2\pi \left(\frac{t}{T} - \frac{x}{L}\right) \quad (3)$$

$$V_x(t) = \frac{\pi H}{T} \frac{\cosh\left(2\pi \frac{z+d}{L}\right)}{\sinh\left(2\pi \frac{d}{L}\right)} \cos 2\pi \left(\frac{t}{T} - \frac{x}{L}\right) - \frac{3(\pi H)^2}{4TL} \frac{\cosh\left(4\pi \frac{z+d}{L}\right)}{\sinh^4\left(2\pi \frac{d}{L}\right)} \cos 4\pi \left(\frac{t}{T} - \frac{x}{L}\right) \quad (4)$$

These two equations give the swell induced current speed calculated from first-order Stokes model (Eq. (3)) and second-order Stokes models (Eq. (4)) respectively. The first-order model is suitable for deep sea and small height swell ( $H/gT^2 \leq 0.001$  and  $H/d \leq 0.03$ ), the second-order model is suitable for larger height and less depth ( $H/gT^2 \leq 0.009$  and  $H/d \leq 0.2$ ). The second-order model has a wider application range than the first-order and satisfies the marine current application when considering a big swell effect. But we should notice that in Eq. (4) the first term is exactly the first-order model and the second term can be seen as the second-order harmonics of the first-order model. The ratio of maximum values between the second term and the first term in Eq. (4) is illustrated in Fig. 3, and it shows that the second term becomes important only when  $d/L$  is very small.

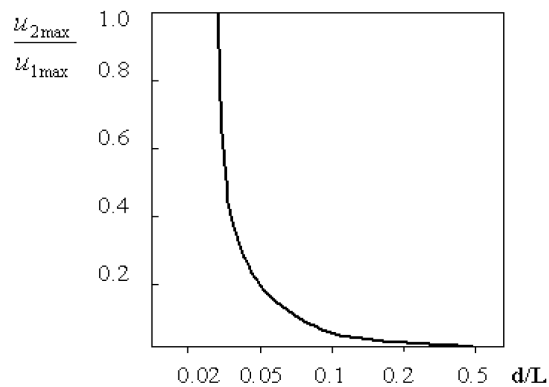

Fig. 3. The ratio of maximum values between the second term and the first term in the second-order Stokes model [5].

Considering that the typical sea depth for marine current application is about 30-50m and that the swell length is about 150-250m, the smallest  $d/L$  is 0.12 which corresponds a ratio about 0.05 between the magnitudes of the second term and the first term in Eq. (4). That means in this case the difference between the first-order Stokes



model and the second-order Stokes model is negligible. Therefore, we can use the first-order Stokes model for the calculation of the speed turbulence caused by swell effect for a marine current turbine.

In Eq. (3), only one frequency component is considered (sinusoidal swell). It is more realistic to consider more frequency components for modeling swell effects. Various wave spectrums have been established based on wave records from different oceans [6]. JONSWAP spectrum has the equivalent peak values with swell and can be applied to model the swell spectrum. JONSWAP spectrum function can be written as the following form,

$$S(f) = \beta_j \frac{H_s^2}{T_p^4} \frac{1}{f^5} \exp\left(-\frac{4}{5} \frac{1}{T_p^4} \frac{1}{f^5}\right) \gamma^Y \quad (5)$$

where, 
$$\beta_j = \frac{0.0624(1.094 - 0.0195 \ln \gamma)}{0.23 + 0.0336\gamma - 0.185(1.9 + \gamma)}$$

$$Y = \exp\left[-\frac{(T_p f - 1)^2}{2\sigma^2}\right] \quad \text{with } \sigma = \begin{cases} 0.07, & f \leq 1/T_p \\ 0.09, & f \geq 1/T_p \end{cases}$$

$$\gamma = 3 \sim 10 \text{ (for swell)}$$

From wave theories, the significant height  $H_s$  (or written as  $H_{1/3}$ ) is defined as the average height of the highest one-third waves. The significant period  $T_s$  (or written as  $T_{1/3}$ ) is defined as the average period of these highest one-third waves. These values can be calculated from wave records and have a relationship with average values about:  $H_s = 1.6\bar{H}$  and  $T_s \approx 1.2\bar{T}$ . The peak period  $T_p$  is lightly larger than the significant period and can be estimated as  $T_p \approx 1.1T_s$ .

Swells refer to waves which have propagated over a very long distance after their generating area. This character enables swells to accumulate more energy and have more concentrated frequency components than local wind-generated waves; it also explains the narrow and sharp energy spectrum shown in Fig.4. On the other hand, wind waves have much shorter wavelength than swells. It can also be verified from Stokes model that wind waves (short-length waves) only have a very small influence on the underwater current speed.

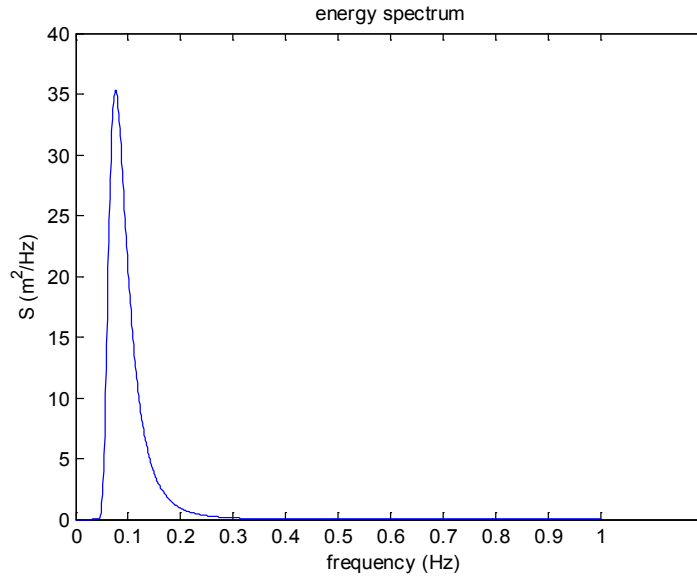

Fig. 4. Swell energy spectrum based on Eq. (5).

The swell energy spectrum curve  $S(f)$  shown in Fig.4 is calculated for a sea state of  $H_s = 3\text{m}$ ,  $T_p = 13.2\text{s}$  ( $\gamma = 7$  is chosen in Eq. (5)). Swells have a very narrow range of frequencies, therefore only a few frequencies need to be selected. The corresponding amplitude of each selected frequency components can be calculated by  $a_i = \sqrt{2S(f_i) \cdot \Delta f_i}$ . Supposing the basic tidal speed without swell is 2 m/s (this speed can be considered as constant during half hour), the following equation can be used to calculate the marine current speed under swell effects,

$$V(t) = 2 + \sum_i \frac{2\pi a_i}{T_i} \frac{\cosh\left(2\pi \frac{z+d}{L_i}\right)}{\sinh\left(2\pi \frac{d}{L_i}\right)} \cos 2\pi \left( \frac{t}{T_i} - \frac{x}{L_i} + \varphi_i \right) \quad (6)$$

Fig. 5 shows the simulation results for the marine current speed under swell effect during 10 minutes, and Fig.6 illustrates the corresponding power harnessed by a marine current turbine with a radius of 8m and power rating of 1.5 MW.

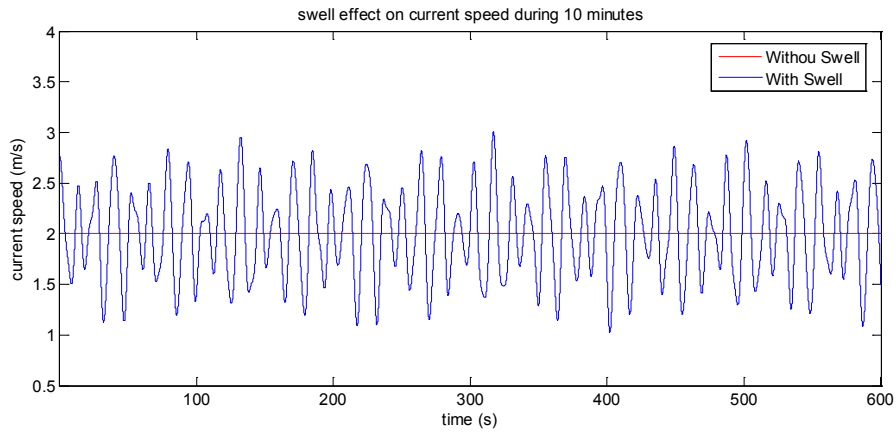

Fig. 5. Current speed with swell effect.

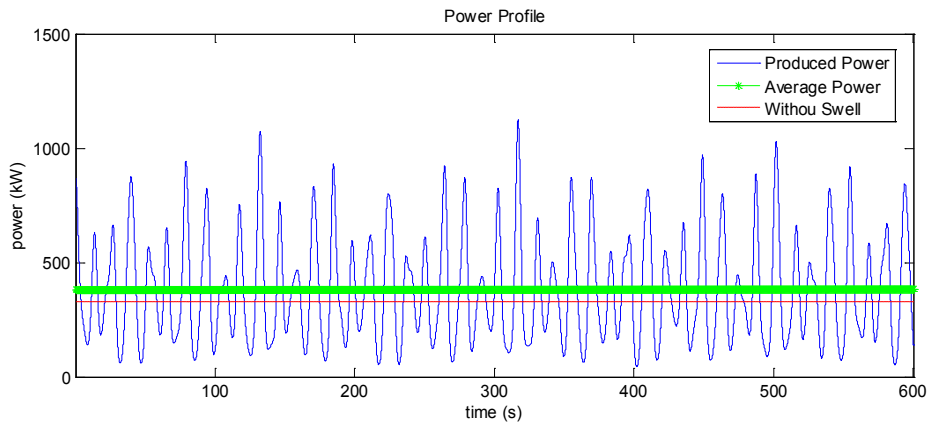

Fig. 6. Power profile of a marine current turbine.

Fig. 1 and Fig. 6 illustrate respectively the long-period and the short-period fluctuating power produced by such a MCT. Based on the power profiles we can do primary requirement estimations for energy storage system (ESS). For absorbing and eliminating power fluctuations, the power in the ESS is equal to the difference between the produced power by the turbine and the output grid power (supposed to be the average power), and the energy in the ESS (with initial value of zero) can be calculated by as:

$$E_{\text{ESS}}(t) = \int_0^t P_{\text{ESS}}(t) dt = \int_0^t [P_{\text{turbine}}(t) - P_{\text{grid}}(t)] dt \quad (7)$$

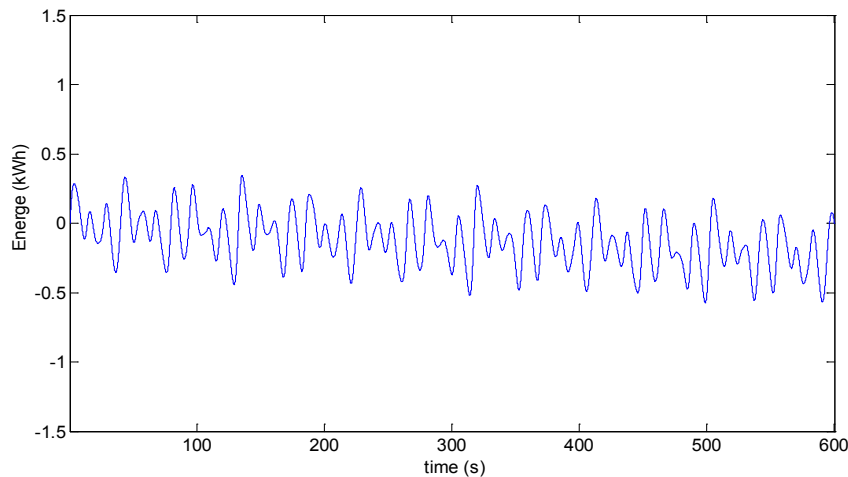

Fig. 7. Energy profile of the ESS.

Fig. 7 shows the energy changing profile of ESS which allows to eliminate the short-time power fluctuation phenomenon (Fig. 6) caused by swell effect. In the same way, the energy curve of ESS for smooth long-time power fluctuation can also be obtained.

The difference between the maximum and minimum value in the energy profile can serve as the energy rating estimation for the ESS. The largest difference between the produced power and the grid power can be considered as the power rating of the ESS. Considering this method, the ESS for smoothing long-time power fluctuation (Fig. 1a) can be estimated with a power rating about 500kW and energy rating about 800kWh. The ESS for eliminating short-time power fluctuation (Fig. 6) is estimated to have a power rating about 700kW and an energy capacity about 1 kWh (It should be noticed that this is a primary estimation which is based on a basic tidal speed of 2 m/s, and the state of charge range limitation of ESS is not considered.) From a more practical view, an energy rating over 1.5 kWh is required for smoothing the short-time power fluctuation.

Another point should be noticed is that the expected charge/discharge times of energy storage systems are quite different: about 4~6 hours for long-time fluctuations and 5~20 seconds for short-time fluctuations. It implies that about 800 cycles and  $2 \times 10^6$  cycles are needed for smoothing long-time and short-time power fluctuations respectively on one year operation.

These basic estimations show that different energy storage systems should be applied to smooth the two different kinds of power fluctuations in a marine current turbine. For slow power variation related to tidal astronomical character, long-duration and high energy capacity ESS is expected. But for fast power fluctuation caused by swell effect, high power, quick charge/discharge ESS with long cycle life is required.

### **3. Battery storage technologies**

Battery is a classical solution for storing electricity in the form of chemical energy. Battery storage technologies presented in this paper refer to rechargeable batteries which can be used as energy storage sources. A battery consists of one cell or multiple cells connected in series or in parallel depending on the desired output voltage and capacity. Each battery cell comprises the cathode (positive electrode), the anode (negative electrode) and the electrolyte which provides the medium for transfer of electrons between the two electrodes. During discharge, electrochemical reactions at the two electrodes generate a flow of electrons through an external circuit with the cathode accepting electrons and the anode providing electrons. During charging process, the electrochemical reactions are reversed and the battery absorbs electricity energy from the external circuit.

#### **3.1 Lead-acid batteries**

Lead-acid batteries are the oldest type of rechargeable batteries. They are considered as very mature technologies. They are easy to install and have a low cost. Valve regulated lead-acid batteries require negligible maintenance. The self-discharge rates for this type of batteries are very low, around 2-5% of rated capacity per month, which make them ideal for long-term storage applications. However, disadvantages of lead-acid batteries are low energy density and short service life. The typical energy density is around 30 Wh/kg and the typical lifetime is between 1200 and 1800 cycles [7]. The cycle life is affected by depth of discharge and they are not suitable for discharges over 20% of their rated capacity [8]. The performance of lead-acid would also be affected by temperature: higher temperature (with the upper limit of 45°C) will reduce battery lifetime and lower temperature (with the lower limit of -5°C) will reduce the efficiency.

### 3.2 Nickel-based batteries

In a nickel-based battery, nickel hydroxide is used on the positive electrode but for the negative electrode different materials can be used. This fact explains the existence of various technologies. There are three kinds of nickel-based batteries namely the nickel-cadmium (NiCd) battery, the nickel-metal hydride (NiMH) battery and the nickel-zinc (NiZn) battery. The NiCd technology uses cadmium hydroxide, the NiMH uses a metal alloy and the NiZn uses zinc hydroxide. Nickel-based batteries have larger energy densities than lead-acid batteries, 50 Wh/kg for the NiCd, 80 Wh/kg for the NiMH and 60 Wh/kg for the NiZn.

NiCd batteries are now reaching the level of maturity as lead-acid batteries. NiCd batteries have a longer lifetime about 3000 cycles and can be fully discharged without damage [9]. As an example, this technology is used in the energy storage system of the Alaska Golden Valley project which provides a backup to an isolated electrical power system. This project is claimed to be the world's most powerful battery system with a rated power of 40 MW and with a discharge capability over 7 min [10]. However, two drawbacks limit future large-scale deployment of this technology. One is the high price, for the NiCd battery may cost up to 10 times more than the lead-acid battery. Another is the environment concerns about cadmium toxicity and associated recycling issues [7-11].

NiMH batteries have high energy density which is over twice than lead-acid batteries. This type of batteries can be recycled and their components are harmless to the environment. They also can be used in large temperature ranges and high voltage operation. However, repeatedly discharged at high load currents would shorten the life of NiMH batteries to about 200-300 cycles and the memory effect reduces the useful SOC (State of Charge) of the battery. NiZn batteries have the same advantages of NiMH batteries and have deep cycle capability as NiCd batteries, but they suffer from poor life cycle due to the fast growth of dendrites.

### 3.3 Lithium-ion batteries

Lithium-ion batteries achieve excellent performances in portable electronics and medical devices. This technology is typically driven by and attractive for consumer electronics market because lithium-ion batteries are lighter, smaller and more powerful

than other batteries. They have the highest energy density from 90 to 190 Wh/kg and the highest power density from 500-2000 W/kg among all the batteries [7,9]. Other advantages of lithium batteries include high efficiency, low memory effect and low self-discharge rate. This is why lithium-ion batteries are very promising to be used in next-generation electrical vehicles [8].

Some drawbacks exist in this battery technology. Lithium-ion batteries are theoretically characterized by a lifetime about 3000 cycles at 80% depth of discharge [9]. However in actual, lithium-ion batteries are not robust and sometimes very fragile. Life cycles are affected by temperature and would be severely shortened by deep discharges. Usually, lithium-ion batteries require special protection circuit to avoid overload and need sophisticated management systems to maintain safe operational conditions. Another drawback is that the cost of lithium-ion batteries, from \$ 900/kWh to \$ 1300/kWh. These facts limit the use of lithium-ion batteries for large-capacity applications and applications where very low SOC would be reached.

### 3.4 Sodium-sulphur batteries

Sodium-sulphur (NaS) is a new promising high temperature battery technology, operating at over 300°C. The specific energy density of this kind of battery is 100Wh/kg and the life span is 2500 cycles at 100% depth of discharge with a high energy efficient about 89% [9].

Basic cell construction uses liquid sulphur at the positive electrode and liquid molten sodium at the negative electrode separated by a solid beta alumina ceramic electrolyte as shown in Fig.8. During discharge, when positive  $\text{Na}^+$  ions flow through the electrolyte and combine with the sulfur forming sodium polysulfide ( $\text{Na}_2\text{S}_4$ ) and electrons flow in the external circuit of the battery. Basic cell voltage is 2V. This process is reversible. During the charging process,  $\text{Na}_2\text{S}_4$  molecules release the  $\text{Na}^+$  ions to the electrolyte where these ions are recombined as elemental sodium [11]. In classical operating conditions, the heat produced by charging and discharging is enough to maintain running temperatures (about 300-350°C), but the battery still need to be heated in stand-by mode to keep the electrodes in molten state [9,12].

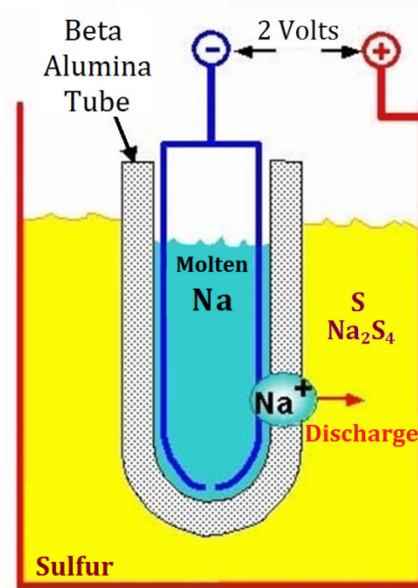

Fig. 8. Basic NaS cell [11].

Sodium sulfur battery technology was brought to market in 2002 by Japanese company NGK. To date, more than 270 MW of total capacity has been set up at over 190 sites in Japan [11]. These batteries stored energy which is suitable for 6 hours of daily peak shaving. U.S. utilities have deployed 9 MW of NaS batteries for reinforcing wind capacity and other applications. The largest NaS installation is a 34 MW, 245 MWh unit used for wind stabilization in Northern Japan.

On one hand, this technology has advantages such as low cost, high energy capacity, high efficiency and deep discharge tolerance. On the other hand, this kind of battery is penalized by high operating temperature and the corrosive nature of sodium. These characteristics make NaS batteries suitable for large-scale stationary applications. In the opinion of the authors, this technology appears attractive for marine renewable applications, being an effective solution for stabilizing energy output during periods of 3-6 hours in order to smooth the output of a marine generator farm. However the operating environment must be perfectly controlled if this solution is used. This fact implies ‘a priori’ a setup on an offshore platform or near the onshore transmission line for the power grid.

### 3.5 Flow batteries



Flow batteries are relatively new battery technology dedicated for large energy capacity applications. This technology consists of two electrolyte reservoirs from which the liquid electrolytes flow through an electrochemical cell comprising the electrodes and a membrane separator. Fig.9. illustrates the structure of a flow battery system. Charging and discharging are realized by means of a reversible electrochemical reaction between two liquid electrolyte reservoirs. Flow batteries are often called redox flow batteries, based on the redox (reduction-oxidation) reaction between the two electrolytes in the system.

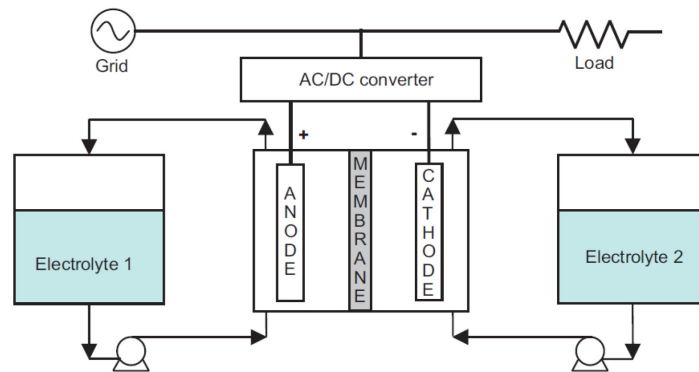

Fig. 9. Flow battery system [10].

The distinguished advantage of flow battery technologies is that the power and energy ratings can be sized independently [10-12]. The power rating is determined by the design of the electrode cells and the energy capacity depends on the volume of the electrolytes. Therefore, flow battery can be easily designed to meet specific energy capacity or power rating requirements. These characteristics make them suitable for a wider range of applications than conventional batteries. Another significant advantage is the long service life about 10,000 cycles at 75% depth of discharge. Other advantages include high safety, negligible degradation for deep discharge and negligible self-discharge. The major disadvantage is that the flow battery system involves pumps systems which increase the complexity of the system and total costs.

Over the past 20 years, four designs of flow batteries have been demonstrated: vanadium redox (VRB), zinc bromine (ZnBr), polysulphide bromide (PSB) and cerium zinc (CeZn). Major installations, in Japan and North American, use the vanadium redox and zinc bromine designs. Energy efficiency is about 85% for VRB system and 75% for

ZnBr system. VRB system of 500kW, 10 hours (5MWh) have been for example installed in Japan by Sumitomo Electric Industries (SEI), and VRB system have also been used for power quality applications (Power supply of 3MW during 1.5seconds). 5kW/20kWh Community Energy Storage units based on ZnBr batteries are now being tested. Integrated ZnBr energy storage systems have been tested on transportable trailers (1MW/3MWh), and these systems could be connected in parallel for more powerful applications.

Flexible energy and power sizing, long lifetime, low cost and low maintenance make flow battery a very promising technology to be used for buffering fluctuant renewable energies integrated to the power grid. For marine current energy, flow batteries can be designed differently for compensation short-time and long-time fluctuations, and more favorably they are suitable for hours energy storage for smoothing the fluctuation due to tidal phenomenon.

The following table gives a comparison among the merits and demerits for the various battery technologies discussed above.

Table 1. Comparisons of battery technologies

Battery type	Advantages	Disadvantages
Lead-acid	<ul style="list-style-type: none"> <li>√Low cost</li> <li>√Low self-discharge (2-5%per month)</li> </ul>	<ul style="list-style-type: none"> <li>×Short cycle life(1200-1800 cycles)</li> <li>×Cycle life affected by depth of charge</li> <li>×Low energy density (about 40Wh/kg)</li> </ul>
Nickel-based	<ul style="list-style-type: none"> <li>√Can be fully charged(3000 cycles)</li> <li>√Higher energy density(50-80Wh/kg)</li> </ul>	<ul style="list-style-type: none"> <li>×High cost, 10 times of lead acid battery</li> <li>×High self-discharge(10% per month)</li> </ul>
Lithium-ion	<ul style="list-style-type: none"> <li>√High energy density(80-190Wh/kg)</li> <li>√Very high efficiency 90-100%</li> <li>√Low self-discharge(1-3% per month)</li> </ul>	<ul style="list-style-type: none"> <li>×Very high cost( \$ 900-1300/kWh)</li> <li>×Life cycle severely shorten by deep discharge</li> <li>×Require special overcharge protection circuit</li> </ul>
Sodium Sulphur(NaS)	<ul style="list-style-type: none"> <li>√High efficiency 85-92%</li> <li>√High energy density(100Wh/kg)</li> <li>√No degradation for deep charge</li> <li>√No self-discharge</li> </ul>	<ul style="list-style-type: none"> <li>×Be heated in stand-by mode at 325°C</li> </ul>

Flow battery	√Independent energy and power ratings	×Medium energy density(40-70Wh/kg)
	√Long service life(10,000 cycles)	
	√No degradation for deep charge	
	√Negligible self-discharge	

---

For marine energy application, these batteries are reasonable supposed to be installed underwater or on an offshore platform and they may be discharged deeply in order to achieve a required smooth effect. In the first place, low maintenance and robust long service life should be considered as important criteria, and in that term the lead-acid and lithium-ion batteries are not favorable due to their short cycle life. Low cost should also be emphasized, which make lithium-ion and nickel-based batteries not attractive. It can be concluded that NaS batteries and flow batteries are two best candidates among battery technologies. They are cost-effective and have robust lifetimes. Compared with NaS batteries, flow batteries have a longer life span but a more complicated system set-up. Flow batteries are easier to operate because they do not need to be kept at a high temperature. With appropriate installations, flow batteries and NaS batteries seem to be two most promising battery technologies suitable for smoothing the long-term fluctuation in marine energy systems.

For the short-term fluctuation (swell disturbance) with a period of seconds, a much shorter charge/discharge time constant of energy storage devices is required. The flywheel and supercapacitor technologies are presented in the following sections.

#### 4. Flywheel technologies

A flywheel is based on a rotating disk which can store kinetic energy. This flywheel is associated with a generator/motor and drive system which allows controlling the energy storage and discharge. According to the rotational speed, there are broadly two classes of flywheel technologies: low-speed flywheels (less than 10,000 rpm) and high-speed flywheels (more than 10,000 rpm) [13-15]. Low-speed flywheels use steel rotors and conventional bearings, and they achieve energy density of 5-30Wh/kg. High-speed flywheels use composite rotors and low friction bearings (e.g., superconducting magnetic bearings). Composite rims are lighter and much stronger than steel, so they can be used with extremely high rotational speed and achieve high energy density up to

100Wh/kg [7]. The amount of energy stored in a flywheel depends on the square of the rotational speed, making high-speed flywheels highly desirable for Energy/mass ratio optimization. Typical flywheel energy storage system (FESS), (Fig. 10), consists of a massive rotating cylinder (a rim attached to a shaft) that is supported on a stator by magnetically levitated bearings. The flywheel system is operated in a vacuum chamber to reduce friction and losses. A motor/generator is connected to the flywheel to interact with the power grid or the renewable energy sources through power electronics drive.

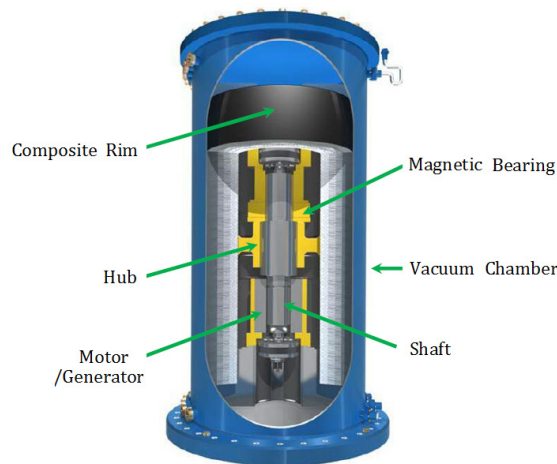

Fig. 10. Typical flywheel energy storage system [15].

Conventional low-speed flywheels can be used for the uninterruptible power supply (UPS). One of the popular flywheel UPSs is the Piller's POWERBRIDGE system available in the range of 250-1300 kW. The bigger system containing a low-speed flywheel with a maximum speed of 3600 r/min and can deliver 1.1 MW during 15 seconds [13]. American company Beacon POWER is one of the leaders of long-term (hours) application market of FESS. Recent reports show that Beacon POWER has turned to develop advanced high-power and high-energy FESS for short-term (seconds/minutes) applications. Fig. 11 shows the evolution of Beacon POWER FESS products and gives a clear insight into the two applications where FESS can offer. Low-power systems (several kW for hours) are used for telecommunication equipment support. High-power systems (hundreds of kW for seconds or minutes) can be used to provide power frequency regulation service for the power grid. An example of this

typical grid-application is the flywheel farm which can provide 20MW for 15 minutes which has been constructed in late 2009 in Stephentown, NY [15,16].

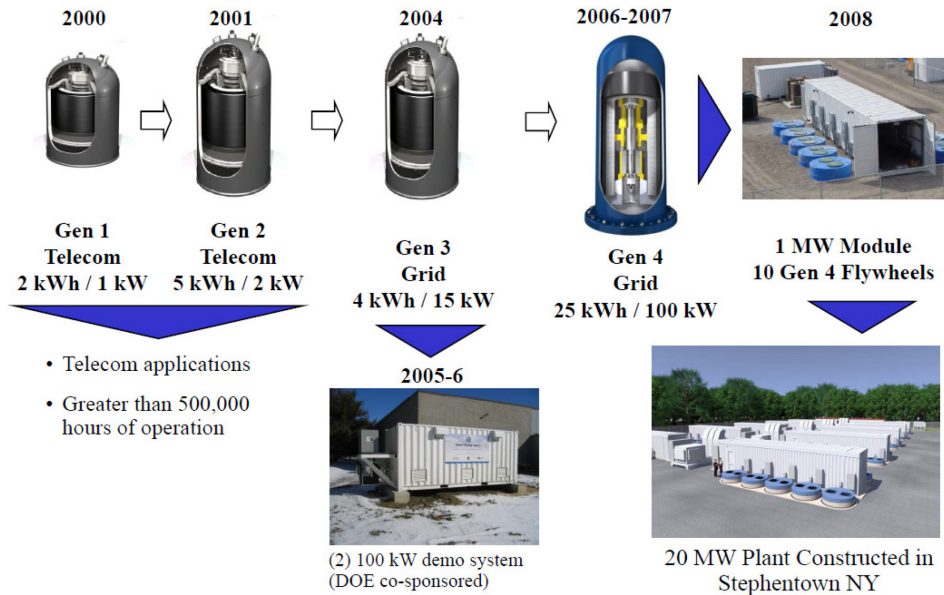

Fig. 11. Evolution of Beacon POWER Flywheel Systems [15]

Key advantages of flywheel energy storage system are high cyclic ability (over  $10^5$  cycles with deep discharge or 20 years service time), high power density (quick charge/discharge), high efficiency and low maintenance. One of the main disadvantages of flywheel energy storage system is the high self-discharge rate which is typically over 20% per hour [7,17]. This disadvantage makes them not suitable for long-term applications. Another challenge is to reduce the high price due to advanced materials and limited mass production.

Based on these characters and the development trends, flywheels seem very appropriate for providing short-term ride-through power or smoothing the power fluctuations on a time scale of several seconds to 15 minutes. With regard to long-term energy storage, they don't have many advantages over battery systems. Therefore, for marine current energy application, flywheel systems can become a very interesting candidate to compensate short-term fluctuations related to swell effects. But it seems flywheel systems are not easy to be installed underwater considering the corrosion effects of sea water and the peripheral equipments such as power converters and transformers.

## 5. Supercapacitor technologies

Supercapacitors, also known as ultracapacitors and electrochemical double-layer capacitors (EDLCs), store energy by capacitance effect. Supercapacitors work in a similar way as conventional capacitors, but they are characterized by a much higher capacitance (kilo farads) in smaller packages [18]. It must be remembered that the capacitance is proportional to the area of the plates and the permittivity of the dielectric, and inversely proportional to the distance between the plates. Supercapacitors use high-permittivity dielectric and maximize the electrode surface area by using porous active carbon, allowing large amounts of energy to be stored at the electrode surface. The two electrodes are separated by a very thin porous separator which is immersed in the electrolyte. The electrolyte is either aqueous or organic. The aqueous capacitors have a lower energy density due to a lower cell voltage but are less expensive. They have a lower resistance, and work over a wider temperature range [11]. Fig. 12 shows the structure of one individual supercapacitor cell [19]. The potential difference for one cell is around 1V and 3V with aqueous and organic electrolyte respectively.

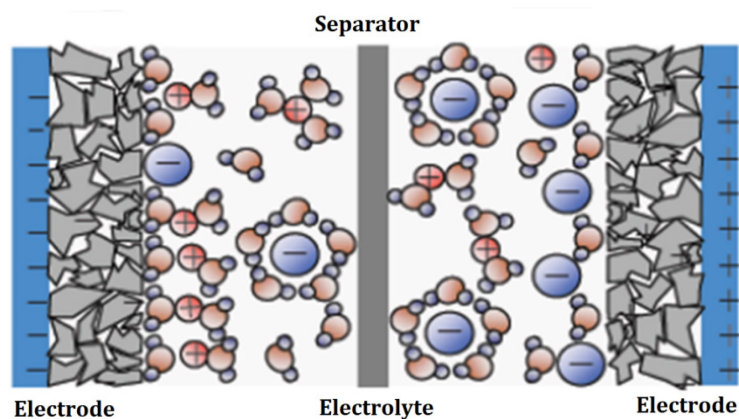

Fig. 12. Individual supercapacitor cell [19].

Thanks to that the electrodes will not be chemically degraded as in batteries, supercapacitors are able to be used during hundreds of thousands cycles in deep charge/discharge operations. Supercapacitor can be cycled more than 500,000 times and have a service life of 12 years. Power density of supercapacitors is considerably higher than batteries due to that the electrical charges are physically stored on the electrodes. Supercapacitors can be easily charged and discharged in seconds, much faster than

batteries. Energy efficiency is high and no heat or hazardous substances are released during operation. Although new materials for electrodes are being developed for increasing the energy density, supercapacitors are limited by the disadvantages of a very low energy density (5Wh/kg) and a high self-discharge rate. That means supercapacitors can absorb or release high amount of power only during a very short time. Another point is that the lifetime of supercapacitor would be affected by the variation of voltage and by the temperature, so the design of supercapacitor system should include an aging model taking into account the operation characteristics.

One typical application for supercapacitors is hybrid electric vehicles (HEV). They are used in HEV for energy storage from electrical braking and for providing accelerating power, thanks to their fast charge and discharge capability. Using supercapacitors in conjunction with batteries combines the high power characteristic of the supercapacitor and the high energy capacity of the battery. In a HEV, the use of supercapacitors allows extending the life of the battery (by reducing the depth of charge/discharge of the battery) and enables the battery to be downsized (by reducing the peak loads on the battery) [8,20-22].

Researches have also shown that supercapacitors can be used to absorb high-frequency power fluctuations produced from renewable energy sources, improving significantly power qualities of renewable energy generation systems. Supercapacitors for Doubly-fed Induction Generator (DFIG) and Permanent Magnet Synchronous Generator (PMSG) wind turbine applications are discussed in [23,24] and [25] respectively. References [26,27] and [39] only use battery as the ESS, the main objection is to balance the difference between the turbine-produced power and the load (or grid) required power. If high-power fluctuations have to be smoothed, high-power density devices such as supercapacitors are therefore required. Hybrid ESS based on battery and supercapacitor for wind power application are studied in [28-30]. The aim of hybrid ESS is to absorb high-frequency fluctuations by supercapacitors and let batteries dealing with low-frequency fluctuations. This will allow optimizing high-power and high-energy ESSs. Supercapacitors used in photovoltaic applications are presented in [31,32]. In reference [33] a solution using supercapacitors for smoothing the power generated from SEAREV wave energy converter is presented; different State of Charge (SOC) control strategies are studied and compared.

For marine current energy system, both low-frequency (long-term) and high-frequency (short-term) fluctuations exist. Thanks to high power performance and high cycling capability, the supercapacitor technology appears to be one of the most appropriate solutions for smoothing the high-frequency fluctuations. But supercapacitors are not adapted for smoothing the power on a time scale larger than one minute. It means that high energy density and long-duration energy storage devices are needed to be associated with supercapacitors for a global treatment in marine current application.

## 6. PHS and CAES technologies

### 6.1 Pumped Hydro Storage (PHS)

Pumped hydro storage is a well-known technology of storing and producing electricity by the use of pumps and turbines to transfer water between two reservoirs situated at different levels. During low electricity demand periods, excess generation power is used to pump water from the lower reservoir to the upper reservoir (Fig. 13). During peak hours when demand is high, the water is released back to the lower reservoir through hydro turbines, generating electricity. The round-trip efficiencies of PHS plant are over 75%. The storage capacity of PHS depends on two parameters: the height of the waterfall and the volume of the water. Sites with two nature bodies of water are favorable for this technology and the sea can be used as the lower reservoir.

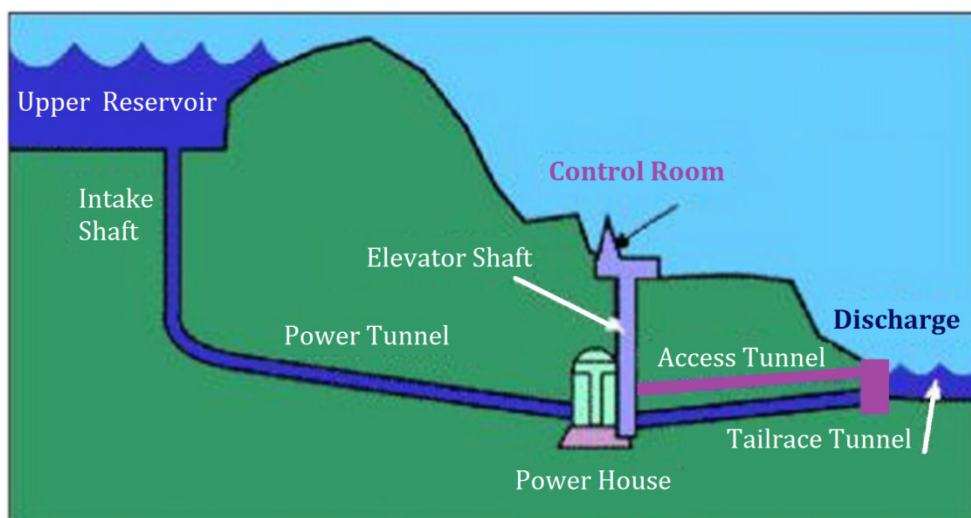

Fig. 13. Schematic of Pumped Hydro Storage plant [34].



Pumped hydro storage is the most widespread energy storage system used on power networks. Its main applications are providing energy management, frequency control, and reserve capacity. And it is now the only energy storage technology deployed on a GW scale worldwide [35]. In the United States, about 20 GW are deployed in 39 sites, with capacities from less than 50 MW to 2,100 MW. Many of these sites are able to store the excess power during more than 10 hours, making the technology favorable for load leveling. The drawbacks for this technology are that the implementation of such a system needs an appropriate geographic site, a high cost investment, and a long construction time.

## 6.2 Compressed Air Energy Storage (CAES)

In a Compressed Air Energy Storage (CAES) system, air is compressed (40-70 bars) and stored in a sealed reservoir, usually an underground cavern, during off-peak periods. During discharge at peak hours, the compressed air is released from the cavern, heated, and expanded through turbines where it is mixed with fuel and combusted to drive an electrical generator (Fig. 14).

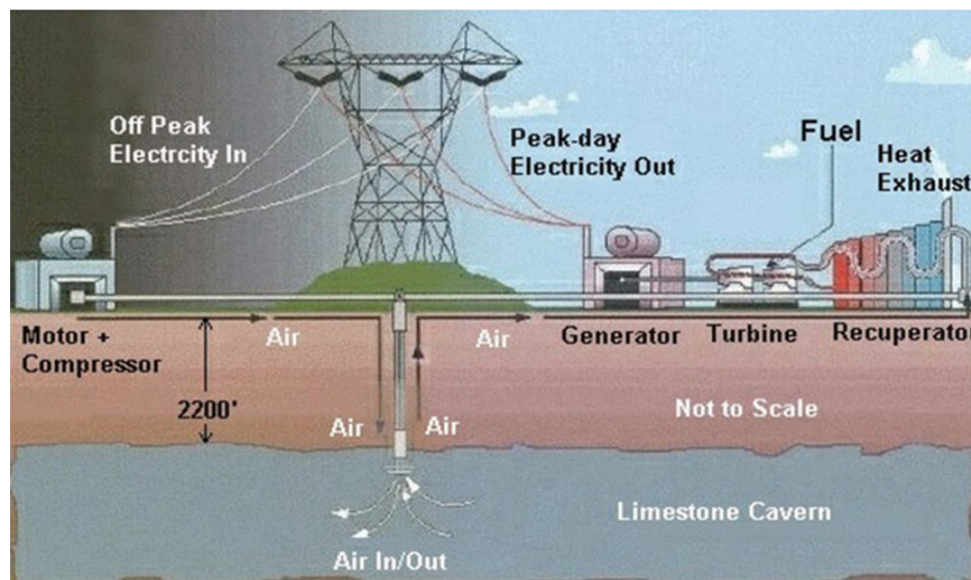

Fig. 14. Schematic of CAES plant [36].

The cheapest solution for storing significant quantities of air at high pressures is using underground caverns as reservoirs. The air can also be compressed and stored in high-pressure pipelines or aboveground reservoir, which would eliminate the geological

limitations and make the system easier to operate. Another approach to compressed air storage is called CAS, compressed air in cylinders. In a CAS system, air is stored in fabricated high-pressure tanks made of carbon-fiber (up to 300 bars). CAS may become a good solution for small- or medium-scale applications when a feasible manufacture cost can be achieved for ultrahigh pressure tanks.

CAES is a proven technology: the first commercial CAES to be built was a 290-MW plant built in Hundorf, Germany in 1978. The second commercial one was a 110-MW unit built in Alabama, US in 1991 [36]. Starting in late 2008, two CAES plants with advanced designs for reducing fuel use were constructed by several US utilities: one bulk plant use an underground reservoir for 10 hours of storage at 300 MW capacity, and another use an aboveground reservoir for 2 hours of storage at 15 MW capacity [37].

CAES is a cost-effective option for storing energy in large quantities. CAES plants can perform ramping duty and smooth the intermittent output of renewable energy sources [37]. Simulations results in [35] show that CAES is characterized by a much lower cost and generates a higher rate of return than PHS in wind farm application.

## 7. Comparisons and Conclusion

To be highly efficient, storage systems need to be closely adapted to the type and the scale of applications. Energy storage applications are often divided into three categories based on required storage time: (1) Power Quality: charge/discharge time is required from several seconds to minutes to ensure the quality of power delivered. Example applications are frequency regulation and transient power stability; (2) Bridging Power: stored energy should be used for several minutes to about an hour to ensure the continuity of the power supply during the switching from one electricity source to another or during black out; (3) Energy Management: The aim of this strategy is to decouple the synchronization between power generation and consumption. This kind of application requires large quantity of energy stored for hours. Typical application are load leveling and energy arbitrage, which implies storing low-cost off-peak energy and releasing (selling) the stored energy during high-price peak hours.

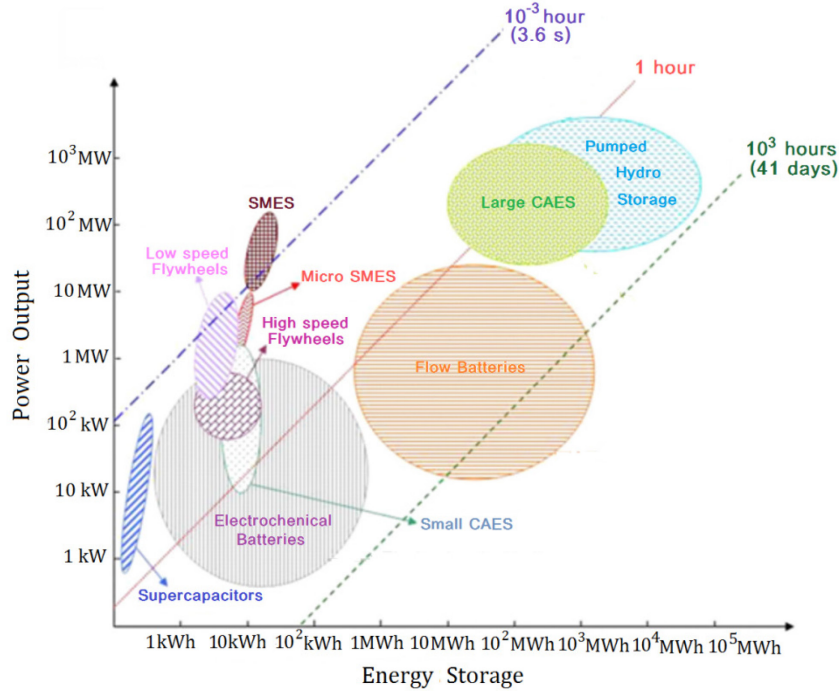

Fig.15. Energy storage technologies comparison [36].

Fig. 15 illustrates energy storage capacities and output power capabilities for different energy storage technologies. Fig.16 compares energy storage systems according to system power ratings, discharge times and different applications. The interesting ranges for smoothing long-term power fluctuation related to tidal phenomenon and short-term fluctuation caused by swell effect have been highlighted in Fig. 16.

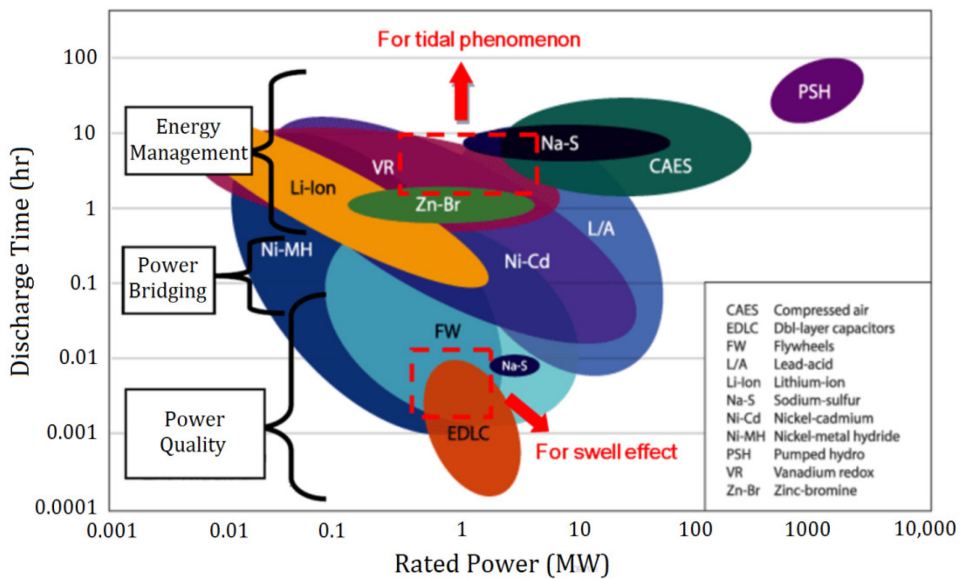

Fig. 16. System ratings for different energy storage technologies [35].

Fig. 15 and Fig. 16 show that many technologies are in concurrence to be applied for one specific application or for a given system. In that case, cost may become one decisive factor for choosing the final solution. Fig. 17 (based on data from [37]) compares the costs (including necessary power conditioning equipment for relative energy storage devices) for different energy storage technologies.

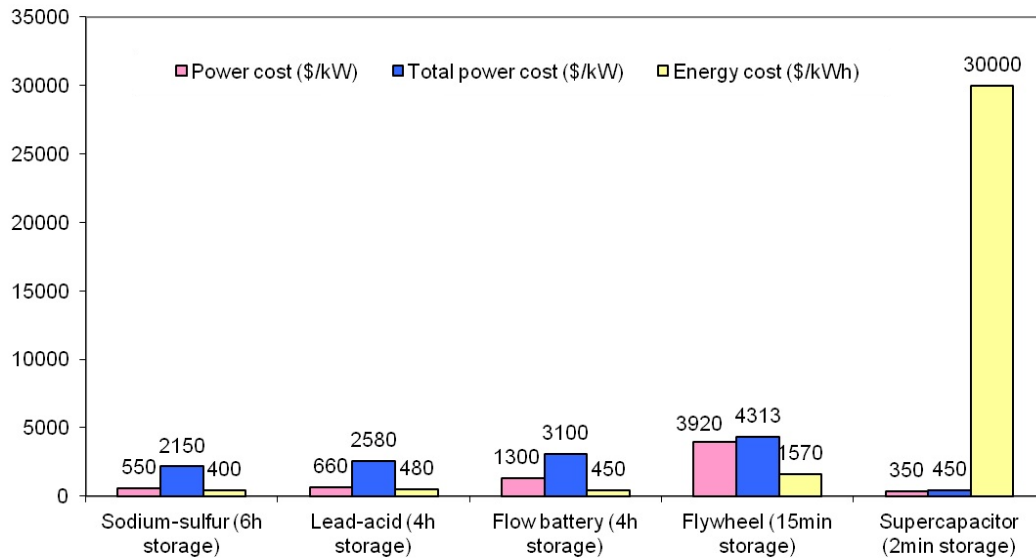

Fig. 17. Costs for energy storage systems.

Based on different characteristics for each energy storage technology, and from above figures, it can be seen that for short-term energy storage (seconds to minutes), supercapacitor and flywheel technologies are ‘a priori’ the best candidates for marine current systems. Flywheels are characterized by a higher cost than supercapacitors due to their higher energy capacity and higher power rating. Although both supercapacitor and flywheel technologies can be used for smoothing short-term high frequency fluctuations caused by swell effects, the former is more appropriate for single generation units and the later is more suitable for one generator farm.

With regard to long-term (several hours) energy storage, batteries are most suitable technologies and the flow battery is a very promising technology for its high cyclic capability and flexible system design. NaS batteries can also be chosen but they need be heated during stand-by mode. Therefore, for smoothing long-term (3~6 hours) fluctuations in marine current application, high-energy batteries like flow batteries and

NaS batteries can be a good solution. They can also be used to realize energy management strategies for marine current farm.

Other technologies like PHS and SMES (superconducting magnetic energy storage) are not very interesting in marine applications. PHS aims at GW scale for over 10 h or even several days energy storage; this technology seems too large for marine current energy systems. SMES aims at MW scale for several ms power absorption/apply [38]. This technology does not fit the requirements of smoothing power fluctuations in marine current energy systems, and it is not economically and technologically favorable.

Although small CAES using aboveground reservoirs seems have an advantage of lower cost over batteries, such systems have yet to be commercially available. Only large CAES plants (hundreds MW) are proven cost-effective in actual operations. And obviously, the CAES technologies with underground caverns are extremely difficulty to apply in marine environment.

## Acknowledgements

This work is supported by Brest Metropole Océane (BMO), Brest, France.

## References

- [1] S. Benelghali, R. Balme, K. Le Saux, M. E. H. Benbouzid, J. F. Charpentier, and F. Hauville, A simulation model for the evaluation of the electrical power potential harnessed by a marine current turbine, *IEEE Journal of Oceanic Engineering*, 2007; 32(4):786-797.
- [2] S. Benelghali, M. E. H. Benbouzid, and J. F. Charpentier, Marine tidal current electric power generation technology: State of the art and current status, *Proc. IEEE Int. Electr. Mach. Drives Conf.*, Antalya, Turkey, 2007; 2: 1407–1412.
- [3] S. Benelghali, M. E. H. Benbouzid, T. Ahmed-Ali, and J. F. Charpentier, High-order sliding mode control of a marine current turbine driven doubly-fed induction generator, *IEEE Journal of Oceanic Engineering*, 2010; 35(2):402-411.
- [4] R. Bonnefille, *Mouvements de la mer* (in French), *Techniques de l'Ingénieur*, 2010; C4610: 1-19.

- [5] <http://hmf.enseeiht.fr/travaux/CD0001/travaux/optsee/hym/7/rapport.htm> (last accessed October 2012).
- [6] Y. Goda, *Random Seas and Design of Maritime Structures*, 3rd ed., Advanced Series on Ocean Engineering, vol.33, World Scientific, Singapore, 2010.
- [7] I. Hadjipaschalis, A. Poullikkas, V. Efthimiou, Overview of current and future energy storage technologies for electric power applications, *Renewable and Sustainable Energy Reviews*, 2009; 13:1513-1522.
- [8] A. Khaligh, and Z. Li, Battery, ultracapacitor, fuel cell, and hybrid energy storage systems for electric, hybrid electric, fuel cell, and plug-in hybrid electric vehicles: State of the art, *IEEE Trans.Veh.Technol*, 2010; 59(6):2806-2814.
- [9] K.C. Divya, and J. Østergaard, Battery energy storage technology for power systems-An overview, *Electric Power Systems Research*, 2009; 79:511-520.
- [10] J. Baker, New technology and possible advances in energy storage, *Energy Policy*, 2008; 36: 4368-4373.
- [11] <http://www.electricitystorage.org/> (last accessed October 2012).
- [12] P. J. Hall, E. J. Bain, Energy-storage technologies and electricity generation, *Energy Policy*, 2008; 36:4352-4355.
- [13] G. O. Cimuca, C. Saudemont, B. Robyns, and M. M. Radulescu, Control and performance evaluation of a flywheel energy-storage system associated to a variable-speed wind generator, *IEEE Trans. Ind. Electron.*, 2006 ; 53(4) :1047-1085.
- [14] J. M. Carrasco, L. G. Franquelo, J. T. Bialasiewicz, E. Galván, R. C. P. Guisado, M. Á. M. Prats, J. I. León, and N. Moreno-Alfonso, Power-electronic systems for the grid integration of renewable energy sources: A survey, *IEEE Trans. Ind. Electron.*, 2006 ;53(4) :1002-1016.
- [15] <http://www.beaconpower.com/products/presentations-reports.asp> (last accessed October 2012)
- [16] M. L. Lazarewicz, and A. Rojas, Grid Frequency Regulation by Recycling Electrical Energy in Flywheels, *Proc. IEEE Power Engineering Society General Meeting*, 2004; 2:2038-2042.
- [17] R. T. Doucette, M. D. McCulloch, A comparison of high-speed flywheels, batteries, and ultracapacitors on the bases of cost and fuel economy as the energy storage system in a fuel cell based hybrid electric vehicle, *Journal of Power Sources*, 2011;196:1163-1170.
- [18] S. Vazquez, S. M. Lukic, E. Galvan, L. G. Franquelo, and J. M. Carrasco, Energy storage systems for transport and grid applications, *IEEE Trans. Ind. Electron.*, 2010 ;57(12) :3881-3895.
- [19] W. Chen, A. K. Ådnanses, J. F. Hansen, J. O. Lindtjørn, and T.Tang, Super-capacitors based hybrid converter in marine electric propulsion system, *Proc. IEEE XIX Int. Electr. Mach. Conf.*, Rome, 2010 ;1-6.
- [20] <http://www.nrel.gov/vehiclesandfuels/energystorage/ultracapacitors.html> (last accessed October 2012)

- [21] P. Thounthong, V. Chunkag, P. Sethakul, B. Davat, and M. Hinaje, Comparative study of fuel-cell vehicle hybridization with battery or supercapacitor storage device, *IEEE Trans. Veh. Technol.*, 2009 ;58(8) :3892-3904.
- [22] E. Schaltz, A. Khaligh, and P. O. Rasmussen, Influence of battery/ultracapacitor energy-storage sizing on battery lifetime in a fuel cell hybrid electric vehicle, *IEEE Trans. Veh. Technol.*, 2009 ; 58(8) :3882-3891.
- [23] C. Abbey, and G. Joos, Supercapacitor energy storage for wind energy applications, *IEEE Trans. Ind. Appl.*, 2007 ; 43(3) :769-776.
- [24] L. Qu, and W. Qiao, Constant power control of DFIG wind turbines with supercapacitor energy storage, *IEEE Trans. Ind. Appl.*, 2011 ; 47(1) :359-367.
- [25] S. M. Muyeen, R. Takahashi, T. Murata, and J. Tamura, Integration of an energy capacitor system with a variable-speed wind generator, *IEEE Trans. Energy Convers.*, 2009; 24(3):740-749.
- [26] P. K. Goel, B. Singh, S. S. Murthy, and N. Kishore, Isolated wind-hydro hybrid system using cage generators and battery storage, *IEEE Trans. Ind. Electron.*, 2011 ; 58(4) :1141-1153.
- [27] A. Abedini, and H. Nikkhajoei, Dynamic model and control of a wind-turbine generator with energy storage, *IET Renew. Power Gener.*, 2011; 5(1): pp. 67-78.
- [28] W. Li, and G. Joós, A power electronic interface for a battery supercapacitor hybrid energy storage system for wind applications, *Proc. IEEE Power Electron. Spec. Conf.*, 2008 :1762-1768.
- [29] W. Li, G. Joós, and J. Bélanger, Real-time simulation of a wind turbine generator coupled with a battery supercapacitor energy storage system, *IEEE Trans. Ind. Electron.*, 2010 ; 57(4) :1137-1145.
- [30] H. Jia, Y. Fu, Y. Zhang, and W. He, Design of hybrid energy storage control system for wind farms based on flow battery and electric double-layer capacitor, *Proc. IEEE Power and Energy Eng. Conf., Asia-Pacific*, 2010 ;1-6.
- [31] H. Zhou, T. Bhattacharya, D. Tran, T. S. T. Siew, and A. M. Khambadkone, Composite energy storage system involving battery and ultracapacitor with dynamic energy management in microgrid applications, *IEEE Trans. Power Electron.*, 2011 ; 26(3) :923-930.
- [32] Y. Cheng, Super Capacitor Applications for Renewable Energy Generation and Control in Smart Grids, *Proc. IEEE International Symposium on Ind. Electron.*, 2011 ;1131-1136.
- [33] J. Aubry, P. Bydlowski, B. Multon, H. Ben Ahmed, and B. Borgarino, Energy storage system sizing for smoothing power generation of direct wave energy converters, *Proc. 3rd Int. Ocean Energy Conf., Bibao, Spain*, 2010;1-7.
- [34] M. Hessami, and D. R. Bowly, Economic feasibility and optimisation of an energy storage system for Portland Wind Farm (Victoria, Australia), *Applied Energy*, 2011;88:2755-2763.

- [35] P. Denholm, E. Ela, B. Kirby, and M. Milligan, The role of energy storage with renewable electricity generation, Technical Report of National Renewable Energy Laboratory, U.S., 2010 ([http://www.nrel.gov/wind/systemsintegration/pdfs/2010/ela\\_energy\\_storage.pdf](http://www.nrel.gov/wind/systemsintegration/pdfs/2010/ela_energy_storage.pdf))
- [36] H. Ibrahim, A. Ilinca, and J. Perron, Energy storage systems-Characteristics and comparisons, *Renewable and Sustainable Energy Reviews*, 2008; 12:1221-1250.
- [37] D. Raster, New demand for energy storage, *Electric Perspectives*, 2008;30-47. (<http://www.eei.org/magazine/EEI%20Electric%20Perspectives%20Article%20Listing/2008-09-01-EnergyStorage.pdf>)
- [38] F. Diaz-Gonzalez, A. Sumper, O. Gomis-Bellmunt, R. Villafafila-Robles, A review of energy storage technologies for wind power applications, *Renewable and Sustainable Energy Reviews*, 2012; 16:2154-2171.
- [39] M. Bragard, N. Soltau, S. Thomas, and R.W. De Doncker, The balance of renewable sources and user demands in grids: power electronics for modular battery energy storage systems, *IEEE Trans. Power Electron.*, 2010 ; 25(12) :3049-3056.