



HAL
open science

SOA BASED APPROACH FOR INTERCONNECTING WORKFLOWS ACCORDING TO THE SUBCONTRACTING ARCHITECTURE

Saida Boukhedouma, Zaia Alimazighi, Mourad Chabane Oussalah, Dalila
Tamzalit

► **To cite this version:**

Saida Boukhedouma, Zaia Alimazighi, Mourad Chabane Oussalah, Dalila Tamzalit. SOA BASED APPROACH FOR INTERCONNECTING WORKFLOWS ACCORDING TO THE SUBCONTRACTING ARCHITECTURE. IADIS International Conference - Collaborative Technologies 2011 - CT'2011, Jul 2011, Rome, Italy. pp.1-11. hal-01067287

HAL Id: hal-01067287

<https://hal.science/hal-01067287>

Submitted on 23 Sep 2014

HAL is a multi-disciplinary open access archive for the deposit and dissemination of scientific research documents, whether they are published or not. The documents may come from teaching and research institutions in France or abroad, or from public or private research centers.

L'archive ouverte pluridisciplinaire **HAL**, est destinée au dépôt et à la diffusion de documents scientifiques de niveau recherche, publiés ou non, émanant des établissements d'enseignement et de recherche français ou étrangers, des laboratoires publics ou privés.

SOA BASED APPROACH FOR INTERCONNECTING WORKFLOWS ACCORDING TO THE SUBCONTRACTING ARCHITECTURE

Saida Boukhedouma⁽¹⁾, Zaia Alimazighi⁽¹⁾,
Mourad Oussalah⁽²⁾, Dalila Tamzalit⁽²⁾

⁽¹⁾ USTHB- FEI- Département Informatique- Laboratoire LSI – Equipe ISI
✉: El Alia BP n°32, Bab Ezzouar, Alger, Algérie.
boukhedouma@yahoo.fr; alimazighi@wissal.dz;

⁽²⁾ Université de Nantes- Laboratoire LINA- Equipe MODAL
✉: 2, Rue de la Houssinière, BP 92208, 44322 – Nantes, cedex 3- France
Mourad.oussalah@univ-nantes.fr; Dalila.tamzalit@univ-nantes.fr;

ABSTRACT

In the area of business processes, services needed and provided by organizations are more and more increasing, especially with the emergence of new technologies, such as workflow and web services supported by Service Oriented Architectures (SOA). The two technologies aim to provide flexibility, scalability and efficiency for business applications and to improve collaboration between business partners. This paper lies at a conceptual level, it proposes an approach to connect workflows of several partners using *services*. The approach is supported by a process meta-model which combines workflow concepts and SOA concepts, for modeling inter-organizational processes particularly built according to a *subcontracting* architecture. The advantage of using an approach based on services is to obtain process models flexible enough in order to allow easier adaptation in case of new business needs, because services are loosely coupled components. Our approach is illustrated by instancing concepts on a simple example of inter-organizational process.

KEYWORDS

Inter-organizational process, process meta-model, SOA, web service, workflow.

1. INTRODUCTION

Workflow technology has been widely used in the organizational environments to support the automation of part or all of a business process according to predefined rules. This has led to considerable improvement of these processes which are therefore, called workflow processes (Levan, 2000), (Aalst, 2002). Today, companies face many challenges: the exceptional growth of services they must offer to their customers, the increased need to provide better quality of service and the necessity of cooperation and collaboration with other business partners. In the workflow area, this cooperation has been initially supported by concepts and tools of *Inter-Organizational workflow* (IOWF) (Aalst, 1999), (Aalst, 2000).

Since the year 2000, with the emergence of *Service Oriented Architecture* (SOA) [Papazoglou, 2007] and *web services* [Alonzo et al, 2004], many research works like [Leymann et al, 2002], [Crusson, 2003], [Gorton et al, 2009] have been directed towards the combination of workflow and web services technologies for the development of collaborative business applications implementing inter-organizational processes, in order to take benefits from the advantages offered by both technologies.

In our research, we focus on structured inter-organizational processes mainly based on architectures of cooperation well defined in the literature of IOWF; we talk about the *capacity sharing*, the *chained execution*, the *subcontracting*, the (extended) *case transfer*, and the *loosely coupled* architectures [Aalst, 1999], [Aalst, 2000]. In our opinion, these architectures include various forms of cooperation that can exist between business partners in the context of a structured cooperation. So, they can be considered as basic

patterns of inter-organizational workflow models. Structured cooperation means that the inter-organizational process model is clearly defined and all process instances are executed according to this model.

Also, in a context of increased globalization and in order to meet new market demands, businesses are often faced with stressful situations like a breach of contract with a partner, a failure of the business process, needs of additional resources or other situations. Faced with this, these companies must review their systems, their business processes and their cooperation with other business partners in order to make the necessary adjustments. In our research, we want to focus on adaptation of inter-organizational process models.

Therefore, our objective at medium term is to achieve the adaptation of inter-organizational process models in order to support new business requirements and changes. For that, we aim to realize the interconnection of workflows so that they remain flexible and easily adaptable. The approach we adopt is based on *services* because of their characteristics: loosely coupled, invoked and business oriented.

In this paper, we consider workflow processes obeying the *subcontracting* architecture. Thus, we propose an SOA based approach for interconnecting workflows according to this architecture. Conceptually, our approach is based on a process meta-model that regroups some concepts of the workflow technology and other concepts of the SOA paradigm.

The rest of the paper is structured as follows: section 2 defines the context of the work and introduces some basic concepts. Section 3 exposes quickly some related works and explains the motivation of this paper. Section 4 presents our conceptual approach that means the scheme of interconnecting workflows and the process meta-model which covers different and complementary views of process modeling. Section 5 illustrates our approach by describing a simple example of IOWF that implements a subcontracting cooperation between two partners, providers of internet access to customers.

2. CONTEXT OF THE WORK

A workflow *process* is the automation of all or part of a business process in which information flows from one activity to another (respectively, one participant to another) according to a set of predefined rules.

Inter-organizational workflow (IOWF) can be defined as a manager of activities involving two or more workflows (affiliated with business partners) autonomous, possibly heterogeneous and interoperable in order to achieve a common business goal.

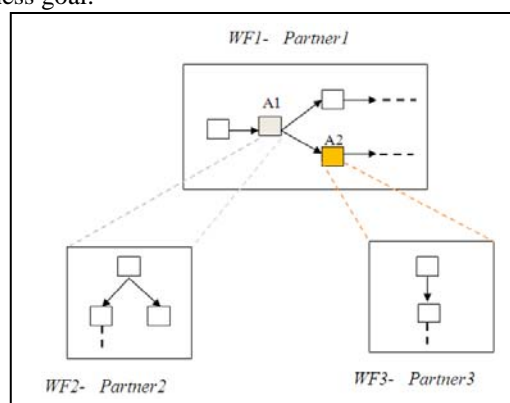

Fig. 1 Scheme of *subcontracting* architecture

One of the architectures defined in [Aalst, 1999] for IOWF is the *subcontracting* architecture. This model of cooperation connects two or more business partners, each of which implements its own workflow process (see Fig.1). There is *one main workflow* (WF1) which subcontracts some activities not implemented locally (like A1 and A2) to *one or more secondary workflow(s)* (WF2 and WF3) involved in the subcontracting relationship.

3. RELATED WORKS AND MOTIVATION

With the emergence of SOA and web services standards, many research works deal with orchestration and choreography of web services [Peltz, 2003], [Decker et al, 2007], [Amirreza, 2009], especially based on BPEL4WS (Business Process Execution Language for Web Services) [Jordan et al, 2006] in order to build business processes by service composition. Also, most of the research works which are SOA oriented [Casati, 2000], [Chen et al, 2005], [Arsanjani et al, 2008], more focus on technical aspects of the proposed approaches, consider collaborative business applications that are fully automatic and do not take into account human intervention in the process.

Other research works such as [Leymann et al, 2002], [Crusson, 2003] and [Gorton et al, 2009] show the interest of combining BPM (Business Process Management) and SOA for the re-use of services to construct dynamic business processes. In [Gorton et al, 2009], the authors propose an approach combining workflow and SOA for business process modeling. The work presented in [Crusson, 2003] describes a complete environment for collaborative processes allowing interaction between business partners via web services.

Also, many platforms and approaches based on workflow and web services technologies have been proposed in the context of structured B2B cooperation, we cite as examples: *CoopFlow* [Chebbi et al, 2006], [Chebbi, 2007], *CrossWork* [Mehandjiev et al, 2005] and *Pyros* [Belhajjame et al, 2005], [Perrin et al, 2004]. These approaches provide a certain degree of flexibility since they allow internal adaptation of workflows without compromising the coherence of the overall workflow.

In our research works, we are interested in structured inter-organizational workflows mainly based on architectures of cooperation already defined in the literature: *capacity sharing*, *chained execution*, *subcontracting*, (extended) *case transfer* and *loosely coupled* [Aalst, 1999]. These architectures describe various forms of cooperation between business partners in the context of structured B2B cooperation and can be considered as basic patterns of IOWF models since. We plan at medium term, to achieve the adaptation of structured inter-organizational process models (basis on IOWF patterns) in order to support changes in case of new business requirements. Thus for interconnecting workflows, we adopt an approach based on services, since services are software components loosely coupled, invoked and business oriented; consequently, the IOWF models remain flexible enough to allow easier adaptation.

The current work is related to the *subcontracting* architecture which is in our opinion, fairly common in B2B relationships. The paper exposes an approach to connect workflows using *services* and proposes a meta-model for process definition. The meta-model that we propose supports two kinds of activities: *internal activities* which can be automatic, semi-automatic or manual for the support of intra-organizational aspect and *interaction activities* (invocations/replies) for the support of inter-organizational aspect. Generally, a meta-model based approach aims to ensure the compliance of process models generated according to the concepts defined on the meta-model and facilitates the adaptation of models in case of new business requirements.

4. OUR APPROACH

In this section, we describe a scheme of interconnecting Workflows using services and the conceptual supports of our approach mainly, the process meta-model, the generated models and the support formalisms at each level.

4.1 Scheme of Interconnecting Workflows

Fig. 2 below describes the scheme of interconnecting WFs according to a *subcontracting* architecture. Each partner involved in the inter-organizational workflow, implements and hosts its workflow locally. Interactions between the main WF and secondary WF(s) are done through operations of invocation/reply of services. Thus, each secondary WF involved in the cooperation is encapsulated within a service (particularly a web service) and has two main activities: an *input activity* for service invocation and input data flow and an *output activity* for returning results provided by the service, to the main workflow.

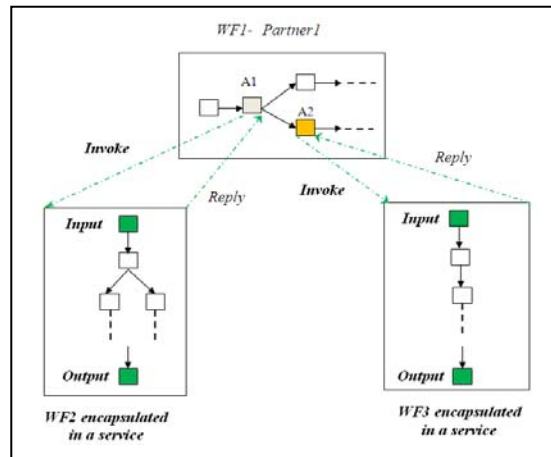

Fig. 2 Scheme of interconnecting WF1- Partner1 according to SOA approach

In the following, we explain the conceptual supports of our approach, mainly the process meta-model. Through an instantiation mechanism, the meta-model is used for generating process models which can be of two kinds: PIM (Platform Independent) or PSM (Platform Specific) models (see Fig.3).

4.2 Conceptual Supports of the Approach

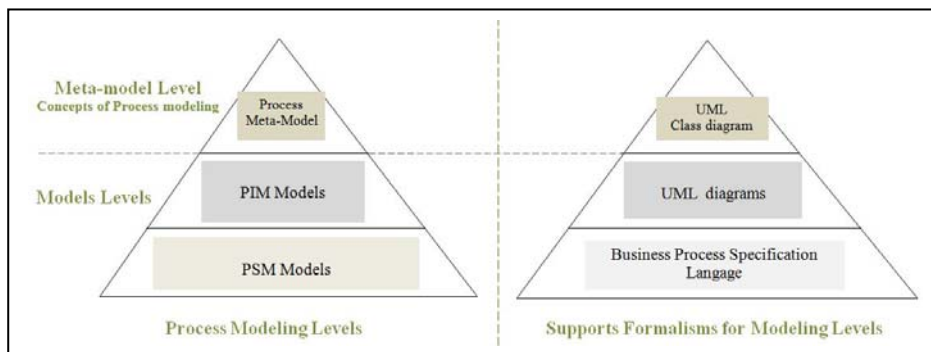

Fig 3. Conceptual levels of our approach

The *meta-model level* exhibits the principal concepts and the links between them for the support of process modeling. The meta-model ensures a conform definition of process models, eventually redefinition of these models if changes must be operated. The meta-model is described using UML class diagrams.

The *model level* represents the different views of a particular process related to a case study of the real world. Process models are built conformably to the concepts identified on the meta-model. These models can be platform independent (PIM models) or related to a specific platform (PSM models) (see Fig.3). At the PIM level of business process modeling, we can use appropriate UML diagrams as modeling tools, mainly sequence diagrams for modeling interactions, activity diagrams for modeling activities of the process and control flow between them, class diagrams to describe the informational aspect and object diagrams in order to show instantiation of the meta-model. At the PSM level, we use a business process specification language to specify the process to be implemented.

In the following, we describe the meta-model of the overall process and then we detail the different modeling perspectives covered.

4.3 The Process Meta-model of Inter-Organizational Processes

The meta-model described in Fig.4 as UML class diagram regroups the main concepts attached to the workflow process definition according to the WFMC¹ standards, and some concepts attached to SOA paradigm according to the OASIS² standards. The goal is to exhibit the relation between the main concepts related to the two technologies in order to guarantee a correct interconnecting between workflow processes using services, in a context of *subcontracting* relationship.

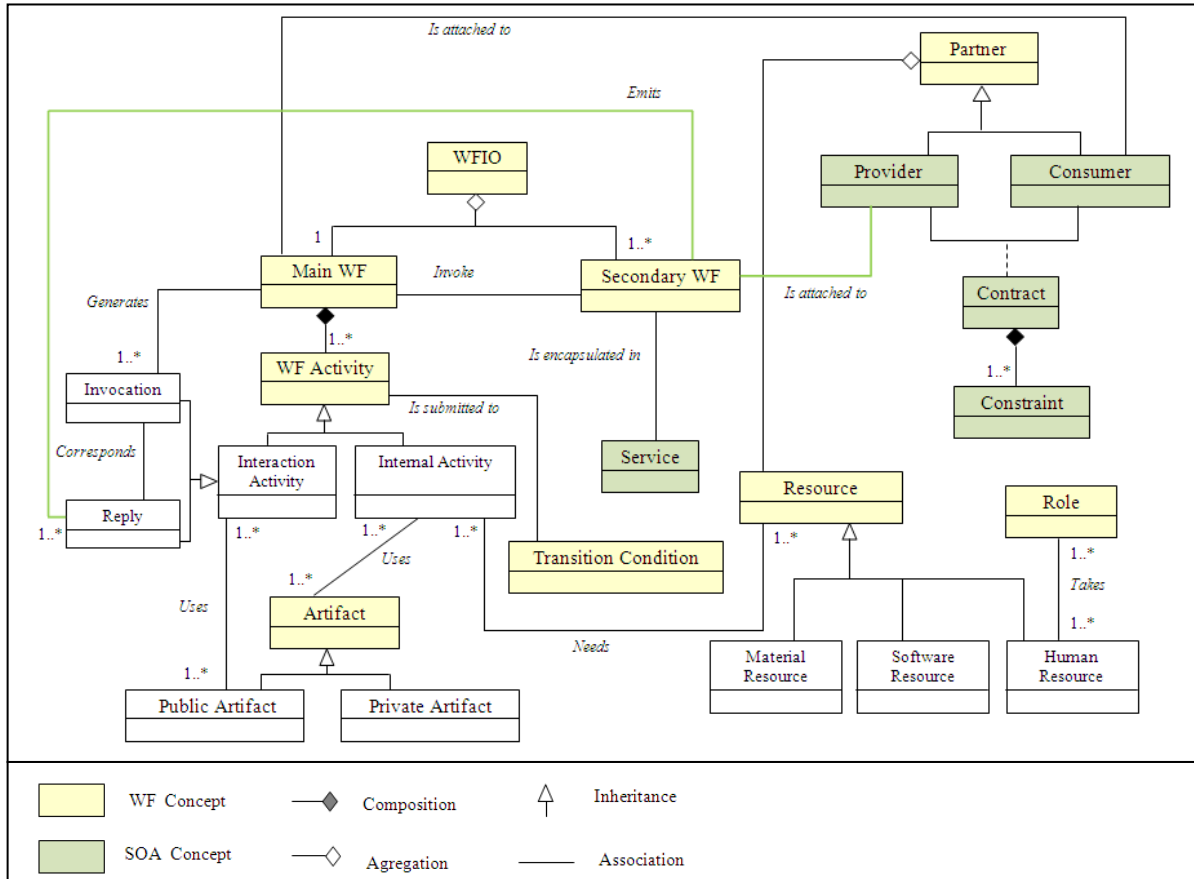

Fig 4. Global Meta-model according to the subcontracting architecture

In fact, an IOWF is a WF composed of a *main WF* and a set (one or more) of *secondary WF(s)*. The main WF defines the scheme of the overall process and triggers the execution of secondary WF through interaction activities (invocation). Seen from the main WF, the secondary WF is a simple activity but its implementation at the partner level that hosts it can be very complex.

In our approach, each secondary WF is encapsulated within a *service* because it is perceived from outside as a black box with only inputs and outputs visible. The main WF interacts with each secondary WF via *interaction activities* (invocation/reply). Other activities are internal ones and not visible from outside. With this vision, the partner that hosts the main WF becomes *consumer* of the service and the partner that hosts the secondary WF becomes *provider* of the service. This particularly follows SOA architecture limited to static cooperation since in our case, the partners implied in the cooperation are known a priori.

¹ WorkFlow Management Coalition – <http://www.wfmc.org>

² <http://www.oasis.org>

For WF process modeling, the WFCM and some works in the area like [Saikali, 2001] identified some modeling aspects covering all views of the process. These aspects are usually the process, the organizational and the informational aspects.

The meta-model of Fig. 4 covers all aspects mentioned above through a combination of WF concepts and SOA concepts and additionally, an *interactional aspect* in order to support the interaction between the main WF and secondary WF(s). For SOA paradigm, we introduce only the concepts those provide visibility and invocation of the service encapsulating the secondary WF. In the following, we detail each modeling aspect.

4.3.1 The Process Aspect

The process aspect covers the *functional* and the *behavioral* views of process modeling. As shown in Fig. 5, the process aspect describes on one hand, the aggregation of inter-organizational WF (IOWF) in terms of one *main workflow* and one or more *secondary workflow(s)*. Each WF process is structured into activities which are the smallest units of work controlled by the workflow management system (WFMS) at runtime level. *Activity* is the *central concept* of the meta-model linking the four views of process modeling.

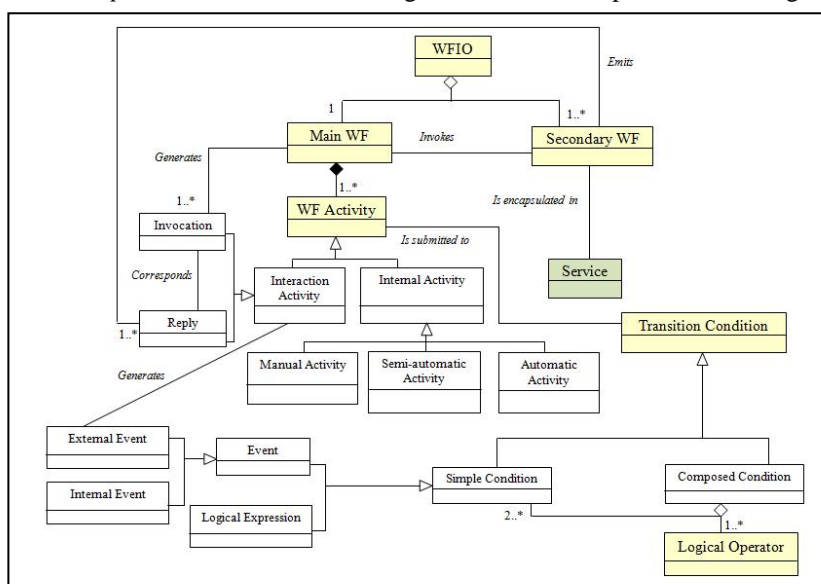

Fig. 5 The process aspect (functional and behavioral views)

On the other hand, the process aspect describes the control flow of activities, namely the disjunction points, the conjunction points and the synchronization points imposed by *transition conditions*; these are the pre-conditions for triggering activities. The execution order of activities is expressed through appropriate operators of control flow supported by the modeling formalism. A condition can be simple or complex, a *simple condition* is either a logical expression on the workflow data or an event (end of activity, an expiry time or an external event such as service invocation). A *composed condition* is expressed through two or more simple conditions and appropriate *logical operator* of flow control.

An activity may specialize in *internal activity* or *interaction activity*. Internal activity is controlled locally by the WFMS, it is supported by private resources of the partner that implements it. Internal activity can be *manual*, *semi-automatic* or *automatic*, this latter can be achieved by invoking an application or a service from the local information system. The secondary WF has the same structure as the main WF but it is completely encapsulated within a service.

4.3.2 The Organizational Aspect

The organizational aspect highlights the participants involved in the achievement of the inter-organizational process. It exhibits on one hand, the partners involved in cooperation that means the service *provider* and the service *consumer*. On the other hand, this aspect shows the internal resources of each WF implemented locally (see Fig. 4). Thus, each partner has a set of *resources* that specialize in human, material or software

resources. A human resource (or human actor) takes one or more role(s), the concept of *role* gives flexibility at the runtime level of the process when affecting activities instances to humans.

4.3.3 The Interactional Aspect

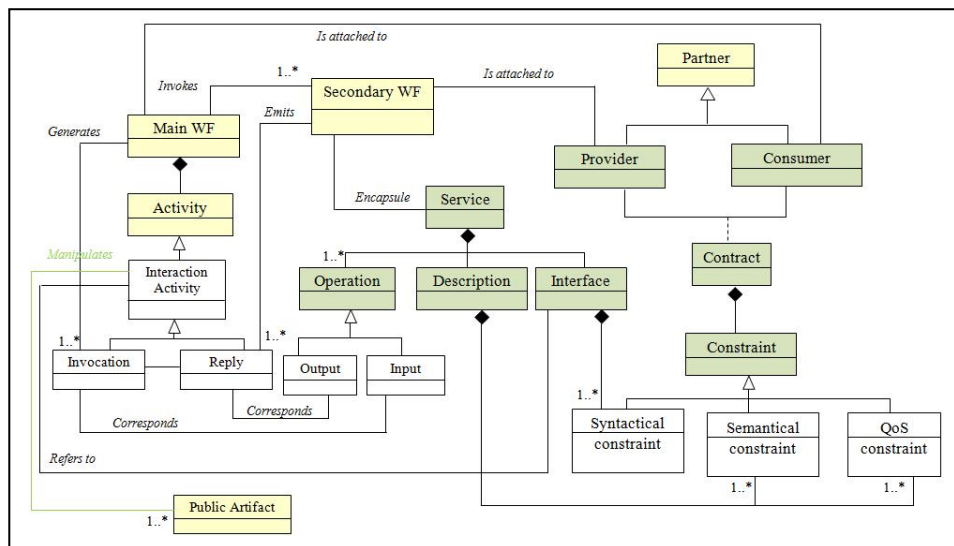

Fig. 6 Meta-model for the interactional aspect

Activities enabling communication between the main WF and the secondary WF are *interaction activities*: an *invocation* from the main WF to which corresponds a *reply* from a secondary WF (see Fig.6). From the service perspective, two operations allow interaction: an *input* operation which receives data for invocation and an *output* operation which transmits the service results. Input and output data are *public artifacts* manipulated by interaction activities.

The inter-organizational aspect is supported by the concept of *contract* defined through a set of *constraints* those can be for three kinds: syntactical, semantic and constraints of QoS (quality of service).

Service *interface* provides necessary and sufficient information for communication with the service; it specifies *syntactical constraints* (format of messages and technological information). Service *description* contains complementary information that ensures correct interaction, it contains *semantic constraints* and *constraints of QoS* (quality of service).

4.3.4 The Informational Aspect

The informational aspect is supported by the generic concept of *artifact* that can be specialized in data, file, form or any other document. In fact, an artifact represents any information used or produced when performing activities instances. In the context of IOWF, some artifacts are *public*, others are *private* (see Fig. 4). A *public artifact* can be seen and manipulated by interaction activities since it is accessible by all workflows implied in the cooperation. In our case, a public artifact is any information conveyed by messages during the invocations / replies between the main WF and secondary WF(s). By cons, a *private artifact* is visible only within one organization and can be handled only by the activities implemented locally, that means the internal activities handling both types of artifacts (public or private).

5. ILLUSTRATION OF THE APPROACH

In order to illustrate our approach, we present a simple example of inter-organizational process obeying the *subcontracting* architecture and we show the instantiation of the main concepts defined on our meta-model.

This section mainly illustrates the models levels shown in Fig.3. Thus for the PIM models, we just exhibit an activity diagram (see Fig.7) in order to describe activities, roles (using swimlanes), invocation of web services, control flow and data flow in the process; and an object diagram to highlight the concepts instantiated on our example. We also, express the correspondence between the main concepts of our meta-model and the concepts of jPDL, the language that we use for specifying the process of our example.

5.1 Description of the Process and Instantiation of Concepts

The process that we consider, involves two business partners respectively called EEPAD and AT providing internet access to customers. The EEPAD company implements a workflow processing customer requests, it needs to subcontract some of these requests with the AT company, especially when dealing with an application for novel connection to the internet. The inter-organizational process is outlined in Fig.7.

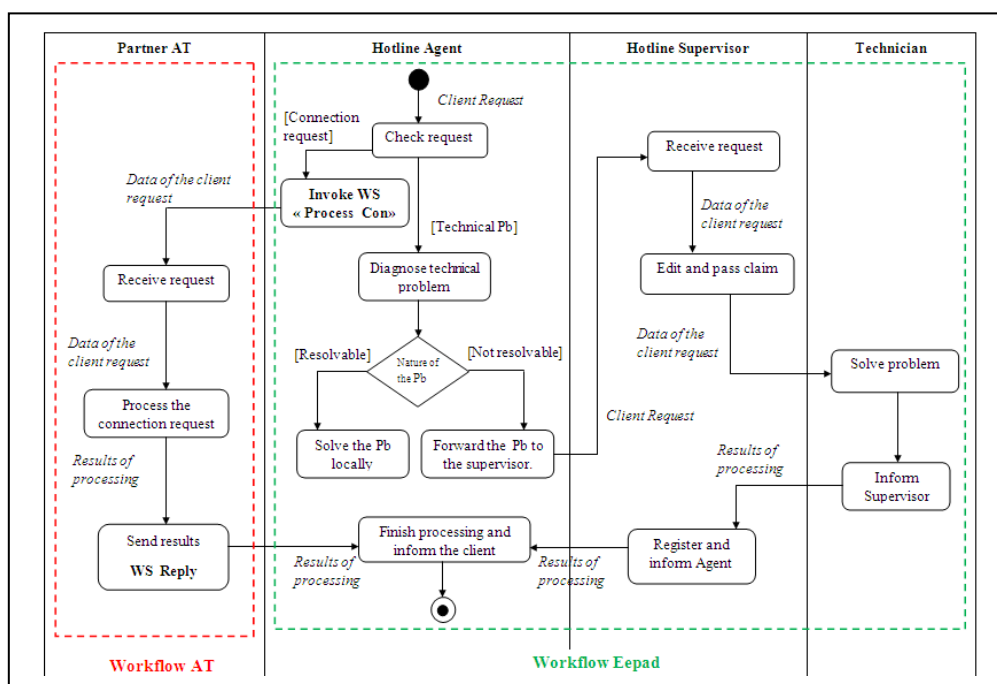

Fig 7. Activity diagram of the inter-organizational workflow EEPAD/AT

A client request arrives at the agent hotline of EEPAD, it is immediately checked. If this is a technical problem, it is diagnosed by the agent hotline who solves it locally if the problem is resolvable. Otherwise, the request is forwarded to the supervisor hotline who issues a complaint and sends it to the appropriate technician. The technician studies the request of the customer and tries to solve the problem. If the client request is a request to connect to the internet, it is forwarded (via web service invocation) to the AT company in order to process it through its local workflow, in the context of subcontracting cooperation between the two companies. The workflow process of AT is encapsulated in a web service and sends the results of processing a request to the EEPAD company that undertakes to complete the processing locally and finally, informs the client of the outcome of his application for internet connection.

Fig.8 bellow is an object diagram that shows the instantiation of the key concepts of the meta-model on the simple example previously described.

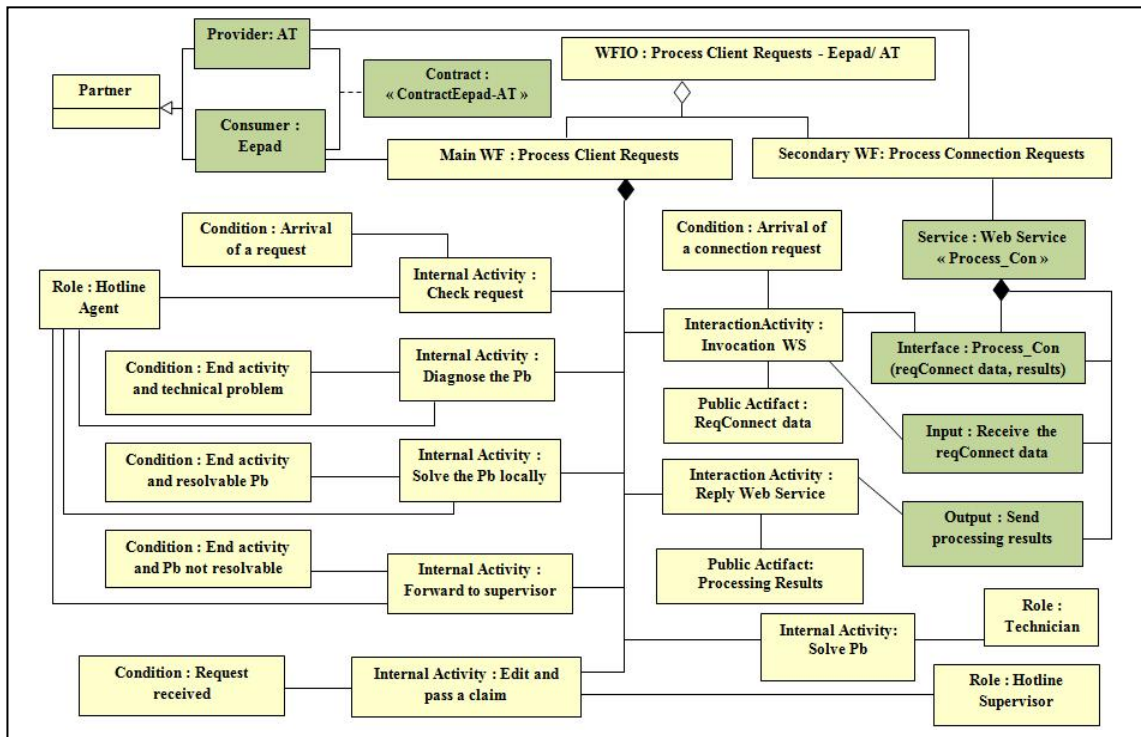

Fig. 8 Instantiation of the meta-model on the example –workflow EEPAD/AT

5.2 Implementation of the Process

To implement the inter-organizational process, we use a process definition language that allows implementation of the key concepts identified in the proposed meta-model. For that, we have specified the process of the previous example using jPDL³, a process definition language enabling the expression of automatic, manual and semi-automatic activities. This language is interpretable by the jBPM⁴ workflow engine which can run under the jBoss⁵ environment which allows the interfacing with web applications (mainly web services). In order to specify any application or *service* invoked by the process. Table 1 shows the correspondence between some jPDL concepts and the main concepts identified on our meta-model.

Table 1. Correspondence of concepts

Concept of the meta-model	Concept jPDL
Process	Process
Manual/ Semi-automatic activity	task-node
Automatic activity	Task
Role/ Human resource	Swimlane/ Actor
Artifact	Variable
Sequence	Transition
Operator of conjunction	Fork
Operator of synchronization	Join
Operator of disjunction	Decision

³ www.jboss.com/products/

⁴ www.jboss.com/products/jbpm/

⁵ www.jboss.org

Jpdl proposes the concept of “*process-state*” which allows the invocation of any application or service considered as a sub-process of the parent process (the invoker). The instance of the parent process stops running during the execution of the sub-process invoked and resumes execution when it is finished.

6. CONCLUSION

In our research works, we are interested in structured IOWF mainly based on architectures of cooperation defined in [Aalst, 1999], [Aalst, 2000]: *capacity sharing, chained execution, subcontracting, (extended) case transfer* and *loosely coupled*. These architectures which can be considered as basic patterns of IOWF models, include various forms of cooperation that can exist between business partners in the context of structured B2B cooperation.

Our ultimate objective is to achieve the adaptation of structured inter-organizational process models (basis on IOWF patterns) in order to support model’s changes in case of new business requirements. For that, we focus first on the issue of workflow interconnection; we adopt an approach based on services for interconnecting workflows, since services are software components loosely coupled, invoked and business oriented, thus the IOWF models remain flexible enough to allow easier adaptation.

In this paper, we have presented an approach based on services for interconnecting workflows according to the *subcontracting* architecture. Thus, we have described a scheme for interconnecting workflows using services, which is conceptually supported by a process meta-model.

The meta-model regroups workflow concepts and SOA concepts and supports two kinds of activities: *internal activities* and *interaction activities* (invocation/reply) for the support of the interactional aspect. Through an instantiation mechanism, the meta-model is used for generating process models related to a specific process of the real world. These models are of two kinds: PIM models described by appropriate UML diagrams and PSM models expressed through appropriate specification language.

For illustration, we have presented a simple example of inter-organizational process and we have shown instantiation of the main concepts using an object diagram. We have specified the process with jPDL, a language for business process definition allowing the definition of manual, semi-automatic and automatic activities and the invocation of web services under the jBPM workflow engine and the jBOSS environment. Also, we have shown a correspondence between some concepts of the proposed meta-model and the jPDL concepts.

We are currently working to generalize our approach for interconnecting workflows using services, to support other specific architectures of structured inter-organizational workflows like *chained execution, (extended) case transfer* and *loosely coupled* architectures.

Once we have established all schemes of workflow interconnection, we intend to focus on the definition of formalism for expressing basic IOWF patterns and we will work on adaptation of IOWF models.

REFERENCES

- (Aalst, 1999): Aalst W.V.D., 1999, Process-oriented architectures for electronic commerce and interorganizational workflow, *Journal of Information systems*, Copyright Elsevier Sciences.
- (Aalst, 2000): Aalst W.V.D., 2000, Loosely Coupled Interorganizational Workflows: modeling and analyzing workflows crossing organizational boundaries, *Journal of Information and Management*, 37(2): 67-75.
- (Aalst, 2002): Aalst W.V.D., 2002, *Workflow Management: Models, Methods and Systems*, The MIT Press. Cambridge, Massachusetts, London, England.
- (Alonso et al, 2004): Alonso G., 2004, Casati F., and Kuno H., Web services: concepts, architectures and applications, Springer Verlag, Heidelberg, Germany.
- (Amirreza, 2009): Amirreza T., 2009, *Web Service Composition Based Interorganizational Workflows*, Sudwestdeutscher Verlag fur Hochschulschriften edition, ISBN 9783838106700.
- (Arjanjani et al, 2008): Arjanjani A., Ghosh S., Allam A., Abdollah T., Ganapathy S., and Holley K., 2008. A Method for Developing Service Oriented Solutions. *IBM Systems journal*, 47(3): 377-396.
- (Belhajjame et al, 2005): Belhajjame K., Vargas-Solar G., and Collet. C., 2005. Pyros - an environment for building and orchestrating open services. In *SCC '05 : Proceedings of the 2005 IEEE International Conference on Services Computing*, pages 155–164, Washington, DC, USA, IEEE Computer Society.

- (Casati et al, 2000):** Casati F., Ilnicki S., Jin L., Krishnamoorthy V., Shan M.C., 2000. Adaptive and Dynamic Service Composition in eFlow, *HP- Laboratories. HLP-2000-39*.
- (Chebbi et al, 2006) :** I. Chebbi, S. Dustdar, S. Tata, 2006. The view based approach to dynamic inter-organizational workflow cooperation, *journal of Data and knowledge engineering*, volume 56, pp. 139-173.
- (Chebbi, 2007) :** Chebbi I., 2007. *CoopFlow* : An approach for workflow ascending cooperation in virtual enterprises. PhD thesis- National Institute of Telecoms, France.
- (Chen et al, 2005):** Chen M., Zhang D., Zhou L., 2005. Empowering collaborative commerce with web services enabled business process management system, *Decision Support System*, www.sciencedirect.com
- (Crusson, 2003):** Crusson T., 2003. Business Process Management : from modeling to execution, positioning in relation to SOA www.intalio.com.
- (Decker et al, 2007):** Decker G., Kopp O., Leymann F., and Weske M., 2007. Bpel4chor:Extending BPEL for modeling choreographies, *In Proceedings of the 2007 IEEE International Conference on Web Services (ICWS 2007)*: 296–303. IEEE Computer Society,
- (Gorton et al, 2009):** Gorton S., Montangero C., Reiff-Marganiec S., and Semini L., 2009. StPowla: SOA, Policies and Workflows, *ICSOC 2007 workshops, LNCS 4907*: 351-362.
- (Jordan et al, 2006):** Jordan D., Evdemon J., 2006. Web services business process execution language version 2.0, *W3C*.
- (Levan, 2000):** Levan S.K., 2000. *The workflow project - concepts and tools for organisations*, Second edition, Eyrolles,
- (Leymann et al, 2002):** Leymann F., Roller D., and Schmidt M.T., 2002. Web Services and Business Process Management, *IBM Systems Journal*, 41 (2).
- (Lopez-Sanz et al, 2008)** Lopez-Sanz M., Acuna C.J., Cuesta C.E., and Marcos E., 2008. Modelling of service oriented architectures with UML, *Electronics Notes in Theoretical Computer Science*, 194(2008): 23-37.
- (Mehandjiev et al, 2005):** N. Mehandjiev, I. Stalker, K. Fessl, and G.Weichhart. 2005. Interoperability contributions of crosswork. *In invited short paper to Proceedings of INTEROP-ESA '05 Conference, Geneva, Springer-Verlag*.
- (Papazoglou et al, 2007):** Papazoglou M. P., and Heuvel W., 2007. Service Oriented Architectures : approaches, technologies and research issues, *Springer Verlag, The VLDB Journal*, 16: 389-415.
- (Peltz, 2003):** Peltz C., 2003. Web Services Orchestration and Choreography. *IEEE Computer*, 36(10):46-52.
- (Perrin et al, 2004):** Perrin O., and Godart C.. 2004. A model to support collaborative work in virtual enterprises. *DataKnowledge Engineering*, 50(1) :63–86.
- (Saikali, 2001) :** K. Saikali, 2001. Flexible workflows using the object approach : 2flows, a framework for flexible workflow. PhD *Thesis, central school of Lyon, France*
- (Virdell, 2003):** Virdell M., 2003. Business Processes and Workflow in the Web Services World. *IBM Developer Works*,