



HAL
open science

Energy and Material Flow Analysis of Binder-jetting Additive Manufacturing Processes

Xu Xin, Simon Meteyer, Nicolas Perry, Yaoyao Fiona Zhao

► **To cite this version:**

Xu Xin, Simon Meteyer, Nicolas Perry, Yaoyao Fiona Zhao. Energy and Material Flow Analysis of Binder-jetting Additive Manufacturing Processes. *Procedia CIRP*, 2014, 15, pp.19-25. 10.1016/j.procir.2014.06.030 . hal-01064197v2

HAL Id: hal-01064197

<https://hal.science/hal-01064197v2>

Submitted on 26 Jun 2015

HAL is a multi-disciplinary open access archive for the deposit and dissemination of scientific research documents, whether they are published or not. The documents may come from teaching and research institutions in France or abroad, or from public or private research centers.

L'archive ouverte pluridisciplinaire **HAL**, est destinée au dépôt et à la diffusion de documents scientifiques de niveau recherche, publiés ou non, émanant des établissements d'enseignement et de recherche français ou étrangers, des laboratoires publics ou privés.



Science Arts & Métiers (SAM)

is an open access repository that collects the work of Arts et Métiers ParisTech researchers and makes it freely available over the web where possible.

This is an author-deposited version published in: <http://sam.ensam.eu>
Handle ID: <http://hdl.handle.net/10985/8523>

To cite this version :

XU XIN, Simon METEYER, Nicolas PERRY, Yaoyao Fiona ZHAO - Energy and Material Flow Analysis of Binder-jetting Additive Manufacturing Processes - Procedia CIRP - Vol. 15, p.19–25 - 2014

Any correspondence concerning this service should be sent to the repository

Administrator : archiveouverte@ensam.eu

Energy consumption model of Binder-jetting additive manufacturing processes

Xin Xu^a, Simon Meteyer^b, Nicolas Perry^c, Yaoyao Fiona Zhao^{a*}

^a *McGill University, Montreal, H3A 0C3, Canada*

^b *Arts et Métiers ParisTech, Paris, France*

^c *Arts et Métiers ParisTech, I2M Université de Bordeaux - UMR 5295, Talence, France*

* Corresponding author. Tel.: +1-514-398-2523; fax: +1-514-398-7365. E-mail address: yaoyao.zhao@mcgill.ca

Energy analysis of Binder-jetting Additive Manufacturing Processes

Considering the potential for new product design possibilities and the reduction of environmental impacts, Additive Manufacturing (AM) processes are considered to possess significant advantages for automotive, aerospace and medical equipment industries. One of the commercial AM techniques is Binder-Jetting (BJ). This technique can be used to process a variety of materials including stainless steel, ceramic, polymer and glass. However, there is very limited research about this AM technology on sustainability aspect. This paper presents a method to build an energy consumption model for printing stage of BJ process. Mathematical analyses are performed to find out the correlation between the energy consumption and geometry of the manufactured part. Based on the analyses, total energy consumption is calculated as a function of part geometry and printing parameters. Finally, test printing is performed to check the accuracy of the model. This process model provides a tool to optimize part geometry design with respect to energy consumption.

Additive manufacturing; Binder-jetting; energy analysis; part geometry

Subject classification codes: include these here if the journal requires them

Abbreviation List

DTO: Define & transmit orders to subsystems.

PP: Part Printing.

PC: Part Curing.

PS: Part Sintering.

DPL: Dry printed layer.

SNL: Spread new layer.

PNL: Print new layer.

I1: Print powder

I2: Binder

I3: Cleaner

O1: Printed part

O2: Waste of binder

O3: Waste of cleaner

1. Introduction

In the past few decades, Additive Manufacturing (AM), also known as 3D printing technology, has drawn more and more attention from the industrial world. Many case studies have showed AM technologies' advantage in manufacturing of short series of customised products [1]. Compared with traditional subtractive manufacturing, AM has three main advantages:

(1) Freeform fabrication: AM remove the traditional manufacturing restrictions and provides the design freedom for innovative product [2].

(2) Short supply chain: AM can reduce the supply chain of fabrication and enhance profit space for manufacturers [3].

(3) Sustainable manufacturing: AM has a huge potential to reduce the environmental impact that normal manufacturing has [4].

Because of these promising characteristics, AM has been employed in industry for some time and plenty of researches have been conducted on the aspect of process control and product quality. However, while claiming the advantage on the environmental aspect, there is still very limit research on the sustainability aspect of this

technology. Another issue is because of the lack of well documented life-cycle data, it is difficult to conduct an exact Life-Cycle Assessment (LCA) or sustainability analysis for AM technologies. To take a step forward in the sustainability area, this paper provides a method to calculate energy consumption of printing process for Binder-Jetting (BJ) [5] technology and based on part design and printing parameters. This research contributes to a better understanding on the sustainability aspect of the BJ process. Furthermore, this research also develops an approach to calculate energy data by virtual manufacturing. Thus, similar models for other AM technologies can also be derived from this method.

This paper is organized as follows: first the background of BJ technology is introduced. Previous works relevant to process energy calculation, virtual manufacturing and part slicing techniques are summarized to illustrate the context and meaning of this research. Secondly, a method to calculate printing energy in BJ process correlating to part geometry and printing parameters is presented. The workflow of this model is described step by step. Sub-processes of printing are introduced and analysed as well. Test printings are conducted to check the accuracy of the model. Finally, conclusions are drawn, results are documented and future outlooks are discussed.

1.1. BJ AM technology

In order to abstract the process flow from the actual BJ technology, the first task is to understand how this technology fabricates functional parts from raw materials.

Binder-jetting is one of commercial 3D printing technologies. This technology was originally developed at MIT in the 1990s [6] and commercialized in 2010. It can handle materials including sand, polymer, glass and metal. Printing process of BJ technology can be divided into the following steps: printing, curing, de-powdering, sintering, infiltration, annealing and finishing.

The core step of BJ which different it from other AM technologies is the printing process. Fig. 1 shows a schematic view of the BJ printing process of BJ. The printing system is made up by a printing bed, a feed bed, a roller, a drying unit, and a print head.

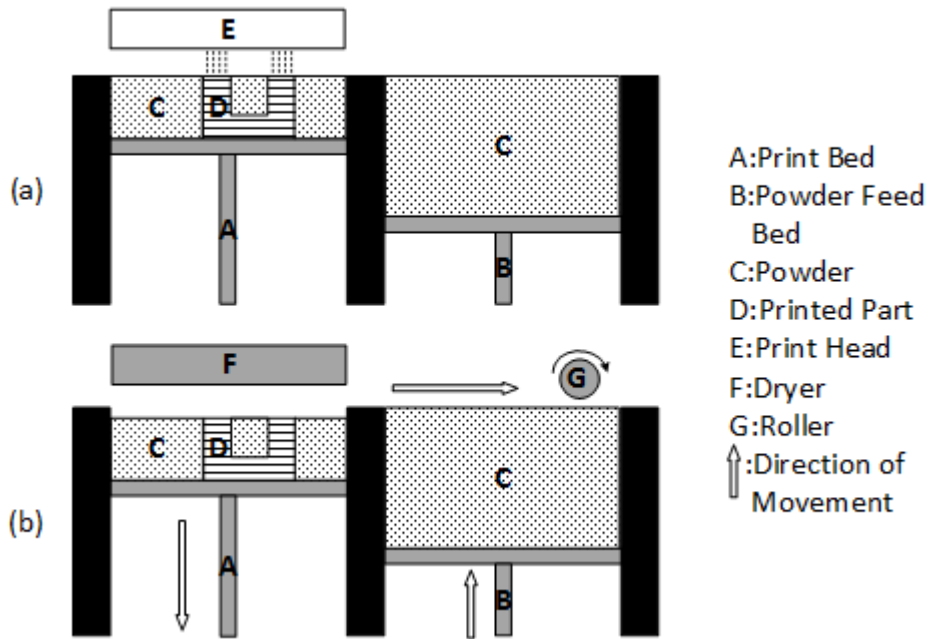

Fig. 1: Printing system of BJ technology: (a) printing (b) drying and spreading

The whole printing process work as follows: the print head first start to jet binder onto loose powders according to layer profile. (shown in Fig. 1 (a)) When one layer is finished, step motor system places the layer under an electrical infra-red heater to remove excessive binder. The next step is shown in Fig. 1 (b), the printing system lower printing bed one layer thickness and feed bed rise. Then the roller evenly spreads a new layer of powder over the printed layer. This process is repeated layer by layer until a part being fully built.

1.2. Relevant works

Despite BJ has already gained popularity as a mainstream commercial AM technology, there is still very limited reported research about the correlation between the part

geometry, process parameters and energy consumption. Researches about energy consumption of other AM technologies offer valued experience to conduct research in this field. Quite a few researches are performed on this topic. A few of them which are closely related to this research are reviewed here.

Kellens et al. [7] developed a method under the framework of CO2PE! to obtain Life-Cycle Inventory (LCI) data for the use phase of manufacturing unit processes. A method called **in-depth approach** is presented in their research to calculate LCI data. In the in-depth approach, the total process energy consumption is calculated based on a time study and a power study, which is used as the principle of energy calculation in this research. Paul and Anand [8] analysed energy consumption of Selective Laser Sintering (SLS) by modelling a virtual manufacturing of a part and correlating the laser energy to part geometry, slice thickness and part orientation. The laser energy is calculated from the total sintering area. However, this paper only concentrates on laser energy. And this method cannot be used to calculate the whole energy consumption of SLS. Singhal et al. [9] performed a research on the optimum part deposition orientation for Stereolithography (SLA) and SLS process to achieve the best surface quality of part. In their research, the build time of part is determined by the deposition orientation and part geometry. Mognol et al. [10] tested the manufacturing parameters' influence on energy consumption of three Rapid Prototyping (RP) system: Thermojet (3DS), FDM 3000 (Stratasys) and EOSINT M250 Xtended (EOS). Their research showed the height of the part has significant effects on the total energy consumption. Choi and Chan [11] studied a virtual prototype system with RP technology. A layer-based simulation methodology was developed in this paper to conduct virtual manufacturing and to investigate the relation between process parameters and surface quality. Kulkarni and Dutta [12] investigated the slicing procedure of layer manufacturing and suggested a

solution to improve geometric accuracy. The uniform external slicing approach represented in their paper is adapted in this research.

The researches reviewed above only analysed the printing process from the layer slicing point of view for a few AM technologies. Their research did not pay attention to the correlation between total printing time, energy consumption, part geometry and process parameters. In this research, the total printing time is calculated through virtual manufacturing process. It is modelled as a function of part shape, print orientation, slice thickness and process parameters. Based on the time study and power data of sub processes, the total energy consumption is calculated.

2. Method

This section describes the method to calculate the energy consumption in printing process of BJ by modelling the virtual manufacturing of a part and estimating the energy consumption with part shape and printing parameters. The overall workflow of the proposed method for calculating printing process energy is shown in Fig. 2.

As shown in Fig. 2, a part is firstly created by a CAD system and exported as an STL file which is a standard CAD exchange file format. Then, part orientation and slice layer thickness are defined to slice the STL file. The intersection contour of each layer is calculated. Based on the contour information, an operation list containing execution order of sub-processes for the corresponding layer printing is generated. By adding up all slices, the operation list for the whole printing process is achieved. With the energy and power data of the sub processes, the total printing energy is calculated from the printing operation list which correlates to the part geometry, printing orientation and layer thickness. The steps of the method are illustrated in detail in the following sections.

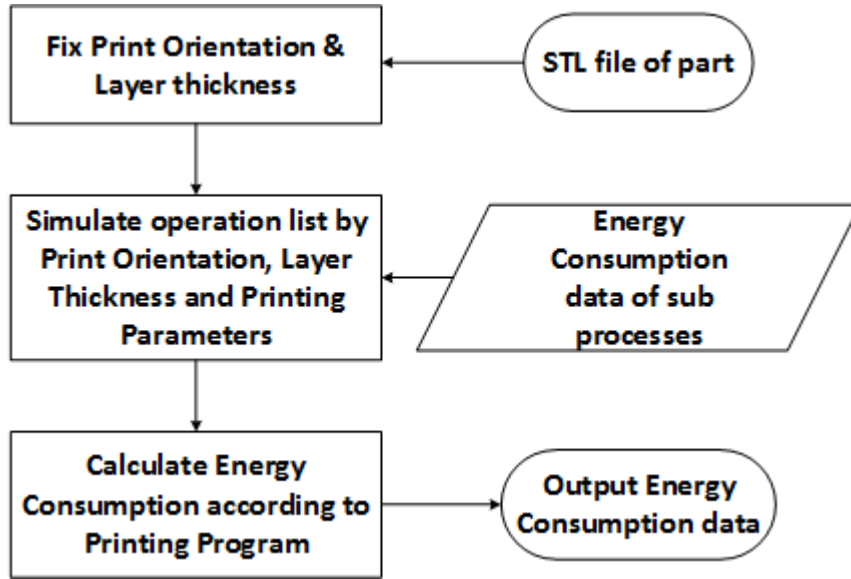

Fig. 2: Workflow of Energy simulation

2.1. Energy of printing process

The total energy consumption can be obtained by calculating energy consumption of each sub-process and summing them together. From this point, the required energy input of printing process of BJ is given as Eq.1:

$$E = \sum_{i=1}^{n_p} E_i \quad (1)$$

Where E is the total process energy consumption, E_i is the energy consumption of sub-process i , $i = 1,2,3 \dots n_p$ and n_p is the number of sub-processes.

The sub-processes are a set of independent operations which fulfil the following requirement: by combining in a specific sequence, they can represent every printing process of the BJ machine. IDEF0 methodology is applied to identify the sub-processes. The printing process is analysed by decomposing the operations into sub operations. When the above requirement is fulfilled, the decomposition stops. The IDEF0 [13] diagrams of printing are shown in Fig. 3 below.

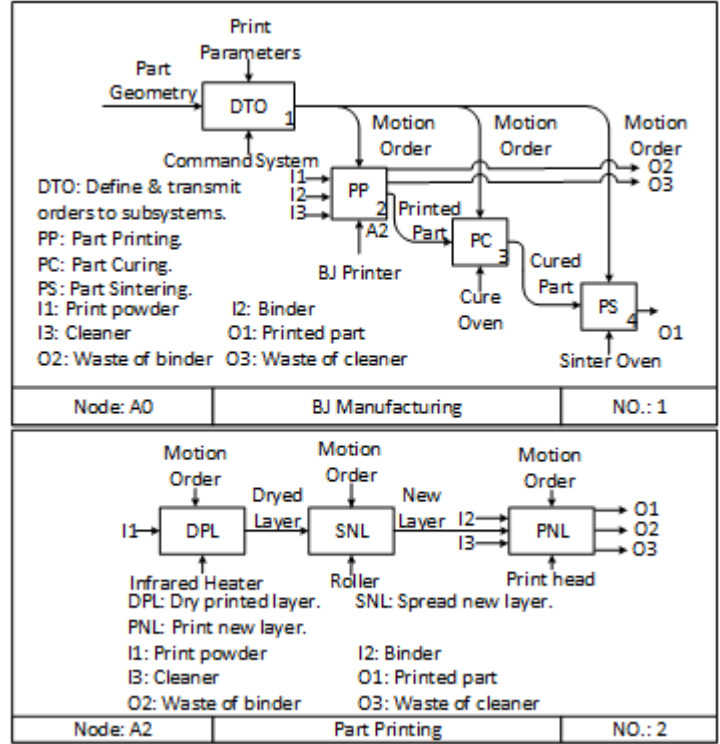

Fig. 3: IDEF0 diagram of BJ process

In Fig. 3, the printing operation is decomposed into three sub operations: dry printed layer, spread new layer and print new layer. Any printing process can be represented by a linear combination of these three operations in a specific order. Therefore, the sub-processes of BJ printing are: printed layer drying, new layer spreading and new layer printing.

The only power supply for the BJ printing process is electric power. Therefore the energy consumption then can be calculated as: $E_i = \int_{t_{i,S}}^{t_{i,E}} P_i(t) \cdot dt$. Substituting the value of E_i , Eq.1 can be modified and rewritten as:

$$E = \sum_{i=1}^{n_p} \int_{t_{i,S}}^{t_{i,E}} P_i(t) \cdot dt \quad (2)$$

Where i is the number of sub-process, $t_{i,S}$ is the start time of sub-processes, $t_{i,E}$ is the end time of sub-process, $P_i(t)$ is the electrical power of sub-process i .

Eq.2 provides a mathematical formula to calculate the total printing energy by integrating the time of sub-process power and summing them together. The next

sections describe the proposed method to calculate the operation list and determine the time distribution of sub-process for a given part geometry, printing orientation and layer thickness.

2.2. Slicing of STL file

AM produces part layer by layer. Hence, before printing, part is sliced to obtain the information of each layer contour. In BJ process, the slicing of part can be achieved in two ways[12]: externally and internally. The external slicing is used in this research because the extra material can be removed by finishing operation to get an accurate part, which is impossible for the internal slicing.

2.3. Operation list and sub-process timeline

The operation list is an array of operation cells which arranged in a specific order. By conducting sub-processes in this order, a designed part is fabricated. Fig. 4 shows the structure of operation cell. An operation cell is made up with four features:

- (1) Operation type: for BJ, operation type can be one of the sub-processes: drying of printed layer, spreading of new layer and printing of new layer. For other AM technologies, this method can also work by changing the sub-process set.
- (2) Geometry parameters: information of layer contour which is obtained by slicing the part.
- (3) Non-geometry parameters: process parameters which are defined by user.
- (4) Operation Time: duration of the operation. It is determined by the operation type, geometry parameters and non-geometry parameters.

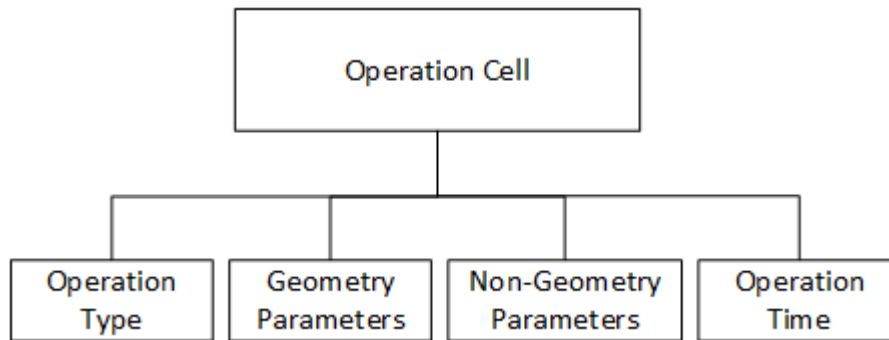

Fig. 4: Structure of operation cell

The sub-process time line is a list which contains start time and end time for each sub-process. This list is determined by the sequence and duration of the operation. Operation list and sub-process time line are calculated from a virtual manufacturing loop.

Fig. 5 shows the program of calculation. Firstly, information of layer contour is loaded. Then the virtual manufacturing loop starts. The part is printed out layer by layer. For each layers printing, three sub-processes are conducted orderly as shown in the IDEF0 diagram (Fig. 3). When a virtual sub-process takes place, it is added into the operation list and assigned to **Operation j.Type** where j represents the number of operation. After this, the start time and end time of the sub-process are also calculated out, added into sub-process timeline and tagged as **Operation j.StartTime** and **Operation j.EndTime** respectively. After the virtual manufacturing is finished, the operation list and sub-process timeline are exported for energy calculation.

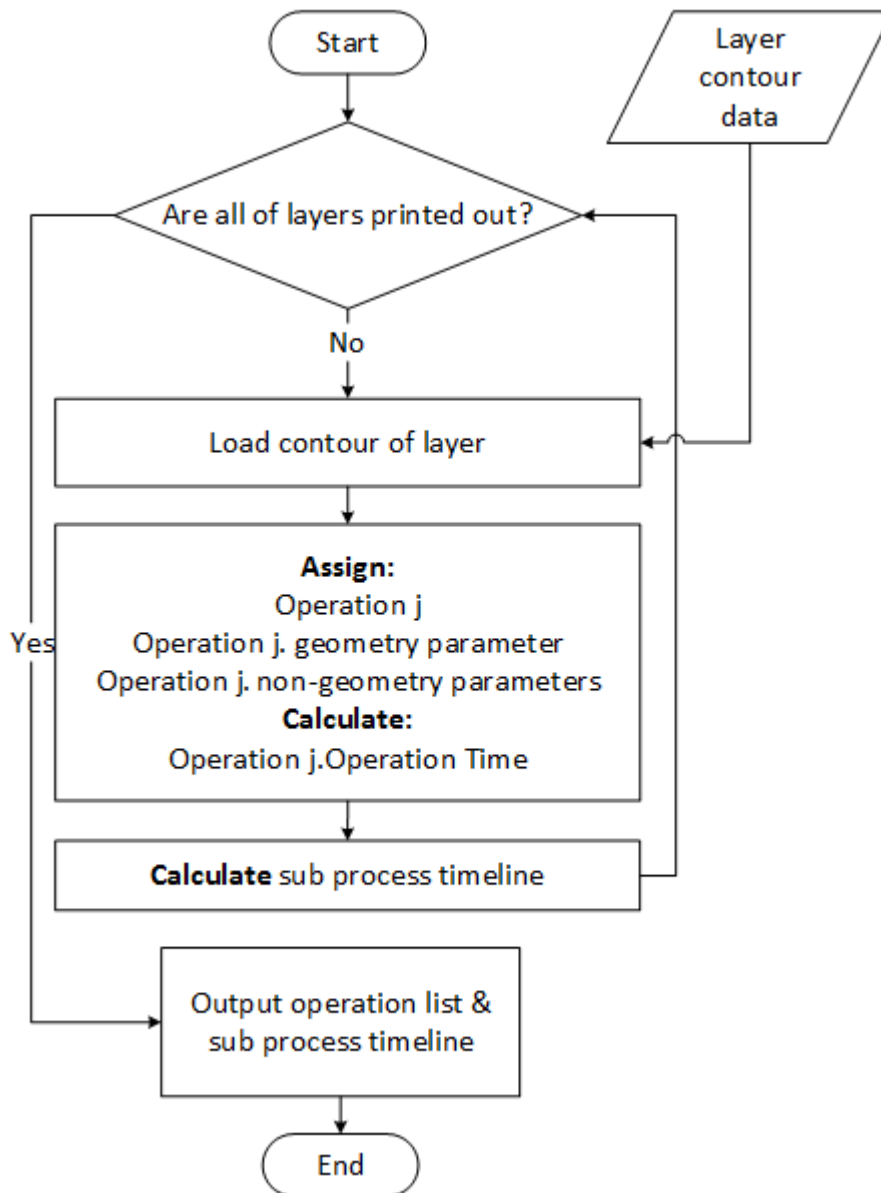

Fig. 5: Calculation of operation list and sub-process

2.4. Operation Time

As defined in the former part, the operation time is the duration of sub-process. It's a function of geometry parameters and non-geometry parameters. For BJ, the sub-processes of printing are: drying of printed layer, spreading of new layer and printing of new layer. The durations of them are calculated as follows.

- Drying of printed layer:

In order to remove excessive binder, after each layer being printed out, the printing bed moves to under beneath the dryer to evaporate the undesired binder. The duration can be different for different layers. The operation time of drying of new layer is determined by the non-geometry parameter which is defined by the user of printer.

- Printing of new layer:

Fig. 6 shows an example of layer contour during the printing process. The print head moves along the Y axis and print out the layer bar by bar, which is similar to inkjet printer. The operation time of new layer printing is determined by the geometry parameter: maximum value of Y of the layer contour. The correlation between them which obtained from experiments is:

$$t_p = 0.09 \times Y_{max} + 23.767 \quad (3)$$

Where t_p is the operation time of new layer printing (s), Y_{max} is the maximum value of Y (mm).

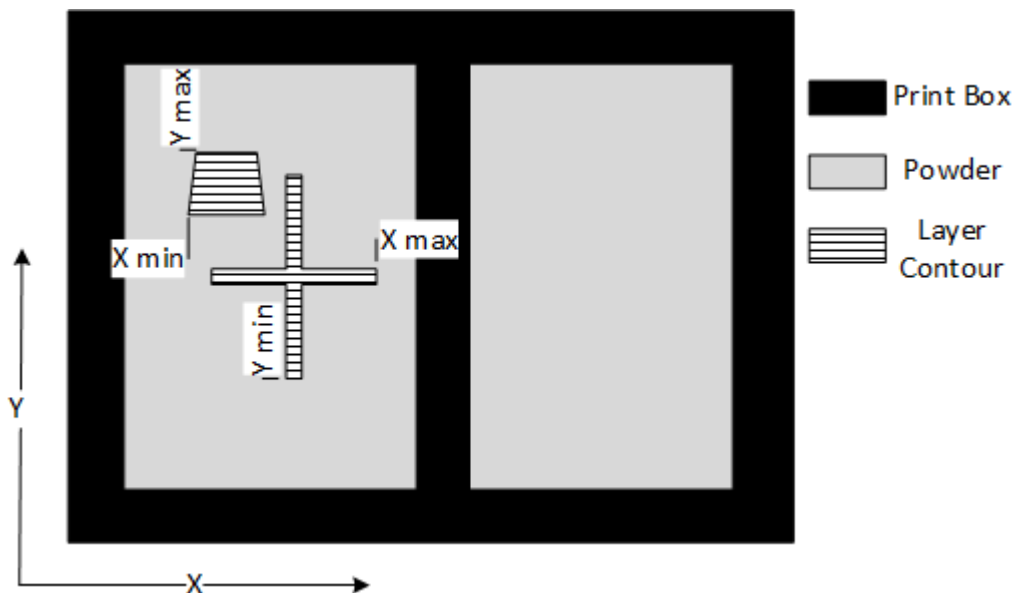

Fig. 6: Schematic of print layer

- Spreading of new layer:

Spreading is conducted by moving printing bed along X axis (shown in Fig.6).

The operation time of new layer spreading t_s is calculated as:

$$t_s = \frac{(X_{left} + X_{right} + X_{max} - X_{min})}{V_s} + \frac{120 - (X_{left} + X_{right} + X_{max} - X_{min})}{V_{rs}} \quad (4)$$

Both geometry parameters and non-geometry parameters have influence on the spreading time. The geometry parameters are the minimum value and maximum value of X of the layer contour X_{min} and X_{max} respectively. The non-geometry parameters are the spread speed V_s , spreader rapid traverse speed V_{rs} , left spreader rapid traverse border X_{left} and right spreader rapid traverse border X_{right} .

The spreading is conducted under rapid traverse speed from the right end. When the roller arrives at $X = X_{max} + X_{right}$, it switches to slow spreading mode until roller arrives at $X = X_{min} - X_{left}$. Then it switches back to fast spreading mode and traverse to the left end of the printing bed.

2.5. Power of sub-processes

Powers of sub-processes are measured by experiments. Table 1 shows the average values of each sub-process. As both process time and power are obtained, the energy consumption of printing can be computed now.

Table 1: Power of sub-processes

Sub-process	Power (W)
Spreading	163.26
Drying	159.61

3. Case study and Result

This section discusses the case studies conducted to validate the proposed energy consumption estimate method. A cylinder is used as the case study design. The result of power and energy simulation from the proposed model is compared to the experimental data to check the accuracy of the model. The cylinder part is generated by SolidWorks 2013 and exported as a STL binary file. The process parameters are chosen as follows:

Layer thickness: $100 \mu\text{m}=1\text{e-}4 \text{ m}$.

Spread speed and drying time: This spread speed (V_s) and drying time are shown as the following Table 2:

Table 2: Spread speed and drying time

Layer	1-10	11-15	16-20	21-25	26-35	>35
Spread speed(mm/s)	1	3	5	10	15	20
Drying time (s)	50	40	40	30	30	30

Spreader rapid traverse speed (V_{rs}): 25 mm/s.

Left spreader rapid traverse border X_{left} : 5mm; right spreader rapid traverse border X_{right} : 5mm.

3.1. Case study of Cylinder

The energy and power simulation are performed on a test of cylinder of radius 1.5 mm and height 4 mm. Two values of printing orientation are considered: 0.00° and 90.00° . For a cylinder, the printing orientation refers to the angle γ between the build orientation vector \vec{Z} and the normal vector of the top surface \vec{n}_t as shown in Fig. 7 (a) and Fig. 7 (b). The Printing height is longest projection length of part on build orientation. The Fig. 7 (c) and Fig. 7 (d) show the comparisons between simulated

power and experiment records for 0.00° and 90.00° respectively.

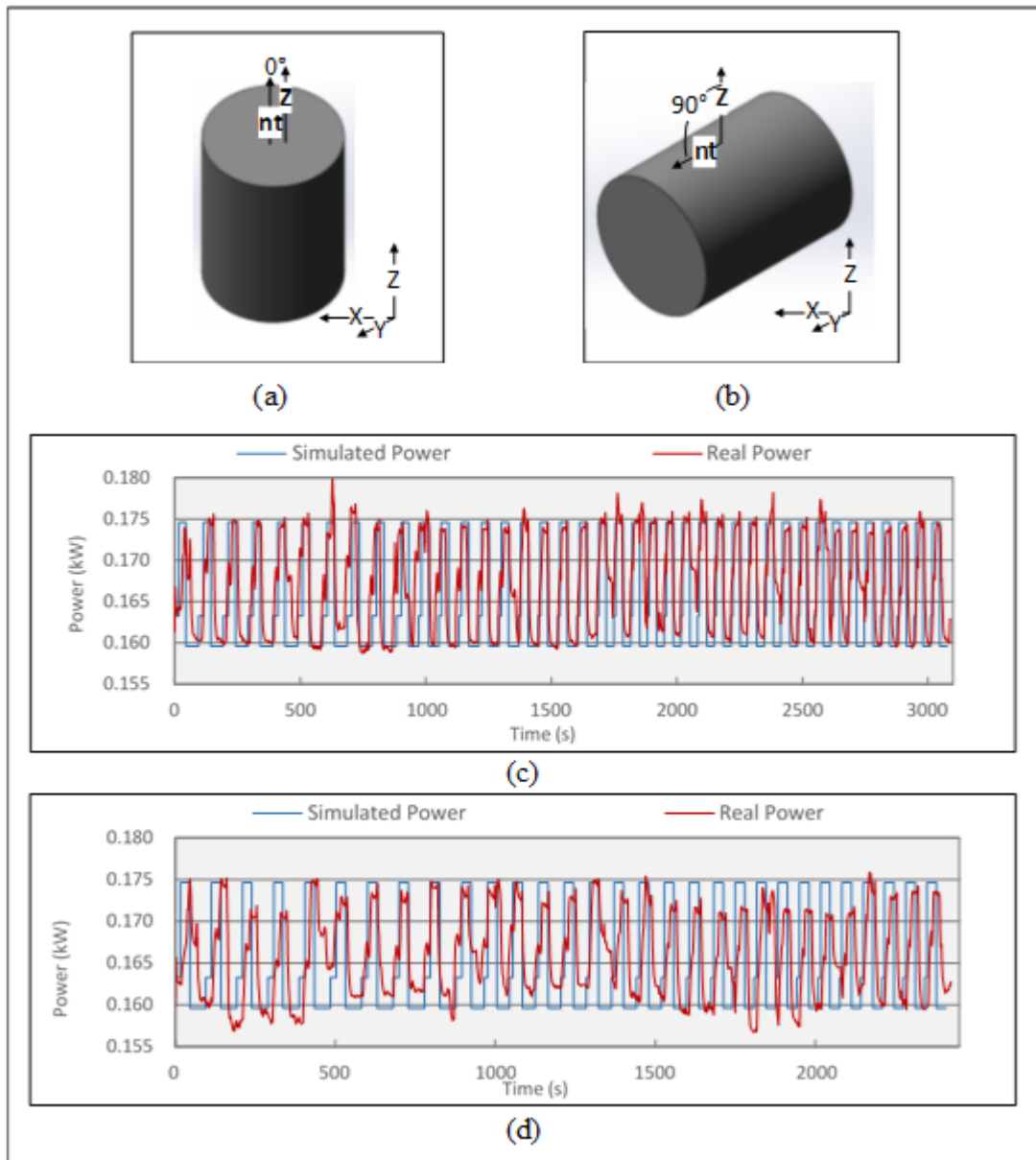

Fig. 7: Print Power Curve

In Fig. 7 (a), the cylinder is printed out along its' axis. As the height of the cylinder is 4mm and the thickness of each layer is $100 \mu\text{m}$, the printing height of this part is 4mm and the cylinder was printed out by 40 layers. This process is reflected by the power curves in Fig. 7 (c) which are respect to the situation of $\gamma = 0.00^\circ$. On both of the simulated power curve and experimental power curve, there are 40 spikes. Each of the spikes stands for the printing process of one layer. Likewise, Fig. 7 (b) and Fig. 7

(d) shows the cylinder is printed out by 30 layers and the printing height is 3mm while $\gamma = 90.00^\circ$.

Table 3: Printing time and energy

Printing Orientation	Simulated print time (s)	Real print time (s)	Accuracy (%)
0°	3076.00	3087.00	99.64%
90°	2408.00	2424.00	99.34%

Printing Orientation	Simulated printing Energy (kJ)	Real print Energy (kJ)	Accuracy (%)
0°	510.24	515.29	99.02%
90°	398.95	408.61	97.64%

Table 3 shows the total printing time and energy estimate for the two different print orientation. From the simulation result of the cylinder, the following inferences on printing time, process energy consumption and print orientation can be drawn as following:

The printing height is determined by part geometry and print orientation. The increase of printing height results in increase of process energy consumption. This is due to the grater printing height lead to a larger number of printed layers which results in a greater printing time. As the average power of the whole printing process is 168 W, the increase of printing time will raise the process energy consumption significantly. According to Table 3. The process energy consumption for $\gamma = 90.00^\circ$ is 20.7% less than the energy consumption for $\gamma = 0.00^\circ$.

4 Conclusions and future scope

This paper presents a modelling method to calculate the total printing energy consumption of BJ technology and to correlate the energy with part geometry, layer

thickness and part orientation. The energy is calculated based on the data of time study and power study. The time study is performed through a virtual manufacturing process and part is sliced by an external slicing approach. One simple cylinder was virtually printed and the printing energy is calculated for different printing orientation. The results are compared with real experiment data to check the accuracy of the model. According to the comparison, the accuracies of time and energy simulation are higher than 99.3% and 97.6% respectively. Thus, the model can effectively simulate the manufacturing process of BJ technology and get a valid result. As the method developed in this paper provides a quick approach to calculate the energy consumption of specific design before real manufacturing, part can be optimized at the designed stage to achieve better energy performance thereby reducing the “energy footprint” of the BJ technology. By providing the energy data, this model can also contribute to sustainability assessment of BJ technology, which helps to gain a deeper understanding of the new technology of AM. The energy calculation method present here can also be easily used for other AM processes such as SLA, SLS and Electron Beam Melting (EBM) with minor modification of operation type and time and power study.

In this paper, the printing energy of BJ has been analysed while energy consumption of other processes of BJ such as curing and sintering are neglected. These energies also have contribution to the energy performance of BJ and should be considered to achieve a complete understanding of the total energy expense of BJ. In addition, for the sake of simplicity, the model divide the printing into three sub-processes while the machine clean operation is not considered as an individual sub-process and included in the printing process. For a more precise model, the clean operation has to be investigated separately. Finally, the algorithm developed in this paper did not take into account the material consumption and quality of part. Module for

material consumption and part quality controlling has to be developed. With these function, this model could be used to compare classic manufacturing process with BJ technology.

References

- [1] Petrovic, V., 2011, Additive layered manufacturing : sectors of industrial application shown through case studies.
- [2] Beaman, J. J., Marcus, H. L., Bourell, D. L., Barlow, J. W., Crawford, R. H., and McAlea, K. P., 1997, Solid Freeform Fabrication: A New Direction in Manufacturing, Kluwer Academic Publishers.
- [3] Morrow, W. R., Qi, H., Kim, I., Mazumder, J., and Skerlos, S. J., 2007, "Environmental aspects of laser-based and conventional tool and die manufacturing," *Journal of Cleaner Production*, 15(10), pp. 932-943.
- [4] Yanchun, L., Zhiming, J., Leu, M. C., and Caudill, R., "Environmental performance analysis of solid freedom fabrication processes," *Proc. Electronics and the Environment, 1999. ISEE -1999. Proceedings of the 1999 IEEE International Symposium on*, pp. 1-6.
- [5] BJORKE, O., and MYKLEBUST, O., 1992, " IMPPACT-Integrated Modelling of Products and Processes Using Advanced Computer Technologies."
- [6] Sachs, E., Cima, M., and Cornie, J., 1990, "Three-Dimensional Printing: Rapid Tooling and Prototypes Directly from a CAD Model," *CIRP Annals - Manufacturing Technology*, 39(1), pp. 201-204.
- [7] Kellens, K., Dewulf, W., Overcash, M., Hauschild, M., and Duflou, J., 2012, "Methodology for systematic analysis and improvement of manufacturing unit process life-cycle inventory (UPLCI)—CO2PE! initiative (cooperative effort on process emissions in manufacturing). Part 1: Methodology description," *Int. J. LCA*, 17(1), pp. 69-78.
- [8] Paul, R., and Anand, S., 2012, "Process energy analysis and optimization in selective laser sintering," *Journal of Manufacturing Systems*, 31(4), pp. 429-437.
- [9] Singhal, S. K., Jain, P. K., Pandey, P. M., and Nagpal, A. K., 2009, "Optimum part deposition orientation for multiple objectives in SL and SLS prototyping," *International Journal of Production Research*, 47(22), pp. 6375-6396.

- [10] Mognol, P., Lopicart, D., and Perry, N., 2006, "Rapid prototyping: energy and environment in the spotlight," *Rapid Prototyping J.*, 12(1), pp. 26-34.
- [11] Choi, S. H., and Chan, A. M. M., 2004, "A virtual prototyping system for rapid product development," *Computer-Aided Design*, 36(5), pp. 401-412.
- [12] Kulkarni, P., and Dutta, D., 1996, "An accurate slicing procedure for layered manufacturing," *Computer-Aided Design*, 28(9), pp. 683-697.
- [13] 1993, " FIPS Publication 183," Computer Systems Laboratory of the National Institute of Standards and Technology (NIST).

Tables

Table 1: Power of sub-processes

Sub-process	Power (W)
Spreading	163.26
Drying	159.61

Table 2: Spread speed and drying time

Layer	1-10	11-15	16-20	21-25	26-35	>35
Spread speed(mm/s)	1	3	5	10	15	20
Drying time (s)	50	40	40	30	30	30

Table 3: Printing time and energy

Printing Orientation	Simulated print time (s)	Real print time (s)	Accuracy (%)
0°	3076.00	3087.00	99.64%
90°	2408.00	2424.00	99.34%

Printing Orientation	Simulated printing Energy (kJ)	Real print Energy (kJ)	Accuracy (%)
0°	510.24	515.29	99.02%
90°	398.95	408.61	97.64%

Figure captions

Fig. 1: Printing system of BJ technology: (a) printing (b) drying and spreading

Fig. 2: Workflow of Energy simulation

Fig. 3: IDEF0 diagram of BJ process

Fig. 4: Structure of operation cell

Fig. 5: Calculation of operation list and sub-process

Fig. 6: Schematic of print layer

Fig. 7: Print Power Curve