



**HAL**  
open science

## PLM and early stages collaboration in interactive design, a case study in the glass industry

Frédéric Segonds, Guillaume Cohen, Philippe Veron, Josquin Peyceré

### ► To cite this version:

Frédéric Segonds, Guillaume Cohen, Philippe Veron, Josquin Peyceré. PLM and early stages collaboration in interactive design, a case study in the glass industry. *International Journal on Interactive Design and Manufacturing*, 2014, 10.1007/s12008-014-0217-4 . hal-01064132

**HAL Id: hal-01064132**

**<https://hal.science/hal-01064132>**

Submitted on 13 Nov 2017

**HAL** is a multi-disciplinary open access archive for the deposit and dissemination of scientific research documents, whether they are published or not. The documents may come from teaching and research institutions in France or abroad, or from public or private research centers.

L'archive ouverte pluridisciplinaire **HAL**, est destinée au dépôt et à la diffusion de documents scientifiques de niveau recherche, publiés ou non, émanant des établissements d'enseignement et de recherche français ou étrangers, des laboratoires publics ou privés.



## Science Arts & Métiers (SAM)

is an open access repository that collects the work of Arts et Métiers ParisTech researchers and makes it freely available over the web where possible.

This is an author-deposited version published in: <http://sam.ensam.eu>  
Handle ID: <http://hdl.handle.net/10985/8518>

### To cite this version :

Frédéric SEGONDS, Philippe VERON - PLM and early stages collaboration in interactive design, a case study in the glass industry - International Journal on Interactive Design and Manufacturing (IJIDeM) p.-- - 2014

Any correspondence concerning this service should be sent to the repository

Administrator : [archiveouverte@ensam.eu](mailto:archiveouverte@ensam.eu)

# PLM and early stages collaboration in interactive design, a case study in the glass industry

Frédéric Segonds · Guillaume Cohen · Philippe Véron · Josquin Peyceré

**Abstract** Product design activity is traditionally presented as a succession of four to six stages. In the early stages of design, during the search for concepts, multi-disciplinary teams are working together, sometimes on the fringe of the digital design chain. But it is during these stages, that most of the product development cost is committed. Therefore, collaboration should be emphasized, and PLM software should contribute to it strongly. This paper first defines the boundaries of the early stages of design. Then, we analyze designer collaboration in this stage and describe the knowledge necessary for efficient collaboration. Finally, we propose and test a concept for a tool to assist the early stages of design, to be integrated in a continuum with other existing digital design tools. A case study is presented in Verallia, specialized in the design and manufacturing of glassware.

**Keywords** Early interactive design · PLM · Collaborative work

F. Segonds (✉)  
Arts et Metiers ParisTech, LCPI, 151 bd de l'Hôpital,  
75013 Paris, France  
e-mail: frederic.segonds@ensam.eu

G. Cohen  
Université Paul Sabatier Toulouse 3, ICA, bat 3R1, 118 route de  
Narbonne, 31062 Toulouse, France  
e-mail: guillaume.cohen@univ-tlse3.fr

P. Véron  
Arts et Metiers ParisTech, LSIS, 2 cours des Arts et Métiers,  
13617 Aix-en-Provence, France  
e-mail: philippe.veron@ensam.eu

J. Peyceré  
Verallia, rue André Chénier, 71104 Chalons-sur-Saône, France  
e-mail: josquin.peycere@saint-gobain.com

## 1 Introduction

Collaborative design tools are currently the focus of much effort. Indeed, the globalization of design activities, particularly in product design, creates a need for distributed collaboration, both synchronous and asynchronous [12]. Many tools have been developed by large software companies (Dassault Systèmes, PTC, etc...). However, these do not suit designers' needs in the early stages of design, but rather in the detailed design stage. In this paper, we present a methodology aiming to improve collaboration in the early stages of design. We first make a literature review of main designs methods, in order to define the boundaries of what are commonly known as the "early stages" of design. We then propose our main contribution: a method implemented in a prototype of a tool to assist collaboration, and demonstrate its utility on an industrial case study for a product.

## 2 Product design and the early stages of design

### 2.1 The product design process evolutions

In this part, we propose a chronological literature review of the methods applied in the business world in order to improve their competitiveness. These methods, used in the industrial world, seem to be at the heart of the issue of reducing product development time, which many businesses in the industry currently face.

#### 2.1.1 Concurrent engineering

Towards the end of the 1980s and the beginning of the 1990s, two forms of design organization emerged as distinct alternatives: sequential design, which involves carrying out design

tasks one after the other, and concurrent engineering, or integrated design [21,25,30]. Two of the aspects of Concurrent Engineering (CE) that distinguish it from conventional approaches to product development are cross-functional integration and concurrency. In CE, one must define shared interfaces between the various tasks. Indeed, CE is an approach to product development, in which considerations about product lifecycle processes, from product planning, design, production to delivery, service, and even end-of-life, are all integrated. By carrying out all these tasks in a parallel fashion, it becomes possible to reduce the time and costs of design, but also to improve the quality of products. With the development of Information Technology (IT), CE methods have evolved gradually towards PLM.

### 2.1.2 PLM

In the early 2000s, Product Lifecycle Management (PLM) emerged as a solution to adapt engineering design to the demands of globalization. Indeed, as PLM addresses the entire lifecycle of the product, it has a cross-functional nature and deals closely with the way a company runs [5]. Collaborative design has been the subject of numerous studies [4,8,15,17]. With the development of Product Data Management (PDM), PLM and associated workflows, software firms have proposed solutions to the everyday problems of engineering design departments (versioning of documents, naming etc.). PLM aims to cover all the stages of product development, by integrating the processes and people taking part in the project [22]. This concept is generally used on industrial products. For Amann [2], over the past several years, PLM has emerged as a term to describe a business approach for the creation, management, and use of product-associated intellectual capital and information throughout the product lifecycle. Thus, PLM is an approach in which processes are just as important as data, or even more so. The PLM approach can be viewed as a trend toward a full integration of all software tools taking part in design and operational activities during a product's lifecycle [2,10]. Therefore, PLM software packages need PDM systems, as well as synchronous and asynchronous, local and remote collaboration tools and if necessary, a digital infrastructure allowing exchanges between software programs.

## 2.2 Design theories and methodologies

The design activity is generally presented as a succession of four to six stages. In the literature, there is no exact definition of the early stages of design's boundaries. As the separation between early and the later stages of design is the subject of various interpretations, it has to be defined before anything else.

Several authors have proposed models of the product design process.

An extensive comparative analysis of all existing models of the design process would be beyond the scope of this paper. Moreover, several authors have already attempted such classifications. Design Theory and Methodology (DTM) has already a rich collection of results that can be used in design cases as well as taught. Tomiyama et al. [27] describe and classify some of these. Furthermore, Howard et al. [11] propose a synthesis of design models proposed from 1967 to 2006. Twenty-two models are identified, and all are divided into six stages, either explicitly stated in the initial model or highlighted in Howard et al. [11] synthesis: needs analysis, task planification, conceptual design, definition of product architecture, detailed design and, finally, development and production stages.

To define the boundaries of the early stages, our choice is deliberately limited to two conventional methodologies which are intended to represent the main product design theories:

- Pahl et al. [20], a German methodology whose first version dates from 1977, is widely used in industry.
- Ullman and Jones [29], an American methodology mainly focused on mechanical products, which has a great level of detail and is widely used in industry and in education.

### 2.2.1 Pahl and Beitz

This design method places design as a central activity of the PLM. It may be the most known and used in literature and industries. For Pahl et al. [20], the product design method is divided into four stages (see Fig. 1). The "planning and clarifying" phase focuses on analyzing the market and developing a list of specifications that the product will address. The "conceptual design" stage, leads to a product concept, taking shape in the product architecture that is defined during the "embodiment design" stage. During the embodiment phase, designers must determine the overall layout design, the preliminary form designs, component shapes and materials, as well as define production processes. This phase is complex because many actions must be achieved simultaneously and some steps must be repeated, for example for the selection of the best preliminary overall layout. Finally, the "detail design" stage is used to generate the final documentation of the product, which will serve as a reference during manufacturing.

This design model has already been used several times as a reference to define the boundaries of early stages of design. Thus, Eder [9] limits the early stages of design to the two first stages of Pahl et al. [20], whereas, Birkhofer et al. [3] define the early stages of product development as "planning and clarifying", the "conceptual design" and the first steps

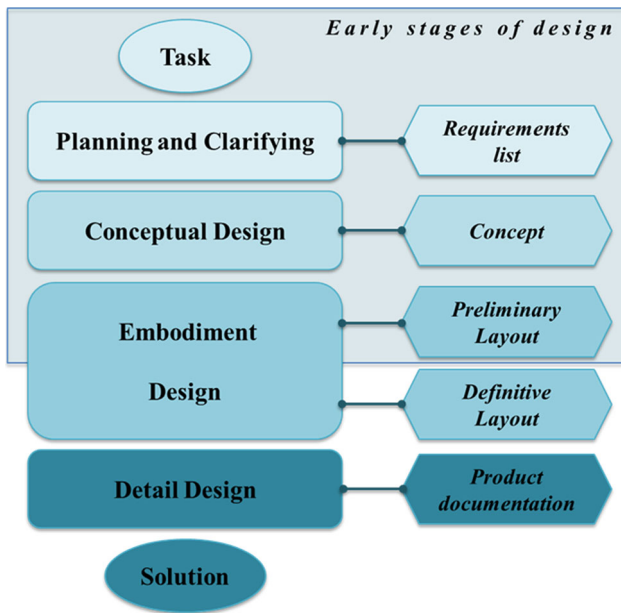
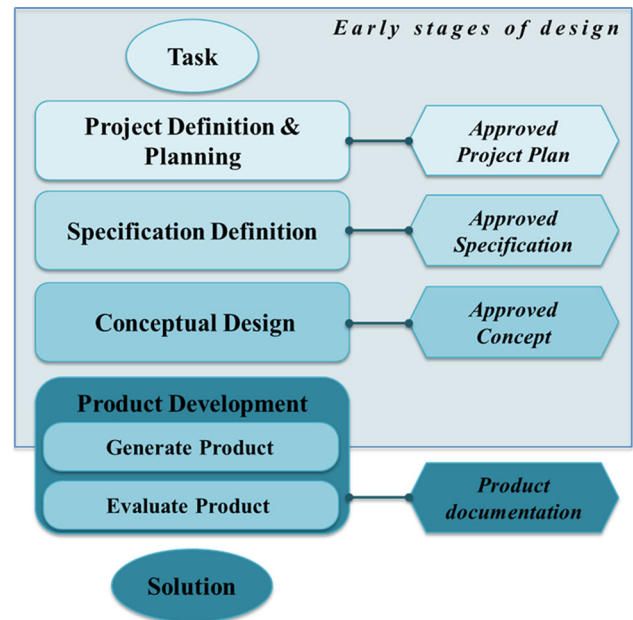

**Fig. 1** Product design process according to Pahl et al. [20], and location of the early stages of design

of “embodiment design” stages, right through to a roughly scaled product. Another interpretation define the early design phases, also called preliminary design, as starting from the research of feasible concepts to embodiment design [18]. The first overall preliminary layout describes the complete construction structure of the system or product being designed. For Pahl et al. [20], it is often necessary to produce several preliminary layouts to scale simultaneously or successively in order to obtain more information about the advantages and disadvantages of the different variants. According to this theory, we define the early stages of design as all the activities from the “task” to achieve to the first preliminary layout, if made successively, or from the “task” to achieve to the first series of preliminary layouts if generated simultaneously.

### 2.2.2 Ullman

In Ullman and Jones [29], product design is also defined in four stages (see Fig. 2). The “project definition and planning” phase is concerned with formation of the project team, validation of product appropriateness, and finally defining a provisional schedule and cost estimate. The “specification definition” stage allows consumer identification, collection of their needs, competition analysis, and translation of needs into technical specifications. The “conceptual design” stage focuses mostly on generating and evaluating solution concepts. Then a decision is made to develop a concept further. This stage ends with a final decision approving the concept during a design review. The phase of “product development” aims to generate and evaluate the product, creating all the



**Fig. 2** Design for Ullman and Jones [29], and position of the early stages of design

technical documentation before the production and support stages. The time spent in support is estimated at 20–30 % of total project time. We notice that no step is specified between concept approval and the product development stage. The definition of the early stages, from the project definition to the preliminary layout, is trickier here. Indeed, the “generate product” phase includes the development and the definition of the construction structure stages, in Pahl et al. [20]’s sense. Thus, as the preliminary design layout marks the end of the early stages of design, it is in Ullman and Jones [29] part of the “generate product” phase.

### 2.2.3 Synthesis

In summary, we notice similarities between these two approaches to product design. The needs definition stage is found consistently, as is the conceptual phase, followed by the detailed design and industrialization stages. Although several authors attempted to define the boundaries of the early stages of design (e.g. [3,9,18]), our own reference for these stages is described in previous Figs. 1 and 2. The early stages of design include the stages of “project definition and planning”, the research and validation of concept stage, and the early stages of the architectural design, up to the preliminary layout generation. These steps are, in Ullman and Jones [29] encapsulated in the “product development” step. This “boundary” may slightly vary depending on the type of design project concerned. For example, in an aeronautical design project, considering only the phases of “planning and clarifying” and “conceptual design” as early stages would

be simplistic. Indeed, the design costs are so large that the project never starts from scratch. The early stages will, in this case, be the phase of preliminary projects, whose role is to define a possible architecture for the aircraft. Thus, the type of project strongly affects the activities of the early phases of design.

### 2.3 Importance of the design project's type

Actions taken in the early stages of design depend on the type of project. According to Micaëlli and Forest [16], there are four types of design projects: inventive projects, innovative projects, construction projects and improvement projects. For each type of project, the “standard” design process must be adapted. The inventive project (or creative, anticipation-based project) aims to validate a new concept. The innovative project targets a new solution that changes the reference system in place. The construction project (or integration, routine design) aims to propose a variant of an existing product. Finally improvement projects involve changing an existing product to satisfy new requirements or improve performance.

The design project type is an important data for the early stages collaboration study. Indeed, the stakeholders and the starting point for the design are not the same. An innovative project develops, from the knowledge of known physico-chemical processes, yield design innovations in the product architecture, which is unknown in early design activity. These two types of projects carry out the whole Pahl et al. [20] design process, from the “task” to the “solution”. Within these four stages, the early stages of design are, as defined in previous section those ranging from the task to the preliminary layout.

For a routine design project, the product to be designed is an unknown configuration of well-known concept and architecture. It is only concerned, from the early stages point of view, with the conceptual design stage (i.e. the production of design sketches) and with the beginning of the embodiment design stage. Indeed, as Pahl et al. [20] point out, many products are not developed from scratch, but are developments or improvements of existing products that take into account new requirements, new knowledge and experiences.

The early stages are not involved in an improvement design project. Since the product architecture and configuration are known in advance, only some parameters of product to be designed are unknown when the project starts. That's why the only stage design work is concerned with is “detail design”.

In summary, Fig. 3 below shows, depending on the type of design project studied, the design stages which are completed, according to the Pahl et al. [20]'s terminology. We note that the intersection between the different project types and the early stages of design varies greatly depending on the type of project. Thus, the most relevant designs for the study

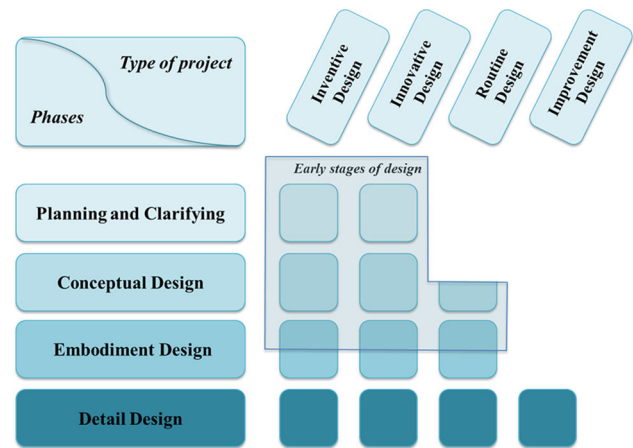

**Fig. 3** Location of the “early stages” of design, completed stages and unfinished stages according to the type of design project

of collaboration in the early stages of design are inventive projects (quite rare), innovative design and routine design projects. The industrial case study, studied in chapter 4, is an example of a routine project in the glass industry.

## 3 Design collaboration: methods, tools and importance of PLM

### 3.1 Early interactive design process

The classical approaches supporting design and manufacture phases have to mute [18]. In today's product design, there is a real need to communicate and collaborate on design concepts and to share data interactively in a real-time. However, a comprehensive system for developing new products that satisfies all the necessary requirements is still unavailable [13]. The early design phases correspond to a series of crucial steps for the product. It is well known that at this earlier stage, every decision on the product engages the majority of the future costs of design, production, assembly, maintenance, and disassembly [18]. The interactive product design is of major economic and strategic importance in the development of new and innovative industrial products and processes. Interactive design is especially developed to support the knowledge modelling in preliminary design. In interactive design, the creation of a product is considered to be constrained by three factors: the expert's knowledge, the end-user satisfaction and the realization of functions [18]. Moreover, the usability [19] of the user interface is a key aspect for the success of industrial products. This assumption has led to the introduction of numerous design methodologies addressed to evaluate the user-friendliness of industrial products [7].

In the early stages of design, various experts from different fields are working together in order to provide a solution. Hence, knowledge is divided between these experts and there

should be structures to share this knowledge. Such structures have been proposed [24,28]. However, just few research propose the prototyping of a collaborative distributed early stages of design environment, to deploy later a customized solution tailored to the needs of end users.

We propose in this paper a methodology and a tool prototype to foster the early interactive design process. The methodology is presented in chapter 4 and a case study with the Verallia company is detailed, up to prototyping and user testing of the solution.

### 3.2 Early collaboration and PLM

Collaborative design is subject to numerous studies. Usually, we note that the detailed design activities are better structured than the early stages. PLM solutions often lack of flexibility, and are not well suited to the early stages of design work. Thus, there exist only a few systems currently available for preliminary product design that provides the sharing of design data and interactive environments for undertaking the design process in distributed environments.

However, Sudarsan et al. [26] point out that “PLM concept holds the promise of seamlessly integrating and making available all the information produced throughout all phases of a product’s lifecycle to everyone in an organization, along with key suppliers and customers”. This ambitious goal, applied to the early stages of design, should provide wide-ranging assistance to the actors involved.

The study of collaboration in the early stages of design, also called “early design collaboration”, must be integrated in the PLM approach to design. Indeed, PLM solutions that are currently deployed do not take into account the whole of the early stages of design. However, these phases are of prime importance to product quality, but also to determine design costs. Indeed, Ullman and Jones [29] show that the incurred cost due to design decisions taken in the early stages represents about 80 % of future product costs, whereas about 10 % of project costs are engaged.

To address these needs, some tools are starting to be developed for graphic designers and, more generally, for the early stages of design teams. However, the difficulty in tool use is often a barrier to its adoption. There has been a particular trend in recent years to develop tools in this specific area, but this does not cover all designer needs. For example, 3DS [1] develops the “Design Studio” that takes into account the constraints of graphic designers to create a digital mock-up earlier in the design process. The goal of this tool is to move to the digital mock-up in three dimensions starting from a blank sheet of paper or 2D drawings. The aim is to facilitate internal and external communication about the project, and improve understanding of the design intent by all actors involved in the project. For 3DS [1], collaboration in early

stages of design should involve, above all, dissemination of the digital mock-up as soon as possible.

Research to cover the entire product life cycle has been proposed. For example, Tseng et al. [28] presents a design platform named “CoDevelop”, with a web interface for collaborative product development. Design is divided into four stages: administration, marketing, design and industrialization. This tool is based on five databases: human resources, marketing information, communication, design and supply chain. Then, a “design studio”, meaning product design engineer, different from the “Design Studio” developed by 3DS [1], is integrated to the digital chain. It allows changing the design from the early stages. A limitation of this study is that the digital model is introduced in the first stage in the design process. The aspects of conceptual research and style study are not mentioned. Thus, this platform is a very good basis to improve work in some design projects, but can show its limits other projects. Another element emphasized by the authors is the cultural and environmental context in which the tool is to be integrated. This is one of the key factors of success and raises a crucial issue when developing such a platform: how to provide a tool that will be adopted by most stakeholders in the early stages of design and that will not compel them in their work? Finally, Tseng et al. [28] point out that email is still the most widely used means for collaboration in design. This validates a great interest in global and early collaboration, from the industrial point of view.

## 4 A tool to assist the early stages of design: a case study

The early stages of design are characterized by a multitude of stakeholders from different backgrounds. We classically find engineers, ergonomists, designers, a marketing team etc. Each of these activities requires a representation of the product, adapted to his core competence field. Thus, the needs for representation of the product are numerous. Hence, a tool to assist the early design collaboration must take into account these constraints in order to propose a solution.

### 4.1 Proposed methodology

The idea of a single, imposed piece of software seems to be rejected, as it is too restrictive. It would be better to develop a tool allowing each person taking part in the project to come make a contribution from the early stages, to participate in the project and enhance its knowledge base. The development of this solution will require an in-depth needs analysis, for different types of products.

Our methodology, shown in Fig. 4, is composed of four phases. Its objective is to enable interactive design of an early stages distributed collaborative tool in accordance with the needs of end users. The first phase “Scope Definition” defines

the scope of action of the tool. For this it is necessary to identify which actors design in the early stages and the collaboration they have. The second phase “Collaborative Process Identification” is intended to provide a mapping of Intermediate Representations (IR) generated during the product design [6]. These IR can be used to support collaboration by integrating them into the tool. A formalism to identify IR is defined by Segonds [23] and shown in Fig. 7.

The third and fourth steps are to develop an early stages of design collaborative environment prototype, and then do a series of user tests with a panel of experts and novices.

Finally, a collaborative tool must allow access to the types of knowledge defined by Yesilbas and Lombard [31]. According to these authors, during design, three types of collaboration are needed:

- “pre-collaborative knowledge” is the pre-requisite information, necessary to enter in the project.
- “in-collaboration knowledge” concerns the knowledge that must be shared and exchanged to achieve the action.
- “post-collaboration knowledge” that is knowledge produced after the collaborative action.

The pre-collaborative knowledge will be available to anybody via a database. The data exchanged during and after the project will be stored and accessible via the tool.

#### 4.2 Methodology’s application: a case study at Verallia

In this case study, we apply our methodology to develop an early collaborative and interactive tool, to the design activity of Verallia in the Chalon-sur-Saône site in France. This plant produces about 3.5 billion bottles a year, for a daily production of about 200,000 to 300,000 bottles. The product studied is a glass bottle that will be used for a new wine brand.

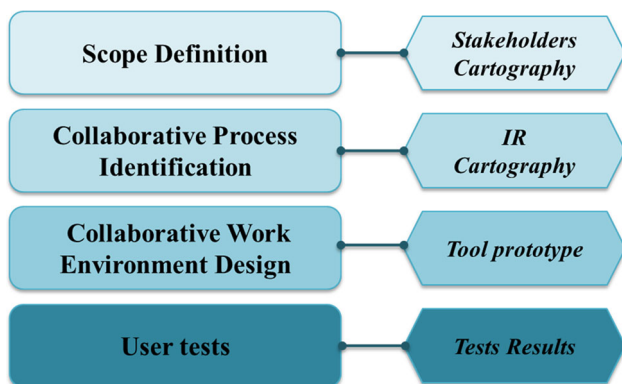

**Fig. 4** Methodology to develop an early collaborative and interactive tool

##### 4.2.1 Step 1: scope definition

To analyze collaboration in the early stages of design, we have to describe the design activity. One needs, at first, to identify the actors in the early design phases and their modes of collaboration. Figure 5 below shows the stakeholders in the development of a new glass bottle, and the main tools of collaboration they use. Our analysis is based on many meetings with the New Product Design (NPD) Engineering Department and with one of their graphic design agencies.

For the development of a new bottle, the customer calls up a graphic design agency and provides a “design brief”. In this brief, he expresses his needs (e.g. “a bottle that will give an overall impression of freshness”). The design team suggests four to six bottle concepts to the customer. In the design a glass bottle, many constraints should be kept in mind for the graphic designer, starting in the early stages. This key-factor is actually a crucial point to reduce time losses of during a project. After several trips between the graphic design agency and the customer, a bottle concept is proposed, through the sales department, to the NPD Engineering Department. To evaluate the cost of the future product, the members of the sales department can access an online database in which they are able to show similar bottles and make a preliminary estimate. The engineering design of the product is then divided in three steps: product definition (about 1 week), glass testing (7–8 weeks) and manufacturing preparation (about 1 week). During these stages, the NPD Engineering Department often calls on mold specialists, who have the manufacturing knowledge in mind.

The aim of the engineering design department is to convert the aesthetic idea of the graphic designer to an achievable under acceptable conditions product (see Fig. 6). The specificity in the design is that the team works on about thirty projects at the same time. That’s why, in the detailed design stage, a tool has been developed by Verallia so as to manage the workflow. This tool is called “New Product Development”. The set of stakeholders involved is drawn on Fig. 5, in dotted line as the NPD area. This tool is efficient and provides the good information at the right time for the design team. Its functionalities correspond to classic PDM tool capabilities, highly customized to Verallia activities.

However, we can notice that some of the main actors of the early stages of design, i.e. the customer and the graphic designers, are not involved in the overall product development. Stakeholders from the early stages of design are represented on Fig. 5, surrounded with a continuous line in the “early stages of design” area. This situation can lead to communication problems, especially in understanding the design intent, and to reduce the loss of time during product design.

We have developed a tool model that can improve collaboration in the early stages of design, based on the methodology presented in previous section. The method, presented both in



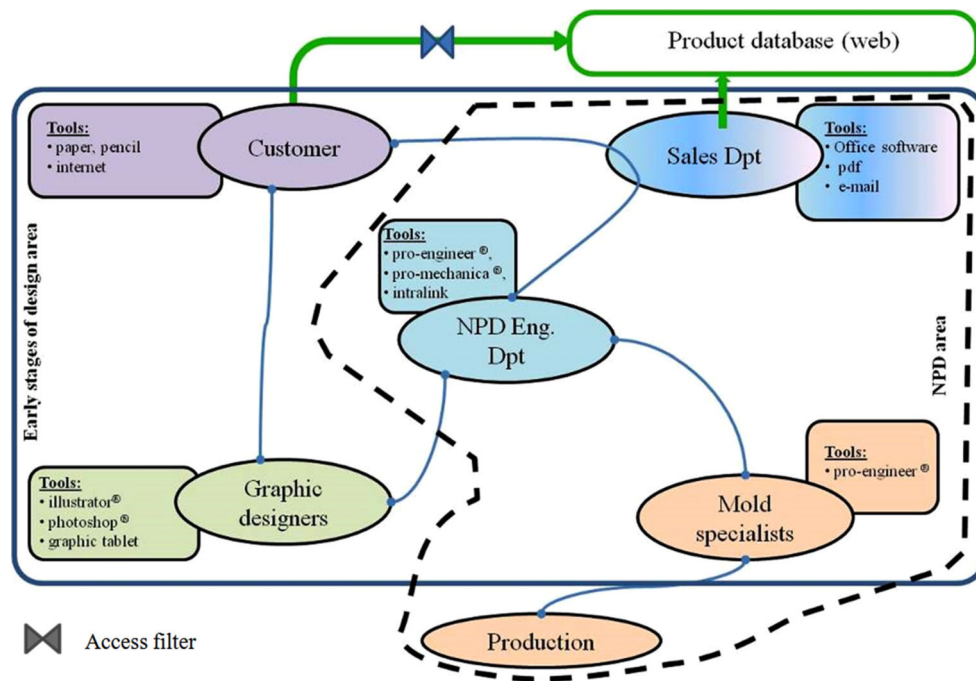
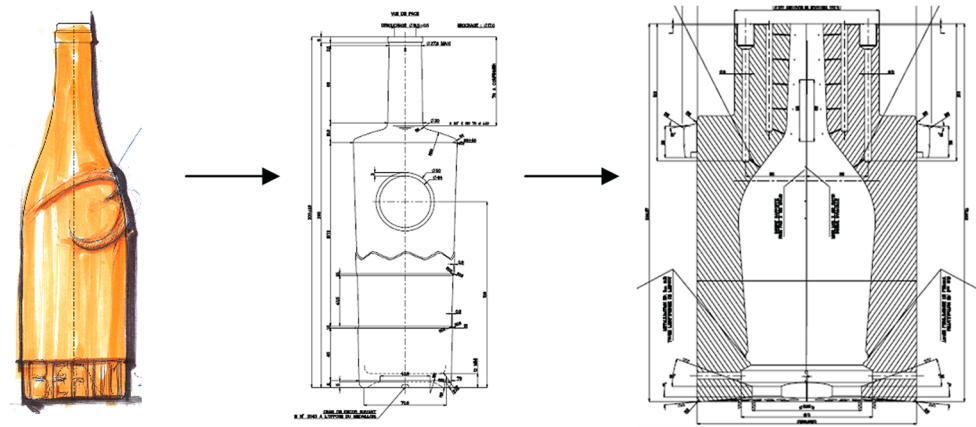

Fig. 5 Stakeholder's cartography for collaborative design of a new bottle in Verallia

Fig. 6 Important IR in the development of a new glass bottle (courtesy of Terre-Neuve and Verallia)



the NPD Engineering Department and in the design agency, will be tested by end-users.

#### 4.2.2 Step 2: collaborative process identification

Considering the complexity of the collaborative processes involved in the development of a glass product, as well as the sheer number of actors involved, characterizing the exchanges between these people is a crucial starting point in order to understand the collaborative activities which take place within the company. In order to provide the best possible specifications for a collaborative work environment, the first stage of our work aims to identify the main modes of communication used in the company. In order to do this, we carried out a series of eight interviews with a panel composed

of professionals in NPD in Verallia and in their graphic design agency.

The user interview is a method used to collect oral data from individuals or groups in order to derive information from specific facts or representations. The relevance, validity, and reliability of this information are assessed based on the goals of this data collection. Therefore, each interview takes place within a specific context. Interviews must be prepared beforehand, by planning which central topics should be addressed and in what order. This allows the interviewer to gradually steer the interviewee's feedback towards specific topics of interest, and to ensure that series of interviews with different people retain a specific internal coherence. The main types of interviews include the directed interview, the semi-directed interview, and the free (open) interview [5].

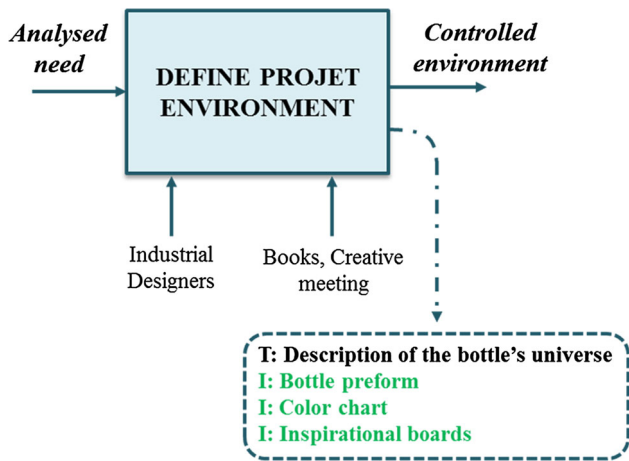

**Fig. 7** “IR oriented IDEF0” diagram for the “Define Project Environment” phase in Verallia

Considering our goals, the type of interview that seemed to suit our needs best is the semi-directed interview. In our questionnaire, we used open questions to gather information about the respondents (e.g. profession, place of residence, etc.) in order to categorize them and ensure they were indeed part of our target user group. We also used closed questions with Likert-type scales [14] to simplify data collection and analysis. This allowed us to collect precise data in a reasonable length of time (each interview lasted about 30 min) and fostered a genuine dialogue between the interviewer and interviewee, while preserving a framework that is tailored to the goals of the project. In our case, the questions focused on the types of communication tools used by the interviewees. Questions were grouped into four main topics: means of communication used, department involved in the communication, duration of use of the communication tool, and type of information transmitted.

The main result of these interviews consists in a cartography of the main Intermediate Representations (IR) of the product. To better identify IR exchanged throughout the design process, we adapt the way of representing IDEF0 diagrams into an “IR oriented IDEF0”. An example of “IR oriented IDEF0” for the “define project environment” phase is presented on the Fig. 7 below. Thus, we define the terms of inbound and outbound work, with a central action. Then, we position in the lower part of diagram, stakeholders and tools used to carry out the action. Finally, we consign the lower part of the global IDEF0 diagram IR generated during the phase, ranking into three categories, with a color code to quickly identify it: T: IR generated as text (black colour); I: IR generated as image (green) and P: IR generated as physical object (blue).

The whole cartography is presented in Segonds [23] and allows to define the main IR that are used to support the collaboration during the design of the work environment.

#### 4.2.3 Step 3: collaborative work environment design

The purpose of this section is to detail the solution proposed above, which will be tested to meet the needs of stakeholders in the early stages of design. Finally we propose a scenario to validate and test this solution with end-users.

The development scenario of a glass bottle, detailed in Sect. 4.2.1 has been used as vital lead. This tool, available online, allows the exchange of information via the web. Part of the model is shown in Fig. 8 below. The final deployed solution will, of course, be secured with a username and personal password, but the purpose of this prototype is to test the adaptation to the needs of the end-users.

The main functionalities of the tool prototype are:

- Possibility for all design stakeholders to connect and interact, from the early stages of design, on a particular project (Fig. 8 takes the example of a project to design a new bottle for a *rosé* wine).
- Sharing data relative to the selected project.
- Customized modules of “Needs”, “Concepts”, “Design” and “Validation” modules depending on the type of project.
- Visualization and collaboration thanks to IR of the product, displayed for different design skills (graphic designer, engineering department, production etc...).

All these functionalities have been implemented in a Publisher<sup>©</sup> prototype and the next section presents return on experience on the prototype thanks to user tests.

#### 4.2.4 Step 4: user tests

A tool’s prototype has been presented to users and has been tested in the field. The scenario of use involves simulating a design project for a glass bottle, involving all stakeholders of design, to ascertain that the tool meets their needs. Stakeholders, who are experts in their field, can quickly identify improvements to bring the prototype. A questionnaire has been developed to collect their feelings in relation to the existing tool. The tool prototype, which serves to support a collaborative environment in the early stages of design in the Verallia industry, was subjected to tests involving eight persons: four experts in the company and four novices. Following these tests, the reactions of the users were collected using a two-page questionnaire. This questionnaire is structured according to five key topics related to the functionalities that are expected from this tool:

- The startup screen: are the icons clear? Does the tool make the users want to use it? Etc.
- The design of the Human–Computer Interface (HCI): is the environment clearly presented? Is it consistent with

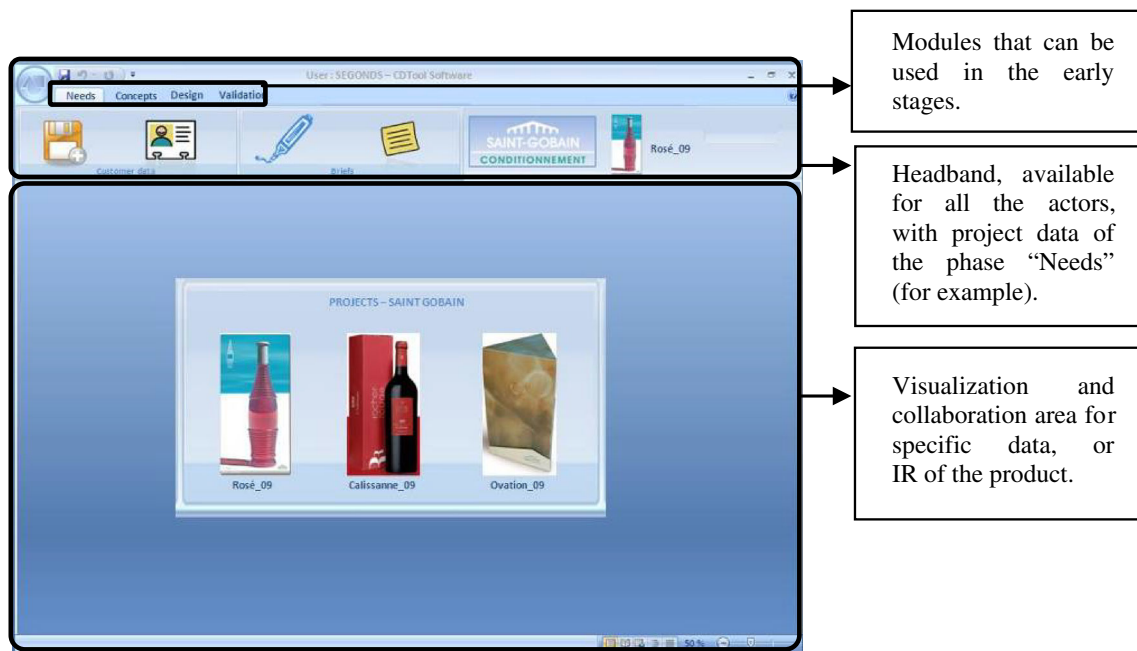

**Fig. 8** Early collaborative design tool prototype

the company identity? Are the contents well-articulated with one another? Is the navigation intuitive? etc.

- Contents: does the tool offer new, interesting functionalities? Are there any functions lacking? Are the available options representatives of my everyday work? Can the contents be understood without any additional explanation? Are the contents logically related? Etc.
- Communication: Do the pages encourage you to interact with them?
- Overall: Do you believe that this kind of collaborative environment for the early stages of design is realistic?

Users were requested to respond using a five-point Likert scale, ranging from “not at all” or “totally ill-suited” to “absolutely” or “excellent”. A semantic analysis scale is in the form of a list of adjectives, or items that are grouped in pairs and lined up, or separated by an odd number of boxes (usually 5 or 7), allowing participants to position their judgment on each line as a point located between these two extremities. The central point corresponds to a neutral judgment. Although the meaning of the adjective is more precise in a semantic differential scale, the participant may feel uneasy during the evaluation. The reason why the adjectives are more precise is the presence of an antonym, which allows disambiguating the meaning of the adjective used. For this reason, we have chosen to use Likert-scale type ratings. When choosing the items, the respondents to the questionnaire must be clearly identified. This makes it possible to adjust the tone and formulation of the questions and to use an appropriate vocabulary—one should not use technical terms when addressing newcomers.

Results on contents and communication are illustrated in Fig. 9. They show that the users subscribe to our proposal. The questions posed in this section of the questionnaire were: The prototype offers interesting new options that concern my work; There are options and functions missing; The options offered by the work environment are represented in my real work; Contents are understandable without any further explanations; The contents are logically linked; Contents motivated me to act.

The most important criterion to us is obviously the contents proposed for the platform. These require, in order to be relevant, from designers to apprehend the complete design process. It emerges that the participants we have involved in the process appreciate this solution proposal, suggesting that the prototype of our collaborative environment does indeed respond to the needs of users at Verallia. Indeed, we note that the collaborative tool prototype collects 71 % of “good” or “excellent” reviews. This validates our proposed methodology to develop an early collaborative and interactive tool.

We will now propose a conclusion regarding the generalizability of the methodology used in this case study.

## 5 Conclusion and future work

In this paper we have analyzed and defined the early stages of design based on a survey of some of the traditional theories of design. Then we showed that these stages, which are crucial in the development of a product, only have a marginal role in PLM tools, whether in industry or in academia. We emphasized that these tools could indeed be viewed as

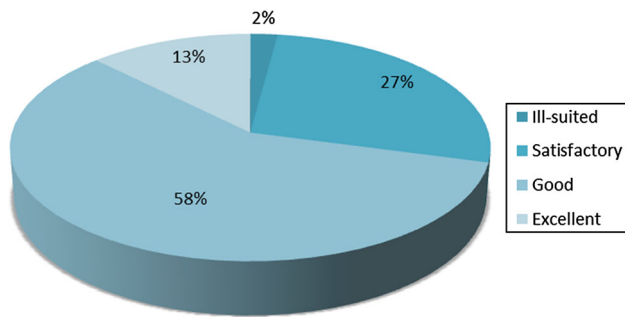

**Fig. 9** Results of user tests related to the contents of the prototype

a constraint for some actors. Finally, we have proposed and tested a method and a tool prototype to define a collaboration tool for these stages, based on research enriched with an industrial case study. Research perspectives are to validate the tool by in field implementation to develop further on its specifications and to create a fully interactive tool for the early stages of design. From the methodology point of view, future work will be made to test it on other types of products. Indeed, in order to conclude on the generalizability of the results, we have to broaden the scope of products to inventive, innovative, but also more complex products.

## References

- 3DS: Inspired people boosting innovation for design excellence [Online]. Available: <http://www.3ds.com/design-studio> (2010)
- Amann, K.: Product Lifecycle Management : Empowering the Future of Business. CimData, Ann Arbor (2002)
- Birkhofer, H., Jänsch, J., Kloberdanz, H.: An extensive and detailed view of the application of design methods and methodology in industry. In: International Conference on Engineering Design, 15–18 August 2005 2005 Melbourne, Australia
- Blanco, E., Boujut, J.F., Degrave, A., Charpentier, P., Ris, G., Benis, F., Martin, F.O., Petiot, J.F., Deniaud, S., Garro, O., Micaëlli, J.P.: A distant collaborative design experiment. *Mecanique et Industries* **3**, 153 (2002)
- Blomberg, J., Giacomi, J., Mosher, A., Swenton-WALL, P.: Ethnographic field methods and their relation to design. In: Schuler, D., Namioka, A. (eds.) *Participatory design: Principles and practices*. Lawrence Erlbaum Associates, New Jersey (1993)
- Bouchard, C., Camous, R., Aoussat, A.: Nature and role of intermediate representations (IR) in the design process: case studies in car design. *Int. J. Veh. Des.* **38**, 1–25 (2005)
- Bruno, F., Muzzupappa, M.: Product interface design: a participatory approach based on virtual reality. *Int. J. Hum. Comput. Stud.* **68**, 254–269 (2010)
- Chen, X.L., Fuh, J.Y.H., Wong, Y.S., Lu, Y.Q., Li, W.D., Qiu, Z.M.: An adaptable model for distributed collaborative design. *Comput. Aided Des. Appl.* **2**, 47–55 (2005)
- Eder, W.E.: Design modeling—a design science approach (and why does industry not use it?). *J. Eng. Des.* **9**, 355–371 (1998)
- Garetti, M., Terzi, S., Bertacci, N., Brianza, M.: Organisational change and knowledge management in PLM implementation. *Int. J. Product Lifecycle Manage.* **1**, 43–51 (2005)
- Howard, T.J., Culley, S.J., Dekoninck, E.: Describing the creative design process by the integration of engineering design and cognitive psychology literature. *Des. Stud.* **29**, 160–180 (2008)
- Johansen, R.: *Groupware: Computer Support for Business Teams*. The Free Press, New York (1988)
- Lau, H.Y.K., Mak, K.L., Lu, M.T.H.: A virtual design platform for interactive product design and visualization. *J. Mater. Process. Technol.* **139**, 402–407 (2003)
- Likert, R.: A technique for the measurement of attitudes. *Arch. Psychol.* **140**, 1–55 (1932)
- Maranzana, N., Segonds, F., Lesage, F., Nelson, J.: Collaborative design tools: a comparison between free software and PLM solutions in engineering education. In: 9th International Conference on Product Lifecycle Management - PLM'12. Montréal (2012)
- Micaëlli, J.P., Forest, J.: *Artificialisme, introduction à une théorie de la conception*, Presses polytechniques et universitaires romandes (2003)
- Merlo, C., Couture, N.: A user-centered approach for a tabletop-based collaborative design environment. *Strojnicki Vestnik/Journal of Mechanical Engineering*, **56**, 754–764 (2010)
- Nadeau, J.-P., Fischer, X.: Research in Interactive Design. In: *Virtual, Interactive and Integrated Product Design and Manufacturing for Industrial Innovation*, vol. 3. Springer, Berlin (2011)
- Nielsen, J.: *Usability Engineering*. Harcourt Science and Technology Company, San Diego (1993)
- Pahl, G., Beitz, W., Feldhusen, J., Grote, K.H.: *Engineering Design—A systematic approach*. Springer, Londres (2007)
- Prasad, B.: *Concurrent engineering fundamentals—integrated product and process organization*. Prentice Hall, London (1996)
- Schuh, G., Rozenfeld, H., Assmus, D., Zancul, E.: Process oriented framework to support PLM implementation. *Comput. Ind.* **59**, 210–218 (2008)
- Segonds, F.: Contribution to the integration of a collaborative design environment in the early stages of design. PhD , Arts et Metiers ParisTech (2011)
- Segonds, F., Mantelet, F., Maranzana, N., Gaillard, S.: Early stages of apparel design: how to define collaborative needs for PLM and fashion? *Int. J. Fash. Des. Technol. Educ.* pp. 1–10 (2014)
- Sohlenius, G.: Concurrent engineering. *CIRP Ann. Manuf. Technol.* **41**, 645–655 (1992)
- Sudarsan, R., Fenves, S.J., Sriram, R.D., Wang, F.: A product information modeling framework for product lifecycle management. *CAD Comput. Aided Des.* **37**, 1399 (2005)
- Tomiyama, T., Gu, P., Jin, Y., Lutters, D., Kind, C., Kimura, F.: Design methodologies: industrial and educational applications. *CIRP Ann. Manuf. Technol.* **2009**(09), 003 (2009)
- Tseng, K., Abdalla, H., Shehab, E.: A Web-based integrated design system: its applications on conceptual design stage. *Int. J. Adv. Manuf. Technol.* **35**, 1028 (2008)
- Ullman, D.G., Jones, E.A.: *The Mechanical Design Process*. McGraw-Hill Higher Education, New York (2003)
- Winner, R. I., Pennell, J. P., Bertrand, H. E., Slusarczyk, M.M.: The Role of Concurrent Engineering in Weapons System Acquisition. In: I. R. (ed) *Institute for Defense Analyses*, p. 338. Alexandria Va (1988)
- Yesilbas, L.G., Lombard, M.: Towards a knowledge repository for collaborative design process: focus on conflict management. *Comput. Ind.* **55**, 335 (2004)