



HAL
open science

Adaptive versus Algorithms and Higher Order Cumulants for Identification and Equalization of MC-CDMA System

Mohammed Zidane, Saïd Safi, Mohamed Sabri, Ahmed Boumezzough, Miloud
Frikel

► **To cite this version:**

Mohammed Zidane, Saïd Safi, Mohamed Sabri, Ahmed Boumezzough, Miloud Frikel. Adaptive versus Algorithms and Higher Order Cumulants for Identification and Equalization of MC-CDMA System. Journal of Telecommunications and Information Technology, 2014, pp.41-48. hal-01063136

HAL Id: hal-01063136

<https://hal.science/hal-01063136v1>

Submitted on 11 Sep 2014

HAL is a multi-disciplinary open access archive for the deposit and dissemination of scientific research documents, whether they are published or not. The documents may come from teaching and research institutions in France or abroad, or from public or private research centers.

L'archive ouverte pluridisciplinaire **HAL**, est destinée au dépôt et à la diffusion de documents scientifiques de niveau recherche, publiés ou non, émanant des établissements d'enseignement et de recherche français ou étrangers, des laboratoires publics ou privés.

Adaptive Algorithms Versus Higher Order Cumulants for Identification and Equalization of MC-CDMA

Mohammed Zidane¹, Said Safi², Mohamed Sabri¹, Ahmed Boumezzough³, and Miloud Frikel⁴

¹ *Department of Physics, Faculty of Sciences and Technology, Sultan Moulay Slimane University, Morocco*

² *Department of Mathematics and Informatics, Polydisciplinary Faculty, Sultan Moulay Slimane University, Morocco*

³ *Department of Physics, Polydisciplinary Faculty, Sultan Moulay Slimane University, Morocco*

⁴ *GREYC laboratory, ENSICAEN School, Caen University, France*

Abstract—In this paper, a comparative study between a blind algorithm, based on higher order cumulants, and adaptive algorithms, i.e. Recursive Least Squares (RLS) and Least Mean Squares (LMS) for MultiCarrier Code Division Multiple Access (MC-CDMA) systems equalization is presented. Two practical frequency-selective fading channels, called Broadband Radio Access Network (BRAN A, BRAN B) normalized for MC-CDMA systems are considered. In the part of MC-CDMA equalization, the Zero Forcing (ZF) and the Minimum Mean Square Error (MMSE) equalizer techniques were used. The simulation results in noisy environment and for different signal to noise ratio (SNR) demonstrate that the blind algorithm gives approximately the same results obtained by adaptive algorithms. However, the proposed algorithm presents the advantage to estimate the impulse response of these channels blindly except that the input excitation is non-Gaussian, with the low calculation cost, compared with the adaptive algorithms exploiting the information of input and output for the impulse response channel estimation.

Keywords—*blind identification and equalization, higher order cumulants, RLS, LMS, MC-CDMA systems.*

1. Introduction

Many algorithms have been proposed in the literature for the identification of Finite Impulse Response (FIR) system using cumulants, established that blind identification of FIR Single-Input Single-Output (SISO) communication channels is possible only from the output second order statistics of the observed sequences (Auto Correlation Function and power spectrum) [1]. Moreover, the system to be identified has no minimum phase and is contaminated by a Gaussian noise, where the Auto Correlation Function (ACF) does not allow identifying the system correctly because the cumulants vanishes on order greater than 2 [2]–[4]. To overcome these problems, other approaches was proposed by several authors in [5]–[14]. This paper is focused on channels impulse response estima-

tion with non-minimum phase and selective frequency such as: BRAN A and BRAN B normalized for MC-CDMA systems. In MC-CDMA a single data symbol is transmitted at multiple narrow band subcarriers [15], [16]. Indeed, in MC-CDMA systems, spreading codes are applied in the frequency domain and transmitted over independent subcarriers. In most wireless environments, there are many obstacles in the communication, such as buildings, mountains, and walls between the transmitter and the receiver antennas. The reflections from these obstacles cause many propagation paths. The problem met in communication is the synchronization between the transmitter and the receiver, due to the echoes and reflection between the transmitter and the receiver antennas. Synchronization errors cause loss of orthogonality among sub-carriers and considerably degrade the performance especially when large number of subcarriers is present [17].

This paper describes a blind algorithm which is based only on third order cumulants. In order to test its efficiency, it was compared with the adaptive algorithms such as Recursive Least Square (RLS) and Least Mean Square (LMS) [18], [19]. Two practical frequency-selective fading channels called Broadband Radio Access Network (BRAN A, BRAN B), normalized by the European Telecommunications Standards Institute (ETSI) were considered [20], [21]. In this paper, a novel concept of blind equalization is developed and investigated for downlink MC-CDMA systems. Moreover, the developed method is compared with the adaptive equalization obtained using RLS and LMS algorithms. The bit error rate (BER) performance of the downlink MC-CDMA systems, using blind BRAN A and BRAN B estimation, are shown and compared with the results obtained with the adaptive methods.

2. Problem Statement

The output of a FIR system that is excited by an unobservable input and is corrupted on output by an additive

white Gaussian noise (Fig. 1) is described by the following formula

$$y(k) = \sum_{i=0}^q x(i)h(k-i). \quad (1)$$

The observed measurable output $r(k)$ is given by

$$r(k) = y(k) + n(k), \quad (2)$$

where $n(k)$ is the noise sequence.

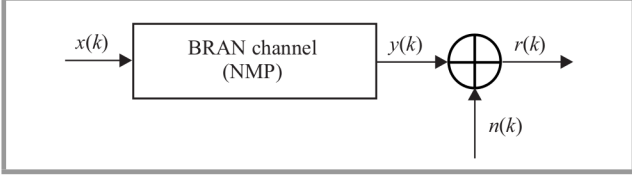

Fig. 1. Channel model.

In order to simplify the algorithm construction, it was assumed that the input sequence $x(k)$ is independent and identically distributed (i.i.d.) zero mean and non-Gaussian. The system is causal and truncated, i.e. $h(k) = 0$ for $k < 0$ and $k > q$, where $h(0) = 1$. The system order q is known. The noise sequence $n(k)$ is i.i.d., Gaussian, independent of $x(k)$ and with unknown variance.

3. Blind Algorithm (Algo-CUM)

The m^{th} order cumulants of $y(k)$ can be expressed as follows [6], [18], [19]:

$$C_{my}(t_1, t_2, \dots, t_{m-1}) = \xi_{mx} \sum_{i=0}^q h(i)h(i+t_1) \dots h(i+t_{m-1}), \quad (3)$$

where ξ_{mx} is the m^{th} order cumulants of the excitation signal $x(i)$ at origin.

For $m = 2$ in Eq. (3), the second order cumulants is obtained as follows:

$$C_{2y}(t) = \xi_{2x} \sum_{i=0}^q h(i)h(i+t). \quad (4)$$

Analogically, if $m = 3$, Eq. (3) yields to

$$C_{3y}(t_1, t_2) = \xi_{3x} \sum_{i=0}^q h(i)h(i+t_1)h(i+t_2). \quad (5)$$

The second-order cumulants Z-transform is straightforward and gives Eq. (6)

$$S_{2y}(z) = \xi_{2x} H(z)H(z^{-1}). \quad (6)$$

The Z-transform of Eq. (5) is Eq. (7)

$$S_{3y}(z_1, z_2) = \xi_{3x} H(z_1)H(z_2)H(z_1^{-1})H(z_2^{-1}). \quad (7)$$

If $z = z_1 z_2$, Eq. (6) becomes

$$S_{2y}(z_1 z_2) = \xi_{2x} H(z_1 z_2)H(z_1^{-1} z_2^{-1}). \quad (8)$$

Then, from Eqs. (7) and (8), the following formula is obtained:

$$S_{3y}(z_1, z_2)H(z_1 z_2) = \mu H(z_1)H(z_2)S_{2y}(z_1 z_2), \quad (9)$$

where $\mu = \frac{\xi_{3x}}{\xi_{2x}^2}$.

The inverse Z-transform of Eq. (9) demonstrates that the 3rd order cumulants, the ACF and the impulse response channel parameters are combined by:

$$\sum_{i=0}^q C_{3y}(t_1 - i, t_2 - i)h(i) = \mu \sum_{i=0}^q h(i)h(t_2 - t_1 + i)C_{2y}(t_1 - i). \quad (10)$$

Using the ACF property of the stationary process such as $C_{2y}(t) \neq 0$ only for $-q \leq t \leq q$ and vanishes elsewhere if $t_1 = -q$, the Eq. (10) becomes:

$$\sum_{i=0}^q C_{3y}(-q - i, t_2 - i)h(i) = \mu h(0)h(t_2 + q)C_{2y}(-q). \quad (11)$$

Using the property of the cumulants, $C_{3y}(t_1, t_2) = C_{3y}(-t_1, t_2 - t_1)$, Eq. (11) is:

$$\sum_{i=0}^q C_{3y}(q + i, t_2 + q)h(i) = \mu h(0)h(t_2 + q)C_{2y}(q). \quad (12)$$

The considered system is causal. Therefore, the interval of the t_2 is $t_2 = -q, \dots, 0$. Otherwise, if $t_2 = -q$, Eq. (12) will takes the following form:

$$C_{3y}(q, 0)h(q) = \mu h(0)C_{2y}(q). \quad (13)$$

Thus, based on Eq. (13) and eliminating $C_{2y}(q)$ from Eq. (12), the equation constituted of only the third order cumulants is obtained:

$$\sum_{i=0}^q C_{3y}(q + i, t_2 + q)h(i) = C_{3y}(q, 0)h(t_2 + q). \quad (14)$$

The system of Eq. (14) in matrix form is as follows

$$\begin{pmatrix} C_{3y}(q+1, 0) & \dots & C_{3y}(2q, 0) \\ C_{3y}(q+1, 1) - \alpha & \dots & C_{3y}(2q, 1) \\ \vdots & \vdots & \vdots \\ C_{3y}(q+1, q) & \dots & C_{3y}(2q, q) - \alpha \end{pmatrix} \times \begin{pmatrix} h(1) \\ \vdots \\ h(i) \\ \vdots \\ h(q) \end{pmatrix} = \begin{pmatrix} 0 \\ -C_{3y}(q, 1) \\ \vdots \\ -C_{3y}(q, q) \end{pmatrix}, \quad (15)$$

where $\alpha = C_{3y}(q, 0)$.

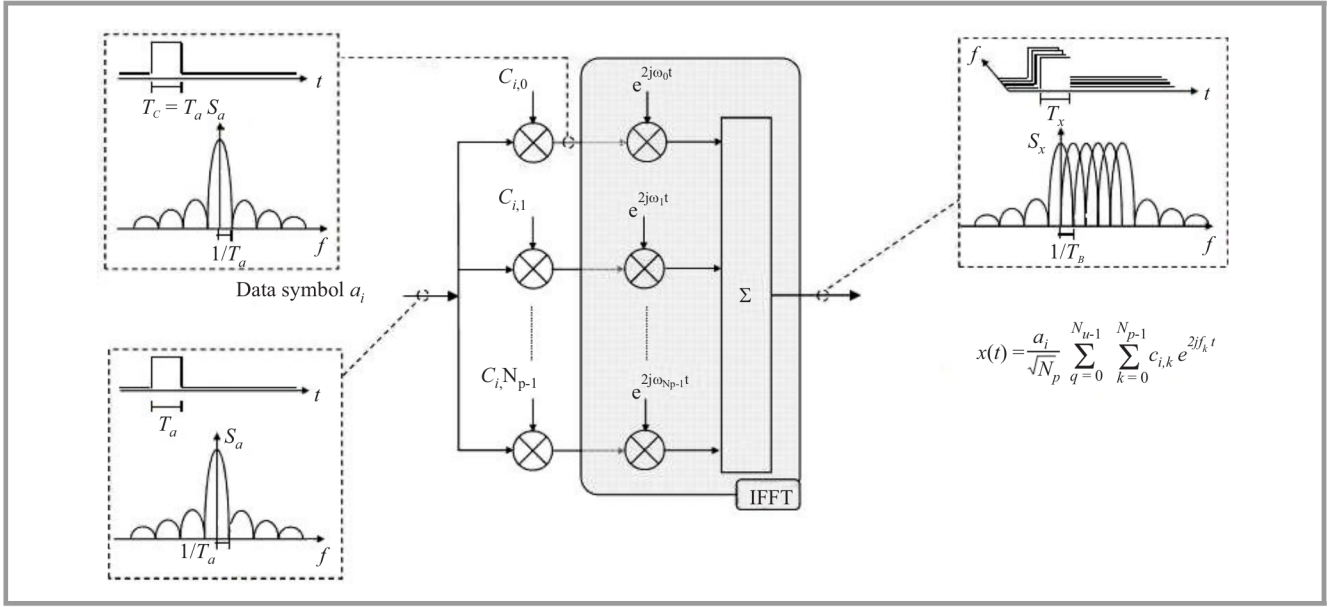

Fig. 2. MC-CDMA modulator principle.

In more compact form, the Eq. (15) is:

$$Mh_e = d, \quad (16)$$

where M is the matrix of size $(q+1) \times (q)$ elements, h_e is a column vector constituted by the unknown impulse response parameters $h(k)$: $k = 1, \dots, q$ and d is a column vector of size $(q+1)$, as indicated in the Eq. (15).

The least squares solution of the Eq. (16) permits a blindly identification of the parameters $h(k)$. Therefore, the solution can be written as:

$$\hat{h}_e = (M^T M)^{-1} M^T d. \quad (17)$$

4. RLS Algorithm

The RLS algorithm [19] is described by the following equations (with initialization $h(0) = 0$).

$Q^{-1}(0) = \delta^{-1}I$, δ is a small positive constant value.

$$k(n) = \frac{\lambda^{-1} Q^{-1}(n-1) X(n)}{1 + \lambda^{-1} Q^{-1}(n-1) X(n)}, \quad (18)$$

$$e(n) = r(n) - X^T h(n-1), \quad (19)$$

$$h(n) = h(n-1) - k(n)e(n), \quad (20)$$

$$Q^{-1}(n) = \lambda^{-1} Q^{-1}(n-1) - \lambda^{-1} k(n) X^T(n) Q^{-1}(n-1). \quad (21)$$

5. LMS Algorithm

The LMS algorithm [18] is described by the following equations with the initialization $h(0) = 0$, and computed for $n = 0, 1, 2, \dots$

$$e(n) = r(n) - X^T h(n-1), \quad (22)$$

$$h(n) = h(n-1) + \mu e(n) X(n). \quad (23)$$

where μ is the convergence factor.

6. Equalization of MC-CDMA System

The operation principle of MC-CDMA system is described by a symbol a_i of each user i transmitted at multiple narrow band subcarriers [22], [23] (Fig. 2). Indeed, in MC-CDMA systems, spreading codes are applied in the frequency domain and transmitted over independent subcarriers.

6.1. MC-CDMA Transmitter

The symbol a_i of user i is multiplied by each chip $c_{i,k}$ of spreading code and then applied to the modulator. Each subcarrier transmits an information element multiplied by a code chip of that subcarrier. For example, the case, where the length L_c of spreading code is equal to the number N_p of subcarriers is considered. The optimum space between two adjacent subcarriers is equal to inverse of duration T_c of spreading code in order to guarantee the orthogonality between subcarriers. Thus, the MC-CDMA emitted signal is given by [6]:

$$x(t) = \frac{a_i}{\sqrt{N_p}} \sum_{q=0}^{N_u-1} \sum_{k=0}^{N_p-1} c_{i,k} e^{2jf_k t}, \quad (24)$$

where $f_k = f_0 + \frac{k}{T_c}$, N_u is the user number and N_p is the number of subcarriers. Figure 3 explains the trans-

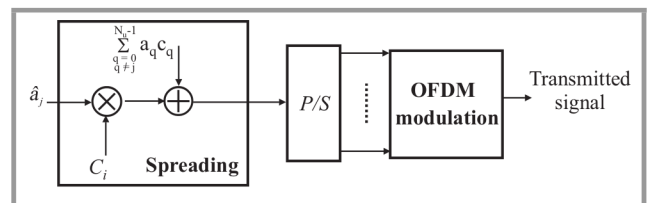

Fig. 3. MC-CDMA transmitter.

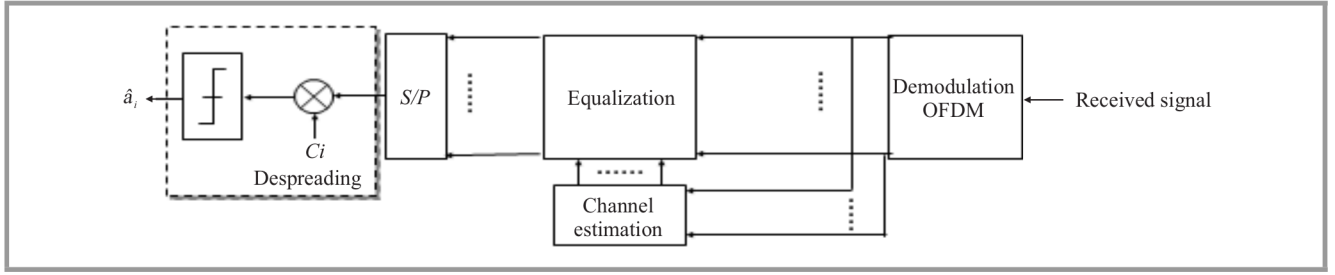

Fig. 4. MC-CDMA receiver block diagram.

mitter operation principle of the for downlink MC-CDMA systems.

Assuming that the channel is time invariant and it is impulse response is characterized by P path of magnitudes β_p and phases θ_p , the impulse response is given by:

$$h(\tau) = \sum_{p=0}^{P-1} \beta_p e^{j\theta_p} \delta(\tau - \tau_p), \quad (25)$$

$$\begin{aligned} r(t) &= \int_{-\infty}^{+\infty} \sum_{p=0}^{P-1} \beta_p e^{j\theta_p} \delta(\tau - \tau_p) x(t - \tau) d\tau + n(t) \\ &= \sum_{p=0}^{P-1} \beta_p e^{j\theta_p} x(t - \tau_p) + n(t), \end{aligned} \quad (26)$$

where $n(t)$ is an additive white Gaussian noise.

6.2. MC-CDMA Receiver

The received signal is given by the following equation [6], [23]:

$$\begin{aligned} r(t) &= \frac{1}{\sqrt{N_p}} \sum_{p=0}^{P-1} \sum_{k=0}^{N_p-1} \sum_{i=0}^{N_u-1} \times \\ &\times \Re\{\beta_p e^{j\theta} a_i c_{i,k} e^{2j\pi(f_0+k/T_c)(t-\tau_p)}\} + n(t). \end{aligned} \quad (27)$$

The main goal, is to obtain a good estimation of the symbol \hat{a}_i . The first operation is the received signal demodulation, according to N_p subcarriers. The second step is the received sequence multiplication by the users code.

The receiver structure for downlink MC-CDMA systems is shown in Fig. 4. The emitted user symbol \hat{a}_i estimation is given by:

$$\begin{aligned} \hat{a}_i &= \sum_{q=0}^{N_u-1} \sum_{k=0}^{N_p-1} c_{i,k} (g_k h_k c_{q,k} a_q + g_k n_k) \\ &= \underbrace{\sum_{k=0}^{N_p-1} c_{i,k}^2 g_k h_k a_i}_{I \ (i=q)} + \underbrace{\sum_{q=0}^{N_u-1} \sum_{k=0}^{N_p-1} c_{i,k} c_{q,k} g_k h_k a_q}_{II \ (i \neq q)} \\ &+ \underbrace{\sum_{k=0}^{N_p-1} c_{i,k} g_k n_k}_{III} \end{aligned} \quad (28)$$

where the part I, II and III of the formula present respectively: the desired signal (i.e. considered user signal), a multiple access interferences (i.e. others users signals) and the noise, i.e. pondered by the equalization coefficient and by chip spreading code.

6.3. Equalization for MC-CDMA

6.3.1. Zero Forcing

The zero forcing (ZF) technique operation principle is to cancel the distortions brought by the channel. The gain factor of the ZF equalizer principle is

$$g_k = \frac{1}{|h_k|}. \quad (29)$$

Therefore, the estimated received symbol \hat{a}_i of the user i is given by:

$$\hat{a}_i = \underbrace{\sum_{k=0}^{N_p-1} c_{i,k}^2 a_i}_{I \ (i=q)} + \underbrace{\sum_{q=0}^{N_u-1} \sum_{k=0}^{N_p-1} c_{i,k} c_{q,k} a_q}_{II \ (i \neq q)} + \underbrace{\sum_{k=0}^{N_p-1} c_{i,k} \frac{1}{h_k} n_k}_{III} \quad (30)$$

Using the orthogonality condition, i.e.

$$\sum_{k=0}^{N_p-1} c_{i,k} c_{q,k} = 0 \quad \forall i \neq q, \quad (31)$$

Eq. (30) becomes:

$$\hat{a}_i = \sum_{k=0}^{N_p-1} c_{i,k}^2 a_i + \sum_{k=0}^{N_p-1} c_{i,k} \frac{1}{h_k} n_k. \quad (32)$$

6.3.2. Minimum Mean Square Error

The Minimum Mean Square Error (MMSE) technique combine the multiple access interference minimalization and the signal to noise ratio maximization. The MMSE minimize the mean square error for each subcarrier k between the transmitted signal x_k and the output detection $g_k r_k$ [6]

$$E[|\varepsilon|^2] = E[|x_k - g_k r_k|^2]. \quad (33)$$

The $E[|\varepsilon|^2]$ function minimalization gives the optimal equalizer coefficient, under the minimalization of the mean square error criterion for each subcarrier as:

$$g_k = \frac{h_k^*}{|h_k|^2 + \frac{1}{\zeta_k}}, \quad (34)$$

where $\zeta_k = \frac{E[|r_k h_k|^2]}{E[|n_k|^2]}$.

The estimated received symbol \hat{a}_i of symbol a_i of the user i is described by:

$$\begin{aligned} \hat{a}_i = & \underbrace{\sum_{k=0}^{N_p-1} c_{i,k}^2 \frac{|h_k|^2}{|h_k|^2 + \frac{1}{\zeta_k}} a_i}_{I \quad (i=q)} + \underbrace{\sum_{q=0}^{N_u-1} \sum_{k=0}^{N_p-1} c_{i,k} c_{q,k} \frac{|h_k|^2}{|h_k|^2 + \frac{1}{\zeta_k}} a_q}_{II \quad (i \neq q)} \\ & + \underbrace{\sum_{k=0}^{N_p-1} c_{i,k} \frac{h_k^*}{|h_k|^2 + \frac{1}{\zeta_k}} n_k}_{III} \end{aligned} \quad (35)$$

Assuming that the spreading codes are orthogonal, the Eq. (35) becomes:

$$\hat{a}_i = \sum_{k=0}^{N_p-1} c_{i,k}^2 \frac{|h_k|^2}{|h_k|^2 + \frac{1}{\zeta_k}} a_i + \sum_{k=0}^{N_p-1} c_{i,k} \frac{h_k^*}{|h_k|^2 + \frac{1}{\zeta_k}} n_k. \quad (36)$$

7. Simulation Results

To evaluate the proposed algorithm performance, the BRAN A and BRAN B models representing the fading radio channels are considered. Their corresponding data are measured for multicarrier code division multiple access (MC-CDMA) systems. The Eq. (37) describes the impulse response $h(k)$ of BRAN radio channel:

$$h(k) = \sum_{i=0}^{N_T} A_i \delta(k - \tau_i), \quad (37)$$

where $\delta(n)$ is Dirac delta, A_i stands for the magnitude of the targets i , $N_T = 18$ is the number of target and τ_i is the time delay (from the origin) of target i .

Although, the BRAN channels are constituted by $N_T = 18$ parameters and seeing that their value are very low, for that the following procedure is taken:

- The BRAN A channel impulse response is decomposed into four sub-channel as:

$$h(k) = \sum_{j=1}^4 h_j(k). \quad (38)$$

- The parameters of each sub-channel are independently estimated, using the proposed algorithm.
- All sub channel parameters are added, to construct the full BRAN channels impulse response.

Table 1

Delay and magnitudes of 18 targets of BRAN A channel

Delay τ_i [ns]	Mag. A_i [dB]	Delay τ_i [ns]	Mag. A_i [dB]
0	0	90	-7.8
10	-0.9	110	-4.7
20	-1.7	140	-7.3
30	-2.6	170	-9.9
40	-3.5	200	-12.5
50	-4.3	240	-13.7
60	-5.2	290	-18
70	-6.1	340	-22.4
80	-6.9	390	-26.7

7.1. BRAN A Radio Channel

In Table 1, the values corresponding the BRAN A radio channel impulse response are shown [6], [24].

In Fig. 5 the estimation of the impulse response of BRAN A channel is presented using the blind and adaptive algorithms in the case of $SNR = 24$ dB and data length $N = 4096$.

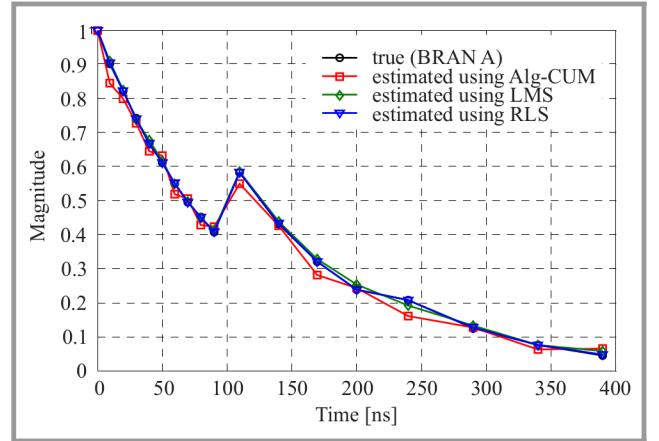

Fig. 5. Estimated of BRAN A channel impulse response, for an $SNR = 24$ dB and a data length $N = 4096$.

The estimated BRAN A channel impulse response using the adaptive algorithms (RLS and LMS) and the Algo-CUM algorithm are much closed to the true type, for data length $N = 4096$ and $SNR = 24$ dB. The robustness of the Algo-CUM proposed algorithm comparatively to the adaptive algorithms allows to act: without information about the input signal, and gives good estimation of the BRAN A channel. It is in opposite to the RLS and LMS versions in which the authors exploit the information of input and output for the estimation of the impulse response channel.

In Fig. 6 the estimated magnitude and phase of the impulse response BRAN A is presented, for $N = 4096$ and $SNR = 24$ dB using the all algorithms.

From the Fig. 6 the authors conclude that the magnitude and phase estimations using blind and adaptive algorithms

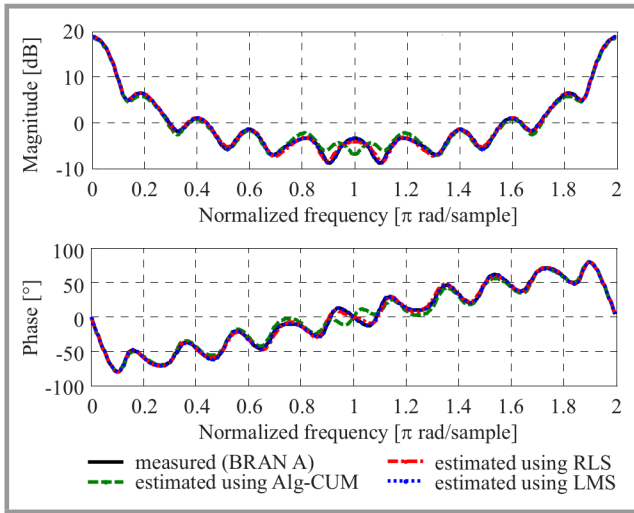

Fig. 6. Estimated magnitude and phase of BRAN A channel impulse response using all target, for $SNR = 24$ dB and $N = 4096$.

have the same allure comparatively to the true ones. However, the algorithm has the advantage of blind estimation of the channel parameters, i.e., without any information about the input.

7.2. Bran B Radio Channel

In Table 2, the values corresponding to the BRAN B radio channel impulse response are presented [24].

Table 2

Delay and magnitudes of 18 targets of BRAN B channel

Delay τ_i [ns]	Mag. A_i [dB]	Delay τ_i [ns]	Mag. A_i [dB]
0	-2.6	230	-5.6
10	-3.0	280	-7.7
20	-3.5	330	-9.9
30	-3.9	380	-12.1
50	0.0	430	-14.3
80	-1.3	490	-15.4
110	-2.6	560	-18.4
140	-3.9	640	-20.7
180	-3.4	730	-24.6

In Fig. 7, the estimation of the impulse response of BRAN B channel is shown using the blind and adaptive algorithms in the case of $SNR = 24$ dB and data length $N = 4096$.

Figure 7 shows that the estimated BRAN B channel impulse response, using the blind and adaptive algorithms, is closed to the true type, for data length $N = 4096$ and $SNR = 24$ dB, but the blind algorithm have the advantage of estimate the impulse response of BRAN B channel blindly with the faible calculate cost, comparing to RLS and LMS implementations.

In Fig. 8, the estimated magnitude and phase of the impulse response BRAN B are presented using all target, for an data length $N = 4096$ and $SNR = 24$ dB, obtained using blind algorithm, compared with the adaptive algorithms (RLS, LMS).

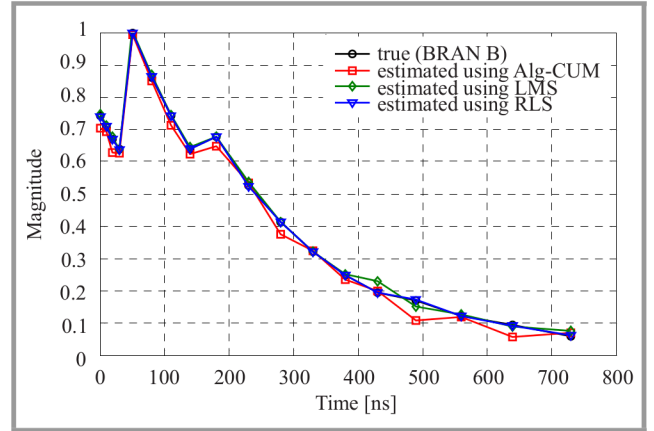

Fig. 7. Estimated of BRAN B channel impulse response, for an $SNR = 24$ dB and a data length $N = 4096$.

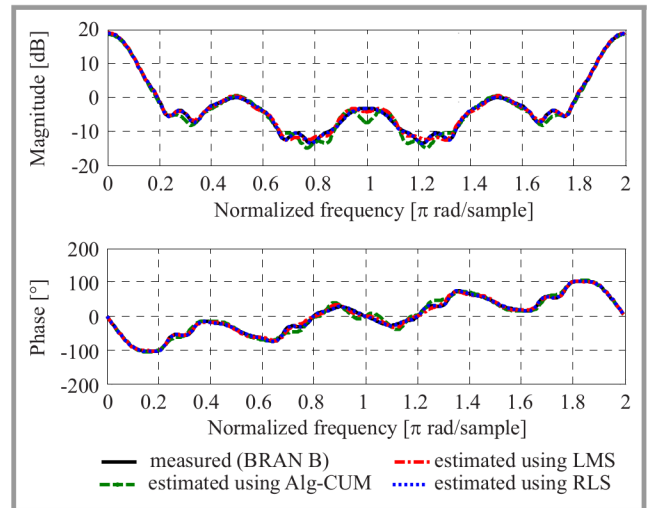

Fig. 8. Estimated magnitude and phase of BRAN B channel impulse response using all target, for an $SNR = 24$ dB and a data length $N = 4096$.

Figure 8 shows, that the estimated magnitude and phase, using blind and adaptive algorithms, have the same form showing no difference between the estimated and the true type version.

8. MC-CDMA System Application

To evaluate the performance of MC-CDMA systems using the blind and adaptive algorithms, the Bit Error Rate, based on two equalizers (ZF and MMSE) and measured and estimated BRAN A and BRAN B channels impulse response are computed. The results are evaluated for different values of SNR .

8.1. ZF and MMSE Equalizers – Case of BRAN A Channel

In Fig. 9, the BER estimation simulation results for the blind and adaptive algorithms using BRAN A channel estimation are shown. The equalization is performed using ZF equalizer.

Figure 10 depicts the BER for different SNR using the blind and adaptive algorithms for BRAN A channel. The equalization is performed using the MMSE equalizer.

The BER results for different SNR values demonstrates that the results obtained by the blind algorithm are similar to those obtained using the adaptive algorithms (RLS and LMS).

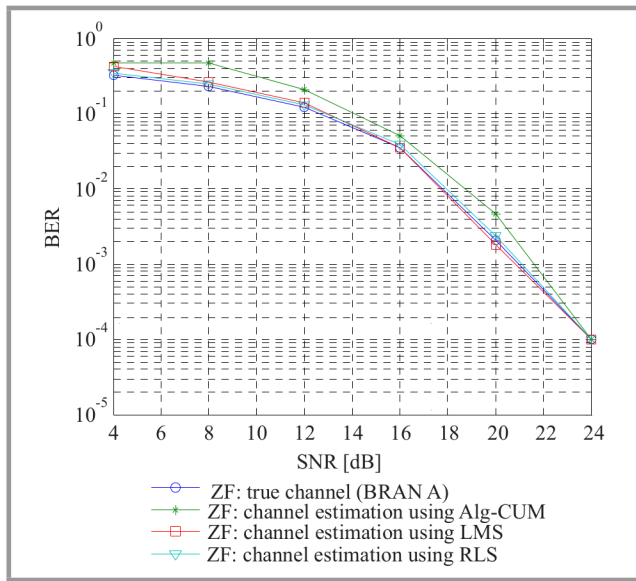

Fig. 9. BER parameter for estimated and measured BRAN A channel using the ZF equalizer.

With $SNR = 24$ dB, for all algorithms $BER = 10^{-4}$ can be achieved only using ZF equalizer, and using MMSE it lowers near to 10^{-5} . The proposed algorithm is very interesting because it is able to estimate the impulse response of these channels blindly.

8.2. ZF and MMSE Equalizers – Case of BRAN B Channel

Figure 11 shows the BER for different SNR values using the blind and adaptive algorithms for BRAN B channel. The equalization is performed using the ZF equalizer.

It demonstrates clearly that the BER parameter obtained using all algorithms gives good results comparable to

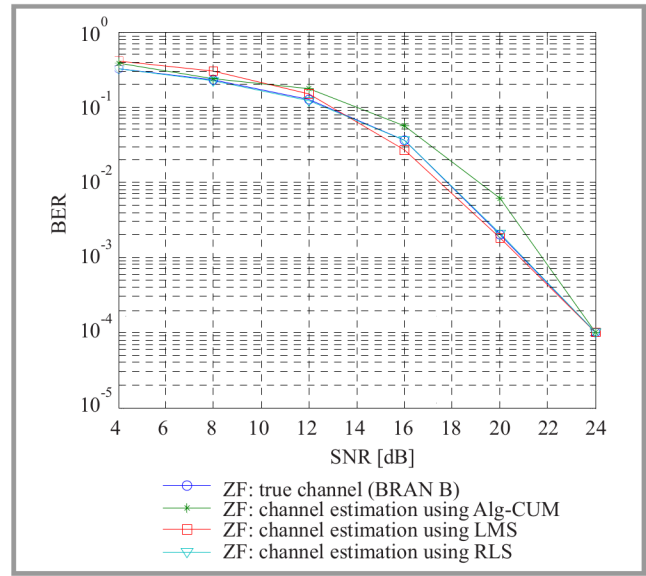

Fig. 11. BER of the estimated and measured BRAN B channel using the ZF equalizer.

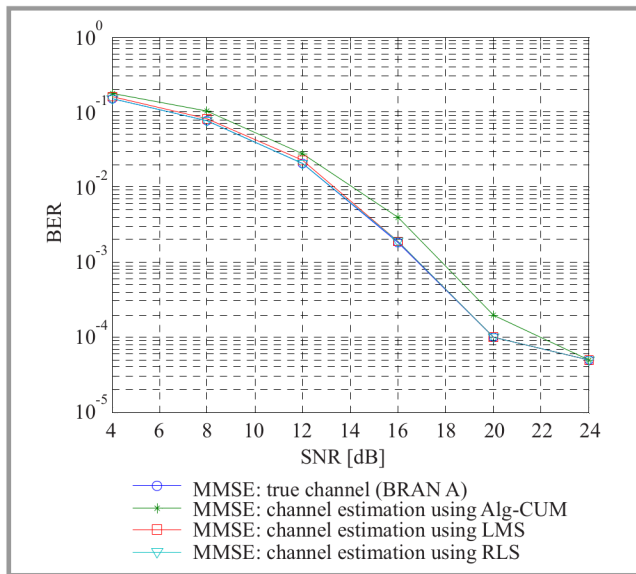

Fig. 10. BER coefficient for an estimated and measured BRAN A channel using the MMSE equalizer.

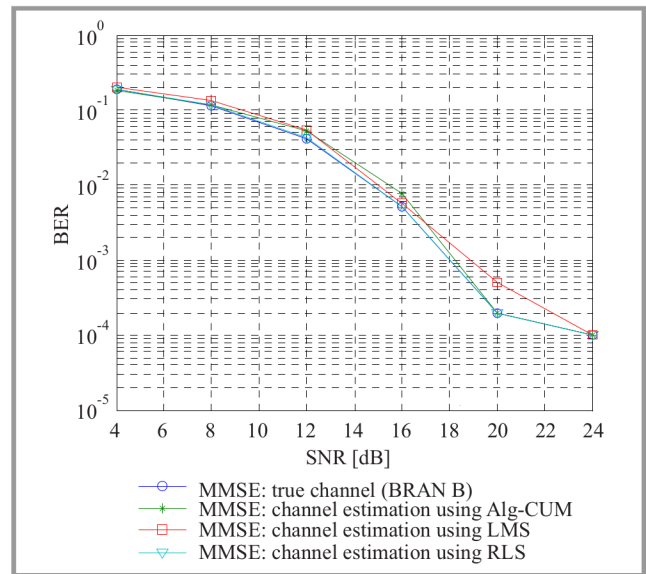

Fig. 12. BER of the estimated and measured BRAN B channel using the MMSE equalizer.

these obtained using measured values for ZF equalization. Therefore, if the $SNR = 24$ dB, for all algorithms BER stays at 10^{-4} level.

Figure 12 illustrates the BER for different SNR values, using the blind and adaptive algorithms for BRAN B channel. The equalization is performed using the MMSE equalizer.

It can be observed that the MMSE equalization, for all algorithms gives the same results as obtained using the measured BRAN B values. Then if the SNR values are superior to 20 dB, BER is 10^{-4} bit. However, if the SNR is superior to 24 dB, there is a BER lower than 10^{-4} .

9. Conclusion

In this paper, a comparative study between the adaptive algorithms (RLS and LMS) and blind algorithm based on third order cumulants was presented. These algorithms are performed in the channel parameters identification, such as the experimental channels, BRAN A and BRAN B. The simulation results show that they are efficient, but the blind algorithm presents the advantage to estimate the impulse response of frequency selective channel blindly with low calculation power required, comparing to RLS and LMS. The magnitude and phase of the impulse response are estimated with a good precision in noisy environment principally for high data record length. In the MC-CDMA equalization part, a good results using the proposed algorithm have been obtained comparatively to LMS and RLS algorithms.

References

- [1] G. B. Giannakis and A. Delopoulos, "Cumulant based autocorrelation estimates of non-gaussian linear processes", *Sig. Proces.*, vol. 47, pp. 1–17, 1995.
- [2] C. L. Nikias and A. P. Petropulu, *Higher order Spectra Analysis*. Englewood Cliffs: PTR Prentice Hall, 1993.
- [3] J. M. Mendel, "Tutorial on higher order statistics in signal processing and system theory: theoretical results and some applications", *Proc. IEEE*, vol. 79 pp. 278–305, 1999.
- [4] S. Safi and A. Zeroual, "Blind parametric identification of non-gaussian FIR systems using higher order cumulants", *Int. J. Syst. Sci.*, vol. 35 pp. 855–867, 2004.
- [5] J. Antari, R. Iqdour, and A. Zeroual, "Forecasting the wind speed process using higher order statistics and fuzzy systems", *Revue des Energies Renouvelables*, vol. 9, pp. 237–251, 2006.
- [6] S. Safi, M. Frikel, A. Zeroual, and M. M'Saad, "Higher order cumulants for identification and equalization of multicarrier spreading spectrum systems", *J. Telecommun. Inform. Technol.*, no. 2, pp. 74–84, 2011.
- [7] S. Safi, M. Frikel, M. M'Saad, and A. Zeroual, "Blind impulse response identification of frequency radio channels: application to BRAN A channel", *Int. J. Sig. Proces.*, vol. 4, pp. 201–206, 2007.
- [8] S. Safi, M. Frikel, M. M'Saad, and A. Zeroual, "Blind identification and equalisation of downlink TCM coded MC-CDMA systems using cumulants", in *Proc. 16th Eur. Sig. Proces. Conf. EUSIPCO 2008*, Lausanne, Switzerland, 2008.
- [9] M. Bakrim and D. Aboutajdine, "Cumulant-based identification of non gaussian moving average signals", *Traitement du Signal*, vol. 16, pp. 175–186, 1999.
- [10] K. Abderrahim, R. B. Abdennour, G. Favier, M. Ksouri, and F. Msahli, "New results on FIR system identification using cumulants", *APII-JESA*, vol. 35, pp. 601–622, 2001.
- [11] S. Safi and A. Zeroual, "Blind identification in noisy environment of non-minimum phase finite impulse response (FIR) system using higher order statistics", *J. Syst. Analysis Model. Simul.*, vol. 43, pp. 671–681, 2003.
- [12] J. Antari, A. Zeroual, and S. Safi, "Stochastic analysis and parametric identification of moving average (MA) non Gaussian signal using cumulants", *Int. J. Phys. Chem. News*, vol. 34, pp. 27–32, 2007.
- [13] M. Zidane, S. Safi, M. Sabri, and A. Boumezzough "Blind identification of minimum phase channels based on higher order cumulants", in *Proc. Int. Conf. Intell. Inform. Netw. Technol. IC2INT'13*, Settat, Morocco, 2013.
- [14] M. Zidane, S. Safi, M. Sabri, and A. Boumezzough "Impulse response identification of minimum and non minimum phase channels", in *Proc. 4th Worksh. Codes, Cryptogr. Commun. Syst. WCCCS'13*, Meknes, Morocco, 2013.
- [15] N. Yee, J.-P. M. G. Linnartz, and G. Fettweis, "Multi-Carrier-CDMA in indoor wireless networks", in *Proc. 4th In. Symp. Pers. Indoor and Mob. Radio Commun. PIMRC'93*, Yokohama, Japan, 1993, pp. 109–113.
- [16] M. Frikel, S. Safi, B. Targui, and M. M'Saad, "Channel identification using chaos for an uplink/downlink multicarrier code division multiple access system", *J. Telecommun. Inform. Technol.*, no. 1, pp. 48–54, 2010.
- [17] M. Frikel, B. Targui, M. M'Saad, and F. Hamon, "Bit error rate analysis of the controlled equalization for MC-CDMA", in *Proc. IEEE Int. Conf. Sig. Proces. Commun. ICSPC 2007*, Dubai, United Arab Emirates, 2007.
- [18] J. Antari, "Analyse et identification aveugle des Systèmes non linéaire en utilisant les statistiques d'ordre, supérieur: application à la modélisation du trafic dans les réseaux internet", Ph.D. thesis, Cadi Ayyad University, Marrakesh, Morocco, 2008 (in French).
- [19] S. Safi, "Identification aveugle des canaux à phase non minimale en utilisant les statistiques d'ordre supérieur: application aux réseaux mobiles", Postdoctoral thesis, Cadi Ayyad University, Marrakesh, Morocco, 2008 (in French).
- [20] A. Y. Kibangou, "Modèles de volterra à complexité reduite: estimation parametrique et application à l'égalisation des canaux de communication", Ph.D. thesis, Université de Nice-Sophia Antipolis, France, 2005 (in French).
- [21] ETSI, "Broadband Radio Access Networks (BRAN); HIPERLAN Type 2; Physical Layer", Dec. 2001.
- [22] ETSI, "Broadband Radio Access Networks (BRAN); High Performance Radio Logical Area Network (HIPERLAN) Type 2; Requirements and architectures for wireless broadband access", Dec. 1999.
- [23] P. Guguen, "Techniques multi-antennes émission-réception Applications aux réseaux domestiques sans fil", Ph.D. thesis, Institut National des Sciences Appliquées, Rennes, France, 2003 (in French).
- [24] J.-M. Auffray, "Systemes MIMO a porteuses multiples: Étude et optimisation de la combinaison de codes temps-espace et des techniques MC-CDMA", Ph.D. thesis, Institut National des Sciences Appliquées, Rennes, France, 2004 (in French).
- [25] V. Le Nir, "Étude et optimisation des systèmes multi-antennes associés à des modulations multiporteuses", Ph.D. thesis, Institut National des Sciences Appliquées de Rennes, France, 2004 (in French).
- [26] J. Antari, A. El Khadimi, D. Mammass, and A. Zeroual, "Developed algorithm for supervising identification of non linear systems using higher order statistics: modeling internet traffic", *Int. J. Future Gener. Commun. Netw.*, vol. 5, 2012.
- [27] S. Safi and A. Zeroual, "Blind non-minimum phase channel identification using 3rd and 4th order cumulants", *Int. J. Sig. Proces.*, vol. 4, pp. 158–168, 2007.

- [28] X. D. Zhang and Y. S. Zhang. "Fir system identification using higher order statistics alone", *IEEE Trans. Sig. Proces.*, vol. 42, no. 10, pp. 2854–2858, 1994.
 - [29] D. P. Ruiz, M. C. Carrion, A. Gallego, and J. A. Morent, "Identification of MA processes using cumulants: several sets of linear equations", *IEE Proc.-Vis. Image Sig. Process.*, vol. 143, no. 2, 1996.
-