



HAL
open science

Preparation of Low-loss Ge₁₅Ga₁₀Te₇₅ chalcogenide glass for far-IR optics applications

Huijuan Xu, Yuju He, Xunsi Wang, Qiuhua Nie, Peiquan Zhang, Tiefeng Xu, Shixun Dai, Xianghua Zhang, Guangming Tao

► **To cite this version:**

Huijuan Xu, Yuju He, Xunsi Wang, Qiuhua Nie, Peiquan Zhang, et al.. Preparation of Low-loss Ge₁₅Ga₁₀Te₇₅ chalcogenide glass for far-IR optics applications. *Infrared Physics and Technology*, 2014, 65, pp.77 - 82. 10.1016/j.infrared.2014.03.008 . hal-01060925

HAL Id: hal-01060925

<https://hal.science/hal-01060925>

Submitted on 4 Sep 2014

HAL is a multi-disciplinary open access archive for the deposit and dissemination of scientific research documents, whether they are published or not. The documents may come from teaching and research institutions in France or abroad, or from public or private research centers.

L'archive ouverte pluridisciplinaire **HAL**, est destinée au dépôt et à la diffusion de documents scientifiques de niveau recherche, publiés ou non, émanant des établissements d'enseignement et de recherche français ou étrangers, des laboratoires publics ou privés.

Preparation of Low-loss Ge₁₅Ga₁₀Te₇₅ Chalcogenide Glass for Far-IR Optics Applications

Huijuan Xu ^a, Yuju He ^a, Xunsi Wang ^{a*}, Qiuhua Nie ^a, Peiquan Zhang ^a, Tiefeng Xu ^a, Shixun Dai ^a, Xianghua Zhang ^b, Guangming Tao ^c

^aLaboratory of Infrared Material and Devices, Ningbo University, 315211, Ningbo, China

^bLaboratoire des Verres et ceramiques, Universite de Rennes I, 35042 Rennes Cedex, France

^cCREOL, The College of Optics & Photonics, University of Central Florida, Orlando, FL 32816, USA

Abstract: Ge₁₅Ga₁₀Te₇₅ (GGT) glass shows good transparency between 2 to 25 micron wavelengths, good chemical and thermal stability to be drawn into fiber, which appears to be a good candidate for developing far-IR fiber-optics devices, although there are strong absorption peaks caused by impurities in the glass. With the aim of decreasing the content of impurities and micro-crystal particles in prepared GGT glass samples, a rapid heating furnace and the fast distillation method based on vapor evaporation plus deposition under vacuum condition was adopted. Properties measurements including Differential Scanning Calorimeter (DSC), Vis-NIR and IR transmitting spectra were performed on the prepared glass samples. Dependence of optical loss on the types of oxygenic getters and their contents and glass quenching temperature was also studied. All these results show that the average optical losses of distilled glass samples were greatly improved by the designated purification processes. Besides, the quality of the glass samples can be improved with the optimized quenching temperature. In all, the optical loss of the glass can be reduced effectively. Minimum optical losses of 0.042 dB/cm at 9 μm and 0.037

*Corresponding author at: NO.818 Fenghua Road, Jiangbei District, Ningbo, China.
Tel: +86 5748760 0947; fax: +86 574 87600946.
E-mail address: xunsiwang@siom.ac.cn (X.S. Wang).

dB/cm at 12 μm are obtained after a right purification process, which are the lowest loss of the GGT chalcogenide glass nowadays.

Keywords: Chalcogenide glass; Optical loss; Purification;

1. Introduction

The Darwin mission performed by the European Space Agency (ESA) aims at detecting life signs in extra solar terrestrial planet [1,2]. The mission will scan the nearby universe in order to get its accurate contents of CO_2 which is regarded as one of the most important spectral signatures of life. Remote optical detection of CO_2 involves monitoring of its two vibrational absorption bands at 4 μm and 16 μm [3,4]. In this mission, a nulling interferometer operating in the IR is crucial for filtering useful IR light from the planet, cutting off and occulting the blinding light coming from the central star. One of the key optical elements of the interferometer will be a single-mode (SM) IR optical fiber or planar waveguide operating in the window of 3 to 20 μm . Therefore, a special glass is crucial for achieving a satisfactory detection limit. Current materials suitable for designing the SM fibers are the polycrystalline silver halides[5,6] and the glassy materials that belong to the broad family of the so-called chalcogenide glasses (ChGs)[7,8], especially that of Tellurium (Te) enriched ChGs due to its heavier atomic mass. Consequently the intrinsic multi-phonon absorption of Te-based ChG is shifted to longer wavelength in comparison with sulfur-based or selenium-based glasses.

Up to now, some advances of Te-based ChGs containing some glass former such as elements of Ge, Ga, I and As, have been reported[9,10]. Among these glasses, $\text{Ge}_{15}\text{Ga}_{10}\text{Te}_{75}$ (GGT) glass is a very promising material for transmitting far-IR radiation and developing IR fiber-optics devices. Advantages of GGT glass are: nontoxic ingredients (no As), low phonon energy, good transparency between 2-25 μm , good chemical stability and good thermal stability

to be drawn into fiber[11]. However, there is an intensive absorption peak around 15-20 μm band in the spectrum, which is assigned to a kind of Ga-O vibration, and it is very hard to be purified by common vacuum distilling method[12]. To decrease the intensity of oxide absorption peak, Zhang et al[13] prepared GGT glass mixed with oxygen getter Aluminum (Al) and obtained a loss of 0.6 dB/cm at 10 μm . However, the addition of metal getter would lead to an increase of scattering loss by impurities of oxides. Additionally, it is well known that Te-based ChGs are prone to devitrification as that Te has strong metallic character in comparison with S and Se, the presence of crystals will also increase optical scatter loss.

In this paper, a distilling method based on vapor evaporation plus deposition under vacuum condition was advanced with the aim of producing GGT glass with low impurity and high homogeneity. The results of purification, as well as optical loss spectra, were also investigated by using three different experimental conditions. These progresses appear as promising results in view of manufacturing high purity ChG glass containing Ga element. These glasses would also make preparations for the fabrication of optical fibers and planar waveguides.

2. Theory of vacuum distillation

In order to synthesize a GGT glass with low impurity level, it is necessary to remove impurities from raw materials. Vacuum distillation technique has attracted great attentions for its low cost and less pollution to our environment, as it drives high purity vapor flowing into target room from a raw material surface under vacuum. Besides, the boiling point of metal will decrease a lot under vacuum condition and that helps to speed up the distilling process. Meanwhile, the efficiency of distillation is dependent on the maximum admissible temperature of container and the vapor pressure of raw material.

Generally, the vapor pressure varies among different metal or metal-oxide (such as impurity),

therefore we can refine a certain metal according to the difference of vapor pressures between the metal and its impurities. The relationship between the vapor pressure of the metal and the temperature can be expressed by Clausius-Clapeyron equation[14,15]:

$$\frac{d_p}{d_T} = \frac{L}{T(V_1 - V_2)} \quad (1)$$

Where p is the vapor pressure of the metal, T is the temperature of the metal, L is the vaporizing latent heat of the metal. V_1 and V_2 represent the molar volume of gaseous metal and liquid metal, respectively. The value of $(V_1 - V_2)$ is approximately of the molar volume of gaseous metal (V_1) because V_1 is far larger than V_2 . Under low vapor pressure, Gas obeys ideal gas law: $V_1 = RT/p$, where R is a gaseous constant and equal to 4.575. Therefore, this equation can be rewritten as following equation:

$$\frac{d_p}{p} = \frac{L}{R} \cdot \frac{d_T}{T^2} \quad (2)$$

The vaporizing latent heat (L) relates to the temperature of the metal: $L = L_0 + aT + bT^2 + cT^3 + \dots$, so the equation (2) can be approximately expressed as the forms of eqs. (3)-(4):

$$\lg p = -\frac{L_0}{4.575} T^{-1} + \frac{a}{1.987} \lg T + \frac{b}{4.575} T + D \quad (3)$$

$$\lg p = AT^{-1} + B \lg T + CT + D \quad (4)$$

Where A , B , C and D are four constants varying with different metals[16]. The vapor pressures of Ge, Ga, Te, Si and Fe at different temperatures are calculated based on equation (4) and are shown in Figure 1. Here, the critical P means the value of vapor pressure when distill starting, the critical T means the lowest requirements of the temperatures to reach the critical P , as it decided by the thermodynamic data of the metals or metal-oxides. As shown in Figure 1, it is clear that a high temperature of 1400 °C (1673K) is needed to vaporize and distill Ge and Ga at a

vacuum of 10^{-3} Pa in theory. In fact, a component containing Ge and Te will appear and the vapor pressure of Ge-containing compound will increase enormously so that Ge can be easily purified by distillation at a temperature of 1050°C (1323K)[2], which is not the case for the Ga-containing glasses. As is known to all, quartz glass container can be used stably under 1050°C (1323K), and the short-term maximum temperature can be up to 1450°C (1723K). So it is needed to find a new way to fast vaporize metals and keep the stability of the quartz container at an ultimate temperature, meanwhile leave the oxides as residual (metallic oxides are usually more stable than the metals, such as Al_2O_3 (boiling temperature is 3250 K), and Ga_2O_3 (melting point is $2,173^{\circ}\text{ C}$).

3. Glass preparation and purification

Appropriate amounts of high purity Ge (99.999%), Te (99.999%) and Ga (99.999%) were used as starting raw materials for glass synthesis. Three different experimental conditions (3 series) were adopted to prepare GGT glasses in this paper, as shown in [Table I](#), and the details are illustrated in the followings:

Series A: the raw elements of 10 grams were loaded into two H-typed quartz tubes (Figure. 2). Different oxygenic getters were introduced into these two tubes: one (marked as G0) was doped with 500 ppm of Mg and another (marked as G1) with 500 ppm of Al. Both two tubes were sealed at position 1 after being evacuated down to about 2×10^{-3} Pa. Next, a rapid heating furnace 2 ($>1000^{\circ}\text{C}/\text{min}$) was used to heat the mixtures in section A to 1400°C and held for 10 minutes to guarantee that all the raw materials were distilled into section B, then the tubes were sealed at position 3. The oxide impurities (e.g. Al_2O_3 , MgO) remained in section A because of their low vapor pressures. At last, the mixtures were melted at 900°C using a rocking furnace and held for 18 hours before being lowered to 750°C for quenching.

Series B: Two tubes (marked as G2, G3) both containing 10 g of raw materials and 500 ppm Al were prepared as series A before the temperatures of the furnaces were subsequently lowered to 600 °C (G2) and 900 °C (G3).

Series C: the raw elements of 10 grams were loaded into two H-typed quartz tubes. Different contents of Al were introduced into these two tubes: one (marked as G4) was doped with 250 ppm of Al and another (marked as G5) with 400 ppm of Al. And the glass preparation process was the same as series A. Additional GGT glass (marked as G6) that hadn't been distilled was also prepared and its glass melting progress is the same as series A.

All seven tubes were quenched in water and annealed at the temperature of 160 °C for 5 hours before being cooled to room temperature slowly. The glass rods were then obtained by taking them out of the tubes. Glass rods were finally cut into disks and polished to a thickness of about 1 mm.

4. GGT glass and its optical loss

4.1 GGT glass characterizations

The thermal characteristics of the samples were measured by differential scanning calorimetry (DSC) in the temperature range of 50-350 °C at a heating rate of 10 °C/min. The glass transition temperature T_g , the onset crystallization temperature T_x and the differences $\Delta T = T_x - T_g$ for three glasses are reported in Table II. ΔT values of GGT glass samples are all over 100 °C, indicating that the GGT glass is stable against crystallization. A small improvement in the distilled glass samples is achieved comparing to the T_x value of non-distilled GGT glass G6. However, the purification process does not change the value of T_g and ΔT as much as the variation of glass composition.

The Vis-NIR transmission spectra of samples were recorded in the range of 1600-2500 nm

by using a PerkinElmer Lambda 950 UV-Vis-NIR spectrophotometer. The results are displayed in Figure 3, showing that the maximum transmittance of each glass sample varies with its thickness. However, the band-width of the transmission spectra of the seven glass samples are kept nearly the same, and there is no apparent absorption peak in this range because the absorption bands in ChGs caused by impurities are commonly located in the region of 2.5-20 μm . Small variation in the cut off edge may be ascribed to the thickness variation of the glass samples in a certain extent.

Quantitative analysis was carried out by an Energy Dispersive Spectrometer (Tescan VEGA 3 SBH, Czech). [Table III](#) lists the compositions of the final glasses, the precision of the analysis, as well as the contents of the impurities in studied glass samples. It can be seen that the change of their compositions were not very noticeable. In addition, only two main impurities exist in the glasses. High carbon content dropped down obviously in the purified glasses. The contents of oxygen decreased from 0.91 wt. % to 0 followed the increasing of the added Al in series C. Here, the contents of the other impurities, such as Na, Si and so on, were too low to be detected.

4.2 Optical loss of GGT glass

The IR absorption spectra of glass samples were recorded in the range of 4000-400 cm^{-1} by using a Nicolet 380 Fourier Infrared spectrophotometer. To evaluate the optical loss, the absorbance of a same GGT glass rod with different thickness of about 4 mm was also measured and the optical loss was calculated by following equation:

$$\alpha = \frac{\ln 10}{(L_1 - L_2)} \times (OD_1 - OD_2) \quad (5)$$

Where α is values of the optical loss, OD_1 and OD_2 are the absorbance of the GGT glass with a thickness of L_1 and L_2 , respectively ($L_1 > L_2$).

Figure 4 gives the optical losses of GGT glasses distilled with different oxygenic getters and non-distilled GGT glass (G6). Obviously, there is a broad absorption peak in 15-20 μm region caused by the impurities involving with Ga when the raw elements were not purified. The optical losses of distilled glasses are significantly lower than the glass without any treatment. Whereas, 500 ppm Mg is not enough for eliminating the oxide impurities as there is still strong absorption in 15-20 μm . While the oxide impurities were effectively removed after the same Al content being added, as that can be explained as the number of reducing valent state is 3 of Al, comparing 2 of Mg, just shown as equation 6.



The relationship between optical losses and quenching temperature is illustrated in Figure 5. It can be seen that the optical loss decreases with the increase of quenching temperature firstly, just as the comparison of G1 (750 $^{\circ}\text{C}$) to G2 (600 $^{\circ}\text{C}$). It can be explained that lower quenching temperature decreases the cooling rate which results in the formation of micro-crystals. Hence, the increase of quenching temperature reduces the amount of micro-crystals which is one of the sources for the scattering loss. Meanwhile, Higher quenching temperature than 750 can also increase the loss, just as the comparison of G3 (900 $^{\circ}\text{C}$) to G1 (750 $^{\circ}\text{C}$). It can be sourced from the inhomogeneity of the glass, as the quenching rate of outer part is quite different from that of inner part.

As shown in Figure 6, four glass samples distilled with different amounts of Al were prepared (the quenching temperatures of all glass samples are 750 $^{\circ}\text{C}$). At least, 400 ppm Al rather than 250 ppm Al is essential to thoroughly eliminate the oxide impurities in the range of 15-20 μm . The lowest optical losses were very close to 0.042 dB/cm at 9 μm and 0.037 dB/cm at

12 μm .

5. Discussion

The GGT glasses with low content of oxygen were achieved by use of a combination of chemical and distillation methods. When raw materials of element were melted without any treatment of purification, there would be a broad absorption band in the range of 15-20 μm and the average optical loss was much higher than distilled GGT glasses. The low optical losses of distilled GGT glasses are due to the absence of water and oxide impurities as well as silica impurities in form of inclusions. At present, lowest optical losses of 0.042 dB/cm at 9 μm and 0.037 dB/cm at 12 μm are obtained, which are the lowest loss to the telluride chalcogenide glass nowadays.

750 $^{\circ}\text{C}$ is the optimized quenching temperature to preparing low loss GGT glass. Higher or lower quenching temperature could result in the increase of optical loss. 400 ppm wt. of Al is the minimum amount of oxygen getter to remove oxygen from the raw materials in our case.

The increase of optical losses in the short wavelength range is due to electronic transition. The increase of optical losses in the long wavelength is due to intrinsic multi-phonon absorption[17]. These intrinsic absorptions can be reduced by modifying the glass composition.

As shown in equation (5), the optical losses of all glass samples depend on tested absorbance which would be influenced by the polishing level and glass optical homogeneity. In order to precisely estimate the optical losses of the investigated glasses, the dependence of the absorption coefficient on absorbance (OD) and the glass thickness (L) was expressed by the following equation:

$$OD \cdot \ln(10) = -2\ln(1 - R) + \alpha L \quad (7)$$

Where R is the reflectivity of investigated glass. α value was the slope of the curve

determined by plotting $OD \cdot \ln(10)$ as a function of glass thickness L . Figure 7 shows the relationship between $OD \cdot \ln(10)$ and L of glass G4 at two different wavelengths, all α values obtained from the curves are listed in Table IV. It can be seen that the values of $OD \cdot \ln(10)$ and thickness L have a linear relationship. The minimal optical losses were 0.059 dB/cm at 9 μm and 0.053 dB/cm at 12 μm for the G0 sample. Additionally, we presume that two reflections always exist in equation (7), so the OD does not tend to zero when the glass thickness is 0.

6. Conclusions

A rapid heating furnace was adopted and the fast distillation method based on vapor evaporation plus deposition under vacuum condition proved to be effective in preparing high purified GGT glass samples. Then, the dependence of optical loss on the type of oxygenic getters and their contents and quenching temperature were investigated. The best result of optical loss of 0.037 dB/cm at 12 μm was obtained. The average optical losses of distilled glasses were far lower than the glass without purification process. Higher or lower quenching temperature could also result in optical loss. Reducing metal Al was much more functional to decrease the oxide content in the GGT glasses. Only with 400 ppm wt. of Al and vacuum fast distillation, it would be good enough to remove all oxide absorption bands, to expand the transmission spectrum and to flat the spectra without any obvious absorption peak in all the range of 8-20 μm . In all, the results show that it is potential for developing a low-loss far-infrared fiber with the Ga-containing Te-based chalcogenide glasses, if that there is much more improvement of glass purification.

Acknowledgments

This work was financially supported by the Natural Science Foundation of China (Grant Nos. 61377099 and 61177087), Scientific Research Fund of Zhejiang Provincial Education

Department (R1101263), Natural Science Foundation of Ningbo (Grant No. 2013A610118), Teaching and Research Award Program for Outstanding Young Teachers in Higher Education Institutions of MOE, P.R.C. Ningbo optoelectronic materials and devices creative team (2009B21007) , Scientific Research Foundation of Graduate School of Ningbo University and sponsored by K. C. Wong Magna Fund in Ningbo University.

References

- [1] S. Danto, P. Houizot, C. Boussard-Pledel, X. H. Zhang, F. Smektala, J. Lucas, *Adv. Funct. Mater.* **16** (2006) 1847-1852.
- [2] X.S. Wang, Q.H. Nie, G.X. Wang, J. Sun, B.A. Song, S.X. Dai, X.H. Zhang, B. Bureau, C. Boussard, C. Conseil, H. Ma, *Spectrochim Acta, Pt A: Mol Biomol Spectrosc* **86** (2012) 586-589.
- [3] A. A. Wilhelm, C. Boussard-Plédel, Q. Coulombier, J. Lucas, B. Bureau, P. Lucas, *Adv. Mater.* **19** (2007) 3796-3800.
- [4] Z. Yang, P. Lucas, *J. Am. Ceram. Soc.* **92** (2009) 2920-2923.
- [5] V. Boev, M. Mitkova, E. Lefterova, T. Wagner, S. Kasap, M. Vlček, *J. Non-Cryst Solids* **266-269 B** (2000) 867-871.
- [6] A. Ksendzov, T. Lewi, O. P. Lay, S. R. Martin, R. O. Gappinger, P. R. Lawson, R. D. Peters, S. Shalem, A. Tsun, A. Katzir, *Appl. Opt.* **47** (2008) 5728-5735.
- [7] M. L. Anne, J. Keirsse, V. Nazabal, K. Hyodo, S. Inoue, C. Boussard-Pledel, H. Lhermite, J. Charrier, K. Yanakata, O. Loreal, J. le Person, F. Colas, C. Compère, B. Bureau, *Sensors* **9** (2009) 7398-7411.
- [8] P. Pattanayak, S. Asokan, *Solid State Commun.* **142** (2007) 698-701.
- [9] B. J. Eggleton, *Opt. Express* **18** (2010) 26632-26634.

- [10] Z. Yang, A. A. Wilhelm, P. Lucas, J. Am. Ceram. Soc. **93** (2010) 1941-1944.
- [11] B. Bureau, C. Boussard-Pledel, P. Lucas, X. Zhang, J. Lucas, Molecules **14** (2009) 4337-4350.
- [12] G.X. Wang, Q.H. Nie, X.S. Wang, X. Shen, F. Chen, T.F. Xu, S.X. Dai, X.H. Zhang, J. Appl. Phys. **110** (2011)043536-043536-5.
- [13] S. Zhang, X. H. Zhang, M. Barillot, L. Calvez, C. Boussard, B. Bureau, J. Lucas, V. Kirschner, G. Parent, Opt. Mater. **32**(2010)1055-1059.
- [14] R. Clausius, Annalen der Physik **155** (1850) 500-524.
- [15] M. C. Clapeyron, l'École polytechnique **23** (1834) 153-190.
- [16] Y. N. Dai, B. Yang, in: X.Y. Tan, C.F. Yang (Eds.), Fundamental theory and method of vacuum distillation, Metallurgical Industry Press, Beijing, 2006, pp. 20-31. (in chinese).
- [17] V. S. Shiryaev, J. L. Adam, X. H. Zhang, C. Boussard-Plédel, J. Lucas, M. F. Churbanov, J. Non-Cryst Solids **336** (2004) 113-119.

FIGURE CAPTIONS

Fig. 1. The vapor pressures of Ge, Ga, Te, Si and Fe at different temperatures

Fig. 2. Glass distillation and preparation flow chart. (a) Vacuum evacuating process, (b) Vacuum distilling process, (c) Glass synthesizing process. Here, 1: sealing point after evacuated, 2: high temperature region, 3: sealing point after distillation, A: raw materials containing tube, B: glass synthesizing tube.

Fig. 3. The Vis-NIR transmission spectra of the glass samples.

Fig. 4. Optical losses of glass samples, G0: GGT glass distilled with 500 ppm Mg, G1: GGT glass distilled with 500 ppm Al, G6: non-distilled GGT glass.

Fig. 5. Optical losses of glasses with different quenching temperatures (all glass samples were distilled with 500 ppm Al)

Fig. 6. Optical losses of glass samples distilled with different content of Al.

Fig. 7. The relationship between $OD \cdot \ln(10)$ and thickness L of glass G4 at two different wavelengths

TABLE I Sample details of the GGT glasses prepared under different experimental conditions.

TABLE II The thermal characteristics of studied glass samples.

TABLE III Impurities content of the glass samples.

TABLE IV Optical loss α of investigated glasses at two different

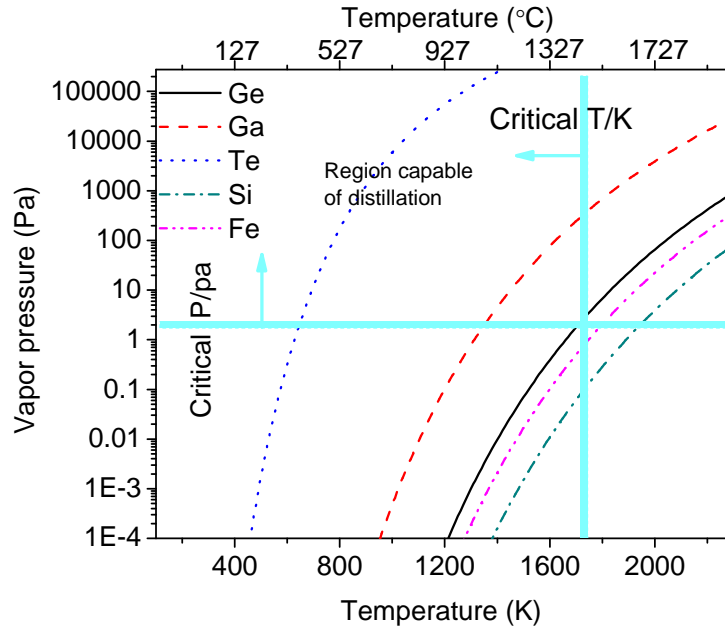

wavelengths.

FIG. 1. The vapor pressures of Ge, Ga, Te, Si and Fe at different temperatures

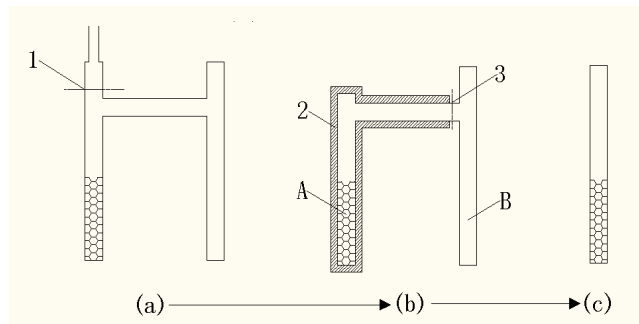

FIG. 2. Glass distillation and preparation flow chart. (a) Vacuum evacuating process, (b) Vacuum distilling process: the mixtures in section A are heated to 1400 °C and hold for ten minutes to guarantee that all the raw materials are distilled into section B, then the tube is sealed at position 3, (c) Glass synthesizing process. Here, 1: sealing point after evacuated, 2: high temperature region, 3: sealing point after distillation, A: raw materials containing tube, B: glass synthesizing tube.

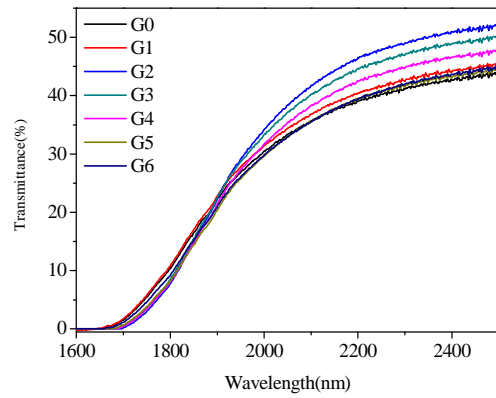

FIG. 3. The Vis-NIR transmission spectra of the glass samples.

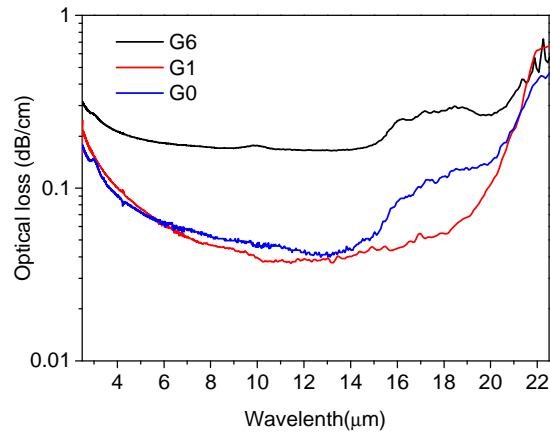

FIG. 4. Optical losses of glass samples, G0: GGT glass distilled with 500 ppm Mg, G1: GGT glass distilled with 500 ppm Al, G6: non-distilled GGT glass.

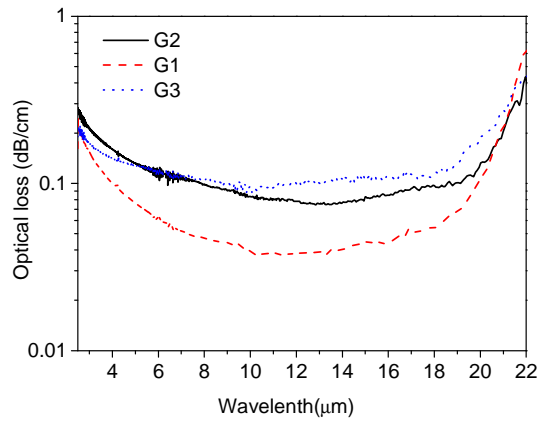

FIG. 5. Optical losses of glasses with different quenching temperatures (all glass samples were distilled with 500 ppm Al, and the quenching temperature of G2 is 600 °C, G1 is 750 °C, G3 is 900 °C).

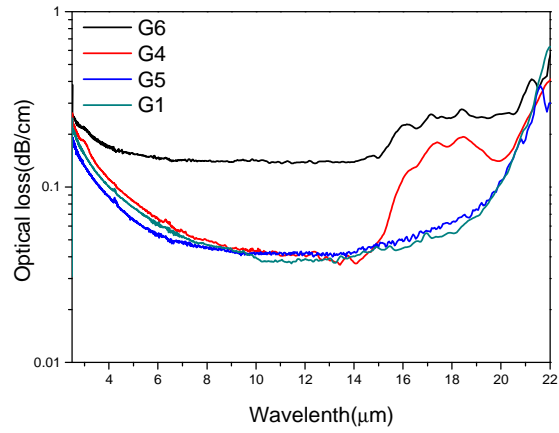

FIG. 6. Optical losses of glass samples distilled with different content of Al.

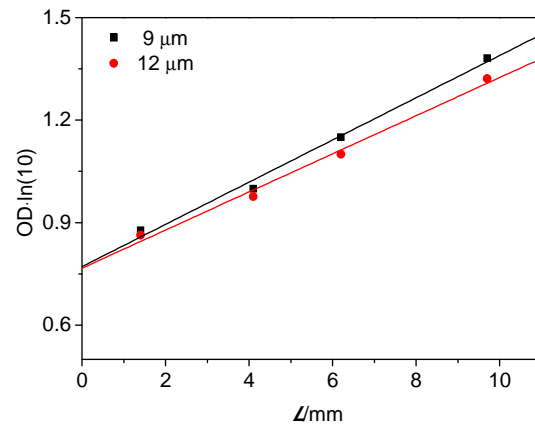

FIG. 7. The relationship between $OD \cdot \ln(10)$ and thickness L of glass G4 at two different wavelengths

TABLE I Sample details of the GGT glasses prepared under different experimental conditions.

Compositions	Reducing metal	Content [ppm]	Quenching Temperature [°C]	Thickness [mm]
Series A				
G6	None	0	750	1.1
G0	Mg	500	750	1.1
G1	Al	500	750	1
Series B				
G2	Al	500	600	1
G1	Al	500	750	1
G3	Al	500	900	1
Series C				
G6	None	0	750	1.1
G4	Al	250	750	1.2
G5	Al	400	750	1
G1	Al	500	750	1

TABLE II The thermal characteristics of studied glass samples.

Compositions	T _g	T _x	ΔT
G0	175.2	285.1	109.9
G1	176.2	285.6	109.4
G2	176.5	285.6	109.1
G3	176.4	285.6	109.2
G4	175.6	285.2	109.6
G5	175.6	285.5	109.9
G6	175.5	285	109.5

TABLE III Impurities content of the glass samples and the precision of EDS measurement.

	Ge		Ga		Te		C		O	
	Atom [at.%]	Error [wt.%]	Atom [at.%]	Error [wt.%]	Atom [at.%]	Error [wt.%]	norm [wt.%]	Error [wt.%]	norm [wt.%]	Error [wt.%]
Series A										
G6	8.67	0.32	5.7	0.22	44.08	2.21	6.28	1.03	0.91	0.23
G0	10.33	0.32	6.52	0.21	53.91	2.27	3.43	0.65	0.63	0.18
G1	11.61	0.34	6.08	0.22	58.47	2.78	3.14	0.76	-	-
Series B										
G2	9.45	0.32	6.26	0.22	49.14	2.41	4.64	0.84	0.76	0.21
G1	11.61	0.34	6.08	0.22	58.47	2.78	3.14	0.76	-	-
G3	12.56	0.33	8.39	0.19	64.35	2.43	1.76	0.41	-	-
Series C										

G6	8.67	0.32	5.7	0.22	44.08	2.21	6.28	1.03	0.91	0.23
G4	11.74	0.32	7.75	0.20	61.46	2.36	2.41	0.51	0.35	0.13
G5	11.44	0.33	7.56	0.19	60.07	2.42	2.41	0.52	-	-
G1	11.61	0.34	6.08	0.22	58.47	2.78	3.14	0.76	-	-

Table IV Optical loss α of investigated glasses at two different wavelengths

Compositions	α dB/cm ($\lambda=9 \mu\text{m}$)	α dB/cm ($\lambda=12 \mu\text{m}$)
G0	0.059±0.002	0.053±0.002
G1	0.063±0.005	0.060±0.006
G2	0.072±0.006	0.067±0.005
G3	0.125±0.025	0.125±0.024
G4	0.062±0.004	0.056±0.004
G5	0.067±0.012	0.063±0.012
G6	0.183±0.019	0.178±0.018