



HAL
open science

Controlling the tape's gap in robotized fiber placement process using a visual servoing external hybrid control scheme

Maylis Uhart, Olivier Patrouix, Yannick Aoustin

► To cite this version:

Maylis Uhart, Olivier Patrouix, Yannick Aoustin. Controlling the tape's gap in robotized fiber placement process using a visual servoing external hybrid control scheme. The International symposium Aircraft Materials (ACMA2014), Apr 2014, Morocco. <hal-01060699>

HAL Id: hal-01060699

<https://hal.science/hal-01060699v1>

Submitted on 4 Sep 2014

HAL is a multi-disciplinary open access archive for the deposit and dissemination of scientific research documents, whether they are published or not. The documents may come from teaching and research institutions in France or abroad, or from public or private research centers.

L'archive ouverte pluridisciplinaire **HAL**, est destinée au dépôt et à la diffusion de documents scientifiques de niveau recherche, publiés ou non, émanant des établissements d'enseignement et de recherche français ou étrangers, des laboratoires publics ou privés.



HAL Authorization

Controlling the tape's gap in robotized fiber placement process using a visual servoing external hybrid control scheme

Maylis Uhart^{1,2}, Olivier Patrouix¹, Yannick Aoustin²

¹ ESTIA, ESTIA Recherche, Technopole Izarbel, 64210 Bidart, France (m.uhart@estia.fr)

² UNAM, IRCCyN de Nantes UMR CNRS 6597, 1 rue de la Noë, 44321 Nantes Cedex 3, France

Keywords: *Manufacturing, Robotized Fiber Placement, Hybrid control, Structured light imaging.*

Abstract

Composite materials are increasingly used in the demanding field of aeronautics. To meet this growing need, *Coriolis Composites* has developed a solution of automated fiber placement named AFP. This system uses an industrial manipulator robot with six axes. This fiber placement task requires a compacting strength adapted to the material used. The robot must be kept in contact with the mold and controls the compacting strength. For the robot trajectories generation, the software specifies the position of each tape before the manufacturing of the part. During the lay-up, there may be a difference between the position of theoretical tapes and the position of real tapes. So, accuracy problems appear. Within this framework, the industrial project IMPALA was born in order to improve this new process. This paper shows the use of visual servoing to handle the position in order to improve the fiber placement accuracy.

1 General Introduction

More and more industries use composite materials for manufacturing their mechanical structures with various processes. The carbon fibers consumption in the market segment shows the sectors that use the most this material [1]. In 2012, Europe has consumed most of composites in the following areas: Aerospace & Defense (46 % of 8.100 t), Wind Turbines (74 % of 9.5 t) and Automotive (56 % of 2.150 t). Asia has consumed most of composites in Sport and Leisure (86 % of 7.800 t).

With hand lay-up, despite the high level of skills of composite worker, there is a lack of repeatability on large and complex structure. On the contrary, the Automated Tape Placement has got a better repeatability and the production efficiency is improved. In order to have better repeatability and accessibility, research work has been carried on the fiber placement process to use robots [2]. This paper presents the work done within the framework of the industrial project IMPALA, managed by Coriolis Composites, which has developed a solution for Automated Fiber Placement.

The robotic cell is made of a six DOF robot mounted on a linear axis allowing the robot to move, and draping on a vacuum table or on a positioning system. Thus, eight axes have to be synchronized. The carbon fiber coils are located in a creel, and carbon fibers are sent to the fiber placement tool using the umbilical fibers guide. The tape width could be setup from one fiber (1/4") to height or 16 or 32 carbon fibers (Figure 1-a). To heat the wrapping surface area, an infrared lamp or a diode based laser is used according to the material and heating temperatures to be achieved.

One of the project's objectives is to improve the laying quality and the accuracy of robotized fiber placement in terms of gap between tapes. To do that, there are four objectives. Firstly, we identify the source of errors and understand the mechatronic system. Then, we find the control strategy most relevant and adjust the accuracy control of the laying-up. We propose to add an external sensor based control loop to adjust the position perpendicular to the laying direction.

Research work has been carried out in laboratory on visual servoing with robot manipulator for years [3]

but only recently, industrial controllers propose an entry point to support external sensors. Visual servoing task is defined in the sensor space (image frame). Thus, the robot is controlled according to the visual data.

This paper describes the task of fiber placement in Sect. 2. The visual servoing scheme is presented in Sect. 3. Section 4 describes the sensor-based control implemented in Sect. 5. Conclusions and future works are presented in Sect. 6.

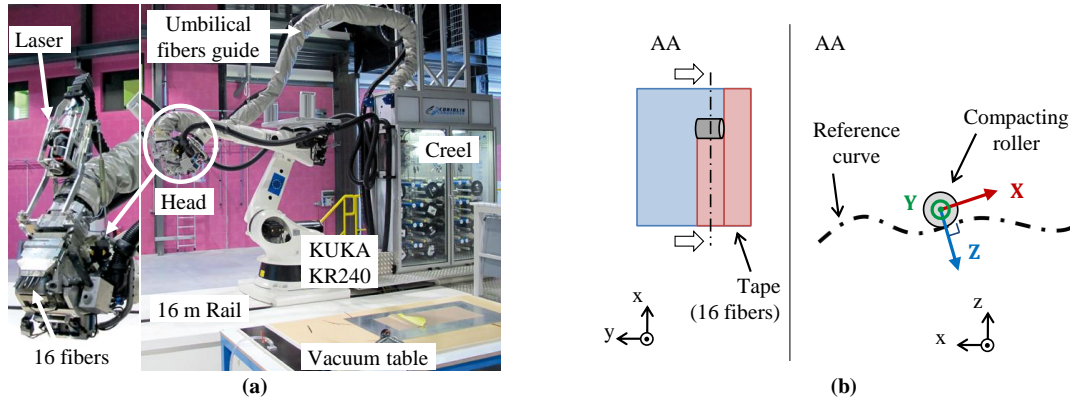

Figure 1. AFP process (a) Robotic cell for Fiber Placement (b) Task definition

2 Description of the current system

The tool-path of the laying head is generated by software named CATfiber and CADfiber. Software is developed by Coriolis Composites and the CAD data of workpiece is used. They specify position of each tape separately before the lay-up. It is an offline programming. Tape interval is needed in accordance with client instructions (Figure 2-a).

The process uses an important compacting strength which should be normal to the surface. This compacting strength leads to increase the effects of the robot flexibility, which tends to generate unwanted gap or overlap during the lay-up because of disturbing forces and torques. No correction is made during the lay-up. So, there may be difference between theoretical tool-path and real lay-up because of incorrect positioning (Figure 2-b).

An external force sensor control scheme has been tested in our laboratory robot. It has a positive impact on the system to improve accuracy [4]. The disturbing force along y-axis is decreased but it is not sufficient to have a precise positioning along y-axis.

So we propose to apply a similar control scheme using a vision system to address the laying quality aspects: control the gap and avoid overlap respecting tape interval. The laying task will be defined in the sensor space. So the robot path will be modified in position along y-axis of the tool with a feedback in space coordinates. The previous tape is considered as reference for the next tape. The two tapes are juxtaposed (Figure 2-c) but the tolerance on ply orientation must be taken into account.

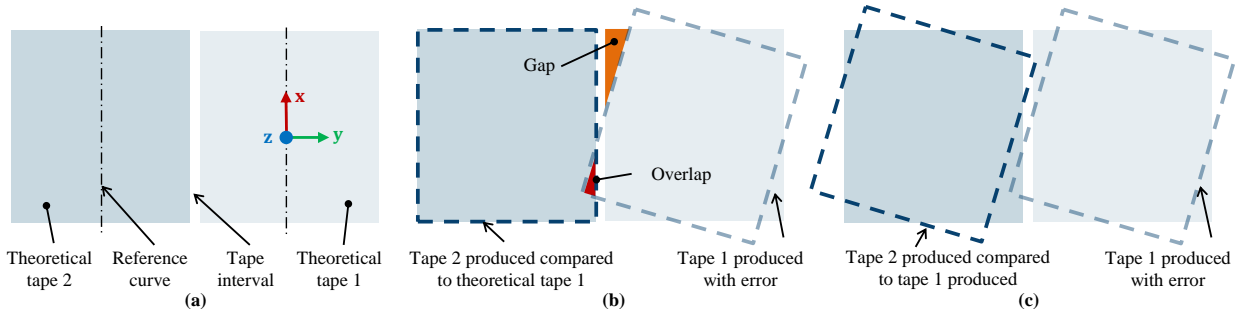

Figure 2. Problems of lay-up (a) Programming (b) Production with position servoing along y-axis (c) Production with visual servoing along y-axis

3 Visual servoing

For image processing and analysis, the color is not insignificant. The carbon color is black (Figure 3-a). This adds a difficulty to detect the tape edge on a previous ply. Mold can be fixed on various supports like vacuum table, vertical positioning system or horizontal positioning system. So, the mold orientation is modified during the manufacturing process. Sometimes, a laser diode is used to heat the wrapping area. Its reflectance should be taken into account. Because of these constraints, a stand-alone camera will not suit. In fact, the carbon fiber is not a friendly material with respect to imaging systems.

Consequently, the idea is to use a high speed camera coupled with a laser projector [5]. The structured light (laser plan) is useful for the image processing. The intersection of the laser plan and the surface of the part will produce a line. The structured light allows capturing the 3D shape information on the part by analyzing the intersection between the light pattern and the part [6]. This, allows us to detect the tape edge by analysis of the deformation of the laser line when the thickness changes. The camera and the laser projector are embedded on the fiber placement tool (Figure 3-b).

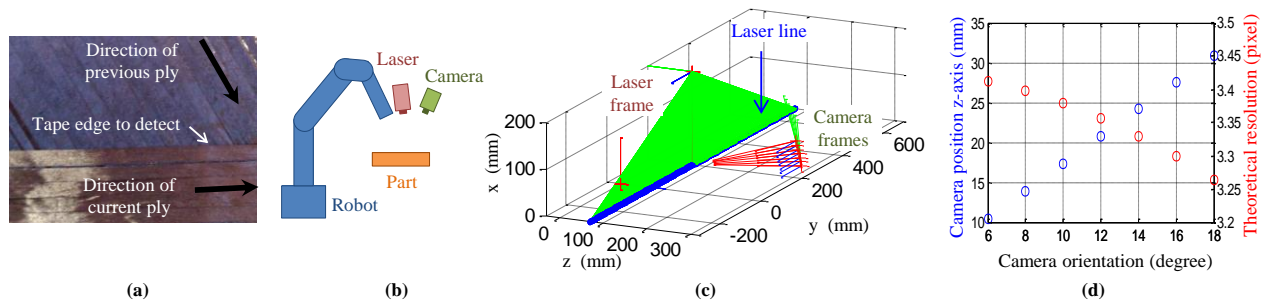

Figure 3. Visual servoing (a) Carbon plies (b) Eye in hand configuration (c) Laser and camera configuration (d) Theoretical resolution depending on camera orientation

3.1 Active vision system

The previous tape on the ply will produce a thickness modification, which creates a discontinuity or a curvature modification of the laser line in the image. We present the devices and the geometrical parameters to maximize the tape detection.

To study position and orientation of the camera and the laser on the fiber placement tool, we use a simulator created with the software Matlab. It allows us to maximize the vision of the thickness change corresponding to the tape edge. Therewith, we can set various parameters like the distance and orientation between elements (Figure 3-c). The focal distance camera is equal to 1715 pixels (based on calibration software). The laser is perpendicular to the surface. The distance between the laser and the camera is equal to 100 mm. The thickness to detect is equal to 0.2 mm. The thickness of carbon ply varies between 0.1 mm and 0.3 mm. For the simulation, the angle between the camera and the laser plan varies between 6° and 18° and the height of camera varies between 10 mm and 35 mm. The height variation is the consequence of the angle. In this way, we obtain the theoretical resolution in accordance with the camera position and orientation (Figure 3-d). We have the best resolution when the camera orientation is equal to 6° but the height of the camera is only 10 mm. So, we have to make a compromise. If we set the camera orientation to 10° and the camera position to 25 mm, we can detect a thickness change of 0.2 mm with a number of pixels between 3.35 and 3.4.

For our experimentations, we use a laser Lasiris of the manufacturer StockerYale Canada with a wavelength of 635 nm and a power of 7 mW. Lines are projected on the surface by the laser. The vision system is a Firefly camera MV FMVU-13S2C of the manufacturer Point Grey Research. The standard resolutions are 640x480 pixels and 1280x960 pixels. The maximum frames per second are 60 and the dimensions of camera are 44mm x 34mm x 24.38mm.

3.2 Image processing and analysis

The use of a structured light vision system makes the image processing task more efficient because the laser light produces a high contrast so the hypothesis of two objects in the image is verified. The object

classification is line and background. We present the image analysis used to locate the tape position [7].

First, it is very important to set the camera parameters such as the brightness, the gain and the shutter. In this way, we can make easier the distinction between the two objects with the image processing and analysis.

Secondly, we can capture an image from camera with the correct settings. Because the camera is embedded on the tool, the data are always in the same place on the image. So, we select a Region Of Interest (ROI) on the captured image. This allows removing the potential noise from the rest of the image and reducing time computing. In fact, the image processing and analysis are made only on the ROI.

Then, a low-pass filter is applied to remove noise. This image is converted in binary image and two objects can be observed such as the background and the laser line. So, a contour detection of these objects is made and then a contour extraction.

Finally, from the last image we can make the image analysis. To extract the tape edge, we can use a polyline approach of the laser line skeleton or Hough transform [8] to detect the lines in the image but also a vertical Sobel filter to draw ellipse and its center. Then, the ellipse center will be aligned to the target defined in the sensor space (i.e. the image) on the tape edge after calibration.

4 Sensor-based control scheme

4.1 External hybrid control

Because we work in industrial application, the inner loop of the controller is inaccessible for warranty issues system. So we have to add an external loop to allow the visual servoing [9]. This allows converting the delta of pixel $\Delta\mathbf{V}$ into the processing image in delta of position in millimeters $\Delta\mathbf{X}_V$ for the inner loop. The dual command (position/vision) can be managed in the Cartesian and the sensor spaces. The theoretical tool-path can be followed while applying a correction in a chosen direction associated with the task definition in the sensor space. The directions controlled in position and the directions controlled in vision are chosen with the diagonal selection matrix \mathbf{S} .

The external hybrid position/visual control is described in the Figure 4. The tape edge is extracted from the processing image and its position is measured in pixel \mathbf{V}_{meas} . This is compared to the position desired of the tape edge in pixel into the image \mathbf{V}_{des} . Then, the delta of pixels $\Delta\mathbf{V}$ is converted in delta of position in millimeters $\Delta\mathbf{X}_V$ through the visual control law. At the same time, the desired position \mathbf{X}_{des} of the placement tool is compared to the measured position \mathbf{X} . The delta $\Delta\mathbf{X}$ is converted in delta of position $\Delta\mathbf{X}_P$ through the position control law. So, the delta $\Delta\mathbf{X}_{VP}$ is composed of directions controlled in position and others directions controlled in vision via the selection matrix \mathbf{S} . Moreover, it is sent to the RSI module to be added to the current position. The Robot Sensor Interface module (RSI) allows sensor integration [10]. The RSI sampling period is equal to 12 ms when using Ethernet communication. A PID correction is implemented on the visual control law to manage the lateral position along y-axis and to drive the tape interval correctly.

For this preliminary testing with visual servoing, the direction along z-axis is controlled in position to make the compacting force.

4.2 Visual Control Law

On the image captured from camera, the tape edge is measured in pixel and the target too. So the delta along y-axis in the image is in pixel. The correction is made with a numerical PID:

$$u^*(t) = K_p e(t) + K_i \int_0^t e(\tau) d\tau + K_d \frac{d}{dt} e(t) \quad (1)$$

e is the error of pixels on the image between the tape edge and the roller edge. t is the time. dt is equal to 12 ms because of the RSI loop. τ is the variable of integration. u^* is the output of the controller in pixel. K_p is the proportional correction. K_i is the integral correction. K_d is the derivative correction. For the moment, an efficient tuning of the gains is experimentally obtained. Then, the output of the controller $u^*(t)$ has to be converted in millimeters with: $u(t) = \alpha u^*(t)$.

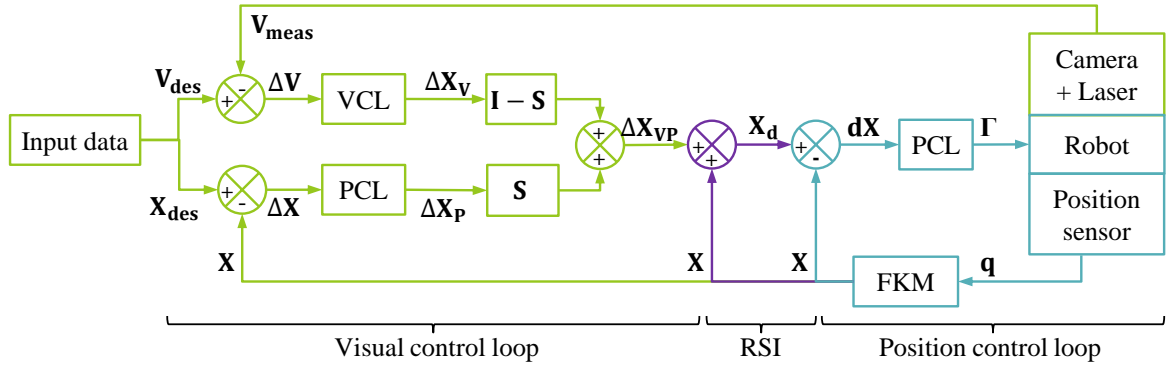

VCL: Visual Control Law; PCL: Position Control Law; RSI: Robot Sensor Interface;
FKM: Forward Kinematic Model

\mathbf{V}_{des} : Tape edge position desired in the image camera (pixel); \mathbf{V}_{meas} : Tape edge position measured in the image camera (pixel); $\Delta \mathbf{V} = \mathbf{V}_{des} - \mathbf{V}_{meas}$ (pixel); $\Delta \mathbf{X}_V$: Delta of position-orientation to correct the position of the tape edge (mm); $\mathbf{I} - \mathbf{S}$: allows to control \mathbf{V}_y ; \mathbf{X}_{des} : Position-orientation desired; \mathbf{X} : Current position-orientation in the reference frame; $\Delta \mathbf{X} = \mathbf{X}_{des} - \mathbf{X}$; $\Delta \mathbf{X}_P$: Delta of position-orientation to correct position and orientation; \mathbf{S} : allows to control specific directions in position-orientation; $\Delta \mathbf{X}_{VP}$: Delta of position-orientation to do; $\mathbf{X}_d = \mathbf{X} + \Delta \mathbf{X}$: Position-orientation desired in Cartesian space for the control position loop; $\mathbf{dX} = \mathbf{X}_d - \mathbf{X}$; Γ : Vector of the torques of actuators; \mathbf{q} : Vector of joints.

Figure 4. External hybrid position/visual control

5 Experimental results

5.1 Thickness detection

We present the image processing results for the thickness detection on several environments: artificial ones and carbon fiber parts. Images processing approaches (hough transform, curve detection,...) are tested and compared. These results allow us to calibrate the sensor for the robot task definition.

For each grabbed frame from camera, the image is processed and analyzed. Figure 5-a shows the laser projection on cardboard and sheet setup. Figure 5-b shows the laser projection with camera set. The Hough analysis is presented in Figure 5-c and the polyline analysis in Figure 5-d. If the laser line is split in two parts due to a large thickness, the Hough transform is preferred to detect the tape edge. However, the polyline analysis gives better results when the laser line is not split.

The leap is detected and an ellipse is drawn. The center of this ellipse is computed and compared to the target drawn on the same image (Figure 6-a). The program has to compute the delta in pixel and translate it in millimeter for the robot with the visual control law.

Moreover, a displacement of the fiber placement tool along y-axis of one millimeter corresponds to a delta of nine pixels into the image. Consequently, without taking the image noise in consideration, a delta of one pixel into the image corresponds to a delta of 0.11 mm for the fiber placement tool.

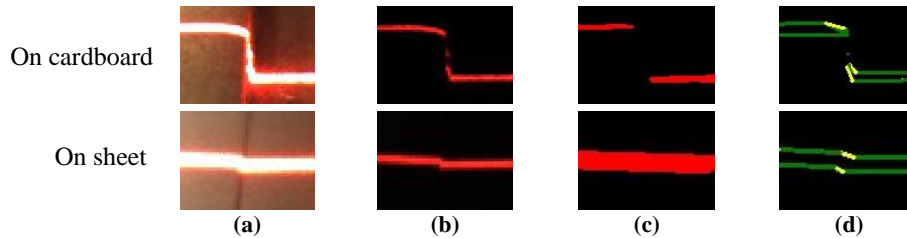

Figure 5. Image processing results (a) Laser projection on setup (b) Image for processing after camera setting (c) Hough analysis (d) Polyline analysis

5.2 Visual servoing process

For the preliminary testing, we use the robotic cell of the engineering school ESTIA, based on a KUKA KR6 robot. A compacting roller and its support are added on the robot. A plate in carbon fibers composed by one complete ply and one tape is put on the table (Figure 6-b). A client-server type communication allows the client “robot” to communicate with the client “camera” thanks to the application server through the TCP/IP communication. In this way, the client “robot” sends its configuration and the position/orientation of the fiber placement tool to the client “camera” via the server. The client “camera” computes the necessary delta of position in millimeters after analysis of the camera capture and sends it to the client “robot” via the server. The development of server and clients was made with the Visual Studio environment in C# language.

One direction is controlled using the image space information along y-axis. To calibrate the client “camera”, the fiber placement tool is placed at the tape edge. On the interface of the client “camera”, we can see the camera captures and set the target in the right place, at the tape edge. In this way, with the visual control mode, the ellipse center will align with the tape edge computing the delta of pixels along y-axis. For our tests, the plate is deliberately shifted to simulate incorrect placement of the previous tape.

In position control mode, the fiber placement tool goes down manually on the plate. Then, the robot is controlled in position along x-axis to make a movement of 200 mm. During this displacement, the position in pixel along y-axis of the ellipse center is measured and compared to the position of the target. At the end, the fiber placement tool lifted through manual mode.

In visual control mode, the lateral position is controlled in closed loop. The robot is controlled in position following x-axis to make a displacement of dx millimeters and it is controlled in visual servoing following y-axis to be aligned on the tape edge. Here, the fiber placement tool trajectory is modified to keep align the compacting roller at the previous tape edge during the displacement.

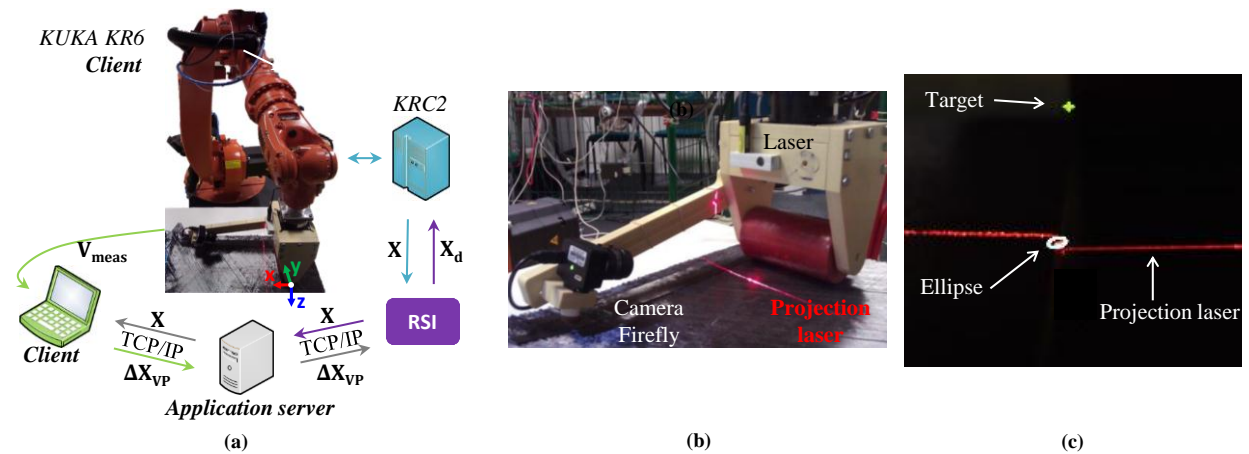

Figure 6. Process (a) Test environment (b) Zoom on test environment (c) Thickness detection

5.3 Results

The visual servoing control scheme results are discussed for the tape-to-tape laying to demonstrate the improvements.

First, the system is controlled in position as the actual implementation. When the tool moves along x-axis about 200 mm (dX_{tool}), the tool position along y-axis (dY_{tool}) is not modified (Figure 7-a). However, the position measured along y-axis in pixel on the image ($Y_{measured}$) is different from the target (Y_{target}) specified at the beginning (Figure 7-b). We can see that up to 5 s, the robot moved about 35 mm along x-axis and there is a gap between the compacting roller and the tape edge. Between 5 s and 7 s, the robot moves about 30 mm and the compacting roller is aligned to the tape edge. Between 7 s and 20 s, the robot moved about 135 mm and there is an overlap.

Then, the system is controlled with hybrid position/visual control mode. Here, the tool position is corrected along y-axis (dY_{tool}) (Figure 8-a) in order to maintain the ellipse center on the image (Y_{measured}) aligned to the target (Y_{target}) (Figure 8-b). At the beginning, there is a gap between the fiber placement tool and the tape edge. So, up to 2.5 s, the robot has corrected its trajectory to be aligned to the tape edge. Then, we can see that the ellipse center varies around the target, set to 252 pixels, because the fiber placement tool has corrected its position along y-axis. Despite the first PID settings, the mean value of ellipse center y-axis position is 256 pixels during the displacement with visual servoing control. In average, the error mean value is equal to 4 pixels or 0.4 mm. The maximum deviation is equal to ± 15 pixels or ± 1.5 mm due to the leap detection. Moreover, we can observe that the displacement along y-axis with the hybrid position/visual control mode (Figure 8-a) is a mirror of the position measured along y-axis in pixel on the image with the position control mode (Figure 7-b).

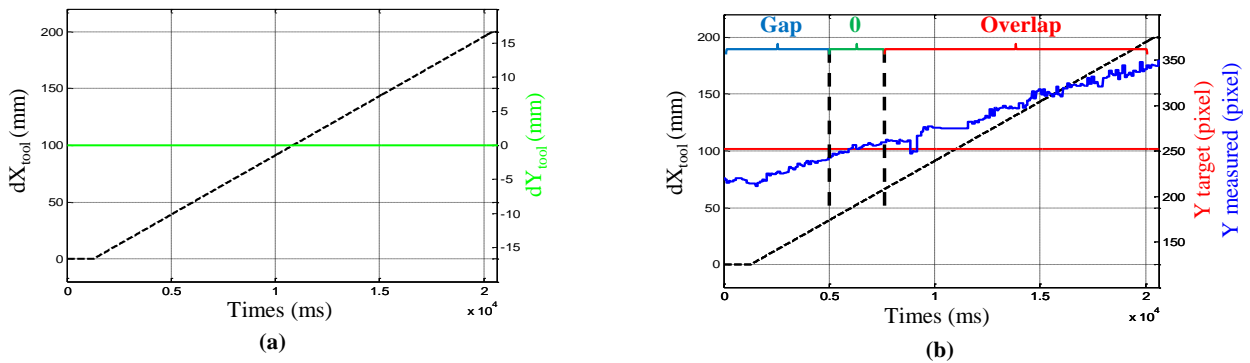

Figure 7. Position control mode (a) Tool position along y-axis in millimeter (b) Tool position along y-axis in pixel on the image

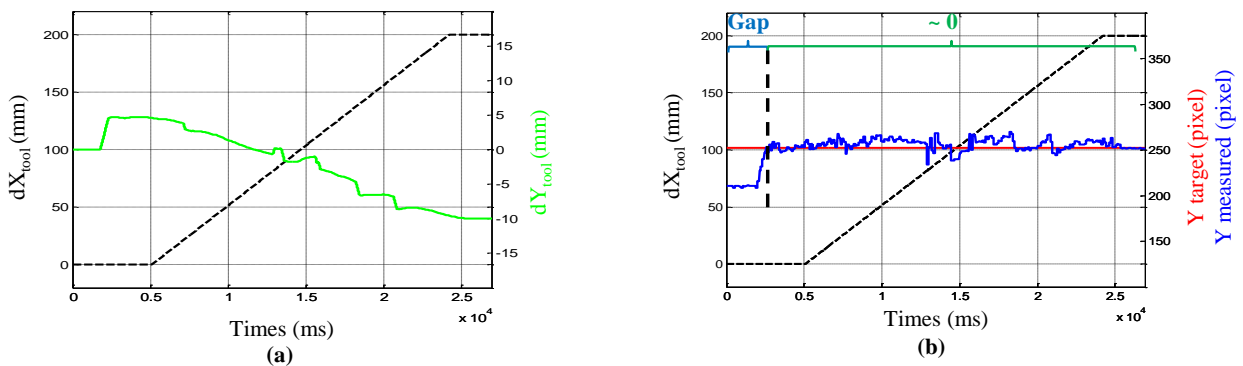

Figure 8. Visual control mode (a) Tool position along y-axis in millimeter (b) Tool position along y-axis in pixel on the image

6 Conclusions

To control the gap between fiber tapes, we have implemented an external hybrid command for the robot. This helped us in fulfilling the aeronautical specification of composites parts designers and manufacturers.

The first results show that if the first tape position is not corresponding to the theoretical tape position, we obtain gap or/and overlap between the two tapes. However, the hybrid position/visual control has a positive impact on the system to improve its accuracy. In fact, the two tapes are aligned.

From an industrial point of view, we have to improve the detection robustness. So, we plan to work with texture analysis to detect the tape edge [11]. Moreover, we made the preliminary testing with the standard brightness of a workshop. It is possible to have pollution of neon light at 50 Hz. So, we can imagine adding a fairing to isolate the system from noise.

To enhance the global robotized process, the combination of force and vision sensors [12] is envisaged in future testing on our new Kuka hardware (KRC4 controller) where the sampling period can be reduced to 4 ms (RSI module).

Acknowledgment

This research work was done in the frame of the IMPALA project, a French funded project from FUI-011 program, under the convention n° F 11 08 008 B. The project consortium is composed by Coriolis Composites, Dassault Aviation, Daher-Socata, Composites Aquitaine (an EADS Sogerma company), CompositAdour, Ecole Centrale de Nantes and ESTIA.

References

- [1] E. Witten (AVK), B. Jahn (CCeV) . “Composites Market Report 2013: Market developments, trends, challenges and opportunities” in *Carbon Composites*, 2013.
http://www.avk-tv.de/files/20130917_market_report_2013_2.pdf
- [2] N.J.Johnston, H.L.Belvin, R.J.Cano, J.M Marchello, A.B.Hulcher. “A prototype research laboratory for automated fabrication of high performance composites” in *Proc. of The 12th International Conference on Composite Materials ICCM12*. 1999, Paris, France
- [3] P. Corke. “Visual control of robots: High performance visual servoing.” *Research Studies Press LTD*, 1996
- [4] M. Uhart, O. Patrouix, Y. Aoustin, J. Canou. “Improving accuracy in robotized fiber placement” in *Proc. of The 19th International Conference on Composite Materials ICCM19*. 2013, Montreal, Canada
- [5] J.Pagès, C. Collewet, F. Chaumette, J. Salvi. “Optimizing Plane-to-Plane Positioning Tasks by Image-Based Visual Servoing and Structured Light”. *IEEE Transactions on Robotics*, Vol. 22, No. 5, pp 1000-1010. 2006
- [6] Jing Xu, Ning Xi, Chi Zhang, Quan Shi. “Real-time 3D shape measurement system based on single structure light pattern” in *Proc. ICRA*. 2010, pp.121,126, Anchorage, Alaska
- [7] Z. Yin, X. Yuan, G. Zhang, H. Zhao. “Research on structured light 3D vision in the remanufacturing system based on robotic arc welding” in *Proc. WCICA*. 2012. pp.4527-4531. Beijing, China
- [8] R. O. Duda, P. E. Hart. “Use of the Hough transformation to detect lines and curves in pictures.” *Communications of the ACM*, 15(1) :11–15, January 1972
- [9] A. Burlacu, C. Lazar. “Image based controller for visual servoing systems”. *Buletinul Institutului Politehnic in Proc. DIN IAȘI*. 2008
- [10] H. Rapp. “A Ping-Pong Ball Catching and Juggling Robot: a Real-Time Framework for Vision Guided Acting of an Industrial Robot Arm” in *Proc of The 5th International Conference on Automation, Robotics and Applications*. 2011. pp.430-435. Wellington, New Zealand
- [11] Y. Xia, D. Feng, R. Zhao. “Morphology-Based Multifractal Estimation for Texture Segmentation”. *IEEE Transactions on Image Processing*, Vol. 15, No. 3. pp.614-623. 2006.
- [12] M. Prats, P. Martinet, S. Lee, P. J. Sanz. “Compliant Physical Interaction based on External Vision-Force Control and Tactile-Force Combination” in *Proc. of IEEE/ International Conference on Multisensor Fusion and Integration for Intelligent Systems*. 2008. pp.405-410. Seoul, Korea.