



HAL
open science

Concordia, Antarctica, seismic experiment for the International Polar Year

Alessia Maggi, Maxime Bes de Berc, Jean-Yves Thoré, Jean-Jacques Lévêque

► **To cite this version:**

Alessia Maggi, Maxime Bes de Berc, Jean-Yves Thoré, Jean-Jacques Lévêque. Concordia, Antarctica, seismic experiment for the International Polar Year. *Annals of Geophysics*, 2014, 57 (3), pp.SS0329. 10.4401/ag-6381 . hal-01056059

HAL Id: hal-01056059

<https://hal.science/hal-01056059>

Submitted on 25 Nov 2021

HAL is a multi-disciplinary open access archive for the deposit and dissemination of scientific research documents, whether they are published or not. The documents may come from teaching and research institutions in France or abroad, or from public or private research centers.

L'archive ouverte pluridisciplinaire **HAL**, est destinée au dépôt et à la diffusion de documents scientifiques de niveau recherche, publiés ou non, émanant des établissements d'enseignement et de recherche français ou étrangers, des laboratoires publics ou privés.



Distributed under a Creative Commons Attribution 4.0 International License

Special section: Geophysical monitorings at the Earth's polar regions

Concordia, Antarctica, seismic experiment for the International Polar Year (CASE-IPY)Alessia Maggi^{*}, Maxime Bes de Berc, Jean-Yves Thoré, Jean-Jacques Lévêque*Institut de Physique du Globe de Strasbourg (IPGS), Université de Strasbourg/ EOST, CNRS, Strasbourg, France***Article history**

Received June 30, 2013; accepted October 17, 2013.

Subject classification:

Antarctica, Seismology, Concordia, IPY, POLENET.

ABSTRACT

The CASE-IPY project, part of the larger POLENET initiative of geophysical observations for the International Polar Year, was built on our extensive experience of running seismological stations in Antarctica, both on rock sites (Dumont d'Urville station), and directly on the ice plateau (Concordia station). For CASE-IPY, we deployed 8 temporary seismic stations on the Antarctic plateau: 3 situated near Concordia itself (starting 2008), and the other 5 regularly spaced between Concordia and Vostok (2010-2012), following the maximum in ice topography. The technical problems we have encountered in our field deployments were essentially due to a combination of extreme environmental conditions and isolation of deployment sites. The 3 stations near Concordia were used as test sites to experiment different solutions, and to converge on a design for the 5 main stations. Results from the nearest stations, which transmit data regularly to Concordia, are very promising. The data recorded by our stations will be distributed widely in the scientific community. We expect them to be exploited essentially for structural studies involving Antarctica itself (its ice-cap, crust and lithosphere) via receiver functions, noise correlation, and surface-wave tomography, but also for studies of the Earth's core.

1. Introduction

The Concordia, Antarctica, seismic experiment for the International Polar Year (CASE-IPY, <http://case.u-strasbg.fr>) was funded by Agence Nationale de la Recherche (ANR, <http://www.agence-nationale-recherche.fr/>) as part of a larger IPY initiative, the Polar Earth Observing Network (POLENET, <http://www.polenet.org/>), which included contributions from 24 countries, including China, Japan, France and the United States. The aim of the POLENET consortium was to investigate polar geodynamics, the Earth's magnetic field, crust, mantle and core structure and dynamics, and systems-scale interactions of the solid earth, the cryosphere, the oceans and the atmosphere. Activities were focused on deployment of autonomous observatories at remote sites on the continents and offshore, coordinated with

measurements made at permanent observatories.

Seismological data from the POLENET observatories, once they have been fully recovered and distributed, will provide the first relatively high-resolution data on the Earth beneath the polar seas and ice sheets. Advanced techniques to image the Earth's deep interior, such as seismic tomography, will be used to place constraints on the planet's internal processes. Seismic imaging of the crust and mantle will (i) investigate causes for anomalously high elevations in East Antarctica, linked with ice sheet development; (ii) provide information on heat flow and mantle viscosity that are key factors controlling ice sheet dynamics and the Earth's response to ice mass change; (iii) provide constraints on the magma sources for polar volcanism. The axial vantage points of the poles will allow unprecedented studies of Earth's inner core, contributing to our understanding of the initial differentiation of the Earth, the Earth's thermal history, and the physics and variability of the Earth's magnetic field. Enhanced seismic station coverage will vastly improve the detection level for earthquakes and permit evaluation of seismotectonic activity across the remote high latitudes.

At the start of IPY (2007-2009) there were 9 permanent broad-band seismic stations and small aperture arrays located on the Antarctic continent, which reported their data to IRIS (Incorporated Research Institutions for Seismology). Of these, only two closely spaced stations (SPA and QSPA at the South Pole) are located far away from the coast. The permanent station DRV at Dumont d'Urville (Terre d'Adélie) is part of the French Geoscope seismic network (INSU, Institut National des Sciences de l'Univers) and has been run by EOST/IPGS (École et Observatoire des Sciences de la Terre/ Institut de Physique du Globe de Strasbourg), in collaboration with the French Polar Institute IPEV (Institut Paul-Émile Victor), since 1986.

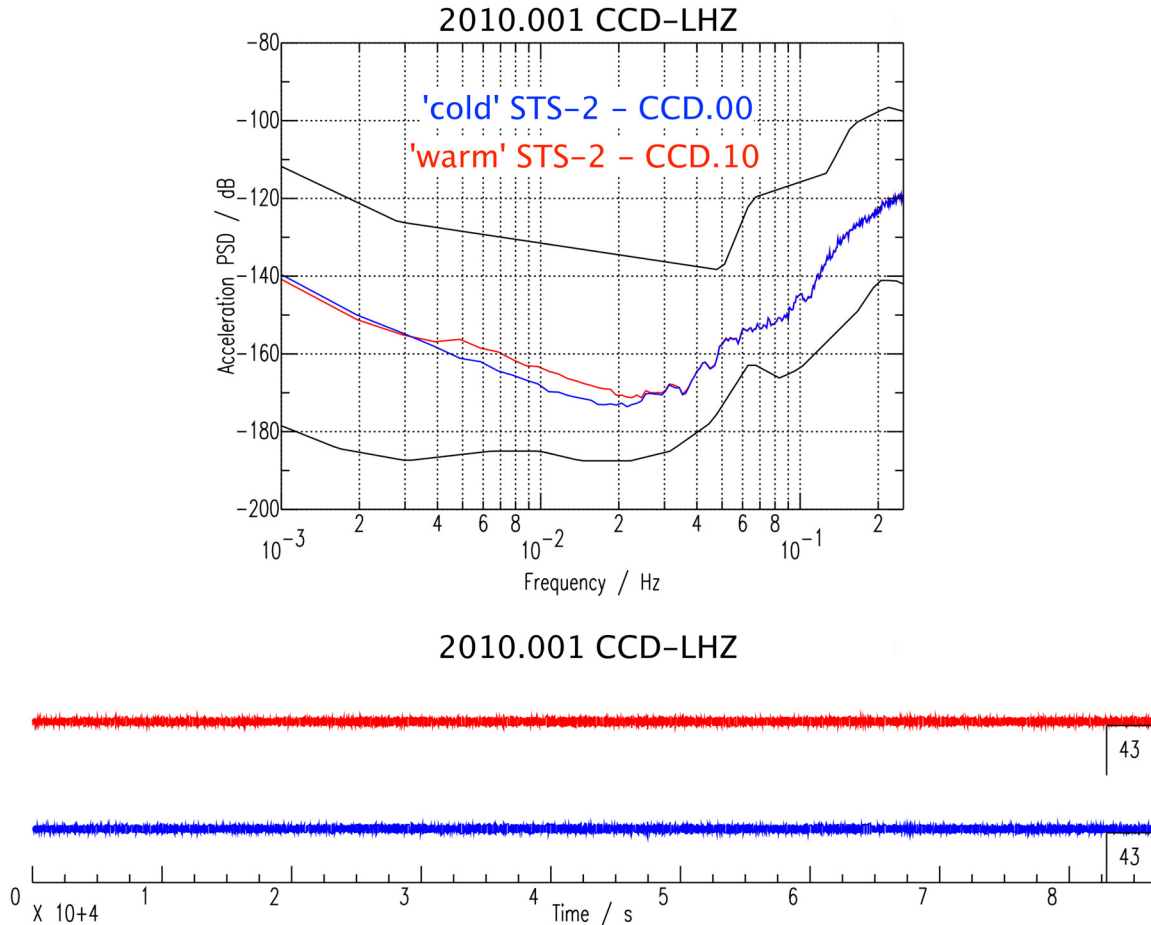

Figure 1. One-day power spectral density plot for CCD station (vertical component, 1sps data) on January 1st, 2010. Also shown are the seismograms for the same day. We run two parallel instruments at Dome-C to ensure redundancy. On January 1st, 2010, these were two STS-2 seismometers, one kept at ambient temperature (-54°C , blue lines, locid 00) recorded on a Quanterra Q330 digitizer, and one heated to -30°C (red lines, locid 10) recorded on a Quanterra Q4120.

Since 1998, EOST and INGV (Istituto Nazionale di Geofisica e Vulcanologia), in collaboration with the French and Italian polar agencies, have been running a project that aims to set up an experimental broad-band station at the French-Italian scientific base Concordia (Dome C). Concordia is ~ 1000 km inland from Dumont d’Urville, at 3250m elevation. The station has been recording continuously since December 2004 and has been a valuable test-bed for determining best practice in the installation of long running broad band seismic stations in the hostile conditions of the East Antarctic Plateau. The Concordia data were opened with station code CCD in 2007, and their quality reached a standard suitable for wider distribution two years later. The station soon after changed status from an experimental to a permanent station, and finally integrated the global Geoscope network in 2010 (see Figure 1 for a background noise PSD).

In the original proposal for CASE-IPY, we planned to deploy 10 broad-band seismometers in East Antarctica, using Concordia/ Dome C as our starting point (Figure 2a). Our preferred location for these stations

was between Concordia and AG01_camp (a temporary POLENET base). We had planned our deployment to be coordinated with those of our Italian, American and Australian colleagues (see map) in order to achieve maximum coverage of the East Antarctica Plateau, and to share a maximum of logistical support. Even with the modifications caused by logistical difficulties (see Figure 2b and discussion below), the final CASE-IPY deployment covered a part of East Antarctica that had never before been the subject of investigation, and was a fully functional seismic antenna in its own right. It completed and connected the American, Chinese and Japanese deployments, thereby helping to create a single, large-footprint seismic array which covered a substantial portion of the continent.

This combined POLENET East Antarctica network numbered some 55 stations, and had a combined length of over 4000 km, with a significant 2D component, providing unprecedented coverage of East Antarctica, and allowing us to attempt to reach the following objectives:

(1) Improve our knowledge of the regional crustal structure. Crustal thickness has been estimated from

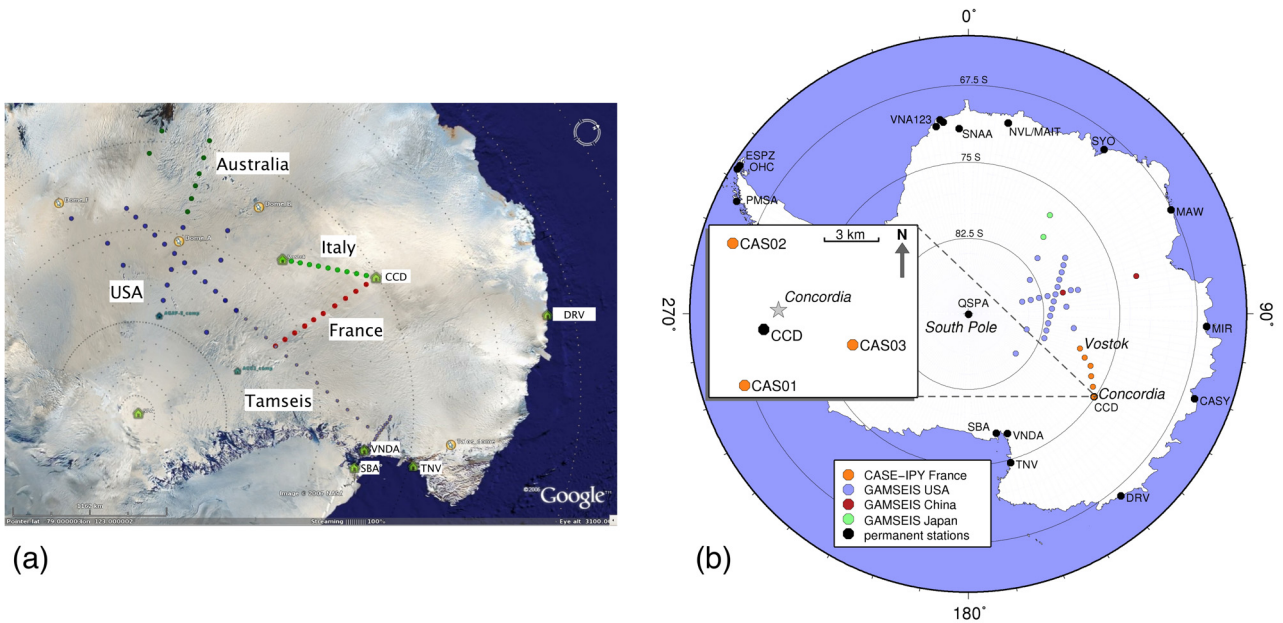

Figure 2. The East Antarctica IPY deployments. (a) As planned at the time of the submission of the funding application for the CASE-IPY experiment (February 2007). The earlier TAMSEIS deployment is also shown. (b) As deployed in the field at the time of the CASE-IPY deployment (2011).

Bouguer gravity anomalies derived from CHAMP satellite data, but has only been properly constrained at the permanent seismic stations and at a handful of sites of previous temporary deployments. East Antarctica is thought not to be a single undifferentiated craton, but to be constructed from several distinct lithospheric blocks. Crustal thickness measurements from the combined POLENET array will corroborate the existence of these multiple units, and will help to trace their boundaries. Retrieval of these boundaries is important for our comprehension of the formation and breakup of Gondwana.

(2) Improve our knowledge of the regional lithospheric structure. Global and regional surface wave tomography studies concord in describing East Antarctica as a region of predominantly fast, cold and thick lithosphere. The most recent regional models have started to provide evidence for coherent lateral variations in lithospheric structure. The combined POLENET array will use single station and multiple-station techniques to retrieve structural information from both earthquake data and ambient noise and to allow these lateral variations to be imaged at a much higher resolution than previously possible.

(3) Improve our sampling for inner core studies. A detailed analysis of the inner core anisotropy, whose fast axis is parallel to the Earth's rotation axis, requires seismic paths nearly parallel to this axis within a specific distance range (130 to 180 degrees). Deploying new stations in Antarctica for recording high northern latitude events will dramatically increase the number of available paths. They will also allow us to map inner core heterogeneities, which are the starting point for investigating inner core differential rotation. Waves reflected

or refracted at core's surface will also give insights into the properties of the core-mantle boundary.

2. Field operations

Field operations for CASE-IPY were made possible thanks to the logistical support provided by Institut Paul-Émile Victor (IPEV, <http://www.institutpolaire.fr/>), the French polar agency that provides partial funding and logistical support for all French-run polar experiments, and by Programma Nazionale Ricerche in Antartide (PNRA, <http://www.pnra.it/>), the equivalent Italian agency with whom IPEV jointly runs logistics out of Concordia base. The description of our field operations splits logically and chronologically into two phases: (1) design and field tests of autonomous seismic stations (2007-2009); (2) instrument deployment (2010-2011). Data and instrument recovery from the stations deployed between Concordia and Vostok took place in December 2011, and data were received in March 2012.

2.1. Instrument design and testing

The International Polar Year provided an important impetus towards the design of autonomous seismic stations able to withstand the rigorous conditions of the Antarctic plateau, specifically 4-6 months of complete darkness and temperatures that descend to -80°C in winter. The leader in the field is undoubtedly IRIS-PASSCAL (<http://www.passcal.nmt.edu/content/polar>) who together with UNAVCO (<http://www.unavco.org/>) received substantial funding from the National Science Foundation (<http://www.nsf.gov/>) to design power and transmission systems to be deployed on remote sites during the IPY.

The IRIS-PASSCAL solution for year-round operation is the following (see <http://www.passcal.nmt.edu/content/polar/equipment/year-round-1> for details): a cold-rated Guralp CMG-3T or a Nanometrics Trillium 240 seismometer, recorded by a Quanterra Q330 digital acquisition system, and powered by primary, single use, Lithium Thionyl Chloride batteries alone or in combination with more traditional rechargeable batteries and solar panels during the summer months (see <http://www.passcal.nmt.edu/content/polar/equipment/year-round/batteries> for a more complete discussion on battery systems). This solution was deployed with success on many POLENET stations, including those installed for the Gamburtsev Antarctic Mountains Seismic Experiment (GAMSEIS, <http://epsc.wustl.edu/seismology/GAMSEIS/>) in East Antarctica, in environmental conditions similar to those of the CASE-IPY deployment. Unfortunately, due to the high cost of the cold-rated primary battery packs and strict funding constraints, we were unable to reproduce the complete IRIS-PASSCAL year round solution, and opted for the less expensive solution of summer operation only.

We designed our first prototype CASE-IPY autonomous seismic stations (Figure 3) by combining our previous experience acquired during preliminary testing of the observatory station at Concordia, with design information graciously provided by IRIS-PASSCAL. We opted at first for a three-box system: the first containing the seismometer (see below for details about the differ-

ent seismometers tested); the second containing the digital acquisition system (Reftek RT-130, <http://www.reftek.com/products/seismic-recorders-130-01.htm>), a radio (Afar pulsAR, <http://www.afar.net/wireless/ether-net-bridge/>), a power controller (MorningStar SunSaver-10L, <http://www.morningstarcorp.com/en/sun-saver>) and a single 60Ah gel-acid battery (Hawker, <http://www.batterier.no/station/Hawker/SBS.pdf>); and the third containing a stock of 9 further batteries, intended to provide backup power for as long as possible into the Antarctic winter. The two latter boxes were heated by simple 2.5W resistance heaters, in order to keep the acquisition system within its standard operating temperatures, and to avoid too much reduction in battery capacity due to the extreme cold. The three boxes were buried under the snow at 1-1.5-m depth. Solar power was generated by three 85W solar panels (Photowatt, <http://www.photowatt.com/>), of which one was dedicated to the data-acquisition box, and the two others to the box containing the backup batteries. The panels were fitted to a single triangular mast (see Figure 4a), which also supported the radio and GPS antennas, a connector for the Palm interface to the Reftek, and an interface for measuring solar panel power and internal temperature of the two heated boxes.

We chose the 6-channel versions of the Reftek RT-130 acquisition systems, with the capability of sending re-centering signals to the seismometers, and used the programmable re-centering signal to trigger powering

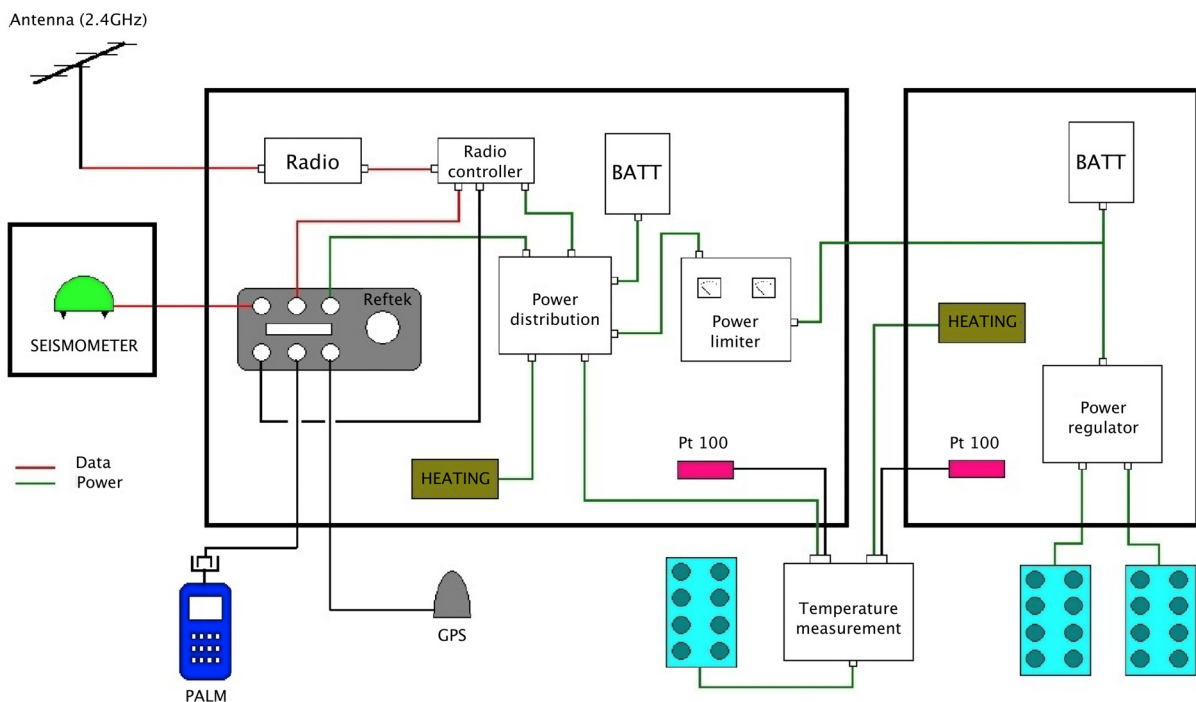
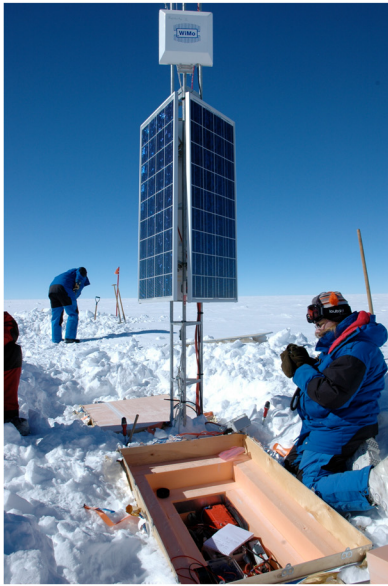
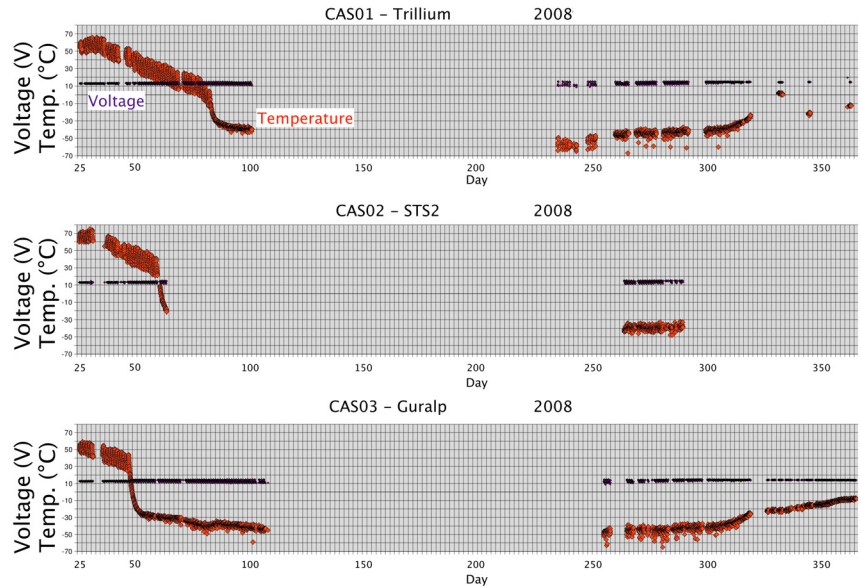

Figure 3. Design of the first prototypes of the CASE-IPY autonomous seismic stations (3-box design with radio transmission to Concordia base). Heating and radio transmission were removed, and the acquisition (Reftek box) and battery (BATT) boxes were merged for the final design.



(a)



(b)

Figure 4. Tests of the prototype CASE stations. (a) Field deployment (the acquisition box is open, the battery box is visible behind the mast, and the position of the buried seismometer is indicated by the flag in the background). (b) Radio transmitted SOH (state of health) information for 2008 for the three stations CAS01, CAS02, CAS03 with three different seismometers (quoted after the station code), showing that the stations shut down in winter and power up again in spring: temperature of the acquisition box as measured by the RT-130 (red), battery voltage (blue). The sharp drop in temperature occurs when there is insufficient solar energy to power the heating.

up of the radio for daily transmission to Concordia of state-of-health (SOH) information and 1sps data for quality control (10 minutes of radio link were required to ensure transmission of 1-day data). Figure 4b shows the SOH for 2008.

In January 2008, three prototype stations constructed according to this design, each with a different seismometer, were deployed at five kilometers from Concordia base, forming a triangle around the observatory station CCD (see inset in Figure 2b and Table 1). The seismometers tested were a Nanometrics Trillium 120P with manual re-centering (<http://www.nanometrics.ca/products/trillium-120-ppa>), a Streckeisen STS-2 (<http://www.passcal.nmt.edu/content/instrumentation/sensors/broadband-sensors/sts-2-bb-sensor>) and a Guralp CMG-40T with 60s response (<http://www.guralp.com/products/40T/>). The seismometers were installed on rigid plates of different materials (glass, polymer, granite) that were placed firmly on the snow, but not sealed in place. Examples of 2008 data from the three seismometers are shown in Figure 5. It was on the basis of

the radio-transmitted SOH and quality control 1sps data, sent by email from Concordia base to our offices in Strasbourg, that we planned modifications to be applied to the prototype in order to build the stations for the full CASE-IPY field deployment.

We learned several lessons about the station design from the first year's deployment:

(1) Active GPS receivers (i.e. GPS receivers in which the electronics and the antenna are housed in an external module) are very sensitive to the buildup of static electricity, which is common on the Antarctic plateau because of its extremely dry air. Two of the three GPS modules failed during the winter because of this, making the spring and summer data difficult to exploit as timing information was compromised (in Figure 5, the earthquake recorded on CAS01 and CAS03 appears to have occurred at significantly different times). We solved this problem by putting the GPS receivers inside the acquisition boxes, as near to the top as possible. As our boxes are made of thin wood with foam insulation, and are buried under only 20-30 cm of snow,

Station	Latitude S	Longitude E	Seismometer (2008)	Seismometer (2010-2011)
CAS01	75° 08.041'	123° 16.085'	Nanometrics T120P	Nanometrics T120P
CAS02	75° 03.845'	123° 14.748'	Streckeisen STS-2	Nanometrics T120PA
CAS03	75° 06.841'	123° 28.532'	Guralp CMG-40T	Lennartz 5s

Table 1. Prototype CASE station locations and seismometer types.

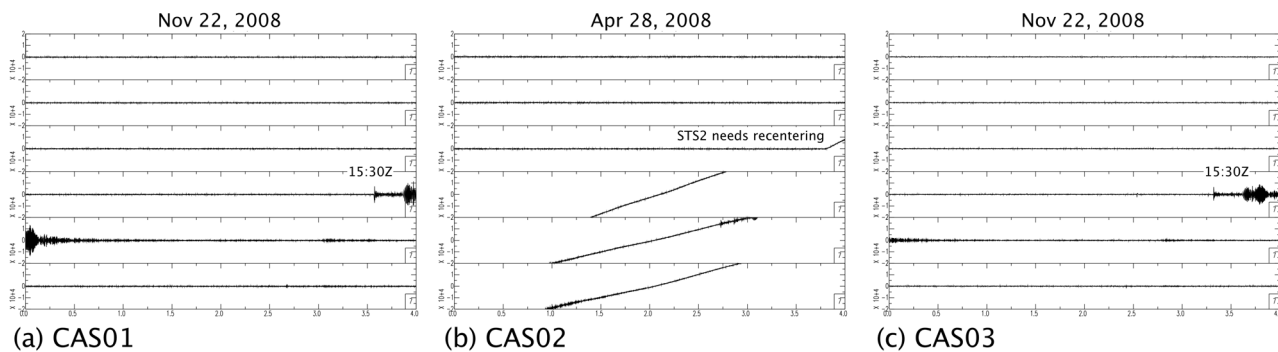

Figure 5. Examples of 2008 data from the prototype stations. Each panel shows one day of data, split into six 4-hour segments. At CAS02 (b), the STS-2 seismometer has drifted too far of center, causing the trend in the data (the mean of each segment is removed from the data before plotting). Panels (a) and (c) show the same event, but given the failure of the GPS units during the first winter (see text) the apparent timing is significantly different between the stations.

the GPS signal is still excellent with this configuration.

(2) Although the configuration of 3 solar panels on a single triangular mast makes for simpler field installation, the loss of solar power in fall and spring is too great. We opted to change this design to one in which the three panels are installed in-line facing north.

(3) Heating the acquisition and battery boxes was found to be unnecessary. As Figure 4b shows, the heating failed early in the year at CAS03, yet this station ran the longest during the Antarctic winter. We concluded that the self-heating of the power regulators and the data acquisition system, combined with the insulation of our boxes and that provided by the snow, were sufficient to guarantee operability of the station. Furthermore, by removing the heating, we greatly reduced the daily temperature variations within the boxes, which have a small but measurable effect on the recorded data.

(4) Field installation of a three-box system proved to be a difficult operation. No radios were planned for the remote stations, as they would be too far from Concordia and from each other to permit SOH or data transmission, therefore when re-designing the stations for the full field deployment, we preferred to combine the acquisition and the battery boxes into a single box.

(5) Although we had worried about tilt caused by movements of the bases on which the seismometers were installed, the mass-positions recorded during the first year's operation showed this tilt to be negligible compared to the temperature-induced mass drifts. We chose the granite base for ease of procurement.

Of the three seismometers, we initially chose the CMG-40T for the full field deployment. Although a less sensitive seismometer, it was also less sensitive to temperature induced drift, and was the only one of the three instruments not to drift off-center in late fall. The two other instruments could have been used together with an automated re-centering solution. However, the re-centering solution for the Trillium 120 had not yet

been finalized, and several years worth of experience with the STS-2 at the permanent station at Concordia (CCD) had taught us that below -30°C , it could take several attempts before STS-2 re-centering was effective, which made us uneasy about counting on this procedure in the field in autonomous operation. The option of using the Trillium 240 as suggested by IRIS-PASSCAL was ruled out as too expensive.

A full set of built-to-order CMG-40s were shipped to Antarctica, and tested at Concordia during the 2008-2009 summer campaign. Unfortunately, they were found to be defective at temperatures below -20°C , and were therefore shipped back to the manufacturer for repair. We replaced them the following year by a new generation of Trillium 120PA with automated re-centering, which we had validated by testing them at -70°C in a new cold test-bed freezer at the Astronomical Observatory of Nice, France. One of the new instruments was installed at site CAS02 in January 2010. Figure 6a shows the 2011 SOH radio-transmitted data for the prototype stations, and Figure 6b shows radio-transmitted data for CAS02, on which the M6.9 Sikkim (India) event of September 18, 2011, is visible. This station is nearly identical to those of the full deployment between Concordia and Vostok, and the data quality makes us hopeful about the results that will be obtainable with the data from the full deployment.

2.2. Instrument deployment

The original CASE-IPY plans (Figure 2a) called for 10 autonomous stations to be installed south of Concordia, terminating in a site that had already been used as a TAMSEIS (TransAntarctic Mountains Seismic Experiment, 2001-2003, <http://epsc.wustl.edu/seismology/TAMSEIS/>) site. The Concordia-Vostok deployment was to be performed by our Italian colleagues at INGV. Between submission of our project and actual field installation, a number of changes were made to the deployment plans:

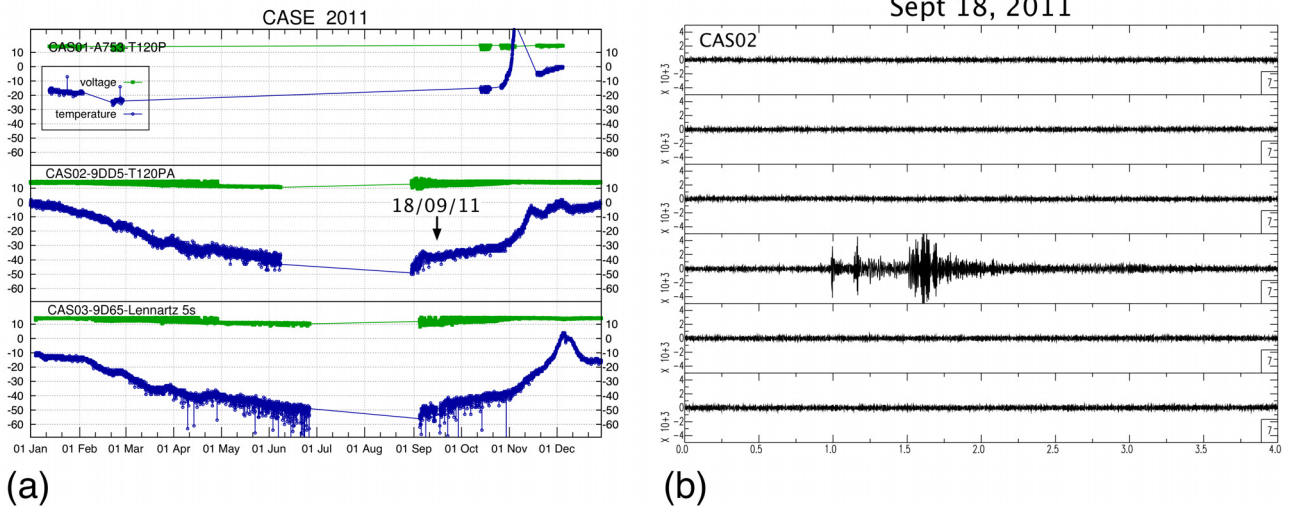

Figure 6. (a) 2011 SOH (state of health, temperature in blue, battery voltage in black), and (b) data example for the second-generation prototype CASE stations. Stations CAS02 and CAS03 worked longer into the winter than in 2008 (see Figure 4b), validating the decision to install the three solar panels in-line and facing North. Data-acquisition for CAS01 was unstable. The data for CAS02 shortly after the station powered-up are of good quality, indicating that the instrument (a Trillium 120PA with automated recentering) was functioning correctly.

(1) Italy started traversing serious economic difficulties, which resulted in no funds being made available for IPY experiments. Our colleagues at INGV were therefore unable to purchase and ship their instruments, leaving the Concordia-Vostok line uncovered. As it was much easier for IPEV and PNRA to provide logistical support along Concordia-Vostok profile than south from Concordia (Vostok base has an air-strip and a considerable stock of fuel), we rapidly switched the location of our deployment.

(2) We had early on reduced the number of stations along the Concordia-Vostok profile to 7, to reduce the logistical weight of the deployment. The extra cost incurred by the switch in choice of seismometer from the CMG-40 to the more expensive Trillium 120PA forced us to reduce this number to 5.

(3) Our profile lay very close to the ice-divide line running between Concordia and Vostok bases, a line that was the target of the French glaciology IPY experiment VANISH (Vulnerability of the ANtarctic Ice Sheet and its atmosphere), part of the international TASTE-IDEA program (Trans-Antarctic Scientific Traverses Expeditions - Ice Divide of East Antarctica). In order to maximize the sharing of logistics between our two experiments, we modified the locations of our profile stations to bring them closer to the ice-divide line (Figure 2b).

Four out of the five stations were deployed in January 2010, using Twin Otter aircraft. The last station (CAS05) was similarly deployed in January 2011. Station locations are given in Table 2.

The full weight of each station was 450 kg, including 200 kg of gel-acid batteries and 90 kg of installation equipment (reused for each deployment). A schematic

Station	Latitude S	Longitude E
CAS04	75° 42.966'	120° 13.545'
CAS05	76° 20.819'	116° 58.060'
CAS06	76° 50.458'	112° 59.203'
CAS07	77° 40.673'	110° 32.976'
CAS08	78° 24.537'	107° 07.187'

Table 2. Locations of profile CASE-IPY stations.

diagram of the installation configuration is shown in Figure 7, and photographs of station preparation and installation are shown in Figure 8. Each deployment took approximately 3.5 hours (excluding flight time), was performed by a four-person team, and involved digging out and replacing approximately 6 cubic meters of snow.

Taking off and landing on un-prepared, relatively rough terrain such as the Antarctic plateau requires favorable meteorological conditions: perfect visibility combined with moderate wind (between 10 and 25 knots) in order to provide sufficient lift and enable short takeoff and landing runs. These conditions occurred only four times during our 2010 flight window, thereby forcing us to postpone deployment of the fifth station to 2011.

In January 2011, we were also able to visit one of the profile stations, CAS04, and found it had stopped functioning on April 25, 2010. The culprit was found to be the Reftek RT-130 data acquisition system. The system was replaced by a spare, and the station started running again on January 15, 2011. The acquisition systems installed at the profile stations were of the same make as those of the prototype stations (none of which had failed), but

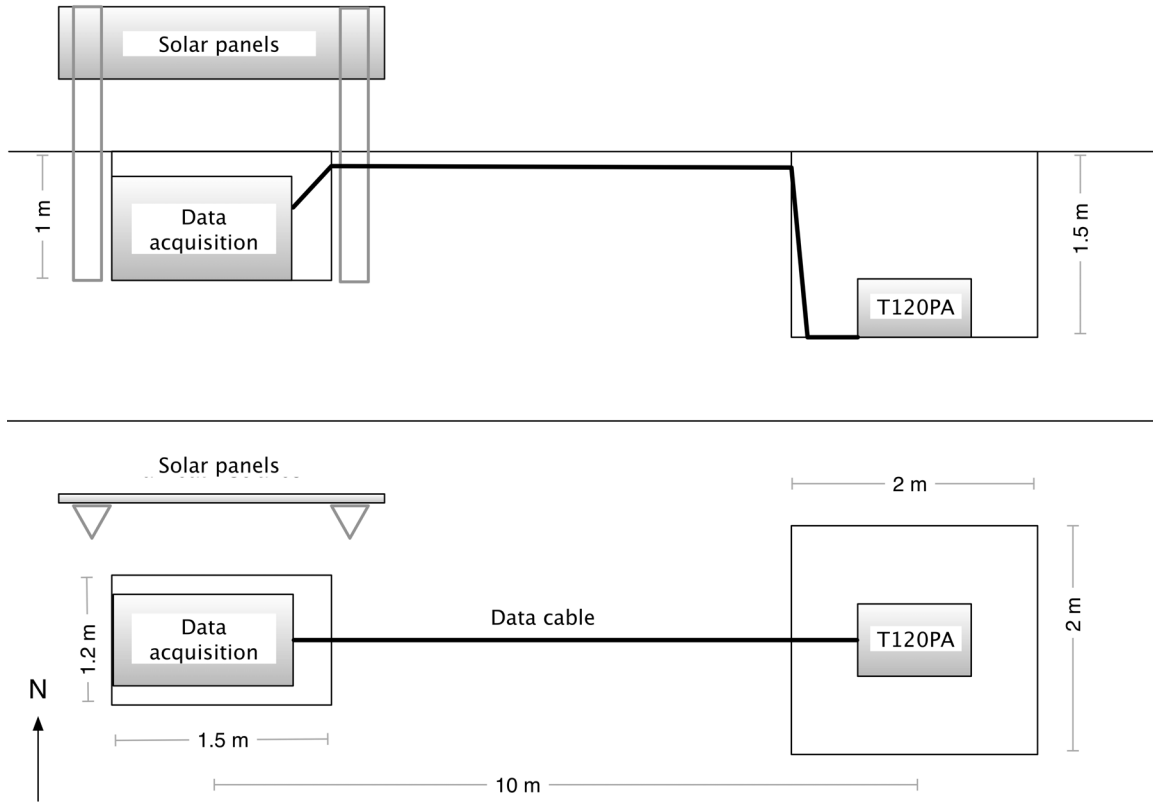

Figure 7. Installation configuration for the CASE-IPY profile stations, indicating the orientation and relative positions of the different components (top: side view; bottom: view from above).

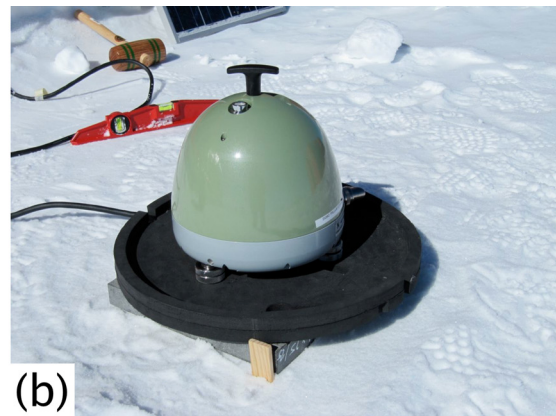
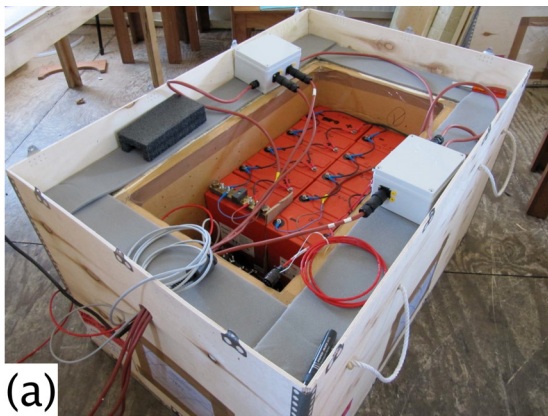

Figure 8. Deployment of the CASE-IPY profile stations. (a) Pre-installation test of the data acquisition box. (b) Pre-deployment test of the Trillium 120PA seismometer. (c) Field deployment with Twin Otter. (d) Seismometer in field pit before the installation of the protective box.

were from a different production lot. We hoped the fault on the system at CAS04 had been an isolated incident, but after recovery of all the remote stations in December 2011, we discovered the same fault on all the Reftek's. We were therefore only able to recover three months of data for each remote site, and twice that amount for CAS04. Analysis of these data started in April 2012, shortly after they were received in Strasbourg.

3. Current knowledge of the structure of East Antarctica

The discussion of our scientific results will be limited to preliminary results obtained using data from the prototype CASE stations, data from the observatory station CCD or publicly available data from other stations in Antarctica. We shall briefly discuss three research topics, using our own results where possible, and exploiting recent results from various IPY research groups: seismological constraints on the structure of the snow and ice; the influence of the ice-sheet on estimates of crustal thickness, and crustal structure of East Antarctica; lithospheric structure of the Antarctic as seen by surface wave tomography.

3.1. Seismic structure of snow and ice

We have exploited the ambient noise seismic signal recorded at CCD and the prototype CASE stations CAS01, CAS02, CAS03 in order to determine the seismic properties of the snow and ice beneath them [L  v  que et al. 2010]. We applied a method based on the spectral ratio of the horizontal and vertical ground motions

(H/V), commonly used to analyze soil response in seismic regions for seismic risk evaluation [Field and Jacob 1995], and which to our knowledge had never before been used to infer the snow and ice response. Figure 9a shows the H/V ratio spectra obtained from the four stations at Concordia station, Dome C, and shows that the main peak in the spectral ratios is observed at 6.7-8 Hz. This peak can be preferentially explained by a 23-m thick layer of unconsolidated snow with an S-wave velocity of 0.7 km/s, overlying a layer of consolidated snow with a faster S-wave velocity of 1.8 km/s (Model 1 in Figure 9b). Although other physical models may fit the same spectral data (e.g. Model 2 in Figure 9b), our preference for the first model is based on the fact that the depth of the velocity contrast coincides with the density at which ice particles arrange themselves in a continuous, dense lattice. The slight variations in the H/V ratios between the four Concordia stations indicate a small variability in the snow and ice structure around Dome C. These results indicate that it might be worthwhile to upgrade the CCD observatory station by adding a borehole seismometer at a depth greater than 20 m, thereby taking advantage of the more consolidated snow at that depth.

The seismic data from the broad-band stations located on the East Antarctic and Greenland ice sheets have recently been used to determine the large-scale seismic parameters of the polar ice sheets [Wittlinger and Farra 2012]. The authors used the P-to-S converted waves at the ice-rock interface, those converted at interfaces inside the ice sheets and their multiples (the P receiver functions) to

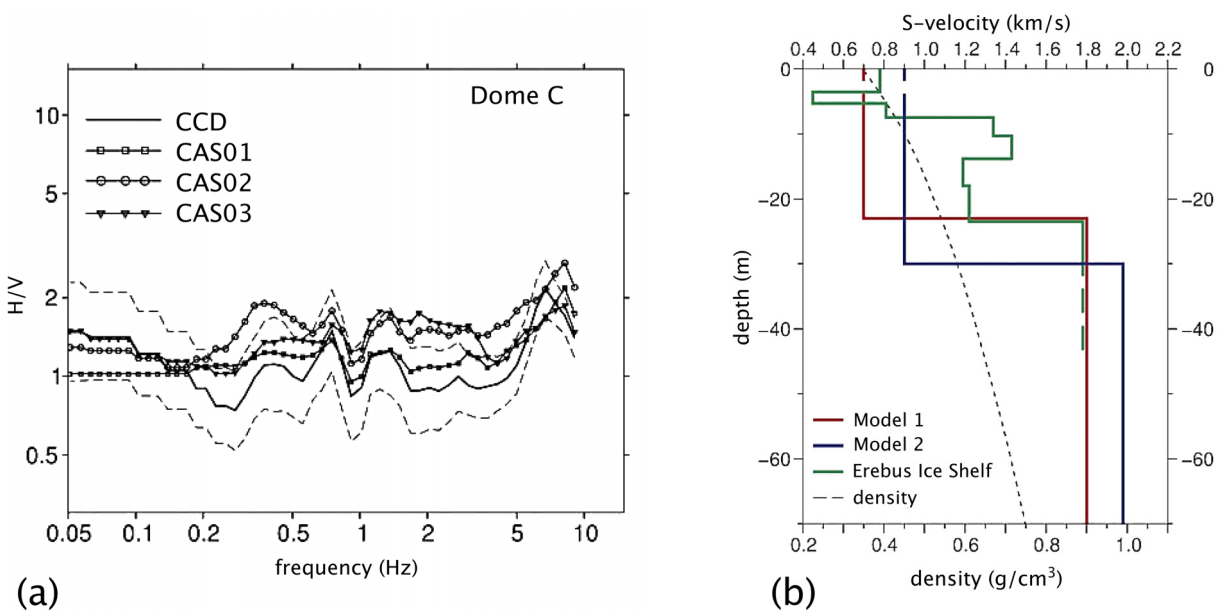

Figure 9. Snow structure at Dome C (after L  v  que et al. [2010]). (a) Mean spectral ratios of horizontal to vertical motion determined from noise at the four Dome C stations. The 1-sigma confidence level is similar for the different curves, and is shown for CCD only (dashed line). (b) S-wave velocity models. Model 1 is preferred, as it is the most compatible with the density profile at Concordia (L. Arnaud, personal communication 2010).

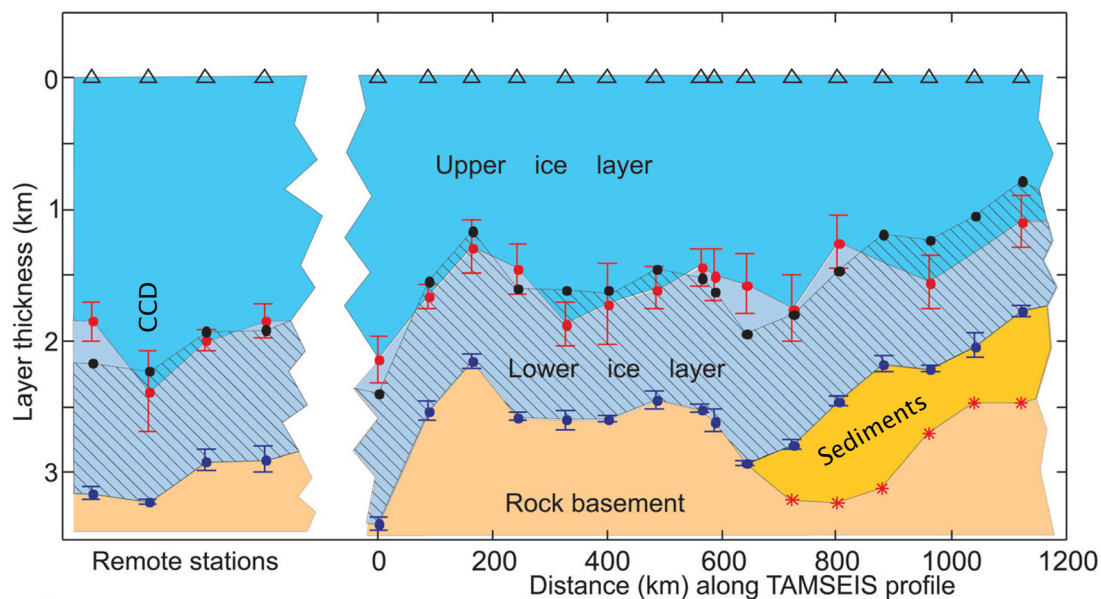

Figure 10. Two-layer ice structure in East Antarctica and Greenland from P-wave receiver functions (after Wittlinger and Farra [2012]). The hatched area has a constant thickness equal to the mean thickness of the lower layer. Remote stations (left) are from left to right: SUMG (Greenland), CCD (Concordia), QSPA (South Pole) and P061 (a Polenet station, see Figure 11a). Other stations are from the TAMSEIS experiment (N132-N020).

estimate the P-wave velocity V_p and the P-to-S velocity ratio V_p/V_s of polar ice. The thickness of the whole ice layer was precisely known either from radio echo soundings or from ice core drillings allowing an accurate determination of V_p and V_p/V_s . At some places in and near the Wilkes Basin, a sedimentary layer is probably squeezed between the ice and the bedrock. They find that the polar ice caps have a two-layer structure (Figure 10): the upper layer is of variable thickness (about $2/3$ of the total thickness at the site of each station) with velocities very close to the standard values for ice; the lower layer has more or less constant thickness, a standard value for V_p but a value for V_s that is only about 75% of the standard value. The authors suggest that the shear-velocity drop in the lower layer may be evidence of strong anisotropy induced by preferred orientation of ice crystals and by fine layering of soft and hard ice layers. They therefore expect a large variation of ice viscosity with depth, which implies heterogeneous flowing of the polar ice sheet. This heterogeneous flowing may invalidate the use at great depth of the ice dating models based on monotonic layer thinning.

3.2. The influence of the ice-sheet on estimates of crustal thickness, and crustal structure of East Antarctica

The main reason why the geological structure of East Antarctica is still relatively unknown, and why such an impetus was given to seismological research in this region during the IPY, is the fact that the whole region is almost entirely covered by an ice sheet with an average thickness of 3 km. Seismological observations are

therefore essential, in combination with aerial geophysical surveys, to constrain its crustal structure. However, as the thick layer of ice has a much lower seismic velocity than the underlying crust, it tends to trap seismic energy that then reverberates strongly within it, and can lead to mis-interpretation and incorrect estimates of crustal thickness in P-to-S receiver function studies [e.g. Lawrence et al. 2006a]. If the ice thickness is known either from radio echo soundings or from ice core drilling, it is possible to predict the ice reverberations and remove them from the P-to-S receiver functions [Cho 2011], but only if a single ice-layer is a reasonable approximation. As we have seen above, the ice structure seems to be two-layered in East Antarctica, which implies that the properties of both layers should be taken into account in modeling the ice-reverberations.

A way to avoid the ice-reverberations altogether is to analyze S-to-P receiver functions, that isolate the S to P converted waves, as these arrive before the direct S phase, while the ice reverberations arrive later. Hansen et al. [2010] use such an analysis, incorporating also Rayleigh wave phase velocities from surface wave tomography, to map the crustal thickness in the Gamburtsev mountains region of East Antarctica, bringing to light the existence of a deep crustal root (Figure 11).

3.3. Lithospheric structure of the Antarctic

The lithosphere of East Antarctica is largely cratonic in nature. Determination of the seismic structure at the base of the Antarctic craton would help to corroborate and clarify the link between plate dynamics and lithospheric structure. East Antarctica ap-

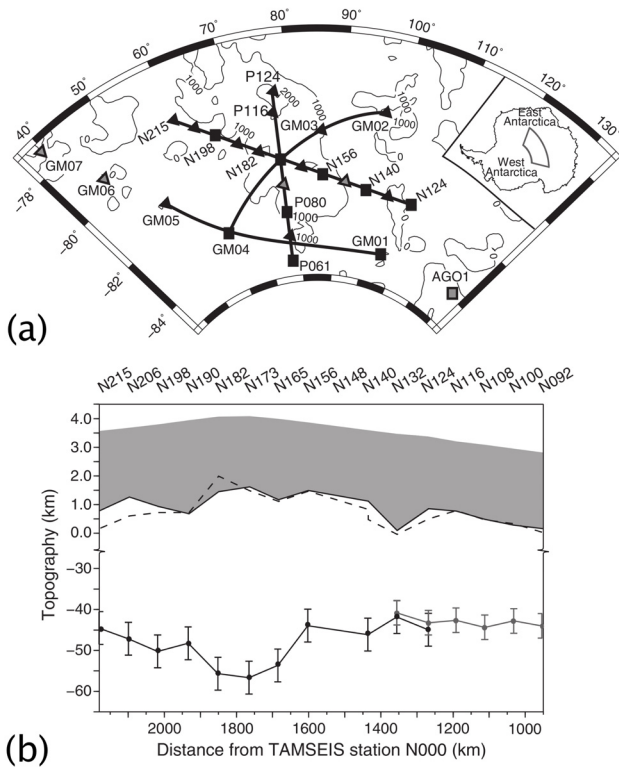

Figure 11. Crustal structure of East Antarctica (after Hansen et al. [2011]). (a) TAMSEIS (N215 to N124), and GAMSEIS stations. (b) Crustal structure derived from joint inversion of S-wave receiver functions and Rayleigh wave dispersion curves.

appears as a region with fast seismic velocities in both global and regional surface wave tomography studies [Debayle et al. 2005].

Figure 12a shows a tomographic image of the S-wave velocities at 100 km depth obtained before the

IPY [Sieminski et al. 2003]. The lateral resolution of this study can be estimated to be ~ 600 km. Even with this limited resolution, the lithospheric structure of the craton seems to be inhomogeneous throughout East Antarctica. Short wavelength lateral variations in the lithospheric structure of East Antarctica have been locally imaged by the TAMSEIS experiment [Lawrence et al. 2006b]. S-wave vertical multipaths through the mantle from permanent stations and the prototype CASE stations have also revealed inhomogeneity in wave attenuation [Souriau et al. 2012]. The full POLENET network deployed for the IPY should permit to improve the lateral resolution of regional tomographies. This is illustrated in Figure 12b, which shows a preliminary surface wave study using all currently available seismic data from Antarctica, including data from CCD and the IPY deployments [An et al. 2011].

4. Conclusion

CASE-IPY, the French contribution to the seismological component of the POLENET IPY initiative, has involved the deployment of five autonomous seismic stations between the Antarctic bases of Concordia and Vostok. The station design matured over two years of prototype testing *in situ* at Concordia before the full deployment took place in 2010 and 2011. We received the data from these stations in early 2012.

The IPY has permitted a vast amount of research into the seismic structure of East Antarctica, thanks to the great number of stations deployed by all the IPY partners, in addition to the permanent observatories. Although the results of scientific analyses using the data

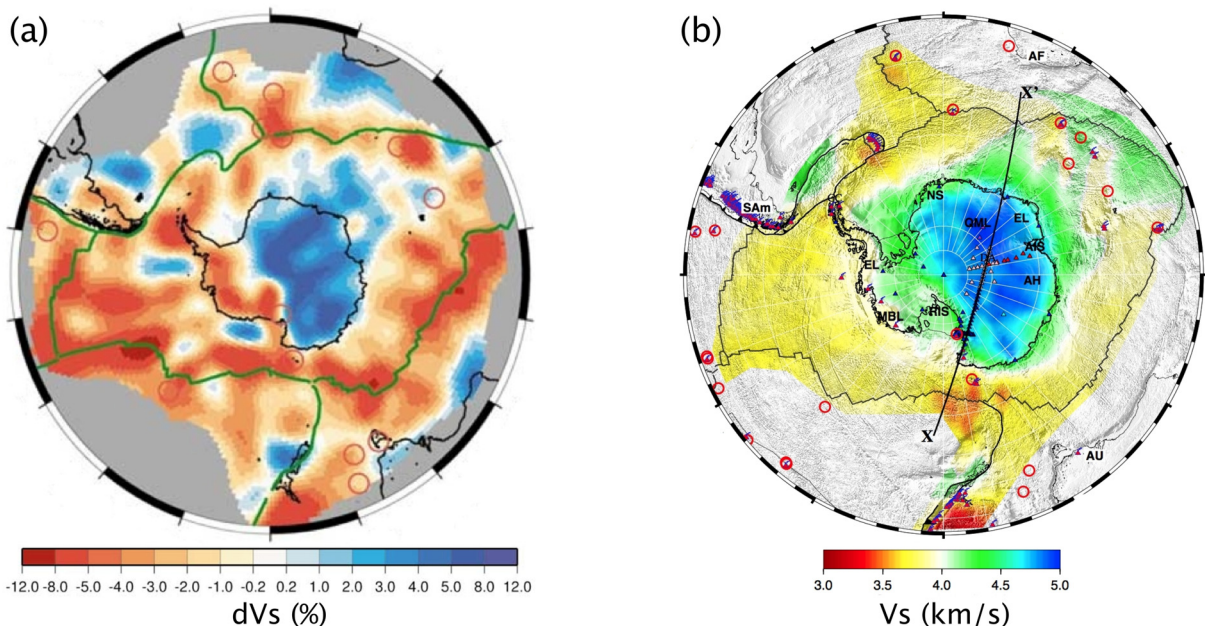

Figure 12. Surface wave tomographic maps of Antarctica at 100-km depth. (a) Results from permanent stations only (after Sieminski et al. [2003]). (b) Preliminary results using permanent and POLENET stations (after An et al. [2011]).

from these stations have only recently started to be published, it seems likely that we shall soon see a large volume of work being performed on these new data.

Acknowledgements. The CASE-IPY project was directly supported by ANR through the ANR-07-BLAN-0147 contract. Logistical support for the CASE-IPY project was provided by IPEV and PNRA. The permanent station CCD at Concordia is supported by the French Polar Institute (IPEV) under program No 906, and by GEOSCOPE.

References

- An, M., et al. (2011). 3D Lithosphere Model of Antarctica from Surface Wave Observations, ISAES, Edinburg.
- Cho, T. (2011). Removing Reverberation in Ice Sheets from Receiver Functions, *Seismological Research Letters*, 82 (2), 207-210.
- Debayle, E., B.L.N. Kennett and K. Priestley (2005). Global azimuthal seismic anisotropy and the unique plate-motion deformation of Australia, *Nature*, 433, 509-512.
- Field, E., and K. Jacob (1995). A comparison and test of various site-response estimation techniques, including three that are not reference-site dependent, *Bulletin of the Seismological Society of America*, 85 (4), 1127-1143.
- Hansen, S.E., A.A. Nyblade, D.S. Heeszel, D.A. Wiens, P. Shore and M. Kanao (2010). Crustal structure of the Gamburtsev Mountains, East Antarctica, from S-wave receiver functions and Rayleigh wave phase velocities, *Earth and Planetary Science Letters*, 300, 395-401.
- Lawrence, J.F., D.A. Wiens, A.A. Nyblade, S. Anandkrishnan, P.J. Shore and D. Voigt (2006a). Crust and upper mantle structure of the Transantarctic Mountains and surrounding regions from receiver functions, surface waves, and gravity: Implications for uplift models, *Geochemistry Geophysics Geosystems*, Q10011; doi:10.1029/2006GC001282.
- Lawrence, J.F., D.A. Wiens, A.A. Nyblade, S. Anandkrishnan, P.J. Shore and D. Voigt (2006b). Rayleigh wave phase velocity analysis of the Ross Sea, Transantarctic Mountains, and East Antarctica from a temporary seismograph array, *Journal of Geophysical Research-Solid Earth*, B06302; doi:10.1029/2005JB003812.
- Lévêque, J.-J., A. Maggi and A. Souriau (2010). Seismological constraints on ice properties at Dome C, Antarctica, from horizontal to vertical spectral ratios, *Antarctic Science*, 22 (5), 572-579; doi:10.1017/S0954102010000325.
- Sieminski, A., E. Debayle and J.-J. Lévêque (2003). Seismic evidence for deep low-velocity anomalies in the transition zone beneath West Antarctica, *Earth and Planetary Science Letters*, 216, 645-661.
- Souriau, A., L. Rivera, A. Maggi and J.-J. Lévêque (2012). Seismic attenuation in the eastern Australian and Antarctic plates, from multiple ScS waves: *Geophysical Journal International*, 190, 569-579; doi:10.1111/j.1365-246X.2012.05501.
- Wittlinger, G., and V. Farra (2012). Observation of low shear wave velocity at the base of the polar ice sheets: evidence for enhanced anisotropy, *Geophysical Journal International*, 190, 391-405.

*Corresponding author: Alessia Maggi,
Institut de Physique du Globe de Strasbourg (IPGS),
Strasbourg, France; email: alessia.maggi@unistra.fr.