



HAL
open science

The *Leishmania donovani* chaperone cyclophilin 40 is essential for intracellular infection independent of its stage-specific phosphorylation status.

Wai-Lok Yau, Pascale Pescher, Andrea Macdonald, Sonia Hem, Dorothea Zander, Silke Retzlaff, Thierry Blisnick, Brice Rotureau, Heidi Rosenqvist, Martin Wiese, et al.

► To cite this version:

Wai-Lok Yau, Pascale Pescher, Andrea Macdonald, Sonia Hem, Dorothea Zander, et al.. The *Leishmania donovani* chaperone cyclophilin 40 is essential for intracellular infection independent of its stage-specific phosphorylation status.. *Molecular Microbiology*, 2014, 93 (1), pp.80-97. <10.1111/mmi.12639>. <hal-01054664>

HAL Id: hal-01054664

<https://hal.science/hal-01054664v1>

Submitted on 13 Feb 2019

HAL is a multi-disciplinary open access archive for the deposit and dissemination of scientific research documents, whether they are published or not. The documents may come from teaching and research institutions in France or abroad, or from public or private research centers.

L'archive ouverte pluridisciplinaire HAL, est destinée au dépôt et à la diffusion de documents scientifiques de niveau recherche, publiés ou non, émanant des établissements d'enseignement et de recherche français ou étrangers, des laboratoires publics ou privés.



Distributed under a Creative Commons CC BY 4.0 - Attribution - International License

1 **The *Leishmania donovani* chaperone cyclophilin 40 is essential for intracellular infection**
2 **independent of its stage-specific phosphorylation status**

3 Wai-Lok Yau^{1,2}, Pascale Pescher¹, Andrea MacDonald², Sonia Hem³, Dorothea Zander², Silke
4 Retzlaff^{3,+}, Thierry Blisnick⁴, Brice Rotureau⁴, Heidi Rosenqvist^{5,++}, Martin Wiese⁵, Philippe
5 Bastin⁴, Joachim Clos², and Gerald F. Späth^{1,*}

6
7 Institut Pasteur and Centre National de la Recherche Scientifique URA 2581, ¹Unité de
8 Parasitologie Moléculaire et Signalisation, and ⁴Unité de Biologie Cellulaire des Trypanosomes,
9 25 rue du Dr Roux, F-75015 Paris, France; ²Clos Group (Leishmaniasis) and ³Electron
10 Microscopy Service, Bernhard-Nocht-Institut für Tropenmedizin, Bernhard-Nocht-Str. 74, D-
11 20359 Hamburg, Germany; ³Plate-forme de spectrométrie de masse protéomique - MSPP,
12 Biochimie et Physiologie Moléculaire des Plantes, UMR 5004 CNRS/UMR 0386
13 INRA/Montpellier SupArgo/Université Montpellier II, F-34060 Montpellier, France;
14 ⁵Strathclyde Institute of Pharmacy and Biomedical Sciences, University of Strathclyde,
15 Glasgow, Scotland, UK

16

17 * Correspondence: Gerald Späth

18 Institut Pasteur, 25 rue du Dr Roux, 75015 Paris, France

19 Phone: +33.1.40.61.38.58; Fax: +33.1.45.68.83.33

20 E-mail: gerald.spaeth@pasteur.fr

21 Short title: LdCyP40 null mutant analysis

22 Key words: *Leishmania donovani*, stress protein, cyclophilin 40, null mutant analysis,
23 intracellular survival, chaperone phosphorylation

24 +current address: Altona Diagnostics, Moerkenstr. 12, 22767 Hamburg, Germany

25 ++current address: Novo Nordisk, Novo Nordisk Park 1, DK-2760 Maaloev, Denmark

26 **Summary**

27 During its life cycle, the protozoan pathogen *Leishmania donovani* is exposed to contrasting
28 environments inside insect vector and vertebrate host, to which the parasite must adapt for
29 extra- and intracellular survival. Combining null mutant analysis with phosphorylation site-
30 specific mutagenesis and functional complementation we genetically tested the requirement of
31 the *Leishmania donovani* chaperone cyclophilin 40 (LdCyP40) for infection. Targeted
32 replacement of LdCyP40 had no effect on parasite viability, axenic amastigote differentiation,
33 and resistance to various forms of environmental stress in culture, suggesting important
34 functional redundancy to other parasite chaperones. However, ultra-structural analyses and
35 video microscopy of *cyp40*^{-/-} promastigotes uncovered important defects in cell shape,
36 organization of the subpellicular tubulin network and motility at stationary growth phase. More
37 importantly, *cyp40*^{-/-} parasites were unable to establish intracellular infection in murine
38 macrophages and were eliminated during the first 24 hours post infection. Surprisingly, *cyp40*^{-/-}
39 ^{-/-} infectivity was restored in complemented parasites expressing a CyP40 mutant of the unique
40 S274 phosphorylation site. Together our data reveal non-redundant CyP40 functions in parasite
41 cytoskeletal remodeling relevant for the development of infectious parasites *in vitro*
42 independent of its phosphorylation status, and provides a framework for the genetic analysis of
43 *Leishmania*-specific phosphorylation sites and their role in regulating parasite protein function.

44

45

46 **Introduction**

47 Parasitic protozoa of the genus *Leishmania* are the etiological agents of leishmaniases, severe
48 human diseases with clinical manifestations ranging from self-curing cutaneous lesions to fatal
49 visceral infection. During the infectious cycle, *Leishmania* replicate as extracellular flagellated
50 promastigotes in the midgut of female phlebotomine sand flies where they undergo an
51 environmentally triggered differentiation process termed metacyclogenesis to develop into
52 highly infectious metacyclic promastigotes (Sacks *et al.*, 1984). Following transmission by
53 blood feeding sand flies, metacyclic parasites are engulfed by phagocytes such as macrophages,
54 where they differentiate into non-motile amastigotes that cause the pathology of the disease.

55 *In vitro* differentiation of infectious metacyclic parasites is induced by nutritional
56 starvation or acidic pH, and development of amastigote-like cells in culture is triggered by pH
57 and temperature change (Zakai *et al.*, 1998; Cunningham *et al.*, 2001; Barak *et al.*, 2005),
58 suggesting that *Leishmania* stage-differentiation occurs through sensing of environmental stress
59 signals encountered inside insect and vertebrate hosts (Zilberstein *et al.*, 1994). Recently, a role
60 of stress signaling in parasite development has been suggested based on phosphoproteomics
61 studies. Gel-based proteomics approaches comparing enriched phosphoprotein fractions from
62 promastigotes and axenic amastigotes revealed a surprising divergence of the stage-specific
63 phosphoproteome with more than 30% of proteins showing statistically significant differential
64 phosphorylation (Morales *et al.*, 2008; Morales *et al.*, 2010). Phosphorylation events in
65 amastigotes were almost exclusively restricted to heat shock proteins and chaperones and
66 occurred largely at parasite-specific phosphorylation sites (Hem *et al.*, 2010), suggesting
67 regulation of the *Leishmania* response to stress by post-translational rather than classical
68 transcriptional mechanisms. This possibility has been investigated previously for the stress-
69 induced protein 1 (STI1), a chaperone that acts as a scaffolding protein for the assembly of
70 foldosome complexes (Pratt and Dittmar, 1998). Null mutant analysis of STI1 in *L. donovani*

71 established the requirement of this protein for parasite survival *in vitro*, and complementation
72 analysis by plasmid shuffle identified the two phosphorylation sites S15 and S481 as essential
73 for STI1 function and parasite viability (Morales *et al.*, 2010).

74 One group of stress proteins that showed increased phosphorylation in amastigotes in
75 these studies is represented by immunophilins, a protein family that includes cyclophilins
76 (CyPs) and FK506 binding proteins (FKBPs), which are characterized by a peptidyl-prolyl
77 isomerase activity required for proper protein folding (Barik, 2006). In a previous study, we
78 revealed stage-specific functions of cyclophilins using the CyP inhibitor cyclosporin A (CsA)
79 (Yau *et al.*, 2010). Inhibitor-treated promastigotes underwent non-synchronous cell cycle arrest
80 and acquired features similar to amastigotes, including oval shape and shortening of the flagella
81 reminiscent of *L. donovani* promastigotes treated with the HSP90 inhibitor Geldanamycin
82 (Wiesgigl and Clos, 2001). In contrast, treatment of axenic amastigotes resulted in parasite
83 death, a phenomenon that was abrogated by temperature shift from 37°C to 26°C. While this
84 pharmacological approach suggests potential roles of cyclophilins in parasite proliferation and
85 thermotolerance and sheds new light on the stage-specific action of CsA and its lethal effects
86 on intracellular *Leishmania* (Yau *et al.*, 2010), the pleiotropic inhibition of multiple
87 cyclophilins and the phosphatase calcineurin by CsA-CyP complexes (Chappell and Wastling,
88 1992) raise questions about the specific function of each of the 17 *Leishmania* cyclophilins.

89 The effects of CsA on *L. donovani* differentiation and thermotolerance, its binding to
90 parasite cyclophilin 40 (LdCyP40) (Yau *et al.*, 2010), and its stage-specific phosphorylation in
91 the axenic amastigotes prompted us to assess the role of this co-chaperone and its modification
92 in parasite survival and infectivity combining gene deletion, phosphoproteomics, and
93 complementation approaches. CyP40 is a highly conserved bi-functional protein that carries
94 peptidyl-prolyl isomerase (PPIase) activity and forms dynamic complexes in yeast and
95 mammalian cells with HSP90 through its conserved tetratricopeptide repeat (TPR) domains

96 (Hoffmann and Handschumacher, 1995). The loss-of-function study presented here identifies
97 important roles for LdCyP40 in the development of infectious parasites *in vitro* and
98 intracellular parasite survival independent of its phosphorylation status, thus establishing a
99 novel link between *L. donovani* chaperone activity and stress-induced parasite differentiation
100 relevant for host cell infection.

101

102 **Results**

103 *L. donovani* CyP40 is constitutively expressed but stage-specifically phosphorylated.

104 CyP40 belongs to the immunophilin superfamily that comprises 17 members in *Leishmania*
105 (Yau *et al.*, 2010). We first investigated the domain structure and sequence conservation of this
106 protein across trypanosomatid parasites (*L. major*, *L. infantum*, *L. braziliensis*, *T. brucei* and *T.*
107 *cruzi*) and various higher eukaryotes, including human, mouse, cow, and yeast. The putative
108 CyP40 protein sequences were retrieved from the UniProt (<http://www.uniprot.org/>) and
109 TriTrypDB databases (<http://tritrypdb.org/tritrypdb/>) by Blast search using *L. major* cyclophilin
110 40 (LmjF35.4770) as a query and aligned using ClustalW 2.0.12. *Leishmania* CyP40 displays
111 the characteristic two-domain structure (Fig. 1A). The N-terminal cyclophilin-like domain
112 (CLD) spans 171 residues and is highly conserved showing 68.8% of amino acid identity
113 across the analyzed organisms. This domain carries the enzymatic peptidyl-prolyl isomerase
114 (PPIase) function and is the target of the cyclophilin-specific inhibitor cyclosporin (CsA). The
115 functional residues for both PPIase activity and CsA binding are highly conserved as expected
116 from our previously published observations that *L. donovani* CyP40 carries isomerase activity
117 and can be enriched from crude parasite extracts by affinity chromatography using immobilized
118 CsA (Yau *et al.*, 2010). In addition, a cleft localized C-terminal of the CLD domain shows a
119 series of conserved residues that have been previously implicated in CyP40 chaperone activity
120 (Mok *et al.*, 2006). The C-terminal part of CyP40 contains three distinct TPR motifs that are

121 less conserved (50.4%, 47.3% and 50.2% of identity for TPR1, 2 and 3 respectively) and
122 together form the TPR domain known to interact with the conserved EEVD consensus
123 sequence of HSP70 and HSP90 (Ward *et al.*, 2002). Together these data identify *Leishmania*
124 CyP40 as a highly conserved member of the eukaryote immunophilin protein family that likely
125 interacts with HSPs and carries chaperone function.

126 In our previous proteomics studies on the protein phosphorylation dynamics during
127 *Leishmania* differentiation, *L. donovani* LdCyP40 abundance was significantly increased in the
128 phosphoproteome of axenic amastigotes when compared to promastigotes, suggesting
129 amastigote-specific phosphorylation of this protein (Morales *et al.*, 2008; Morales *et al.*, 2010).
130 However, this putative stage-specific phosphorylation has not been validated in *bona fide*
131 animal-derived amastigotes, and whether the increase of abundance results from an increase in
132 phospho-stoichiometry or simply increased protein expression has not been investigated. To
133 distinguish between these two possibilities, we analyzed LdCyP40 stage-specific expression
134 and phosphorylation profiles by Western blotting using total protein extracts and
135 phosphoprotein fractions enriched by immobilized metal affinity chromatography obtained
136 from cultured promastigotes, axenic amastigotes, and *bona fide* amastigotes purified from *L.*
137 *donovani* infected hamster spleen. As judged by α -tubulin expression used as normalization
138 control, LdCyP40 is constitutively expressed across all stages tested, but shows a significant
139 increase in abundance in the phosphoprotein fraction of axenic and hamster-derived
140 amastigotes compared to promastigotes (Fig. 1B). The weaker signal observed in splenic
141 amastigotes compared to axenic amastigotes may result from unequal loading or reflects a
142 difference in phosphorylation levels between both samples. These results establish LdCyP40
143 stage-specific *de novo* phosphorylation and a substantial increase in the phospho-stoichiometry
144 of this protein in amastigotes.

145

146 *Establishment of cyp40^{-/-} null mutants.*

147 We established LdCyP40 null mutant parasites to study the biological functions of LdCyP40
148 and ultimately assess the physiological role of stage-specific CyP40 phosphorylation by
149 complementation. The endogenous alleles were replaced using two targeting constructs
150 comprising puromycin and bleomycin resistance genes flanked by the 5' and 3'UTRs of
151 LdCyP40 (Fig. 2A and Fig. S1). Respective add-back controls re-expressing LdCyP40 from the
152 ribosomal locus under the control of the CyP40 3'UTR were generated using a knock-in
153 strategy (Fig. 2A and Fig. S2). The absence of the LdCyP40 ORF and corresponding protein in
154 six independent null mutant clones and its re-expression in complemented parasites was
155 confirmed by PCR (Fig. 2B and data not shown) and Western blot analysis (Fig. 2C and Fig.
156 S3).

157

158 *Morphological characterization of cyp40^{-/-} null mutant and add-back clones.*

159 Microscopic observation of the two independent null mutant clones *cyp40^{-/-}* cl.4 and cl.5 and
160 four independent add-back clones as well as add-back pools derived from each null mutant
161 clone revealed important morphological alternations at stationary growth phase that correlated
162 with the absence of CyP40 expression (Fig. S4A). At logarithmic growth phase, CyP40 null
163 mutant promastigotes were morphologically identical to wild-type and add-back controls as
164 judged by Giemsa staining of fixed parasite cultures (Fig. S4A, left panels). By contrast 70% of
165 *cyp40^{-/-}* cells at stationary growth phase of two independent null mutant clones acquired a
166 small spherical cell shape, while wild-type parasites and add-back clones showed the spindle
167 shaped cell body characteristic for stationary phase parasites (Fig. S4A, right panels).
168 Moreover, measurements of cell body and flagellum length revealed a significant reduction of
169 the ratio between both parameters in *cyp40^{-/-}* cells (Fig. S4B). Given the reproducibility of this

170 phenotype, most of the subsequent experiments were performed with CyP40 null mutant clone
171 4 and its corresponding add-back pool if not otherwise stated.

172 As cell rounding is often associated with cellular stress and apoptotic cell death (Lee *et*
173 *al.*, 2002; Gannavaram and Debrabant, 2012), we next investigated integrity and ultra-structural
174 organization of CyP40 null mutant cells and controls. Wild-type, *cyp40*^{-/-} and *cyp40*^{-/-/+}
175 promastigotes were fixed with 2% glutaraldehyde and analyzed by scanning electron
176 microscopy (Fig. 3A). This analysis confirmed the atypical spherical cell shape of *cyp40*^{-/-}
177 stationary phase promastigotes and provided a first indication of their cellular integrity.
178 Likewise, analysis by transmission electron microscopy revealed no overt alterations in cellular
179 organization of *cyp40*^{-/-} cells, which showed intact nuclei and mitochondria, and absence of
180 apoptotic bodies or autophagosomes (Fig. 3B). Finally, direct assessment of cell death by
181 FACS analysis following membrane exposure of phosphatidylserine with annexin V-FITC and
182 exclusion of propidium iodide did not reveal any significant change in cell viability of
183 stationary *cyp40*^{-/-} parasites after 6 days of *in vitro* culture (Fig. 3C). Together these results
184 rule out the possibility of cell death as the cause of *cyp40*^{-/-} morphological alterations but
185 rather suggest a defect in parasite development and cellular remodeling at stationary phase.

186

187 *Phenotypic characterization of stationary phase cyp40*^{-/-} *promastigotes*.

188 During the infectious cycle, non-infectious procyclic promastigotes differentiate into highly
189 infective metacyclic promastigotes in response to nutritional starvation after digestion and
190 excretion of the blood meal. This process is mimicked in culture during stationary growth
191 phase (Sacks *et al.*, 1984; da Silva and Sacks, 1987) and is accompanied by the expression of
192 characteristic biological and morphological markers, including expression of high molecular
193 weight LPG and increase in SHERP mRNA abundance. The altered morphology of *cyp40*^{-/-}
194 parasites primed us to investigate the status of these phenotypic markers. First, monitoring cell

195 density of WT, *cyp40*^{-/-} and add-back promastigotes with a CASY cell counter, deletion of
196 CyP40 did not affect the rate of proliferation nor the density reached at stationary phase (Fig.
197 4A). Surprisingly, despite defects in stationary phase morphology, *cyp40*^{-/-} promastigotes
198 showed normal expression of higher molecular weight LPG characteristic for stationary phase
199 parasites as revealed by Western blot analysis using the anti-LPG antibody CA7AE (Fig. 4B),
200 and induced SHERP mRNA to levels corresponding to WT and add-back controls (Fig. 4C).
201 Together these data demonstrate that *L. donovani* CyP40 is dispensable for parasite survival *in*
202 *vitro* under standard culture conditions, and is not required for metacyclic-specific glycolipid
203 remodeling or gene regulation, at least for the markers investigated here. To further
204 characterize the stationary phase defect of *cyp40*^{-/-} parasites, we investigated the functional
205 properties of infectious, stationary phase parasites, including cell motility and intracellular
206 survival.

207
208 *CyP40 null mutants show reduced motility and a loosened subpellicular tubulin network.*

209 An important functional characteristic of stationary phase parasites is a significant increase in
210 motility, which is of physiological relevance in the natural setting for migration of metacyclic
211 parasites from sand fly midgut to larynx (Walters *et al.*, 1989; Walters *et al.*, 1993), or the
212 establishment of host cell infection (Uezato *et al.*, 2005; Forestier *et al.*, 2011). We quantified
213 motility in at least 741 WT, *cyp40*^{-/-} and add-back promastigotes obtained from logarithmic
214 and stationary phase cultures utilizing video microscopy and *in silico* tracking analysis.
215 Qualitative observation of each movie did not reveal any significant difference in flagellar
216 wave orientation and flagellar beating amplitude across all lines and both culture conditions
217 (data not shown). Likewise, quantitative analysis showed no significant difference in beating
218 frequencies and speed between WT, *cyp40*^{-/-}, and add-back log phase promastigotes. As
219 expected, WT and add-back promastigotes showed a statistically significant increase in motility

220 speed and flagellar beat frequency at stationary phase (Fig. 5A), and moved in a uni-directional
221 way over extended distances (Fig. 5B and Video S1). By contrast, CyP40 null mutant parasites
222 do not increase speed at stationary growth phase (Fig. 5A) and show a defect in directional
223 motility as they largely spin on themselves (Fig. 5B and Video S1).

224 As judged by transmission electron microscopy, this motility defect was not caused by
225 alterations in flagellar structure of *cyp40*^{-/-} parasites, which maintained the characteristic 9+2
226 organization of the axoneme (Fig. 5C). However, investigating more closely the *Leishmania*
227 subpellicular tubulin network by scanning EM after removal of the parasite plasma membrane
228 by detergent treatment, stationary phase *cyp40*^{-/-} promastigotes showed a significantly
229 loosened tubulin network, in contrast to the very dense, small-meshed network observed in
230 wild-type parasites (Fig. 5D). Western blot analysis of WT, *cyp40*^{-/-} and add-back parasites
231 from logarithmic and stationary cultures did not reveal any significant difference in expression
232 levels of α - and β -tubulin, with the exception of a small β -tubulin isoform at around 33 kDa,
233 which is specific for stationary phase cells and slightly reduced in CyP40 null mutants (Fig.
234 S5). This finding was confirmed by quantitative proteomics using 2D-DIGE analysis of total
235 extracts of WT and *cyp40*^{-/-} promastigotes from stationary growth phase that identified the
236 small β -tubulin isoform (LinJ.21.2240, spot 928) with a highly significant, four-fold reduction
237 of abundance in the null mutant *cyp40*^{-/-} (Fig. 5E and Fig. S6). This isoform corresponds to a
238 previously described proteolytic cleavage product of β -tubulin with a molecular weight of
239 about 34 kDa (Drummel-Smith *et al.*, 2003). Similar low molecular weight isoforms have been
240 identified in the stage-specific proteomes of *L. major* and *T. cruzi* metacyclic parasites (Parodi-
241 Talice *et al.*, 2007; Mojtahedi *et al.*, 2008), but their biological significance in stage-specific
242 remodeling of the tubulin network remains to be elucidated. Together these data demonstrate
243 non-redundant CyP40 functions in cytoskeletal remodeling of the parasite during stationary

244 growth phase, which is likely the basis for the aberrant morphology and the motility defect
245 observed in *cyp40*^{-/-} parasites.

246

247 *Leishmania cyp40*^{-/-} mutants fail to establish intracellular infection.

248 The development of highly infectious metacyclic parasites can be mimicked by exposing
249 promastigotes to various forms of stress, including nutritional starvation and acidification at
250 stationary phase (da Silva and Sacks, 1987; Bate and Tetley, 1993; Zakai *et al.*, 1998; Serafim
251 *et al.*, 2012). The stationary phase-specific defects of *cyp40*^{-/-} promastigotes primed us to
252 investigate their capacity to infect host cells. Bone marrow-derived macrophages obtained from
253 C57BL/6 mice were incubated for 2 hours with WT, *cyp40*^{-/-}, and add-back stationary phase
254 promastigotes at a multiplicity of infection of 10 parasites per host cell, free parasites were
255 removed by washing, and intracellular parasite burden was determined by nuclear staining and
256 fluorescence microscopy at 2, 24, and 48 hours post infection. The *cyp40*^{-/-} cells were
257 phagocytosed at levels comparable to the controls with 80% of macrophages hosting a mean of
258 2.5 parasites per infected host cell (Fig. 6A). While WT and add-back parasites persisted over
259 the 48 hours post infection period and showed intracellular proliferation as documented by the
260 increase in number of parasites per infected macrophage (Fig. 6A, lower panel), the level of
261 *cyp40*^{-/-} infection was reduced by over 90% during the first 24 hours and parasites were
262 completely eliminated by 48 hours post infection (Fig. 6A). We next tested if intracellular
263 elimination of *cyp40*^{-/-} parasites is caused by a susceptibility to elevated temperature or acidic
264 pH encountered inside the host cell, or results from a defect in amastigote differentiation.
265 CyP40 null mutant promastigotes grown at 37°C did not show any significant difference to WT
266 and add-back parasites (Fig. S7A), and axenic amastigotes developed and proliferated normally
267 in response to both temperature and pH shift as judged by cell counting (Fig. 6B) and
268 assessment of expression of the axenic amastigote marker protein A2 (Fig. 6C). Thus,

269 LdCyP40 carries essential functions for successful host cell infection independent of parasite
270 resistance to acidic pH, elevated temperature, or amastigote development.

271

272 *Functional assessment of CyP40 phosphorylation.*

273 The failure of *cyp40*^{-/-} parasites to establish intracellular infection provided an interesting read
274 out to test for the function of CyP40 phosphorylation in parasite infectivity using
275 complementation analysis. We investigated the CyP40 amino acid residues that were
276 phosphorylated by using LC-ESI-MS/MS analysis. Axenic amastigote protein extracts from
277 transgenic *L. donovani* over-expressing Strep::*CyP40* were collected and Strep::*CyP40* was
278 enriched by affinity chromatography using streptactin agarose liquid chromatography (Fig. S8).
279 After SDS-PAGE and Coomassie Brilliant Blue staining, the band corresponding to
280 Strep::*CyP40* was extracted and subjected to phosphopeptide analysis by LC-ESI-MS/MS. MS
281 analysis revealed that residue serine 274 (S274) of *CyP40* was the only detected
282 phosphorylation site of *CyP40* in axenic amastigotes (Fig. 7A and Fig. S9). The multiple
283 sequence alignment of trypanosomatid *CyP40* described in Fig. 1 localizes S274 to the center
284 of the TPR motif 2 and shows that it is unique among trypanosomatids (Fig. 7B). An
285 independent study also pointed out that S274 is phosphorylated in *L. mexicana* (Dr. Martin
286 Wiese, University of Strathclyde, Glasgow, unpublished data). These data suggest that
287 phosphorylation at S274 of *CyP40* is *Leishmania*-specific and may have critical roles in
288 parasite survival.

289 To study the relationship between *CyP40* phosphorylation and parasite infectivity, an
290 add-back line was generated expressing a serine 274 to alanine (S274A) phosphorylation site
291 mutant version of *CyP40* (Fig. 7C, left panel, and Fig. S10), which was subsequently tested for
292 *in vitro* infectivity. We next assessed the accumulation of this mutant in the parasite phospho-
293 protein fraction to test if elimination of S274 is sufficient to abrogate phospho-specific affinity

294 purification of CyP40. Total protein extracts and phospho-protein enriched extracts from WT
295 treated or not with lambda phosphatase, or add-back parasites expressing CyP40-S274A were
296 analyzed by western blotting using anti-CyP40 antibody and anti- α -tubulin antibody for
297 normalization of the signals. As expected, robust amounts of CyP40 were detected in the wild-
298 type phospho-protein extracts, and this signal was strongly reduced by phosphatase treatment
299 prior to enrichment representing background levels of CyP40 enrichment likely due to non-
300 specific binding to the affinity matrix (Fig. 7C, right panel). The same level of background
301 signal was obtained with CyP40-S274A confirming that this residue represents the only
302 phosphorylation site in CyP40.

303 Bone marrow-derived macrophages were then infected with *cyp40*^{-/-} promastigotes
304 complemented with CyP40-S274A. The controls, WT, *cyp40*^{-/-} and add-back promastigotes
305 behaved in a similar fashion as described previously (Fig. 7D). The higher counts of infected
306 macrophage obtained with WT parasites compared to add-back control may be due to batch-to-
307 batch variation of parasites. The *cyp40*^{-/-}+*S274A* add-back promastigotes entered
308 macrophages and established infection at similar efficiency. The parasite number decreased in
309 the first 24 hours post infection but parasites started to multiply after 48 hours (Fig. 7D, left
310 panel). The intracellular proliferation of CyP40-WT and CyP40-S274A add-back did not show
311 any significant difference, as indicated by the number of parasites per 100 macrophages at 48
312 hours post infection (Fig. 7D, right panel). These data indicate that phosphorylation of CyP40
313 is either not important for the function of CyP40 in *Leishmania* intracellular survival, or can be
314 compensated by other co-chaperones.

315

316

317 **Discussion**

318 The conserved co-chaperone CyP40 participates in the formation of highly dynamic heat shock
319 protein complexes across various eukaryotes (Pratt *et al.*, 2004; Ratajczak *et al.*, 2003; Riggs *et*
320 *al.*, 2004; Pearl and Prodromou, 2006), and has been linked to many tissue- and organism-
321 specific functions, including steroid receptor signaling in mammalian cells and yeast (Ratajczak
322 *et al.*, 2009), or microRNA activity and assembly of RNA-induced silencing complexes (RISCs)
323 in plants (Smith *et al.*, 2009; Ilki *et al.*, 2012). No information is available on how this co-
324 chaperone affects viability and infectivity of trypanosomatid pathogens, including *Leishmania*,
325 even though parasite differentiation is triggered by environmental stress signals (Zilberstein
326 and Shapira, 1994), has been previously linked to the formation of heat shock complexes
327 (Morales *et al.*, 2010), and is regulated by HSP90 activity (Wiesgigl and Clos, 2001). Here by
328 utilizing a targeted null mutant approach we reveal non-redundant and essential CyP40
329 functions in *Leishmania* stage-specific morphogenesis, motility, and the development of
330 infectious-stage parasites.

331 We recently obtained first insight into the biological roles and functional diversity of *L.*
332 *donovani* CyPs and FKBP s using a pharmacological approach. Treatment of *L. donovani*
333 promastigotes and axenic amastigotes with CsA and FK506 revealed important, redundant
334 functions of CyPs and FKBP s in promastigote proliferation and morphogenesis, but unique
335 function of *Leishmania* CyPs in parasite thermotolerance (Yau *et al.*, 2010). The direct
336 enrichment of CyP40 from *L. donovani* extracts using immobilized CsA, the presence of a
337 conserved TPR domain in this protein, and its stage-specific phosphorylation in axenic
338 amastigotes (Morales *et al.*, 2008; Morales *et al.*, 2010) suggested important stress functions of
339 CyP40 in *Leishmania* differentiation and thermotolerance that may be regulated at post-
340 translational levels.

341 However, the CyP40 loss-of-function analysis performed in this study shed a
342 substantially different light on the protein's unique functions. In contrast to CsA treated
343 promastigotes that underwent non-synchronous cell cycle arrest at logarithmic growth phase
344 and showed morphological changes reminiscent of axenic amastigotes, i.e. retraction of the
345 flagellum and oval cell body (Yau *et al.*, 2010), *cyp40*^{-/-} promastigotes did not show any overt
346 defects in cell growth or cell shape at this culture stage. Moreover, absence of CyP40
347 expression did neither alter the IC50 to CsA nor did it affect the phenotypic response to this
348 inhibitor (Fig S7 and data not shown) suggesting that CyP40 is not a major target of CsA at this
349 culture stage. Finally, *cyp40*^{-/-} parasites did not show any overt defects in resistance to various
350 forms of stress, including nutritional starvation, acidic pH and elevated temperatures (Fig. 6D
351 and S7), while CsA-treated parasites underwent cell death at 37°C (Yau *et al.*, 2010). Thus, in
352 contrast to other TPR domain containing chaperones in *Leishmania*, such as STI1 (Morales *et*
353 *al.*, 2010; Hombach *et al.*, 2013) or SGT (Ommen *et al.*, 2010), which are both essential for
354 *Leishmania* promastigote viability, CyP40 carries non-essential functions at this stage, which
355 may be redundant to other PPIases of the CyP or FKBP protein families and thus compensated
356 in the null mutant.

357 Various aspects of the *cyp40*^{-/-} null mutant phenotype pointed at essential and non-
358 redundant CyP40 functions that were not observed during CsA treatment and thus are likely
359 independent of the CyP40 PPIase activity targeted by this inhibitor (Yau *et al.*, 2010). First,
360 lack of CyP40 expression caused important morphological and structural alterations of
361 stationary phase parasites, which adopted a rounded rather than characteristic needle-shaped
362 morphology. These defects were linked to a loosening of the subpellicular tubulin network that
363 determines parasite morphology and provides the rigidity necessary for efficient motility
364 (Seebeck *et al.*, 1990). These results point to unique CyP40 functions in regulating *Leishmania*
365 cytoskeletal dynamics. Microtubule elongation and shortening are highly dynamic events that

366 are regulated by stabilizing or destabilizing interactions (Walczak, 2000). Recently, a role of
367 the CyP40 related immunophilin FKBP52 in regulating microtubule depolymerization through
368 direct interaction with tubulin via its TPR domain has been described in rat brain (Chambraud
369 *et al.*, 2007). Given the capacity of CyP40 and FKBP52 to compete for molecular partners
370 (Ratajczak *et al.*, 2003), it is possible that CyP40 interacts with microtubules and promotes
371 tubulin polymerization to counteract FKBP52-mediated depolymerization. Alternatively, the
372 requirement of CyP40 for *Leishmania* morphological integrity at stationary growth phase may
373 be indirect and caused by misfolding of client proteins that require CyP40 co-chaperone
374 function. In yeast, TPR-domain containing co-chaperones make distinct and extensive contacts
375 with HSP90 that lead to a differential modulation of HSP90 chaperone function (Ratajczak *et al.*,
376 2009). For example, displacement of STI1 from HSP90 by the yeast CyP40 homolog CPR6
377 restores ATPase activity (Pearl and Prodromou, 2006). Based on our previous observation that
378 *L. donovani* STI1 acts as a scaffolding protein to assemble highly dynamic heat shock
379 complexes (Morales *et al.*, 2010), it is possible that lack of CyP40 alters the formation and
380 activity of foldosome complexes causing the observed phenotypic consequences of CyP40
381 deletion.

382 Second, *cyp40*^{-/-} parasites showed an important, stage-specific defect in directional
383 motility despite integrity of the 9+2 structure of the axoneme. The presence of trypanosomatid
384 CyP40 in the flagellar proteome (Oberholzer *et al.*, 2011) indicates that LdCyP40 may directly
385 interact with motor components for proper folding. This possibility is supported by various
386 studies of related FKBP52 showing (i) direct interaction between the FKBP52 PPIase domain
387 and the motor protein dynein via dynamitin (Silverstein *et al.*, 1999; Galigniana *et al.*, 2001;
388 Galigniana *et al.*, 2004); (ii) an essential role of FKBP52 for sperm tail development and
389 movement (Hong *et al.*, 2007); and (iii) a requirement of FKBP12 in *Trypanosoma brucei*
390 motility (Brasseur *et al.*, 2013).

391 Finally, the most striking loss-of-function phenotype of *cyp40*^{-/-} parasites is represented
392 by the abrogation of intracellular parasite survival. Unfortunately the *L. donovani* strain used in
393 our analysis failed to establish hamster infection (Fig. S11) likely due to a non-specific loss of
394 virulence that occurs during parasite culture adaptation (Pescher et al, 2011). While we cannot
395 rule out that loss of intracellular survival reflects a developmental defect caused by the
396 morphological and cytoskeletal alterations observed at stationary phase culture, our
397 observations that null mutant parasites are normal in viability and metacyclic marker
398 expression, and convert normally into axenic amastigotes may point to different possible
399 scenarios. Intracellular killing of *cyp40*^{-/-} mutants may be associated with the requirement of
400 LdCyP40 co-chaperone activity for proper folding of parasite survival factors, which may
401 confer parasite resistance to macrophage cytolytic activities. Alternatively, the identification of
402 LdCyP40 in the parasite secretome (Silverman *et al.*, 2008) opens the possibility that this co-
403 chaperone may directly interact with host phagolysosomal or cytoplasmic proteins to subvert
404 host cytolytic activities and favor intracellular parasite survival, a scenario reminiscent to
405 secreted *T. cruzi* CyP19, which inactivates the anti-microbial peptide trialysin of the reduviid
406 insect vector by direct binding (Kulkarni *et al.*, 2013). A third possibility is the involvement of
407 CyP40 in the sorting of exosome payload proteins, similar to the role played by the chaperone
408 HSP100 (Silverman *et al.*, 2010). This idea would be supported by the very similar phenotypes
409 of CyP40 (this paper) and HSP100 null mutants (Krobitsch and Clos, 1999).

410 In previous phosphoproteomics investigations we identified LdCyP40 as a major
411 amastigote-specific phosphoprotein and revealed a coordinated increase in phosphorylation of
412 all major parasite chaperones and HSPs during axenic amastigote differentiation, which
413 occurred largely at parasite-specific sites (Morales *et al.*, 2008; Morales *et al.*, 2010; Hem *et al.*,
414 2010). These results are compatible with the hypothesis that *Leishmania* stress protein function
415 is regulated at post-translational levels through phosphorylation by stress-activated protein

416 kinases, a possibility that is supported by the genetic validation of two phosphorylation sites in
417 *L. donovani* STI1 that are essential for parasite viability (Morales *et al.*, 2010). The failure of
418 *cyp40*^{-/-} parasites to establish intracellular infection provided a powerful read out to further test
419 this hypothesis and to assess the physiological role of CyP40 phosphorylation by site-directed
420 mutagenesis of the single CyP40 phosphorylation site. Surprisingly, although CyP40
421 phosphorylation at S274 was highly stage-specific and observed exclusively in axenic and *bona*
422 *fide* splenic amastigotes, expression of an LdCyP40 S274A mutant fully restored intracellular
423 survival of *cyp40*^{-/-} parasites thus ruling out an essential role of this modification in
424 intracellular infection *in vitro*. The biological function of this highly conserved phosphorylation
425 site eludes us. Phosphorylation of FKBP52 disrupts the binding activity of this chaperone to
426 HSP90 and thus is required for the dynamic turnover of heat shock complexes (Miyata *et al.*,
427 1997). The S274 CyP40 phosphorylation site maps to the TPR2 subdomain and thus may play a
428 similar role in regulating the dynamics of protein-protein interactions, but may not cause a
429 discernible phenotype due to the expression of other, functionally redundant TPR-domain
430 proteins in *Leishmania*.

431 In conclusion, null mutant analysis of LdCyP40 revealed important non-redundant
432 functions of this co-chaperone in parasite morphogenesis, cytoskeletal remodeling during
433 stationary growth phase, motility, and infectivity. How LdCyP40 carries out its parasite-
434 specific functions, and whether they depend on CyP40 isomerase and/or (co-)chaperone
435 activities remains to be elucidated. In other organisms, CyP40 exerts its function mainly
436 through binding to HSP90 (Li *et al.*, 2011). There are several lines of evidence that CyP40
437 functions in *Leishmania* may not follow this established model as isolation of HSP90
438 complexes by anti-STI1 immuno-precipitation from *L. donovani* promastigotes and axenic
439 amastigotes did not reveal LdCyP40 (Morales *et al.*, 2010), although both co-chaperones can
440 bind HSP90 simultaneously in other organisms (Li *et al.*, 2011). In addition, while the

441 LdCyP40 PPIase domain is highly conserved, the TPR domain underwent substantial
442 evolutionary modification (Yau *et al.*, 2010), which may impact on LdCyP40-HSP interactions.
443 Future studies applying structure/function analyses to assess LdCyP40 isomerase and
444 chaperone activities, combined with pull down assays and native electrophoresis, will elucidate
445 the roles of the LdCyP40 PPIase and TPR domains in *L. donovani* differentiation, virulence and
446 stress protein interaction.

447

448

449 Experimental procedures

450 **Ethics statement.** All animals were handled according to institutional guidelines of the Central
451 Animal Facility of the Institut Pasteur (Paris, France) and experiments were performed in
452 accordance with protocols approved by the animal Experimentation Ethics Committee of the
453 Institut Pasteur (permit #03–49) and the veterinary service of the French Ministry of
454 Agriculture (number B-75-1159, 30 May 2011). The animals were housed and handled in
455 accordance with good animal practice as defined by FELASA (www.felasa.eu/guidelines.php).

456
457 **Mice, macrophages and parasites.** Wild-type C57BL/6 mice were purchased from Charles
458 River, and were kept and treated according to the institutional guidelines for animal
459 experiments. Bone marrow-derived macrophages (BMMs) were prepared from the femurs of 6
460 – 8 weeks old female mice as described (Forestier *et al.*, 2011). *Leishmania donovani* strain
461 1SR (MHOM/SD/62/1SR) was maintained at 25°C, pH 7.4 in supplemented M199 medium
462 (Kapler *et al.*, 1990; Hubel *et al.*, 1997). Axenic differentiation of promastigotes was performed
463 as described (Goyard *et al.*, 2003; Morales *et al.*, 2008).

464
465 **Multiple sequences analysis.** The putative cyclophilin 40 protein sequences of human, mouse,
466 bovine, yeast and several trypanosomatids, including *L. major*, *L. infantum*, *L. braziliensis*, *T.*
467 *brucei* and *T. cruzi*, were retrieved from the NCBI (<http://www.ncbi.nlm.nih.gov/protein/>) and
468 TriTrypDB databases (<http://tritrypdb.org/tritrypdb/>) by Blast search with algorithm blastp
469 using *L. major* cyclophilin 40 (LmjF35.4770) as a query. The retrieved sequences were aligned
470 with ClustalW 2.0.12 using the built-in programs of Geneious version 4.8 (Larkin *et al.*, 2007;
471 Kearse *et al.*, 2012; <http://www.geneious.com>). Matrix Blosum62 was applied as the scoring
472 rule for amino acid substitution (Henikoff and Henikoff, 1993). Sequence alignments with
473 Expect (E) values less than 10^{-5} were considered significant.

474
475 **Generation of *L. donovani* *cyp40*^{-/-} mutants by gene replacement.** Null mutant parasites
476 were generated by sequential replacement of the endogenous *CYP40* alleles using two targeting
477 constructs comprising puromycin and bleomycin resistance genes flanked by approximately
478 1000 bp of the 5' and 3'UTRs of the *L. infantum* *CYP40* gene (GeneDB accession number
479 LinJ.35.4830) that were PCR amplified from *L. infantum* genomic DNA (strain
480 MHOM/FR/91/LEM2259). Genomic DNA of parasites was extracted with Genra Systems
481 Puregene Tissue Core Kit A (Qiagen) according to the manufacturer's instruction.

482 For subsequent cloning of the 5'UTR, primer pairs CYP40-5'UTR-fwd
483 (GGGGAATTCATTTAAATGAGATGCGGTAGATGTCCTG) and CYP40-5'UTR-rev
484 (GGGGGTACCTGCGTGCGTGTAGGTCTAC) added EcoRI and SmaI sites (underlined) to
485 the 5'-end, and a KpnI site to the 3'-end. For cloning of the 3'UTR, primer pairs CYP40-
486 3'UTR-fwd (GGGGGATCCGTTGCGCCTGCCGGACAGAAC) and CYP40-3'UTR-rev
487 (CCCAAGCTTATTTAAATGAGTGAGACGTGCACGCAAC) added BamHI site to the 5'-
488 end, and HindIII and SmaI sites to the 3'-end. The amplified fragments were digested with
489 EcoRI/KpnI and BamHI/HindIII and ligated into pUC19 vector digested with the same enzyme
490 pairs yielding the constructs pUC-CYP40-5'UTR and pUC-CYP40-3'UTR. Next, the cloned
491 5'UTR fragment was liberated by EcoRI and KpnI digestion, ligated into pUC-CYP40-3'UTR
492 digested with the same enzyme pair yielding the construct pUC-CYP40-5'3'UTR. For the
493 construction of the final targeting constructs, the antibiotic resistance genes *PAC* and *BLE* were
494 isolated from pUC-PAC and pUC-BLE after digestion with KpnI and BamHI and ligated into
495 pUC-CYP40-5'3'UTR digested with the same enzymes, yielded the final constructs pUC-
496 CYP40-5'PAC3' and pUC-CYP40-5'BLE3' used for *Leishmania* *CYP40* gene replacement.

497 For genetic complementation of the *Cyp40* null mutant, an "add-back" line was
498 established using a knock-in strategy. The *CYP40* open reading frame was PCR amplified using

499 primers CYP40-5'Kpn (GGGGGTACCATGCCGAACACATACTGC) and CYP40-3'BglII
500 (GGGAGATCTTCACGAGAACATCTTCTTG), adding KpnI and BglII sites (underlined) to
501 the 5'- and 3'-ends of the *LmCYP40*, respectively. The amplified fragment was digested with
502 these enzymes, ligated into pUC-CYP40-3'UTR digested with KpnI and BamHI yielding the
503 construct pUC-CYP40+3'UTR. The cloned CYP40+3'UTR was liberated by digestion with
504 Acc65I and SwaI, the 5'-protruding end of the digested fragment was filled-in with Klenow
505 fragment, and cloned into XbaI/BglII digested and blunt ended vector pIRmcs3+ (Hoyer *et al.*,
506 2004) yielding the final construct pIR-CYP40 used for integration into the small ribosomal
507 subunit (SSU) locus of the *cyp40*^{-/-} genome.

508 The plasmids were extracted from transformed *E. coli* DH5 α , purified using CsCl
509 continuous gradient centrifugation and linearized with SwaI. The targeting fragments were
510 separated by agarose electrophoresis, purified and transfected into logarithmic promastigotes
511 by electroporation as described (Spath *et al.*, 2000; Ommen *et al.*, 2009). Integration of gene
512 replacement constructs was verified by PCR using the primer pairs: (P1,
513 CATTGGCGCTTTTCATGC; P2, ATTACATCAGACGTAATCTG; P3,
514 TGAAAGTGCTACCCTGGTACGTC; P4, GTGGGCTTGTACTCGGTC; P5,
515 GGAACGGCACTGGTCAAC). PCR products were analyzed by agarose gel electrophoresis.

516
517 **Site-directed mutagenesis.** Cloned *L. major* CYP40 in the construct pUC-CYP40+3'UTR was
518 used as template for site-directed mutagenesis that is based on a modified PCR (Hombach *et*
519 *al.*, 2013). The template was amplified by PCR using the following phosphorylated
520 oligonucleotide pairs (mutation sites were underlined) to introduce the mutation: CYP40-
521 S274A-fwd (GCAGTGGGCGGAGGCTCGCCACACGGCGTC) and CYP40-S274-rev
522 (TGGAGCTTGATGGCGCACATTG). The PCR products were ligated and used to transform

523 competent *E. coli* DH5 α (Invitrogen). Plasmids were extracted and purified for DNA
524 sequencing to verify the mutation.

525

526 **Cell counting.** The cell density of parasite cultures were determined every 24 hours either
527 using a CASY cell counter (Schärfe System) or microscopically by counting 2% (w/v)
528 glutaraldehyde fixed cells loaded into a Neubauer-improved cell counting chamber
529 (Marienfeld).

530

531 **Macrophage infection assays.** Isolation and differentiation of BMMs were performed as
532 described (Forestier *et al.*, 2011). The mature BMMs were treated with 20 mM EDTA for
533 detachment. The dislodged cells were resuspended in complete RPMI medium and plated
534 overnight in 24-well plates containing sterile 12-mm glass coverslips at a cell density of 1×10^5
535 cells/well. *L. donovani* promastigotes cultured for 6 days until stationary-phase ($8 - 10 \times$
536 10^7 /ml), or axenic amastigotes from logarithmic growth phase ($1 - 5 \times 10^7$ /ml) were washed
537 three times with plain RPMI medium and once with infection medium (0.7% BSA, 25 mM
538 HEPES [pH 7.4] in plain RPMI medium), incubated with BMMs at 37°C with 5% CO₂ for 2
539 hours at a multiplicity of infection of 10 parasites per host cell. Extracellular parasites were
540 then removed by washing the coverslips extensively with PBS and transfer of the cover slip
541 into new 24-well plates containing 1 ml of fresh complete RPMI medium per well. This
542 washing procedure was repeated daily until 5 days post infection. The plates were incubated for
543 up to 5 days at 37°C with 5% CO₂ during the experiment.

544

545 **Analysis of intracellular parasite burden.** Coverslips of quadruplicate experiments were
546 collected at 0, 24 and 48 hours post infection, washed once with PBS and then fixed with 4%
547 (w/v) paraformaldehyde for 15 min at room temperature. After three further washes with PBS

548 and one wash with ddH₂O, the coverslips were mounted with Mowiol medium containing
549 nuclear dye Hoechst 33342 (Invitrogen). At least 100 macrophages were imaged per coverslip
550 using Axioplan 2 wide field light microscope with the Apotome module (Carl Zeiss). Number
551 of parasites and macrophages was estimated counting host cell and parasite nuclei using ImageJ
552 (National Institute of Health, US) using a predefined pixel range for each cell type (400 to
553 infinity pixels, macrophages; 0 to 150 pixels, parasites; 100 to 200 pixels, CFSE labeled
554 parasites in case of mixed infection assay).

555
556 **Microscopic analyses.** *Giemsa staining analysis.* Parasites (1×10^6) were settled on poly-L-
557 lysine coated glass slides and air-dried overnight. The dried cells were fixed with methanol and
558 stained with Giemsa solution (Sigma) for 10 min. After rinsing with water and air-drying, the
559 slides were mounted with Immersol 518N (Carl Zeiss) and observed under an Axioplan 2 wide
560 field light microscope (Carl Zeiss). The acquired images were analyzed by Zeiss Axiovision
561 release 4.7 (Carl Zeiss) or Openlab v3.0 (Improvision).

562 *Scanning electron microscopy.* Parasites were washed twice in ice-cold PBS and then
563 fixed with 2% (w/v) glutaraldehyde (Sigma) in PBS with 0.1 M sodium cacodylate (pH 7.2).
564 Briefly, the fixed cells were treated with 1% (w/v) OsO₄ and dehydrated followed by critical-
565 point drying (CPD 7501, Polaron) and coated with gold powder (Ion Beam Coater 681, Gatan).
566 Samples were visualized with scanning electron microscope SEM 500 (Philips). For
567 cytoskeleton analysis, cells were treated with 1% Triton X-100 at 4°C in PBS for 10 minutes to
568 strip the plasma membrane and visualize the cytoskeleton. The samples were then washed
569 twice in PBS, fixed in glutaraldehyde and processed for scanning electron microscopy in
570 standard conditions as described (Absalon *et al.*, 2008).

571 *Transmission electron microscopy.* Parasites were washed twice in ice-cold PBS and
572 then fixed with 2% (v/v) glutaraldehyde (Sigma) in PBS with 0.1 M sodium cacodylate (pH

573 7.2). The fixed cells were post-fixed in 1% (w/v) OsO₄ and then dehydrated with increasing
574 ethanol concentrations (70–100%) and embedded in EPON epoxy resin (Hexion Speciality
575 Chemicals). Ultrathin sections (~70 nm) were prepared using an Ultramicrotome (Ultra Cut E;
576 Reichert/Leica) and stained with uranyl acetate and lead citrate. Sections were analyzed using
577 the Tecnai Spirit TEM (FEI).

578
579 **Annexin V-FITC assay.** Parasites (2×10^7 cells) were washed and resuspended in 100 μ l of
580 binding buffer containing 100 μ g/ml of FITC conjugated annexin V (a gift from Dr. Aude
581 Foucher, Photeomix, Paris), 1 μ g/ml of PI, 10 mM HEPES (pH 7.4), 140 mM NaCl and 5 mM
582 CaCl₂. The suspensions were incubated at room temperature for 10 min in the dark. The stained
583 cells were subjected to FACS analysis ($\lambda_{\text{ex}} = 488$ nm; $\lambda_{\text{em}} = 515$ nm [FITC] and 617 nm [PI])
584 with a FACSCaliburTM (BD Biosciences). 10,000 events were analyzed using FlowJo 8.7 (Tree
585 Star).

586
587 **SYBR Green-based semi-quantitative RT-PCR.** SHERP cDNA was amplified using forward
588 primer CGACAAGATCCAGGAGCTGAAGGAC and reversed primer
589 CCTTGATGCTCTCAACCGTGCTG). Beta actin cDNA was amplified as reference gene to
590 calculate relative expression levels of SHERP mRNA.

591
592 **Motility analysis.** For each condition, at least 3 movies were recorded (500 frames at 33 ms of
593 exposure for 16 s movies). Samples were observed in their respective culture media (cell
594 density of about 5×10^6 cells/ml in logarithmic phase or 10^7 cells/ml in stationary phase) under
595 a 10 \times objective of an inverted DMI4000 microscope (Leica). Cells were filmed using a
596 numeric camera Photometrics Evolve 512 (Photometrics). Movies were converted with the
597 MPEG Streamclip V1.9b3 software (Squared 5) and analyzed with the ICY software

598 (<http://www.bioimageanalysis.org/>). For each movie, at least 255 cells were simultaneously
599 tracked *in silico*. Mean speeds (in $\mu\text{m/s}$) were calculated from instant velocity data transferred
600 and compiled in Microsoft Excel. Statistical analyses were performed in the KaleidaGraph
601 V4.0 software (Synergy Software). Data were first filtered (number of spot detections > 3 and
602 mean speed $< 100 \mu\text{m/s}$) to exclude false tracks (non-*Leishmania* objects, dead cells and/or
603 attached cells). An ANOVA test was then performed with Tukey ad-hoc post-tests at 0.5 for
604 intergroup comparisons ($p < 0.0001$).

605
606 ***Leishmania* phosphoprotein enrichment.** Promastigotes, axenic amastigotes, and splenic
607 amastigotes derived from *Leishmania* infected hamsters, were centrifuged at $1000 \times g$ at 4°C
608 for 10 min. Pellets were washed twice with plain M199 medium, then resuspended in lysis
609 buffer (150 mM NaCl, 50 mM Tris-HCl pH 7.4, 1% Triton X-100, 1% benzonase, and protease
610 inhibitor cocktail [Roche]) and lysed at 4°C for 30 min with vortexing every 10 min. The lysate
611 was then sonicated on ice for 5 min (10 seconds pulse with a 20 seconds pause) using Bioruptor
612 (Diagenode). Cell debris was removed by brief centrifugation. Protein concentration of lysates
613 was estimated by RC DC protein assay (Bio-rad) and adjusted to 0.1 mg protein/ml with lysis
614 buffer. Phosphoprotein was enriched using the Phosphoprotein purification kit (Qiagen)
615 according to the manufacturer's instructions. Briefly, 2.5 mg of total protein were loaded to the
616 equilibrated columns. Unbound proteins were removed by washing the column with 6 ml of
617 lysis buffer. Bound phosphorylated proteins were eluted with 2 ml elution buffer and
618 concentrated using Amicon Ultra-0.5 ml centrifugal filters with Ultracel[®] 10K membrane
619 (Millipore).

620
621 **Phosphopeptide identification.** Cell lysate extracted from transgenic *L. donovani* expressing
622 Strep::CyP40 (refer to supporting information) was separated by SDS-PAGE. Separated

623 Strep::CyP40 was trypsin-digested and diluted in loading buffer (80% ACN, 5% TFA). The
624 sample was then processed for LC-ESI-MS/MS analysis to identify phosphorylation sites, as
625 described (Morales *et al.*, 2010). Briefly, digested protein was diluted in loading buffer (80%
626 ACN, 5% TFA) and loaded on TiO₂ microcolumns. After two washing steps in 10 µl loading
627 buffer and 60 µl buffer 2 (80% ACN, 1% TFA), phosphopeptides were eluted using 10 µl
628 NH₄OH (pH 12), dried, then resuspend in 10 ul of 0.1% formic acid before analyzing with a Q-
629 TOF mass spectrometer (Maxis; Bruker Daltonik GmbH, Bremen, Germany), interfaced with a
630 nano-HPLC U3000 system (Thermo Scientific, Waltham, USA). Samples were concentrated
631 with a pre-column (Thermo Scientific, C18 PepMap100, 300 µm × 5 mm, 5 µm, 100 Å) at a
632 flow rate of 20 µL/min using 0.1% formic acid. After pre-concentration, peptides were
633 separated with a reversed-phase capillary column (Thermo Scientific, C18 PepMap100, 75 µm
634 × 250 mm, 3 µm, 100 Å) at a flow rate of 0.3 µL/min using a two-step gradient (8 % to 28 %
635 acetonitrile in 40 min then 28 % to 42 % in 10 min), and eluted directly into the mass
636 spectrometer. Proteins were identified by MS/MS by information-dependent acquisition of
637 fragmentation spectra of multiple charged peptides and MS/MS raw data were analysed using
638 Data Analysis software (Bruker Daltonik GmbH, Bremen, Germany) to generate the peak lists.
639 The *L. major* database from GeneDB was searched using MASCOT software (Matrix Science,
640 London, UK) with the following parameters: trypsin cleavage, one missed cleavage sites
641 allowed, carbamidomethylation set as fixed modification, 10 ppm mass tolerance for MS, and
642 0.05 Da for MS/MS fragment ions. Phosphorylation (ST), Phosphorylation (Y) and oxidation
643 (M) were allowed as variable modifications. All phosphorylated peptides were first checked for
644 the presence of the major fragment ion [MH-H₃PO₄]⁺ = MH - 98 Da corresponding to the loss
645 of the phosphate moiety and identified positively by MASCOT. In addition, all MS/MS spectra
646 were carefully checked manually for assignment of phosphorylation sites.

647

648 **Western blot analysis.** Samples in 1 × Laemmli buffer were separated by 10% SDS-PAGE
649 and then transferred to PVDF membranes. Rabbit anti-CyP40 antiserum (1:20000 dilution, Yau
650 *et al.*, 2010), mouse anti-A2 antibody (clone C9, 1:50 dilution, Zhang *et al.*, 1996), mouse anti-
651 LPG antibody (clone CA74E, 1:20000 dilution, Tolson *et al.*, 1994), mouse anti- α -tubulin
652 antibody (clone B-5-1-2, 1:20000 dilution, Sigma), goat anti-mouse HRP conjugated antibody
653 (1:20000 dilution, Thermo Scientific) and goat anti-rabbit HRP conjugated antibody (1:20000
654 dilution, Thermo Scientific) were used to probe the membrane. SuperSignal West Pico
655 chemiluminescent substrate (Thermo Scientific) was added to the membranes and
656 chemiluminescent signals were revealed on X-ray films.

657
658 **2D-DIGE analysis.** The analysis was performed as previously described (Pescher et al, 2011).
659 Briefly, 50 μ g of G-Dye-labeled total protein extracts from wild-type and *cyp40*^{-/-}
660 promastigotes from stationary growth phase were separated in the first dimension by IEF on 18
661 cm pH 4 to 7 IPG strips, and the second dimension by SDS-PAGE. Three gels representing
662 independent experimental replicates were scanned with a Typhoon imager and analyzed with
663 the DeCyderTM software package from GE Healthcare. Gels were stained with Lava purple,
664 revealed by scanning on a Typhoon imager, and differentially expressed proteins were
665 subjected to MS analysis.

666
667 **Statistical analysis.** Numerical data were expressed as mean \pm standard deviation. Mann-
668 Whitney U test was used to compare the significance between specific groups and $p < 0.05$ was
669 considered as statistically significant. All statistical analysis was performed using either Excel
670 2003 (Microsoft) or Prism 5.0 (GraphPad).

671
672 **Acknowledgments**

673 We thank Dirk Schmidt-Arras (University of Kiel), Gabi Ommen, Mareike Chrobak and
674 Christel Schmetz (Bernhard Nocht Institute, Hamburg) for discussion, Eric Prina for critical
675 reading of the manuscript, Claire Forestier and Evie Melanitou (Institut Pasteur) for advices on
676 macrophage experiment, Emanuelle Perret from the Institut Pasteur Imaging platform for
677 advice on fluorescence microscopy, and Abdelkader Namane, Pascal Normand, and Christine
678 Laurent from the Institut Pasteur Proteomics platform for protein determination and
679 quantitative analysis of the 2D-DIGE gels. This work was supported by the Institut Pasteur,
680 Réseau International des Instituts Pasteur, Centre Nationale de Recherche Scientifique, the 7th
681 Framework Programme of the European Commission through a grant to the LEISHDRUG
682 Project (223414), the Fondation de Médicale Recherche and Deutscher Akademischer
683 Austausch Dienst, and the French Government's Investissements d'Avenir program:
684 Laboratoire d'Excellence 'Integrative Biology of Emerging Infectious Diseases' (grant no.
685 ANR-10-LABX-62-IBEID).

686

687

688

689 **Figure legends**

690 **Fig 1. *L. donovani* CyP40 is a conserved chaperone and shows amastigote-specific**
691 **phosphorylation.** (A) *Amino acid sequence analysis of Leishmania CyP40.* Multiple alignment
692 of CyP40 amino acid sequences of mammal (human, mouse and bovine), trypanosomatid
693 (*Leishmania* and *Trypanosoma*) and yeast was performed using ClustalW as described in
694 experimental procedures. CLD/PPIase (cyclophilin-like domain/PPIase) and TPR domains are
695 indicated. Degree of residue conservation is represented by the colour code (green, 80-100%
696 conserved; yellow, 30-80% conserved; red, 10-30% conserved). *, key residues for cyclosporin
697 A binding and PPIase activity; ^, key residues for chaperone function; Δ, key residues for

698 HSP90 binding. Accession numbers: M.mus, NP_080628.1; H.sap, NP_005029.1; B. tau,
699 NP_776578.1; S.cer, NP_013317.1; T.cru, TcCLB.506885.400; T.bru, Tb927.9.9780; L.bra,
700 LbrM34.4730; L.mex, LmxM34.4770; L.inf, LinJ35.4830; L.maj, LmjF35.4770. (B) *Western*
701 *blot analysis*. Phosphoproteins of *in vitro* cultivated *L. donovani* promastigote (pro), axenic
702 amastigote (ax. ama, ax), and amastigotes harvested from infected hamster spleen (sp) were
703 enriched using a Phosphoprotein purification kit (Qiagen). Total and phosphoprotein extracts
704 were analyzed by Western blotting using anti-CyP40 antiserum and anti- α -tubulin antibody for
705 normalization.

706
707 **Fig. 2. CyP40 null mutant parasites are viable in culture.** (A) *Targeted replacement and*
708 *add-back strategies*. Targeting constructs comprising bleomycin (*BLE*) and puromycin (*PAC*)
709 resistance genes flanked by the *CYP40* 5' and 3' untranslated regions (UTRs) were used for
710 deletion of the genomic *CYP40* alleles. A targeting construct containing the nourseothricin
711 resistance gene (*SAT*) and the *Leishmania major* *CYP40* open reading frame (ORF) flanked by
712 the *L. major* small ribosomal subunit homology regions (*LmSSU*) were used for restoring
713 CyP40 expression in the *cyp40*^{-/-} parasites. Primers specific for amplifying *CYP40* (P1/P4), the
714 resistance genes *PAC* (P2/P4) and *BLE* (P3/P4), and the *SSU* locus (P1/P5) are indicated. (B)
715 *Validation of homologous recombination events by PCR analysis*. Genomic DNA of wild-type
716 (WT), heterozygous CyP40 null mutant (-/+), homozygous CyP40 null mutant (-/-) and CyP40
717 add-back (-/-+) was subjected to diagnostic PCR analysis using the indicated primer pairs
718 (P_xP_y) to amplify the endogenous CyP40 ORF (*CYP*), the *CYP40* ORF integrated into the
719 ribosomal locus (*SSU*), and the bleomycin (*BLE*) and puromycin (*PAC*) resistance genes. (C)
720 *Western blot analysis*. Total protein from wild-type (WT) and CyP40 null mutant (-/-) and add-
721 back (-/-+) were extracted and analyzed by western blotting using anti-CyP40 (CyP, upper

722 panel) and anti- α -tubulin antibodies (Tub, lower panel). The molecular weight of marker
723 proteins in kDa is indicated.

724

725 **Fig. 3. Stationary *cyp40*^{-/-} promastigotes show altered morphology.** (A, B) *Electron*
726 *microscopy analysis*. Promastigotes from stationary growth phase were fixed and processed for
727 either scanning (A) or transmission EM (B) as described in Materials and Methods. Scale bar
728 represents 10 μ m in the scanning EM panels and 500 nm in the transmission EM panels. n,
729 nucleus; m, mitochondria; k, kinetoplast; f, flagellum; fp, flagellar pocket; l, lipid droplet. (C)
730 *Cell viability determination*. Stationary promastigotes of wild-type (WT) and *cyp40*^{-/-} (-/-)
731 from 6 days cultures were stained with propidium iodide (PI, 1 μ g/ml) and annexin V-FITC (1
732 μ g/ml) for 10 min, and respective fluorescence intensities were analyzed by FACS. Numbers at
733 the lower-right quadrant represent percentage of apoptotic cells (PI⁻, Annexin V-FITC⁺), while
734 numbers at the upper-right quadrant represent percentage of dead cells (PI⁺, Annexin V-
735 FITC⁺).

736

737 **Fig 4. Growth characterization of Cyp40 null mutant promastigotes.** (A) *In vitro growth*
738 *curve of cyp40*^{-/-} *mutants*. Promastigotes of wild-type (WT), *cyp40*^{-/-} (-/-) and *cyp40*^{-/+} (-/+) were
739 cultured at 25°C, pH 7.4 for 120 hours. Aliquots of culture were collected every 24 hours
740 and cell density was measured with a CASY cell counter. (B) *Western blot analysis of LPG*
741 *expression*. 5×10^6 wild-type or *cyp40*^{-/-} parasites from logarithmic (log) or stationary (stat)
742 cell culture were subjected to western blot analysis using anti-LPG antibody. (C) *RT-PCR of*
743 *SHERP expression*. Total RNA of the wild-type (black), *cyp40*^{-/-} (white) and *cyp40*^{-/+} (gray)
744 were extracted, reverse transcribed, and amplified with SHERP specific primer. β -tubulin was
745 amplified with specific primers as reference gene. Relative expression levels of SHERP mRNA
746 was analyzed using semi-quantitative RT-PCR.

747

748 **Fig. 5. Analyses of motility and cytoskeleton of stationary phase *cyp40*^{-/-} promastigote.** (A,
749 *B*) *Motility analysis.* Motility tracks were established for logarithmic (log) and stationary phase
750 (stat) wild-type (WT), *cyp40*^{-/-} (-/-) and *cyp40*^{-/-/+} (-/-/+) promastigotes. For each condition, at
751 least 3 movies were recorded for the simultaneous *in silico* tracking of at least 255 cells per
752 movie. Mean speed (in $\mu\text{m/s}$) was calculated from instant velocity data and graphically
753 represented in left panel with SD bars. *ANOVA test, $p < 0.0001$. $n=735$ for WT Log and 737
754 for WT Stat, $n=746$ for -/- Log and 747 for -/- Stat, $n=741$ for -/-/+ Log and 742 for -/-/+ Stat.
755 Characteristic tracks are shown in Fig. 5B. (C) *Flagellar ultrastructure of stationary WT and*
756 *cyp40*^{-/-} *promastigotes.* Scale bar represents 100 nm. (D) *Cytoskeleton analysis.* Wild-type
757 (WT) and *cyp40*^{-/-} (-/-) stationary promastigotes were treated with 1% Triton X-100 at 4°C in
758 PBS for 10 minutes to strip the plasma membrane and visualize the parasite cytoskeleton.
759 Samples were washed twice in PBS, fixed and processed for scanning electron microscopy as
760 described (Absalon *et al.*, 2008). Scale bar represents 100 nm. (E) *2D-DIGE analysis.* The
761 readout of the DeCyder Biological Variation Analysis (BVA) module is shown for a small β -
762 tubulin isoform that shows four-fold reduced abundance in the null mutant abundance. The
763 upper panels represent 3D images of the volumes of the spots from wild-type (WT) and *cyp40*^{-/-}
764 *-/-* (-/-). The bottom panel shows a graphic representation of differences in abundance across
765 three independent experiments. The numbers indicate the fold difference in abundance of
766 *cyp40*^{-/-} to WT.

767

768 **Fig. 6. Intracellular survival and axenic differentiation of the *cyp40*^{-/-} null mutants.** (A)
769 *Macrophage infection assay.* BMMs from C57BL/6 mice were infected with stationary phase
770 promastigotes of *L. donovani* wild-type (WT, O), *cyp40*^{-/-} (clone 4, □, and 5, ■) or *cyp40*^{-/-/+}
771 (Δ) for 2 hours, and parasite burden was analyzed at 0, 24 and 48 hours post-infection by

772 nuclear staining with Hoechst 33342 and fluorescence microscopy. Results are representative
773 of three triplicate experiments with standard deviation denoted by the bars is shown. (B) In
774 vitro growth curve of *cyp40*^{-/-} axenic amastigotes. Promastigotes of wild-type (WT), *cyp40*^{-/-}
775 (-/-) and *cyp40*^{-/-/+} (-/-/+) were induced for axenic differentiation at 37°C, pH 5.5 for 72 hours,
776 and amastigote growth was monitored following inoculation of 2×10^6 axenic amastigotes into
777 fresh medium and daily determination of cell density with a CASY cell counter. (C) A2 marker
778 protein expression analysis. Extracts from wild-type (WT), *cyp40*^{-/-} (-/-) and *cyp40*^{-/-/+} (-/-/+) axenic
779 amastigotes 72 hours after incubation under differentiation-inducing conditions were
780 subjected to western blot analysis using an axenic amastigote marker A2-specific monoclonal
781 antibody (upper panel). Equal loading was controlled by Coomassie staining of an acrylamide
782 gel loaded with equivalent quantity of the samples (lower panel). The molecular weight of
783 marker proteins in kDa is indicated.

784

785 **Fig 7. Effect of phosphorylation of CyP40 on *Leishmania* intracellular survival.** (A, B)
786 *Phosphorylation site identification.* (A) Peptide 270LQQWSEAR277 (m/z 1098.49) was
787 identified in LC-ESI-MS/MS analysis of *L. major* Strep::CyP40 peptides after tryptic digestion
788 and TiO₂ enrichment and Ser274 was identified as a phosphorylated residue. *, fragment ions
789 arising from loss of ammonia (-17 Da); pS, phosphorylated serine. (B) *Multiple sequence*
790 *alignment of L. major CyP40 phospho-residue.* Sequence segments encompassing CyP40
791 phosphorylation site of mouse, human, bovine, yeast, two *Trypanosoma* (*T. cruzi*, *T. brucei*),
792 four *Leishmania* species (*L. braziliensis*, *L. mexicana*, *L. infantum*, *L. major*) were analyzed
793 with ClustalW. The phospho-residue Ser274 of *L. major* CyP40 is marked by an asterisk (*).
794 (C) *Analysis of the CyP40-S274A add-back line by western blotting.* Total protein (left panel)
795 from wild-type (WT), CyP40 null mutant (-/-) , CyP40 add-back lines Cyp40-WT and CyP40-
796 S274A (-/-/+ and S274A, respectively), and enriched phosphoprotein extracts (right panel) of

797 axenic amastigotes of *L. donovani* wild-type (WT) and *cyp40*^{-/-/+S274A} (S274A) were
798 analyzed. As background control of the phosphoprotein enrichment, 2 mg of the WT total
799 extract were first treated with 8000 units of lambda phosphatase (LPP) for 2 hours at 30°C. The
800 LPP-treated sample was then subjected to phosphoprotein enrichment. The total and
801 phosphoprotein (Phospho) extracts of the parasites were analyzed by Western blotting using
802 anti-CyP40 antiserum and anti- α -tubulin antibody. The molecular weight of marker proteins in
803 kDa is indicated. (D) *Macrophage infection assay*. BMMs from C57BL/6 mice were infected
804 for 2 hours with stationary phase promastigotes of *L. donovani* wild-type (WT, ○), *cyp40*^{-/-} (-/-
805 , □) or CyP40-WT and CyP40-S274A add-backs (respectively -/-/+, Δ and -/-/+S/A, ▼) and
806 parasite burden was at 0, 24 and 48 hours post-infection by nuclear staining with Hoechst
807 33342 and fluorescence microscopy. Result is presented as percentage infected BMMs (left
808 panel, one representative triplicate experiment with standard deviation denoted by the bars is
809 shown), and number of parasites per 100 BMMs at 48 hours post-infection (right panels, results
810 of one representative triplicate experiment with standard deviation denoted by the bars is
811 shown).

812

813

814

815 **References**

816 Absalon, S., Blisnick, T., Bonhivers, M., Kohl, L., Cayet, N., Toutirais, G., *et al.* (2008)

817 Flagellum elongation is required for correct structure, orientation and function of the
818 flagellar pocket in *Trypanosoma brucei*. *J Cell Sci* **121**: 3704-3716.

819 Barak, E., Amin-Spector, S., Gerliak, E., Goyard, S., Holland, N. and Zilberstein, D. (2005)

820 Differentiation of *Leishmania donovani* in host-free system: analysis of signal perception
821 and response. *Mol Biochem Parasitol* **141**: 99-108.

- 822 Barik, S. (2006) Immunophilins: for the love of proteins. *Cell Mol Life Sci* **63**: 2889-2900.
- 823 Bates, P.A., and Tetley, L. (1993) *Leishmania mexicana*: Induction of metacyclogenesis by
824 cultivation of promastigotes at acidic pH. *Exp Parasitol* **76**: 412-423.
- 825 Brasseur, A., Rotureau, B., Vermeersch, M., Blisnick, T., Salmon, D., Bastin, P., Pays, E.,
826 Vanhamme, L., and Pérez-Morga, D. (2013) *Trypanosoma brucei* FKBP12 differentially
827 controls motility and cytokinesis in procyclic and bloodstream forms. *Euk Cell* **12**: 168-181.
- 828 Chambraud, B., Belabes, H., Fontaine-Lenoir, V., Fellous, A. and Baulieu, E.E. (2007) The
829 immunophilin FKBP52 specifically binds to tubulin and prevents microtubule formation.
830 *FASEB J* **21**: 2787-2797.
- 831 Chappell, L.H. and Wastling, J.M. (1992) Cyclosporin A: antiparasite drug, modulator of the
832 host-parasite relationship and immunosuppressant. *Parasitology* **105 Suppl**: S25-40.
- 833 Cunningham, M.L., Titus, R.G., Turco, S.J. and Beverley, S.M. (2001) Regulation of
834 differentiation to the infective stage of the protozoan parasite *Leishmania major* by
835 tetrahydrobiopterin. *Science* **292**: 285-287.
- 836 da Silva, R. and Sacks, D.L. (1987) Metacyclogenesis is a major determinant of *Leishmania*
837 promastigote virulence and attenuation. *Infect Immun* **55**: 2802-2806.
- 838 Drummel-Smith, J., Brochu, V., Girard, I., Messier, N. and Ouellette, M. (2003) Proteome
839 mapping of the protozoan parasite *Leishmania* and application to the study of drug targets
840 and resistance mechanisms. *Mol Cell Proteomics* **2**: 146-155.
- 841 Duina, A.A., Marsh, J.A. and Gaber, R.F. (1996) Identification of two CyP-40-like cyclophilins
842 in *Saccharomyces cerevisiae*, one of which is required for normal growth. *Yeast* **12**: 943-952.
- 843 Forestier, C.L., Machu, C., Loussert, C., Pescher, P. and Spath, G.F. (2011) Imaging host cell-
844 *Leishmania* interaction dynamics implicates parasite motility, lysosome recruitment, and
845 host cell wounding in the infection process. *Cell Host Microbe* **9**: 319-330.

- 846 Galigniana, M.D., Radanyi, C., Renoir, J.M., Housley, P.R., and Pratt, W.B. (2001) Evidence
847 that the peptidylprolyl isomerase domain of the hsp90-binding immunophilin FKBP52 is
848 involved in both dynein interaction and glucocorticoid receptor movement to the nucleus. *J*
849 *Biol Chem* **276**: 14884–14889.
- 850 Galigniana, M.D., Morishima, Y., Gallay, P.A., and Pratt, W.B. (2004) Cyclophilin-A is bound
851 through its peptidylprolyl isomerase domain to the cytoplasmic dynein motor protein
852 complex. *J Biol Chem* **279**: 55754–55759.
- 853 Gannavaram, S., and Debrabant, A. (2012) Programmed cell death in *Leishmania*: biochemical
854 evidence and role in parasite infectivity. *Front Cell Infect Microbiol* **2**: 95.
- 855 Goyard, S., Segawa, H., Gordon, J., Showalter, M., Duncan, R., Turco, S.J. and Beverley, S.M.
856 (2003) An *in vitro* system for developmental and genetic studies of *Leishmania donovani*
857 phosphoglycans. *Mol Biochem Parasitol* **130**: 31-42.
- 858 Hem, S., Gherardini, P.F., Osorio y Fortea, J., Hourdel, V., Morales, M.A., Watanabe, R., *et al.*
859 (2010) Identification of *Leishmania*-specific protein phosphorylation sites by LC-MS/MS
860 and comparative genomics analyses. *Proteomics* **10**: 3868-3883.
- 861 Henikoff, S., and Henikoff, J.G. (1993) Performance evaluation of amino acid substitution
862 matrices. *Proteins* **17**: 49–61.
- 863 Hoffmann, K. and Handschumacher, R.E. (1995) Cyclophilin-40: evidence for a dimeric
864 complex with hsp90. *Biochem J* **307**: 5-8.
- 865 Hombach, A., Ommen, G., Chrobak, M., and Clos, J. (2012) The Hsp90-Sti1 Interaction is
866 Critical for *Leishmania donovani* Proliferation in Both Life Cycle Stages. *Cell Microbiol*
867 (Epub ahead of print)
- 868 Hong, J., Kim, S.T., Tranguch, S., Smith, D.F., and Dey, S.K. (2007) Deficiency of co-
869 chaperone immunophilin FKBP52 compromises sperm fertilizing capacity. *Reproduction*
870 **133**: 395–403.

- 871 Hoyer, C., Zander, D., Fleischer, S., Schilhabel, M., Kroener, M., Platzer, M. and Clos, J. (2004)
872 A *Leishmania donovani* gene that confers accelerated recovery from stationary phase growth
873 arrest. *Int J Parasitol* **34**: 803-811.
- 874 Hubel, A., Krobitch, S., Horauf, A. and Clos, J. (1997) *Leishmania major* Hsp100 is required
875 chiefly in the mammalian stage of the parasite. *Mol Cell Biol* **17**: 5987 - 5995.
- 876 Iiki, T., Yoshikawa, M., Meshi, T., and Ishikawa, M. (2012) Cyclophilin 40 facilitates HSP90-
877 mediated RISC assembly in plants. *EMBO J* **31**: 267–278.
- 878 Kapler, G.M., Coburn, C.M. and Beverley, S.M. (1990) Stable transfection of the human
879 parasite *Leishmania major* delineates a 30-kilobase region sufficient for extrachromosomal
880 replication and expression. *Mol Cell Biol* **10**: 1084-1094.
- 881 Kearse, M., Moir, R., Wilson, A., Stones-Havas, S., Cheung, M., Sturrock, S., Buxton, S.,
882 Cooper, A., Markowitz, S., Duran, C., et al. (2012) Geneious Basic: an integrated and
883 extendable desktop software platform for the organization and analysis of sequence data.
884 *Bioinformatics* **28**: 1647–1649.
- 885 Krobitch, S., and Clos, J. (1999) A novel role for 100 kD heat shock proteins in the parasite
886 *Leishmania donovani*. *Cell Stress Chaperones* **4**: 191–198.
- 887 Kulkarni, M.M., Karafova, A., Kamysz, W., Schenkman, S., Pelle, R., and McGwire, B.S.
888 (2013) Secreted trypanosome cyclophilin inactivates lytic insect defense peptides and
889 induces parasite calcineurin activation and infectivity. *J Biol Chem* **288**: 8772–8784.
- 890 Larkin, M.A., Blackshields, G., Brown, N.P., Chenna, R., McGettigan, P.A., McWilliam, H.,
891 Valentin, F., Wallace, I.M., Wilm, A., Lopez, R., et al. (2007) Clustal W and Clustal X
892 version 2.0. *Bioinformatics* **23**: 2947–2948.
- 893 Laubach, V.E., Shesely, E.G., Smithies, O. and Sherman, P.A. (1995) Mice lacking inducible
894 nitric oxide synthase are not resistant to lipopolysaccharide-induced death. *Proc Natl Acad*
895 *Sci U S A* **92**: 10688-10692.

- 896 Lee, N., Bertholet, S., Debrabant, A., Muller, J., Duncan, R., and Nakhasi, H.L. (2002)
897 Programmed cell death in the unicellular protozoan parasite *Leishmania*. *Cell Death Differ*
898 **9**: 53–64.
- 899 Li, J., Richter, K. and Buchner, J. (2011) Mixed Hsp90-cochaperone complexes are important
900 for the progression of the reaction cycle. *Nat Struct Mol Biol* **18**: 61-66.
- 901 Mark, P.J., Ward, B.K., Kumar, P., Lahooti, H., Minchin, R.F. and Ratajczak, T. (2001) Human
902 cyclophilin 40 is a heat shock protein that exhibits altered intracellular localization
903 following heat shock. *Cell Stress Chaperones* **6**: 59-70.
- 904 Miyata, Y., Chambraud, B., Radanyi, C., Leclerc, J., Lebeau, M.C., Renoir, J.M., Shirai, R.,
905 Catelli, M.G., Yahara, I., and Baulieu, E.E. (1997) Phosphorylation of the
906 immunosuppressant FK506-binding protein FKBP52 by casein kinase II: regulation of
907 HSP90-binding activity of FKBP52. *Proc Natl Acad Sci U S A* **94**: 14500–14505.
- 908 Mojtahedi, Z., Clos, J. and Kamali-Sarvestani, E. (2008) *Leishmania major*: Identification of
909 developmentally regulated proteins in procyclic and metacyclic promastigotes. *Exp*
910 *Parasitol* **119**: 422-429.
- 911 Mok, D., Allan, R.K., Carrello, A., Wangoo, K., Walkinshaw, M.D., and Ratajczak, T. (2006)
912 The chaperone function of cyclophilin 40 maps to a cleft between the prolyl isomerase and
913 tetratricopeptide repeat domains. *FEBS Lett* **580**: 2761–2768.
- 914 Morales, M.A., Renaud, O., Faigle, W., Shorte, S.L. and Spath, G.F. (2007) Over-expression of
915 *Leishmania major* MAP kinases reveals stage-specific induction of phosphotransferase
916 activity. *Int J Parasitol* **37**: 1187-1199.
- 917 Morales, M.A., Watanabe, R., Laurent, C., Lenormand, P., Rousselle, J.C., Namane, A. and
918 Spath, G.F. (2008) Phosphoproteomic analysis of *Leishmania donovani* pro- and amastigote
919 stages. *Proteomics* **8**: 350-363.

- 920 Morales, M.A., Watanabe, R., Dacher, M., Chafey, P., Osorio y Fortea, J., Scott, D.A., *et al.*
921 (2010) Phosphoproteome dynamics reveal heat-shock protein complexes specific to the
922 *Leishmania donovani* infectious stage. *Proc Natl Acad Sci U S A* **107**: 8381-8386.
- 923 Oberholzer, M., Langousis, G., Nguyen, H.T., Saada, E.A., Shimogawa, M.M., Jonsson, Z.O.,
924 Nguyen, S.M., Wohlschlegel, J.A., and Hill, K.L. (2011) Independent analysis of the
925 flagellum surface and matrix proteomes provides insight into flagellum signaling in
926 mammalian-infectious *Trypanosoma brucei*. *Mol Cell Proteomics* **10**: M111.010538.
- 927 Ommen, G., Lorenz, S. and Clos, J. (2009) One-step generation of double-allele gene
928 replacement mutants in *Leishmania donovani*. *Int J Parasitol* **39**: 541-546.
- 929 Parodi-Talice, A., Monteiro-Goes, V., Arrambide, N., Avila, A.R., Duran, R., Correa, A., *et al.*
930 (2007) Proteomic analysis of metacyclic trypomastigotes undergoing *Trypanosoma cruzi*
931 metacyclogenesis. *J Mass Spectrom* **42**: 1422-1432.
- 932 Pearl, L.H., and Prodromou, C. (2000) Structure and *in vivo* function of Hsp90. *Curr Opin*
933 *Struct Biol* **10**: 46–51.
- 934 Pearl, L.H., and Prodromou, C. (2006) Structure and mechanism of the Hsp90 molecular
935 chaperone machinery. *Annu Rev Biochem* **75**: 271–294.
- 936 Pescher, P., Blisnick, T., Bastin, P., and Spath, G.F. (2011) Quantitative proteome profiling
937 informs on phenotypic traits that adapt *Leishmania donovani* for axenic and intracellular
938 proliferation. *Cell Microbiol* **13**: 978–991.
- 939 Pollock, J.D., Williams, D.A., Gifford, M.A., Li, L.L., Du, X., Fisherman, J., *et al.* (1995)
940 Mouse model of X-linked chronic granulomatous disease, an inherited defect in phagocyte
941 superoxide production. *Nat Genet* **9**: 202-209.
- 942 Pratt, W.B., and Dittmar, K.D. (1998) Studies with purified chaperones advance the
943 understanding of the mechanism of glucocorticoid receptor-hsp90 heterocomplex assembly.
944 *Trends Endocrinol Metab* **9**: 244–252.

- 945 Pratt, W.B., Galigniana, M.D., Harrell, J.M. and DeFranco, D.B. (2004) Role of hsp90 and the
946 hsp90-binding immunophilins in signalling protein movement. *Cell Signal* **16**: 857-872.
- 947 Ratajczak, T., Ward, B.K., and Minchin, R.F. (2003) Immunophilin chaperones in steroid
948 receptor signalling. *Curr Top Med Chem* **3**: 1348–1357.
- 949 Ratajczak, T., Ward, B.K., Cluning, C. and Allan, R.K. (2009) Cyclophilin 40: An Hsp90-
950 cochaperone associated with apo-steroid receptors. *Int J Biochem Cell Biol* **41**: 1652-1655.
- 951 Riggs, D.L., Cox, M.B., Cheung-Flynn, J., Prapapanich, V., Carrigan, P.E., and Smith, D.F.
952 (2004) Functional specificity of co-chaperone interactions with Hsp90 client proteins. *Crit*
953 *Rev Biochem Mol Biol* **39**: 279–295.
- 954 Rosenzweig, D., Smith, D., Opperdoes, F., Stern, S., Olafson, R.W. and Zilberstein, D. (2008)
955 Retooling *Leishmania* metabolism: from sand fly gut to human macrophage. *FASEB J* **22**:
956 590-602.
- 957 Sacks, D.L. and Perkins, P.V. (1984) Identification of an infective stage of *Leishmania*
958 promastigotes. *Science* **223**: 1417-1419.
- 959 Seebach, T., Hemphill, A., and Lawson, D. (1990) The cytoskeleton of trypanosomes.
960 *Parasitol Today* **6**: 49–52.
- 961 Serafim, T.D., Figueiredo, A.B., Costa, P.A.C., Marques-da-Silva, E.A., Gonçalves, R., de
962 Moura, S.A.L., Gontijo, N.F., da Silva, S.M. et al. (2012) *Leishmania* metacyclogenesis is
963 promoted in the absence of purines. *PLoS Negl Trop Dis* **6**: e1833.
- 964 Silverman, J.M., Chan, S.K., Robinson, D.P., Dwyer, D.M., Nandan, D., Foster, L.J., and
965 Reiner, N.E. (2008) Proteomic analysis of the secretome of *Leishmania donovani*. *Genome*
966 *Biol* **9**: R35.
- 967 Silverman, J.M., Clos, J., Horakova, E., Wang, A.Y., Wiesgigl, M., Kelly, I., Lynn, M.A.,
968 McMaster, W.R., Foster, L.J., Levings, M.K., et al. (2010) *Leishmania* exosomes modulate

- 969 innate and adaptive immune responses through effects on monocytes and dendritic cells. *J*
970 *Immunol* **185**: 5011–5022.
- 971 Silverstein, A.M., Galigniana, M.D., Kanelakis, K.C., Radanyi, C., Renoir, J.M., and Pratt,
972 W.B. (1999) Different regions of the immunophilin FKBP52 determine its association with
973 the glucocorticoid receptor, hsp90, and cytoplasmic dynein. *J Biol Chem* **274**: 36980–36986.
- 974 Smith, M.R., Willmann, M.R., Wu, G., Berardini, T.Z., Möller, B., Weijers, D. and Poethig,
975 R.S. (2009) Cyclophilin 40 is required for microRNA activity in Arabidopsis. *Proc Natl*
976 *Acad Sci U S A* **106**: 5424-5429.
- 977 Spath, G.F., Epstein, L., Leader, B., Singer, S.M., Avila, H.A., Turco, S.J. and Beverley, S.M.
978 (2000) Lipophosphoglycan is a virulence factor distinct from related glycoconjugates in the
979 protozoan parasite *Leishmania major*. *Proc Natl Acad Sci U S A* **97**: 9258-9263.
- 980 Tolson, D.L., Schnur, L.F., Jardim, A. and Pearson, T.W. (1994) Distribution of
981 lipophosphoglycan-associated epitopes in different *Leishmania* species and in African
982 trypanosomes. *Parasitol Res* **8**: 537-542.
- 983 Uezato, H., Kato, H., Kayo, S., Hagiwara, K., Bhutto, A., Katakura, K., Nonaka, S., and
984 Hashiguchi, Y. (2005) The attachment and entry of *Leishmania (Leishmania) major* into
985 macrophages: observation by scanning electron microscope. *J Dermatol* **32**: 534–540.
- 986 Walczak, C.E. (2000) Microtubule dynamics and tubulin interacting proteins. *Curr Opin Cell*
987 *Biol* **12**: 52–56.
- 988 Walters, L.L., Modi, G.B., Chaplin, G.L., and Tesh, R.B. (1989) Ultrastructural development of
989 *Leishmania chagasi* in its vector, *Lutzomyia longipalpis* (Diptera: Psychodidae). *Am J Trop*
990 *Med Hyg* **41**: 295–317.
- 991 Walters, L.L., Irons, K.P., Chaplin, G., and Tesh, R.B. (1993) Life cycle of *Leishmania major*
992 (Kinetoplastida: Trypanosomatidae) in the neotropical sand fly *Lutzomyia longipalpis*
993 (Diptera: Psychodidae). *J Med Entomol* **30**: 699–718.

- 994 Ward, B.K., Allan, R.K., Mok, D., Temple, S.E., Taylor, P., Dornan, J et al. (2002) A structure-
995 based mutational analysis of cyclophilin 40 identifies key residues in the core
996 tetratricopeptide repeat domain that mediate binding to Hsp90. *J Biol Chem* **277**: 40799–
997 40809.
- 998 Warth, R., Briand, P.A. and Picard, D. (1997) Functional analysis of the yeast 40 kDa
999 cyclophilin Cyp40 and its role for viability and steroid receptor regulation. *Biol Chem* **378**:
1000 381-391.
- 1001 Weisman, R., Creanor, J. and Fantes, P. (1996) A multicopy suppressor of a cell cycle defect in
1002 *S. pombe* encodes a heat shock inducible 40 kDa cyclophilin-like protein. *EMBO J* **15**: 447-
1003 456.
- 1004 Wiesgigl, M. and Clos, J. (2001) Heat Shock Protein 90 Homeostasis Controls Stage
1005 Differentiation in *Leishmania donovani*. *Mol Biol Cell* **12**: 3307-3316.
- 1006 Yau, W.L., Blisnick, T., Taly, J.F., Helmer-Citterich, M., Schiene-Fischer, C., Leclercq, O., *et*
1007 *al.* (2010) Cyclosporin A treatment of *Leishmania donovani* reveals stage-specific functions
1008 of cyclophilins in parasite proliferation and viability. *PLoS Negl Trop Dis* **4**: e729.
- 1009 Zakai, H.A., Chance, M.L. and Bates, P.A. (1998) *In vitro* stimulation of metacyclogenesis in
1010 *Leishmania braziliensis*, *L. donovani*, *L. major* and *L. mexicana*. *Parasitology* **116**: 305-309.
- 1011 Zhang, W.W., Charest, H., Ghedin, E. and Matlashewski, G. (1996) Identification and
1012 overexpression of the A2 amastigote-specific protein in *Leishmania donovani*. *Mol Biochem*
1013 *Parasitol* **78**: 79-90.
- 1014 Zilberstein, D. and Shapira, M. (1994) The role of pH and temperature in the development of
1015 *Leishmania* parasites. *Annu Rev Microbiol* **48**: 449-470.
- 1016
- 1017
- 1018

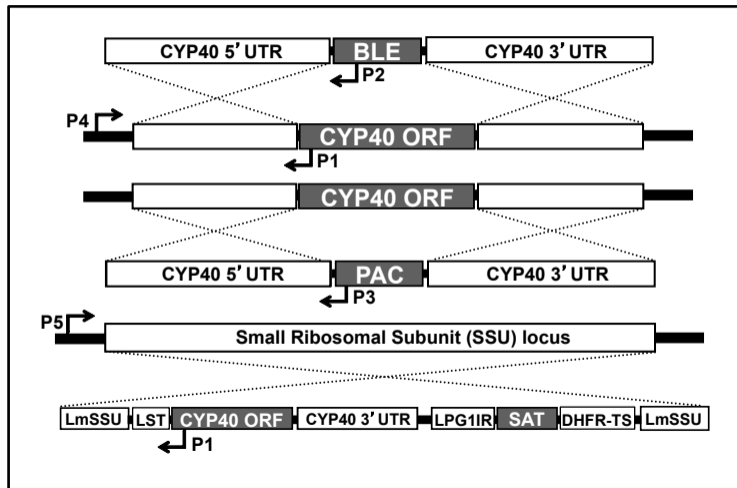
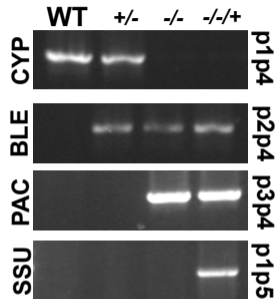
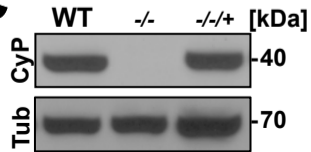
A**B****C**

A

Logarithmic

Stationary

B

Logarithmic

Stationary

C

WT

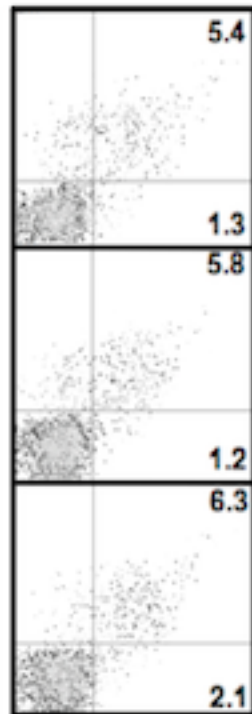
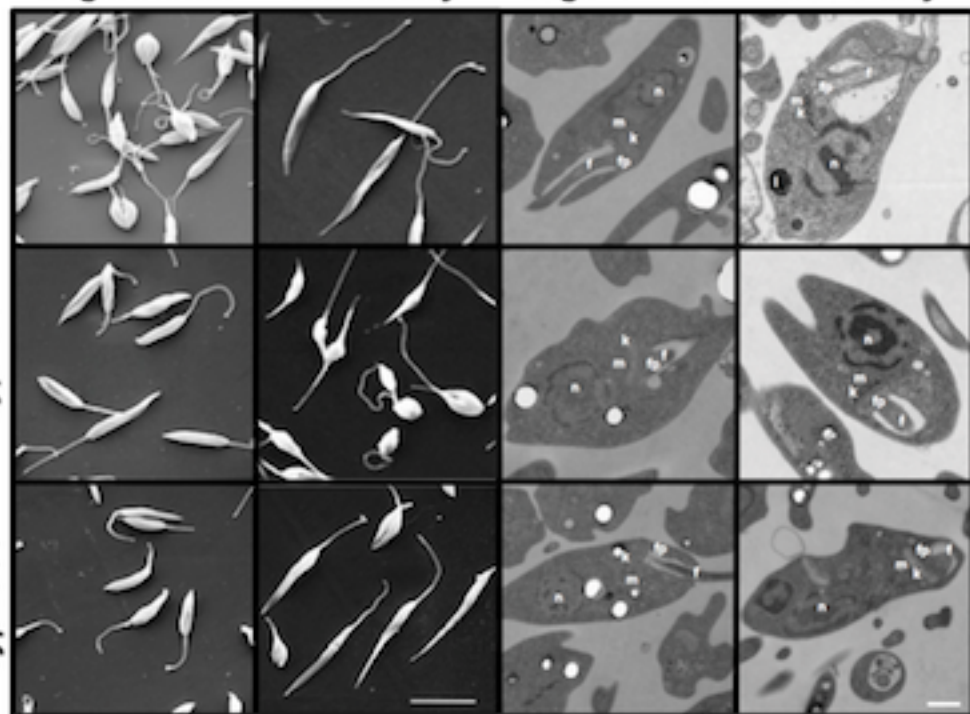
*cyp40-1-**cyp40-1-1+*

2.1

Annexin V-FITC

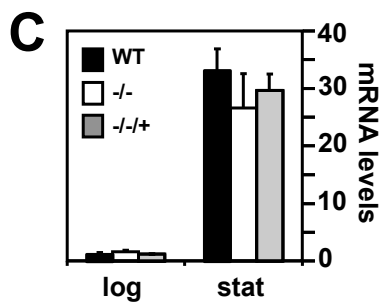
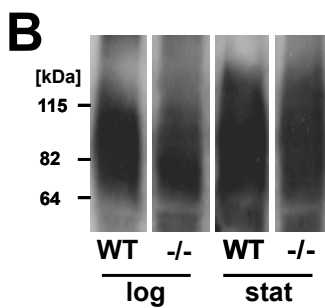
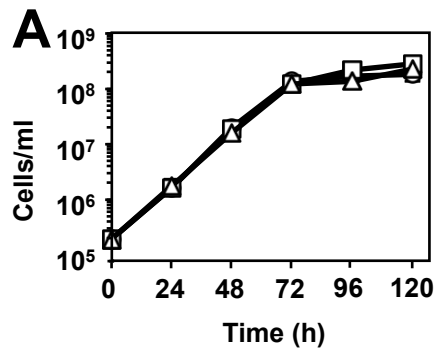

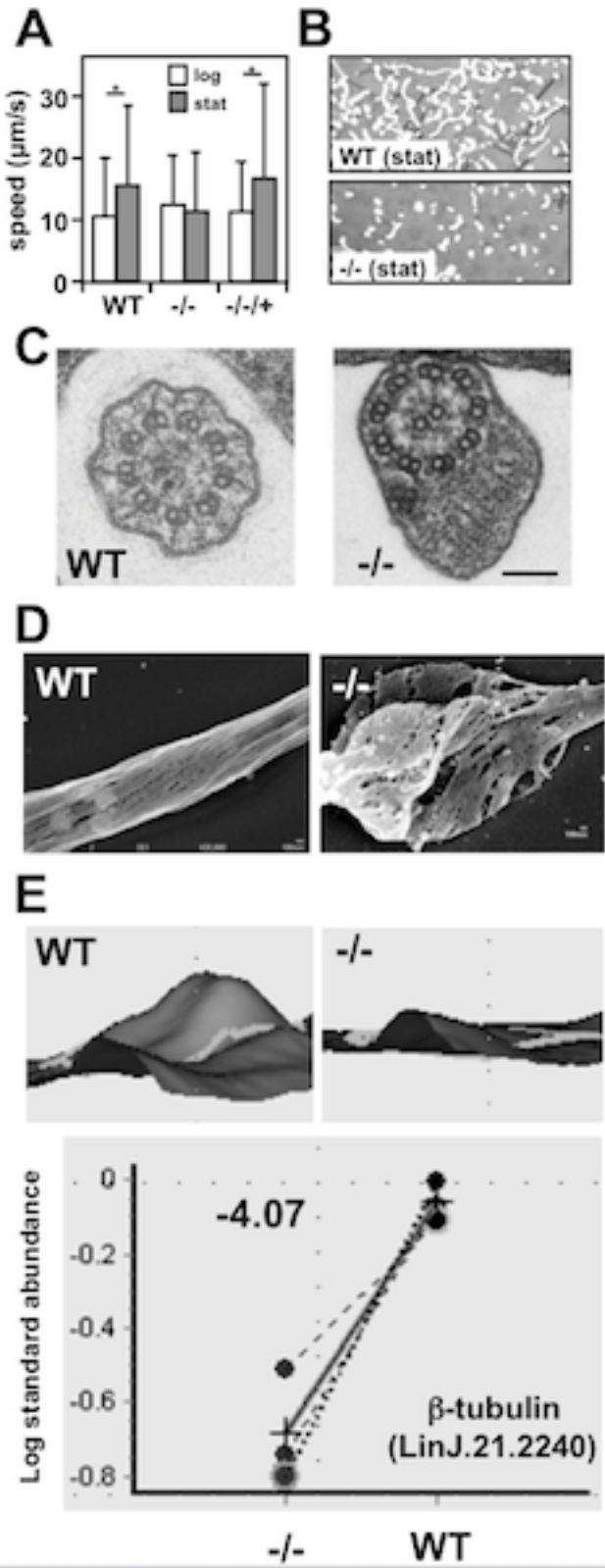

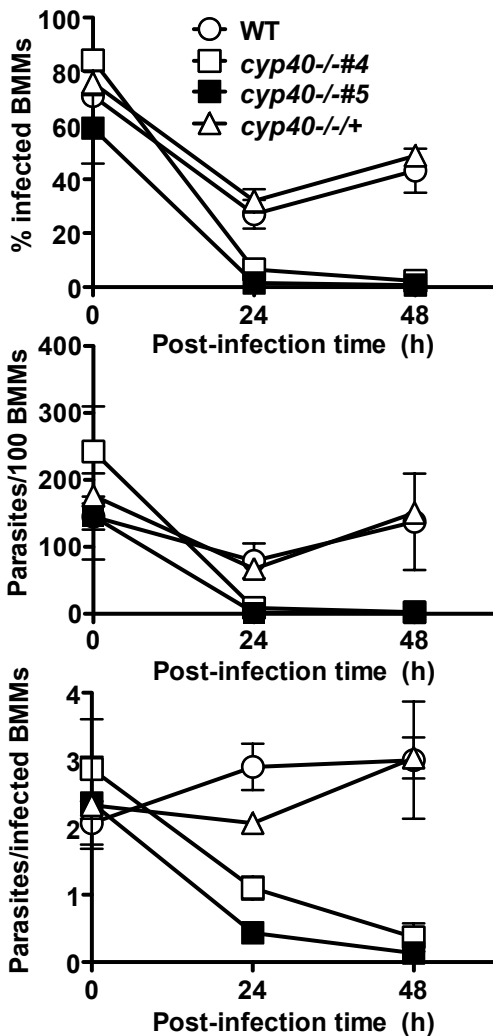
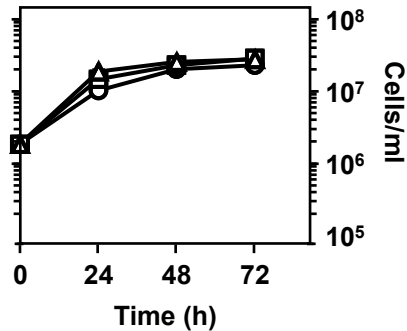
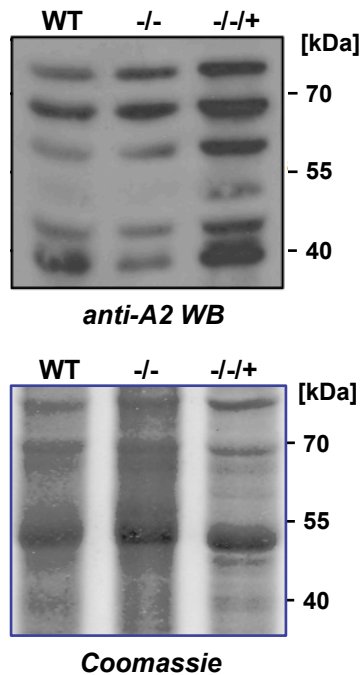
A**B****C**

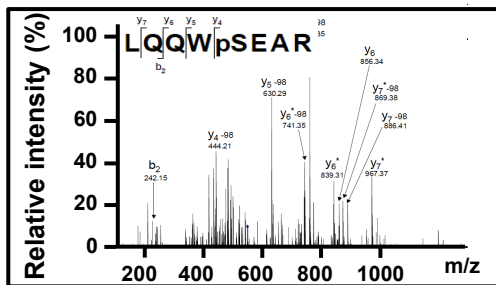
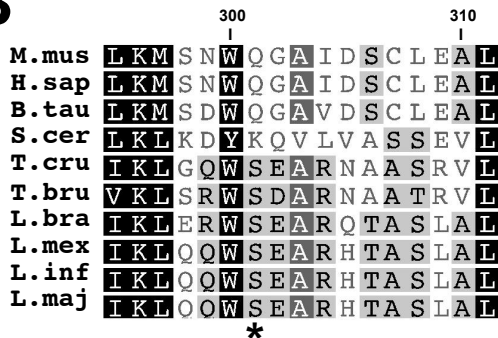
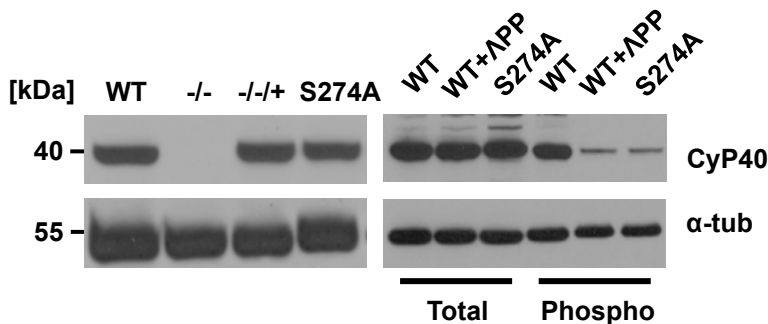
A**B****C****D**