



**HAL**  
open science

# Wireless chipless passive electromagnetic transducers for SHM applications

Patrick Pons, Hervé Aubert, Manos Tentzeris

► **To cite this version:**

Patrick Pons, Hervé Aubert, Manos Tentzeris. Wireless chipless passive electromagnetic transducers for SHM applications. International Workshop on SHM (IWSHM), Sep 2013, Stanford, United States. 8 p. <hal-01053192>

**HAL Id: hal-01053192**

**<https://hal.science/hal-01053192v1>**

Submitted on 29 Jul 2014

**HAL** is a multi-disciplinary open access archive for the deposit and dissemination of scientific research documents, whether they are published or not. The documents may come from teaching and research institutions in France or abroad, or from public or private research centers.

L'archive ouverte pluridisciplinaire **HAL**, est destinée au dépôt et à la diffusion de documents scientifiques de niveau recherche, publiés ou non, émanant des établissements d'enseignement et de recherche français ou étrangers, des laboratoires publics ou privés.



HAL Authorization

# *Wireless chipless passive electromagnetic transducers for SHM applications*

<sup>a,b</sup> Patrick PONS, <sup>a,b</sup> Hervé AUBERT, <sup>c</sup> Manos TENTZERIS

<sup>a</sup> CNRS, LAAS, 7 avenue du colonel Roche, F-31400 Toulouse, France

<sup>b</sup> Univ de Toulouse, LAAS, F-31400 Toulouse, France

<sup>c</sup> School of ECE, Georgia Institute of Technology, Atlanta, GA 30332, U.S.A

## **ABSTRACT**

The energy autonomy of wireless sensors is crucial especially for buried or inaccessible sensors that are often the case in SHM applications. This problem can be overcome by using classical passive sensors (RFID or SAW sensors) but they suffer from a problem of low reading distances (<10m). For few years emerged a new kind of passive sensors using electromagnetic transducers, combining very high autonomy, high resistance to harsh environment, potential interrogation distance higher than SAW sensors and wide variety of sensing principles. We started to work in this new research field in 2005 and several sensor principles have been validated in our lab (pressure, temperature, stress) with FMCW (Frequency Modulated Continuous Wave) Radar interrogation.

## **INTRODUCTION**

Since the late 1990s, wireless sensor networks emerge as a key technology for numerous applications (domestic, health, environmental, industrial, military, ...) [1-4] and especially for Structural Health Monitoring (SHM) [5-8]. One can divided wireless sensors technologies into two main classes: (1) active sensors which require RF transmitter and (2) passive sensors without RF transmitter.

*Active sensors* can be described by three different functional parts: a transducer which converts the input to be analyzed into electrical signal, electronic circuits for the signal conditioning and a communication unit for data transmission (Figure 1). This type of sensors works generally with a battery related to the high consumption of the transmitter. The main advantages of this kind of sensors are : a high reading distance (up to several km), a high fickleness with the possibility to use any kind of transducers, an easy identification compatible with large sensors network and a low sensitivity to electromagnetic interferences. The key limiting factor is the sensor autonomy and the sensor life time is driven by embedded quantity of energy (mainly the battery size), the data transmission rate and the reading distance. Another drawback is the low resistance to harsh environments (high temperature, high radiation level) related to the presence of electronic circuits. Then, despite the disadvantages of this type of active sensors, a lot of companies propose now wireless active sensor products that are suitable for different applications. That was made possible by the availability on the market of low cost and efficient (low consumption, low size) transducers, electronic circuits (from DC to RF) and batteries but also the availability of standardized transmission protocol (e.g., Wifi, Zigbee and Bluetooth). The main research studies in this field for increasing the sensor autonomy are concentrated on the development of new energy micro-source with high power (electrochemical, nuclear, thermo-electric, thermo-ionic, ...), high efficiency of energy harvesting (solar, vibration, thermoelectric, Radio-Frequency, ...) and low consumption electronic circuits.

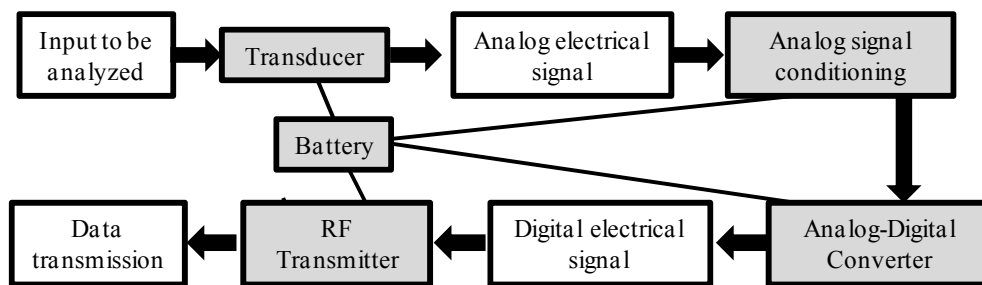

Figure 1. Synoptic of active wireless sensor

*Passive sensors* is typically composed of two parts: (1) a passive transducer with only passive elements and (2) a remote reader able to analyze the transducer response (Figure 2). The wireless communication between these two parts can exploit electrical, magnetic, electromagnetic, acoustic or optical link. The most popular are magnetic and electromagnetic links, related to the availability of several low costs solutions for electronic readers. The first one called “near field communication” is quite old and is limited by the very short reading distance (few tens of cm). Electromagnetic interrogation, based on the analysis of backscatter wave by the transducer, allows overcoming this limitation. Two classes of passive sensors with electromagnetic interrogation already exist on the market : RFID and SAW.

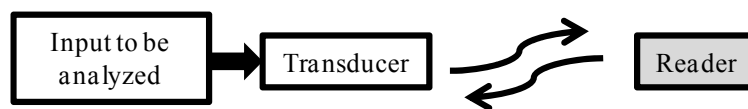

Figure 2. Synoptic of passive wireless sensor.

RFID passive sensors are based on the modulation of the backscatter wave level between two states (RCS1 and RCS2) reproducing digital coding of the signal (Figure 3). This modulation is obtained through the switching between two different loads connected to the antenna. The switch is driven by the digital output of a microcontroller that converts the analog response of the transducer. The main advantage, compared with active sensors, is the very high autonomy since the RF transmitter is removed and all the electronic units are powered through RF link. In return, the reading distance is generally lower than 5m.

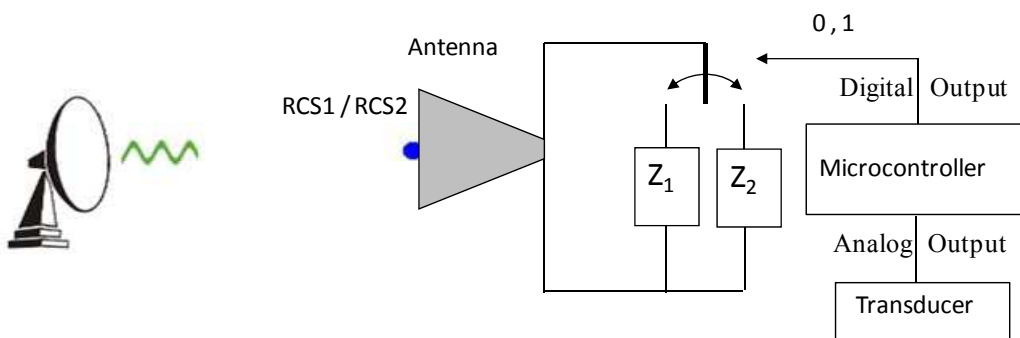

Figure 3. Synoptic of typical RFID wireless sensor

SAW sensors are based on piezoelectric substrate on which inter-digital electrodes (connected to an antenna) allow converting the electromagnetic waves into acoustic waves (for the input signal) and acoustic waves into electromagnetic waves (for the output signal). The backscattered signal is then

analyzed in time or frequency domain to extract transducer information as the propagation speed of the acoustic wave in the piezoelectric material is dependent on several factors (stress, temperature, surface coating, ...). The two main advantages compared to RFID passive sensors are the fully autonomous nature of these sensors (no need of energy for electronic or transducer part) and the high resistance to harsh environments. In return, the sensor response is fully analog making the identification more difficult and reducing the accuracy. Moreover the sensing principles are restricted by the use of piezoelectric substrates. Even if the reading distance is generally greater than that obtained for RFID sensors, this one is usually lower than 10m, related to the low efficiency of the coupling coefficient between electromagnetic and acoustic waves (between 0.1% and 5%).

Two main antagonistic requirements for SHM applications, i.e., a very high energy autonomy (for buried or low accessibility sensors) and a high reading distances ( $>10\text{m}$ ), are then often difficult to obtain with the above-described sensors. Recently a new class of passive wireless sensors emerged based on the electromagnetic transduction principle. These sensors are mainly composed of a variable RF impedance or RF resonator connected to an antenna that can be interrogated through backscattered wave analysis [9-14]. These sensors combine the advantages of SAW sensors (fully autonomous, high resistance to harsh environment) with an interrogation distance higher than 10m thanks to the elimination of the electromagnetic/acoustic conversions. Another advantages of electromagnetic transducers compared to SAW consists of using millimeter-wave frequency that allows the realization of efficient antennas (lower size and higher directivity), the wide range of sensing properties through the large possibilities of sensing principles (variation of physical or electrical length of the RF transducer, modification of the material properties, modulation of RF coupling between the RF transducer and movable mechanical or fluidic parts) and the possibility to use of great choice of materials.

Wireless passive and chipless electromagnetic transducers are then an interesting solution for several SHM applications. We started to work in this new research field in 2005 and several sensor principles have been validated in our lab (pressure, temperature, stress) with FMCW (Frequency Modulated Continuous Wave) Radar interrogation.

## **PRESSURE SENSOR**

We started this study in 2005 and the details on this sensor can be found in [15]. This device is composed of a planar half-wavelength resonator (designed around 30GHz) deposited inside a circular Pyrex cavity and a high resistivity silicon membrane anodic-bonded to Pyrex (Figure 4). The initial distance between the resonator and the membrane is around few microns allowing the electromagnetic coupling between the resonant mode in the planar resonator and the transverse stationary waves in the dielectric membrane through the evanescent transverse EM field in the air slab. A weak membrane deflection under pressure leads to the strong variation of the EM coupling and then gives a high resonant frequency shift ( $\sim 1\text{GHz}/\mu\text{m}$  between  $0.25\mu\text{m}$  and  $6\mu\text{m}$ ). The sensor has been fabricated using classical micro-technology process and characterized with a specific pressure probe module allowing on wafer  $S_{21}$  parameters. The sensor exhibits a very high sensitivity close to  $0.37\text{GHz}/\text{bar}$  (up to 3 bars) for a  $45\mu\text{m}$  thick silicon membrane.

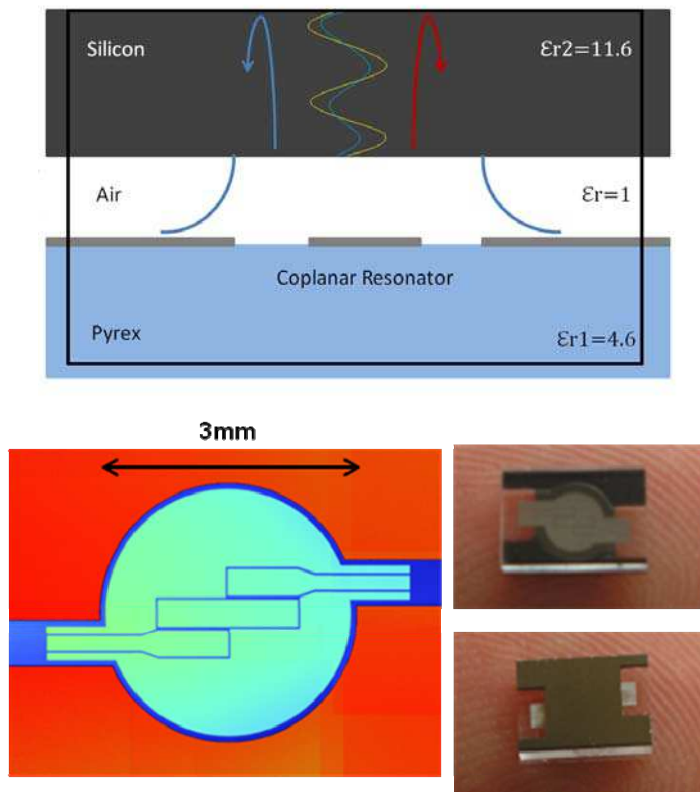

Figure 4. Topology of pressure sensor [15]

## TEMPERATURE MEMS SENSOR

We started this study in 2009 in collaboration with Georgia Institute of Technology and more details are given in [16]. The temperature transducer consists of split ring resonators (around 4.7 GHz) fabricated on top side of substrate and excited by a coplanar transmission line located on wafer back side (Figure 5). The slits of the rings are covered with bimorph micro-cantilevers whose layers are made from two different materials. A temperature shift induces the cantilever deflection and then a modification of the coupling capacitance between the two arms of the ring, which leads to the change of the resonant frequency.

The rings and the coplanar line are deposited on a 787 $\mu\text{m}$ -thick Neltec substrate. The bilayers cantilever is obtained by the lamination of a 100 $\mu\text{m}$  thick aluminum sheet and a 50 $\mu\text{m}$  thick polyethylene (PET) sheet. Measurements of  $S_{11}$  parameter at two different temperatures (32 $^{\circ}\text{C}$  and 60 $^{\circ}\text{C}$ ) show a relative resonant frequency shift around 530ppm/ $^{\circ}\text{C}$  and an estimated full scale variation close to 10%.

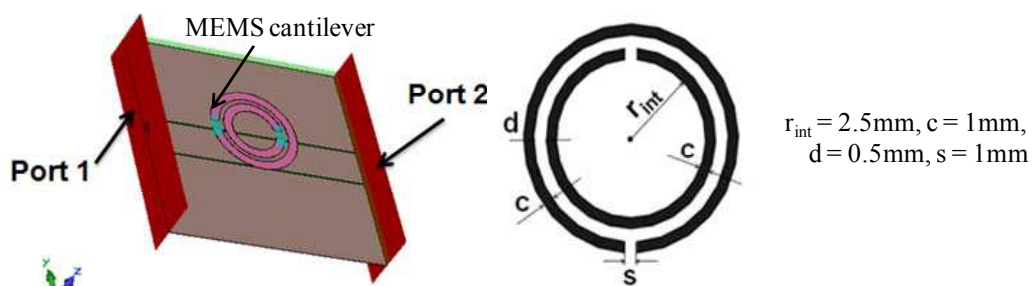

Figure 5. Topology of temperature MEMS sensor [16]

## TEMPERATURE FLUIDIC SENSOR

We started this study in 2010 in collaboration with Georgia Institute of Technology and more details are given in [17-18]. The sensors are based on the thermal expansion of a fluid inside a polymer (SU8) micro-channel fabricated above a RF structure. The principle has been validated first with a metallic liquid by using an array of dipole antennas (Figure 6). A drastically step-by-step change of the Radar Cross Section (RCS) of the sensor is obtained by short-circuiting progressively the two arms of the different dipoles array. Devices operating around 30GHz were fabricated on Kapton with an array of 5 dipoles for which short circuits were achieved by depositing Galinstan drop between the dipole strands. RCS characterizations, performed using a millimeter-wave FMCW RADAR, have shown that one can obtain a RCS shift close to 12dBsm for the full scale. Temperature sensor principle has been also validated using dielectric fluid (water) that changes the permittivity between the two electrodes of a planar capacitor (Figure 7). The capacitor length is equal to 400 $\mu$ m and provides a variation of the reflection coefficient ( $S_{11}$ ) around 9 dB at 30 GHz for full scale. Capacitance then varies continuously from 20fF to 140fF corresponding to temperature change of 9°C.

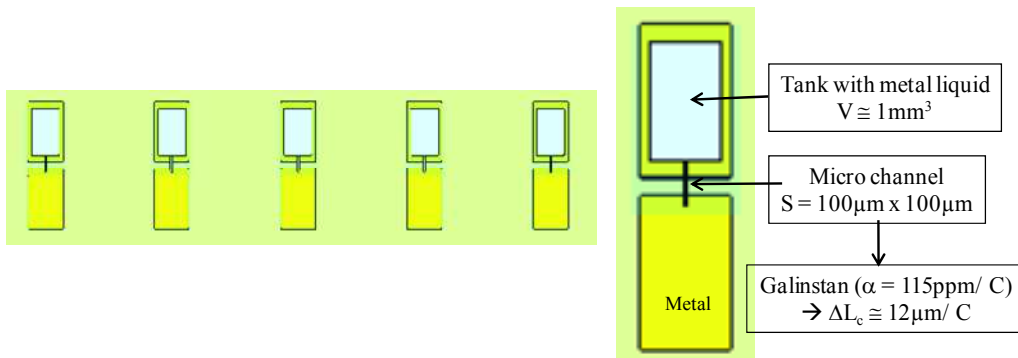

Figure 6. Topology of temperature fluidic sensor with metallic fluid [17-18]

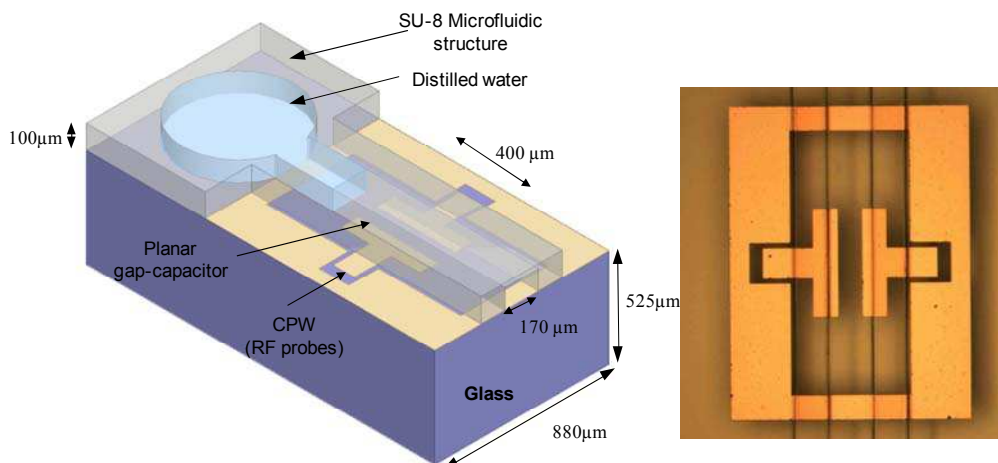

Figure 7. Topology of temperature fluidic sensor with dielectric fluid [17-18]

## STRESS SENSOR

We started this study in 2010 in collaboration with Georgia Institute of Technology and more details are given in [19]. The sensor is based on two coupled planar resonators (a patch antenna and an open loop) whose resonant frequencies are close to 2.4 GHz. The loop is closed by a variable capacitor which changes with the deformation (Figure 8). This variable capacitor is formed by a metal cantilever and the free metal of the loop, separated by an insulator of  $15\mu\text{m}$  thick. Deformation of the support (100 microns thick Kapton) then causes a displacement of the anchor point of the cantilever. The surface of the capacitor is then modified with sensitivity dependent on the length of the cantilever. The total size of the sensor is  $40\text{mm} \times 25\text{mm}$ . Simulation results show a maximum sensitivity of  $4.5\text{ppm}/\mu\epsilon$ . Demonstrators were manufactured with conventional technologies to fabricate the resonators and the cantilever. Then the assembly was performed more or less manually which failed to achieve accurate positioning of the cantilever. However a measured sensitivity of  $1.3\text{ppm}/\mu\epsilon$  was obtained, that is as large as what has been published to date.

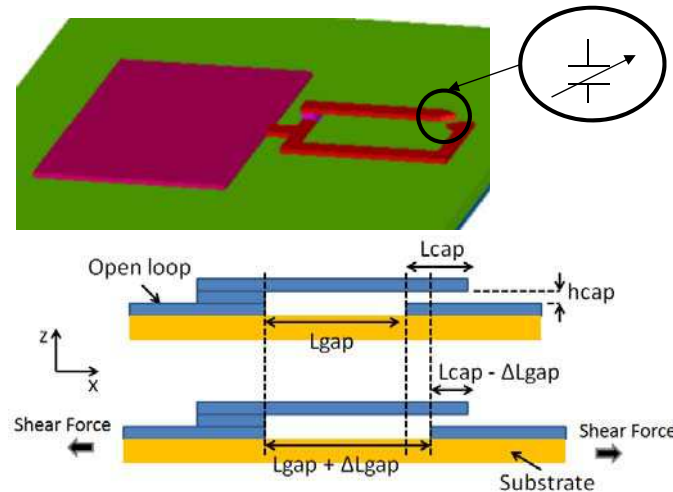

Figure 8. Topology of stress sensor [19]

## RADAR INTERROGATION

The interrogation system is based on the FMCW (Frequency Modulated Continuous Wave) Radar. From the measured Radar Cross Section (electromagnetic echo) of the sensors, the physical quantity can be wirelessly derived and the identification of the sensor can also be performed [20-21]. A Radar operating at around 29.45 GHz has been designed and fabricated. The interrogation principle up to 30m has been first validated using  $1\text{ cm}^2$  passive target and few mW for Radar emission. In most cases of sensors described previously, one transducer port is connected to an antenna through a coaxial cable (1m long) and the second port of the transducer is connected to a  $50\ \Omega$  load. The RF cable which operates as a delay line allows separating the transducer echo from the antenna echo. The beat frequency level, which corresponds to the Radar output, is then modulated by the input to be analyzed (pressure, stress, temperature). A full scale variation of the beat frequency level around 5 dB is generally obtained with the different transducers and the sensor accuracy is estimated to  $\pm 5\%$  (Figure 9).

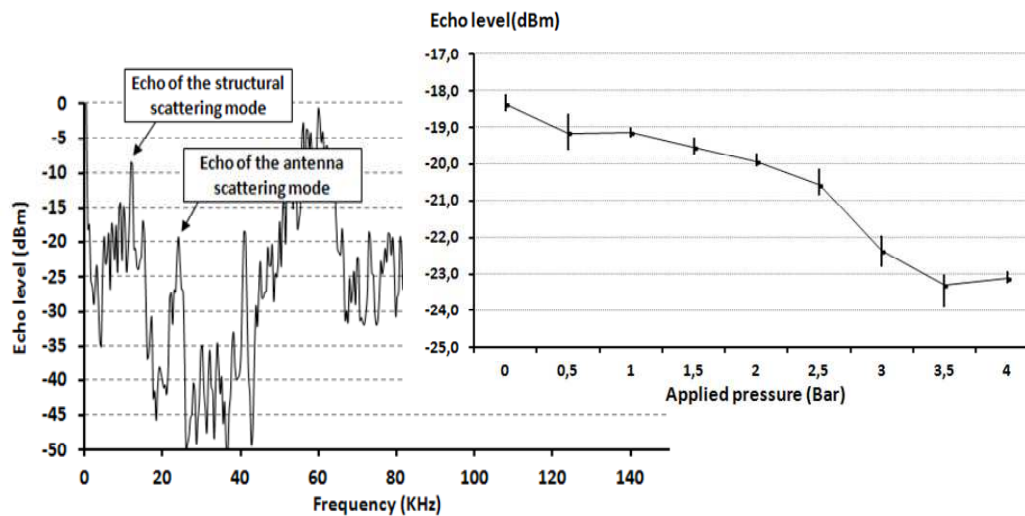

Figure 9. Example of Radar response with the pressure transducer

## CONCLUSIONS

The principle of new passive sensors, based on electromagnetic transduction, has been validated for several physical parameters (pressure, temperature, stress) which are interesting for SHM applications. The main advantages of this new kind of sensors are: a very simple transducer part without battery and without embedded electronic circuits and a wireless reading distance greater than 10m using a FMCW Radar.

Nevertheless our main objective now is focused on the realization of sensors with given specifications (sensitivity, accuracy, ...) for specific applications.

## ACKNOWLEDGEMENTS

Part of this work is supported by the French Project of 'Pôle de compétitivité' entitled 'Système Autonome Communicant En Réseau' (SACER). All these studies have been performed with PhD students (Mehdi JATLAOUI, Franck CHEBILA, Thai TRANG, Sofïène BOUAZIZ, Anya TRAILLE).

## REFERENCES

1. L Atzori, A Iera, G Morabito. The Internet of Things: A survey. *Computer Networks* 54 (2010), 2787-2805
2. L Ruiz-Garcia, L Lunadei, P Barreiro, J Robla. A Review of Wireless Sensor Technologies and Applications in Agriculture and Food Industry. *Sensors* 2009, 9, 4728-4750
3. E Sardini, M Serpelloni. Passive and Self-Powered Autonomous Sensors for Remote Measurements. *Sensors* 2009, 9, 943-960
4. H Alemdar, C Ersoy. Wireless sensor networks for healthcare, A survey. *Computer Networks* 54 (2010) 2688-2710
5. E.J. Brandon, et al., Structural health management technologies for inflatable / deployable structures: Integrating sensing and self-healing, *Acta Astronautica* (2010), doi:10.1016/j.actaastro.2010.08.016
6. A. S. Kiremidjian, Structural Health Monitoring for Civil Infrastructure : From Instrumentation to Decision Support, *IWSH 2011, Sept 13-15, Stanford University, USA*
7. Chih-Yuan Chang, San-Shan Hung, Implementing RFIC and sensor technology to measure temperature and humidity inside concrete structures, *Construction and Building Materials* (2011), doi:10.1016 /j.conbuildmat.2011.06.066
8. M.J. Chae, H.S. Yoo, J.Y. Kim, M.Y. Cho, Development of a wireless sensor network system for suspension bridge health monitoring, *Autom. Constr.* (2011), doi:10.1016/j.autcon.2011.06.008

9. M McGrath, R Sabouni, A Pham. Development of nano-based resonator gas sensors for wireless sensing systems. *Proceedings of the SPIE 2004, Volume: 5593, Issue: 1, Pages: 62-72*
10. J. Chuang, D. J. Thomson, and G. E. Bridges. Embeddable wireless strain sensor based on resonant RF cavities. *Review of Scientific Instruments*, 76 (2005)
11. M Jatlaoui, P. Pons, H. Aubert. Radio Frequency Pressure Transducer . *European Microwave Week (EUMC2007)*, 8-12 October 2007, Munich, Germany
12. A Mahmood, H Sigmarrsson, H Joshi, W Chappell, D Peroulis. An Evanescent-mode Cavity Resonator Based Thermal Sensor . *IEEE sensors 2007*, 28-31 Oct 2007, Atlanta, USA
13. Y Zhao, SH Kim, Y Li, B Pan, X Wu, M Tentzeris, J Parapolymerou, MG Allen. A Micromachined Airflow Sensor Based on RF Evanescent-Mode Cavity Resonator. *IEEE MTT-S 2008*, 15-20 June 2008, Atlanta, USA
14. R Matsuzaki, M Melnykowycz, A Todoroki. Antenna/sensor multifunctional composites for the wireless detection of damage. *Composites Science and Technology* 69 (2009) 2507–2513
15. M. Jatlaoui, F. Chebila, P. Pons, H. Aubert. Working Principle Description of the Wireless Passive EM Transduction Pressure Sensor. *European Physical Journal - Applied Physics*, Vol 56, N°1, oct 2011
16. T. Thai, M. Jatlaoui, F. Chebila, H. Aubert, P. Pons, G. DeJean, M. Tentzeris, R. Plana. Design and Development of a Novel Passive Wireless Ultrasensitive RF Temperature Transducer for Remote Sensing. *IEEE Sensor Journal*, Volume 12, Issue 9, sept 2012, pp 2756-2766
17. A. Traille, S. Bouaziz, H. Aubert, P. Pons, M. M. Tentzeris. A Novel Wireless Passive Temperature Sensor Utilizing Microfluidic Principles in Millimeter-Wave Frequencies. *IEEE Sensors*, 28-31 October 2011, Limerick, Ireland
18. S. Bouaziz, F. Chebila, A. Traille, P. Pons, H. Aubert, M. Tentzeris. Novel Micro-fluidic Structures for Wireless Passive Temperature Telemetry Medical Systems Using Radar Interrogation Techniques in Ka-band. *IEEE Antennas & Wireless Propagation Letters*, Volume 11, 2012, pp 1706-1709
19. T. Thai, H. Aubert, P. Pons, G. DeJean, M. Tentzeris, R. Plana. Novel Design of a Highly Sensitive RF Strain Transducer for Passive and Remote Sensing in Two Dimensions. *IEEE Transactions on Microwave Theory and Techniques*, Issue 3, March 2013, pp 1385-1396
20. F. Chebila, M. Jatlaoui, P. Pons, H. Aubert. Reconfigurable Multi-band Scatterers for Micro-Sensors Identification. *IEEE International Symposium on Antennas & Propagation*, June 1-5 2009, Charleston, USA
21. M. Jatlaoui, F. Chebila, S. Bouaziz, P. Pons, H. Aubert. Original Identification technique of passive EM Sensors using Loaded Transmission Delay Lines. *European Microwave Week (EUMC2010)*, 26 Sept-1 Oct 2010, Paris, France