

# Parametric Optical Signal Processing in Silicon Waveguides with Reverse-biased p-i-n Junctions

**C. Peucheret<sup>1</sup>, F. Da Ros<sup>2</sup>, D. Vukovic<sup>2</sup>, K. Dalgaard<sup>2</sup>, and M. Galili<sup>2</sup>  
A. Gajda<sup>3,4</sup> L. Zimmermann<sup>4</sup>, B. Tillack<sup>3,4</sup>, and K. Petermann<sup>3</sup>**

1. FOTON Laboratory – CNRS UMR 6082, Lannion, France
2. Department of Photonics Engineering, Technical University of Denmark, Kgs. Lyngby, Denmark
3. Institut für Hochfrequenz- und Halbleiter-Systemtechnologien, TU Berlin, Berlin, Germany
4. IHP, Frankfurt (Oder), Germany

christophe.peucheret@univ-rennes1.fr



**DTU Fotonik**  
Department of Photonics Engineering



# Nonlinear platforms for signal processing

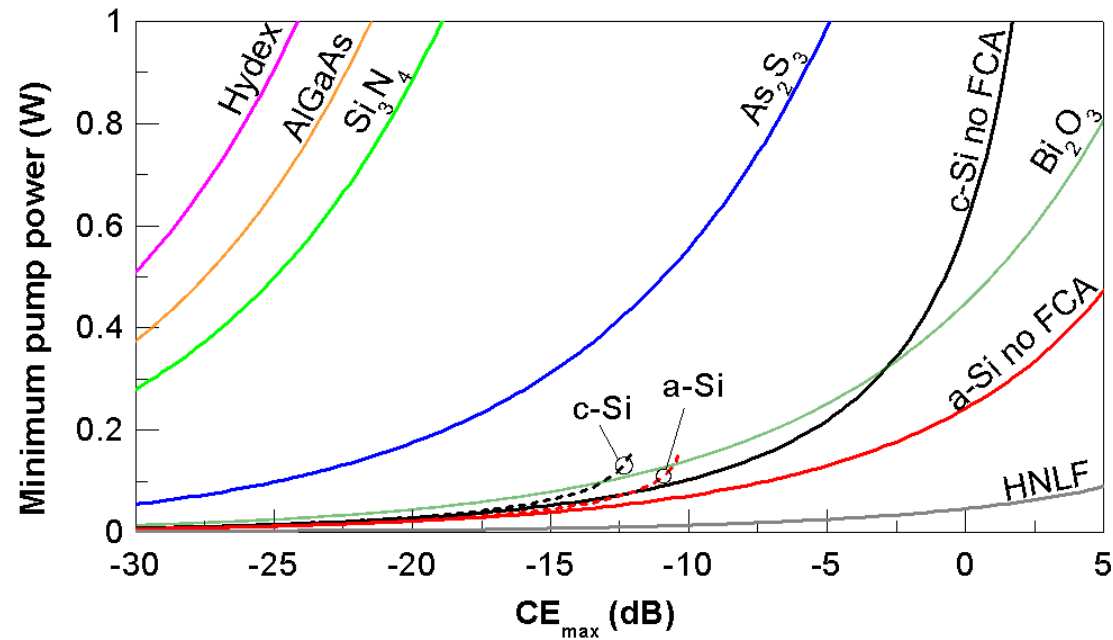

Minimum pump power required for a target conversion efficiency

# Nonlinear loss mechanism in Si waveguides

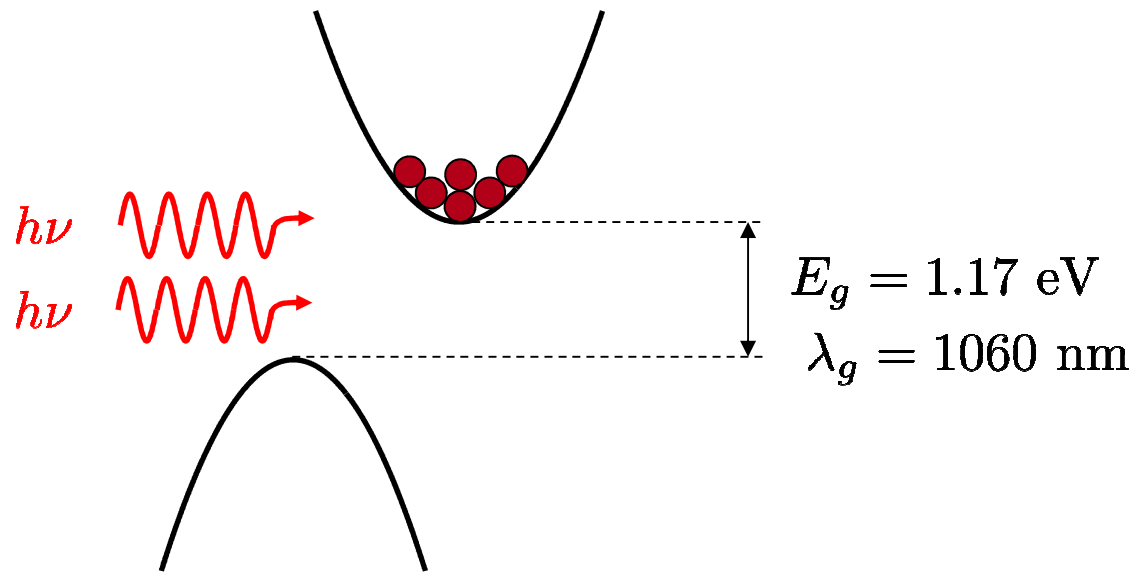

Two-photon absorption (TPA) if:

$$2h\nu > E_g \Rightarrow \lambda < 2\lambda_g \\ \lambda < 2120 \text{ nm}$$

$\Rightarrow$  Generation of free carriers

- Free carrier absorption (FCA)
- Free carrier dispersion (FCD)

can be mitigated using p-i-n junction

# Nonlinear platforms for signal processing

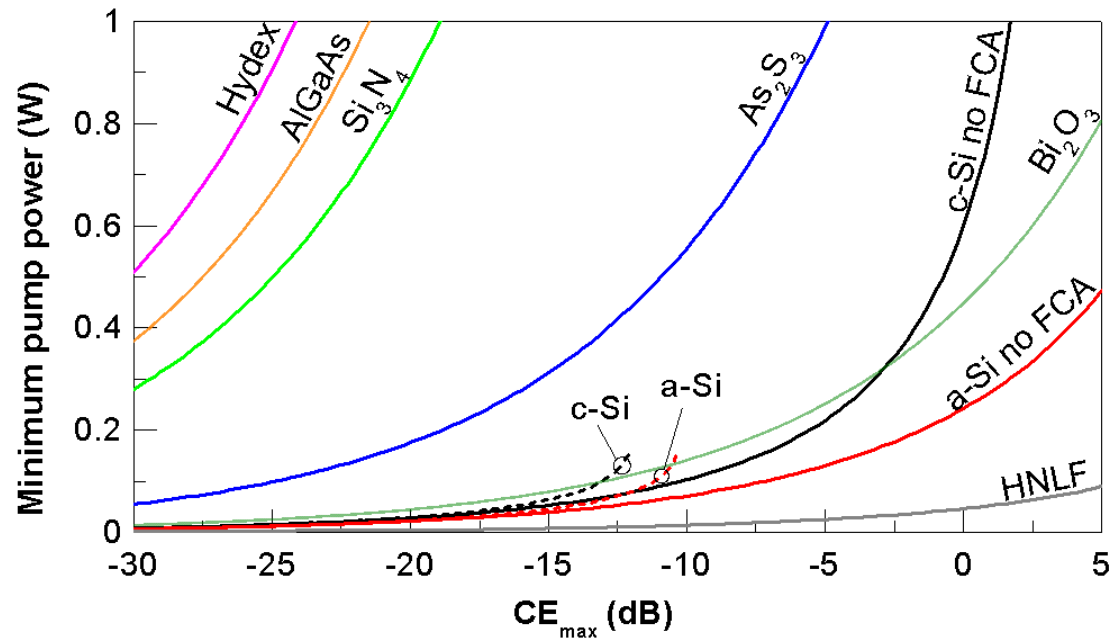

Minimum pump power required for a target conversion efficiency

# Outline

- Motivations
- Silicon waveguides with p-i-n junctions
- Phase insensitive signal processing
  - High-efficiency FWM wavelength conversion
- Phase-sensitive signal processing
  - Regeneration of phase modulated signals
  - Simultaneous wavelength and modulation format conversion
- Summary

# Silicon waveguides with p-i-n junction

Avoiding nonlinear loss:

1. Operate at wavelengths above 2120 nm
  - no TPA
  - no telecom band operation
2. Pulsed pump operation with low repetition frequency
  - not compatible with high bit rate operation
3. **p-i-n junction** across the nonlinear silicon waveguide
  - Sweep the carriers generated by two-photon absorption
  - Reduce effective carriers lifetime

⇒ **limits the impact of free-carrier absorption**

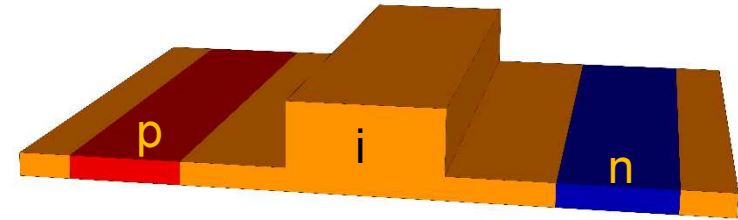

H. Rong et al., Opt. Express 14 (2006) 1182.

A. C. Turner-Foster et al., Opt. Express 18 (2010) 3582.

J. R. Ong et al., IEEE Photon. Technol. Lett. 25 (2013) 1699.

# Fabricated silicon waveguide structure

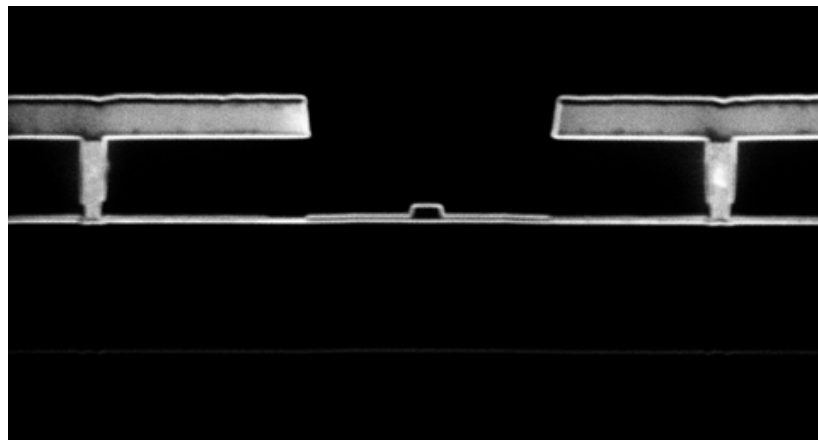
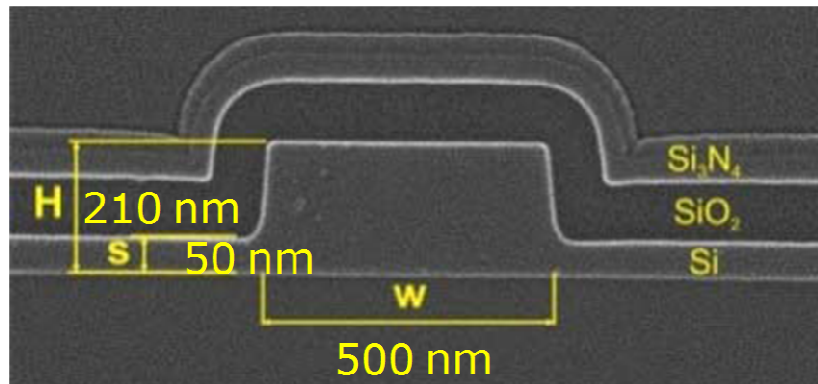

- Waveguide height:  $H = 210$  nm
- Slab height:  $s = 50$  nm
- Rib width:  $w = 500$  nm
- Covered by 100 nm  $\text{SiO}_2$  and 90 nm  $\text{Si}_3\text{N}_4$
- p-doped region: boron }  $10^{18} \text{ cm}^{-3}$
- n-doped region: arsenic }
- doped regions spaced 1.2  $\mu\text{m}$
- higher doped contact regions spaced further away

- Fabricated in a BiCMOS foundry using 258 nm lithography
- 8" wafers with 2  $\mu\text{m}$  buried oxide layer

# Silicon waveguides optical properties

Quantity	Value	Unit
Length	4	cm
Loss	1	dB/cm
TPA coeff.	0.5	cm/GW
Nonlinear coeff.	280	$W^{-1} \cdot m^{-1}$
Coupling loss*	4.5	dB/facet

\*1D grating couplers with 35 nm bandwidth

Optical properties in line with standard SOI waveguides  
+ p-i-n junction



# Record (2012) conversion efficiency

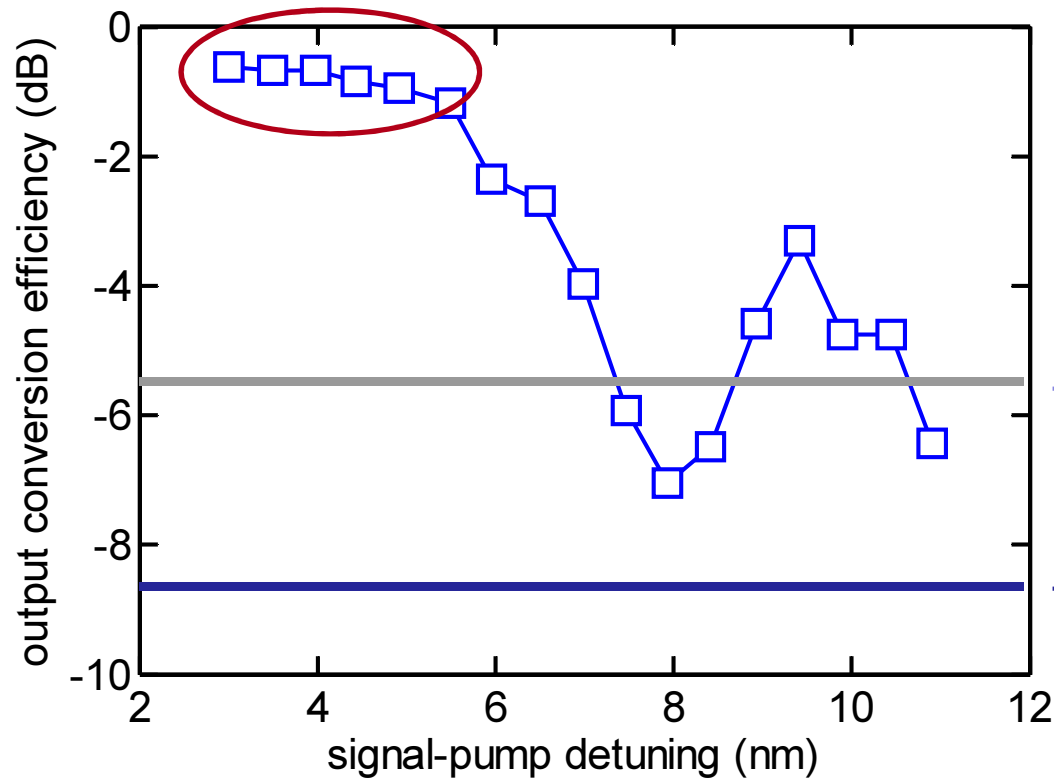

Maximum output conversion efficiency:

-0.7 dB

-5.5 dB *Malouthi et al., Intel 2008*

-8.5 dB *Kuo et al., Intel 2006*

- Pump wavelength  $\lambda_p = 1542$  nm
- Pump power: 26 dBm
- Reverse bias: 20 V

W. Mathlouthi et al., Opt. Express 16 (2008) 16735.

# Free carrier absorption threshold

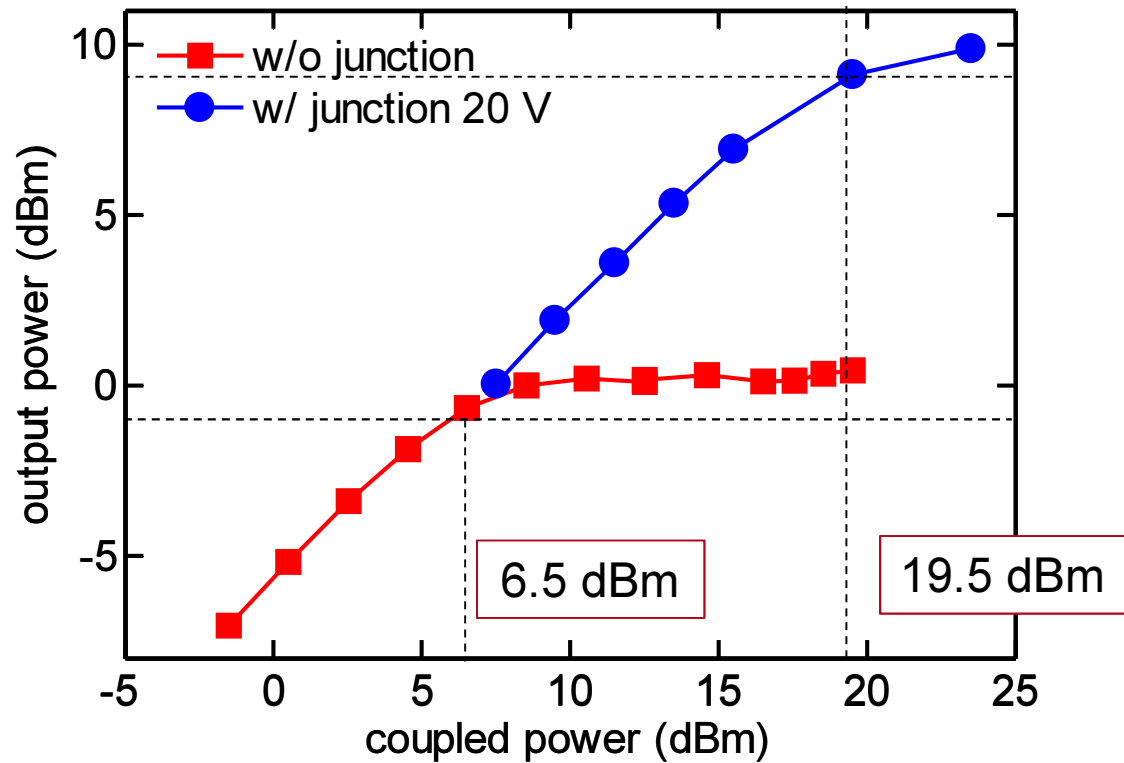

Coupled power before FCA limitation increased by more than 10 dB

# **Phase-insensitive Signal Processing**

# Set-up for 40 Gbit/s wavelength conversion

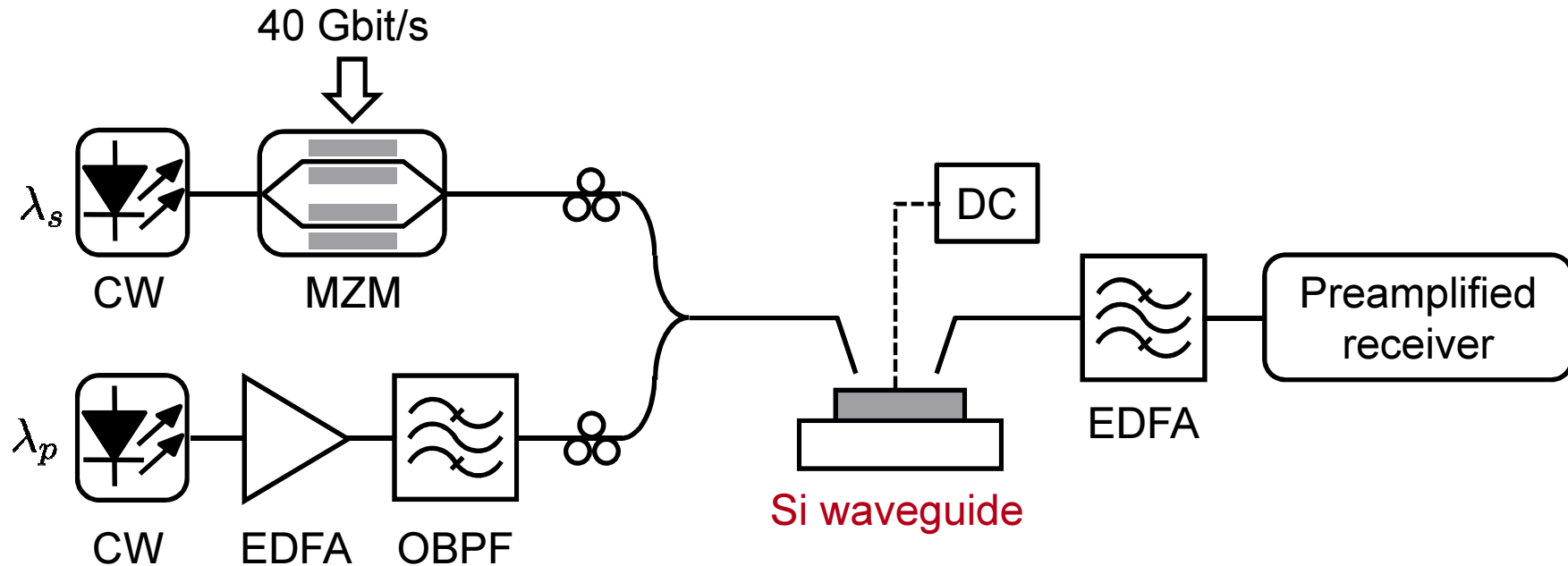

- 40 Gbit/s NRZ-OOK
  - PRBS  $2^{15}-1$
  - $P_p = 22.5$  dBm
  - $P_s = 2.5$  dBm
- } coupled into Si waveguide

# Wavelength conversion bandwidth

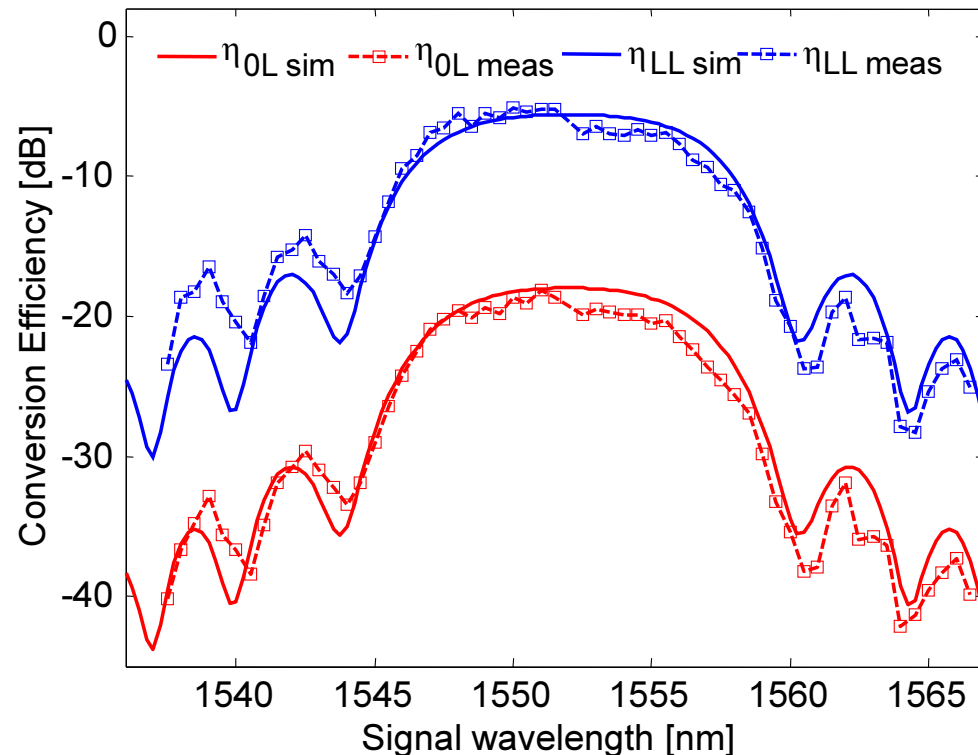

Conversion efficiency:

output:

input/output:

$$\eta_{LL} = \frac{P_i(L)}{P_s(L)} \quad \eta_{0L} = \frac{P_i(L)}{P_s(0)}$$

- 20 dBm pump power
- 0 dBm signal power
- 20 V reverse bias
- Good agreement between measurement and theory for  $D=-2450$  ps/(nm·km)

- 3 dB conversion bandwidth of ~10 nm
- Wider bandwidths achievable after dispersion engineering

# Wavelength converter output spectra

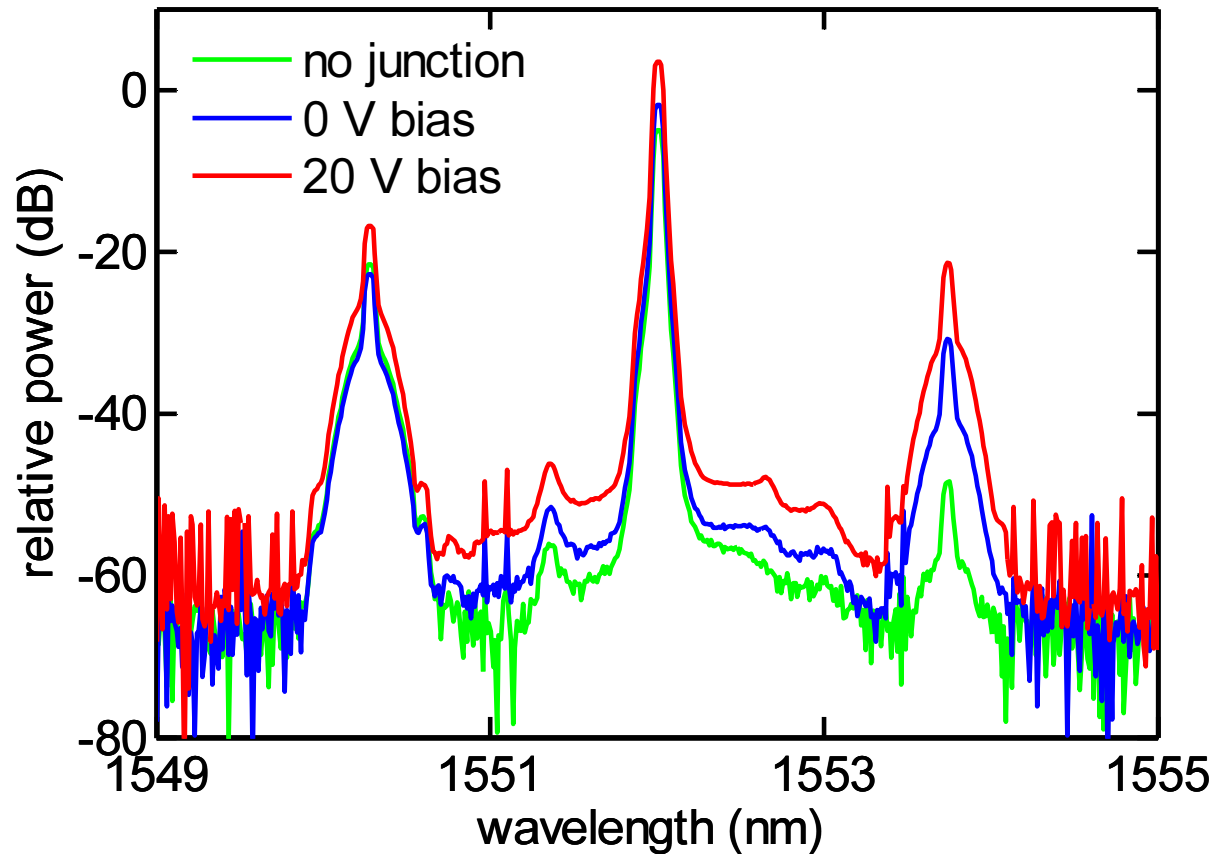

Bias (V)	CE (dB)
no junction	-26.9
0	-8
20	-4.6

- Built-in field of p-i-n junction already significantly improves the conversion efficiency
- Up to -4.6 dB output conversion efficiency for 20 V reverse bias

# BER performance for wavelength conversion

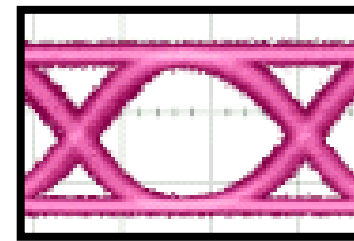
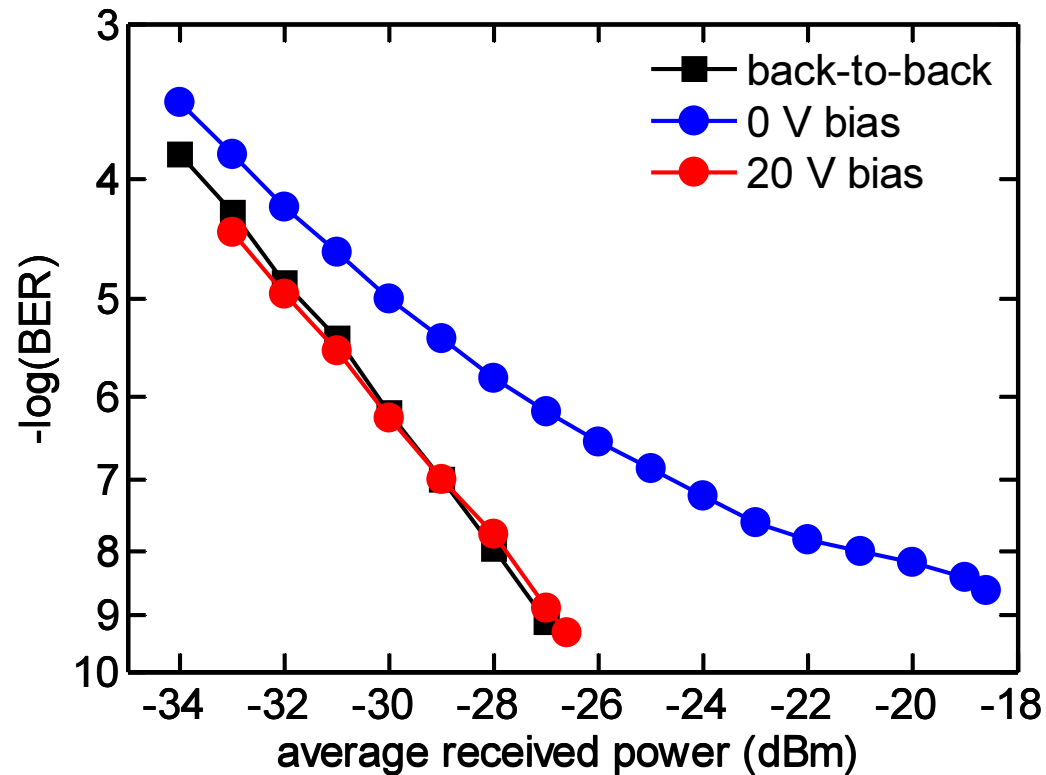

back-to-back

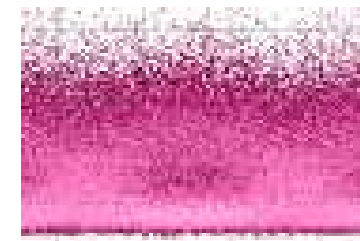

no p-i-n



p-i-n - 0 V

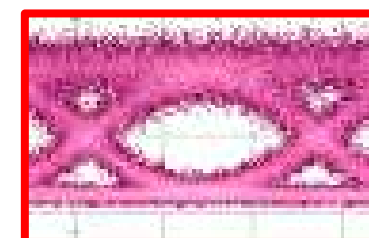

p-i-n - 20 V

40 Gbit/s wavelength conversion with 0.2 dB power penalty applying 20 V reverse bias

# **Phase-sensitive Signal Processing**



# Motivations for phase-sensitive processing in waveguides

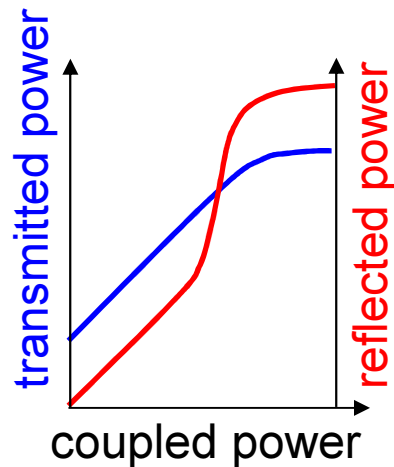

- Stimulated Brillouin scattering (SBS) limits the amount of pump power that can be coupled in a highly nonlinear fibre (HNLf)
- Classic mitigation technique for parametric amplification:

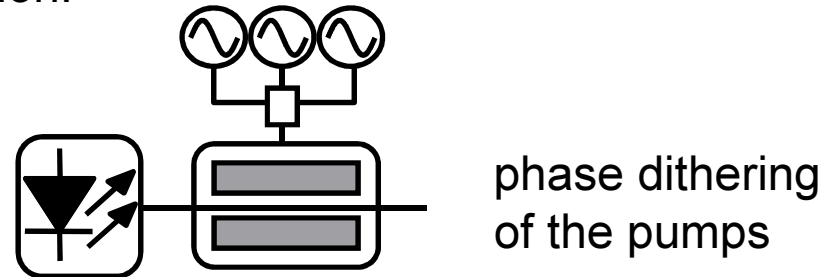

- Not “phase-sensitive friendly” technique
- Other techniques:
  - High-SBS threshold HNLFs  $\Rightarrow$  15 dB/km loss (1<sup>st</sup> generation)
  - Strained HNLFs  $\Rightarrow$  OK as long as dispersion well controlled

Short (but highly nonlinear) waveguides should be relatively immune to SBS

# Phase sensitive processing in waveguides

- Periodically-poled lithium niobate waveguides

K. J. Lee et al., Opt. Express 17 (2009) 20393.

B. J. Puttnam et al., IEEE Photon. Technol. Lett. 23 (2011) 426.

T. Umeki, Opt. Express 21 (2013) 12077.

- Chalcogenide waveguide

R. Neo et al., Opt. Express 21 (2013) 7926.

- Low TPA, no FCA
- 10 dB phase-sensitive extinction ratio (pulsed pump 38.6 MHz)
- Limited by damage threshold of the waveguide

- Silicon photonic crystal waveguide

Y. Zhang et al., Opt. Lett. 39 (2013) 363.

- 11 dB phase-sensitive extinction ratio (pulsed pump 38.6 MHz)
- Limited by TPA and FCA

# Static phase-sensitive investigation

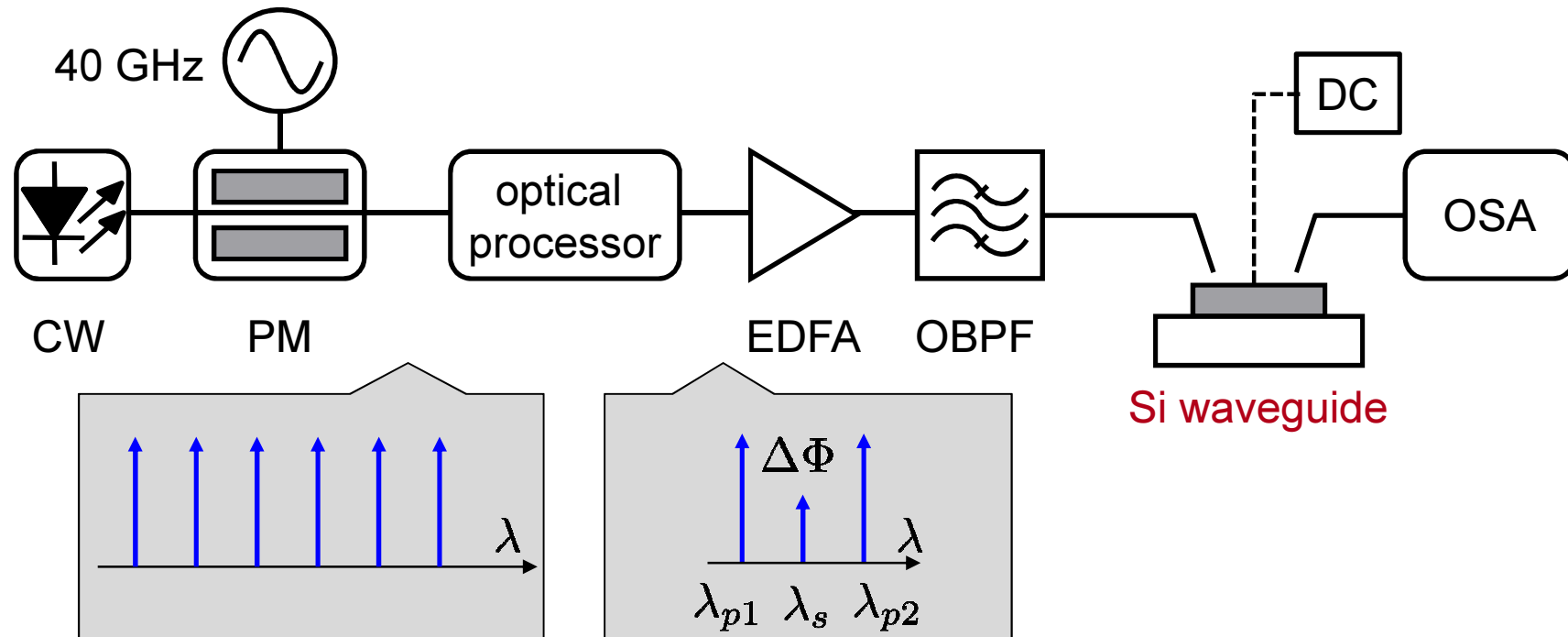

- Phase coherence between pumps and signal ensured by frequency comb generation
- Frequency spacing of 40 GHz between interacting waves

# Evidence of phase-sensitivity in Si

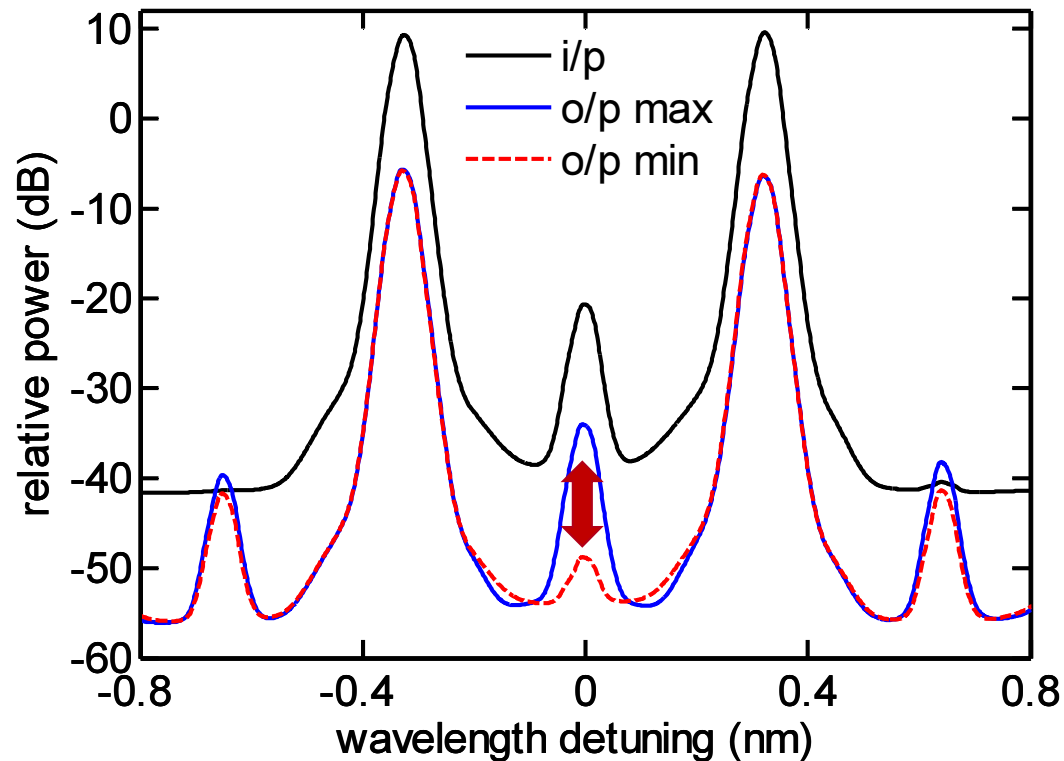

- 28 dBm total power
- pump-to-signal power ratio: 30 dB

- L= 4 cm
- Reverse bias: 25 V
- Signal phase shift:

$$\Phi_s = 30^\circ$$

$$\Phi_s = 120^\circ$$

Power of the degenerate signal/idler depends on the relative phase between signal and pumps

# Phase sensitive extinction ratio optimisation

pump power

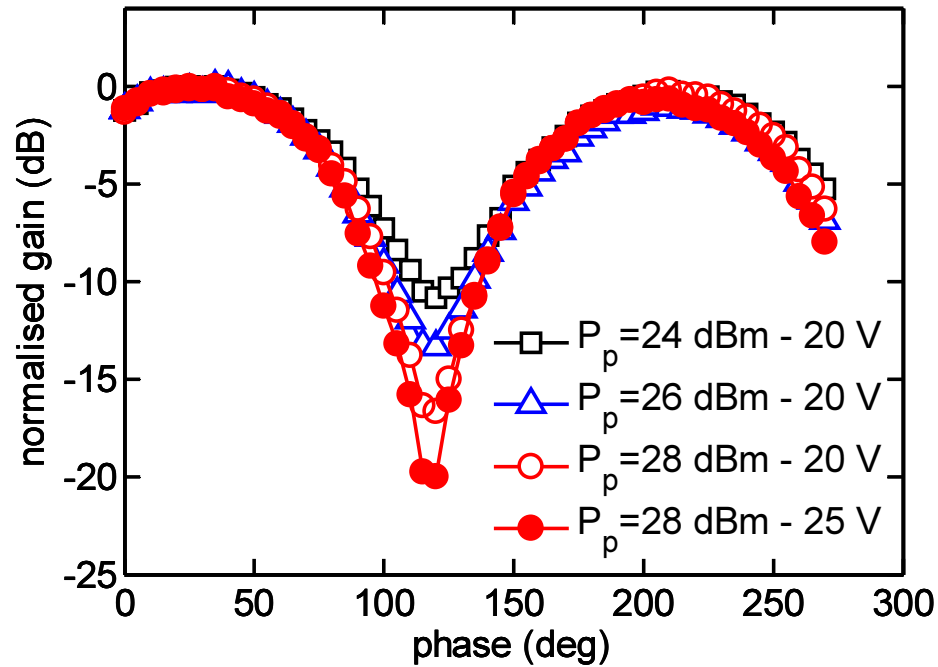

waveguide length

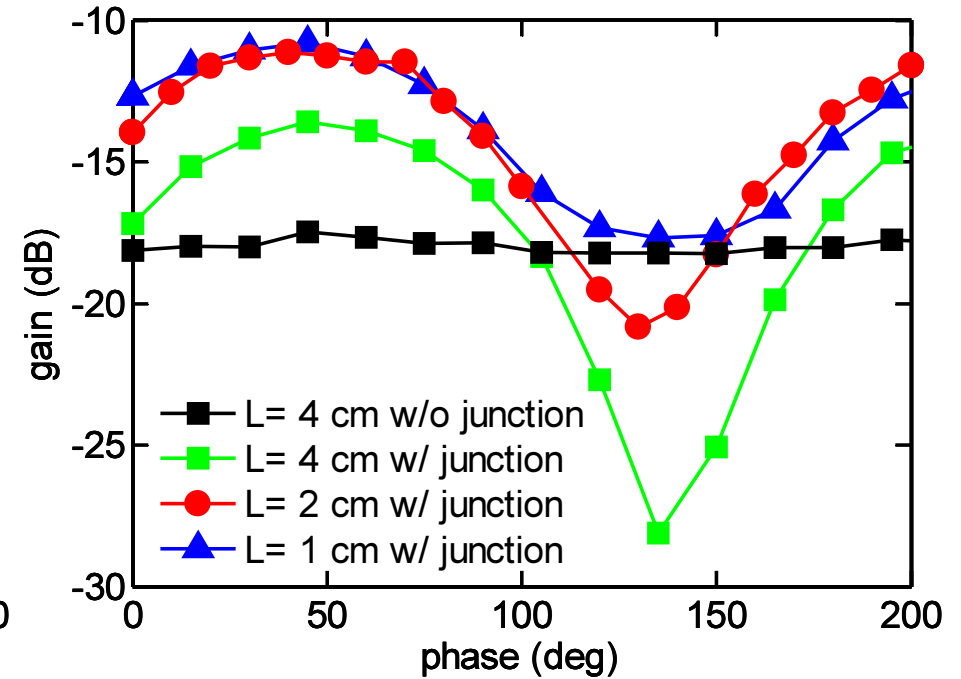

$L = 4$  cm      7.5 dB coupling loss

Up to 20 dB phase-sensitive extinction ratio attainable

# Setup for phase regeneration

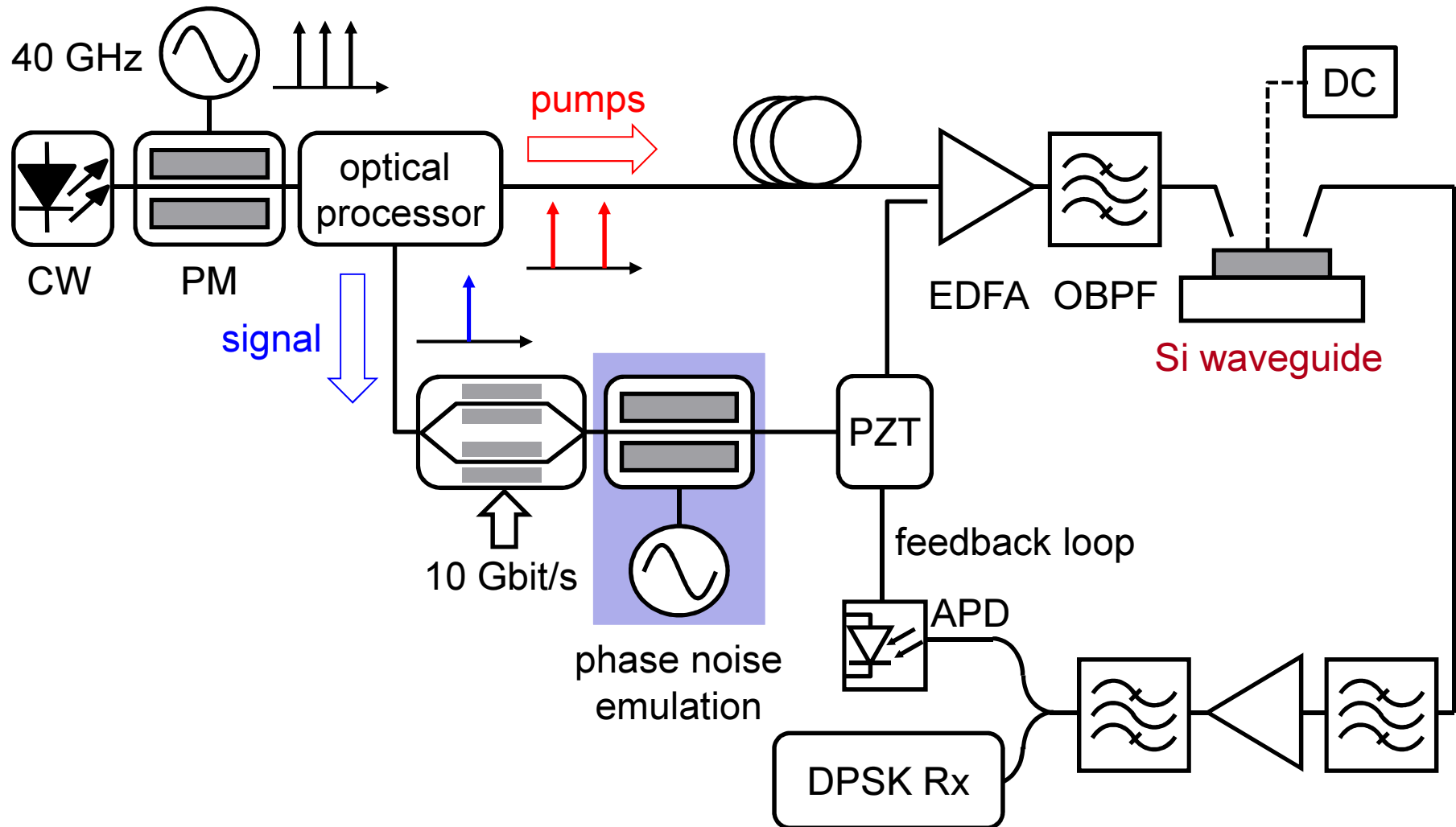

# Phase-sensitive regenerator output spectrum

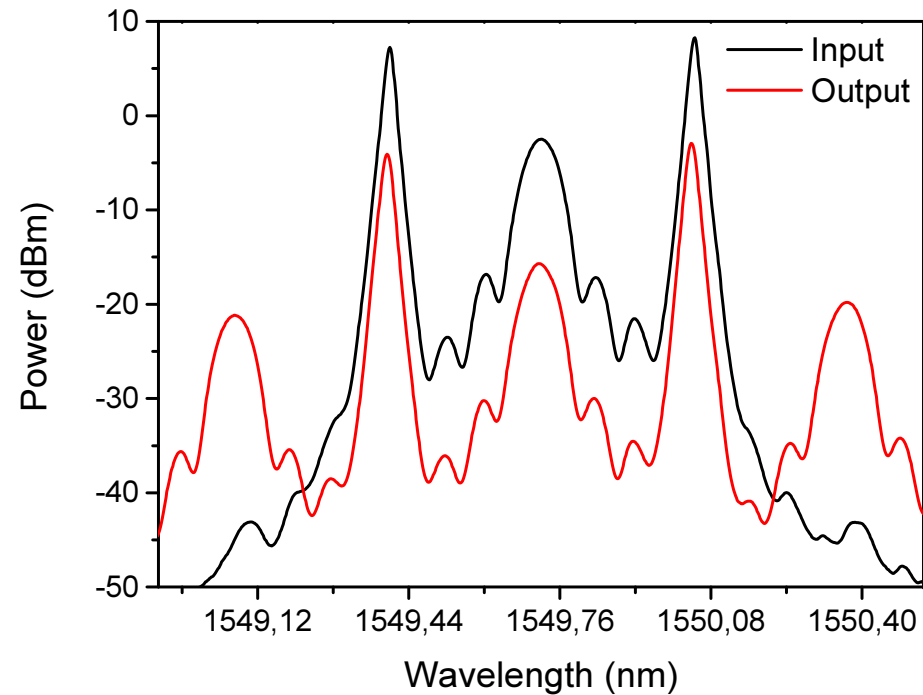

Higher-order sidebands generated

# BER evaluation for phase-regeneration

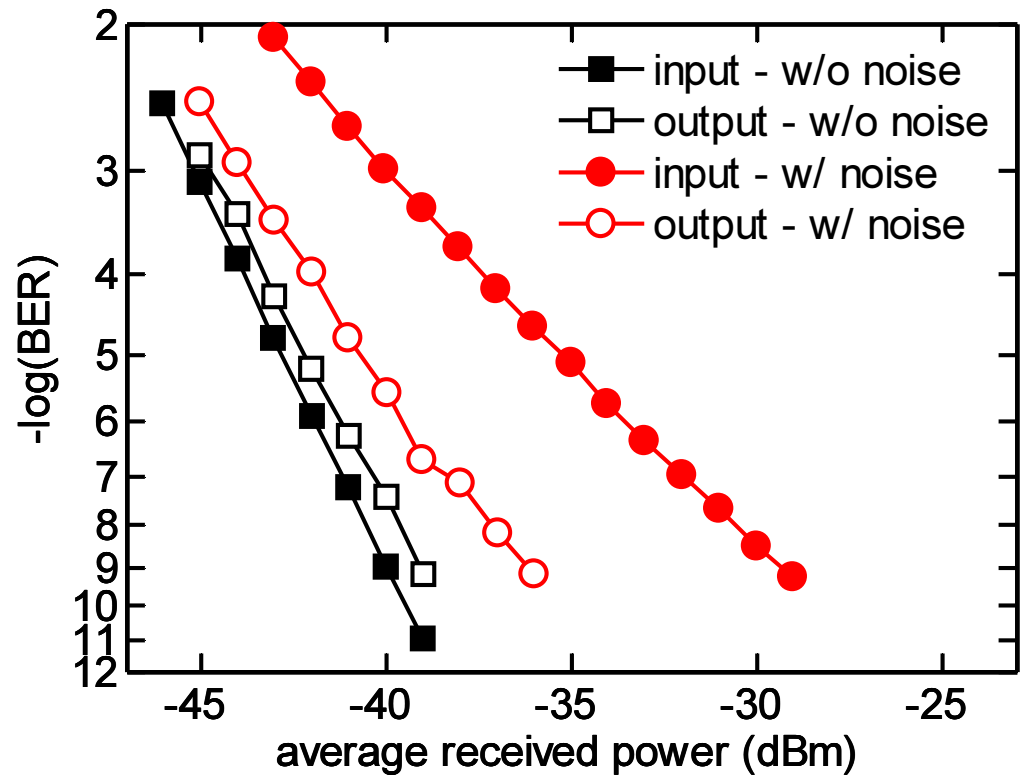

- $2^{15}-1$  PRBS
- 4 GHz phase noise
- 0.57 phase modulation index

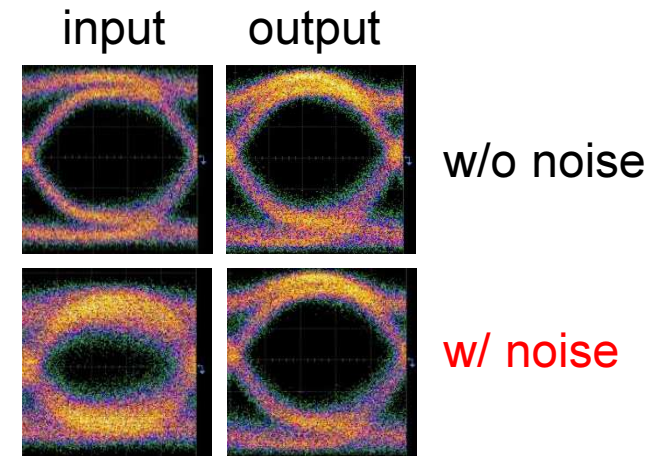

Phase-noise penalty reduced from 10 dB to less than 3.5 dB



# Phase regeneration capability

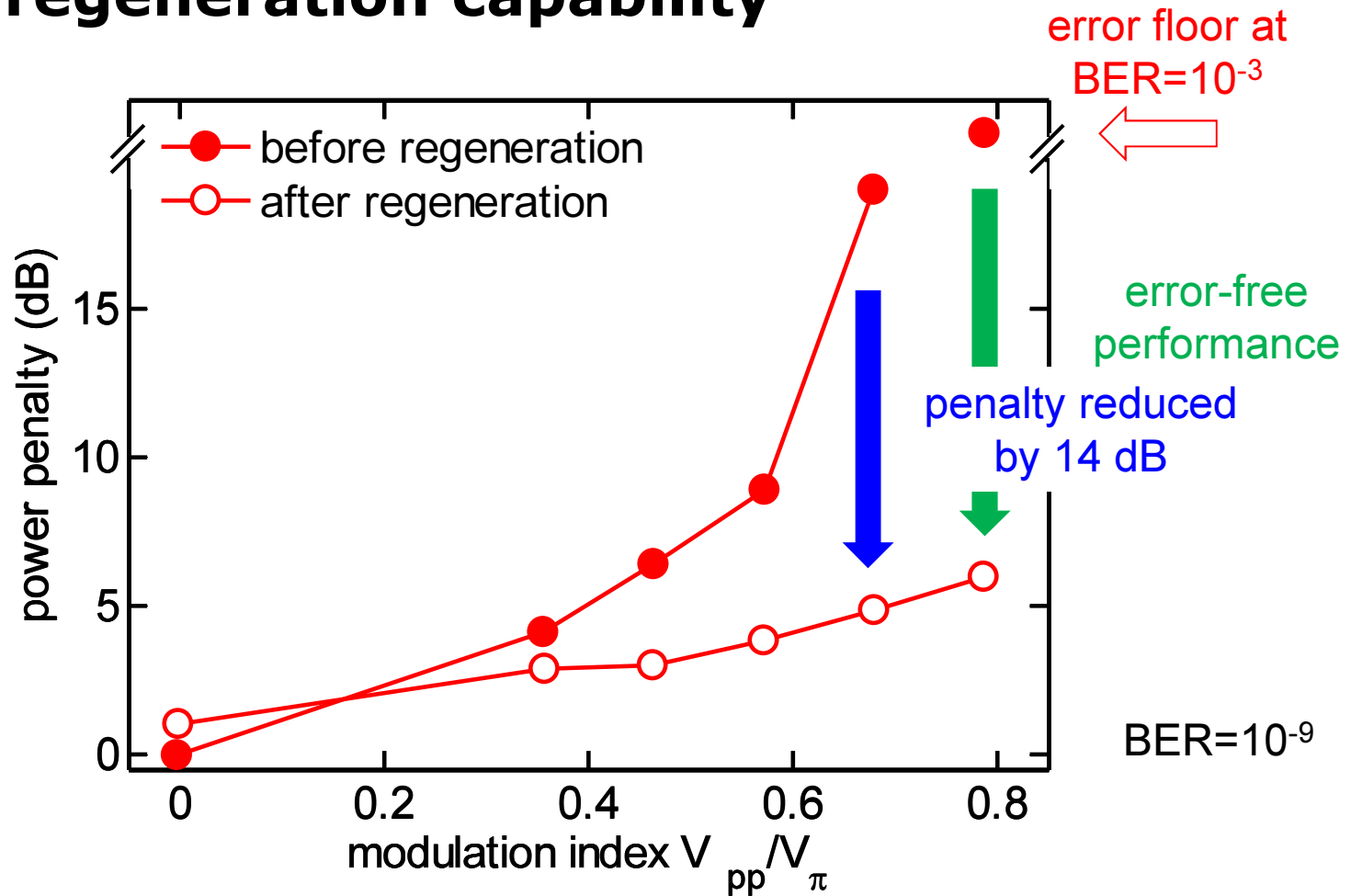

Increase of the phase noise modulation index slowly increases the power penalty of the regenerated signal

# Phase-sensitive wavelength conversion

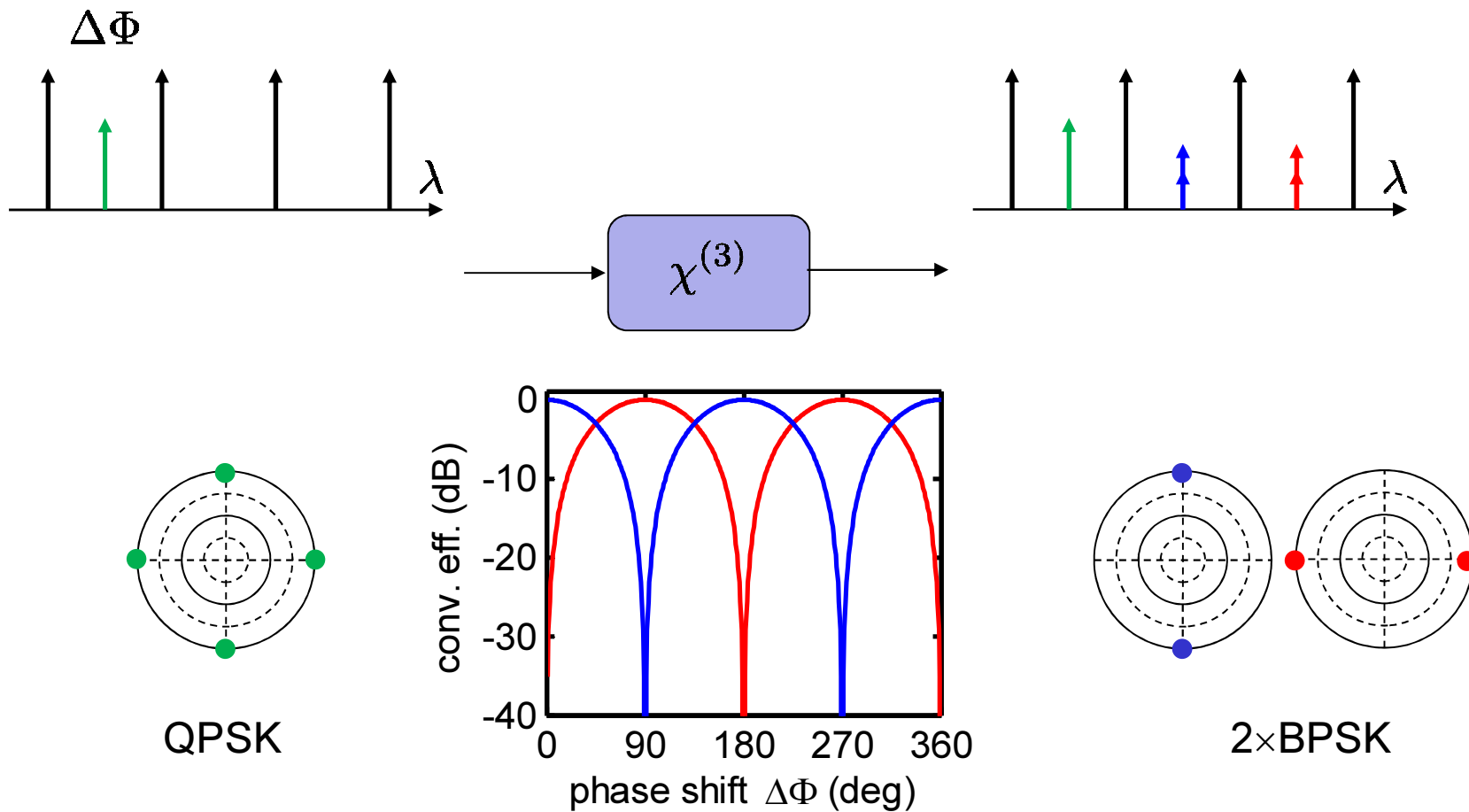

R.P. Webb et al., Opt. Express 19 (2012) 20015.  
 M. J. Power et al., Opt. Express 21 (2013) 25664.

F. Da Ros et al., Opt. Express 21 (2013) 28743.  
 F. Da Ros et al., IEEE Photon. Technol. Lett. 26 (2014) 1207. 26

# Phase-sensitive wavelength conversion in Si

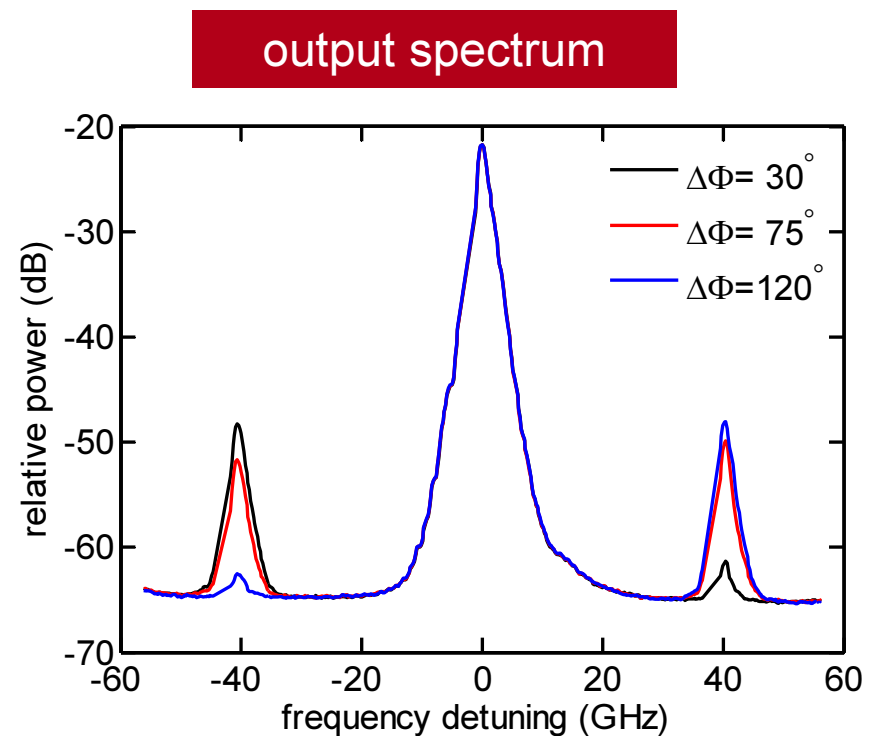
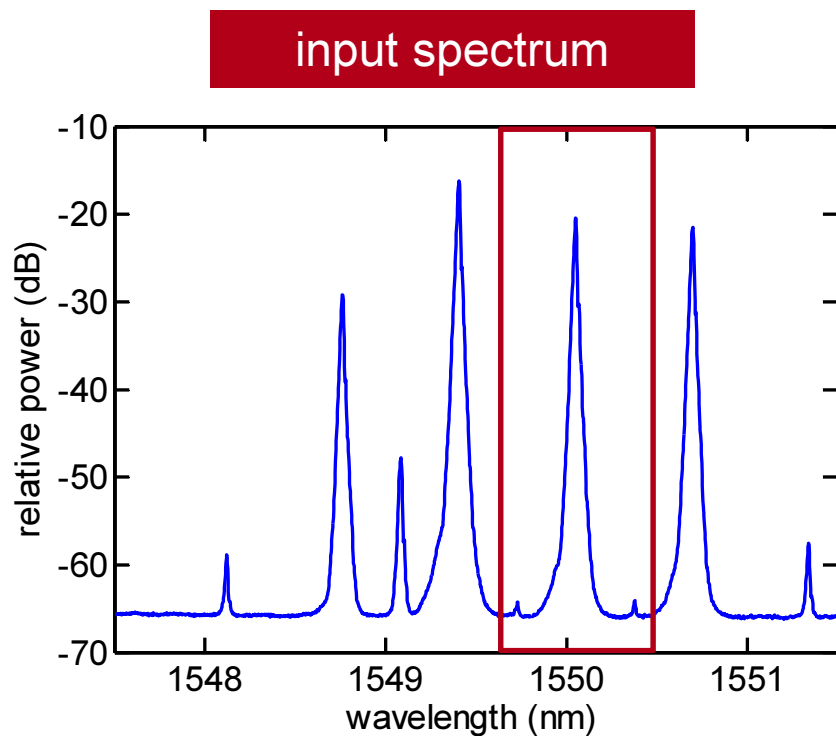

Power evolution of the idlers out of phase

# Conversion efficiencies of the idlers

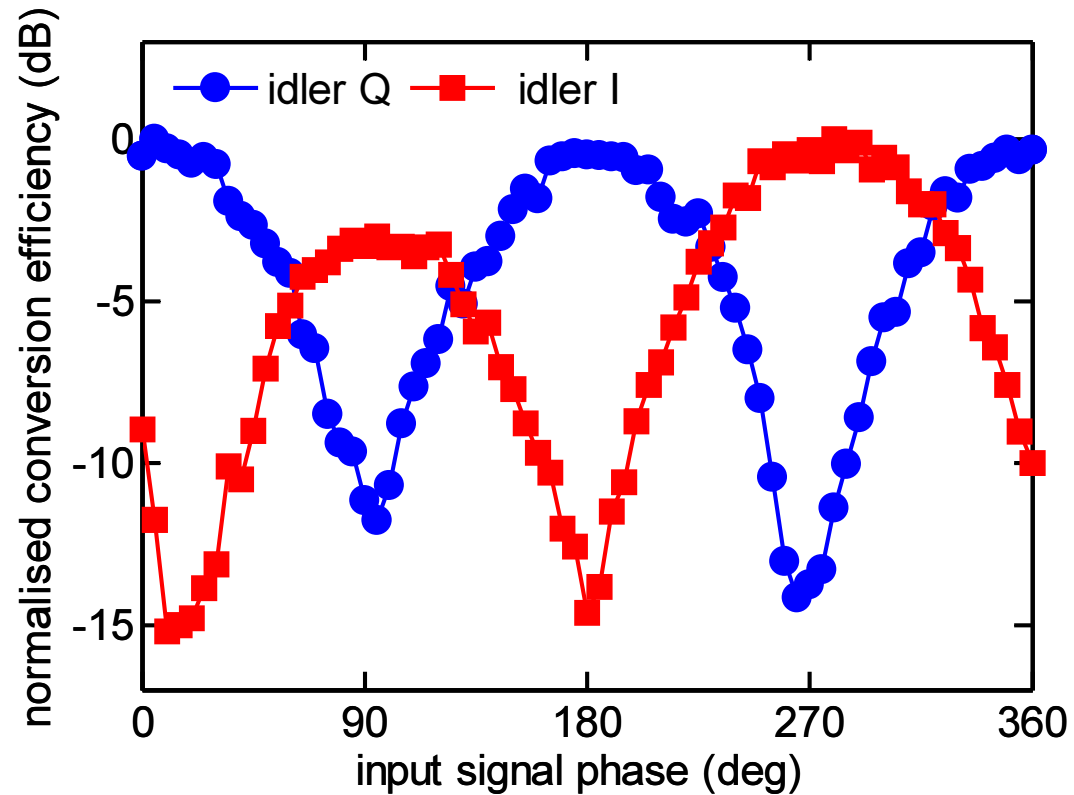

90° phase-shifted dependences of the conversion efficiencies of the idlers on the input signal phase

## Conversion efficiencies of the idlers

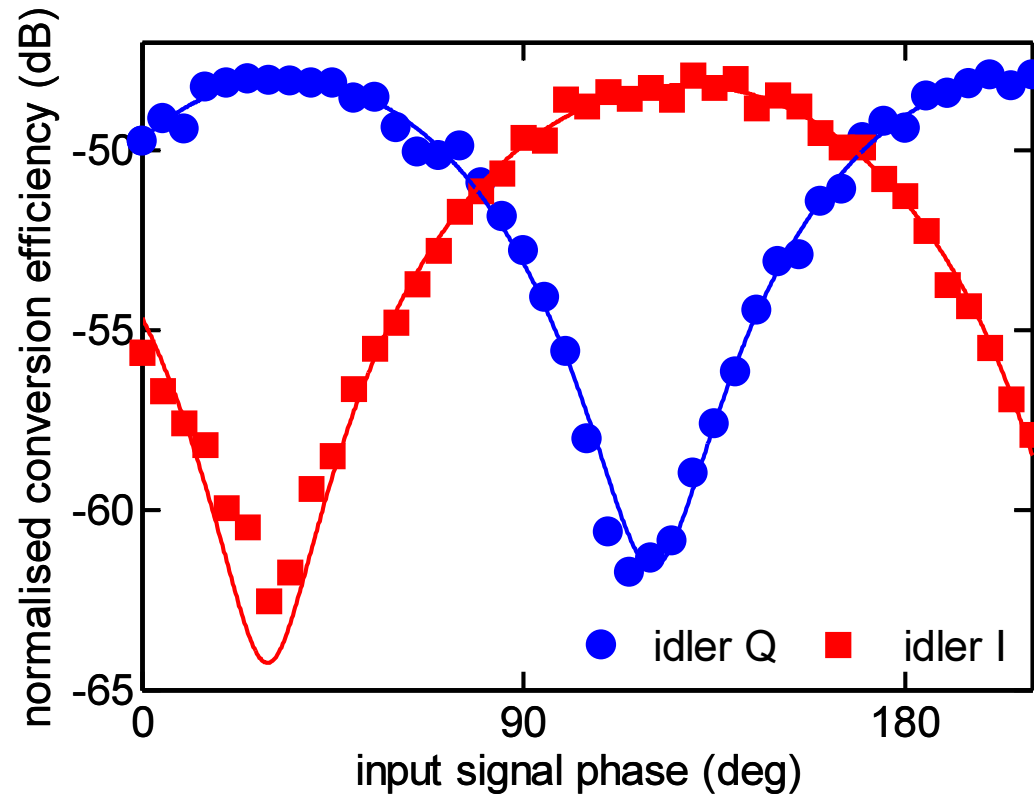

90° phase-shifted dependences of the conversion efficiencies of the idlers on the input signal phase

# Summary

- Silicon waveguides with p-i-n junctions have been designed and fabricated with good optical properties
- High-efficiency FWM wavelength conversion demonstrated at 40 Gbit/s
- First demonstration of phase-sensitive processes on-chip with CW pumping
- Complete phase regeneration demonstrated using 4 cm long waveguide

Trade-off silicon photonics compatibility with increased complexity of active removal of carriers

# Acknowledgments



**Danish Agency for Science  
Technology and Innovation**

Ministry of Science  
Technology and Innovation

VILLUM FONDEN

