



**HAL**  
open science

# Properties of Mode-Locked Optical Pulses in a Dispersion-Managed Fiber-Ring Laser Using Semiconductor Optical Amplifier as Active Device

Jacques W. D. Chi, Arnaud Fernandez, Chao Lu

► **To cite this version:**

Jacques W. D. Chi, Arnaud Fernandez, Chao Lu. Properties of Mode-Locked Optical Pulses in a Dispersion-Managed Fiber-Ring Laser Using Semiconductor Optical Amplifier as Active Device. 2012. hal-01024455

**HAL Id: hal-01024455**

**<https://hal.science/hal-01024455>**

Preprint submitted on 18 Jul 2014

**HAL** is a multi-disciplinary open access archive for the deposit and dissemination of scientific research documents, whether they are published or not. The documents may come from teaching and research institutions in France or abroad, or from public or private research centers.

L'archive ouverte pluridisciplinaire **HAL**, est destinée au dépôt et à la diffusion de documents scientifiques de niveau recherche, publiés ou non, émanant des établissements d'enseignement et de recherche français ou étrangers, des laboratoires publics ou privés.

# Properties of Mode-Locked Optical Pulses in a Dispersion-Managed Fiber-Ring Laser Using SOA as Active Device

Jacques W. D. Chi, Arnaud Fernandez, and Chao Lu, *Member, IEEE*

**Abstract**—A hybrid model is proposed in order to exploit the idea of compensating SOA's nonlinearity by adjusting cavity dispersion in a SOA-fiber ring mode-locked laser. The model is checked by analytical as well as experimental results. Excellent agreement is obtained in both cases. It is predicted that, once the cavity dispersion is correctly adjusted, the mode-locked pulses of ~10ps width will become distortion-free Gaussians, with its time-bandwidth product (TB) very close to the fundamental Gaussian limit (TB=1/2) using root-mean-square definition. We will show evidence and explain why other waveforms, notably soliton, are highly unlikely in such a system. Some interesting effects related to band-pass filter are revealed. Our results highlight the ambiguity of TB using full-width at half-maximum (FWHM) definition. As a consequence, the widely adopted "Transform-limited Pulse" in its FWHM version might be misleading.

**Index Terms**—Optical pulses, pulse generation, semiconductor fiber ring laser, transform-limited pulse, ultrafast optics.

## I. INTRODUCTION

OPTICAL pulses as clean as possible, *i.e.* distortion-free and containing few chirp in both its time waveform and spectrum, are highly important everywhere they appear. In theoretical studies, notably in mode-locked lasers, models are built assuming ideal waveforms such as Gaussian [1] and soliton [2]. In optical communication networks using time- or wavelength-division multiplexing (TDM or WDM), a clean pulse train increases data transmission capacity by reducing the time slot per bit at a given bandwidth (TDM), or reducing its bandwidth per channel at a given bit-rate (WDM). Therefore, how to obtain a clean optical pulse train fast enough for such applications, and how to measure it, are of remarkable importance and vast implications.

The cleanness of an optical pulse is most objectively and quantitatively measured by its time-bandwidth product (TB)

using root-mean-square (RMS) definition, *i.e.* the standard deviation of energy densities of a signal in the time- and frequency domain. The *Uncertainty Principle* states that  $TB \geq 1/2$ , the equality being uniquely obtained with an ideal (chirp-free) Gaussian [1], [3]. For an ideal hyperbolic secant (first-order soliton), we calculated  $TB = 0.5236$ . Therefore, if one obtains for sure  $0.5 \leq TB < 0.5236$  for an optical pulse, it cannot be a soliton but might be a chirped Gaussian. In this paper, we will use this method to distinguish a soliton and a Gaussian. In the following we call  $TB = 1/2$  as the Gaussian limit, and a pulse with  $TB \sim 0.5$  as a Gaussian-limited pulse, in contrast to a transform-limited pulse [1]. This last one routinely applies to a pulse with  $\Delta f \Delta t \sim 0.5$ ,  $\Delta f$  and  $\Delta t$  being intensity full-width at half-maximum (FWHM) in the frequency- and time domain, respectively. As will be shown and discussed later, it turns out that  $\Delta f \Delta t$ , and hence the notion of Transform-limited Pulse in FWHM version, are ambiguous and might be misleading. The situation could be even worse if  $\Delta t$  is obtained using autocorrelation technique [4].

In our attempt to achieve clean pulses, we have carried out an experiment using a semiconductor optical amplifier (SOA) and dispersion-compensating fiber (DCF) to form a ring laser [5]. As has been explained in [5], the objective is to compensate SOA's nonlinearity, mainly caused by carrier dynamics, by an appropriate amount of negative dispersion [6]. The resulting actively mode-locked pulses at 10GHz repetition rate are indeed transform-limited, with  $\Delta f \Delta t = 0.46$ . In this experiment, noticeably, the pulse's shape is not estimated by autocorrelation plus curve-fitting, but directly observed with a fast optical sampling oscilloscope; the spectrum is obtained using a high-resolution optical spectrum analyzer. This provides an excellent opportunity to test a theoretical model about mode locking which, once validated, could reply to some interesting questions: 1) What these transform-limited pulses really are? Could they reasonably be approximated by Gaussians or solitons? 2) How close these pulses could be to the fundamental Gaussian limit, once relevant parameters are optimized?

Keeping these questions in mind, we propose and develop the present hybrid model, based on the experiment in [5]. In this model, the SOA's behavior is described and then resolved

Manuscript received August 28, 2012. J. W. D. Chi is with Ecole Nationale d'Ingénieurs de Brest (ENIB), Laboratory RESO/Lab-STICC, CP. 29608, Brest, France (phone : +33 298 055 6636; fax: +33 298 055 6689; email: chi@enib.fr).

A. Fernandez is with LAAS Toulouse, 7 av. du Colonel Roche, 31077, Toulouse Cedex 4, France (email: afermand@laas.fr).

Chao Lu is with Polytechnic University, Department EIE, Kowloon, Hong Kong (email: [enluchao@polyu.edu.hk](mailto:enluchao@polyu.edu.hk)).

in the time domain, results are checked by analytical formulas; the transmission out of SOA is calculated in the frequency domain. The overall precision is estimated to be  $\sim 10^{-4}$  in the evaluation of TB, which is good enough for addressing the above questions.

In Section II, the experiment in [5] and relevant results are briefly reminded for consistency. The hybrid model and the algorithm are developed in Section III, together with comparisons between the model's predictions and available analytical results. In Section IV, the experimental condition is applied to the model so as to directly check its output, followed by detailed inspection of optical pulses' properties in similar conditions. Our conclusions are presented in Section V.

## II. EXPERIMENT

The experimental setup is shown in Fig. 1.

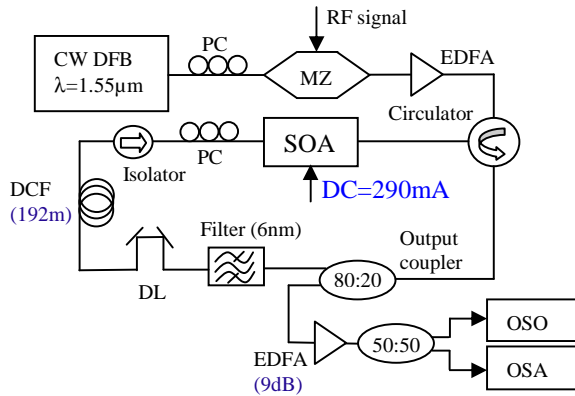

Fig. 1. Experimental setup. MZ: Mach-Zehnder amplitude modulator; PC: polarization controller; DL: delay line; EDFA: erbium doped fiber amplifier; DCF: dispersion compensating fiber; OSO: optical sampling oscilloscope; OSA: optical spectrum analyzer.

In this experiment, the SOA (by CIP, ref. SOA-NL-OEC) as the gain medium exhibits 1dB polarization gain dependence. It has a multi-quantum-well (10 wells) structure with a length  $L_{\text{SOA}}=1.5\text{mm}$ , shows its peak gain at 1555nm, and provides 28dB small-signal optical gain at 290mA DC drive. Its optical gain is periodically modulated at 10GHz by an optical back-injection. The noise in the ring will circulate clockwise, and eventually grow into mode-locked pulses if conditions are propitious. The band-pass filter serves to locate the carrier frequency, as well as to limit the noise level in the ring cavity. The length of DCF is estimated using a model in [7]. The characteristics of all these components are either provided by their producers, or measured by ourselves [5]. All of them are commercially available. The modulation and the filter functions are also measured and will be given in Section III. The parameters adopted are given in Table 1.

The average power of the extracted pulse train is  $\sim 0.3\text{mW}$  (with an average back injection power of  $\sim 9\text{mW}$ ), its spectral width is less than 1nm. This pulse train is first boosted by an EDFA with +9dB gain. Compared to EDFA's saturation power ( $\sim 10\text{mW}$ ) and its amplification bandwidth ( $>35\text{nm}$ ) [8], the

differences are 1~2 orders of magnitude for both values. Therefore, the pulse's original shape and spectrum are preserved after EDFA. The amplified pulse train is then analyzed simultaneously by an optical sampling oscilloscope (OSO, Ando AQ7750), with its input bandwidth of 500GHz and a resolution of 0.6ps in time, and by an optical spectrum analyzer (OSA, Apex AP2440A), with its spectral resolution of 0.16pm or 20MHz between  $\lambda=1520 \sim 1567\text{nm}$ . The peak power in the ring cavity, just before the output coupler, is estimated to be  $\approx 12\text{mW}$ .

The oscilloscope trace of the output pulse train is shown in Fig. 2. These pulses have a FWHM width of  $\Delta t \approx 12\text{ps}$ . Notice that there are some slight fluctuations around the peaks. The spectrum has been shown in Fig. 2(d) in [5], together with a Gaussian fit. The fitting quality there is excellent. The product  $\Delta f \Delta t = 0.46$  is thus obtained. Therefore, these pulses are indeed transform-limited (always in FWHM version).

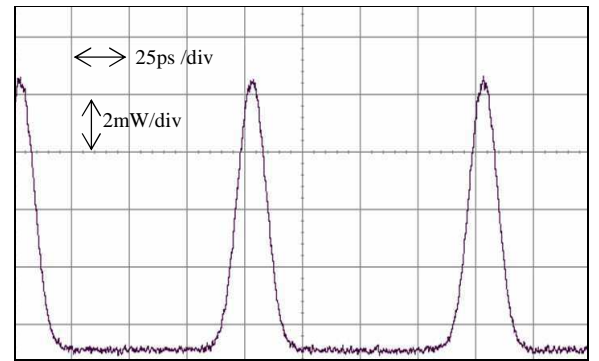

Fig. 2. Oscilloscope trace of the output pulse train.

It should be noticed that the insertion of DCF into the ring cavity is not easy [9], due to structure and material differences between DCF and single-mode fiber (SMF) used for linking different elements. The insertion loss per facet of DCF could be as low as -2dB in our experiment, but that value is far from regularly obtainable. This is the reason why it is difficult, at least for now, to insert a designed length of DCF into the ring laser while maintaining an acceptable insertion loss.

## III. MODEL AND ALGORITHM

### A. Hybrid Model

The schematic of the model is depicted in Fig. 3.

Recognizing that pulse width  $\Delta t \geq 6\text{ps}$  in general in SOA-related lasers excluding external pulse compression, it is not necessary in the present model to include the effect of gain dispersion, since its time constant is  $\sim 0.1\text{ps}$  [10]. Other ultrafast effects, notably two-photon absorption, are also neglected for the same reason and the fact that optical power level is moderate here [11]. In this regime, the dominant physical effects inside SOA are carrier recovery and gain saturation. Assuming slowly-varying envelopes, the electrical field in SOA is

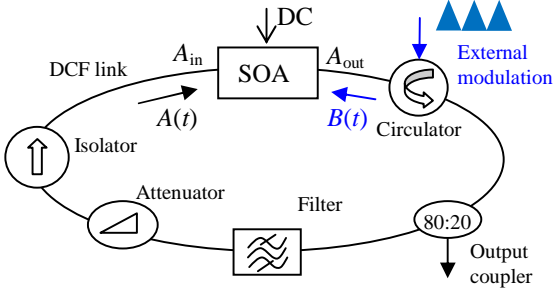

Fig. 3. Schematic of the model

$$E(z, t) = [A(z, t) \exp(i\beta_0 z) + B(z, t) \exp(-i\beta_0 z)] \times \exp(-i\omega_0 t) \quad (1)$$

Here,  $A$  and  $B$  are the forward (+ $z$ ) and the backward (- $z$ ) field envelopes,  $\beta_0$  and  $\omega_0$  are the free-space propagation constant and the carrier frequency, respectively. Lateral and polarization effects are ignored. Notice that the carrier frequencies for  $A$  and  $B$  are independent, but this makes no difference in the model. The propagation for  $A, B$  is described by [6], [7]:

$$\partial_z A + v_g^{-1} \partial_t A = \frac{1}{2} [g(1 - i\alpha_H) - \alpha_{int}] A \quad (2)$$

$$-\partial_z B + v_g^{-1} \partial_t B = \frac{1}{2} [g(1 - i\alpha_H) - \alpha_{int}] B \quad (3)$$

Together with the rate equation for the optical gain  $g(z, t)$ :

$$\partial_t g = \frac{g_0 - g}{\tau} - g \frac{(|A|^2 + |B|^2)}{E_{sat}} \quad (4)$$

In the above equations,  $v_g$  is the group velocity in SOA,  $\alpha_H$  is the Henry's factor,  $\alpha_{int}$  is SOA's internal loss coefficient,  $g_0$  is the small-signal optical gain,  $\tau$  is the carrier lifetime,  $E_{sat}$  is the saturation energy. Due to a narrow frequency bandwidth involved, these parameters are assumed to be constant. Notice that the noise term is not explicitly present in (2)-(4), it will be included as an additional input afterward.

The SOA's output envelop ( $A_{out}$  in Fig. 3) makes a roundtrip through the ring, and emerges as a renewed input  $A_{in}$ . The transmission of the pulse train in the fiber link of ~200m could be considered as linear, since with a peak intensity of ~10mW, the nonlinear length  $L_{NL}$  will be ~50km for a typical SMF [12]. Therefore, nonlinear effects in the fiber link are not a concern, even though relevant fiber parameters in our experiment differ from those in [12]. Consequently, the transmission through the fiber link could be described by a transfer function in the frequency domain,

$$H(\omega) = \frac{\tilde{A}_{in}^{N+1}(\omega)}{\tilde{A}_{out}^N(\omega)} = \eta \times \exp \left[ -\frac{1}{2} \left( 2\sqrt{\ln 2} \frac{(\omega - \omega_0)}{B_{PB}} \right)^4 \right] \times \exp \left[ i\beta_2 L \frac{(\omega - \omega_0)^2}{2} \right] \quad (5)$$

Here,  $\tilde{A}_{in}^{N+1}$  and  $\tilde{A}_{out}^N$  are the frequency-domain presentations of  $A_{in}^{N+1}$  and  $A_{out}^N$ , respectively, with the integer  $N$  denoting the number of roundtrip;  $\eta$  is the total amplitude attenuation, including the loss from the output coupler;  $B_{PB}$  is the bandpass filter's 3dB bandwidth, its flat-top form is checked by us and is well-fitted by the first exponent above. For simplicity, we assume that the filter is centered at  $\omega_0$ . The consequence of this assumption will be discussed later. The second exponent depicts the effect of group velocity dispersion (GVD) in the fiber link,  $\beta_2$  is the GVD parameter averaged throughout the link, and  $L$  is the total length of the ring. In the following, we replace  $\beta_2$  by the dispersion parameter  $D$  through the relation  $D = -2\pi c \beta_2 / \lambda^2$ , with  $\lambda = 1.55 \mu\text{m}$ . Higher-order dispersion is neglected due to relatively long pulse widths and the high value of  $\beta_2$  involved [12], in consistency with the rest of the model.

Some other components are also implicitly contained in (5). These include a polarization controller, whose attenuation is accounted for by  $\eta$ , and an optical delay for synchronization. It is assumed that harmonic mode-locking is achieved, *i.e.* the roundtrip delay corresponds to an exact multiple of modulation period. This explains the absence of  $\beta_1$  (the inverse of the group velocity in the fiber) in (5). In effect, the optical delay in Fig. 1 is already included in the total fiber length  $L$ . Mode-locking is achieved if with a big enough  $N$  ( $\sim 10^2$ ),  $|A_{in}^{N+1}| = |A_{in}^N|$ . The hybrid model is thus complete.

### B. Algorithm

Since (5) is essentially error-free, the resolution of (2)-(4) determines the precision of the model. In order to achieve high precision, we have upgraded the algorithm in [7] to a higher order. The detailed formulation is available in [13], which adopts a predictor-corrector strategy [14], and is equivalent to the well-known 4<sup>th</sup>-order Runge-Kutta algorithm in terms of convergence [15]. Notice that the effect of gain dispersion is included in [13] as well, in order to take on optical pulses as short as ~1ps in future studies.

To adapt the above algorithm to the experiment in Fig. 1, the modulation period is divided into  $2^M$  equal intervals (256 to begin with, up to 4096 to ensure convergence and precision). For a 10GHz signal, this corresponds to a stepsize of  $\delta t = 100/2^M$  [ps]. The SOA is divided accordingly, with a space division  $\delta z = v_g \delta t$ .

At  $t=0$ , a trigger signal  $A_{in}^0(t)$  at the front facet, and the back injection (modulation) signal  $B(t)$  at the rear facet, are simultaneously injected into SOA. The trigger  $A_{in}^0$  could be a random signal emulating a noise, or simply a sinus

$A_{in}^0 = a \sin(bt)$  with arbitrary  $(a, b)$ , or a combination of both. As a matter of fact, we observed that the final outcomes are independent of the choice of  $A_{in}^0$ , as long as this last one has reasonable peak power (at -40dBm, say). Meanwhile, the modulation signal can be written as [1]

$$B(t) = B_0 \exp[-\Delta_m(1 - \cos \omega_m t)] \quad (6)$$

where  $B_0$  is the peak amplitude of the modulation envelop,  $2\Delta_m$  is the modulation index, and  $\omega_m = 2\pi \times 10^{10}$  is the modulation frequency. This function has been verified in [5]. The output envelop  $A_{out}^0(t)$  is then calculated using the algorithm mentioned above. It is converted to  $\tilde{A}_{out}^0(\omega)$  by Fourier transform (FT). The next input  $A_{in}^1(t)$  is obtained from

$$A_{in}^1(t) = FT^{-1} \left[ H(\omega) \tilde{A}_{out}^0(\omega) \right] \quad (7)$$

A complete roundtrip is thus accomplished. A random noise emulating spontaneous emissions in SOA could be added to  $A_{in}^1$ , as well as to the following roundtrips. It is observed, however, that the final outcomes are insensitive to such a noise, as long as its power level is realistic (-40dBm is applied in our simulations). The only perceptible consequence is a slight fluctuation ( $\sim 10^{-4}$ ) of TB. This observation might be explained by the permanent presence of a large number of coherent photons in SOA. In effect, even at its intensity trough,  $|B|_{min}^2 \approx 7.4 \text{ mW}$  (using  $B_0^2 = 30 \text{ mW}$  and  $\Delta_m = 0.7$ ), which is far more intense than any possible noise. Therefore, spontaneous emissions could not grow perceptibly (except those photons joining mode-locked pulses) and remain weak enough to be neglected. Consequently, all noises are ignored after the trigger  $A_{in}^0$ .

The new input  $A_{in}^1(t)$  is synchronized to  $B(t)$  to obtain  $A_{out}^1(t)$ , while the optical gain  $g(z, t)$  in the SOA remains what it is after the precedent passage of  $A$  and  $B$ , as described in the algorithms in [7] and [13], *i.e.*  $g(z, t)$  is not reset to its initial state  $g = g_0$ . This simply reflects the fact that every time slot is occupied by a pulse in harmonic mode-locking. After  $N \sim 100$  roundtrips in favorable conditions, two consecutive inputs will have the same amplitude distribution,  $|A_{in}^{N+1}| = |A_{in}^N|$ , the steady state is thus achieved; otherwise  $|A_{in}^{N+1}| \neq |A_{in}^N|$  whatever  $N$  is, the mode locking will not happen. The results presented in the next section are obtained with  $N=200$ .

### C. Theoretical verification

Recall that for an arbitrary signal  $A(t)$ ,

$$\begin{aligned} TB &= \sigma_t \cdot \sigma_\omega \\ \sigma_x &= \langle x^2 \rangle - \langle x \rangle^2 \quad (x=t, \omega) \\ \langle x^n \rangle &= \frac{1}{E} \int_{-\infty}^{\infty} x^n I(x) dx \end{aligned} \quad (8)$$

$$E = \int_{-\infty}^{\infty} I(x) dx$$

where  $I(t) = |A|^2$  and  $I(\omega) = |\tilde{A}|^2$  are the intensities in the time- and frequency domain, respectively. The integration limits  $(-\infty, \infty)$  are replaced by  $(0, T)$  for a periodic signal, and  $E$  is the signal's energy in one period. The integrations in (8), as well as in the following, are carried out using the 6<sup>th</sup>-order Bode's rule [14].

For an ideal Gaussian,  $TB = 1/2$  and  $\Delta f \Delta t = 2 \ln(2) / \pi$  [1]. These two reference values could test the precision of the chain of calculation, including integration, FT, sampling rate, speed of convergence, and so on. We calculated that for an ideal Gaussian,  $A_1 = \exp[-(t-t_0)^2 / \tau_0^2]$ ,

$$TB = 0.5 \pm 0.0002, \quad \Delta f \Delta t = 0.44127 \pm 0.00005 \quad (\text{Gaussian})$$

where  $\tau_0$  and  $t_0$  are arbitrary parameters. Compared with the exact values, the relative errors are  $\sim 10^{-4}$ . For a chirp-free soliton,  $A_2 = \text{sech}[(t-t_0) / \tau_0]$ , the results are

$$TB = 0.5236 \pm 0.0002, \quad \Delta f \Delta t = 0.327 \pm 0.002 \quad (\text{soliton})$$

The larger fluctuation ( $\sim 10^{-3}$ ) of a soliton's  $\Delta f \Delta t$  is because there is no analytical function to estimate its spectral FWHM using least-squares fitting [14]. The method of interpolation has to be used, resulting in some uncertainty at  $10^{-3}$  level. However, a less accurate estimate of  $\Delta f \Delta t$  does not degrade the precision of the calculated pulse itself. Notice also that a chirp-free soliton's TB is higher than that of a chirp-free Gaussian, but the opposite is true for  $\Delta f \Delta t$ . This discordance between TB and  $\Delta f \Delta t$  reveals the important fact that  $\Delta f \Delta t$  is not a good enough measure for judging the overall cleanness of a signal.

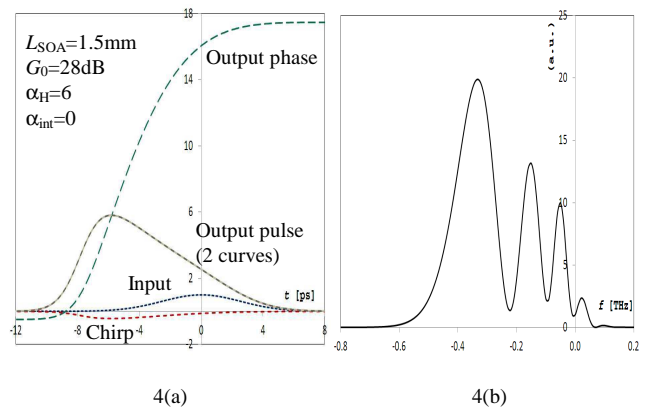

Fig. 4. Amplification of a 3ps Gaussian pulse by SOA. 4(a): The input and the output pulses' (theory and calculation) intensities in a linear scale, output pulse's phase in radian, and its chirp in THz. Notice that  $t$  is traced in a moving coordinate at the group velocity. 4(b): Spectrum of the output pulse.

The precision of the model in nonlinear regime could be tested by launching an ideal Gaussian into SOA, and then comparing the amplified pulse with the analytical result in [6].

Fig. 4(a) shows the result using a Gaussian of  $\Delta t=3\text{ps}$  and  $E=E_{\text{sat}}$ . Other parameters are indicated in the figure. Fig. 4(b) is the spectrum of the output pulse. As can be seen in Fig. 4(a), the shape of the calculated output pulse is seamlessly superposed with the theoretical curve. The calculation error of the algorithm in this nonlinear regime is difficult to estimate, since the theoretical curve itself involves integrations [6]. It is reasonable, however, to assume that the relative error in Fig. 4(a) is of the same order as in the evaluation of (8), since the method of integration is the same. Consequently, we will adopt 4 digits for TB and 3 digits for  $\Delta f\Delta t$  in the following results.

The optical phase  $\phi(t)$  of the output envelop has a ‘‘S’’ form, resulting in a nonlinear negative chirp, defined by  $\delta f^c = -(2\pi)^{-1} \partial_t \phi$  in THz. The spectrum of this output pulse is highly distorted, as shown in Fig. 4(b). This output pulse has TB=2.677, which is far higher than the Gaussian limit. Due to its multi-peak spectrum, its  $\Delta f\Delta t$  is hardly meaningful and is not estimated.

It could be said, therefore, that the numerical procedures used in this paper are trustworthy; its predictions are in excellent agreement with available theoretical results.

#### IV. PROPERTIES OF MODE-LOCKED PULSES

The above algorithm is then applied to the experiment of Fig. 1, where the total fiber dispersion is estimated to be  $DL=-25\text{ps/nm}$ ; the filter bandwidth is  $B_{\text{BP}}=6\text{nm}$ ; the average optical power injected into the rear facet is measured to be  $9\text{mW}$ , its peak intensity is therefore  $B_0^2 \approx 23.5\text{mW}$  according to (6) with  $\Delta_m=0.7$ . Substituting these values in the algorithm, mode-locking is obtained with  $0.145 \leq \eta \leq 0.185$ , which corresponds to a total transmission loss of  $20\log_{10} \eta = -16.8 \sim -14.7\text{dB}$  outside SOA. With  $\eta < 0.145$ , the peak intensity of the output pulse will drop quickly below the noise level; if  $\eta > 0.185$ , the SOA output will be chaotic and there will be no mode locking. Fig. 5 shows the result obtained with  $\eta=0.152$ , which corresponds most likely to the experimental observation of Fig. 2.

As can be seen in Fig 5(a), the peak intensity of the output pulse  $|A_{\text{out}}|_{\text{max}}^2 = 12.5\text{mW}$ . After passing through an output coupler (80:20), an EDFA amplifier (9dB) and a 50:50 power splitter, the peak intensity at the OSO in Fig. 1 should be  $12.5 \times (0.2 \times 10^{9/10} \times 0.5) = 9.93\text{mW}$ . Taking into account some uncertainties, such as mode conversion loss between SOA and SMF, this value is in good agreement with the experimental result of  $9.2\text{mW}$  in Fig. 2. The calculated  $\Delta f\Delta t = 0.459$ , which is the same as experimental result ( $=0.46$ ). Moreover, the calculated pulse’s waveform and spectrum are both well fitted by Gaussians, as shown in Fig. 5. This is also the case for experimental results in [5]. Furthermore, the slight fluctuation around the output pulse’s peak in Fig. 5(a) is indeed observed in Fig. 2, confirming once again the precision of the model and the algorithm, as well as the high resolution of the fast OSO. Notice also that the main peak in the spectrum is red-shifted of about  $-0.1\text{THz}$  relative to the carrier frequency (at  $f=0$ ).

TABLE I  
PARAMETERS USED IN THE SIMULATION

Symbol	Quantity	Value or relation
$\alpha_H$	Henry’s factor	6.0
$\alpha_{\text{int}}$	SOA’s internal loss	$8.86\text{ cm}^{-1}$
$\beta_0$	wavenumber	$2\pi/\lambda$
$B_{\text{BP}}$	Filter bandwidth	variable, 5~6nm
$E_{\text{sat}}$	SOA’s saturation energy	0.5 pJ
$2\Delta_m$	modulation index	1.4
$D$	dispersion parameter	-139.2 ps/(nm·km) for DCF (to be averaged with SMF)
$g_0$	small-signal gain	$51.84\text{ cm}^{-1}$ ( $G_0=28\text{dB}$ net gain)
$L_{\text{SOA}}$	SOA’s length	1500 $\mu\text{m}$
$L$	total length of the ring	variable ( $DL=-10\sim-25\text{ ps/nm}$ )
$\lambda$	wavelength	1.55 $\mu\text{m}$
$\omega_0$	carrier frequency	$2\pi c/\lambda\text{ s}^{-1}$ ( $c=3 \times 10^8\text{ m/s}$ )
$\omega_m$	modulation frequency	$2\pi \times 10^{10}\text{ s}^{-1}$
$v_g$	group velocity in SOA	$c/4\text{ m/s}$
$\tau$	carrier lifetime	16 ps

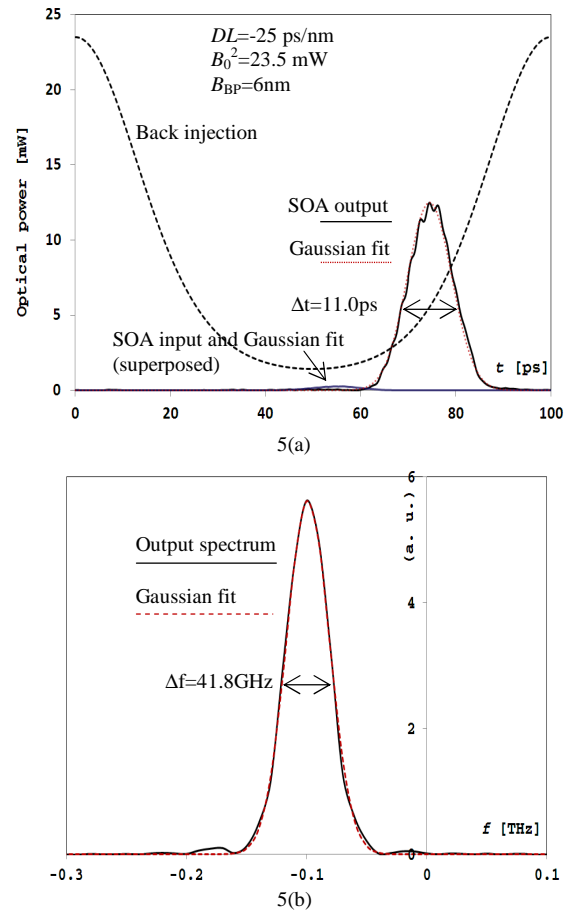

Fig. 5. Mode-locked pulse at  $\eta=0.152$ . 5(a): Intensities of input pulses (2 consecutive inputs totally superposed) measured at the front facet ( $z=0$ ), output pulse (with a Gaussian fit) and back injection intensities measured at the rear facet ( $z=L_{\text{SOA}}$ ). The time shift between the input and the output pulses corresponds to the transmission delay in SOA. 5(b): Spectrum of output pulse with a Gaussian fit.

With its  $\Delta f\Delta t=0.459$ , this output pulse is well qualified as transform-limited, even though some fluctuations can be

observed in both its waveform and spectrum. However, it has  $TB=2.526$ . This value is comparable to that obtained in Fig. 4, where severe distortions are clearly observed in both amplified pulse's waveform and spectrum.

As a matter of fact, the output pulse's waveform in Fig. 5(a) and its spectrum in Fig. 5(b) stretch widely below their half-maximum levels, resulting in the poor TB value above. These low-level fluctuations cannot be filtered out, however. By using a narrow-band filter (0.5~1nm) around the pulse's spectrum in Fig. 5(b), the pulse will change substantially its shape and spectrum, or simply collapse. This behavior is not revealed by its  $\Delta f \Delta t$  value, in contrast to its TB. This issue will be further illustrated and discussed in the following examples.

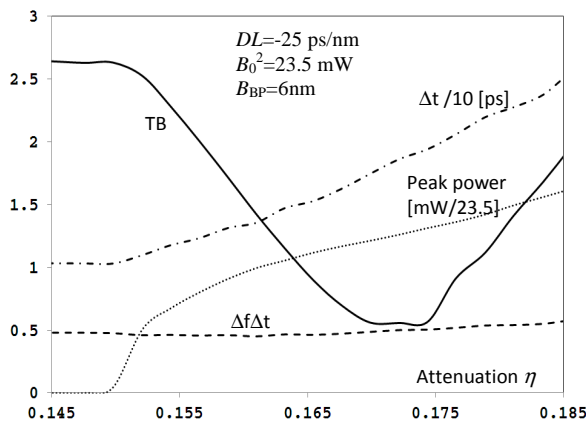

Fig. 6. Properties of mode-locked pulse at different cavity attenuation  $\eta$ . Pulse's width is divided by 10, its peak power is normalized to  $B_0^2=23.5$ mW.

The output pulse's  $\Delta t$ ,  $\Delta f \Delta t$ ,  $TB$ , as well as its normalized peak power  $|A_{out}|_{max}^2/B_0^2$  within the mode-locking range, are traced in Fig. 6. As can be seen in Fig. 6, the values of  $\Delta f \Delta t$  within the entire locking range remain very close to 0.5 and, therefore, the output pulse is always transform-limited. In contrast, its  $TB$  values vary strongly, with the minimum point  $TB=0.5551$  obtained at  $\eta=0.172$ . At this point, the pulse has similar properties as those in Fig. 7 in terms of phase and chirp, and will be discussed together there. The fundamental Gaussian limit is thus still some distance away. It is not obvious to experimentally localize this minimum  $TB$  point using other, more measurable quantities as background. Notice also that, by adjusting the cavity loss, it is possible to obtain transform-limited pulses with a width  $\Delta t=10\sim 25$ ps and a peak power of a few mW after the output coupler.

With  $DL=-25$ ps/nm, as well as with other  $DL$  values used in the following, it is possible to obtain mode-locked pulses using other sets of parameters. In the above case of  $DL=-25$ ps/nm, for example, the model predicts that mode-locking can happen with  $B_0^2$  varying from a few tens of mW up to well beyond 100mW, if  $G_0=28$ dB and  $B_{BP}=6$ nm are maintained. However, an increasing  $B_0^2$  reduces the effective SOA gain for mode-locked pulses, the cavity loss has to be reduced ( $\eta$  increased) to compensate the effect, as the model correctly predicts in

agreement with physical insight. The problem of DCF-SMF link, mentioned in Section II, might then become a hurdle.

In order to further reduce the minimum value of  $TB=0.5551$  obtained with  $DL=-25$ ps/nm,  $DL$  and  $B_0^2$  are allowed to change in the simulation, while other parameters in Table 1 are kept unchanged. Fig. 7 shows the result obtained with  $DL=-23.4$  ps/nm,  $B_0^2=36.8$ mW and  $\eta=0.182$ .

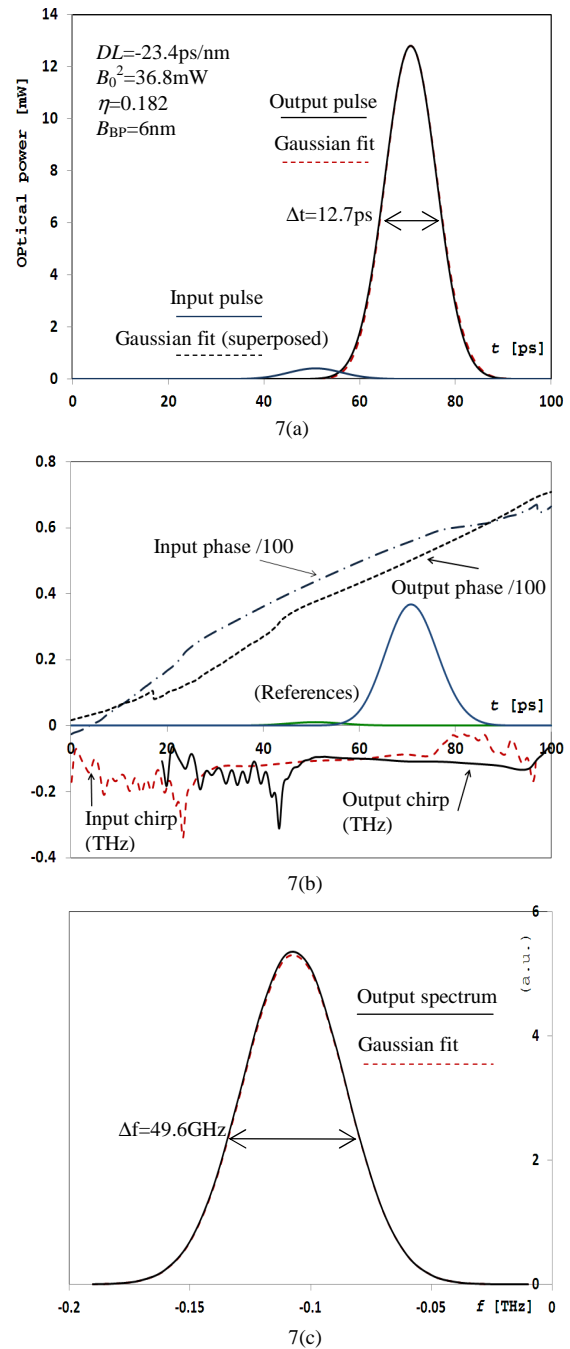

Fig. 7. Pulses obtained with  $DL=-23.4$ ,  $B_0^2=36.8$ mW and  $\eta=0.182$ . 7(a): Input and output pulses' shapes and their Gaussian fits; 7(b): Correspondent optical phases (/100) in radian and chirps in THz; 7(c): Output spectrum with a Gaussian fit.

The output pulse in Fig. 7 has  $TB=0.5086$ , which is very close to the fundamental Gaussian limit. It is even below that of an ideal hyperbolic secant (0.5236). The difference between the two values is well beyond the error margin in the calculation of  $TB$ . As a consequence, this pulse cannot be a soliton. Notice that this remark is based on  $TB$ , not on curve fitting or  $\Delta f \Delta t$ .

From a theoretical point of view, only in the limit of slowly saturating gain, the master equation in [2] could become the nonlinear Schrödinger equation (NSE), whose solution is a soliton. This assumption is acceptable for erbium doped fibers, where the carrier lifetime of  $\sim 10\text{ms}$  is far longer than the pulse widths [2]. In the case of SOA, however, the carrier lifetime is comparable to the pulse widths, this assumption is not true. In contrast, the master equation in [1] does not require the above condition. Instead, it applies the quadratic approximation,  $\cos(\omega_m t) \approx 1 - (\omega_m t)^2/2$  around  $t=0$  in (7), which is usually acceptable around the trough of the modulation function (see Fig. 5(a)). Unsurprisingly, therefore, SOA-related lasers, such as this one, would most likely support Gaussian pulses, if cavity dispersion is correctly adjusted.

Interestingly, the pulse in Fig. 7 is hardly transform-limited ( $\Delta f \Delta t = 0.634$ ), even though both its waveform and spectrum are remarkably well fitted by Gaussians. Here, once again,  $TB$  and  $\Delta f \Delta t$  deliver contradictory signals about the cleanness of a pulse.

The optical phases and chirps illustrated in Fig. 7(b) could help understand why this pulse has such a low  $TB$ . Contrary to the nonlinear ‘‘S’’ shape of the phase in Fig. 4(a), both input and output pulses in Fig. 7(b) have nearly linear phases during the time slots where the pulses’ intensities are significant. As a consequence, their instantaneous frequencies (chirps) are nearly constant during the corresponding time slots. According to *Fourier Shift Theorem*, therefore, their spectra are simply red-shifted, as confirmed by Fig. 7(c). In effect, it is this nearly constant chirp which explains the cleanness of this pulse. Furthermore, a careful inspection of Fig. 7(b) reveals that the input and the output chirps have opposite slopes (upward for the input, downward for the output). This is the result of the dispersion management with DCF. In effect, the role of DCF in this ring laser is not to eliminate the spectral red-shift associated with SOA’s amplification, but to smooth the pulse’s phase so that the red-shift becomes nearly constant and therefore harmless regarding the cleanness of the pulse.

It is probable that the above  $TB=0.5086$  could be further reduced if  $G_0$  and  $\Delta_m$  are allowed to change as well. The interest of doing this seems limited, however, since it would not help gain more insight into the system.

Notice that the pulses in Figs. 5-7 are essentially unchanged to a varying  $B_{BP}$  between 5-8nm in the simulation, implying that the initial assumption of carrier frequency  $\omega_0$  being at the center of the filter is acceptable for these pulses, whose spectral spans are narrow compared to  $B_{BP}$ . Our simulation

also shows that clean pulses ( $TB < 0.6$  and  $\Delta f \Delta t \sim 0.5$ , say) can be expected in a range  $DL = -23 \pm 3\text{ps/nm}$  by adjusting  $B_0^2$  and  $\eta$  only (similar to Fig. 6). All these provide some margins for practical applications.

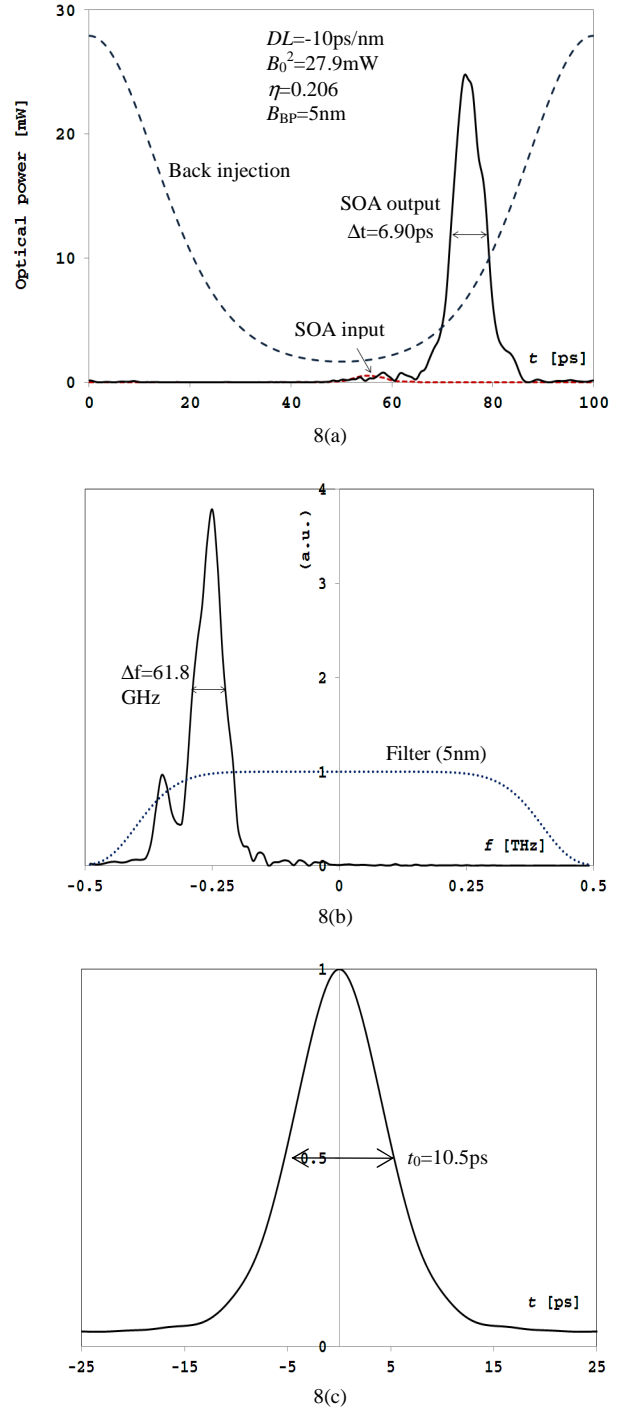

Fig. 8. Pulse obtained with  $DL = -10\text{ps/nm}$  and  $B_{BP} = 5\text{nm}$ .  
 8(a): Input and output pulses’ waveforms and the back injection;  
 8(b): Output pulse’s spectrum and the filter function;  
 8(c): Calculated intensity autocorrelation trace of the output pulse.



If the cavity dispersion  $DL$  deviates substantially from the above equilibrium point ( $DL \sim 23\text{ps/nm}$ ), however, the pulse's phase and chirp will become erratic, resulting in poor TB and misleading  $\Delta f \Delta t$  values. A typical example is shown in Fig. 8, which is obtained with  $DL = -10\text{ps/nm}$ ,  $B_0^2 = 27.9\text{mW}$ ,  $\eta = 0.206$  and, noticeably,  $B_{BP} = 5\text{nm}$ , which differs from previous cases ( $B_{BP} = 6\text{nm}$ ).

The output pulse in Fig. 8(a) has a peak power of  $24.8\text{mW}$  and a relatively narrow width of  $\Delta t = 6.90\text{ps}$ . It has complicated waveform and spectrum, resulting in  $TB = 10.31$ , a very poor value indeed. Meanwhile, its  $\Delta f \Delta t = 0.426$ , which paradoxically qualifies the pulse as transform-limited.

As shown in Fig. 8(b), the spectrum of this pulse is far more extended than previous cases of Figs. 5-7. As a result, the interaction of this pulse with the filter becomes important. In effect, the mode-locking cannot happen with  $B_{BP} = 6\text{nm}$  if other parameters are roughly the same as before. With the help of a narrower filter of  $5\text{nm}$ , the lower (red) end of the pulse's spectrum will be re-shaped and limited, as can be seen between  $f = -0.5 \sim -0.25\text{THz}$  in Fig. 8(b). Since the spectral energy is near zero on the other (blue) side of the filter, a narrower filter is effectively equivalent to a red-shift of the carrier frequency  $\omega_0$  from the center of a wider filter. In other words, it is the spectral distance between  $\omega_0$  and the red-end of the filter that matters, as long as  $B_{BP}$  is wide enough. As a consequence of this interaction between the pulse and the filter, the filter bandwidth  $B_{BP}$  should be allowed to change or, alternatively, the carrier frequency  $\omega_0$  needs to be shifted, in order to obtain mode-locked pulses in the condition of unbalanced dispersion. To the authors' best knowledge, this "red-wall" effect, *i.e.* the spectral re-shaping by the filter's red-end to stop pulses' excessive red-shift so as to maintain mode-locking, is not predicted before this study.

The second-order autocorrelation trace of the output pulse, calculated using *Wiener-Khinchin Theorem*, is shown in Fig. 8(c). It is remarkably clean, with the FWHM width  $t_0 = 10.5\text{ps}$ . This corresponds to  $\Delta t = 7.42\text{ps}$  if the initial pulse is supposed to be a Gaussian, or  $\Delta t = 6.77\text{ps}$  if a soliton is assumed [16]. Both values are in good agreement with the original one. Meanwhile, all details of the original pulse are washed out. Were this pulse indeed produced in an experiment, and then measured by the usual autocorrelation technique, it would not be difficult to fit the autocorrelation trace approximately with both assumptions. As a consequence, conclusions or theories that follow might be unrealistic. Therefore, independent of theoretical models or laser systems which may produce such a pulse, its potential existence should not be ignored.

## V. CONCLUSION

The model presented in this paper demonstrates its capability of predicting and analyzing the behaviors of mode-locked optical pulses in a SOA-fiber ring laser. The associated algorithm is shown to be accurate enough to address the questions asked at the beginning of the paper.

In the condition of adequate cavity dispersion, nearly perfect Gaussian pulses can be expected. Its time-bandwidth product using RMS definition could be very close to the fundamental Gaussian limit. These pulses would have a slight and linear chirp as a result of the dispersion management. Thanks to their narrow spectral widths, these pulses are resilient to parameter variations, including filter bandwidth change. If the cavity dispersion is not correctly adjusted, the cleanness of mode-locked pulses will degrade, as measured by their energy spreads in both time- and frequency domain. These pulses will then have rather complicated waveforms and spectra, and are consequently more sensitive to parameter variations.

It is also demonstrated that this SOA-fiber ring laser does not support optical solitons. The method and arguments developed in this paper could be applied to other similar laser systems using SOA as active devices.

The results obtained in this study highlight the inadequacy of  $\Delta f \Delta t$ , the time-bandwidth product using FWHM definition, as an objective criterion for judging the overall cleanness of a pulse. The correlation between the cleanness of a pulse and its  $\Delta f \Delta t$  value is not as strong as usually expected. As a consequence, the tacit significance of Transform-limited Pulse seems questionable, as well as its widespread use today.

The above results and observations are inseparable with a careful evaluation of optical phase. It is not obvious how to reveal the details of these pulses using intensity-based approaches such as autocorrelation. Indeed, some questions might be asked as to what extent an autocorrelation trace could be used, and whether the curve-fitting is trustworthy enough to serve beyond a pure illustrative propose.

## REFERENCES

- [1] A. E. Siegman, *Lasers*. University Science Books, 1986, ch. 9 and 27.
- [2] H. A. Haus, K. Tamura, L. E. Nelson, and E. P. Ippen, "Stretched-pulse additive pulse mode-locking in fiber ring lasers: Theory and experiment," *IEEE J. Quantum Electron.*, vol. 31, pp. 591-598, Mar. 1995.
- [3] L. Cohen, *Time-Frequency Analysis*. Prentice-Hall, 1995, ch. 3.
- [4] J. H. Chung, A. M. Weiner, "Ambiguity of ultrashort pulse shapes retrieved from the intensity autocorrelation and the power spectrum," *IEEE J. Selected Topics in Quantum Electronics*, vol. 7, pp. 656-666, July 2001.
- [5] A. Fernandez, C. Lu, and J. W. D. Chi, "All-optical clock recovery and pulse reshaping using semiconductor optical amplifier and dispersion compensating fiber in a ring cavity," *IEEE Photonics Technology Letters*, vol. 20, pp. 1148-1150, July 1, 2008.
- [6] G. P. Agrawal and N. A. Olsson, "Self-phase modulation and spectral broadening of optical pulses in semiconductor laser amplifiers," *IEEE J. Quantum Electron.*, vol. 25, pp. 2297-2306, Nov. 1989.
- [7] J. W. D. Chi, C. Lu, and M. K. Rao, "Time-domain large-signal investigation on nonlinear interactions between an optical pulse and semiconductor waveguides," *IEEE J. Quantum Electron.*, vol. 37, no. 10, pp. 1329-1336, Oct. 2001.
- [8] G. P. Agrawal, *Lightwave Technology*, Wiley Interscience, 2004, ch. 3.
- [9] B. Edvold and L. Gruner-Nielsen, "New technique for reducing the splice loss to dispersion compensating fiber," in *ECOC 1996*, Oslo, pp. 245-248, 1996.
- [10] G. P. Agrawal, "Effect of gain dispersion on ultrashort pulse amplification in semiconductor laser amplifiers," *IEEE J. Quantum Electron.*, vol. 27, no. 6, pp. 1843-1849, Jun. 1991.

- [11] M. Y. Hong, Y. H. Chang, A. Dienes, J. P. Heritage, P. J. Delfyett, S. Dijaili, and F. G. Patterson, "Femtosecond self- and cross- phase modulation in semiconductor laser amplifiers," *IEEE Select. Topics Quantum Electron.*, vol. 2, pp. 523-539, 1996.
- [12] G. P. Agrawal, *Nonlinear Fiber Optics*, 3<sup>rd</sup> ed., Academic Press, 2005, ch. 3 and 4.
- [13] J. W. D. Chi, A. Fernandez, and C. Lu, "A comprehensive modeling of wave propagation in photonic devices," *IET Commun.*, vol. 6, no. 5, pp. 571-576, 2012.
- [14] W. H. Press, S. A. Teukolsky, W. T. Vetterling, B. P. Flannery, *Numerical Recipes*, Cambridge University Press, 2<sup>nd</sup> ed., 1992, ch. 4, 15, and 16.
- [15] C. M. de Sterke, K. R. Jackson, and B. D. Robert, "Nonlinear coupled equations on a finite interval: A numerical procedure," *J. Opt. Soc. Amer. B*, vol. 10, no. 3, pp. 403-412, Mar. 1991.
- [16] See, for example, A. Yariv, *Optical Electronics in Modern Communications*, 5<sup>th</sup> ed., Oxford University Press, 1997, ch. 6.

**Jacques W. D. Chi** received his BEng degree in Electronic Engineering from Tsinghua University in Beijing, China, in 1985. He then studied in Institut d'Electronique Fondamentale (IEF) in University of Paris-11, France, and obtained there his MSc and PhD in Optoelectronics in 1987 and 1991, respectively.

He became an Assistant Professor in Ecole Nationale d'Ingénieurs de Brest (ENIB) in 1991. He is actually an Associate Professor in ENIB (Maître de Conférences Hors Classe, Habilitation pour Diriger la Recherche). He has carried out both experimental and theoretical studies in various topics in photonics, including nonlinear optics, semiconductor device modelling and optical communication technology. He is a member of Société Française d'Optique (SFO).

**Arnaud Fernandez** was born in Albi, France, in 1979. He received the Master Degree in electronic engineering from the National Engineering School of Brest in 2003 and his MSc and PhD from Université de Bretagne Occidentale, Brest, in 2004 and 2009 respectively.

His PhD thesis dealt with the theoretical and experimental study of intracavity dispersion management in an active mode-locked laser using a semiconductor optical amplifier in a fibre ring cavity. This study was expended to the application of such laser device in an all optical clock-recovery scheme. In 2012 he has joined the MOST group at LAAS-CNRS as an Assistant Professor.

**Chao Lu** (M'91) obtained his BEng in Electronic Engineering from Tsinghua University, China in 1985, and his MSc and PhD from University of Manchester in 1987 and 1990 respectively. From 1991 to 2006, he was with the School of Electrical and Electronic Engineering, Nanyang Technological University, Singapore. From June 2002 to December 2005, he was seconded to the Institute for Infocomm Research, Agency for Science, Technology and Research (A\*STAR), Singapore, as Program Director and Department Manager. He joined the Department of Electronic and Information Engineering, The Hong Kong Polytechnic University, Hong Kong SAR in 2006 as a Professor, where he is currently a member of the Photonic Research Centre working in the area of optical communication systems and fibre devices for communication and sensing systems.