



HAL
open science

Performance Analysis of an EEMD-based Hilbert Huang Transform as a Bearing Failure Detector in Wind Turbines

Yassine Amirat, Mohamed Benbouzid, Tianzhen Wang, Sylvie Turri

► **To cite this version:**

Yassine Amirat, Mohamed Benbouzid, Tianzhen Wang, Sylvie Turri. Performance Analysis of an EEMD-based Hilbert Huang Transform as a Bearing Failure Detector in Wind Turbines. IEEE ICGE 2014, Mar 2014, Sfax, Tunisia. pp.193-198. hal-01023502

HAL Id: hal-01023502

<https://hal.science/hal-01023502>

Submitted on 13 Jul 2014

HAL is a multi-disciplinary open access archive for the deposit and dissemination of scientific research documents, whether they are published or not. The documents may come from teaching and research institutions in France or abroad, or from public or private research centers.

L'archive ouverte pluridisciplinaire **HAL**, est destinée au dépôt et à la diffusion de documents scientifiques de niveau recherche, publiés ou non, émanant des établissements d'enseignement et de recherche français ou étrangers, des laboratoires publics ou privés.

Performance Analysis of an EEMD-based Hilbert Huang Transform as a Bearing Failure Detector in Wind Turbines

Yassine Amirat
ISEN Brest, EA 4325 LBMS
Brest, France
Yassine.Amirat@isen.fr

Mohamed Benbouzid
University of Brest, EA 4325
LBMS, Brest, France
Mohamed.Benbouzid@univ-brest.fr

Tianzhen Wang
Shanghai Maritime University,
Shanghai, China
tzwang@shmtu.edu.cn

Sylvie Turri
University of Brest, EA 4325
LBMS, Brest, France
Sylvie.Turri@univ-brest.fr

Abstract—Sustainability and viability of wind farms are highly dependent on the reduction of the operational and maintenance costs. The most efficient way of reducing these costs would be to continuously monitor the condition of these systems. This allows for early detection of the degeneration of the generator health, facilitating a proactive response, minimizing downtime, and maximizing productivity. This paper deals then with the assessment of a demodulation technique for bearing failure detection through wind turbines generator stator current. The proposed technique is based on a modified version of the Hilbert Huang transform. In this version, the use of the EEMD algorithm allows overcoming the well-known mixed mode.

Keywords—Wind turbines, bearing failure detection, amplitude demodulation, Hilbert Huang transform, EEMD.

I. INTRODUCTION

Wind turbines failure detection is certainly one of the most important key in maintenance cost reduction. Despite the long experience accumulated by several technologies applied in electric machine, the task in wind turbines is still an art. It has become even more challenging as far as wind energy conversion system are deployed onshore or offshore where there are substantial wind resources, leading to a best electricity generating opportunities, so it yields to high maintenance costs because they are inaccessible or hardly accessible [1]. With the development of these wind farms due to increasing land or sea constraints, new challenges arise particularly with regard to maintenance. Indeed, maintenance is significantly restricted during periods of high wind speed and significant wave height. In this context, cost-effective, predictive and proactive maintenance of wind turbines assumes more importance. Wind turbine Condition Monitoring Systems (CMS) provide then an early indication of component incipient failure, allowing the operator to plan system repair prior to complete failure. So the CMS will be an important tool for lifting uptime and maximizing productivity; in other words when cost-effective availability targets must be reached. The experience feedback of wind turbine industries shows important features of failure rate values and trends [2-3]; and states that a large fraction of wind turbine downtime is due to drive train and bearing failures, particularly in the generator and gearbox. For failure diagnosis problem, it is important to know if a failure exists or not in the generator; and in addition, to identify the failed element of the

system and to find the failure causes via the processing of available measurements. To today condition monitoring techniques for wind turbines have not been resolved and have not reached their full potential, because CMS are highly linked to the detection philosophy and should be applied only when the detection methods are reliable [4-5]. A well-known method for assessing impending problems is to use current sensors installed within the wind turbine generator as transducer for failure detection [6].

Many techniques and tools are developed for condition monitoring of wind turbine electric generator in order to prolong their life span [7]. Some of the technology used for monitoring includes existing and pre-installed sensors, such for speed, torque, vibrations, temperature, flux density, etc. These sensors are managed together in different architectures and coupled with algorithms to allow an efficient monitoring of the system condition. Those methods are outcome from electric motor condition monitoring. From the theoretical and experimental point of view, the well-established methods are: electrical quantities signature analysis (current, power...), vibration monitoring, temperature monitoring and oil monitoring. In the case of wind turbines generator, some research works on fault detection were carried out using the electrical quantities of the generator, such as the diagnosis of unbalance and failure in the blades of a small wind turbine by measuring the power spectrum density at the turbine generator terminal [8]. The advantage of signature analysis of the generator electrical quantities is that those quantities are easily accessible during operation.

Analyzing the generator electrical quantities usually involves the use of signal processing techniques. For steady state operations, the Fast Fourier Transform (FFT) and other techniques based upon it are widely used in the literature [8-9]. However, in the case of variable speed wind turbines, the FFT is difficult to interpret and to extract the features of variations in time-domain, since the operation is predominately non-stationary due the behavior of the wind speed. To overcome this problem, procedures based on time-frequency representations (Spectrogram, Quadratic Wiegner-Ville, etc.) or time-scale analysis (wavelet) have been proposed in the literature of the electric machines community [10-12]. Nevertheless, these methods are formulated through integral transforms and analytic signal representations, so their accuracy depends on data length

and stationarity. Also these techniques have drawbacks such as high complexity, poor resolution and/or may suffer from artifacts (cross-terms...) and it is not easier to track the frequencies introduced by the failure.

This paper deals then with the assessment of a demodulation technique for bearing failure detection through wind turbines generator stator current [13]. The proposed technique is based on a modified version of the Hilbert Huang transform. In this version, the use of the EEMD algorithm allows overcoming the well-known mixed mode. The proposed technique is tested using experimental data from a 0.75kW test bench.

II. ROLLING ELEMENT BEARING FAULT

The failure of rolling element bearings of the electric generator is the most common failure mode associated with a long downtime of wind turbines. Because of their construction, rolling element bearings generate precisely identifiable signature on vibration. The characteristic frequencies of rolling element bearings depend on the geometrical size of the various elements [14]. Those frequencies present an effective route for monitoring progressive bearing degradation. It is therefore possible to detect on the stator side the frequencies associated with the bearings using an accelerometer mounted directly on the bearing housing, which is not often easily accessible. It is also true that vibration monitoring has made out its efficiency; and it is highly suitable for rolling element bearings, however it represents an issue when requiring a good vibration baseline. To tackle this problem, an alternative procedure for bearing failures detection in electrical machines is proposed by analyzing the stator side electrical quantities, such as the current or the instantaneous power [14]. Indeed, bearing failures generate predictable frequencies in the stator current. In fact, a bearing failure is assumed to produce an air gap eccentricity. The effect of the eccentricity on the magnetic flux distribution is depicted in Fig. 1. Due to the eccentric rotor motion, an *unbalanced magnetic pull* is produced; this gives rise to torque oscillations which lead to an amplitude and/or phase modulation of stator current [15]. It is therefore sufficient to demodulate the current to achieve failure detection. In this paper, the authors will assess an alternative technique detecting bearing failures regardless the stator current frequency content.

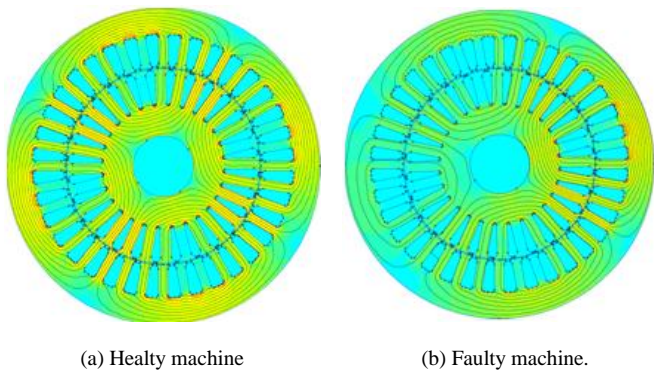

Fig. 1. Effect of the eccentricity on the magnetic field.

III. SIGNAL PROCESSING TOOLS

This work focuses on mechanical failures that lead to stator current amplitude modulations. These include bearing failure and air gap irregularities.

For amplitude modulated signals, the gathered current $i(t)$ is assumed to be multi-components and can be expressed as

$$i(t) = \sum_{k=1}^M a_k(t) \sin(\phi_k(t)) \quad (1)$$

where $a_k(t) = a_k(1 + m_{ka} \sin(2\pi f_{ka} t + \phi_{ka}))$

and $\phi_k(t) = 2\pi f_{k0} t + m_{kp} \sin(2\pi f_{ka} t + \phi_{kp})$

However, due to sampling procedure (1) is rewritten as follow.

$$i(n) = \sum_{k=1}^M a_k(n) \sin(2\pi f_k / F_s + \phi_k(n)) \quad (2)$$

Where $n = 0 \dots N - 1$ is the sample index, N is the number of logged samples, ϕ_k is the phase parameter and F_s is the sampling frequency.

For failure detection, a possible approach relies on the use of amplitude demodulation techniques to estimate the instantaneous amplitude (IA). Then, statistical features can be extracted to detect if IA is time-varying or not.

A. Amplitude Demodulation

For amplitude modulated signals, many techniques for amplitude demodulation were investigated. The most popular include the Hilbert transform (HT) [16] and the Teager Energy Operator [17]. Furthermore for three-phase system, it has been recently shown that the Concordia transform can be used to perform demodulation [18]. In this study, one phase current is considered. In this context, if the current is assumed to be mono-component, (2) is reduced to

$$i(n) = a(n) \sin(2\pi f / F_s + \phi(n)) \quad (3)$$

and the Hilbert transform can be chosen to estimate the instantaneous amplitude since it is usually more robust against noise than the Teager energy operator and easier to implement, because its computation is closely related to FFT which is the most built-in function in embedded targets.

However, the current is not really mono component, so Hilbert transform is no longer valid. Because It is well known that the stator current is a combination of various dominant harmonic components; such as fundamental harmonic, teeth harmonic, saturation harmonic, unknown harmonics including noise; and harmonics introduced by the failure. Under such assumption, innovative techniques are investigated for tracking the failure component by separation methods [19-20].

In this paper the authors explore a separation method in order to isolate the failure effect and track the variation of the dominant component introduced by this failure. One of the emerging methods for signal separation is the Hilbert Huang transform (HHT). The HHT method has focused considerable attention and has been recently indexed to fault diagnosis of rotating machinery [21].

The HHT method proceeded on two steps. The first one consists in decomposing the signal using the Empirical Mode Decomposition (EMD) method. The EMD has been described as an adaptive time-frequency data analysis method for nonlinear and non-stationary signals [20]. Unlike standard approaches that decompose a signal (data) into series of pre-defined basis functions (harmonic, wavelet), the EMD is derived from data. The EMD produces a representation of a discrete signal in terms of elementary modes based on the local characteristic time-scale of the signal and hence leading to physical meaning. The multi-components signal is expressed as a sum of a series of intrinsic mode functions (*imfs*) and can be expressed by

$$i(n) = \sum_{m=1}^M imf_m(n) + R_M(n) \quad (4)$$

The decomposition details can be found in [20]. Nevertheless, one major drawback of the EMD is the mode mixing. This phenomenon means that the detail related to one scale can appear in two different intrinsic modes as clearly shown by Fig. 2. The mixed mode makes the individual *imf* devoid of a physical meaning. To overcome this drawback, the Ensemble EMD was introduced by [22]. The EEMD is described as a new noise-added method, which automatically mitigate the EMD mode mixing. This *friendly-noise* decomposition is base on the EMD and is described by Fig. 3.

The second step relies on applying the Hilbert transform to each *imf* obtained through the EEMD algorithm. Since the *imfs* are discrete, it is necessary to use the Discrete Hilbert Transform (DHT) [23].

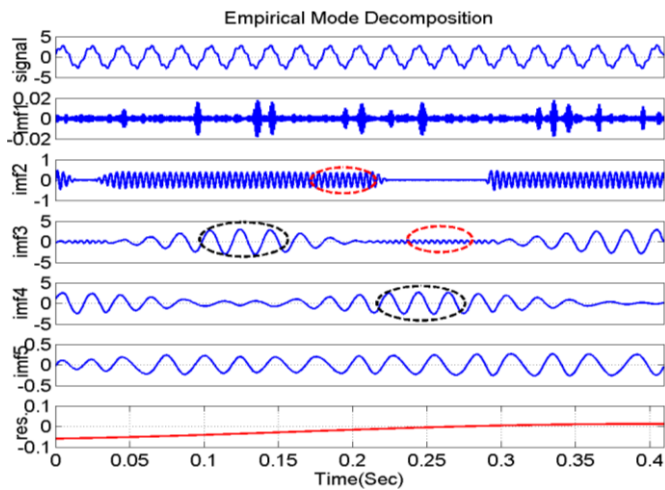

Fig. 2. Empirical mode decomposition and the mixed mode phenomena.

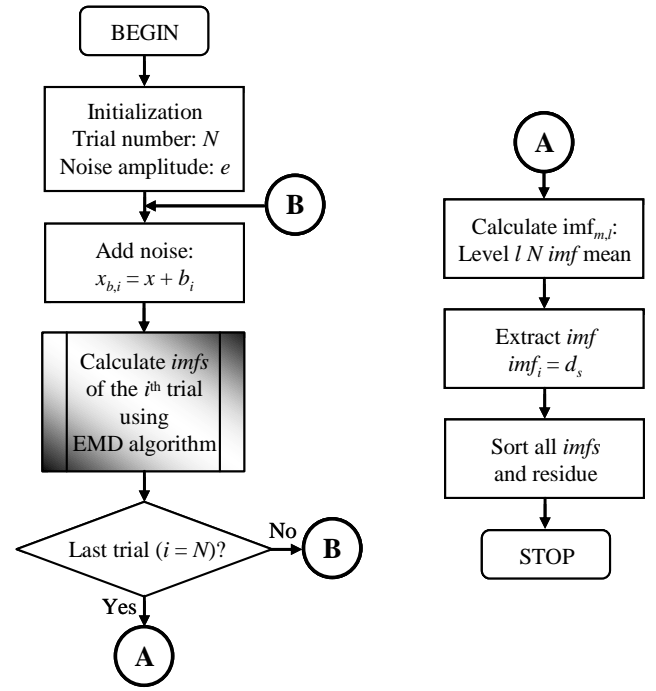

Fig. 3. EEMD algorithm flowchart.

$$H[imf_x(n)] = F^{-1} \{ F \{ imf_x(n) \} u(n) \} \quad (7)$$

where $F\{\cdot\}$ and $F^{-1}\{\cdot\}$ correspond to the FFT and Inverse FFT, respectively, and $u(n)$ is defined as

$$u(n) = \begin{cases} 1, & n = 0, \frac{N}{2} \\ 2, & n = 1, 2, \dots, \frac{N}{2} - 1 \\ 0, & n = \frac{N}{2} + 1, \dots, N - 1 \end{cases} \quad (8)$$

Using (3), the instantaneous amplitude *IA*, denoted $\hat{a}(n)$, is given by

$$\hat{a}(n) = \sqrt{imf_x^2(n) + (H[imf_x(n)])^2} \quad (9)$$

B. Failure Detector

Several fault detectors based on amplitude demodulation have been proposed in the literature, and most of them use complicated classifier [20]. Furthermore these methods assume that a training database is available, which can be difficult to obtain for wind turbines. In this section, we propose a low complexity detector which does not require any training set. The detector is based on the variance of the dominant *imf*. After applying EEMD and locating the most energized *imf* due to the failure occurrence, its *IA* is computed through (9). A statistical criterion is then applied to assess a failure indicator.

IV. TEST FACILITY DESCRIPTION

Figure 4 describes the experimental setup that is operated in the motor configuration for experimental easiness. It is composed of two parts: a mechanical part that has a tachogenerator, a three-phase induction motor and an alternator. The tachogenerator is a DC machine that generates 90 V at 3000 rpm. It is used to measure the speed. It produces linear voltage between 2500 and 3000 rpm. The alternator is a three-phase synchronous machine with a regulator and a rectifier circuit that stabilize the output voltage at 12 VDC. The advantage of using a car alternator instead of DC generator is obtaining constant output voltage at various speeds. The induction motor could be identically loaded at different speeds. Figure 5 illustrates the experimental test philosophy, while bearings with artificial deterioration are shown in Fig. 6. The induction generator and the bearings data and parameters are given in the Appendix.

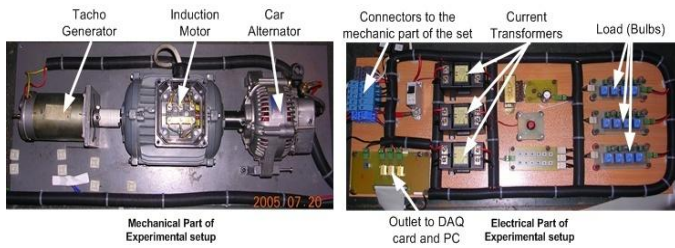

Fig. 4. Experimental set up.

V. FAILURE DETECTOR ASSESSMENT AND RESULTS

In this section, the results of the proposed approach are presented with experimental signals. The EEMD algorithm was adjusted for $e = 0.3$ and $N = 100$. This decomposition was applied to logged stator current for several loads during operation with healthy and faulty bearing.

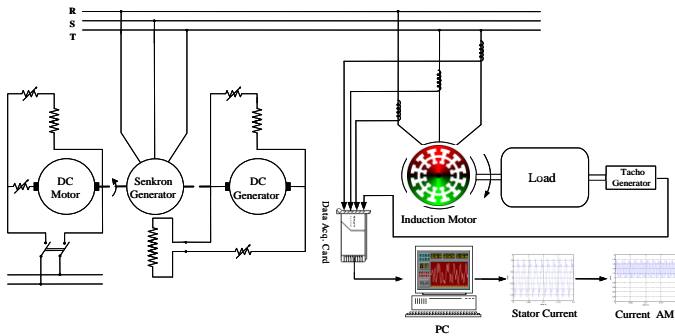

Fig. 5. Experimental test philosophy.

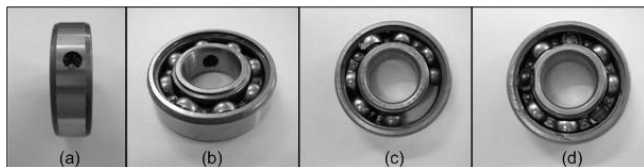
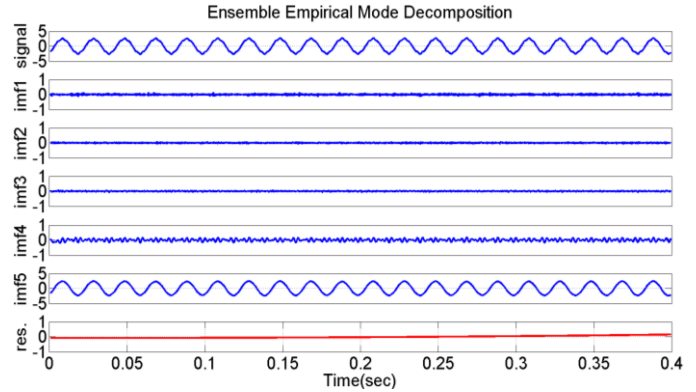
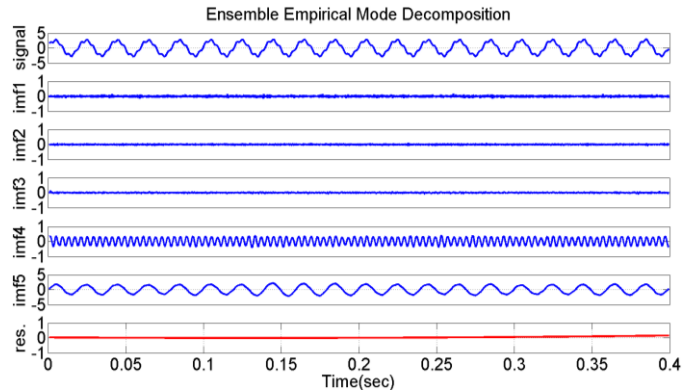

Fig. 6. Artificially deteriorated bearings: (a) outer race deterioration, (b) inner race deterioration, (c) cage deterioration, (d) ball deterioration [25].

Figure 7 depicts the first five *imfs* and the residue for a 40% loaded healthy and faulty machine. It can be seen that the 4th *imf* is more energized when the bearings are defected; whatever the bearing failure; except when it is defected by outer race, as shown in Fig. 8. In this case, the 4th *imf* seems to be no more different from the healthy one. This is mainly due a bad emulation of the failure. This *imf* can therefore be investigated for bearing failure detection. Owing to this ascertainment, the mean of the instantaneous amplitude of this *imf* for several loads and cases is therefore computed.



(a) Healthy bearings.



(b) Faulty bearings (cage damage).

Fig. 7. Stator current EEMD.

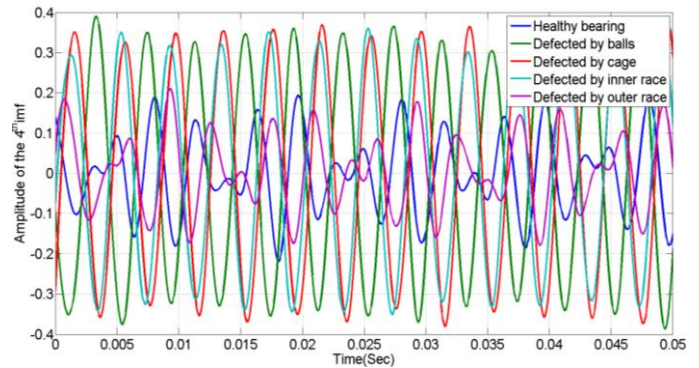

Fig. 8. 4th *imf* for healthy and faulty bearings.

After Hilbert transform, n_e samples have been removed at the beginning and at the end of the instantaneous amplitude of the 4th *imf*, to avoid the edge effects problem of the Hilbert transform. Figure 9 displays the instantaneous amplitude *IA* of the 4th *imf* for a healthy and faulty bearings. Readable information on failure detection performance using the *IA* mean are illustrated by the bar graph of Fig. 10. Compared to the healthy case, the *IA* mean is higher in the faulty case. In particular, this criterion is multiply by 3 for a bearing failure.

In this context, a bearing failure can be detected by setting the hypothesis test threshold to an adjusted value during normal conditions and operations.

VI. CONCLUSION

This paper dealt with the assessment of a demodulation technique for bearing failure detection through the generator stator current in wind turbines context. The proposed technique is based on a modified version of the Hilbert Huang transform. In this version, the use of the EEMD algorithm allows overcoming the well-known mixed mode. In this context, the current was first decomposed into intrinsic mode functions through the EEMD.

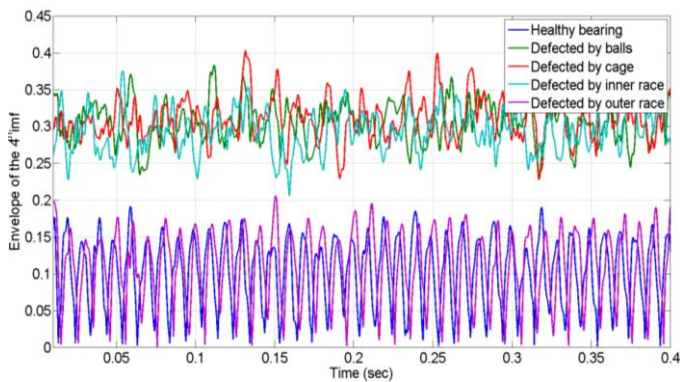

Fig. 9. Instantaneous amplitude of the 4th *imf* for healthy and faulty bearings.

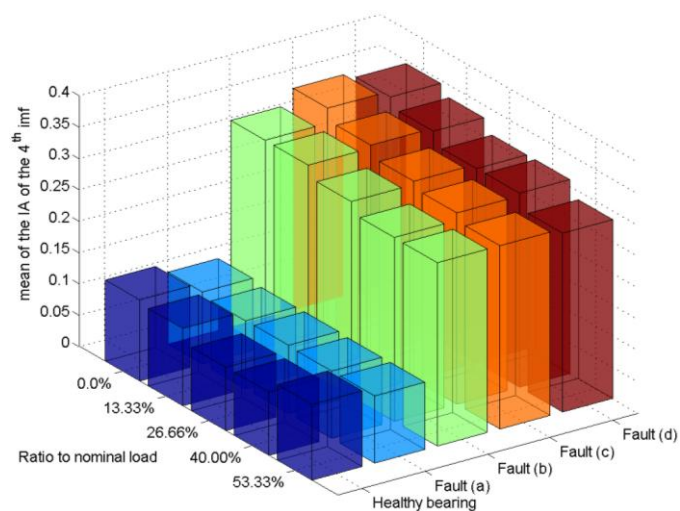

Fig 10. 4th *imf* instantaneous amplitude mean for healthy and faulty bearings.

It was then found that the 4th one is the most energized when bearing faults occur. The instantaneous amplitude of the 4th *imf* mode is then analyzed using a statistic criterion based on the mean value. The achieved results clearly show that it can be used as a reliable indicator for bearing failures regardless training data.

APPENDIX

INDUCTION GENERATOR AND BEARINGS PARAMETERS

Induction Generator	
Power rate	0.75KW
Voltage rate	220/3380V
Current rate	1.95/3.4A
Rate speed	2780 rpm
Frequency	50Hz
Bearings Parameters	
Type	6204.2ZR
Outside diameter	47mm
Inside diameter	20mm
Pitch diameter D_p	31.85mm
Number of balls N	8
Diameter of balls D_B	12mm

REFERENCES

- [1] Y. Amirat, M. Benbouzid, E. Al-Ahmar, B. Bensaker, and S. Turri, "A brief status on condition monitoring and fault diagnosis in wind energy conversion systems," *Renewable and Sustainable Energy Reviews*, vol. 13, n°9, pp. 2629–2636, 2009.
- [2] W. Yang, P.J. Tavner, C.J. Crabtree and M. Wilkinson, "Cost-effective condition monitoring for wind turbines," *IEEE Trans. Industrial Electronics*, vol. 57, n°1, pp. 263-271, January 2010.
- [3] P. Caselitz and M. M. J. Giehardt, "Application of condition monitoring systems in wind energy converters," in *Proceedings of the 1997 EWECC*, Dublin (Ireland), pp. 579–582, October 1997.
- [4] B. Lu, Y. Li, X. Wu and Z. Yang, "A review of recent advances in wind turbine condition monitoring and fault diagnosis", in *Proceedings of the 2009 IEEE PEMWA*, Lincoln (USA), pp. 1-7, June 2009.
- [5] W. Yang, P.J. Tavner, C.J. Crabtree and M. Wilkinson, "Cost-effective condition monitoring for wind turbines," *IEEE Trans. Industrial Electronics*, vol. 57, n°1, pp. 263-271, January 2010.
- [6] P.J. Tavner, "Review of condition monitoring of rotating electrical machines," *IET Electric Power Applications*, vol. 2, n°4, pp. 215-247, July 2008.
- [7] B. Lu, Y. Li, X. Wu and Z. Yang, "A review of recent advances in wind turbine condition monitoring and fault diagnosis", in *Proceedings of the 2009 IEEE PEMWA*, Lincoln (USA), pp. 1-7, June 2009.
- [8] S. Rajagopalan, J. A. Restrepo, J. Aller, T. Habetler and R. Harley, "Non stationary motor fault detection using recent quadratic time frequency representations," *IEEE Trans. Industry Applications*, vol. 44, n°3, pp. 735-744, May-June 2008.
- [9] P. Zhang, Y. Du, T.G. Habetler and B. Lu, "A survey of condition monitoring and protection methods for medium-voltage induction motors," *IEEE Trans. Industry Applications*, vol. 47, n°1, pp. 34-46, January/February 2011.
- [10] M. Riera-Guasp, J. Antonio-Daviu, J. Roger-Folch, and M.P.M. Palomares, "The use of the wavelet approximation signal as a tool for the diagnosis of rotor bar failure," *IEEE Trans. Industry Applications*, vol. 44, n°33, pp. 716-726, May-June 2008.

- [11] M. Blodt, J. Regnier, and J. Faucher, "Distinguishing load torque oscillations and eccentricity faults in induction motors using stator current Wigner distributions," *IEEE Trans. Industry Applications*, vol. 45, n°6, pp. 1991-2000, November-December 2009.
- [12] E. Al-Ahmar, M.E.H. Benbouzid and S. Turri, "Wind energy conversion systems fault diagnosis using wavelet analysis," *International Review of Electrical Engineering*, vol. 3, n°4, pp. 646-652, July-August 2008.
- [13] V. Choqueuse, M.E.H. Benbouzid, Y. Amirat and S. Turri, "Diagnosis of three-phase electrical machines using multidimensional demodulation techniques," *IEEE Trans. Industrial Electronics*, vol. 59, n°4, pp. 2014-2023, April 2012.
- [14] M.E.H. Benbouzid, "A review of induction motors signature analysis as a medium for faults detection," *IEEE Trans. Industrial Electronics*, vol. 47, no. 5, pp. 984-993, October 2000.
- [15] E.H. El Bouchikhi, V. Choqueuse and M.E.H. Benbouzid, "Current frequency spectral subtraction and its contribution to induction machines bearings condition monitoring," *IEEE Trans. Energy Conversion*, vol. 28, n°1, pp. 135-144, March 2013.
- [16] Y. Amirat, V. Choqueuse, M.E.H. Benbouzid and S. Turri, "Hilbert transform-based bearing failure detection in DFIG-based wind turbines," *International Review of Electrical Engineering*, vol. 6, n°3, pp. 1249-1256, June 2011.
- [17] I. Kamwa, A.K. Pradhan and G. Joos, "Robust detection and analysis of power system oscillations using the Teager-Kaiser energy operator," *IEEE Trans. Power Systems*, vol. 26, n°1, pp. 323-333, February 2011.
- [18] B. Trajin, M. Chabert, J. Regnier, and J. Faucher, "Hilbert versus Concordia transform for three phase machine stator current time-frequency monitoring," *Mechanical Systems & Signal Processing*, vol. 23, n°8, pp. 2648-2657, November 2009.
- [19] A. Boudraa and J. C. Cexus, "EMD-based signal filtering," *IEEE Trans. Instrumentation and Measurement*, vol. 56, n°6, pp. 2196-2202, December 2007.
- [20] Y. Amirat, V. Choqueuse and M.E.H. Benbouzid, "EEMD-based wind turbine bearing failure detection using the generator stator current homopolar component," *Mechanical Systems and Signal Processing*, vol. 41, n°1-2, pp. 667-678, December 2013.
- [21] J. Antonino-Daviu, M. Riera-Guasp, M. Pineda-Sanchez, and R.B. Perez, "A critical comparison between DWT and Hilbert-Huang-based methods for the diagnosis of rotor bar failures in induction machines," *IEEE Trans. Industry Applications*, vol. 45, n°5, pp. 1794-1803, September/October 2009.
- [22] Z.H. Wu and N.E. Huang, "Ensemble empirical mode decomposition: A noise-assisted data analysis method", *Advances in Adaptive Data Analysis*, vol. 1, n°1, pp. 1-41, 2009.
- [23] Y. Amirat, V. Choqueuse and M.E.H. Benbouzid, "Condition monitoring of wind turbines based on amplitude demodulation," in *Proceedings of the 2010 IEEE ECCE*, Atlanta (USA), pp. 2417-2421, September 2010.