



HAL
open science

Axis control using model predictive control: identification and friction effect reduction

Pedro Rodriguez-Ayerbe, Didier Dumur, Sylvain Lavernhe

► To cite this version:

Pedro Rodriguez-Ayerbe, Didier Dumur, Sylvain Lavernhe. Axis control using model predictive control: identification and friction effect reduction. 3rd International Conference on Virtual Machining Process Technology, May 2014, Calgary, Canada. 8p. hal-01023265

HAL Id: hal-01023265

<https://hal.science/hal-01023265v1>

Submitted on 11 Jul 2014

HAL is a multi-disciplinary open access archive for the deposit and dissemination of scientific research documents, whether they are published or not. The documents may come from teaching and research institutions in France or abroad, or from public or private research centers.

L'archive ouverte pluridisciplinaire **HAL**, est destinée au dépôt et à la diffusion de documents scientifiques de niveau recherche, publiés ou non, émanant des établissements d'enseignement et de recherche français ou étrangers, des laboratoires publics ou privés.

Axis control using model predictive control: identification and friction effect reduction

Pedro Rodriguez-Ayerbe, Didier Dumur, Sylvain Lavernhe**

* *SUPELEC- E3S, Automatic Control, 3 rue Joliot Curie 91192 Gif sur Yvette – France*

** *LURPA ENS – Cachan, 61 avenue du Président Wilson - 94235 Cachan*

Pedro.Rodriguez-Ayerbe@supelec.fr, Didier.Dumur@supelec.fr,
sylvain.lavernhe@ens-cachan.fr

Abstract: This paper treats the identification and control of a machining center by means of predictive control, specifically focusing on the aspect of reducing friction effect. The machine tool is a five-axis CNC Mikron machine, in the context of HSM "High Speed Machining", with open control architecture. The axes are internally controlled by current and speed PI controllers in a classical cascade framework. In an external position loop, a predictive controller is considered instead of a classical position proportional controller with a feed forward action. The novelties stressed in the paper are the identification and the tuning of the predictive controller in order to reduce the impact of the frictions. The two-degree of freedom controller obtained using predictive strategy permits to adjust separately the tracking performance and the disturbance rejection. The tracking performance is tuned to reduce the contour error and the disturbance rejection is tuned by means of a disturbance model in order to reduce the friction impact. First, based on a nonlinear simulation model considering the frictions in the axis, a numerical model is derived by least square identification. Afterwards this numerical model is used to synthesize a predictive GPC controller reducing the impact of the friction. The benefit of the proposed structure is analyzed by means of experimental tests and a comparison with the classical position loop control with speed feed-forward. The experimental results are obtained for a two-axis trajectory, showing that the resulting experimental contour errors are smaller using the predictive controller. As perspective the paper proposes to use a control structure including only an internal current controller and external predictive position loop, without velocity loop.

Keywords: machine-tool, identification, predictive control, friction.

1. INTRODUCTION

Axis control in machine tools applications including predictive control strategies has proved to have advantages regarding the classical structures using PI controllers and filters, and this is basically for two reasons: the first one is that the knowledge of the trajectory in the future can be used to anticipate the commands of the axis, and the second one is the consideration of constraints [Susanu, et al., 2004]. In classical

machine tool axis control architectures, the anticipative action taking into account the future trajectory is achieved by means of feedforward actions, in such a way that the axis usually does not active any constraints, justifying in this case the use of unconstrained linear approaches. Therefore, in case of constraints arising when specified performances become more and more severe, the potential of predictive control for this kind of application is very promising.

Indeed, performances requested in the machining domain are continuously increasing in terms of machining velocity and accuracy [Altintas, 2000]. The fulfilling of the imposed specifications implies on the one hand the use of more and more reliable actuators for the axis control, and on the other hand the implementation of advanced control laws, allowing the optimization of the system behaviour. However, if changing the actuator proved to be easy, the control laws within the CNC machine-tool are up to now completely closed, thus difficult to adjust. In order to have an easy implementation of advanced control strategy, an open architecture (OA) is considered in this work. Open architecture systems are a domain with great interest nowadays. In this direction, OA machine tools are a challenge with important long-terms benefits [Pritschow, et al., 2001].

The goal of this paper is thus to present the full procedure leading to the final validation. First, based on a nonlinear simulation model considering the frictions in the axis, a numerical model is derived by least square identification. Afterwards this numerical model is used to synthesize a GPC (Generalized Predictive Control) controller reducing the impact of the friction. This controller is finally validated by means of experimental tests in an OA machining center.

The next Section examines the structure of the machining centre. Section 3 presents the identification of the axis dynamics. Section 4 considers the design of the axes controllers under a predictive strategy. Section 5 details the experimental results for a two-axis trajectory, showing that the resulting experimental contour errors are smaller using the predictive controller. Finally, Section 6 gives some conclusions.

2. FIVE-AXIS CNC MIKRON MACHINE



Figure 1; Five-axis CNC Mikron machine.

The machine tool is a five-axis CNC Mikron machine, in the context of HSM "High Speed Machining", with open control architecture. The axes are internally controlled by current and speed PI controllers in a classical cascaded framework. In an external position loop a classical proportional controller with a feedforward action is considered. This external loop will be thereafter replaced by a predictive controller. The machine is shown Figure 1. Figure 2 reproduces the classical cascaded structure of the axis. In the considered open architecture framework, the position loop and anticipative effect have migrated from the CN to be implanted in a PC and the real time is assured using dSPACE platform. This open structure is proposed in [Beudaert, 2013].

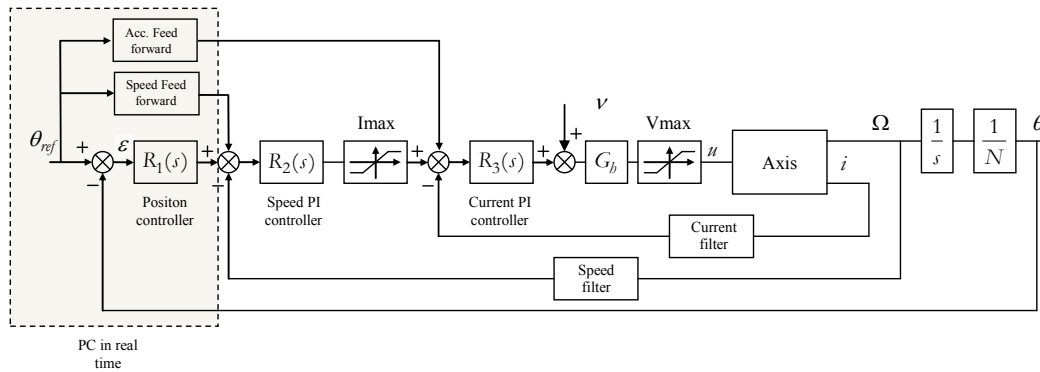
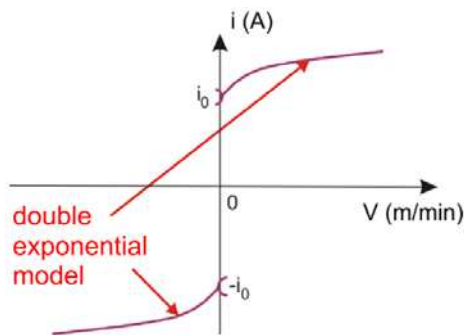

Figure 2; Axis control in open architecture.

The nonlinear characteristics of the axis due to frictions have been previously identified in [Prevost, 2011], and a nonlinear virtual environment has been validated, which is therefore available for reproducing the nonlinear effects of the machine. This nonlinear simulator will be further used to identify a numerical model considered afterwards within the predictive control synthesis. The friction identified in each axis is given by the characteristic show in figure 3. The value of the static friction i_0 correspond to a torque of $2.47i_0 = 2.57\text{Nm}$.



$$\begin{cases} i_{fr} = ae^{bV} + ce^{dV} & \text{if } V > 0 \\ i_{fr} = -ae^{bV} + ce^{dV} & \text{if } V < 0 \\ i_{fr} \in [-i_0; i_0] & \text{if } V = 0 \end{cases}$$

Identified values for x axis:

$$\begin{aligned} a &= 1.576 & b &= 0.01965 & i_0 &= 1.043 \\ c &= -0.5332 & d &= -0.2801 \end{aligned}$$

Figure 3; Fiction model and identified values.

3. IDENTIFICATION

Based on the nonlinear simulator, a linear discrete time transfer function of the axis dynamics is derived from the step response of the velocity loop through a standard least square identification method [Landau, 1990], with a sampling rate of 1ms. Orders of this transfer function from 2 to 4 have been tested, as shown in Figure 4, giving the maximum overshoot of the response obtained with the nonlinear simulator and the identified models. It can be seen that a second order system does not conveniently approximate the simulated non-linear step response. Third and fourth order models have approximately the same response; in the sequel the third order model is finally considered. This obtained model including an additional integral action to derive the position is as follows:

$$\frac{y(q^{-1})}{u(q^{-1})} = \frac{10^{-3}(2.908q^{-1} + 5.992q^{-2} + 5.87q^{-3} - 0.852q^{-4})}{1 + 2.843q^{-1} + 2.697q^{-2} + 0.916q^{-3} + 0.0317q^{-4}} \quad (1)$$

where u is the voltage input to the axis motor, y the position of the axis in mm, and q^{-1} the backward shift operator.

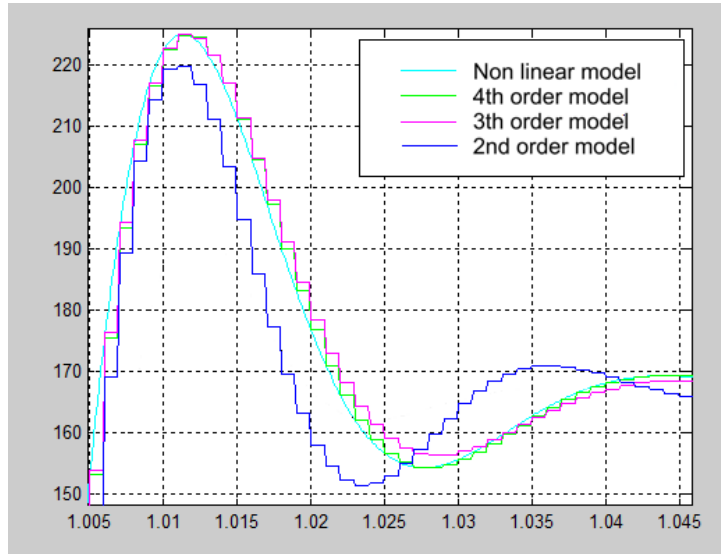

Figure 4; Step response of nonlinear and identified models.

4. GENERALIZED PREDICTIVE CONTROL (GPC)

This part briefly reminds the basic steps of the GPC controller design, more details may be found in [Clarke, et al., 1987]. In the GPC theory, the plant is classically modeled by the input/output CARIMA form:

$$A(q^{-1})y(t) = B(q^{-1})u(t-1) + \frac{C(q^{-1})\xi(t)}{\Delta(q^{-1})} \quad (2)$$

$\xi(t)$ is a zero mean non-correlated white noise, and $C(q^{-1})$ models the noise influence [Clarke, et al., 1989]. The introduction of the difference operator $\Delta(q^{-1})=1-q^{-1}$ in the disturbance model helps to find an integral action in the controller and so eliminate the static errors. The control signal is obtained by minimization of a quadratic cost function:

$$J = \sum_{j=N_1}^{N_2} [y_{ref}(t+j) - \hat{y}(t+j)]^2 + \lambda \sum_{j=1}^{N_u} \Delta u(t+j-1)^2 \quad (3)$$

where N_1 and N_2 define the output prediction horizons, and N_u the control horizon. λ is the control weighting factor, y_{ref} the reference value, \hat{y} the predicted output value, obtained solving diophantine equations, and u the control signal. The receding horizon principle assumes that only the first value of the optimal control sequence resulting from the minimization of (3) is applied to the system, so that at the next sampling period the same procedure is repeated. This control strategy leads to a two-degree of freedom *RST* controller, implemented through a difference equation:

$$S(q^{-1})u(t) = -R(q^{-1})y(t) + T(q)w(t) \quad (4)$$

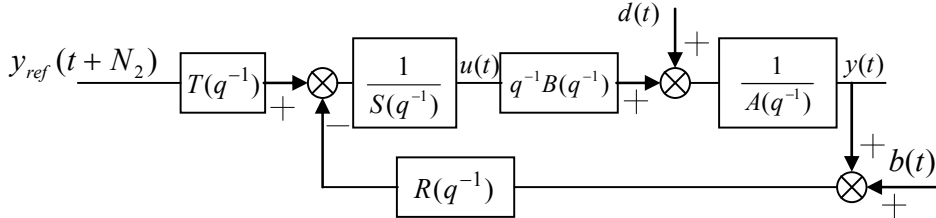

Figure 5; Two-degrees of freedom GPC controller.

The GPC parameters chosen here to provide appropriate stability margins [Clarke, et al., 1989; Boucher, et al., 2003] are $N_1=1, N_2=8, N_u=1, \lambda=0.003$. The C polynomial is chosen as $C(q^{-1})=(1-q^{-1})(1-0.8q^{-1})(1-0.9q^{-1})$. It includes a root at $q=1$, in order to remove the integral action of the GPC controller. In fact, the static friction in the axis produces oscillations in the output when an integral action is included in the predictive controller. The other two roots of the C polynomial permits to obtain good robustness margins [Rodriguez, et al., 2005], as can be observed in the Black-Nichols diagram shown in Figure 6.

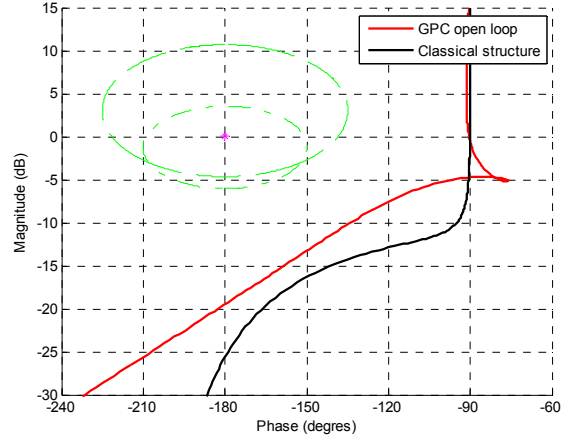

Figure 6; Stability margins and step response of GPC controller.

A phase margin of 90 degrees and a gain margin of 20dB are obtained with the third order model, similar of the margins obtained with the classical structure. The obtained GPC controller is:

$$\begin{aligned}
 R(q^{-1}) &= 4.6208 - 8.6839q^{-1} + 4.3108q^{-2} - 0.1551q^{-3} \\
 S(q^{-1}) &= 1.0000 - 1.4394q^{-1} + 0.5239q^{-2} - 0.0141q^{-3} \\
 T(q^{-1}) &= 1.4300q^{-1} - 1.3093q^{-2} - 0.0398q^{-3} - 0.0318q^{-4} - 0.0212q^{-5} - \\
 &\quad 0.0083q^{-6} + 0.0067q^{-7} + 0.0230q^{-8} + 0.0338q^{-9} - 0.0096q^{-10}
 \end{aligned} \tag{5}$$

5. EXPERIMENTAL RESULTS

The GPC controller is compared to a proportional controller with speed anticipation. Figures 7 and 8 show the obtained results for two trajectories in x and y axis. The ideal trajectories have been modified using [Beudaert, et al., 2013] in order to round discontinuities. Left part of the figures shows the trajectory and the axis position with both controllers and the right part shows the contour error. In both cases, the contour error is smaller using the GPC controller. A summary of obtained errors is shown in Table I.

	Trident		Corner	
	FFW	GPC	FFW	GPC
Mean value	$2.52 \mu\text{m}$	$0.62 \mu\text{m}$	$2.24 \mu\text{m}$	$0.83 \mu\text{m}$
Standard deviation value	$1.85 \mu\text{m}$	$1.78 \mu\text{m}$	$1.17 \mu\text{m}$	$0.56 \mu\text{m}$

Table I; Contours errors obtained with classical proportional with a speed feed forward action (FFW) and predictive (GPC) controllers.

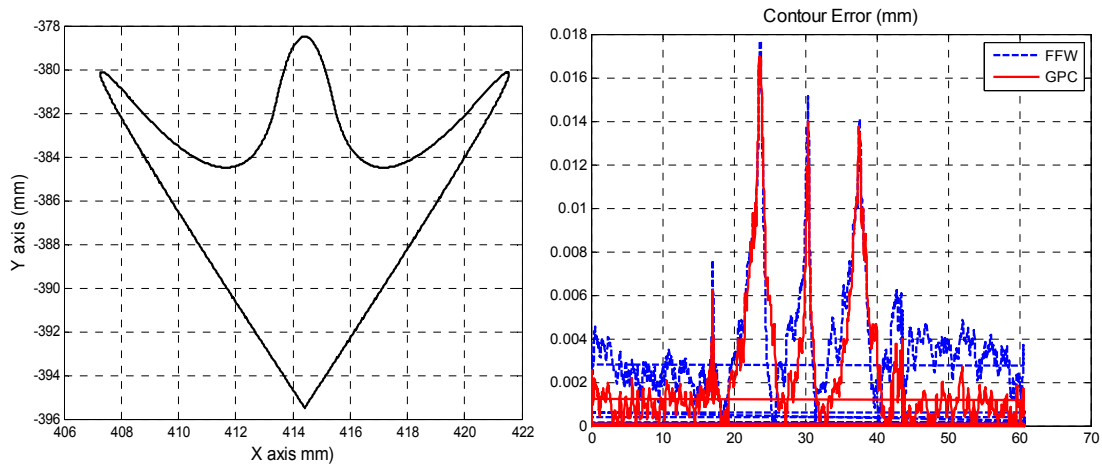

Figure 7; Trident trajectory in x and y axis. GPC (red) and proportional control with speed feed-forward (blue) experimental results

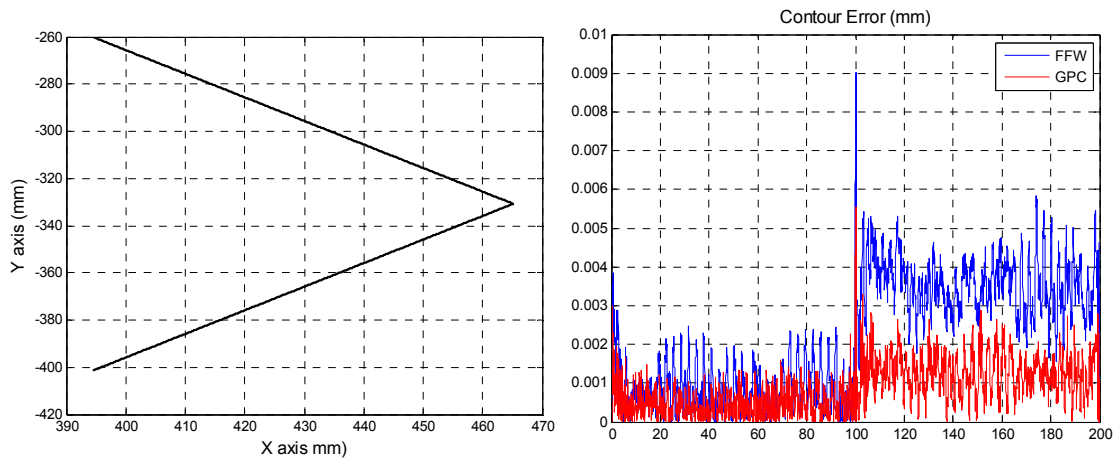

Figure 8; Corner trajectory for x and y axis. GPC (red) and proportional controller with speed feed-forward (blue) experimental results

6. CONCLUSIONS

This paper proposes the elaboration of a predictive axis controller to replace the classical position controller and feedforward action, in order to improve performances in terms of contour errors, especially through a better rejection of friction. The validation was experimentally realized on a CNC machining center including an open architecture module, which enabled implementation of user-defined control structures. The improvement compared to previous predictive realisations comes from the specific choice of the disturbance polynomial, which removes for disturbance rejection the integral action issued from the predictive controller in order to reduce oscillations due to

the existence of static friction. This structure provides indeed better results compared to the currently implemented strategy based on speed feedforward action.

Future work will consider a predictive strategy which can be substituted to proportional control and acceleration feedforward action, in order to provide even better performances, since several factors to be included in a predictive architecture, such as the use of the knowledge of the derivatives of the trajectory and the use of motor and axis sensors, can be investigated for that purpose.

REFERENCES

- [**Altintas, 2000**] Altintas, Y; "Design and analysis of CNC Systems"; In: *Manufacturing Automation. Metal Cutting Mechanics, Machine Tool Vibrations, and CNC Design*, pp. 159-229; Cambridge University Press 2000.
- [**Beudaert, et al., 2013**] Beudaert, X.; Lavernhe, S; Tournier, C; "5-axis local corner rounding of linear tool path discontinuities"; In: *International Journal of Machine Tools and Manufacture*, 73(0), pp. 9-16, 2013.
- [**Beudaert, 2013**] Beudaert, X.; "Commande numérique ouverte : interpolation optimisée pour l'usinage 5 axes grande vitesse des surfaces complexes"; »; PhD - ENS Cachan, 2013.
- [**Boucher, et al., 2003**] Boucher, P.; Dumur, D.; Rodriguez, P.; "Robustification of CNC controllers for machine tools motor drives"; In: *Annals of the CIRP*, 52(1), pp. 293-296, 2003.
- [**Clarke, et al., 1987**] Clarke, D.W; Mohtadi; C; Tuffs, P.S.; "Generalized predictive control – Part I. and II"; In: *Automatica*, 23(2), pp. 137-160, 1987.
- [**Clarke, et al., 1989**] Clarke, D. W.; Mohtadi,C ; "Properties of generalized predictive control"; In: *Automatica*, 25(6), pp. 859-875, 1989.
- [**Landau, 1990**] Landau, I.D.; "System Identification and Control Design: Using P.I.M. + Software", Prentice Hall, Inc. 1990.
- [**Prevost, 2011**] Prevost, D, "Modélisation avancée du couple Machine-outil/Commande Numérique dans un contexte UGV pour l'optimisation du calcul de trajectoires multi axe" »; PhD - ENS Cachan, 2011.
- [**Pritschow, et al., 2001**] Pritschow, G.; Y.Altintas, Y.; Jovane, F.; Koren, Y.; Mitsubishi, M.; Takata, S.; van Brussel, H.; Weck, M.; Yamazaki, K. "Open Controller Architecture – Past, Present and Future"; In: *Annals of the CIRP*, 50, pp. 463-470, 2001.
- [**Rodriguez, et al., 2005**] Rodriguez, P.; Dumur D., "Generalized Predictive Control robustification under frequency and time-domain constraints"; In: *IEEE Transactions on Control Systems Technology*, 13(4), pp. 577-587, 2005.
- [**Susanu, et al., 2004**] Susanu, M.; Dumur, D.; "Improving performance of machine tools with predictive axis controllers within an open architecture framework"; In: *3rd Intl. Conf. on Advanced Manuf. Technology (ICAMT)*; 2004.