



HAL
open science

Chemical enterprise model and decision-making framework for sustainable chemical product design

Juliette Heintz, Jean-Pierre Belaud, Vincent Gerbaud

► **To cite this version:**

Juliette Heintz, Jean-Pierre Belaud, Vincent Gerbaud. Chemical enterprise model and decision-making framework for sustainable chemical product design. *Computers in Industry*, 2014, vol. 65, pp. 505-520. <10.1016/j.compind.2014.01.010>. <hal-01022141>

HAL Id: hal-01022141

<https://hal.science/hal-01022141v1>

Submitted on 10 Jul 2014

HAL is a multi-disciplinary open access archive for the deposit and dissemination of scientific research documents, whether they are published or not. The documents may come from teaching and research institutions in France or abroad, or from public or private research centers.

L'archive ouverte pluridisciplinaire **HAL**, est destinée au dépôt et à la diffusion de documents scientifiques de niveau recherche, publiés ou non, émanant des établissements d'enseignement et de recherche français ou étrangers, des laboratoires publics ou privés.



HAL Authorization

Chemical enterprise model and decision-making framework for sustainable chemical product design

Juliette Heintz ^{a,b,1}, Jean-Pierre Belaud ^{a,b}, Vincent Gerbaud ^{a,b,*}

^a Université de Toulouse, INP, UPS, LGC (Laboratoire de Génie Chimique), 4 allée Emile Monso, F-31432 Toulouse Cedex 04, France

^b CNRS, LGC (Laboratoire de Génie Chimique), F-31432 Toulouse Cedex 04, France

ABSTRACT

The chemical product substitution process is undertaken by chemical industries for complying with regulations, like REACH in Europe. Initially devoted to chemists, chemicals substitution is nowadays a complex process involving corporate, business and engineering stakeholders across the chemical enterprise for orienting the search toward a sustainable solution. We formalize a decision making process framework dedicated to the sustainable chemical product design activity in an industrial context. The framework aims at improving the sharing of information and knowledge and at enabling a collaborative work across the chemical enterprise stakeholders at the strategic, tactical and operational levels. It is supported by information and communication technologies (ICT) and integrates a computer aided molecular design tool. During the initial intelligence phase, a systemic analysis of the needs and usages enables to define the product requirements. In the design phase, they are compiled with the help of a facilitator to generate the input file of a computer aided product design tool. This multiobjective tool is designed to find mixtures with molecular fragments issued from renewable raw materials, and is able to handle environment-health and safety related properties along with process physicochemical properties. The final choice phase discusses the solution relevancy and provides feedback, before launching the product manufacturing. The framework is illustrated by the search of a bio-sourced water-solvent mixture formulation for lithographic blanket wash used in printing industry. The sustainability of the solution is assessed by using the sustainability shades method.

Keywords:

Sustainable chemical product development
Collaborative decision-making
Molecule substitution
Computer aided product design
Process system engineering
ICT

1. Introduction

The chemical manufacturing industry is on the frontline of sustainable development as its product and process activities often strongly impact the environment and people's health and safety. Indeed chemical industries are reconsidering the products that they use and produce, under the pressure of regulations like REACH [1] and VOC directives [2] or of consumers wanting eco-labeled products. They do so from a "doubly green chemistry" perspective: one green for the use of renewable raw materials and one green for the reduction of their impacts [3]. The management of sustainability during the product development cycle is becoming the new

paradigm of chemical manufacturing industries [4–6]. It is inducing a shift from a cost-driven development to a sustainability-driven development [7]. Within the sustainability context and driven by the 12 principles of green chemistry and the 12 principles of green engineering [8,9], specific issues must be looked at: the use of renewable materials, the minimization of energy and material resources consumption, the evaluation of impacts on environment, the consideration of health and safety, the selection of appropriate criteria to assess sustainability [10] and the selection of consistent life cycle methods covering economics, environmental and social issues [11]. However these issues are a concern for hard science engineers that are not the only people to be involved when designing a new product. Indeed, the chemical product development process involves many stakeholders across the chemical enterprise. The market department will get involved for cost analysis, market trends and user needs assessment. R&D chemists, chemical engineers and process operation engineers bring knowledge and expertise in product properties, in process constraints and in product and process design. The quality

* Corresponding author at: Université de Toulouse, INP, UPS, LGC (Laboratoire de Génie Chimique), 4 allée Emile Monso, F-31432 Toulouse Cedex 04, France. Tel.: +33 534323651.

E-mail address: Vincent.Gerbaud@ensiacet.fr (V. Gerbaud).

¹ Current address: Prosim SA, Immeuble Stratège A, 51, rue Ampère, F-31670 Labège, France.

Nomenclature

BPMN	business process modeling notation
CAMD	computer aided molecular design
CAPD	computer aided product design
DSM	Design Structure Matrix
EHS	Environmental, Health, Safety
ICT	Information Communication Technology
LCA	Life Cycle Analysis
LISI	levels of information system interoperability
LCIM	level of conceptual interoperability model
MDE	model driven engineering
MMI	Man Machine Interface
OCL	Object Constraint Language
OIM	organizational interoperability maturity
PSE	process system engineering
QFD	Quality Function Deployment
QSAR	Quantitative Structure Activity Relationship
QSPR	Quantitative Structure Property Relationship
RED	property name expressing the ratio of Hansen Solubility Radius versus the HSP sphere radius for a given product
RM-ODP	Reference Model of Open Distributed Processing
SBVR	Semantics of Business Vocabulary and Rules
SME	Small Medium Enterprise
UML	Unified Modeling Language
VOC	Volatile Organic Component
XML	Extensible Markup Language

management department is responsible for ensuring the product quality through norms and means to achieve it. The business process experts will be managing production and chemical supply chain; corporate managers. ... Hung et al. [12] wrote: 'Effective product development depends on the integration of a variety of specialized capabilities, strong functional groups with interdisciplinary teams and multiple progressive pressures. New product development [...] involves cross-function integration, a complicated interdisciplinary activity that requires many knowledge inputs to generate a suitable product solution as well as an appropriate project plan in the time-competitive environment'. This stresses the importance of information and knowledge management between people that are coming from different cultures and the importance of bringing them to consider all the sustainability issues together.

In this context, we develop an ICT based decision-making frame to improve the collaborative participation between all stakeholders in the development of sustainable chemical products. To our knowledge it is the first time that such a framework is coupled with a computer aided molecular design for finding chemical product, and that this coupling is specially aimed at sustainable chemical product development. Section 2 surveys a background on chemical product development activity issues and on enterprise-wide product engineering. Section 3 reviews limitations of existing approaches and tools. It identifies five challenges and suggests solutions. Section 4 describes our ICT solution and computer-aided chemical product development. It is split into a description of the chemical enterprise perspective and of the different phases of the decision process. It incorporates a distributed computing solution aiming at finding chemical products satisfying predefined requirements within a sustainable context. Section 5 describes a detailed industrial based case study aiming at finding a novel ink wash-blanket solvent in a printing manufacture.

2. State of the art

2.1. Chemical product development

Hill [5] stated that chemical product development covers "(1) chemical product design and development, and (2) product-oriented process design and development", also called chemical product engineering [4]. We restrict ourselves to the first issue in this paper.

2.1.1. Product classification

Refs. [13,14] classified products in basic, structured and configured-consumer products. Basic/functional chemicals encompass commodity, intermediate and specialty chemicals that are designed for achieving one function (solvent, reactant) and for matching only a few key physicochemical properties (solvent power, boiling point, etc.). Structured products and configured-consumer products combine many properties and functions in a single product, which is often a mixture. Structured products (cream, films, etc.) or industrial chemicals are assemblies of basic chemicals [4,15]. Some of their properties can be set by the product manufacturing process itself [5,16], which induces a simultaneous design of the product and process. Configured-consumer products (drug delivery patches, post-it note, drug pill...) target the end-user markets and are assemblies of several industrial products with a focus on their physical construction [15]. For all product classes, the set of requirements is complex. It can include qualitative sensory factors, environment, health, safety (EHS) impact-related properties, stability and flowing considerations along with more traditional physicochemical properties. Costa et al. [4] focused on product perceived quality factors and identified three property classes: product properties, process-related properties and usage-related properties to encompass all the product technological requirements.

2.1.2. Product design solutions

For designing a new chemical product, the traditional trial and error bottom-up approach is intrinsically inefficient. It proceeds as follow: given a raw material, perform chemical, physical or biochemical transformations to make a molecule; then check properties and see a posteriori if the expected requirements are matched. Instead, top-down reverse engineering approaches focus in needs first: they define a priori a set of target property values and search for complying molecules, either into databases or by building them from a pool of small chemical elements. Reverse engineering is nicely implemented within computer-aided molecular design (CAMD) tools [17–19]. Those tools rely upon a multi-objective optimization technique to build candidate molecules and upon property estimation models to evaluate the candidate performance vs. the set of a priori target property values. The use of accurate property prediction methods is recommended to legitimate the CAMD predictive process. Nevertheless, experimental synthesis and validation completes the CAMD process. Within the CAMD tools, the objective function can aggregate any types of property for which exists an estimation model based on the molecular and product structure. We identify group contribution methods [20–23], QSAR/QSPR methods [24], similarity models for toxicity models [25] and arbitrary scaling methods for sensorial properties [26].

For mixture products, each mixture component can be designed and property models with linear or non-linear dependency on the mixture composition must be considered. Most computer aided product design (CAPD) tools perform a sequential search of each product components individually for example by using CAMD, before checking mixture properties and mixture stability [27–30] or decompose the overall problem into a subset of subproblems [31]. This prompted us to develop in parallel to the present paper

contribution, a new CAPD tool performing a global mixture search by using a genetic algorithm on a versatile matrix molecular structure representation [32]. It enables to bias the search toward molecules coming from renewable resources, and to account for the poor accuracy of existing property estimation methods for the less studied renewable molecules pools used to build the candidates.

2.1.3. Product requirements

The standard definition of a requirement [33] remains arguable, since its perception by the user and by the solution provider can be different [34]. As a general definition, we state that a requirement defines an expectation expressed by one of the stakeholders in a direct (performance) or indirect (forbidding, limiting) manner. Furthermore, requirement statements betray the culture of the stakeholder enouncing it: engineers will use mathematics, physics, chemistry and numbers to express requirements in terms of property specifications; corporate managers will use words. A classification of properties was presented in the sub-section above about product classification.

To harmonize the expression of requirements and their understanding, an unambiguous semantic shared by all stakeholders is needed: For requirements not requiring explicit math formulas, the business rule concept is well fitted. It enables to express conditions and recommendations in terms of necessity or obligations [35,87] and allows some external control of the process and procedure within the enterprise strategy [35]. For hard science engineering requirements, maths and numbers can be used to express constraints. Language can further be used to express the requirements without ambiguity: the Semantics of Business Vocabulary and Rules (SBVR) [36] and Object Constraint Language (OCL) [37] apply for business rules and constraints respectively.

2.1.4. Chemical product design activities

The process system engineering (PSE) discipline aims at developing model-based methods and tools for the chemical industries [38]. It invented the CAMD approach which has become the leading technique for chemical product design [39]. As the product design and manufacturing processes are related to each other, a management of the activity workflow and the associated information is welcomed [40]. In PSE, Varma et al. [41] acknowledged the importance of 'enterprise-wide cross-functional coordination' for the chemical supply chain and stressed the need for integrating decision-making across the enterprise layers. Indeed, a corporate level decisions about finding a new green non-fossil based molecule will influence decision-making at the activity/process level where the new product is developed.

Among several frameworks that model chemical product development activities [13,16,28,42]. Hill [5] described an eight steps methodology for basic/functional products design: (i) product definition with an analysis of customer needs; (ii) technical product requirements; (iii) product performance relationship and derivation of property prediction models; (iv) product candidate generation; (v) product candidate selection; (vi) process design; (vii) risk analysis; and finally (viii) business case analysis. For more complex products, classified as structured or configured-consumer products, no generic methodologies exist.

Under the name 'integrative product design strategies', Smith and Ierapepritou [14] reviewed how consumer, product-process performance and business issues are handled within the chemical product design activities of 15 industry actors producing specialty chemicals, drugs, food, personal care and bulk chemicals. They noticed that consumer needs are always taken into account, and that product-process performance integration is very often implemented in practice although no standardized approach emerges. Regarding business decision variables, they concern project planning and scheduling, resources allocation, product

portfolio management and supply chain management. But the linkage to the product design activities is not trivial [14].

Gagnon et al. [43] reviewed both conventional and sustainable design processes in the literature and proposed to classify integrated sustainable engineering design process activities in four stages at first; planning and problem definition, conceptual design, preliminary design and detailed design, which are also found in the stage-gateTM product development process stages [15]. Then, they split further the four stages into 22 tasks. Usual steps like design specification, alternative concept generation, alternative concept performance evaluation, are complemented with steps that Gagnon et al. claimed to be critical for achieving sustainability: multidisciplinary project team, definition of sustainability (sustainable issues relevant for the problem, criteria, assessment methods, monitoring indicators, etc.), selection of an approach for multi-criteria decision making, performance assessment according to the sustainability criteria or indicators. Finally, they proposed a methodology to evaluate the extent of sustainability achieved, by using four degrees of shade over six dimensions of sustainability. The six dimensions cover the design process itself, the indicator relevance, the sustainability issue covered, the analysis tool accuracy, the alternative performance and the decision-making process itself.

2.2. Enterprise-wide product engineering

2.2.1. Decision making process

Simon's early three phase modeling decision making process: intelligence, design and choice phases [44], is often completed by an implementation phase, a feedback monitoring phase [45] and a knowledge capitalization phase [46]. Decisions are taken by people and can be hierarchized in parallel with the organization of the enterprise [47,83]. In that case, it is common to distinguish between strategic, management/tactical and operational decision levels. Among the numerous decision making methods, we can cite DELPHI [48,49], ELECTRE [50], PROMETHEE [51], multi-attribute utility technique [52], analytic hierarchy process [53], analytic network process [54].

Ng [55] sketched a hierarchical decision-making process for chemical product and process design concerning both process system engineering and business process engineering. He matched a four level organization (corporate, business unit, manufacturing site and R&D laboratories) with a business decision-making framework hierarchized in the order of decreasing time and length scales, from corporate to molecule level. Refs. [10,56] proposed a generic decision-support framework for sustainable development and used it in the chemical process design area [11]. They identified the stakeholders and their level of interest in economic, environmental and social issues. They also discussed sustainability indicators choice and pertinence, and considered several multiple criteria decision analysis (MCDA) techniques to help the decision makers in choosing the most sustainable option. The framework was claimed to improve dialog and increase a shared knowledge among decision-makers, to show trade-offs between conflicting objectives.

2.2.2. Product design framework

Intended for the planning of the product design activity, Hung et al. [12] developed a knowledge-based system by using the Design Structure Matrix framework (DSM) [57] for managing information flows and for planning product and process design scheduling and costing. The Quality Function Deployment technique (QFD) [58] was also used by Hung et al. to transform the customer needs and market requirements into technical requirements and specifications. Finally, they coupled the QFD and DSM components with a knowledge-based product database. The

database provided necessary information to support the product design: customer requirements for elaborating the technical function and for connecting it to the QFD solution principles; engineering requirements; product parts; the product architecture; the design process template to generate the duration and cost of design activities within the DSM framework.

Dekkers et al. [59] used a generic reference model for describing firstly, the product design and product engineering process, secondly, the product manufacturing process activities, thirdly, their direct relations and the feedback loops between them. Reviewing the literature, they isolated five research themes in it and isolated a sixth theme requiring more effort, called "Enabling [the interface between the two processes] through Information and Communication Technology". A side comment to that theme was the necessity of bridging the management culture and the engineering culture across the enterprise.

2.3. Enterprise modeling and integration concepts and tools

According to Vernadat [60], enterprise modeling and integration aims at facilitating information sharing across the enterprise stakeholders by using models of the structure, the behavior and the organization of the enterprise. The enterprise organization is usually modeled in the aforementioned works [10,41,55,56] by a hierarchy with stakeholders. For example, Ng listed stakeholders in four enterprise level for a chemical enterprise [55]: CEO, CTO, CFO and board members at the corporation level; business VP and marketing managers at the business unit level; plant managers and operating personnel at the manufacturing site level; R&D directors, chemists and engineers at the R&D laboratory level.

For a consistent representation of the enterprise architecture, the ISO 19440 standard recommends to use four views [61]: functional (event-process-activity), organizational (enterprise structure), informational (object-data) and resource (resource, capability) [62]. Lê and Wegmann [63] discussed challenges in enterprise architecture and selected the RM-ODP (Reference Model of Open Distributed Processing) hierarchical model architecture for providing multiple view of the enterprise and its environment, such as its internal structure, the services provided by the enterprise, the business processes, the data flow between business entities and the information technology components and their interactions.

The degree of interoperability achieved within the enterprise architecture entities can be appreciated with the help of models summarized by Panetto and Molina [64]: the LISI (levels of information system interoperability) model focuses on technical aspects and complexity of interoperations between systems through five degrees: isolated, connected, functional distributed, domain integrated or universal systems. The OIM (organizational interoperability maturity) model deals with the enterprise environment and organizational issues that contribute to the interoperable systems. The system technical coherence – alignment – can be evaluated through the LCIM (level of conceptual interoperability model).

Alignment is an important objective of model driven engineering that we use in this work. Vertical enterprise integration refers to decision-making integration [60] or to strategic alignment (Henderson and Venkatraman [86]) across the enterprise organizational layers like those described by Ng [55]. Horizontal enterprise integration refers to physical and logical integration of business processes from product demand to product shipment (Venadat, 2002) or to coherency of information across the modeling layers (metamodels, conceptual models, implementation models). For achieving vertical and horizontal alignment, model-driven engineering (MDE) tools, concepts and languages can be used [65]. With that approach, our process and system analysis relies upon the integration of different technical spaces combining BPMN (business-process modeling notation [66,67]) and UML 2.0 (Unified Modeling

Language, [68]) and object-component oriented technologies for encompassing all four views of the enterprise recommended by the ISO 19440 Standard [61]. Some information documents were also structured by using a XML scheme.

3. Limitations and proposed solutions

We propose a solution customized for sustainable chemical product design by using standard modeling semantics and decision making techniques within an ICT supported framework. To our knowledge it is the first time that such a framework is coupled with a computer aided molecular design tool for finding chemical product, and that this coupling is specially aimed at sustainable chemical product development. Thus we contribute to the bridging of the management culture and the engineering culture across the enterprise as advocated by Dekkers et al. [59].

From the state of the art section, we observe that a newly designed chemical product is ultimately chosen based on the satisfaction of requirements formulated by various stakeholders from engineering, business, management cultures across the enterprise layers. Corporate managers may decide at the strategic level to cope or not with REACH regulation and initiate a product substitution activity. At the tactical level, business unit experts, product manager and the marketing office may formulate consumer-related requirements and target a specific crop as a possible renewable material source for the future product molecules. Then at the operational level, engineers may specify these high level requirements into property specifications and chemical structures. Those decisions propagate down through the enterprise layers and are gradually refined.

Therefore, it appears from the state of the art section that the design of a sustainable chemical product sets five key challenges: (1) decision management and propagation, (2) involvement of many stakeholders across the chemical enterprise, (3) management of the information and stakeholder knowledge, (4) modeling of the chemical product information (molecular structure, property classes, property models covering both technical and impact issues), (5) ensuring the sustainability of the solution. For each challenge we propose solutions:

1. For decision management, we select the three phases decision sequence of Simon [44] and use it with the help of the DELPHI method. Although it is not sufficient to handle all business decision variables recorded by Smith and Ierapepitou [14], it covers reasonably well the chemical product design activities before their implementation [5,43]. The Intelligence phase covers Hill's steps (i) and (ii) about product definition, user needs and requirements. The design phase covers steps (iii) about product performance and step (iv) about product candidate generation. The choice phase concerns step (v) about product candidate selection. Steps (vi) to (viii) are partially covered and would be fully in an extended version of Simon's sequence: process design step (vi) belongs to an additional implementation phase but also to the design phase in the case of so-called structured products; steps (vii) about risk analysis belongs to a monitoring phase but is also relevant during the choice phase and step (viii) about business case analysis belongs to a knowledge capitalization phase. In addition, some business variables like resource allocation can still be introduced as requirements in the intelligence phase, as we illustrate later in the case study. Finally we hierarchize the intelligence phase decisions through strategic, tactical and operational levels.
2. In parallel with that hierarchical decision-making, we describe the enterprise organization with four layers (corporate, business process unit, chemical engineering and chemist) and relate them to strategic, tactical and operational decision levels that

will structure the decision propagation during the intelligence phase. This intends to achieve vertical alignment.

- For the management of knowledge and information, we intend to document each decision and the process of decision refining. During the intelligence phase, decisions are refined as they propagate through the enterprise organizational layers. We provide access to the documentation produced by other stakeholders so as to allow each new decision to be taken in awareness of previous decisions. For consistency, we use standard semantics and standard documentation. Besides, considering that stakeholders at the strategic and tactical level might express requirements word semantics whereas operational level stakeholder might use maths constraints, we decide to split requirements into business rules and constraint types, expressed with SBVR and OCL semantics respectively. Design phase and choice phase will also be documented. By bringing consistency through the organizational layers relations, the use of standard semantics participates in achieving horizontal alignment in its information sense, across the modeling layers.
- For the product design process, we use the so-called IBSS CAPD tool developed in a parallel work and customized specifically for sustainable product design [32]. As any CAMD approach, IBSS is performing a need-oriented search, which makes it ready to exploit the requirements tree resulting from the intelligence phase. It uses a detailed molecular representation and it is able to cope with a large number of property specifications expressing product requirements. Hence, IBSS can be used to find both basic and structured products as defined by Smith and Ierapepitou [14] being either single molecules or mixtures, and to orient the search toward bio-sourced molecules. Regarding properties, properties described by Costa as process-related property can be handled if we can find an alternative expression decoupled from the manufacturing process and applicable to the product design activity. For example when searching for a new extractive distillation solvent, we can related the manufacturing extractive distillation process efficiency to the relative volatility thermodynamic property which is computed by using only the chemicals involved, independently of the distillation process configuration.
- For ensuring the sustainability of the solution, we first allow requirements to include sustainable issues during the

Intelligence phase. During the design phase, the IBSS CAPD tool is able to handle environmental, health and safety related properties for describing the sustainable requirements. Besides IBSS allows the user to impose bio-sourced fragments in the candidate molecules, improving their sustainability by satisfying a key principle of green chemistry "use of renewable materials". In addition we use the procedure of Gagnon et al. [43] to assess the degree of sustainability during the choice phase.

Overall, according to the LISI scale for appreciating the degree of interoperability, our solution reaches an intermediate degree, as it is a "functional distributed" solution.

4. An ICT based frame for sustainable product development

4.1. Chemical enterprise modeling frame

In Fig. 1, we sketch a chemical enterprise modeling frame where decision levels are assigned to enterprise layers and set in parallel with stakeholder roles and with a multi-scale description of the chemical enterprise from molecules to enterprise-wide issues. Thereby, the frame enforces a vertical alignment through interrelated layers describing the decision, the organization and the system (here a chemical product).

The pyramid axes aim at capturing the pillars of sustainable engineering principles, society, environment and economy [43] while keeping engineering and technology as the core activity of the enterprise.

We assume a simplified organization of the enterprise with four hierarchical levels inspired by those of Ng [55]. At each level, a stakeholder is defined as a role, which can be played by a team of people in large companies. Inversely a single person can be in charge of several roles in a SME. A stakeholder faces stimuli along each of the three axes (see examples in Fig. 1) that will participate in the setting of the product requirements. Then the stakeholders are confronted to strategic, tactical or operational decision levels for responding to those stimuli. Strategic and tactical levels may concern several stakeholders. The operational level concerns hard-science and engineering issues.

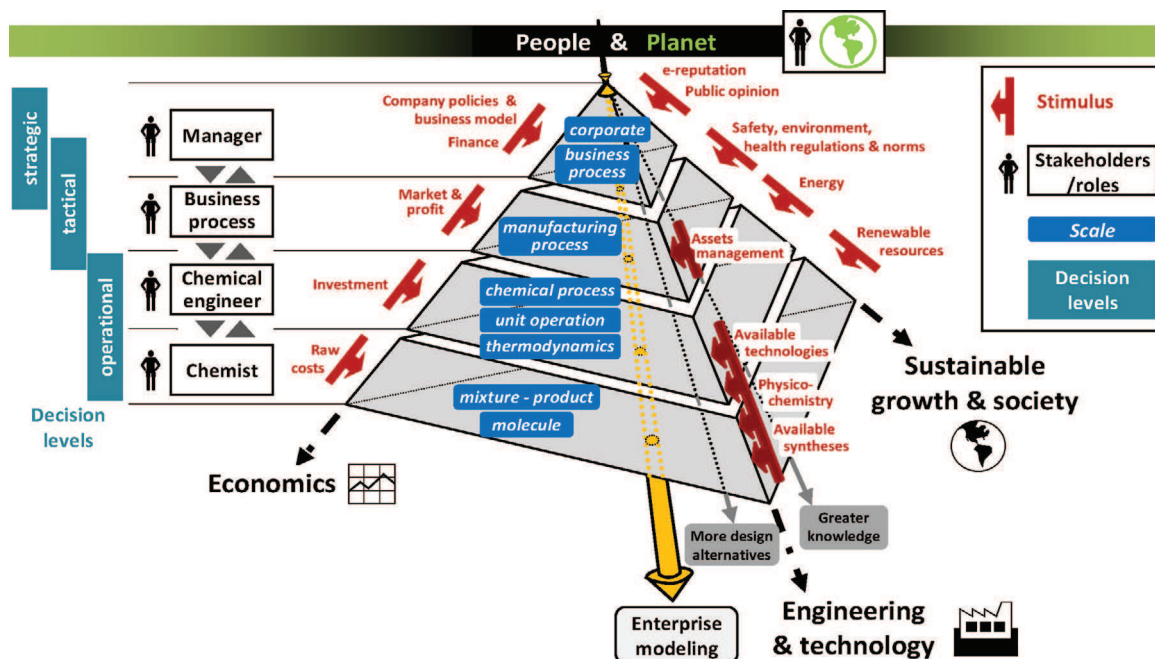

Fig. 1. Chemical enterprise scheme within the sustainable growth paradigm.

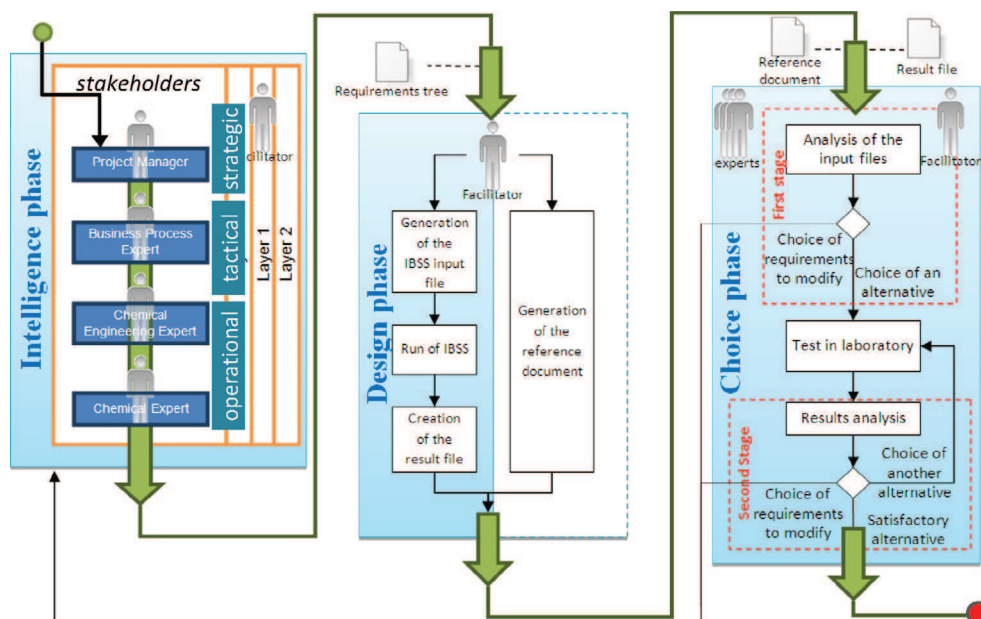

Fig. 2. Overview of product design decision making process.

Each level is confronted to one or more of the eight system scales from the corporate to the molecular level. From our proposal of chemical enterprise model (Fig. 1), we may list: Corporate <> Business process (portfolio of products, financial operations, etc.) <> Manufacturing process (production plant, biochemical or petroleum-based process, suppliers, storage and transport, etc.) <> Chemical process (production, water & energy network, waste treatment, etc.) <> Unit operations (intensified reactor, heat integrated distillation, filter, crystallizer, etc.) <> Thermodynamics (phase transitions, aqueous phases, organic phases, reacting media, etc.) <> Mixture-product (structured product, end-user cream, etc.) <> Molecule (raw material, active principle, etc.).

As we go toward smaller scales, design alternatives increases within the decision process and the related knowledge and information as well.

4.2. Decision making process for sustainable chemical product design

The decision process is triggered by a stimulus that either conflicts with the business policy, like product substitution of a

chemical to comply with the REACH regulation, or motivates a change in the business policy, like adding greener solvents to the product portfolio. Fig. 2 displays our decision making process for sustainable product design, based on Simon's original process [44].

4.2.1. The intelligence phase

For chemical product design, the intelligence phase goal is to set requirements that meet customer needs and comply with the enterprise strategy. They are used in the next design phase to constrain the mixture structure and the properties target values. Fig. 3 describes the vertical multi-levels and horizontal abstraction layers supporting the intelligence phase.

We suppose that the four stakeholders of the enterprise pyramid are involved sequentially, concerned with decisions at the strategic (manager), tactical (business process expert) or operational level (chemical engineers and chemists). The tree of requirements is defined during a top-down hierarchical process through the strategic, tactical and operational levels. The propagation of the decision ensures a strategic alignment as the

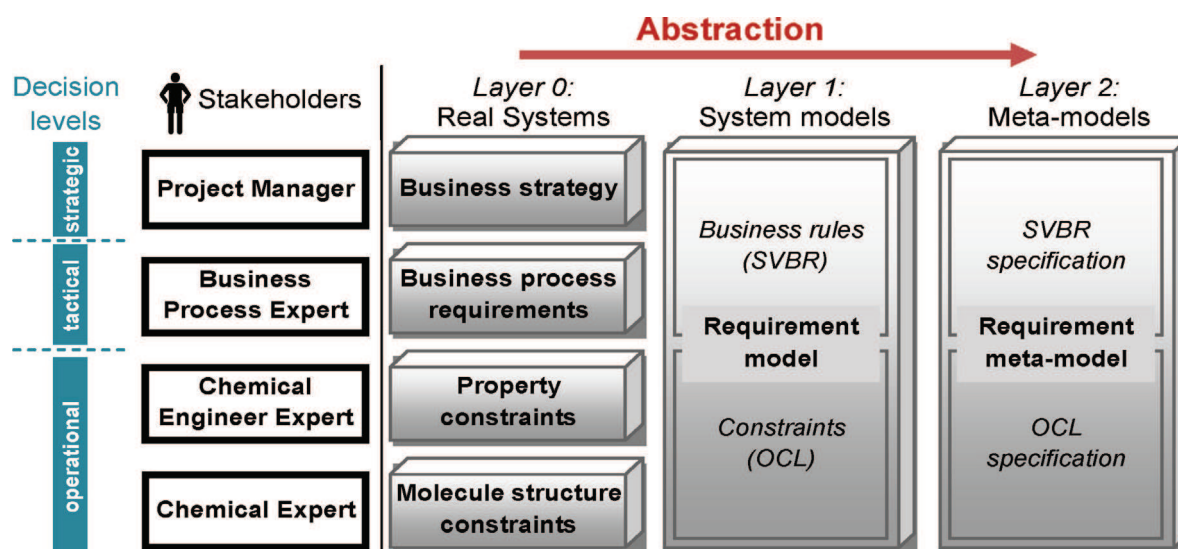

Fig. 3. A simplified multi-level and multi-layer approach for the product design Intelligence phase.

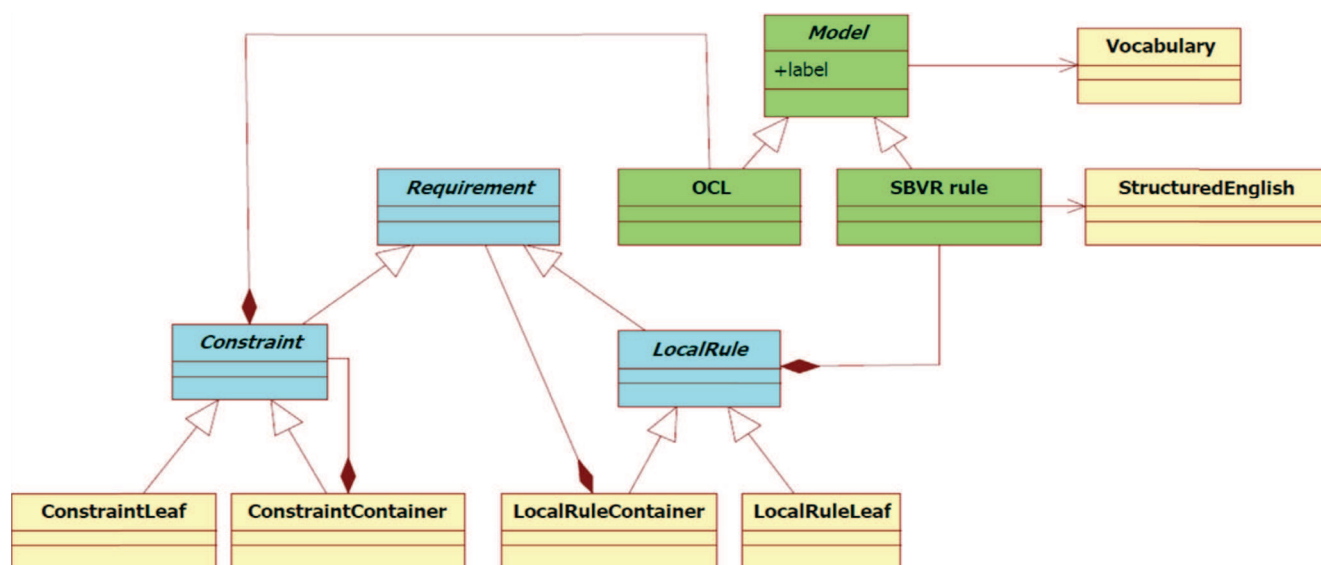

Fig. 4. An UML2 model of requirement.

decisions taken have an impact on the lower levels. This way the business strategy is followed at each level of the enterprise.

The horizontal alignment is limited to the use of a single unified requirement model for all decision levels (Fig. 3), but a more generic multi-layer frame was presented elsewhere [69].

According to Fig. 1, each stakeholder faces directly some stimuli along the three, economy, engineering and socio-environmental axes. It allows him to address specific types of requirements (layer 0 in Fig. 3). We decide that requirements are expressed as business rules at the strategic and tactical level, whereas the operational level can directly express constraints. The requirement model is displayed as a UML2 model in Fig. 4. It shows that the constraints are modeled by using OCL and the local rules are expressed as SBVR using structured English to avoid any ambiguous interpretations and to improve communication.

In addition, we use a coloring of the requirements is used to stress the interest level of the requirements: yellow refers to a “consider in priority” interest, white refers to “consider as well” interest and shaded gray refers to “ignore” interest. The “ignore” status means that the requirement is kept in mind but is inactive for the current level. It may be reactivated along the construction of the requirements tree by other stakeholders, as all of them can access the entire tree details and documentation.

At each level, the dedicated stakeholders are asked to express the stimuli they face as requirements within the tree. But as highlighted in the background section, collaborative work should be welcomed to reach a final set of requirements that is conform to the enterprise reality. In addition to a full access to the tree of requirements by any stakeholder, we introduce a so-called facilitator, possibly the product design project manager. As a human factor easing the overall collaboration, he manages the different layers and skills needed for the requirements maturity. At the present level of our framework development, his activity is supported by a common document oriented tool for handling the textual and informal notes attached by the different actors to the different objects such as the requirement objects along the intelligence phase. We foresee two future developments. One is to use Enterprise Social Software (ESS) tools in support of the facilitator activity, which are based on the concepts of Web 2.0 [70], or Semantic web [71]. A web 2.0 portal is under consideration for developing specific add-on modules to an existing collaborative platform. Its core requirements are: profiles management according to stakeholder, skills and organization level, information

automation, statistics, charts and dashboards, chat, markers of progress, markers of opinion, space for sketching, notes and tags management. The second aims at improving the knowledge management based on simple notes by using semantic and ontological annotations which are not only human readable but also suited for computer processing. For this way we have to define a formal vocabulary and meaning of the different skills existing in our chemical enterprise context. A further perspective would be to implement the concepts of Robin et al. [72] which allow modeling of collaborative knowledge and integrate it into a design context enabling an efficient support of the stakeholders during the intelligence phase.

4.2.2. The design phase

The design phase focuses on the generation of chemical product candidates. Fig. 2 shows that the facilitator supervises the selection of a suitable method for generating alternatives. We use our own computer aided product design (CAPD) tool [32], briefly described below. The requirements tree data from the intelligence phase are used as input and transformed into product specifications. Some requirements are unsuitable for the CAPD tool, like the cost evaluation, and are put aside to be considered later during the choice phase. CAPD tool-specific parameters are added by the facilitator, like those related to the multiobjective search algorithm. In parallel, the facilitator formalizes a reference document understandable by the experts involved in the next decision-making process choice phase. It contains the requirements set during the intelligence phase and the CAPD parameters.

As a result of the design phase, output candidate molecules or mixtures are listed. Each candidate is ranked according to a performance note expressing its match with the set of requirements. However, since the CAPD tool is based on predictive property evaluation models, the candidate relevance depends on the accuracy of the property evaluation models used. Besides, some molecular structures may not be actually feasible or easy to synthesize. Thus, human expertise and laboratory consolidation are necessary and handled in the next choice phase.

4.2.3. The choice phase

The choice phase consists in choosing which alternatives can be implemented. We select the DELPHI method used in Tavana et al. [73] for helping with the choice of the best alternative. A facilitator runs an analysis on the questionnaires' answers and on the

motivations of these answers. If no consensus is reached, a second round starts and the experts answer the questionnaires once again until the group converges toward a consensus answer.

Experts should come from the domains of chemistry, chemical engineering, process system engineering, industrial engineering (supply chain issues) and industrial economy and manager staff. They also should not have participated in the design phase to give an impartial opinion and bring new ideas if necessary, and they should be kept anonymous. The use of ESS web-supported ICT tools to edit the polls and collect the answers can allow the experts in different location to fill the questionnaire whenever and wherever they like, also saving time and money.

A questionnaire for chemical product design is available in the appendix of Heintz [74] and contains four distinct sets of questions, about the performance of the alternatives (relevance of property choices, of property weighting, of target values, of property estimation methods, etc.), about the product structure (synthesis feasibility of each component of the mixture, of the mixture as a whole, mixture composition, relevance of molecule structure choices, of fragments building blocks number and type, etc.), about the search algorithm (relevance of the algorithm parameter choices, etc.) and about general issues (overall appreciation of the number of alternatives to compare, selection of the five best alternatives, specific rejection criteria and justification for some alternatives). If experts are not able to answer questions they can leave a "no opinion" answer.

Fig. 2 shows that the choice phase enables to start over the intelligence phase. Four causes were imagined: 1. There is no acceptable alternative. 2. Potentially interesting alternatives are not credible, as a result of inappropriate requirements on molecular structure, property estimation models or operating conditions. 3. The best alternative has a medium performance. In this case, a better tuning of the weighting of the property targets in the global objective function must be encouraged if it still complies with the customer needs priority list. 4. The best predicted alternative is deemed unsuitable for laboratory test, being chemically non-feasible, or too costly with the existing synthesis techniques, or too costly because of the high cost of raw materials available at the time of the search.

For choosing the best alternative, the experts have access to the intelligence phase requirements tree, the related documentation, and to the design phase outputs. These latter are the candidate molecules or mixtures and related property values and all the tool-related choices (property estimation models, chemical building block pools, etc.).

Finally, considering that the design phase relies mostly on computer prediction methods which accuracy may not be optimal, we implement a two stage DELPHI procedure inspired by the post-mortem phase of Howard method [75] (Fig. 2). The first stage selects the best predicted alternative. The corresponding product is then synthesized and formulated in laboratory, including experimental property measurements. In a second stage, the experimental data then replace the property estimation in the performance calculation and the experts decide whether the final alternative is still worthy. If not, another alternative is chosen for testing.

4.3. An original CAPD solution for the design phase

Our so-called IBSS CAPD distributed computing tool was developed for finding sustainable products. It allows running a multiobjective simultaneous search over the optimization variables like the mixture molecules, the mixture composition and the mixture operating conditions. Besides it can handle a large variety of property estimation methods, including mixture properties, and it is able to bias the search toward molecules issued from renewable material stocks. The IBM-RUP (rational unified process)

software development method was applied [76]. This iterative process is centered on the software architecture and is driven by the functional needs. In our case, they were defined thanks to the interview results of the partners in the French ANR CP2D 2009 project InBioSynSolv aiming at designing new biosolvents. These partners covered the enterprise layers: chemist, chemical engineer, product business unit, corporate.

We provide below the core model from the architectural, functional, behavioral and structural views in the UML concept understanding [68]. A complementary description of the IBSS tool focused on the mixture building and evaluation is published elsewhere [32].

4.3.1. Architectural view

The CAPD tool architecture is built around three software components, MMI in front office, Search and P3 in back office, which can be used independently. Together they form the IBSS application. The Man-Machine Interface (MMI) is developed in java for allowing a distributed multi-platform deployment of the IBSS client. The Search component is written in C#. It manages the search algorithm by generating mixture candidates and by modifying them to investigate the solution space. The evaluation of the performance with respect to the target values set in the objective function of all the candidate solutions is done by using the property values returned by the P3 components. The P3 (Property Prediction Package) calculation component is a VB.NET Dynamic-Link Library. The list of property calculation models can be updated independently of the other components.

4.3.2. Functional view

UML use cases have been ran to define four functionalities [74]. They are: (i) launch a search, (ii) define an XML problem file, (iii) define properties and models used to evaluate the performance of the molecule or mixture, (iv) evaluate the properties and performance of a set of mixtures.

For the use case (ii), assuming that the requirements tree is complete and exhaustive, the facilitator defines the XML problem file after adding the tool specific parameters, namely search algorithm parameters for IBSS. The XML file is the input of the CAPD tool and contains three types of data. (i) The mixture data enable to customize the mixture composition and structure, by defining the possible fixed parts and the degrees of freedom of the different variable parts and the building blocks. (ii) The objective function data refer to the properties to evaluate, their target values, the property estimation models and the operating conditions used to calculate these properties. (iii) The search algorithm parameters are all the data that can directly influence the speed and the effectiveness of the search, namely the population size and the elitism policy. The other functionalities are detailed in Heintz [74].

As part of the objective function data, Fig. 5 shows the UML Class diagram for the OCL description of the calculable property target values. It shows that for each calculable property one must choose a relative weight in the multiobjective performance function, a target value, a property estimation model and possible process operating conditions (temperature, pressure, etc.), a performance function describing the evolution of performance with the difference between predicted and target value, and eventually some parameter value useful for the property calculation model (ex. the reference values of a scale-based real property model).

As part of the mixture data, Fig. 6 shows the mixture framework enabling to customize the search. Molecules can be fixed or free within a mixture. For a free molecule, it is possible to fix or not some fragment which can be constructed from preselected chemical building blocks.

For the use cases (ii) and (iii), the MMI component implements a dual login access, for basic and expert user, with different panel

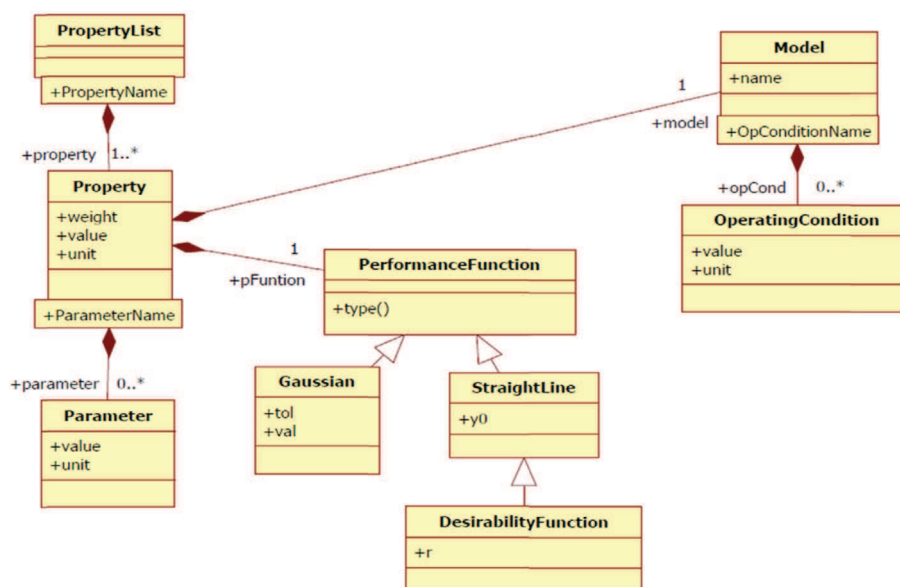

Fig. 5. Class diagram used for the OCL description of the constraints on the properties.

views. The dual login is aimed to complete missing XML data in case the tree of requirement issued from the intelligence phase has not been refined enough. An expert user can access all functionalities and refine all data whereas a basic user has a limited access. In accordance with our chemical enterprise organizational structure (Figs. 1 and 3), a basic user is typically a corporate manager or a business process stakeholder. A basic user can propose the number of elements in the mixture, fix some of the mixture compounds or leave them free for the search, select predefined source of building blocks (sugar-based, vegetable-oil based, glycerol derivative based, etc.), define so-called real properties guidelines. The expert user, a chemist or chemical engineer in our organization, can customize the lists of building blocks, set the molecule structure and fragment data, select calculable properties and their estimation models, define property target values, define new sets of real property, assign the search algorithm data.

Available to basic user after having been defined by an expert user, real properties are distinguished from the calculable properties described in Fig. 5 class diagram. They are not linked to property estimation models and are described on a scale-based degree: from low to high. For each real property, one or several calculable properties are predefined [32]. For example, the real property 'EHS impact' is evaluated by computing the 'acute toxicity' + 'flash point' + 'vapor pressure' + 'biodegradability' properties. Setting a real property degree triggers default values constraints in the associated calculable properties.

4.3.3. Behavioral view

The behavioral view presents the different processes of the tool and is shown in Fig. 7.

Fig. 7 highlights the three components and their interoperability. The interoperability between the MMI and the search components is asynchronous via XML and text files. Eventually, the facilitator can directly generate the XML file from the requirements tree data issued from the intelligence phase, completed with IBSS specific search parameter as recalled before. The interoperability between the search and the P3 calculation components is synchronous and windows library like.

A multipurpose data structure for describing molecules, fragments, basic and complex building blocks has been developed [32], inspired by earlier works on molecular graph [77,78]. It enables to describe molecules, structures, fragments, connections and chemical building blocks in the XML input file of the search component, to print the molecule structure information in the text output result file. It also enables to perform efficiently molecule structure modifications within the search component, while accounting for the predefined customization of the mixture structure by the user when setting the problem in the MMI component or directly by the facilitator. It is also used to communicate the relevant molecule information between the Search and P3 components so as to compute properties.

Fig. 7 shows that there exist three packages within the search component. The MMI and problem packages handle the interoperability with the MMI component and assign the XML input file

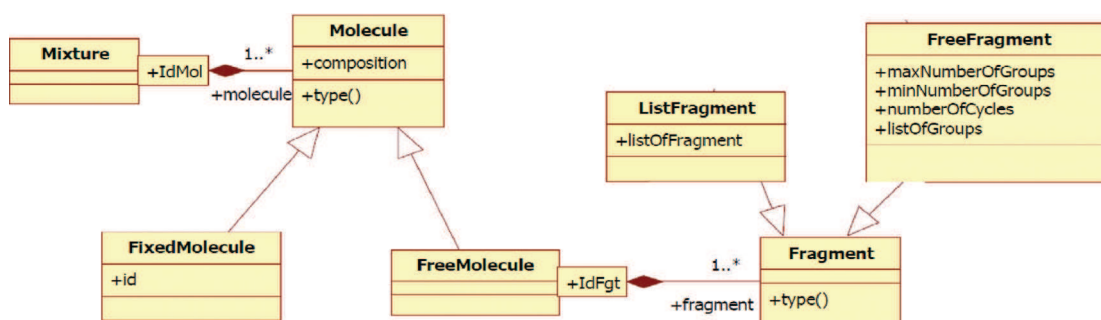

Fig. 6. Class diagram used for the OCL description of the constraints on the molecular structures.

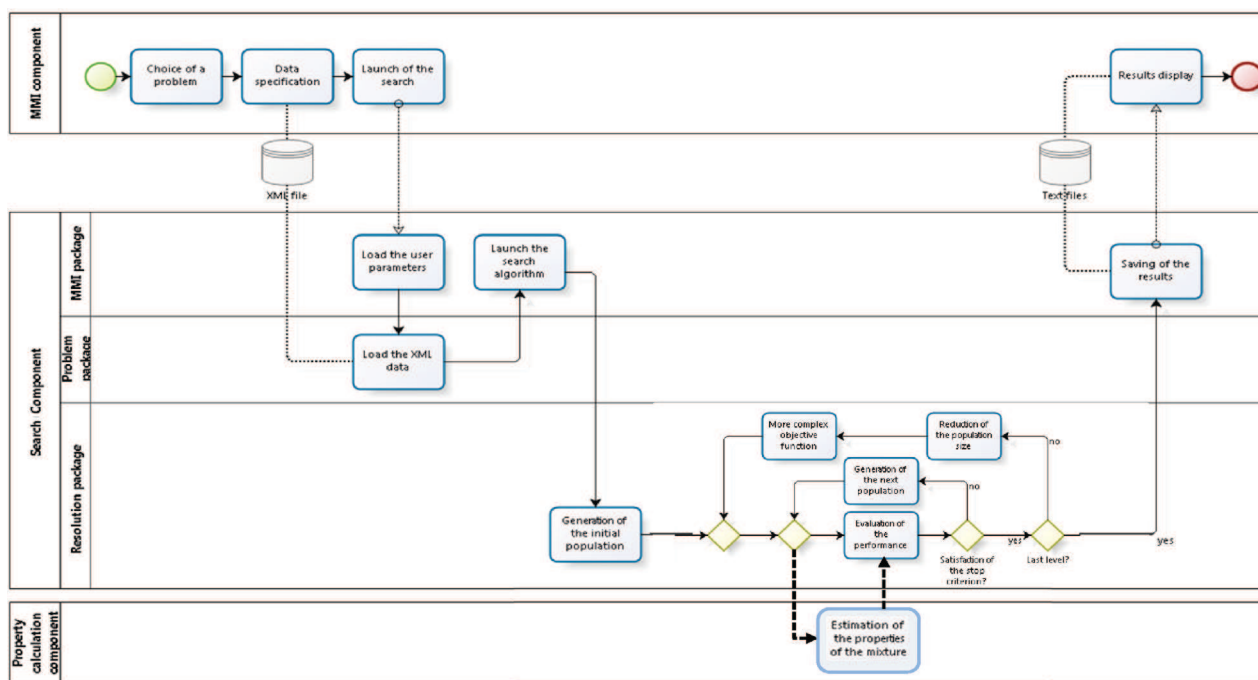

Fig. 7. BPMN diagram of the three IBSS components behavior.

information into the data structure of the resolution package. The resolution package runs the multiobjective genetic algorithm to find candidate mixtures. Three activities are performed, first the initial population is generated, second the performance of each mixture of the population is evaluated, third depending on the search ending criteria, a new population is generated, by using modification operators upon the mixture composition, the mixture operating conditions or the mixture molecules.

The principles of the molecule modification genetic operators are sketched in Fig. 8. Inspired by literature works [79,80], they were improved with branch insertion and substitution, and completed with two routines. One routine is dedicated to maintain the cyclic structures vs. non-cyclic ones as modification may often

break cycle. The other routine is made to account for the possible fragment structure of the molecules [32].

In order to benefit from the use of more accurate but often more computer demanding, property prediction methods, the search can be run over a multi-level sequence (see the activity in Fig. 7 search component). The population size is reduced as the level number increases [18,26,78]. This way, the computational time for solving complex models is not wasted on poor candidates.

4.3.4. Structural view

The structural view presents the modeling abstractions (the classes and the relationships that exist between them). The property related attributes (Fig. 5) and the mixture-molecule

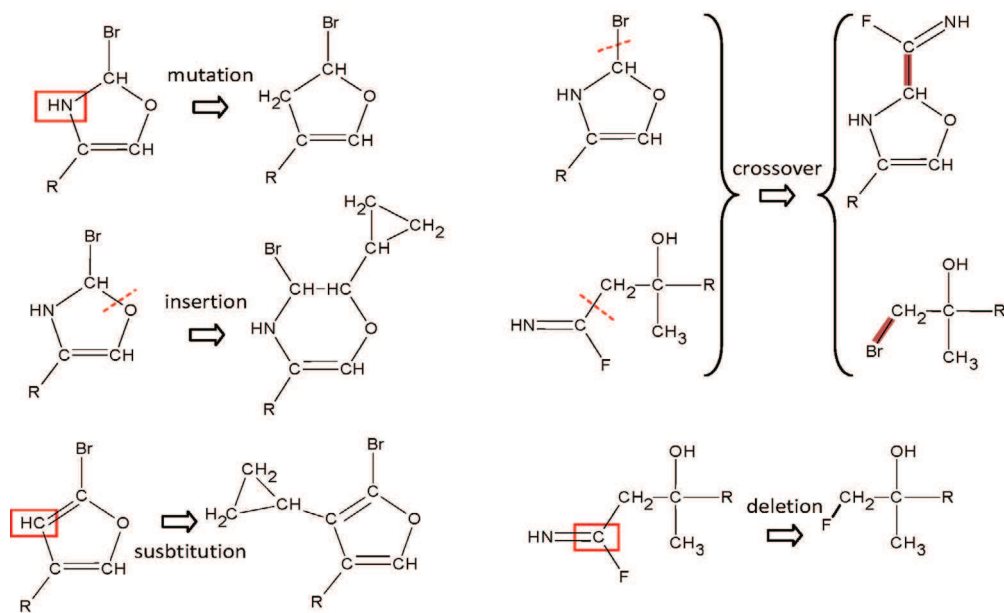

Fig. 8. Molecule modification operators.

granular attributes (Fig. 6) are translated into the class diagram that enabled to structure the application code along with BPMN activity diagrams within the RUP methodology. A full description is available in Heintz [74].

5. Case study: design of a novel ink blanket WASH

An example taken from literature [81] is revisited and used to illustrate our framework.

5.1. Sustainability context and stimulus for blanket wash product design

The removal of ink residue and dried ink from rubber blankets in the US lithographic printing process sector is done with 40 “blanket wash” formulations, 21 of which contain petroleum distillates [81]. In our case, we consider the case of a blanket wash supplier willing to expand its portfolio with greener products. The process stimulus is the following: pushed by regulation evolutions, and wishing to obtain the ISO 14001 standard certification about designing and implementing an effective environmental management system, one of the client requests a greener solvent and claims for a decision have to be made.

A new fact is created in the business rule repository of the enterprise following the SBVR standard where red terms are keyword terms for modality, the underlined terms designate standard and specific objects, and italic terms designate facts and verbs:

-
- StrategicLocalRule1: **A replacement product of product Blanket Wash that is greener than product Blanket Wash must be found.**
 - Fact1: **Customer C1 wants a replacement product that is greener than product Blanket Wash.**

In addition, we list other facts and business rules existing in the enterprise repository:

- Fact2: **Each thing that is wanted by a customer is a customer need of that customer.**
- BusinessRule1: **It is obligatory that each customer need of each customer is satisfied.**
- BusinessRule2: **It is obligatory that each functionality that is performed by a product is performed by each replacement product of that product.**
- BusinessRule3: **It is obligatory that each supplier is located at less than 300 kilometers from the site supplied by this supplier.**
- BusinessRule4: **It is obligatory that each product respects the security rules.**
- BusinessRule5: **It is prohibited that a product prevents a process to function.**

Fact2 describes a customer need. BusinessRule1 shows that the commercial policy of the enterprise is to satisfy the customer needs. BusinessRule2 ensures that substituting products achieve the same key functionality (here cleaning ink). BusinessRule3

-
- StrategicLocalRule4: **The production cost of the replacement product of product Blanket Wash must be at most 10% greater than the production cost of product Blanket Wash.**

translates a specific policy in favor of local suppliers. BusinessRule4 and BusinessRule5 refer to security and performance requirements.

The conjunction of Fact1 and Fact2 violates BusinessRule1. The other BusinessRules are not violated but are cited for consideration since they may become violated by the substitution product.

5.2. Blanket wash intelligence phase

Induced by the business rule violation, the intelligence phase aiming at defining the requirements tree is initiated by the project manager, who takes the role of facilitator. The whole process details are found in Heintz [74] and an overview of the sequential construction of the requirements tree over the four organizational levels is displayed in Figs. 9 and 10. As the ESS BlueKiwi platform supporting this phase is still under development, the procedure is run here with the help of a facilitator person only and the documents keeping all the construction details are produced manually.

At the strategic level, the project manager translates the enterprise business rules 1–5 into strategic local business rule 1, 2, 3, 5 and 6 expressed in SVBR (Fig. 9). Local business rules refer to temporary rules that apply only to the current decision making process. As this is the initial stage of the decision process, all rules are assigned a yellow color, meaning a “consider in priority” interest.

The enterprise BusinessRule1 becomes:

A new StrategicLocalRule4 about production costs objectives is inserted by the manager.

A cost increase may be acceptable by the client at the printing facility since using greener product will help him getting the ISO 14001 certification, which may help finding new clients:

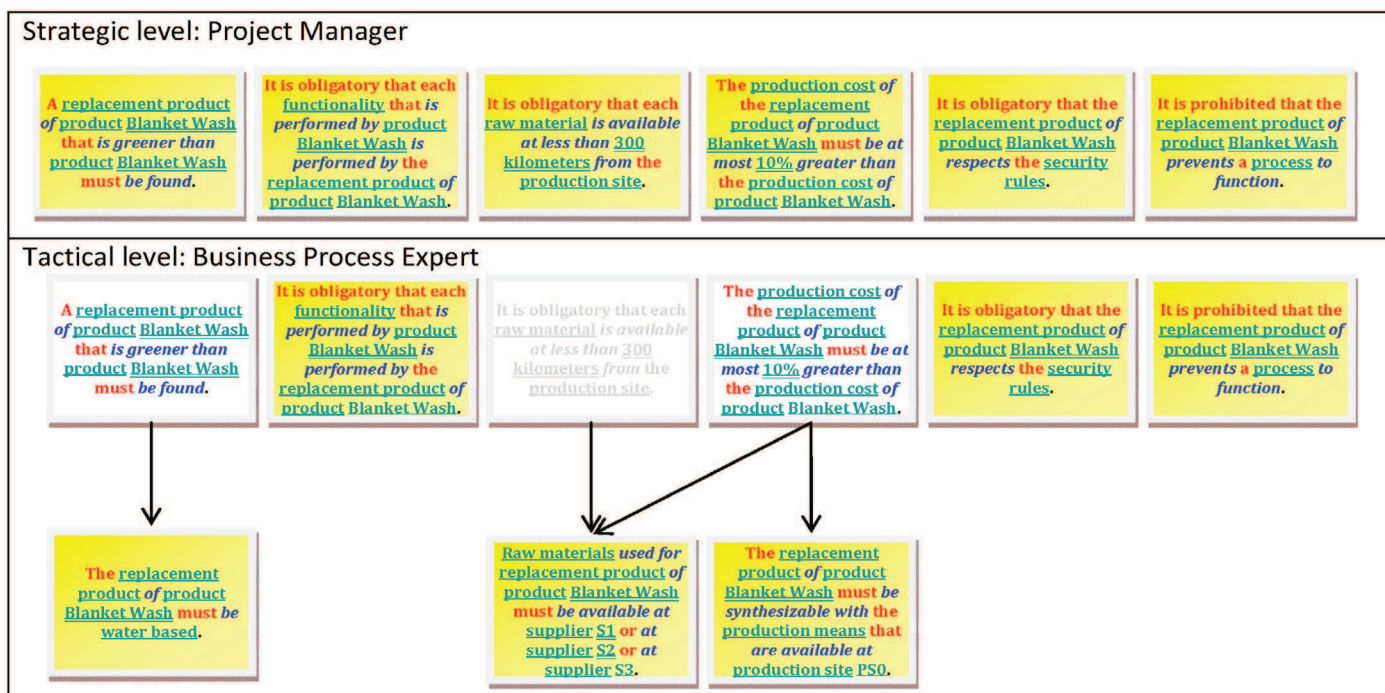

Fig. 9. Strategic and tactical level construction of the requirements tree for ink blanket-wash product.

At the tactical level, the business process expert refines the StrategicLocalRule1 into TacticalLocalRule1 that orients the search toward water-based solvents, which bears some advantages in terms of usability and handling.

by constraints. Product properties are the ability to dissolve the ink, which is evaluated by computing solubility parameters under a so-called RED function; the molecular weight MW and the water solubility $\log(Ws)$. Process-related properties concern the printing

- TacticalLocalRule1: **The replacement product of product Blanket Wash must be water based.**

By taking into considerations supply chain issues, he also refines the StrategicLocalRules3 and 4 in TacticalLocalRule2 defining a supplier list and TacticalLocalRule3 defining the production site. The interest status coloring of each rule is also eventually changed: some strategic level rules are kept in yellow priority interest; new rules arise also in yellow state. StrategicLocalRule3 about supplier range is given the gray color “ignore” status since the new TacticalLocalRule2 fully substitutes it. On the other hand, the StrategicLocalRule4 about a maximum 10% cost increase is kept in the white color “consider as well” status since the new TacticalLocalRule2 and TacticalLocalRule3 do not fully cover its meaning.

At the operational level, all yellow and white status business rules are translated into property target values constraints expressed in OCL (Fig. 10).

The chemical engineering expert is qualified to set property target values. For example, the TacticalLocalRule1 about water-based solvent is refined into an OCL constraint on the water solubility model limit value ($\log(Ws) < 4$) for all compounds of the replacement product:

```
Context PropertyList inv
self.property[logWS].weight=4
self.property[logWS].value<4
self.property[logWS].unit="n/a"
self.property[logWS].parameter.value="n/a"
self.property[logWS].performanceFunction->type()="
Gaussian"
self.property[logWS].performanceFunction.tol=1
self.property[logWS].performanceFunction.val=0.8
```

Using Costa's typology of properties [4] we identify product, process-related and usage-related properties that are concerned

process as the product is in contact with a spinning rubber blanket surface, setting specific values for the viscosity, the surface tension and the density. The other properties are usage-related ones: properties like VOCs are a major concern in printing industry and are evaluated by computing the vapor pressure. EHS properties are evaluated using the Environmental Waste, Environmental Impact, Health, Safety and LCA indices [88]. The flash point is constrained to set flammability limits. Molecular weight is limited to ensure liquid phase of organic molecule.

Comparing both the chemical engineer and the chemist decision refining process, we observe that the supplier related TacticalLocalRule2 is not relevant for the chemical engineer but it is for the chemists for selecting suitable molecule fragment lists. The chemist expert also adds constraints on the mixture. Fig. 10 shows that molecule [1] of the binary mixture is fixed and it the water molecule, whereas molecule [2] is a free molecule to be designed. At first a constraint on mixture composition is suggested (more than 3/10 should be water), but as his gray color status shows, it is ignored during the design phase because of the ability of the CAPD tool to optimize at the same time molecular structures and mixture compositions. Thus, all the property constraints set by the chemical engineer apply to molecule [2]. The molecule [2] structure is constructed from preselected chemical building blocks. Those are decided in accordance with the TacticalLocalRule2 listing the suppliers. In our case, the list of fragments selected is taken from renewable raw materials pools: vegetable oils, glycerol derivative and cellulosic derivative. Then, the list of building blocks is selected among usual chemical functions. It excludes well-known polluting chemical functions: halogens like chloride, fluoride and aromatics like benzene derivative.

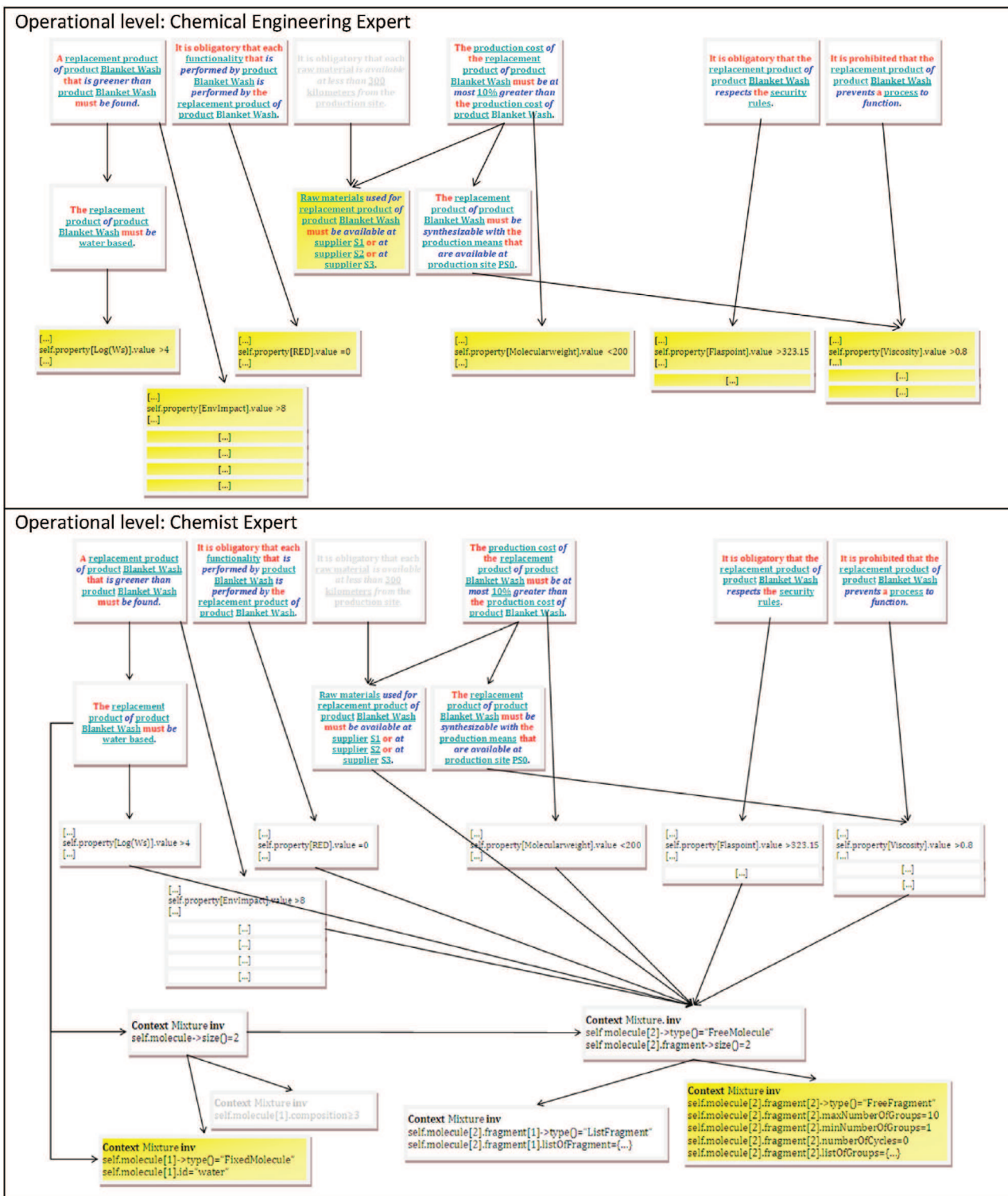

Fig. 10. Operational level construction Illustration of the sequential construction of the requirements tree for ink blanket-wash product.

The whole requirements tree process construction leads to the definition of 28 requirements (Figs. 9 and 10).

5.3. Blanket wash design phase

Extracted from the requirements tree, the 13 property target values have been set and have to be matched by the candidate mixture water-organic solvent. They all correspond to calculable properties with specific property estimation methods. Details about the property estimation model choices are given in Heintz et al. [82].

Tool specific parameters are added by the facilitator based on preliminary tests [74]. The relevant information is written in the XML file by the facilitator logged as expert user. Following the requirements tree, he defines a two component mixture to be searched. Water is imposed as the first component. The second is a solvent which composition is an optimization variable. The organic solvent structure is split into two fragments, one with a core synthon traceable from the biomass renewable material stocks selected in the Intelligence phase and the other built from the chemical blocks selected by the chemist.

Optimal Performance = 0.96;
 MW: 180.203 g/mol;
 FP: 356.45K;
 Pvap@298K: 7.47E-05bar;
 RED: 0.53;
 Env. Waste_index: 8.13;
 Env. Impact_index: 5.48;
 Health_index: 7.74;
 Safety_index: 5.57;
 LCA_index: 4.37;
 Log(Ws): 4.48mg/L;
 Viscosity@300K: 1.41 cp;
 ST@298K: 44.64dyn/cm2;
 Density: 1.03;

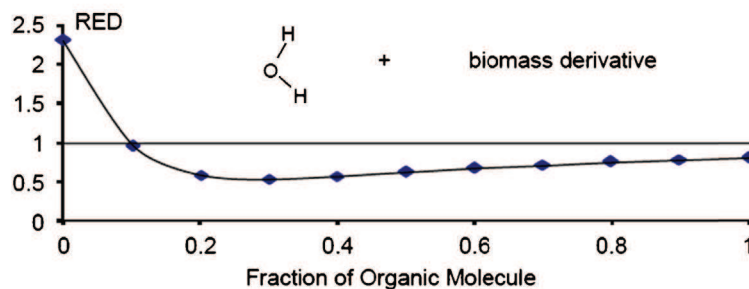

Fig. 11. Performance and property values for the best biomass derivative mixture and influence of its fraction on its ability to dissolve the ink (RED property).

The search is ran over 300 generations and is completed in less than 40 min. The result output file displays a list of a hundred mixtures rated by their performance [82]. Analysis of the results shows that only 13 different molecules are proposed for the organic solvent, all including bio-sourced fragments. Furthermore, the best 18 mixtures are composed of the same water–biomass derivative organic solvent with a variation of the composition. Confidential issues prevent us to display the organic molecule formula. For them, the performance ranges from 0.94 to 0.96 out of 1. A unity performance is a hypothetical goal being achieved for a null value of the RED property, enabling to evaluate the capacity of the mixture to dissolve the ink ($RED < 1$). Fig. 11 displays the property values for the optimal solution and the variation of the RED with the organic solvent composition in the aqueous mixture. It shows that the mixture with a 0.3 fraction of organic molecule shows the best dissolving capacity.

5.4. Blanket wash choice phase

Considering that the 18 top alternatives correspond to the same binary aqueous mixture, the mixture with the highest theoretical performance, at composition $x = 0.3$ is retained for laboratory validation by the experts. They also judge that the number of good alternatives is large enough (45 candidates with a performance higher than 0.9). However, a consensus is reached to carry out a new design phase because the property prediction model for the five index methods used to predict the environmental, environmental waste, health, safety and life cycle impacts are not considered to be accurate enough for the biomass derived solutions. Indeed, a chemical engineering expert recommends finding more accurate and versatile property estimation methods. He suggest to substitute the health index by a method for evaluating the toxicity, the environmental waste index by a method for evaluating the bio-concentration factor, the environmental impact index by a biodegradability factor prediction method together with an increased weighting of the vapor pressure prediction method (vapor pressure is one of the VOC evaluation method), the safety index by a flash point prediction method, and to discard the LCA index. Results obtained with that new set of property estimation methods are not displayed in this contribution.

The second stage of the choice phase consists in determining if, in light of the experimental results from laboratory, the alternative tested is still considered satisfactory, or if another alternative from the set shall be tested. Similarly to the first stage, another possible outcome is to go back to the intelligence and the design phases for obtaining a new set of alternatives.

At the end, the mixture defined by its composition, molecular structures and physical properties, is selected by the enterprise in order to replace the current chemical product. The Implementation phase can start the integration analysis of the new product within the production process.

A posteriori, we can assess the sustainability degree of the solution over six dimensions as suggested by Gagnon et al. [43], with sustainability shade ranging from A (minimal) to D (state of the art). The ‘design process’ dimension consists in counting how many tasks were covered among the 22 tasks listed by Gagnon in his integrated sustainable design process. With 13 tasks, including all tasks listed as critical by Gagnon (see the state of the art section), the ‘design-process’ dimension is graded “B-shade”. The ‘sustainability issue covered’ dimension is graded “B-shade” as issues covering partially all three sustainability pillars are considered. The ‘indicator relevance’ dimension should get an excellent “D-shade” grade since a systematic search of bio-sourced solvent is run. But it is degraded to a poor grade ‘A-shade’ since the initial EHS index models were found unsuitable. The ‘analysis tool accuracy’ dimension is graded a fair ‘C-shade’ because most property estimation models but the EHS index methods are state of the art models. The ‘alternative performance’ dimension is graded ‘C+-shade’ because a novel aqueous – bio-based solvent mixture has been found, dramatically reducing the environmental impact. The ‘decision-making’ dimension is graded ‘C-shade’ because all sustainability pillars are addressed and so in a balanced manner. Overall with one A, two Bs and three Cs shades, the experts estimate that the product development process is reasonably sustainable but can be improved. Thus the decision is taken to run again the CAPD tool by selecting new property estimation methods for the EHS impacts assessment as the ‘indicator relevance’ dimension is responsible for the current worst shade “A”.

6. Conclusion

We have formalized a three phase decision making process framework dedicated to sustainable chemical product design in an industrial context where chemical related industries need to comply with new regulations, like REACH or seek to expand their portfolio of product with a low environmental impact. Based on our proposal of chemical enterprise model, we have supported the decision process with information and communication technologies, distributed solutions and standard modeling and computing languages. We have been careful to vertical alignment by defining parallel and hierarchical layers of the decision levels, of the enterprise organization, of the requirements models and of the system itself, the product. We have taken care of horizontal alignment by using consistent semantics for describing the requirements and a consistent framework for describing molecules and properties in the CAPD tool. Together with the documentation gathered through the whole process, our proposal improves the sharing of information and knowledge and enables collaborative work across the chemical enterprise actors at the strategic, tactical and operational levels of decision. Overall we have achieved a “functional distributed” solution, the medium level in interoperability according to the LISI method.

During the intelligence phase, a model driven simplified multi-scale multi-layer approach involves four stakeholders across the enterprise spanning the strategic, tactical and operational decision levels. A simplified model of requirements is proposed. Upper enterprise layer requirements at the strategic and tactical levels are expressed thanks to local rules, inspired by business rules and using SBVR Structured English. The lower layer requirements at the operational level are expressed as constraints written with OCL. With the help of a facilitator, a systemic hierarchical analysis of the needs and usages enables the stakeholders to build a tree of requirements for the design phase. Product requirements are refined from the general enterprise rules level toward the technical constraints level, while the whole process steps is documented in parallel and available to all people involved.

For the design phase, the tree of requirement is compiled and eventually completed by the facilitator to generate the inputs of a computer aided product design CAPD tool. Our innovative CAPD tool is built with sufficient flexibility to cope with sustainability context specific features. It enables to find mixtures as solutions and to source candidate molecules from renewable raw materials. It also handles a multi-criterion search able to handle multiple properties that cover the three pillars of sustainability, society, environment and economy along with functional properties. The CAPD tool implements a genetic algorithm and uses molecular graphs. Aspects of the functional, architectural, behavioral and structural system views have been presented through class diagrams and activity diagrams.

The choice phase is divided in two stages. It uses the DELPHI method where the experts first choose the most promising alternative for laboratory testing. Then, once the experimental values are available, the experts validate or invalidate the alternative for implementation. Finally, they discuss the solution relevancy and provide feedback, before launching the “greener” product manufacturing.

The original framework is illustrated by the search of a bio-sourced aqueous-solvent mixture formulation for lithographic blanket wash for which the intelligence, the design and the choice phase are described. Finally, the sustainability of the solution is assessed by using Gagnon’s sustainability shades method.

Acknowledgement

This scientific work was supported by the French national research agency (InBioSynSolv ANR-CP2D-2009-08) in partnership with Solvay-Rhodia Company.

References

- [1] REACH, 2008. Documentation available at EC web site: http://ec.europa.eu/enterprise/sectors/chemicals/reach/index_en.htm.
- [2] VOC, VOC Solvents Emissions Directive (Directive 1999/13/EC) amended through article 13 of the Paints Directive (Directive 2004/42/EC), 2004.
- [3] M. Nieddu, E. Garnier, C. Bliard, The emergence of doubly green chemistry, a narrative approach, *European Review of Industrial Economics and Policy* (2012/1) (2012).
- [4] R. Costa, G.D. Moggridge, P.M. Saraiva, Chemical product engineering: an emerging paradigm within chemical engineering, *AIChE Journal* 52 (2006) 1976–1986.
- [5] M. Hill, Chemical product engineering—the third paradigm, *Computers & Chemical Engineering* 33 (2009) 947–953.
- [6] G. Hall, J. Howe, Sustainability of the chemical engineering manufacturing industry-towards a new paradigm? *Education for Chemical Engineers* 5 (2010) e100–e107.
- [7] L. Patil, L. Srinivas, K. Murthy, D. Dutta, R. Sudarsan, Toward an integrated decision support framework for sustainability analysis, NIST IR (2013), <http://dx.doi.org/10.6028/NIST.IR.7909>.
- [8] P.T. Anastas, J. Warner, *Green Chemistry Theory and Practice*, Oxford University Press, Oxford, 1998p, 135.
- [9] P.T. Anastas, J.B. Zimmerman, Design through the 12 principles of green engineering, *Environmental Science Technology* (2003) 94–101.
- [10] A. Azapagic, S. Perdan, An integrated sustainability decision-support framework. Part I. Problem structuring, *International Journal of Sustainable Development & World Ecology* 12 (2005) 98–111.
- [11] A. Azapagic, A. Millington, A. Collett, A methodology for integrating sustainability considerations into process design, *Chemical Engineering Research and Design* 84 (2006) 439–452.
- [12] H.F. Hung, H.P. Kao, Y.S. Juang, An integrated information system for product design planning, *Expert Systems with Applications* 35 (1–2) (2008) 338–349.
- [13] B. Smith, M.G. Ierapepritou, Framework for consumer-integrated optimal product design, *Industrial and Engineering Chemistry Research* 48 (18) (2009) 8566–8574.
- [14] B.V. Smith, M.G. Ierapepritou, Integrative chemical product design strategies: reflecting industry trends and challenges, *Computers & Chemical Engineering* 34 (2010) 857–865.
- [15] W.D. Seider, W. Soemantri, J.D. Seader, D.R. Lewin, Perspectives on chemical product and process design, *Computers & Chemical Engine* 33 (2009) 930–935.
- [16] M. Hill, Product and process design for structured products, *AIChE Journal* 50 (8) (2004) 1656–1661.
- [17] R. Gani, E.A. Brignole, Molecular design of solvents for liquid extraction based on UNIFAC, *Fluid Phase Equilibria* 13 (1983) 331–340.
- [18] P.M. Harper, R. Gani, P. Kolar, T. Ishikawa, Computer-aided molecular design with combined molecular modeling and group contribution, *Fluid Phase Equilibria* (1999) 158–160, 337–347.
- [19] L.E.K. Achenie, R. Gani, V. Venkatasubramanian, *Computer Aided Molecular Design: Theory and Practice*, Elsevier, Amsterdam, Netherlands, 2003.
- [20] K.G. Joback, R.C. Reid, Estimation of pure-component properties from group contributions, *Chemical Engineering Communications* 57 (1987) 233–243.
- [21] L. Constantinou, R. Gani, New group contribution method for estimating properties of pure compounds, *AIChE Journal* 40 (1994) 1697–1710.
- [22] J. Marrero, R. Gani, Group-contribution based estimation of pure component properties, *Fluid Phase Equilibria* (2001) 183–184, 183–208.
- [23] A.S. Hukkerikar, B. Sarup, A.T. Kate, J. Abildskov, G. Sin, R. Gani, Group-contribution+ (GC+) based estimation of properties of pure components: improved property estimation and uncertainty analysis, *Fluid Phase Equilibria* 321 (2012) 25–43.
- [24] M. Karelson, V.S. Lobanov, A.R. Katrinsky, Quantum-chemical descriptors in QSAR/QSPR studies, *Chemical Reviews* 96 (1996) 1027–1043.
- [25] S.A. Gallenos, Mini-review on chemical similarity and prediction of toxicity, *Current Computer-Aided Drug Design* 2 (2006) 105–122.
- [26] M. Korichi, V. Gerbaud, P. Floquet, A.-H. Meniai, S. Nacef, X. Joulia, Computer aided aroma design. II. Quantitative structure-odour relationship, *Chemical Engineering and Processing: Process Intensification* 47 (2008) 1912–1925.
- [27] R. Gani, Chemical product design: challenges and opportunities, *Computers and Chemical Engineering* 28 (2004) 2441–2457.
- [28] E. Conte, R. Gani, K.M. Ng, Design of formulated products: a systematic methodology, *AIChE Journal* 57 (2011) 2431–2449.
- [29] A.I. Papadopoulos, M. Stijepovic, P. Linke, P. Seferlis, S. Voutetakis, Molecular design of working fluid mixtures for organic rankine cycles, *Computer Aided Chemical Engineering* 32 (2013) 289–294.
- [30] M. Mattei, M. Hill, G.M. Kontogeorgis, R. Gani, Design of an emulsion-based personal detergent through a model-based chemical product design methodology, *Computer Aided Chemical Engineering* 32 (2013) 817–822.
- [31] A.T. Karunanithi, L.E.K. Achenie, R. Gani, A new decomposition-based computer-aided molecular/mixture design methodology for the design of optimal solvents and solvent mixtures, *Industrial Engineering Chemical Research* 44 (2005) 4785–4797.
- [32] J. Heintz, V. Gerbaud, J.-P. Belaud, Models driven conception of an Computer Aided Mixture Design tool, in: 21st European Symposium on Computer Aided Process Engineering, Elsevier, 2011, pp. 1608–1612.
- [33] IEEE, Standard Glossary of Software Engineering Terminology, *IEEE Std 610*, 12-1990, 1990.
- [34] K.E. Wiegers, *Software Requirements*, O’Reilly Media, Inc., 2009.
- [35] R.G. Ross, *Principles of the Business Rule Approach*, 1st ed., Addison Wesley, Boston, USA, 2003.
- [36] OMG, *Semantics of Business Vocabulary and Business Rules (SBVR)*, v1.0, OMG, Needham, MA, 2008, Available at: <http://www.omg.org/spec/SBVR/1.0/PDF/WWW Document>.
- [37] OMG, *Object Constraint Language OMG Available Specification Version 2.0*, OMG, Needham, MA, 2006, Available at: <http://www.omg.org/spec/OCL/2.3.1/PDF/WWW Document>.
- [38] K.U. Klatt, W. Marquardt, Perspectives for process system engineering. Personal views from academia and industry, *Computer & Chemical Engineering* 33 (2009) 536–550.
- [39] K.M. Ng, R. Gani, K. Dam-Johansen, *Chemical Product Design*, Elsevier, Amsterdam, Netherlands, 2007.
- [40] W. Marquardt, M. Nagl, Workflow and information centered support of design processes. The IMPROVE perspective, *Computer & Chemical Engineering* 29 (2004) 65–82.
- [41] V.A. Varma, G.V. Reklaitis, G.E. Blau, J.F. Pekny, Enterprise-wide modeling & optimization—an overview of emerging research challenges and opportunities, *Computer & Chemical Engineering* 31 (2007) 692–711.
- [42] B.V. Smith, M.G. Ierapepritou, Modeling and optimization of product design and portfolio management interface, *Computers & Chemical Engine* 35 (2011) 2579–2589.

- [43] B. Gagnon, R. Leduc, L. Savard, From a conventional to a sustainable engineering design process: different shades of sustainability, *Journal of Engineering Design* 23 (2012) 49–74.
- [44] H.A. Simon, *The New Science of Management Decision: The Ford Distinguished Lectures*, Harper and Row, New York and Evanston, 1960.
- [45] N. Ashrafi, A decision making framework for software total quality management, *International Journal of Technology Management* 16 (1998) 532–543.
- [46] J. Renaud, A. Lefebvre, C. Fonteix, Improvement of the design process through knowledge capitalization: an approach by know-how mapping, *Concurrent Engineering Research and Applications* 12 (2004) 25–37.
- [47] R.N. Anthony, *Planning and Control Systems A Framework for Analysis*, Studies in Management Control, Division of Research Graduate School of Business Administration, Harvard University, Boston, 1965.
- [48] N. Dalkey, O. Helmer, An experimental application of the Delphi method to the use of experts, *Management Science* 9 (1963) 458–467.
- [49] H.A. Linstone, M. Turoff, *The Delphi Method: Techniques and Applications*, Addison-Wesley Pub. Co., Advanced Book Program, 1975.
- [50] B. Roy, Classement et choix en présence de points de vue multiples, *Revue française d'automatique, d'informatique et de recherche opérationnelle* 2 (1968) 57–75.
- [51] T. Briggs, P.L. Kunsch, B. Mareschal, Nuclear waste management: an application of the multicriteria PROMETHEE methods, *European Journal of Operational Research* 44 (1990) 1–10.
- [52] R.L. Keeney, H. Raiffa, *Decisions with Multiple Objectives: Preferences and Value Trade-Offs*, Cambridge University Press, Cambridge, UK, 1993.
- [53] T.L. Saaty, L. Vargas, *Fundamentals of Decision Making and Priority Theory With the Analytic Hierarchy Process*, Rws Pubs, Pittsburgh, USA, 1994.
- [54] T.L. Saaty, *The Analytic Network Process: Decision Making With Dependence and Feedback*, 2nd ed., Rws Pubs, Pittsburgh, USA, 2001.
- [55] K.M. Ng, MOPSD: a framework linking business decision making to product and process design, *Computers & Chemical Engineering* 29 (2004) 51–56.
- [56] A. Azapagic, S. Perdan, An integrated sustainability decision-support framework. Part II: Problem analysis, *International Journal of Sustainable Development & World Ecology* 12 (2005) 112–131.
- [57] T.R. Browning, Applying the design structure matrix to system decomposition and integration problems: a review and new directions, *IEEE Transaction on Engineering Management* 40 (3) (2001) 292–306.
- [58] L. Chan, M. Wu, Quality function deployment: a literature review, *European Journal of Operational Research* 143 (2002) 463–497.
- [59] R. Dekkers, C.M. Chang, J. Kreutzfeldt, The interface between “product design and engineering” and manufacturing: a review of the literature and empirical evidence, *International Journal of Production Economics* 144 (2013) 316–333.
- [60] F.B. Vernadat, Enterprise modeling and integration (EMI): current status and research perspectives, *Annual Reviews in Control* 26 (2002) 15–25.
- [61] ISO/DIS 19440.2, *Enterprise Integration—Constructs for Enterprise Modeling*, ISO, Geneva, 2005.
- [62] IEEE, Recommended practice for architectural description of software-intensive systems, in: IEEE-std-1471-2000, 2000.
- [63] L.S. Lê, A. Wegmann, Hierarchy-oriented modeling of enterprise architecture using reference-model of open distributed processing, *Computer Standards & Interfaces* 35 (2013) 277–293.
- [64] H. Panetto, A. Molina, Enterprise integration and interoperability in manufacturing systems: trends and issues, *Computers in Industry* 59 (2008) 641–646.
- [65] J.M. Perez, F. Ruiz, M. Piattini, MDE for BPM: a systematic review, in: J. Filipe, B. Shishkov, M. Helfert (Eds.), *Software and Data Technologies, Communications in Computer and Information Science*, Springer, Berlin/Heidelberg, 2008, pp. 127–135.
- [66] S.A. White, Introduction to BPMN, 2004 URL: http://www.omg.org/bpmn/Documents/Introduction_to_BPMN.pdf (WWW Document).
- [67] OMG, *Business Process Modeling Notation (BPMN)*, OMG, Needham, MA, 2007, Available at: www.bpmn.org/ (WWW Document).
- [68] OMG, *OMG Unified Modeling Language Specification, Version 2.0*, OMG, Needham, MA, 2005, Available at: <http://www.omg.org/spec/UML/2.0> (WWW Document).
- [69] J. Heintz, V. Gerbaud, J.-P. Belaud, Operational and strategic alignment in the decision process of molecule substitution, *Computer Aided Chemical Engineering* 30 (2012) 382–386.
- [70] T. O'Reilly, *What is Web 2.0: design patterns and business models for the next generation of software*, *Communications & Strategies* 1 (2007) 17.
- [71] J.G. Breslin, D. O'Sullivan, A. Passant, L. Vasiliu, Semantic web computing in industry, *Computers in Industry* 61 (2010) 729–741.
- [72] V. Robin, B. Rose, P. Girard, Modelling collaborative knowledge to support engineering design project manager, *Computers in Industry* 58 (2007) 188–198.
- [73] M. Tavana, M. Pirdashti, D.T. Kennedy, J.-P. Belaud, M. Behzadian, A hybrid Delphi-SWOT paradigm for oil and gas pipeline strategic planning in Caspian Sea basin, *Energy Policy* 40 (2012) 345–360.
- [74] J. Heintz, Systemic approach and decision process for sustainability in chemical engineering: application to computer aided product design, (Ph.D. thesis), Université de Toulouse, 2012 Available at <http://ethesis.inp-toulouse.fr/archive/00002022/>.
- [75] R.A. Howard, Decision analysis: applied decision theory, in: *Proceedings of the 4th International Conference on Operational Research*, 1966, pp. 55–77.
- [76] P. Kroll, P. Kruchten, *The Rational Unified Process Made Easy: A Practitioner's Guide to the RUP*, 1st ed., Addison Wesley, Boston, USA, 2003.
- [77] J.E. Ourique, A. Silva Telles, Computer-aided molecular design with simulated annealing and molecular graphs, *Computers & Chemical Engineering* 22 (1998) S615–S618.
- [78] M. Korichi, V. Gerbaud, P. Floquet, A.-H. Meniai, S. Nacef, X. Joulia, Computer aided aroma design. I. Molecular knowledge framework, *Chemical Engineering and Processing: Process Intensification* 47 (2008) 1902–1911.
- [79] B. Van Dyk, I. Nieuwoudt, Design of solvents for extractive distillation, *Industrial Engineering Chemical Research* 39 (2000) 1423–1429.
- [80] P.R. Patkar, V. Venkatasubramanian, Chapter 5: genetic algorithms based CAMD, in: *Computer Aided Molecular Design: Theory and Practice*, Elsevier, Amsterdam, Netherlands, 2002, pp. 95–128.
- [81] M. Sinha, L.E.K. Achenie, Chapter 11: CAMD in solvent mixture design, in: *Computer Aided Molecular Design: Theory and Practice*, Elsevier, Amsterdam, Netherlands, 2002, pp. 261–287.
- [82] J. Heintz, I. Touche, M.T. dos Santos, V. Gerbaud, An integrated framework for product formulation by computer aided mixture design, *Computer Aided Chemical Engineering* 30 (2012) 702–706.
- [83] H.I. Ansoff, *Corporate Strategy: An Analytic Approach to Business Policy for Growth and Expansion*, McGraw-Hill, New York, 1965.
- [86] J.C. Henderson, N. Venkatraman, Strategic alignment: leveraging information technology for transforming organizations, *IBM Systems Journal* 38 (2) (1999) 472–484.
- [87] BRG, *Defining Business Rules - What Are They Really?* 2000 URL: http://www.businessrulesgroup.org/first_paper/BRG-whatBR_3ed.pdf (WWW Document).
- [88] D.C. Weis, D.P. Visco, Computer-aided molecular design using the Signature molecular descriptor: Application to solvent selection, *Comput Chem Engng* 34 (2010) 1018–1029.



Juliette Heintz completed her PhD degree in system engineering at the Laboratoire de Génie Chimique (Chemical Engineering Laboratory) in 2012. She works currently as a software and process engineer at the Process Modelling, Simulation and Optimization software editor, ProSim.



Jean Pierre Belaud is an associate-professor at the Toulouse University in the Process and System Engineering department of Laboratoire de Génie Chimique (LGC CNRS UMR 5503). BSc in chemical process engineering (1995) BSc computing sciences (1996), PhD Process and System Engineering (2002), his core skills are enterprise modeling and system engineering using collaborative ITS. He has been strongly involved in the design of the well-established CAPE-OPEN standard for components interoperability of process simulation. He is working on concepts, methods and software tools for eco-design and sustainability of industrial processes and systems (from agro-industry and chemical related processes). Within this scientific frame, he has varied research interest in process system engineering and industrial engineering which include: computer-aided system engineering, sustainability, life cycle assessment, eco-design, process system engineering, simulation, enterprise modeling, collaborative decision making and open innovation 2.0. He is identified as an expert of French National Research agency and he is head of third year of INP-ENSIACET engineer school for students in industrial engineering.



Vincent Gerbaud is a research director at the Toulouse University in the Process and System Engineering department of Laboratoire de Génie Chimique (LGC CNRS UMR 5503). BSc (1991), MSc (1992) and PhD (1996) in chemical engineering, he conducts research activities in process system engineering, with a strong interest in small scale understanding, modelling and simulation; quantum chemistry, molecular simulation, thermodynamics, computer aided molecular and mixture design. Product applications studied over the years have covers a wide range of domains: SLE, VLE, VLE phase equilibria of vegetable oil blends, crystal solubilities, non ideal organic mixtures, flammable mixtures or high concentration electrolyte solutions; system thermodynamics for solid aggregates, crystals or solvent mixtures. At the process scale, he deals with the design and synthesis of distillation processes, typically azeotropic and extractive distillation. Over the years, he has supervised the development of several softwares, incl. one for simulating the precipitation of tartaric salts in wine and its implication on the wine acidity and one for finding suitable batch distillation processes. He has published over 60 articles and several books chapters.