



HAL
open science

people and technology

Pierre Rabardel

► **To cite this version:**

| Pierre Rabardel. people and technology. université paris 8, pp.188, 2002. <hal-01020705>

HAL Id: hal-01020705

<https://hal.science/hal-01020705v1>

Submitted on 8 Jul 2014

HAL is a multi-disciplinary open access archive for the deposit and dissemination of scientific research documents, whether they are published or not. The documents may come from teaching and research institutions in France or abroad, or from public or private research centers.

L'archive ouverte pluridisciplinaire **HAL**, est destinée au dépôt et à la diffusion de documents scientifiques de niveau recherche, publiés ou non, émanant des établissements d'enseignement et de recherche français ou étrangers, des laboratoires publics ou privés.



HAL Authorization

PEOPLE AND TECHNOLOGY

a cognitive approach to contemporary instruments

LES HOMMES ET LES TECHNOLOGIES

une approche cognitive des instruments contemporains

Pierre Rabardel

Translated by Heidi Wood

PART ONE: ACTIVITIES WITH INSTRUMENTS, POSITION IN THE SOCIAL FIELD AND SCIENTIFIC APPROACHES.....	1
----------------------------------------------------------------------------------------------------	---

CHAPTER 1: FOR A HUMAN-CENTERED APPROACH TO TECHNIQUES	2
---------------------------------------------------------------------	----------

Technocentric points of view on human activity at work.....	2
-------------------------------------------------------------	---

Criticisms of technocentric approaches.....	5
---------------------------------------------	---

Towards a human-centered design of techniques.....	8
----------------------------------------------------	---

Advantages and limitations of non-psychological approaches to techniques and artifacts	15
----------------------------------------------------------------------------------------------	----

CHAPTER 2: PSYCHOLOGICAL APPROCHES TO TECHNIQUES AND ARTEFACTS	18
-----------------------------------------------------------------------------	-----------

Vygotsky, a founding vision still alive today: the instrument at the heart of the development and functioning of the psyche.....	18
----------------------------------------------------------------------------------------------------------------------------------	----

Techniques constitute the human environment and are the means of transmitting the species' cultural capital	19
-------------------------------------------------------------------------------------------------------------------	----

Human and animal techniques: breaks and continuations	21
-------------------------------------------------------------	----

Is practical intelligence an inferior form of intelligence?	23
-------------------------------------------------------------------	----

From the epistemic subject to the psychological subject: genetic psychology's move toward acknowledging techniques.....	25
-------------------------------------------------------------------------------------------------------------------------	----

From information processing to situated cognition. Which status for techniques?	26
---------------------------------------------------------------------------------------	----

The evolution of ideas in work psychology and ergonomics.....	28
---------------------------------------------------------------	----

The necessity of reconstructing psychology to allow a real contribution to the design of technical systems.....	30
-----------------------------------------------------------------------------------------------------------------	----

The relation to artifacts and techniques: a central issue for psychology	31
--------------------------------------------------------------------------------	----

Future directions for the definition and analysis of activities with instruments.....	34
---------------------------------------------------------------------------------------	----

PART TWO: THE NOTION OF THE INSTRUMENT	36
----------------------------------------------	----

CHAPTER 3: INTRODUCTION TO THE NOTION OF THE INSTRUMENT	37
----------------------------------------------------------------------	-----------

Technical object, fabricated material object, artifact.....	37
Machines and instruments: a question of viewpoints	40
CHAPTER 4: THE TRIAD NATURE OF ACTIVITY WITH INSTRUMENT SITUATIONS.....	42
A techno-centered approach	44
The collective's anthropocentric approach	47
Psychological approaches focused on the subject.....	48
Discussion on the appearance of a forth pole	50
CHAPTER 5: POINTS OF VIEW AND HYPOTHESES ON INSTRUMENTS.....	53
Technological Approaches	54
A biological metaphor	54
The animal's instrument as an intermediary world	54
The social instrument, capitalizing on experience	55
From the material instrument to the psychological instrument	57
The instrument as indicator of child development	57
The semiotic instrument	59
Tools and cognitive instruments	60
Summary: the instrument as mediator, knowledge, operant and means of action.....	62
CHAPTER 6: THE INSTRUMENT AS A MIXED ENTITY.....	64
From artifact to usage: utilization schemes	65
Scheme, schema... a nomadic concept	67
Piaget's notion of the scheme	70
Cellérier's theoretical elaborations	72
Evolutions of the notion of scheme linked to the functional analysis of the psychological subject's activity	74
A development of the scheme concept in acknowledging specificity of content.....	78

Work schemes: an example:.....	80
Utilization schemes.....	81
A psychological definition of the notion of instrument.....	86
PART THREE: ELABORATION AND GENESIS OF THE INSTRUMENT BY THE SUBJECT	91
CHAPTER 7: WHEN SUBJECTS DEVELOP THEIR INSTRUMENTS - INSTRUMENTAL GENESES	92
The notion of catachresis	92
Interpreting the difference between intended usage and real usage of artifacts.....	93
The results of studies on catachreses and attributions of function.....	93
Limitations of interpreting in terms of misappropriation - towards an interpretation in terms of elaboration and instrumental genesis	100
CHAPTER 8: INSTRUMENTAL GENESIS, A PROCESS THAT CONCERNS BOTH ARTIFACT AND SUBJECT	101
Instrumental geneses exist even in highly restricted activities	102
Instrumentation and instrumentalization: an introduction	103
An example of instrumental genesis directed toward the artifact	104
An example of instrumental genesis directed toward the subject.....	105
Defining the instrumentalization process.....	106
Defining the instrumentation process	108
CHAPTER 9: MENTAL REPRESENTATIONS AND MODELS OF INSTRUMENTS.....	110
Representations for action	110
Representations are adapted to tasks.....	111
Construction and contents of representations.....	114
Some characteristics of representations for action in activity with instrument situations	118

CHAPTER 10: ARTICULATIONS BETWEEN DESIGN PROCESSES AND INSTRUMENTAL GENESES	122
Toward a development of instrumental geneses with contemporary technologies?	122
New possibilities not inscribed in artifacts by designers	122
Rethinking the nature of design processes	123
PART FOUR: ACTING WITH INSTRUMENTS.....	127
CHAPTER 11: EFFECTS OF THE UTILIZATION OF INSTRUMENTS ON THE SUBJECT'S ACTIVITY - REQUIREMENTS AND POSSIBILITIES.....	128
Structuring effects of artifacts on activity	128
Limitations of the structuring effects of artifacts on activity: analysis levels and focuses.....	131
Expanding the range of possibilities	132
Required activity and types of constraints	133
Structuring modalities for multiple activities.....	135
Activity is only relatively required	136
CHAPTER 12: THE PROBLEM OF THE TRANSPARENCY OF ARTIFACTS.....	139
Transparency to understand and transparency to act	139
Two metaphors: "black box" and "glass box"	140
Towards a conceptualization in terms of operative transparency	144
Approach to operative transparency in reference to the situation.....	145
Approach to operative transparency in reference to action	146
Operative transparency is inscribed in time.....	147
Operative transparency responds to differentiated criteria depending on objectives	147
PART FIVE: APPLICATIONS	149
ANALYZING	150

Analyzing the properties of objects truly taken into consideration in activity	150
Analyzing with the aid of the instrument-mediated action situations model	151
DESIGNING	153
Design that tackles problems encountered in usage	153
Design focused on users' schemes and representations	154
Designing based on users' real instruments.....	156
Elaborating and evaluating a design project based on the instrument-mediated activity situations model.....	156
TRAINING	158
Designing actions, programs and training in an instrumental perspective	158
Constructing situations that favor the formation of knowledge and the development of competencies in training and the workplace	160
REFERENCES	163

**PART ONE: ACTIVITIES WITH INSTRUMENTS,
POSITION IN THE SOCIAL FIELD AND
SCIENTIFIC APPROACHES**

The aim of this chapter is to situate the instrumental approach in terms of the **social fields** concerned (work, education, daily life), and the questions thrown up by the **scientific fields** of psychology, didactics and ergonomics.

The problems faced in the **social fields**, the debates they generate and the contradictions and issues that they touch on, are so vast that an all-encompassing and objective approach appears extremely difficult. However, we will demonstrate that some options, particularly those postulating an underlying elimination of “human components” in production systems, cannot be a pertinent frame for analyzing activities with instruments given that their defining feature is precisely the presence of humans and their activities. An instrumental problematic is necessarily centered on humans and grounded in an anthropocentric option. In removing people from activity, in our opinion, psychology, ergonomics and didactics lose their *raison d'être*.

The positioning in **scientific fields** does not aim to be exhaustive either. It seeks to identify the main approaches to activity with instruments in the psychological field and in fields of action to which it contributes, particularly ergonomics and didactics.

At first, we will define approaches to human activity based on a technocentric view that tends to attribute a residual place to this activity. Points of view criticizing technocentric approaches will then be analyzed, followed by arguments in favor of an anthropocentric perspective on anthropotechnical objects and systems. This latter perspective will serve as a guide to situate different non-psychological approaches to artifacts and techniques. Psychological approaches will then be examined in detail.

CHAPTER 1: FOR A HUMAN-CENTERED APPROACH TO TECHNIQUES

Technocentric points of view on human activity at work

There is a joke that pilots tell each other with half smiles: “in airplanes of the future, there will only be two seats in the cockpit - one for a person and the other for a dog. The dog will be there to stop the pilot touching the controls and the person will be there to feed the dog.”

What lies behind this “joke”?

Activity as a residue

Limiting human intervention, considered inefficient and unreliable, too expensive or too risky, is one of the current trends in the productive system. In this perspective, reducing the place of people, the tasks they perform and the actions they accomplish is an objective. Yet even the ideology that vehicles the complacent image of the operator-free factory does not hide the fact that

today, it is impossible in practice to master everything or have everything done by machines¹. Even in this perspective, there is a place for humans. In airplanes of the future, for example, the pilot (who may or may not still be called a pilot) could be present merely in case of unexpected problems that cause the automated systems to break down. He/she would recover breakdowns and incidents, or perform limited operations for which he/she would remain temporarily more proficient.

The place that this perspective accords people is residual: humans occupy an ever-shrinking place, performing tasks that have not yet been yet resolved technically in terms of reliability, safety, efficiency, performance, usefulness, optimality and automation. As Clot (1992) indicates, "the path that consists in reorganizing tasks with the objective of having the results no longer dependant on the operator - this path that is often taken and that the contemporary strength of machinery allows us to imagine more and more as a desirable option - consists in seeing human activity as a residue." Bainbridge (1982) reminds us that it only leaves operators tasks that are too complex or impossible to automate.

Nonetheless, the "residual" perspective is only one of the possible options and must be situated historically. For Millot (1991), automation initially aimed to give system procedures commands to make their operation fully autonomous. Operators were retained in order to carry out decision-making supervisory tasks that were not yet automatable. This analysis is in line with that put forward by authors like Brodner (1987) or Craven and Slatter (1988): "designers predominantly adopted a technocentric approach in the design of man-machine systems, concentrating their efforts on the efficiency of fixed capital and tending to ignore human factors."

However, according to Millot, the initial concept of automation excluding operators then evolved toward a concept aiming to reintroduce them into the automated system, but in considering them as a "necessary evil" whose errors have to be limited. Millot claims that today it would be possible to move beyond this stage with decision-making assistance tools. These would allow operators to intervene early or in anticipation of incidents. He thus concurs with theoretical analyses based on the empirical results of Roth, Bennet, & Woods (1987). These results affirm the possibility of developing technical systems that are not only prostheses that compensate for operators' shortcomings but on the contrary, are instruments at their service.

A pessimistic view of human intervention which leads to a strict delimitation of activity at work

The "residual" point of view corresponds to a pessimistic view of human intervention. David Noble (quoted by Bernoux 1991) maintains that the digital control of machine tools was chosen over another option in which "the programming was not designed by engineers sitting at their desks but by the

¹ The crucial question of the pertinence and social legitimacy of the productive system opting for a progressive reduction of operators will not be discussed here. It goes without saying that this dimension of the problem is essential in a period of increasing mass unemployment.

production workers who operated the machine and programmed the new tasks it had to perform, i.e. programming while doing". According to Noble, the digital control option corresponds to a pessimistic view of human intervention as a source of errors in the production process. The second option, on the other hand, would have called upon the operators' competence and judgement. This point of view is shared by Johnson and Wilson (1988): "designers mostly consider the human operator as an inefficient and unreliable systems element".

In the residual perspective, it is not only the room for human activity that is restricted. The nature of the activity, given the pessimistic point of view, also tends to be strictly delimited. Spontaneous human interventions are considered likely to disrupt, or even damage, the operation of expert automates and machines.

In our "joke", the dog is the emblematic figure that represents the "necessity" of forbidding misplaced initiative or disruptive action. At the very least, it must be channeled and sufficiently controlled to render it inoffensive. In the design of airplanes, for example, Gras & Scardigli (1991) highlight the increasing number of systems that aim to prevent excessive accelerations, tilts or turns, i.e. any departure from the norm or personal piloting style. The tasks attributed to the pilot are reduced to a minimum.

Technological choices of controlling and delimiting activity correspond to the pessimistic vision of human intervention.

An example of a technocentric point of view

These options are in line with fundamental technological research choices that also accord a residual position to human activity. Thus, Sacerdoti (1977), in a publication about planning in Artificial Intelligence, looks at the design of robots that seeks autonomy. Convinced that robots' means of perception will remain rudimentary for a long time to come, he attempted to design machines paired with a human operator, with constant interaction between the user and the system. His perspective is the design of machines for which humans are an essential supplement given the current and probable future insufficiency of technological knowledge (in this case in terms of artificial perception). The departure point for Sacerdoti's research problematic is the technical system that incorporates people as supplements for that which is not yet treatable by technology. People are not the focus of this point of view. They are constituted in reference to a predominant technological point of view. For this reason, this type of problematic is technocentric.

How pertinent are technocentric and anthropocentric points of view?

Two main perspectives are thrown up by this first approach:

- a predominantly **technocentric** approach in which humans occupy a residual position, and in which their real activity no longer has a specific status. It can thus only be considered in the same terms as a technical process. As the work philosopher Schwartz (1988) put it, when we apprehend

work only by its technical nature, then there is no other solution than to speak of people via things, even when this option is grounded in a humanist perspective;

- a predominantly **anthropocentric** approach in which humans occupy a central position and determine the way relations with techniques, machines and systems are seen. This option places human activity at the heart of analysis and thus allows the reversal necessary so as to speak of things in terms of people – to use Schwartz's expression.

Of course, neither of these two points of view is sufficient in itself. The technocentric approach alone tends to place humans in a residual position and cannot allow a true apprehension of their activity. However, a unilaterally anthropocentric approach is incapable of apprehending technical systems in their technological specificity. The answer clearly does not lie in negating one of these approaches (which constitute poles at either end of dozens of intermediates). Rather, it is in their conceptual and pragmatic conjugation allowing the apprehension of a production system from both technological and human activity perspectives.

Yet today, conceptualizations of people's place in terms of their activity are insufficiently developed, or in any case much less so than technology-oriented ones and are sometimes even caricatured copies of the latter. The activities with instrument approach is one way of compensating for part of this deficiency and making up for lost time.

Through criticisms of approaches that are too unilaterally technocentric, we will see that the development of anthropocentric conceptualizations appears to be necessary, perhaps even urgent.

Criticisms of technocentric approaches

Many criticisms have been leveled at design in which people are considered as residual to technique. Lack of space obliges us to consider only a small number of these. We will focus on the field of work activities and those thrown up by psychology and ergonomics (control of operator-computer processes and interactions), as well as critical social theories.

Process control

Making industrial processes reliable is an important issue today given the economic, human and ecological costs of accidents and incidents. Several studies carried out in this perspective have attempted to determine the origin of errors usually considered as "human". They lead us to reconsider the origin of a number of these errors. For example, Reason (1990) demonstrates that some errors considered as "human" are in fact linked to causes deeply rooted in technical systems in the same way as pathogenic agents exist in a human body.

The nature of tasks entrusted to operators in automated procedures also throws up questions. In his revealingly titled text "Ironies of Automation", Bainbridge (1982) notes that the progressive elimination of humans in favor of robots paradoxically leads to only entrusting operators with the group of miscellaneous tasks not based on the needs of their activity but based on what is not automatable.

In the aviation field, debates on the place and the role of pilots in new generation airplanes are also heated. As of 1980, Wiener & Curry suggested that the pilot be "reintroduced" into the piloting circuit but in an "envelope" placed under the system's control. Thus they considered that the pilot had indeed been removed from the circuit!

Morishige (1987) who along with Rouse, Geddes, and Curry (1987) argues in favor of an approach to automation centered on the operator, also disputes the efficiency of the "full automation" option. For Morishige, who has developed studies in the field of fighter planes, the performance of automated systems is liable to improve when technical devices supply appropriate information to pilots. However, as the curves on the diagram indicate (figure 1), overall performance tends to worsen when automation is increased (when the system provides solutions or when it exercises control alone with no "manual" intervention). The author does not present empirical results to support this theory but its radical nature indicates the scope of questioning in this field.

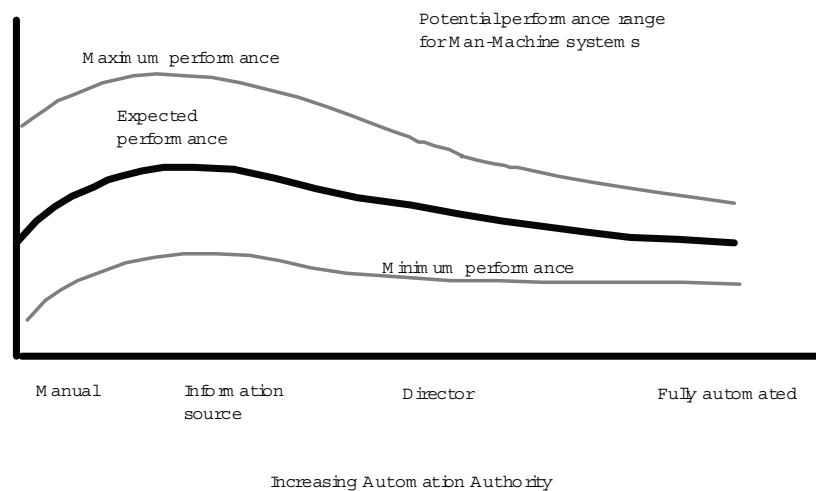

Figure 1
Performance of a human-machine system in the automation of airplane cockpits (based on Morishige 1987)

Human-computer interactions

Likewise, in the field of human-computer interactions, Kammergaard (1988), in agreement with Ehn & Kyng (1984), considers the excessive influence of the “system” perspective as a serious problem in the development of application programs: many of the negative consequences of application program use in the workplace are due to insufficient attention being paid to approaches centered on people at work

The system perspective, which is widespread in software design, is considered insufficient by these authors because operators are seen as equivalents to other components of the system: a group of human and machine components performs tasks as a result of their interconnected actions. Thus the task does not have a specific expression on the individual level. In this perspective, interaction is considered as a transmission of data between human and software components. This transmission must be effective and efficient (this is the main quality of the interface). For this reason, the user must if possible follow modalities similar to those of the machine.

Designers thus see standardizing the interface and disciplining the user as good solutions. Studies based on this point of view aim, first of all, at making data transmission faster and more reliable. The main design problem is then the distribution of tasks between user and machine for data processing.

Our authors consider that this perspective reduces human work to a data processing activity that is the only one capable of conceptualizing, in a technocentric perspective, in terms of algorithmic procedures. Breaking with this technocentric approach, the Utopia project (with Kammergaard's participation) was developed so the user could have a view of the system in which people, machines, tasks and materials are seen as interconnected in a terminology founded in the realm of tasks significant to the user.

Critical social theories

The discussion of the residual perspective and technocentric options are of course grounded in critical social theorists and sociologists such as Haudricourt (1964 & 1987), who calls for technology that would at last be a social science, or Habermas (1968) who conducts a powerful and stimulating critique of what he calls instrumental cognitivism.

Lhote & Dulmet (1992) consider that reference to human work is essentially missing from engineering science research (optics, electronics, electrotechnology, mechanical and procedural engineering). According to the authors, it is only in industrial automation that a partial awareness of the impossibility of eliminating human work is emerging. The production systems studied here are fundamentally hybrid, i.e. made up of human and technological resources. How these systems evolve throws up the “question of how to define the new role of humans in systems that are highly computerized and automated”. Work must take on a central position in

engineering sciences because, according to the authors, the specialists of these disciplines must recognize:

- that the user is omnipresent as soon as we stop focussing on objects that are too intermittent and the direct interventions they support;

- that the dream of the operator-free factory becomes a nightmare as soon as we realize, beyond its unacceptable social cost, the inescapable limits of purely computerized or automated solutions in terms of flexibility, reliability, adaptation to change, reactivity to hazards: purely technical approaches cave in under the weight of the complexity, cost, development time and question of efficiency when we consider systems thrown into the unstable and changing environment that currently typifies most companies.

Criticism of the residual perspective also comes from administration and company sciences. For Freyssenet (1992), belief in the possibility of replacing work or fully controlling it is a denial of reality. Engineering and administration sciences are starting to realize that the increasing number and sophistication of technical and controlling devices and attempts to understand the adaptability and inventiveness of the work act have led to burn out. According to the author, today these fields as well as certain companies are asking themselves:

- how to define a technical system in which the worker would not be the weak link in the efficiency chain but on the contrary, an actor of increased reliability, performance and development;

- how to define administrative tools that are not prescriptive, but rather aids for work collectives² in conducting action.

We can only concur with Freyssenet's conclusion: the irreducibility of the work activity has been heightened precisely because principles of substitution and relementation have been taken so far.

The activities with instruments problematic is part of the movement that criticizes the perspective that reduces human activity to a residual position. It seeks to contribute to a predominantly anthropocentric design of technical systems that are truly centered on an operator who is an actor of his/her work and therefore, an actor of the reliability, development and performance of the technical systems he/she participates in. Thus these systems must be considered both as a means of production (in the broad sense) and instruments for people at work.

Towards a human-centered design of techniques

² Recent developments in administration science are in line with this. They seek less to identify costs than to ensure that companies possess and can mobilize competence to produce economic value (Hubault & Lebas 1993).

The critiques that we outlined above come together to question approaches in which the place of people at work is seen in reference to and by its difference from that occupied by the technical system, i.e. in a residual perspective and often in the terms of the technique itself. Dubois P. (1992) insists that since the myth of the operator-free factory has done its time, relying on people to improve technical performance has become essential.

Another view of human relations with systems is emerging. In this view, technical systems and machines are considered in terms of operators and not the contrary. Humans are central and the place of technology is defined in relation to them. In this view, the technical system is centered on the person who is to use it. It will be imagined, designed and created in reference to the user (or users) for whom it will be a tool or an instrument. An anthropocentric notion of technique such as this is necessary and awareness of this necessity is starting to emerge, as we will see, in a variety of research and action centers: in companies, in training, in ergonomics, and in research policies.

Quality as a factor for re-centering on people in companies

Some of the current changes in criteria that production is subjected to are in line with a re-centering on people. While productivity and cost criteria have obviously not been abandoned, new criteria are being implanted. This is true of quality criteria, which lead, in some cases, to a reexamination of the place of people in the productive system. Of course, some undertakings favor a predominantly technocentric approach to the problem by assuming that a full control of production systems requires repeatability, as is sometimes the case in quality certification operations. The human activity point of view is then difficult to impose as Christol and Mazeau (1993) point out: the risk is that formalizing operations degenerates into a normalization that is seen as an end in itself: this return of the "one best way" is of concern in that one of the limits of Taylorism was precisely its difficulty in obtaining quality. Complete mastery of the production system only through repeatable procedures appears more and more as an unrealistic objective. Quality results from a system including: heterogeneous raw materials; equipment of varying reliability; organizational rules that must be interpreted to attain efficiency; men and women who are different from each other and whose characteristics change constantly, Deltor (1993). This is why anthropocentric approaches that consider operators as producers of quality and in some cases, as the main producers of quality are developing in certain companies.

Technical training and professional didactics

Meanwhile, in technical training, a renewal of interest has been observed for dimensions of professional competence such as skills, whose role in the operation of contemporary technologies had hitherto been underestimated or denied.

For Deforge (1991), both actor and observer of changes in technical training in France, two trends have shaken this field since its foundation in 1919:

- a movement toward grouping activities into branches based on the rationalizing and unifying ideology of technological training which has always aimed to surpass and erase technological particularities through reason. This rationalizing impulse, which was very strong until recent years, opposed notions of skill and assumed it would only persist in trades destined to disappear.

- a centrifugal tendency that despite a desire for unification, brings out corporative subdivisions or those inspired by the operational constraints of professions..

Technical training has fought hard against skill, testifies the author who participated in this battle as an inspector. Yet, he says, today it is coming back to other options and considers that skills have their place in the most evolved industrial processes. For Deforge, the efficiency of skills allows models born of technology that are too far removed from reality to reduce this distance. He considers skills as a specific source of qualification and a bonus for companies.

The revival of skills in the education system's training programs occurs primarily through on-the-job training courses, retraining courses and school-workplace schemes. We feel this is partly because changes in the recruitment of teachers has brought about a partial loss of the education system's training capacities in this field.

Originally, teachers of technical training courses were experienced professionals, preferably the best in their field. Today, they are mostly graduates in technical training whose trade experience is sometimes limited to a few brief sessions of work experience.

The demand for professional experience tends to be replaced by demands for technical knowledge as Tanguy (1991) indicates. The consequence is a distancing from the work activity, which then determines the recruitment of teachers and makes professional training of students more difficult. We are not convinced that the current move toward a range of training-workplace relations, work experience programs and the extension of training to the highest levels of education will fully compensate for the problematic effects of the excessively technocentric options followed in French education.

The current emergence of new research perspectives aiming to construct professional didactics is in line with Deforge's conclusions (1991): technology as a technical science allows us to understand techniques. However, when we have to perform technical acts in a technical environment, technical science is not enough because underlying techniques is the human actor with his/her skills, personality and affectivity which, he concludes, is so much the better.

We can hope that professional didactics (a supplement to technical didactics), initially focussed on professional training in professional environments, will also contribute to an anthropocentric revitalization of technical training.

Ergonomics and anthropotechnology

The ergonomic approach, a minimal definition of which is work's adaptation to people, is grounded in a predominantly anthropocentric approach and has been since its inception.

We will not go into the methodological, conceptual and theoretical evolutions in this field. Let us note only that beyond an ergonomics of human factors (sometimes known as "tables and chairs" ergonomics) based on analyses in terms of human "properties" that must be considered in a work situation, another form of ergonomics has developed. Influenced by the French-language school, ergonomics centered on human activity in the workplace has integrated and moved beyond approaches in terms of human factors. Today we see the emergence of predominantly cognitive approaches that aim at treating more specifically the cognitive dimensions of activity, in particular in connection with contemporary changes in work and the massive implantation of information processing machines (see, for example, Green & Hoc 1991, Hollnagel 1991, Thon & al. 1991, De Keyser 1991, etc.).

Thus, in the field of research into interactions with machines and information processing, Floyd (1987) distinguishes between two paradigms corresponding to two possible points of view in a design or research perspective:

- a paradigm defined as being product or machine-oriented; a point of view described as traditional in which the user is considered as static, with a fixed interaction with the machine that is pre-determined within the machine;
- a paradigm considering computers as tools for people doing a real job;

The author favors this second point of view centered on usage processes. He calls for an extension of the notion of the user. He writes that we must move toward design that considers the user as a person performing a real job.

Likewise, for Bannon & Bodker (1991) artifacts must not be analyzed for themselves and in isolation. They must be analyzed in their use settings which are non static, and evolve and develop over time. For this reason, a historical view of technology is necessary.

These reflections and analyses centered on the use of computer tools led to research into design practices which are themselves anthropocentric. A good example of this is the book by Norman & Draper (1986) "User centered system design: New perspectives in Human Computer Interaction"

The necessity of developing anthropocentric points of view has also emerged in the field of production systems. Clegg (1988) puts forward the idea of users appropriating the design of advanced production technologies. This appropriation perspective should be understood as having a double meaning: problems and solutions should be appropriate to users in that they need to be adapted to them, but also in the sense that they should become, in a certain way, their property.

The option of an anthropocentric approach to production technologies is developed by several authors in an ergonomics perspective. Corbett (1988), who places its origins in the studies developed in the late 1970s, resumes five main characteristics based on the literature:

- the anthropocentric approach is based on existing user competence and seeks to develop it, whereas a conventional approach tends to incorporate it into machines, thus contributing to a de-qualification of operators;

- anthropocentric technology seeks to increase the degrees of operator freedom to allow them to define their own work objectives and activities. Operator control precedes that of technology;

- anthropocentric technologies aim at reducing the division of labor;

- they aim at facilitating social communication (formal and informal) among operators;

- and more generally, they must aspire to the development of working environments more compatible with work health, security and efficiency.

Beyond these developments of ergonomics centered on the work situation and more generally on activity, the necessity of expanding the field of ergonomics has become apparent. The concept of macro-ergonomics including organization and training put forward by Hendrick (1987) joined studies on the industrialization of newly independent countries (Chapanis 1975, Seurat 1977) and the anthropocentric perspectives developed by Wisner (1976, 1985) to look at the problem of transferring technologies to developing countries whose economic, climatic, organizational, cultural and more generally anthropological conditions are different from that of the country from which the technology originated. However, as Montmollin (1992) indicates, while macro-ergonomic approaches correspond to real problems, today their theoretical grounding is often hazy and eclectic, closer to ideology than a truly scientific approach. A huge theoretical undertaking remains urgent in this field.

The anthropocentric approach to human relations to technology thus moves beyond the situation of an individual in the workplace to consider the collective dimensions of work and the anthropological specificity of human groups on a worldwide scale. This does not undermine its relation with the subject using tools he/she must appropriate in new conditions, as Guillevic (1990) reminds us.

Research policy inclinations

The necessity of an anthropocentric development of techniques is also reflected in the analyses and recommendations of European research policies.

Cooley (1989) states that current systems are predominantly designed in a technocentric perspective. According to the author, they tend to render

users passive and the machine active. They are born of design dominated by the three essential characteristics of natural sciences (predictability, repeatability and mathematical quantification) and tend to exclude intuition, subjective judgement, tacit knowledge, imagination and intention. The author sees this as the result of a trend toward marginalizing operators and turning them into passive appendages to the machine. Based on his thesis, he reminds us of the suggestion formulated in an article from "American Machinist": the ideal worker for most digitally controlled machines would be mentally retarded with a mental age of 12.

Nonetheless, as Martin (1989) stresses in the same report, all attempts at designing digitally controlled machines with no need for operator competence have failed. Despite a partial automation of operations, the skills and knowledge relative to production remain indispensable to use these machines efficiently. This is why systems based on an exclusively technocentric approach encounter serious difficulties: they are not very robust or flexible and are extremely sensitive to disruptions. The authors conclude that it is necessary to develop anthropocentric technologies that associate human skills and ingenuity with advanced and appropriate forms of technology in a true symbiosis.

Among the research fields that this report targets for development is the design of anthropocentric systems and tools as opposed to machines. In the education field, it also recommends studies on training methodology through use in the field of new technologies, as well as the elaboration and generalization of knowledge in training through action.

Conclusion: techniques must be considered in terms of their psychological dimensions

In a publication aiming to constitute technology as a human science, Sigaut (1991b) highlights the strangeness of the belief that techniques are not social: once this belief is overcome, techniques return to the fold of social sciences.

In the same way, it seems to us that the idea that techniques are not psychological is every bit as strange: techniques must also join the problematics of psychology and two main directions seem possible.

- One of these directions consists in apprehending the operator and machine in the same terms. Today, this is a well-worn path, particularly in the field of cognition. It sometimes seems that the limits of the mechanical metaphor are not always well defined or mastered.

For Feigenbaum (1991), thought is of the same nature, whether it be human or mechanical. "Humanity is a mechanism," he says. According to him, the nature of the physical, material incarnation that supports thought is of no importance because thought can be reduced to the manipulation of symbols. "What is the importance of physical incarnation? What difference does it make that we are made up of flesh and blood... Do we wonder what sort of body Einstein had? We never think about it when we refer to the general theory of relativity," states the author.

Onfray (1991) gives us a timely reminder that these theories are not new. Oscillation between understanding humans as machines and constructing machines that simulate them goes back a long way. Already in the 16th century there was a twin approach in which the body was seen as a machine and machines simulated the body (giving rise to the success of robots). Descartes, for example, dissected animals, and perhaps humans, and at the same time tried to develop robots.

We can wonder whether Feigenbaum's statements are perhaps contemporary forms of an update of this perspective in cognitive terms. Perhaps tomorrow, we will smile at the over-simplicity of his affirmation, just as today we smile at the hypotheses of 16th century mechanists or the fantastical (and no doubt provocative) predictions of Minsky: artificial intelligence, that of machines, will soon be so developed that we will be lucky if computers allow us into their homes as pets. It seems that these predictions are taking a long time to come true. Perhaps it is because fundamentally speaking, computer processes and thought and human activity processes are definitively non-interchangeable.

- Another direction consists in trying to apprehend machines and humans in different terms, not making them interchangeable, and analyzing technical activities in human terms. It is in this perspective that the instrumental approach we will develop in this publication will be grounded.

Technique is the way someone does something, wrote Lynn White in a phrase whose importance, according to Sigaut (1991), is to remind us that the "someone is essential" because he/she indicates the right perspective. A technique only exists when it is practiced, i.e. when it is passed via someone who, having learned or invented it, applies it efficiently. There is no technique without efficiency and the human skills it implicates. Techniques must thus be observed where skills are produced. However, this always takes place on a scale of one or two individuals. The observable reality of technique is on the scale of a person or a small group of people.

We can only adhere to this conclusion. Even if analyses must be situated at different levels, we share the author's point of view that the best level is that where there is direct contact between operators and material objects - we would add, more generally, between operators and the objects made as well as artifacts (including symbolic ones), and their associated uses. This analysis scale is precisely that of psychology even if it is not exclusive to it.

The instrumental approach is thus situated on a level of analysis of techniques as psychological constituents. It contributes to theoretical reflection and the empirical examination of relations between humans and human-centered technical systems from the perspective of operators engaged in real activities and actions situated in their work, training or daily life contexts.

Advantages and limitations of non-psychological approaches to techniques and artifacts

The development of points of view relative to human-centered technique requires theoretical and methodological tools fitting with these goals. We share the view of Hatchuel (1992) who calls for an enrichment of the analysis of technique. In order to do so, he says, we must ground ourselves in intermediary theories that are not paraphrased from the language of the mechanic, robot technician or chemist, nor simple discourse on social arrangements. According to the author, notions such as tool, instrument, procedure, prototype, machine, assembly, construction and integration are already intermediary notions that we use spontaneously but they are fragile.

Social actors mobilize particular knowledge that depends on the relations they build with technical objects: their intentions, use and fantasies. The idea that an object has a use is, according to Hatchuel, an excessive simplification: a technical object has uses that our knowledge allows us to apprehend or discover; we must recognize that a particular object can be compatible with several types of technical knowledge and thus also with several types of technical competence. In exploring possible categorizations of knowledge, we look at technical objects in a way that permits us to reconstitute the nature of relations an actor will have with them, as well as the validity and legitimacy of his/her actions.

Gonod's approach (1991) aims to clarify these relations. He puts forward a global vision of the rationales underlying our relations with technical artifacts (figure 2). The author distinguishes four rationales: construction, operating, use and evolution, based on which he situates approaches by different scientific disciplines (figure 3). This approach is interesting for its attempt to situate and coordinate possible points of view. However, in its current state, it is still insufficient: consideration of human activity is limited which leads, as we can see in figure 3, to an absence of any reference to psychology as a discipline allowing analysis of technical constituents. It is thus necessary to complete Gonod's synthesis:

- in taking figure 2 as a starting point, we must at very least add a design rationale corresponding to designers' activity (and thus in relation with – but distinct from – the construction rationale) and give a psychological sense to the other dimensions, particularly to the utilization rationale;

- add the missing family of disciplines (psychology, ergonomics and didactics) to the approaches identified in figure 3.

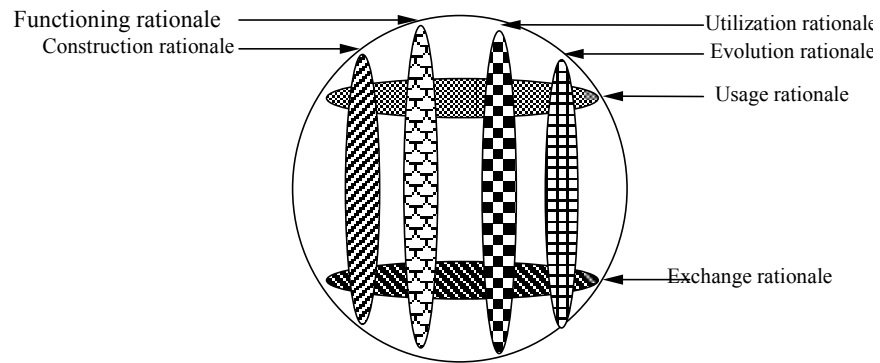

Figure 2

Multidimensionality of technology (based on Gonod 1991)

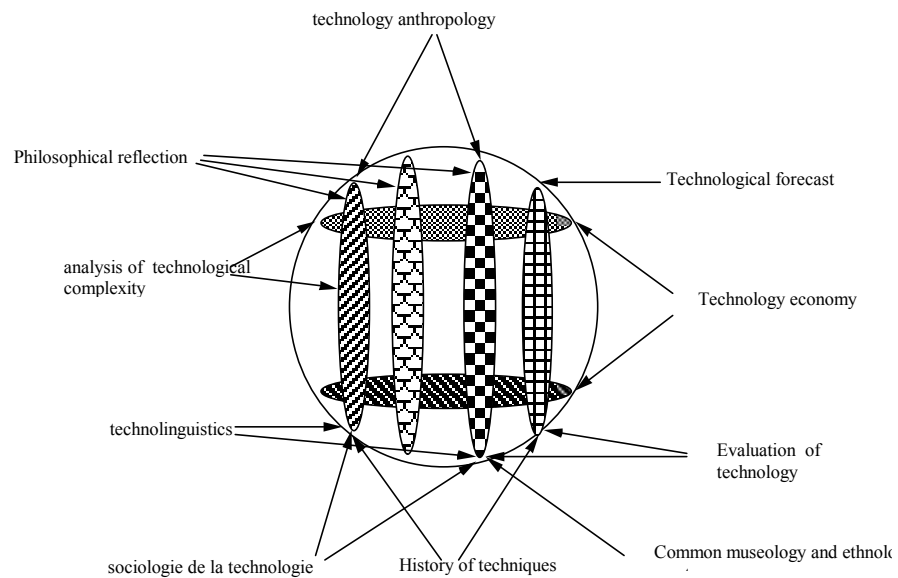

Figure 3

Multiplicity of scientific approaches to technology
(based on Gonod 1991)

Perrin (1991b) takes a step in this direction: he criticizes the point of view that sees technology as an application of sciences. He says we must distinguish between the knowledge processes of natural sciences and artificial sciences.

According to the author, the history of engineering sciences (civil, mechanical, chemical, etc.) indicates that they have only made progress when confronted with the design and construction of new artifacts. The production of technical knowledge is fully linked to that of artifacts: the action of designing a new technical object engenders the process of transforming and producing technical knowledge. Affirming that artifact design activities give rise to the production of technical knowledge means accepting that the

production of technical knowledge is based on specific characteristics of these design activities.

It also means hypothesizing that the laws of evolution and genesis of technical objects result from characteristics specific to intellectual and organizational procedures that are used in designing them (Perrin 1992).

In the point of view developed by Perrin, a part of human activity appears: that of designers, and this is very important. Yet it is limited to the sphere of artifact design: there is no production of technical knowledge in use. Thus the utilization sphere and the associated knowledge production processes (knowledge and representations for action) remain unrecognized.

Affirming that technical knowledge can only progress via the design and construction of new technical objects again indicates a point of view that is partly technocentric in which technique is reduced to objects and systems and only the activity of designers who are socially recognized as such is taken into consideration.

Perrin's position could take on another meaning if the idea of design itself had another meaning: design continues in use, through uses like the design of these uses as well as by a questioning of technical objects themselves. Following this other point of view, usage also gives rise to the production of technical knowledge, particularly knowledge relative to artifacts as instruments.

The instrumental approach aims to contribute to the elaboration of intermediary concepts and theories whose importance is highlighted by Hatchuel. Based on the study of the instrumental relations subjects have, during action, with artifacts, we gain a deep understanding of one of the forms of relations with technical objects: use relations. We will analyze these relations as they are constructed by the subject and in their meaning for the subjects themselves, i.e. from an intrinsic point of view. This undertaking implies distancing ourselves from conceptualizations born of technical knowledge and elaborating and developing the necessary intermediary concepts.

We thus fall in step with authors such as Bannon and Bodker (1991). These authors affirm that since artifacts exist in the activity and are constantly transformed by activity, they should not be analyzed as things but as usage mediators. Artifacts are not only individual means. They are bearers of the division and sharing of labor and their significance is incorporated in social practice. As a result, artifacts evolve constantly and reflect a historical state of users' practice at the same time as they model this practice. For Bannon and Bodker, a computer application program, for example, must be considered as a group of tools whose design creates new working conditions for both the individual and the collective. The introduction of the artifact changes not only the operational aspects but also all the other aspects of the practice. This is why utilization processes need to be at the heart of research rather than the artifact itself.

It is in this perspective that we put forward a psychological conceptualization of artifacts as instruments. We aim to make this conceptualization equally pertinent for ergonomics and didactics. In maintaining links between conceptualizations generated by technological, anthropological, sociological and philosophical fields, we will define the instrument in the essence of its constituting relation: **the subject's use of the artifact as a means he/she associates with his/her action**. The point of view adopted will be that in which machines, technical objects, symbolic objects and systems, i.e. artifacts, will be considered as material or symbolic instruments.

CHAPTER 2: PSYCHOLOGICAL APPROCHES TO TECHNIQUES AND ARTEFACTS

Awareness of the necessity of an instrumental point of view on techniques and, within these, on artifacts, is not a privilege of our era of "new technologies". We will outline the main ideas on the subject. Its history is already long, though somewhat chaotic, made up of forward leaps and sometimes long halts. We will see that today, for many people, a renewal appears desirable.

Vygotsky, a founding vision still alive today: the instrument at the heart of the development and functioning of the psyche

Vygotsky is one of the most profound and influential of authors. Many of the authors we will quote place themselves within, or find themselves one way or another following one of the directions he opened up during what Rivière (1990) rightly called a prodigious decade of production from 1924 to 1934. Vygotsky himself, as Bronckart (1985) reminds us, situated himself within the perspectives explored in philosophy, particularly by Spinoza, Hegel and Marx.

In a text from 1931, he develops the epistemological grounds of his psychological approach. The behavior of the contemporary, culturally evolved adult is the result of two different processes of psychic development. In phylogenetic terms, there was a process of biological evolution which led to the appearance of homo-sapiens, as well as a process of historical development through which primitive man developed culturally. The difficulty of studying superior psychic functions lies in the fact that these two dimensions of biological and cultural evolution, in ontogenesis, fusion into a process that is both unitary and complex.

According to Vygotsky the two fundamental forms of cultural behavior are the use of instruments and the human language. As Verillon (1988b) stresses, we find in Vygotsky what we do not find in other authors that share his preoccupations on the specificity of human cognitive development in interaction with artifacts: an attempt at describing the psychological processes by whose intermediary such a development would be possible.

This attempt places activities with instruments at the heart of the problem of the constitution and functioning of superior human psychic functions. In 1930 based on the notion of interior technique developed by Claparède, he put forward an instrumental method for psychology grounded in the principle of a similarity between the role of “psychological instruments”, seen as “artificial adaptations” that aim to control human psychic processes and the role of instruments in the workplace.

The integration of the instrument in the behavioral process activates a whole series of new functions linked to the usage and control of the instrument. It replaces and renders useless a whole series of natural processes whose work is developed by the instrument. It transforms the progress and the particular aspects of all psychic processes that enter into the composition of what he calls the instrumental act. It replaces some functions with others, recreates and reconstitutes the whole behavioral structure, just as the technical instrument completely restructures work operations. Taken as a whole, the processes are a complex, structural and functional unit oriented toward the solution of the problem raised. They are coordinated, and during the activity defined by the instrument, form a new complex: the instrumental act. Thus, just as work, as an activity adapted to an end cannot be satisfactorily explained in limiting ourselves to goals and problems, the explanation must refer to the employment of tools; the explanation of superior forms of behavior is that of the means that allow people to master the process of their own behavior (Vygotsky 1934).

Because of the in-depth studies he carried out on language in an instrumental perspective, Vygotsky’s studies exercised and still exercise a great influence on psychological studies in this field (Wertsch 1979, 1985; Bruner & Hickmann 1983, etc.). However, it is also clear that this same instrumental perspective is destined to have an increasing influence in the field of study and design of relations with artifacts and techniques. For example, Vygotsky is quoted as a reference in five of the fifteen chapters of a collaborative publication postulating the importance of re-grounding psychology in the field of human-computer interactions (Caroll 1991a). This influence is likely to increase, particularly given that an unpublished manuscript specifically treating the instrumental approach, “the Instrument and the Sign in Child Development” has been discovered (Zazzo 1989) and its publication announced³.

Techniques constitute the human environment and are the means of transmitting the species’ cultural capital

Leontiev’s approach follows the perspectives opened up by Vygotsky and presents them in his articles (for example Leontiev 1965) and two of the books published in French (Leontiev 1975 and 1976) including “The Development of the Psyche”, which is an elaborate synthesis based on several texts and articles.

³ It will be interesting to compare this work with the text published under a similar title in the book “Mind in Society” (Vygotsky 1978).

The relation to artifacts and instruments is an important dimension of the theoretical frame. Leontiev takes up Vygotsky's hypotheses concerning the reconstruction of the activity in use as a whole without, it would seem, contributing anything truly new. His contribution is relative to both a systematic development of the concepts of activity theory and a conceptualization of the notion of the artifact in relation to the development of the human psyche, although here too he takes up Vygotsky's reflections. We too will insist on this last point.

The distinction between natural objects and artifacts is not necessary for a theoretical elaboration of the development of the animal psyche, yet it is for that of humans. When an animal uses a tool, even one that is man made, the animal considers it as part of its "natural" environment that it must adapt to. The animal only sees the tool as a natural means of acting on instinct, for example bringing a piece of fruit closer to itself. The monkey's tool performs a certain operation but this is not fixed in the tool. As soon as the tool has performed its function in the monkey's hands, it loses all interest. It has not become the permanent support for this operation.

It is not the same for human instruments, which are part of the non-natural world produced by human culture. The instrument is not only an object with a specific form and determined physical properties. It is above all a social object whose use modalities are elaborated during collective work. It is a bearer of work operations that are crystallized in it.

This is one of the central points of Leontiev's theory: the fixing of the human species' cultural capital. While the evolution of animal species is biological, human evolution takes place through the fixing of the species' cultural capital within phenomena external to material and intellectual culture.

Each person acquires truly human capacities by appropriating this cultural capital. Leontiev stresses that even instruments or tools from everyday life must be actively discovered in their specific qualities. Users must perform a practical or cognitive activity on these tools that adequately corresponds to the human activity they incarnate, i.e. one that reproduces the characteristics of the activity crystallized (accumulated) in the object.

However appealing this theoretical approach may be, no empirical element has really supported the appropriation thesis besides a few didactic examples. Leontiev leaves us hanging. However, we will see that he is not alone in his cultural approach to the human psyche and the place of artifacts and techniques.

In several texts, Wallon (particularly Wallon 1935, 1941, 1942, 1951) examines relations between people and techniques. He formulates hypotheses on their possible effects on the development of children and more generally, how cognition can be affected or even transformed.

Children cannot be apprehended outside the environment in which they grow up and which is part of them from birth. The world they must adapt to, on which they model their activity and impressions is not invariable and eternal. The group of objects specific to this period: their cradle, their bottle,

their blankets, fire, artificial light; later the furniture whose structures they manipulate, the tools that form their habits and teach them to make things, techniques of language, explanation and comprehension that regulate their thoughts in imposing on them, via conceptual or logical frames, the division of efforts and the objects that inhabit the world placed at their disposal today by thousands of years of material and mental elaboration.

Thus the environment that children react to is not only physical. It is the environment humans have created through their activity. The younger children are, the more they depend on this social environment. Techniques, artifacts and instruments are, like language or customs, constituents of this social environment by which, according to Wallon, people in transforming their living conditions, transform themselves.

Based on the idea put forward by Langevin, that the notions we use to represent familiar things spring from an ancestral and distant contact with them, Wallon explores their evolutions in terms of those of the technically structured environment: what will happen to the notion of human presence, i.e. the possibility of assigning a single spatial quality to combined visual and aural impressions, for a child in front of a radio? It is impossible that the airplane, with its fast contractions of space, will not modify the time-space relations elaborated by people whose measure was their footsteps and the movements of their herds. Speed thus apprehended in its extreme variability could render time and space relations more concrete, more lively and more intimate.

Wallon's examples are dated but the questions he raised over 50 years ago have remained pertinent and important in a period that is seeing, for example, the emergence of "virtual realities". His investigations have profound psychological implications and we can only be struck by their similarity with very contemporary problematics relative to categories of knowledge and its situated nature⁴ (Dubois 1991, Rosch 1975, 1978, Weill Fassina, Rabardel & Dubois 1993) and at the same time to artifacts (in the broad sense), to techniques, and to instruments as psychologically significant objects

He considers that the formula of knowledge categories cannot be considered as given once and for all. They accompany human activity in its ability to use things. They reflect the laws and structures that our techniques allow us to discover and apply in nature.

Human and animal techniques: breaks and continuations

Vernant (1987) reminds us that one of the major ideas of historical psychology developed by Ignace Meyerson is that people must be studied where they have invested the most: what they have made, constructed, instituted and created to edify the human world is their truly natural place: tools, techniques, languages, institutions, literature, arts, etc.

⁴ Knowledge is situated in that subjects strongly associate it with the situations in which they constructed and/or used it. These situations are both dependent on the subject's specific history and that of the society and culture in which it is inscribed.

For Meyerson (1948), the instrument and the machine throw up several problems for psychology, among which is the fact that new techniques act on and form users. Faced with a tool, people can be masters or merely cogs. They can feel more or less dependent. They can participate more or less and in various ways in the machine.

Human objects, “artifices” as he calls them, thus constitute the mediating worlds that form the successive screens between people and nature. Every new technique has its source in and is accompanied by a new mentality. Every invention, however unimportant, acts on people’s minds.

The impact of activities with instruments, and more generally of techniques, on humans is thus designated as an important object for psychology, in particular and not exclusively work psychology given that Meyerson considers work not only as conduct but even more fundamentally as a psychological function (Meyerson 1948, 1955).

Although he did not establish the link himself in his texts, how can we not see in his conception of human psychology, the echo of studies done much earlier with Guillaume on the use of instruments among monkeys? Their publication was spread over eight years during which the two authors progressively developed a conceptualization of the notion of the instrument and corresponding research problematics that were linked with problematics of similar human behavior on several occasions.

The successive titles indicate this evolution: “The Detour Problem” Guillaume, Meyerson, (1930) “The Intermediary Linked to the Object” Guillaume, Meyerson, (1931) “The Intermediary Independent of the Object” Guillaume, Meyerson, (1934) “Choices, Corrections and Inventions”, Guillaume, Meyerson, (1937).

In the first studies, the instrument is present in an experimental frame aiming to explore detour behavior. The authors try to distinguish, within the difficulties the monkeys encounter, those which are due to the instrument, those due to the detour technique and finally, the interaction between these factors. These problems were then compared to the difficulties encountered by the war wounded suffering from certain types of apraxia. In these initial situations, the detour question is given more importance than explorations of the activity with instrument.

However, the specifically instrumental approach then develops throughout the studies and texts that describe them. The mediating, intermediary status of the instrument is affirmed: it is when the experimental situation obliges the animal to understand the properties, either of the intermediary, or of the link between the intermediary and the field, that the problems really appear. The signification of the instrument varies from one animal to another, or even in the same animal depending on its experience and perhaps the conditions of the situation. The instrument is thus an intermediary whose properties must be seen independently from those of its members and associated with those of its members.

This approach is widespread. Our authors write that an instrument is for humans, and it would seem for animals, a sort of intermediary world whose properties are, or can be, different both from those of the body and those of the objects on which the action is exercised. To act efficiently, we need to be able to associate these diverse properties in more or less variable situations. The instrument's use among monkeys and among humans supposes explicit knowledge. This knowledge consists of artificial behavior, true techniques in the sense that there is an acquired art, which includes delicate and precise adaptations of the hand to the tool, the tool to the object and the hand to the object via the tool.

Motricity problems depend on the nature and form of instruments, which are intermediaries that allow indirect action on things. With the instrument and via the instrument, thousands of different situations are encountered and the instrument must be adapted to them. An instrument is a transformer. Learning to handle it means being able to subordinate the motor impulse to its new effects. The reaction of effects on causes is constantly being corrected. At the same time, the instrument is invention in as far as it moves beyond and renews. It liberates pre-trained reactions and constructs and creates new responses, both instrumental techniques and body techniques.

Guillaume and Meyerson, through the idea of body techniques, thus linked their explorations to studies that Mauss (1935) developed elsewhere in anthropology. However, human intelligence is not reduced to that of anthropoids. In a text from 1980, for example, Meyerson is very critical of studies done on the language of monkeys (Gardner 1972, Premack 1976). Through language learning, children enter the world of expressions and possibilities that make up the world that is specifically human. Meyerson affirms that this cannot be confused with the experimental mumbling of the few monkeys analyzed by the authors who were looking for hidden treasures that did not exist.

Is practical intelligence an inferior form of intelligence?

Based on studies of children, particularly on practical intelligence, Rey (1935) also questioned relations between the instrument use behaviors of children and monkeys. His starting point was research by Koehler (1927), as well as the possible extension of some of his observations to adult behavior.

For example, he observed that a child who has begun using instruments has great difficulty in seeing the tool independently of the activity he/she imparts or wishes to impart to it. The action's orientation causes the objects to disappear by absorbing them into a dynamic structure in which environment and self are not differentiated. Rey looks at possible similarities with adult behavior in certain activities that engage sensory-motricity: during delicate manual work (taking apart a mechanism or drawing, for example), do we clearly distinguish the instruments used?

However, Rey's work is interesting for another reason. His analysis of the origins of research on practical intelligence reveals, although he does not stress this himself, that from the outset, the activities with instrument approach was disconnected from an instrumental conception taking into

consideration symbolic systems. The reference was the very young child, the animal or the abnormal child. This option led to the view that practical intelligence was an “inferior form of intelligence”. The possibility of a generalized approach to instrumented activities, taking into consideration instruments that activated the highest levels of cognitive activity was closed from the very start. This no doubt also explains, at least partially, the lack of studies based on problematics of practical intelligence.

We believe that what we need today is the development of a generalized conception of the instrument that allows us to apprehend its status and the activities it is associated with on every level of cognitive functioning, including the highest levels. Of course, this concerns symbolic instruments. Yet beyond this, it is the instrument’s status in work and everyday life activities linked with contemporary technology that makes this update necessary.

However, the study field of training and the evolution and transformation of sensory-motor activities constitutes, as we have seen, a domain in which the question of activities with instruments is highly relevant, even if it is in different terms for people and animals.

In reading Bullinger (1987a & b) who looks at these issues in children, one can only be struck by similarities between his analyses and studies by Guillaume and Meyerson. However, the former extends the reflections of these authors whose series of articles ended with an affirmation that perhaps temporarily blocked potential instrumental research: “It is the instrument that leads to invention. We invent little when we are only faced with our own bodies.”

In suggesting that the body is the subject’s first instrument, Bullinger breaks with this affirmation and opens up the possibility of not only a questioning of the process of instrumenting the body, but also the possibility of placing these questions in a more general problematic of the psychological status of the instrument and activities with instruments.

His approach is grounded in a double reference to Piaget and Wallon.

Along with Piaget, he argues that the subject’s activity should not be confused with the functioning of the biological machine. This would add up to evading, as far as the psychological subject is concerned, the issue of the origin of instrumental activities: the body is, and perhaps above all becomes an instrument for the subject. But for Bullinger, the problem of instrumentation must also be examined in a light that reveals the fact that instrumental elaborations go well beyond biological organization.

He joins Wallon in considering that environments are a means of activities for the child. The organism, which is the main object of instrumentation in young children, is not the only instrumentable element: those exterior to the biological organization can rise to the status of means⁵.

⁵ Let us remember that Bullinger placed himself in a sensory-motricity instrumentation perspective.

Thus, stresses Bullinger, problems of motor control may not stop with the naked hand but extend to the hammer being held.

In this, he extends studies by Guillaume and Meyerson, questions put forward by Rey, as well as hypotheses by Vygotsky (1930) who considers that children, in their development phase, are instrumented with a wide range of instruments. The levels of development are differentiated by the level and nature of the equipment and thus, by the degree of control over their own behavior.

From the epistemic subject to the psychological subject: genetic psychology's move toward acknowledging techniques

In a profoundly different perspective, another researcher from Geneva, Mounoud (1970), developed research on the child's structuring of the instrument.

He confronts children with tests of problem solving by the construction and use of instruments (inspired by those of the preceding authors) that seem to him the most suitable to studying the formation of true and false logic norms. Tests with instruments have the advantage of containing material criteria of success and failure, which the author sees as the only ones possible for the very young children (aged 2 to 7) that interest him. They were also chosen because they allow him to closely study the processes of action interiorization and reflective abstraction that are his main points of interest.

Mounoud's approach is thus situated in a perspective of genetic psychology that consists in seeing action and thought as modes of exchange and adaptation between the subject and the outside world. It aims at defining, thanks to behavioral evolution in the chosen tests, the interiorization of action schemes from the point of view of their general coordination as well as that of the appropriation of the physical environment.

His perspective is thus only vaguely linked to questions of a psychological approach to techniques and artifacts. Nonetheless, the author describes his tests as indicators of practical problem resolution and from the outset, takes into consideration the specific nature of the instrument, i.e. upholding a simultaneous complementarity in terms of the subject's actions and the objects he/she applies them to.

Perhaps this is one of the reasons that his studies, although very interesting, have so far sparked little follow-on research, including in the author's own work.

His research is situated in a theoretical frame of Piagetian thought. As Vérillon (1988a) points out, this does not attribute a specific place to artifacts or fabricated material objects. The object submitted to the Piagetian subject is an ahistorical object: its essential property is that it is determined by physical laws. That these laws were constructed in the object by nature or artificially is not, in this perspective, a pertinent difference. The introduction of artifacts in Piagetian experiments is essentially linked to their ability to facilitate

identification of invariant properties of the real or their importance in terms of analyzing behavior in a structural perspective.

Inhelder and de Caprona (1992a) remind us that the profound originality of Piaget's work was in orienting his work toward the study of fundamental knowledge categories, without which no adaptation to reality would be possible. This option allowed the creation of a fundamental psychology dealing with the construction of notions such as space, time, causality, etc. Piaget's problematic is entirely turned toward the cognitive genesis of properties of the real and actions that progressively constitute structures, categories and knowledge instruments. Mounoud's research was essentially grounded in this frame.

However, the psychological approach to activities with instruments in our opinion comes mainly under another perspective oriented toward the functional analysis of the psychological subject's behavior. This perspective is centered on the dynamics of subjects' finalized behavior and organized actions, their goals, choice of means, controls and the specific heuristics allowing them to attain a particular result via several different paths.

In this decidedly functionalist perspective, a series of important studies around those of Inhelder and Cellérier and complementing those of Piaget (to which they made a major contribution) have developed since the late 1970s concerning cognitive micro-geneses in finalized behavior.

Yet in Geneva, the idea goes back even further. As of 1954, at the Fifteenth International Congress in Psychology, Inhelder (1955) put it forward and generated interest among psychologists who were then engaged in the beginnings of what is now known as the "cognitive revolution", particularly Bruner's.

From information processing to situated cognition. Which status for techniques?

Bruner (1991) reminds us that psychology today is affected by two revolutions: the cognitive revolution since the mid 1950s and only now, contextualism which is fundamental. Knowledge and cognition are considered by these as contextualized and distributed, transgressing the individual's limits. The author aims to reorient the cognitive revolution (of which he was one of the instigators) toward its founding principle: "the construction of signification"⁶.

For Bruner, the idea that signification is unrelated to information in the computer sense, definitively disqualifies theories that consider people as elements in the transfer of information in a flux. He says that we must break

⁶ Prévost (1994), who considered Bruner's book as a milestone, highlights its unusual editorial past: its author is J. Bruner, leader of American cognitive psychology, at least that of the East Coast and more specifically, New York. He teaches at Harvard University and initially wrote this book as an internal report for this university. A French editor had it translated and published it in 1991. According to Prévost, it was not until autumn 1992 that Harvard distributed it in a less confidential manner.

with paradigms that require making what we study artificial to the point where it becomes difficult to recognize a representation of a human life.

He puts forward an analysis of the evolution of ideas within the “cognitivist revolution”: little by little, the focus shifted from signification to information and from the construction of signification to information processing, under the influence of the now dominant metaphor of the computer. It is in this light that we ended up evaluating the validity of a theoretical model, despite the fact that information is indifferent to signification. In computer terms, information contains a message pre-coded in the system: meaning precedes the message. It is not produced by the computer and is not at all in its domain.

The concept of computability replaced that of signification, and the cognitive processes of programs used on the computer were identified. Complex programs were apprehended as virtual minds and real minds as comparable to the former. Partisans of the Stimulus-Response model adhered to this in replacing stimulus by entry and exit by response... The new paradigm left no room for the mind understood as an intentionality of states (believing, desiring, pursuing an objective, understanding a signification): the new anti-mentalist science was to banish intentionality. A simultaneous attack was launched on the concept of the agent, which implies that the action is conducted in the realm of intentionality.

For Bruner, the central issue in psychology is thus a creation of a science of signification and processes by which it is created and negotiated. Signification and interpretation are the founding principles of a psychology that is not interested in behavior, but rather in action, its counterpart grounded in intentionality, or more specifically, in the action situated in a cultural whole and in the reciprocal interactions of participants' intentions. Human, material or intellectual tools participate in culture. People find in them the means they need to go beyond and sometimes redefine their natural limits.

Language learning, a symbolic tool, is instrumental. The analysis of accounts allows us to identify “naturally” significant categories of action for people: in their makeup, they respect the elements identified by Burke: an agent's action, in order to reach a goal, through instrument use, in a scene that imposes certain constraints.

The identification of material or symbolic instruments as participants in culture is in line with approaches developed by several of the preceding authors. Bruner places instruments in contemporary debates on the evolution of psychology. His choices lead him to place concepts of signification and people as agents (subjects) of a situated and contextualized action at the heart of psychology.

These choices are also those underlying our approach to activities with instruments and we will see that they are far from arbitrary. Their necessity also comes from the issues and difficulties faced by psychology when it intends to contribute to the design of machines (even the most contemporary) when these machines constitute a means of working for operators.

The evolution of ideas in work psychology and ergonomics

These issues go back a long way in work psychology and ergonomics. In the mid 1960s, research on intellectual activities in work on instruments was undertaken in several sectors, as Leplat and Pailhous (1973) remind us: air navigation control (Leplat and Bisseret 1965), the chemical industry (Savoyant 1971), rolling mills (Cuny and Deransart 1971) etc.

The basic situation common to these different studies is one in which the operator's action is mediated by an instrument-tool, machine or remote control device. This instrument transforms the action as well as the information provided to the subject for this action.

In these studies, the stress is placed on the operator's representation of the device or artifact's properties. Leplat and Pailhous highlight the necessity of carefully distinguishing between dimensions relative to the machine's operation (for the expert, the operator, etc.) and those relative to its use, keeping in mind its goals: "in requiring that operating rules be defined before studying utilization rules, we risk embarking this research on a slippery path... we risk ending up with rules that are logically coherent but have nothing to do with the subject's activity".

The distinction between the utilization plan and the operating plan effectively corresponds to modalities of approaches to instruments that users can differentiate, as Richard (1983) indicates in his research on functioning rationales (centered on the process used in the machine) and use (centered on the user's action and activity).

In the mid 1960s, the "Soviet" school of psychology developed similar questions. (studies by Ochanine 1966, 1978 are significant examples) warning against the naive realism of engineers and proclaiming the necessity of developing an anthropocentric point of view (although this term was not used at the time). According to this view, it is the model that the operator constructs of the machine in line with the finalization of his/her activity that should be the focus of interest.

The subject, his/her finalization, the significance he/she attributes to action situations that Bruner considers as needing to be at the heart of contemporary psychological research, have thus been major issues for studies in work psychology and ergonomics for a long time. Evolutions in technology and production systems have only served to reinforce these explorations, while orienting them toward an acknowledgement of the specific forms of complexity and new instrumental potential generated by these evolutions.

Leplat (1991) stresses that the complexity of work, further increased by the development of new technology, leads to many accidents that reveal the extent of the dysfunction of the complex systems users are associated with. The problem of designing truly efficient work aid systems thus becomes crucial.

Leplat distinguishes two diametrically opposite trends for the design of such aids given the different options in operator-robot task distribution:

- One of the solutions is the tool-prosthesis, in which the tool replaces the operator for a certain number of tasks (but then we tend to move out of the instrumental situation frame) and the operator deals with problems the robot cannot deal with;

- the other solution involves collaboration between an operator who is indeed competent but has access to limited resources, and what Leplat calls a tool-instrument.

He thus generalizes analyses by Roth, Bennet & Woods (1987) who develop this same distinction between prostheses and instruments concerning cognitive tools born of artificial intelligence:

- prosthesis type systems are defined as a means of compensating for human deficiencies. In this paradigm, the focus is more on the system's construction than its use and the operator is essentially in the position of interface between the machine and his/her environment. Control is carried out by the machine part of the operator-machine system. The operator is in charge of providing data to the expert system as well as taking into account and applying the solutions proposed;

- systems defined as instruments are defined as means allowing competent users to perform tasks. In this paradigm, subjects' competence in the construction and use of tools is considered as a resource allowing goals to be attained. Unlike the prosthesis perspective, the user has an active role. The instrumental point of view on cognitive tools leads to using computer technology not as a means of production or of recommended solutions, but to help the user reach his/her own decisions.

As several authors have indicated (Woods 1986, Woods, Roth, & Bennet 1990, Bainbridge 1991), the relation between the machine, the computer and the operator is moving toward cooperation and collaboration.

Nonetheless, the design of such cooperative aid instruments is extremely demanding, both in terms of the analysis of systems and that of the activity of the operators concerned. The extent and difficulty of these demands seem to have been long underestimated, even if current interrogations, particularly in the study field of human-computer interactions indicate a renewal and reorientation of the issues.

The idea of aid systems that assist diagnostic activity and the elaboration of solutions tends to be developing in this direction (Falzon 1989). Such systems no longer aim to provide operators with an answer (or the best possible answer by a sort of analogy with Taylor's "one best way"). Rather, they seek to help the operator in his/her own analysis activity. The operator associates the system with his/her activity in a collaborative relation. This type of design choice is clearly anthropocentric: operators and their activity are placed at the heart of the device, which is designed from the outset to be

associated with them. It is in line with the instrumental paradigm described by Roth, Bennet & Woods (1987).

The necessity of reconstructing psychology to allow a real contribution to the design of technical systems

It was also in a perspective of critical reflection on psychology's contribution to design in human-computer interactions that in June 1989, a number of research leaders in this field participated in an important seminar in a New York hotel. Participants agreed that a wide gulf separated psychology and the HCI field⁷. The conclusion, put forward in the Kittle House Manifesto, is that psychology needs to be reconstructed (Caroll 1991b): in the 1970s, psychologists applied laboratory methods with modest success; in the 1980s, they applied information-processing theories with poor results.

Criticisms concern both HCI psychology's ability to pertinently describe users' and designers' activity and the inadequacy of the proposals it put to designers.

The "Human Factors" paradigm is criticized because of the place it accords psychology, i.e. essentially the *a-posteriori* evaluation of a system already designed. This evaluation is considered to be of little use to design because it produces few improvement proposals and those it does produce, often appear too late.

Methods based on the frequency of errors and performance times are considered to contribute few elements capable of enriching design: many theories can only be used to model very narrow phenomena.

The computer metaphor is strongly debated: users do not recognize their own work in task descriptions in terms of information processing. These analyses are often considered too weak to aid design.

In a text from the same publication, Bannon and Bodker (1991) develop the question of signification. The positions of classic cognitivism and its experimental approach are criticized on these grounds: analyses concern individuals without reference to their culture and their history; problems are defined and evaluated by the experimenter and placed in an unfamiliar environment; the real nature of the task and expected behavior are often not apparent to the subjects and the question of signification for the subject is only rarely explored; performance is evaluated in terms of rationality norms that are external to the subject and his/her deviation from these norms.

Bannon and Bodker also consider that HCI research currently neglects essential facts: developmental aspects relative to both tools and user competence. The analysis of skills acquisition comes under fire because it only looks at the first hours of use. A long-term approach to skills and competence development is recommended.

⁷ HCI is an abbreviation of "Human Computer Interaction".

Finally, according to the manifesto, design aids grounded in the psychology of information processing (guidelines, rules, etc.), seriously underestimate the complexity of the design process. Under Simon's influence, they treated this complexity as if it could be partially broken down hierarchically which led to a distorted view of the process. The models and guides based on an apprehension of design in terms of problem solving are not considered very pertinent in that they are not coherent with real design mechanisms (the possible solutions are not likely to be identifiable; the breaking down into sub-problems does not advance the solution to the global problem; partial and temporary solutions do not participate in the final solution but play an important role in the space specifications of the final design; the design process includes the discovery of new goals). Psychology thus needs to aspire to understanding the processes of real design.

Generally speaking, according to the manifesto, HCI psychology needs to be enriched methodologically and conceptually. It should be both more diverse and more specialized.

The development of action and activity theories, the description of tasks and the view of artifacts as psychological objects are seen as a group of unprecedented intellectual tools in this perspective. Several of the book's authors recommend the incorporation of the methods and concepts of developmental approaches in HCI psychology.

The relation to artifacts and techniques: a central issue for psychology

This renewed psychology called for by the Kittle House manifesto and to whose emergence it contributes, must treat relations to artifacts as a central concern. These relations need to be explored along two lines corresponding to two forms of human activity:

- design activities: it is necessary to have a better understanding of the mechanisms and processes by which artifacts are designed to provide designers with real aids. Assisting the design activity supposes that the aids proposed be coherent with this activity. They must integrate it, rather than hinder or even prevent it;

- usage and utilization activities: it is necessary to analyze and understand what these activities are from the perspective of the users themselves, as well as their modalities and significations that occur within social situations and contexts whose singularity and complexity must be respected.

According to the authors, understanding through psychology the processes at work in the fields of use (specificity principle) and design (applicability principle) is crucial to the creation of the contextualized science necessary for design. Respecting the singularity, the complexity and the signification of the context is thus considered as a condition for applying psychology and more generally, all forms of science.

The signification of the result of instrument use as well as the instruments themselves, in reference to action and activity is also an essential dimension for Bannon & Bodker (1991). In the same publication, after a discussion of traditional HCI models, they present an alternative theoretical frame for real activity and use of artifacts in work situations⁸. They suggest not considering computers as objects, but rather as tools and instruments. They define guidelines to such an approach:

- artifacts exist in activity and are constantly transformed by activity;
- artifacts must not be analyzed as things but rather in the way they mediate use; studying mediation is thus essential for HCI;
- artifacts are not only individual means; they are bearers of the sharing and division of labor;
- their signification is incorporated in a social practice.

The link between artifact design, tasks and work is also at the heart of interrogations by Greif (1991) who considers that machine design should be part of the design of work as a whole. Work activities are constituted through the design of real tasks and tools.

An instrumental approach is also put forward by Payne (1991) who refers to Vygotsky and Bruner: for him, the fundamental point is that thought is formatted by tools. He advises analyzing the way in which artifacts structure the task, both in bringing up new questions (artifact-centered problems) and in contributing new resources for performing the task and moving beyond these new problems.

In the same way, Kuutti (1992) develops an instrumental point of view based on activity theory, which for the author, brings HCI a new vision compared with the standard cognitive science point of view (communication between two information processors): there is no longer question of a user interacting with a computer, but an active subject using an application program as an instrument to manipulate objects in such a way that the result of the manipulation is, for the user, significant in the context of the activity.

Many of Norman's studies look at the psychology of everyday activities (1988) as well as the consequences to be drawn in a design perspective

⁸ The question of signification is placed at the heart of the issue of the necessary renewal of a psychology that aims to describe human interactions with artifacts and more generally, the appropriation of techniques. We could say that studies in the field of cultural psychology naturally lean this way. Bruner is not alone in this. Cole (1989) puts forward an overview of the birth, death and current revival of interest in the culture of artifacts and states that cultural psychology is grounded in two major theses: human skills in the creation of artifacts; and the skills corresponding to the transmission of knowledge thus accumulated to following generations. In our opinion, these theses converge with old explorations on the differentiation between humans and animals (with all the studies carried out from this perspective in using the tool as a differentiation criteria) and those of cultural theories of human nature and the external transmission of the cultural capital of the species (an important theme in Soviet psychology).

(Norman and Draper 1986) He also looks at approaches to activity from of the Soviet school (Vygotsky 1978, Luria 1979, Leontiev 1981) and their followers (Wertsch 1985b).

In a text from 1991, he highlights the role of Soviet psychology in the field, the way it was forgotten and even repressed under behaviorism as well as the current revival of the problematics it has inspired.

Norman distinguishes two points of view: “the system view” and “the personal view”:

- the system view is that of the external observer who looks at how the human-artifact whole accomplishes a task. This is the classic human-machine system view in which the system is considered in terms of a centering on the process;

- the personal view is based on the analysis of the modifications brought about by the use of an artifact: what is transformed in the task, what must be learned, the procedures that must be abandoned. This view aims to analyze both the aspects linked to the task and those linked to the activity

Norman looks at the effects of artifacts on activity. He distinguishes several dimensions of influence in terms of the distribution of actions in time (precomputation), the distribution of actions among people (distributed cognition) and the changes in actions required by individuals in order to perform the activity. He considers that the construction of artifact typologies is an important task for psychology and suggests distinguishing between passive artifacts such as books and active artifacts such as computers.

The instrumental approach is situated in a “personal view” and like Norman, we think it is necessary to analyze the object’s influence on the recomposition of tasks, the appearance of new tasks and the disappearance of old tasks. He analyzes, for example, the problem of checklists to demonstrate that their use is itself a task that introduces new tasks: making up the list, remembering to consult it, reading and interpreting the items on the list.

Yet we feel it is necessary to go beyond an approach in terms of tasks, toward analyses based on the hypothesis of a total recomposition of the activity in line with the perspective opened up by Vygotsky with the concept of the instrumental act. The results that we have obtained in the robotic field (Rabardel 1990, Rabardel 1991a, Rabardel 1993b) follow these hypotheses: the very conception of the world in which the user acts via the instrument is transformed. In the same way, in computer assisted design (Rabardel & Beguin 1993, Beguin 1994) we highlight the emergence of a specific way of handling the activity’s objects as operating materials in line with an anticipation of future productions and the instruments that will be available at that time.

We have seen that the idea of the necessity of a specific psychological questioning of the modalities and characteristics of human relations to artifacts is widely held, in both fields of everyday life and in work with

instruments such as computers. The necessity of psychological questioning is also emerging for activities in relation with complex technical systems.

Norros (1991), for example, lays out the characteristics of FMS (flexible manufacturing system) technologies:

- These technologies are systemic and evolutionary; their application is progressive and complex. The design process continues during use of the system, both in operators' working methods as well as technical solutions and organizational structures. Thus, says Norros, a participatory design process is necessary;

- new activities are required by the tool's new characteristics, in particular mediation to bring about both a sensorial distancing from the operator and visibility given to the characteristics, properties and system states that are of course invisible;

- the respective roles of explicit and tacit knowledge are altered due to the uncertain nature of situations that require diagnosis and decision for action.

We are at the limits of the instrumental approach, at least in the terms we wish to give it in this publication. The question of the nature of instruments and the associated forms of activity in process surveillance and the control of the dynamic environment are of course important. However, our own studies in this field are too limited today for us to take the risk of generalizing.

Future directions for the definition and analysis of activities with instruments

At the end of our exploration of the literature, it appears that even in the field of sensory-motricity where activities with instruments have been studied most, a lot of empirical and theoretical work remains to be done. Beyond this, we feel the superior forms of activities with instruments must be studied in terms of their relations with sensory-motricity and the originality of their own forms.

We are looking not only at psychological instruments⁹, but also at instruments born of contemporary technology and production modes that allow and condition action and activities oriented toward the world of objects.

A project such as this is naturally grounded in the fields of human activity that are directly concerned by activities with instruments: first of all in work, a prime source of complex and standardized uses; education and training where instrumental competence develops and fundamental psychological instruments are constructed; and lastly in daily life, where uses multiply and are reproduced day after day and are also diversified following sometimes random encounters.

⁹ As Vygotsky understood it: they allow one to act on oneself or on others. We will return to this notion in the following chapter.

This direction in psychological research could only truly develop if it respects the complexity, variability, diversity and singularity of real situations in social life. In various forms, this is what the majority of the authors we have referred to have called for. It is the true meaning of a contextualist renewal that is now vital for psychology.

Work, training and daily life cannot be considered as areas in which a universalizing and asocial form of psychology can be applied that would inject into it data supposedly fundamental for its application. The limitations of this perspective have led, for example, to today's calls for an overhaul of HCI psychology. Work, daily life and training are areas in which psychology aiming to take psychic activities into consideration in terms of their human specificity and diversity should be developed. In taking these elements into consideration, it will then produce results that can effectively be reinvested for the transformation of situations within which people live their lives.

PART TWO: THE NOTION OF THE INSTRUMENT

The aim of this second part is to develop an overall theoretical frame for the analysis and conceptualization of activities with instruments. The elaboration of such a frame requires a psychological definition of the notion of the instrument. This will be the objective of chapter 3. It will lead us to conceive of the instrument as a mixed entity made up of an artifact and a scheme.

In chapter 4, we will examine instrumental geneses, i.e. the subject's elaboration of his/her instruments. Finally, in chapter 5, we will analyze the effects of instrument use on the subject's activity and put forward a group of concepts allowing us to define and account for these effects: required activity, expansion of the range of possibilities, operative transparency.

CHAPTER 3: INTRODUCTION TO THE NOTION OF THE INSTRUMENT

In the beginning of this chapter, based on an examination of different approaches, we will suggest considering these objects and technical systems as artifacts. We will then describe the instrumental relation to the artifact as one of the possible relations to artifacts. In the third part, we will describe activity with instrument situations and put forward a triadic model of this class of situation. We will then examine the different views of the instrument in psychological literature, before presenting a summary.

Technical object, fabricated material object, artifact

In the famous article "Technology as a Human Science", Haudricourt (1964) stressed the possibility of a variety of views of the technical object: "Take this table. It can be studied from a mathematical point of view - it has a surface and a volume; from a physical point of view - we can study its weight, its density, its resistance to pressure; for from a human science point of view - the origin and function of tables for mankind".

This range of possible perspectives corresponds to different analysis issues as Bibard (1991) explains. Technical objects can be described as belonging to the technical systems they fit into (this is the innovation sociology approach). They can also be seen as part of technical branches (B. Gilles' approach), or as forming part of socio-technical systems that are restricting for people (an essentially economic point of view). Bibard embarks on an analysis aiming to explain what is contained in things, what is inscribed in them to make them usable and useful, and what defines their coherence and relations with their surroundings.

This project is not unrelated to the views of Simondon, one of the contemporary philosophers who has explored technique most thoroughly. In 1968, having observed that culture has set itself up as a defense system against techniques, he aimed to demonstrate that in ignoring technical reality, it ignored a human reality.

He defined the technical object as an intermediate type of reality, a reversible mediation between people and the world, and a paradigm of the relation between the living and the environment. For Simondon, the meaning of the technical object is how it works. Studying invention introduces an understanding of the object's internal essence as a reality with its own coherence. Biological study, on the other hand, makes it appear as a functional bridge between heterogeneous realities: organism and environment. Comparative technology, studying technical objects, must thus focus simultaneously on their functional dimension (ordering different means according to their usefulness) and their internal perfection as technical beings.

For Simondon, technical activities, at the most elementary level, appear essentially as functionally useful mediation. However, at a higher level, criteria of inherent perfection take over. The evolution of technical objects means progressively eliminating operators as a source of energy (machine tool), then of information (complete machine), to the networks by which the world which becomes a technicized environment with which the operator has contact via interfaces.

This approach is behind several studies, particularly in the tradition of technical genetics (Deforge 1981). Yet it reflects an inherently technocentric point of view in that it values the internal perfection of the technical object, thus undermining the status of the being, of the technical individual. This intrinsic point of view sees the technical object as a being that is moving toward autonomy, i.e. the elimination of the operator.

For the author, object usage activities have a "minority status", while the engineer or designer's relation to the object has a "majority status". These terms do not have negative connotations for Simondon: he feels a halfway path between minority and majority statuses is an appropriate relation to technique. However, they will inevitably lead him, perhaps despite himself, to effectively only according a minority status to usage activities, i.e. to people's activities when they uphold an instrumental relation to the object.

As Bernoux (1991) indicates, stressing the minority-majority opposition leads to the idea that the user's practice contributes nothing to knowledge of the technical object. We feel that it even leads to a denial of the usage activity, particularly in the workplace. Thus, for Simondon, the technical object has been apprehended through work as an instrument, supplement or product. He feels there should be a turn-around to allow that which is human in the technical object to appear without being seen in terms of the work relation.

The consequences of this view will have even greater importance among those who, based on Simondon's research, will have a completely unilateral interpretation of the technical object, whose uses will be only be seen in light of designers' anticipations. Many other researchers besides Simondon have, like him, contributed, despite themselves, to the notion that the technical object is predominantly associated with a technocentric point of view.

It is a problematic situation that makes the examination of the technical object difficult from other points of view than that of the technique itself. For this reason, we have replaced the term technical object with that of "Fabricated

Material Object” (FMO). The term “technical object” thus designates a fabricated material object seen from a technical point of view, just as the term “product” describes this same object as something to be designed, made or sold; that of the “instrument”, the object being used, etc. The different terms thus indicate the types of particular relations specific to the fabricated material object (Rabardel 1984, Léonard & Rabardel 1984, Rabardel & Vérillon 1985).

The term “fabricated material object” was chosen to allow the most neutral possible name and avoid anticipating the analysis perspective to be adopted. This undertaking seems even more essential today given the issues at stake in technocentric and anthropocentric design. But we feel the term fabricated material object, a heavy circumlocution, should now be replaced by that of artifact. This word is almost synonymous and its usage is fairly widespread, particularly in the field of human sciences (see, for instance, several chapters in the joint publication Perrin 1991a).

In anthropology, the notion of artifact designates anything that has undergone a transformation, however minimal, of human origin. It is thus compatible with an anthropocentric point of view. Another advantage is that it does not restrict meaning to material things (from the physical world). It can also be applied to symbolic systems, which instruments are at times.

Thus, from now on we will use the term artifact, a “neutral” term that does not specify a particular type of relation to the object. However, we will give a more precise definition than “something that has undergone a transformation of human origin”. We are interested in the thing liable to be used and elaborated so as to participate in finalized activities.

Finalization is constitutive of the artifact’s design, or at least the class of artifacts our research refers to. Indeed, as we wrote about fabricated material objects (Rabardel, Vérillon 1985), its finalization is at the origin of its existence. Each artifact was designed to produce a class of effects and its implementation in conditions anticipated by designers allows production in situation of these effects¹⁰. In other words, each artifact gives rise to possible transformations of the object of the activity, which were anticipated, deliberately sought and are liable to become concrete in usage. Hence, the artifact (whether material or not) makes concrete a solution to a problem or a class of problems raised socially.

Mostly, artifacts have a social status from the outset that goes beyond the one the subject grants it in associating it with his/her action. At the same time, it often remains short of the properties the subject attributes to it or really exploits. The finalization of the artifact gives it particular characteristics, which anticipate use of both real objects on which it can act with the aid of the artifact, and the activities and modalities of action.

Finally, we will use the term instrument to designate the artifact in situation, inscribed in usage, in an instrumental relation of action to subject as

¹⁰ The effect sought can be forbidding a certain type of action or transformation. This is true, for example, of security devices.

a means of the action. This is merely an initial definition indicating a minimal approach to the psychological notion of the instrument and corresponding to one of the weakest uses we will make of the notion of instrument.

Machines and instruments: a question of viewpoints

Artifacts in use within a production and activity system, often called machines¹¹, can be apprehended from several viewpoints, each of which is pertinent in its own way.

The artifact as a technical system

One approach sees the artifact as a technical system with specific features, which is considered independently of humans. This, for example, is the approach that Lafitte (1932) proposes for machines. They are seen as bodies organized by humans that form, within nature as a whole, a sort of reign that in its richness, its variety, the singularity of its prodigious development as well as by the vagueness of its contours, is the same as other reigns we have imagined up to now. This perspective, which was also partly shared by Simondon, is not really a psychological approach to relations with artifacts. It is the equivalent of the way an entomologist sees the ant: the artifact is a thing to know, an object of knowledge.

Nonetheless, focussing on the artifact as a functioning system and structure obeying specific rules and constraints also concerns the operator in action in his/her relation to machines.

This is true of designers whose objective is to end up with an effectively functioning and operational artifact that performs the required functions. According to the colorful image put forward by Coutouzis and Latour (1986), the machine is a machination, a strategy, a trick, in which the forces enrolled control each other in such a way that none of them can extract itself from the whole. The engineer's skill consists in finding a range of ways to implicate each element in the functioning of the others. In this perspective, the system's functioning is seen in light of its design.

This is also true of humans engaged in action: the artifacts in use, even if they did not create them themselves, can be systems for them that function according to their own laws and constraints. They must consider this functioning in the way they use them. For example, a driver takes into consideration the constraints linked to the functioning of his/her car by watching the temperature of the motor, tire pressure, etc.

Yet maintaining the machine in a functional condition may be more than a secondary task (however necessary), as for our driver. It may also be the object of the job, as is the case of maintenance technicians, and to a degree, those in charge of the surveillance of automated installations and major procedures. This requires maintaining the system as a whole as functional

¹¹ In this section, we use the term machine as a synonym of artifact (widely used in technological literature) when the authors themselves use it.

within acceptable limits. For the subject, the artifact is an object to be known so it can be managed in order to make its functioning correspond to prescribed or simply expected criteria. This relation, the **functioning rationale**, as Richard (1983) put it, organizes the relation to the artifact.

The artifact in light of its functions

The relation to artifacts in use can also have a second dimension. It can be focused on the evolutions and changes in state of (material or non-material) objects that the system deals with and acts on. The focus is less on the artifact as a functioning system than on the artifact producing transformations of the product treated, matter or information; on the processes of these transformations; on the successive states; the flux, etc.

Thus the artifact is seen in terms of its functions, of what it produces, i.e. in terms of what happens to objects, to the things whose transformation it contributes to as a sub-group of a larger system, such as a production unit or a company. This sub-group can itself be considered as a mixed operator-machine system that produces transformations¹².

In this perspective, the **process of transforming things** organizes the point of view from which the human-machine relation is apprehended.

The artifact as a means of action

Finally, a third type of relation between operators and artifacts in use is the instrumental relation. The artifact is placed in a finalized activity from the viewpoint of the person using it. It thus has the status of a means of action for the subject who accords him/herself this means to operate on an object. This means may also be accorded to the subject, as in the case of the workplace, for example. Here the relation to the artifact is apprehended from the viewpoint of the subject, of his/her activity and action. In this light, it is **activity and utilization rationales** (to use Richard's terms once more) that organize the approach to the instrumental relation of humans to artifacts.

Functioning, use and process as complementary rationales

Naturally, the instrumental relation does not exclude other types of relations to artifacts in use. These are very often complementary to the instrumental relation, or even integrated within it. It is often necessary for the subject to maintain the artifact in a functional state (functioning rationale) and manage the process of transforming objects (process rationale) so that the artifact is an efficient means of his/her action (use rationale, instrumental relation).

Let us take an example in the domain of plastics extrusion. The operator runs a machine that allows the fabrication of a plastic film whose thickness must be constant, give or take a few microns. The operator is responsible for

¹² For example, it is this last option that underlies Coutouzis and Latour's affirmation that the actors of such systems can be freely chosen among humans and non-humans.

the quality of the film. The plastic matter reaches him/her in the form of granules, is melted in an oven and extruded as a film. Having observed an irregularity in thickness, the operator hypothesizes that the filter that homogenizes the matter in fusion is partially clogged (functioning rationale), leading to an insufficient flow of matter causing irregularity in the product (process of transforming things rationale). The operator increases the temperature of the oven (utilization rationale) so as to make the matter more liquid and thus reinstate the quality of the product.

This example illustrates that the operator's instrumental use of the machine (i.e. as a means for his/her action) to attain quality objectives can involve considering the functioning rationale as a transformation of things rationale. It also shows that only part of the machine (the oven temperature setting) constitutes the operator's instrument, rather than the machine as a whole. The instrument is thus not given once and for all and interchangeable with the machine itself. It is the product of the operator's choice, who associates the machine, artifact, or most often a sub-group of the artifact with his/her action.

CHAPTER 4: THE TRIAD NATURE OF ACTIVITY WITH INSTRUMENT SITUATIONS

Despite major differences in the way they conceive of artifacts and instruments, most of the authors mentioned explicitly (or sometimes implicitly) distinguish between three poles engaged in instrument utilization situations:

- **the subject** (user, operator, worker, agent, etc.);
- **the instrument** (tool, machine, system, utensil, product, etc.);
- **the object** towards which the action, aided by the instrument, is directed (matter, reality, object of the activity, of work, other subject, etc.).

We will see that the meaning of each of these poles varies greatly depending on the author and the viewpoint underlying their interpretation system. Nonetheless, the principle of situating the artifact in a position that is both intermediary and mediating between the subject and the object seems to be a widely held option. We have shown elsewhere (Rabardel 1993a) that even when authors do not refer to it explicitly, a careful analysis of studies often allows us to identify the same poles.

For this reason, we have put forward the I.A.S. model to describe classes of Instrument-mediated Activity Situations (Rabardel & Vérillon 1985). This triad model (fig. 4) brings out the multiplicity and complexity of relations and interactions between the different poles, unlike the usual bipolar models of subject-object interaction situations. Beyond direct subject-object interactions (dS-O), many other interactions must be considered: interactions between the subject and the instrument (S-I), interactions between the instrument and the object on which it allows one to act (I-O), and finally subject-object interactions mediated by an instrument (S-Om). Furthermore, this whole is thrown into an

environment made up of all the conditions the subject must take into consideration in his/her finalized activity. Each of the poles and each of the interactions that we have just examined are themselves liable to be in interaction with the environment thus defined.

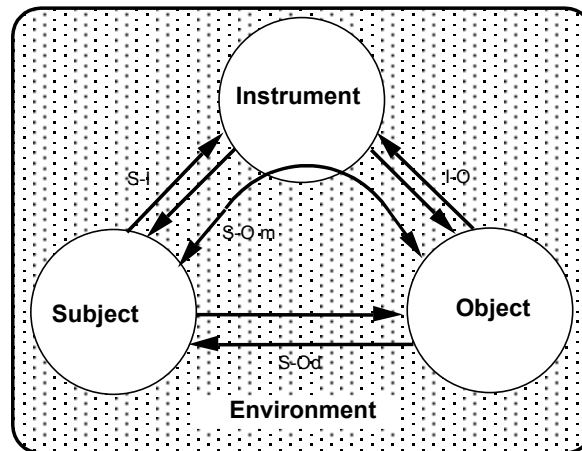

Figure 4

I.A.S. Model: the triad nature of Instrument-mediated Activity Situations (based on Rabardel & Vérillon 1985)

The I.A.S model is a tool for the analysis of tasks and activities. Let us take an example borrowed from Aucherie and Sacotte (1994). It concerns a professional painter preparing the walls and ceiling of a room by using a wallpaper removal machine¹³. A fast observation of the activity allows us to establish an initial description. The painter runs the plate of the wallpaper removal machine over all the areas covered in wallpaper. At the same time, he scrapes with a spatula the wallpaper that comes off due to the steam. He then applies the machine to the ceiling and explains that he has discovered that the heat makes the areas in poor condition more fragile: he then has to merely scrape them lightly with the spatula. This description of the activity is analyzed in terms of the status of the different elements in table 5.

The example of analysis based on the I.A.S. model presented in table 5 immediately reveals certain essential characteristics of activities with instruments. First of all, the objects of the activity are numerous: plaster, wallpaper, ceiling and vary at different times. Likewise, there are several instruments: wallpaper removal machine, spatula, steam. For the subject, a single technical device (the wallpaper removal machine) incorporates several instruments: in the phase examined, these are the plate and steam, but at other moments, for example when starting up the machine, elements such as the cover of the heater, the gas tap, etc. are liable to have the status of

¹³ The device produces high-pressure steam. It consists of a hollow metal plate, which on one side allows the steam to escape through a series of holes (like an iron) and on the other side, has a handle that allows the user to manipulate it.

instruments. Unexpected elements have the status of instruments, such as steam. Finally, the painter uses the wallpaper removal machine to carry out tasks not foreseen by designers: weakening the plaster. We will come back to this point in detail in the chapters devoted to instrumental genesis in which we will analyze the signification of this "misappropriation" as being part of activities of elaborating instruments by users.

ACTIVITY	SPATULA	PLATE wallpaper removal machine	STEAM	PLASTER	WALL PAPER	CEILING
Painter runs wallpaper removal machine over wallpaper		instrument	instrument		object	
Using a spatula, he scrapes at wallpaper which comes off under the effect of steam	instrument		instrument		object	
He runs wallpaper removal machine over ceiling		instrument				object
The steam weakens plaster			instrument	object		
Painter scrapes with spatula	instrument			object		

Table 5

Example of the analysis of activity based on the I.A.S. model.

Of course, it is clear that the I.A.S. model, even in this simple example, does not cover all the characteristics of situations in which activities are mediated by instruments: the range of instruments used by a single subject in a complex action; the very variable and sometimes collective nature of the action's contexts; the subjects' specific finalizations, etc. Yet the instrument is present, and this presence constitutes the resulting triad and multiple interactions that form a common core, characteristic of the class of instrument-mediated activity situations.

However, as we will see, this shared core is liable to be interpreted in several ways.

A techno-centered approach

The COST report in 1991 on the definition, state of the art and scientific perspectives in the field of human-machine communication gives an elaborate expression to this type of approach¹⁴.

The user and the machine are considered as a system thrown into an environment. The aim of this system is to carry out a certain task. The interactive nature of relations between the operator, the machine and the environment is essential. Operator-machine interactions are not simple exchanges of information. Rather, they must ensure the coordination of two intelligent processes that take place, one in the operator's brain, the other in the machine. The machine must thus dispose of a representation of the operator and his/her world, of the object and its world and a strategy allowing it to execute the task in cooperation with the operator and under his/her control.

Focussing on the machine as a machine is manifest: the machine must help the operator to perform a task but he/she must undergo training to benefit from this aid. The machine has to perform two functions: managing the dialogue with the operator and performing the task (or planning).

A tripolar model of human-machine relations is put forward under the name of "operator-machine-object triplet" (fig. 6). We will examine this triadic model in the conceptualization of each of the poles and in that of interactions.

The conceptualization of poles:

- the **human pole** is less constituted in terms of the subject than as a human component (with its own characteristics and properties) of a broader system that goes beyond him/her and in which he/she is inserted;
- the **artifact pole** is considered in machine terms, or of the operating and functional machine. It is thus not at all, or only slightly, an instrumental point of view focused on the system as a means of the subject's action. This view is symmetrical to the view of the operator;
- the **object pole** is considered as that on which the operator-machine system activity is focused. The object pole is made up of the object of the shared activity of the system's components thrown into the environment common to the operator and the machine. Two views of the reality the operator-machine system is faced with are thus distinguished: a view in terms of object (referred to the object of the activity) and another in terms of environment (i.e. the context of the activity).

¹⁴ The COST report is the fruit of a group in which the positions held were far from homogenous. Our interpretation concerns the point of view that we considered dominant in the report.

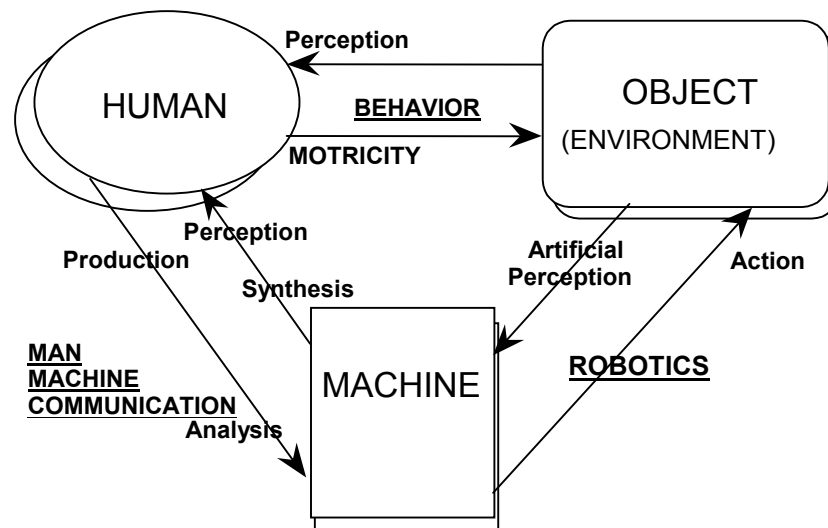

Figure 6

Operator-machine triplet (based on the COST report 1991)

- interactions:

- the different spheres of interactions between both operator and machine and machine and object are present. They allow us to distinguish domains of scientific study: operator-machine interactions being in the domain of operator-machine communication and machine-object interactions in that of robotics.
- however, and this is one of the essential shortcomings, instrument-mediated subject/object interaction is missing. We can hypothesize that this is the result of the view of the operator and the machine, both reduced to the notion of components of a system, i.e. part of a vision in which the focus is on the system itself and in which it is the system that acts.

The predominantly technocentric conception of this triad approach appears in the functions the machine must perform: managing the dialogue with the operator and performing the task (or planning it). In both cases, the operator loses out. This view does not refer to the operator's action and activity but rather to the process of accomplishing a task, which is that of the system as a whole. There is a symmetricizing of the statuses of the operator and the machine. This symmetricizing is perhaps inherent to the notion of the operator-machine system once it is considered in reference to the object transformation process.

Such a conception is of course fully applicable when we have to elaborate technological solutions. Yet it is insufficient when we need to analyze the situation from the viewpoint of the operator engaged in action, i.e. a point of view in which the artifact has the status of a means for this action. This viewpoint is necessary to the constitution of a specifically psychological conceptualization of the notion of the instrument.

The collective's anthropocentric approach

The viewpoint expressed by Norros (1991) which examines the question of developing operators' expertise in FMS (Flexible Manufacturing Systems) grounded in a triadic model (see fig. 7) is systemic. The work process is considered as a socio-technical system of activity and operator activity is examined both as an individual and collective activity.

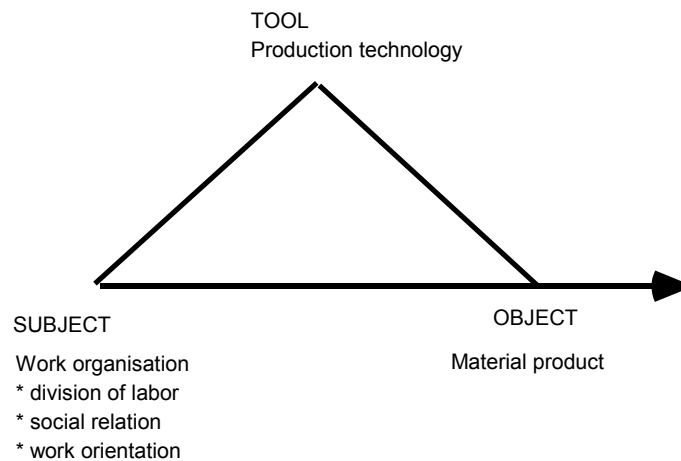

Figure 7 Norros' model (1991)

The view developed by Engeström (1991), inspired by Vygotsky and Leontiev is also systemic, but at an even more general level. He suggests considering the system of socially distributed activity as a pertinent analysis unit. An activity system is constantly racked by tensions and contradictions internal to its elements and among them. In a way, it constitutes a self-organizing machine, virtually producing innovations and disruptions.

The author presents a triad model (fig. 8) of such a system considered as a unified dynamic whole including: the operator and his/her colleagues in the work community (subject); the conceptual and material tools (instruments); the objects of the action (object).

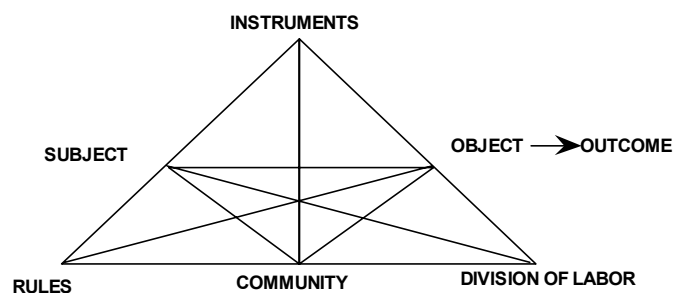

figure 8

Engeström's model (1991)

This model implies several mediations in the activity (between subject and object via instruments, including symbols and representations). Yet the triangle is only the tip of the iceberg. Less visible activity mediators form the basis of the model: rules, community and division of labor. The system is constantly changing and the system's activity reconstructs itself continuously.

The approach as a whole is thus focused on the global system that makes up the company and thus allows the analysis of the collective dimensions of work. The author thus breaks with the idea, described as "Cartesian", of the individual brain as a pertinent analysis unit considering cooperation as a harmonious adjustment of individual work efforts. He defines the Cartesian view of expertise as residing in the individual in the form of tacit or explicit knowledge, skills and mental models.

The subject pole of the triad is defined as a multi-professional team. The move from individual subject to collective subject allows the consideration of specifically collective dimensions of work. Yet this perspective raises problems for a psychological approach to the activity with instrument: is the acting individual, in acting, no more than a fraction of a more global subject? We think that the notion of the collective subject must not eradicate that of the individual subject. On the contrary, it must be coordinated with it. The analysis level of the person remains fundamental in psychology, as in ergonomics and didactics, even if it must not, of course, be the only one considered. We will return to this question in the conclusions of this chapter.

Psychological approaches focused on the subject

Most of the psychological studies we referred to in the preceding chapter are based explicitly or implicitly on a triadic description of activity with instrument situations. Guillaume & Meyerson (1937) thus applied to humans the results of ten years of research done on monkeys: use of instruments among both monkeys and humans supposes real techniques in that there is an acquired art which includes delicate and precise adaptations of the hand to the tool, the tool to the object and the hand to the object via the tool. In this approach, the three poles of the triad are identified (hand, tool, object) and the different interactions highlighted, including the subject-object interaction mediated by the instrument.

For Bullinger (1987a), a distinction must be maintained between organism and subject. The organism is a material object liable to instrumental elaborations. Regardless of the child's developmental level, there is always a "subject" (however young), that organizes and directs instrumental elaborations. Between the subject and the world, there are always sensori-motor systems. Here, the three poles of the triad are the subject, the organism, particularly sensori-motor systems and the world. The operator occupies two of the poles of the triad, one as subject and the other (the instrument pole) as organism.

Of course, this is also true of Mounoud (1970) who describes the instrument as an intermediary world between subject and object (the three poles), by the fact that it associates itself with the subject's actions (subject-object interaction); actions that it transmits to other objects (subject-object

interactions mediated by instrument); because it has complementary relations (instrument-object interaction) with objects (and the context of the task) to which it applies itself.

We could hypothesize that the triadic view can be generalized because the situation corresponding to these examples concerns instruments which engage behavior that is clearly intelligent, but whose sensori-motricity (or "sensori-gestuality" according to Guillaume & Meyerson and Mounoud) occupies a large place. The triadic view of activity with instrument situations is also shared by many psychologists interested in complex cognitive activities.

Thus, in a text from 1991, Norman also analyzes what he calls cognitive artifacts based on a triadic model of activity with artifact situations (fig. 9) whose three poles are the subject, the artifact and the task.

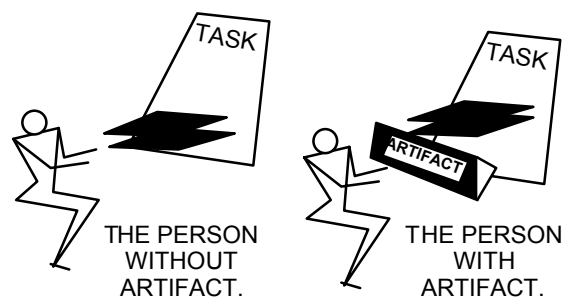

Figure 9: Norman's triadic representation (1991)

Norman distinguishes two types of possible views of these situations:

- a "system" view, which considers the subject-artifact whole as a system and examines what this system can do in light of the task which is considered as unchanged. In this perspective, the artifact is considered to amplify the system's functional capacities;

- a "personal" view, which is that of the user from whose perspective the transformations of the task are examined. These transformations of the task bring about new cognitive demands that necessitate the activation of cognitive capacities very different from those required by the original task.

Norman thus develops a hypothesis of a recomposition of the activity as a whole also using a triadic model to understand activities with cognitive artifacts. Here he joins the hypotheses of Vygotsky, who is cited in the bibliography.

An attentive reading of Vygotsky's texts reveals that he too uses a triadic conception of activity with instrument situations, even if he does not present this in graphic terms (at least in the texts to which we have access). He distinguishes three poles of the Vygotsky triad (1930): a new intermediary element, the psychological instrument, places itself between the object and the psychic operation directed at it.

We will return to his definition of the psychological instrument. Let us note only that it is by analogy with material instrument usage situations that

Vygotsky elaborates this triad. He hypothesizes a recomposition of the whole activity linked to instrument usage that leads to the emergence of the instrumental act as a pertinent analysis unit for psychology. He shows that tools and signs share a mediating function, yet indicates the limits of the analogy and their differences, particularly in the way they orient human activity (Vygotsky 1931).

A triadic approach to activity with artifact situations is also developed in the domain of process control. Hollnagel (1990) also identifies three pertinent poles: user, computer and process, while distinguishing two types of interactions (see fig. 10):

- the computer supplies the user with information on the process and at the same time "amplifies" some of the user's cognitive functions (discrimination, interpretation). The relation is one of embodiment in that a computer can be in a certain way considered as a part of the operator (Ihde 1979);

- the computer is an interpreter of communications between the operator and the application program. It is a mediator over which the operator has no control. The relation is hermeneutic. Hollnagel links this distinction to that established by Reason (1988) between tools that correspond to the amplifying function and prostheses that interpret.

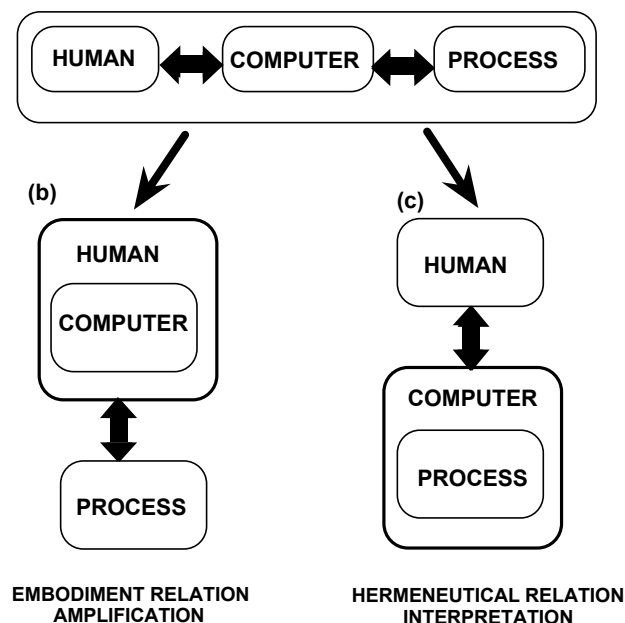

Figure 10 Hollnagel's tripolar model (1990)

Discussion on the appearance of a forth pole

An initial conclusion is that the triadic scheme is liable to a wide range of interpretations linked to viewpoints that are themselves different, though coherent in themselves. This is not at all problematic as long as these viewpoints are made explicit. The triad is very general in nature: it underlies interpretations in very different disciplines, from technology and engineering to

cognitive psychology via animal psychology, psycho-sociology and ergonomics (including cognitive ergonomics).

This generality is a very interesting feature in itself: the I.S.A. modeling that systemizes it can, like the notion of the instrument, take on the status of **intermediary concept**, facilitating inter-disciplinary dialogues as well as cooperation in action. It indicates an approach common to several disciplines whilst being interpreted and interpretable in a specific manner for each of them.

The second discussion point concerns these different interpretations among disciplines (and often also within the same discipline), without limiting ourselves to the examples that have been presented.

We feel that conceptions of the subject pole of the triad are on a continuum which runs from positions that strongly affirm the idea of a subject as carrying signification and acting intentionally in a socially finalized environment to conceptions in which the very notion of the individual or the subject seem to break down:

- either because the subject is no longer considered as a human component or factor (whose properties must be identified so they can be taken into consideration: he/she is, for example, the center of intelligent processes) in a more global system including technological components (which in some conceptions may have an equal status, for example being also the center of intelligent processes);

- or because the individual subject tends to recede before the idea of a collective subject when the aim is to identify the collective dimensions of the action.

A systematic and detailed analysis of these different positions on the human pole of the triad and their evolution in the history of ideas remains to be done. It will no doubt generate vital debates. We need only to remember Bruner's assertions (1991): a violent, anti-mentalist campaign against the notion of the agent implying that behavior occurs in the grip of intentionality in relation with desires, beliefs, moral obligations, etc., was carried out at the beginning of what can be called the "cognitivist revolution". We should also remember that the term "operator" comes from the notion of operation, which has a known status in Taylorism, even if it has taken on other meanings since then.

As for conceptions of the instrument pole¹⁵, it is enough to stress that most authors give it an intermediary, or even mediator status between the subject and the object. This implies a break with the usual bipolar models in psychology (as well as in other human or life sciences), reducing situations to a one-to-one interaction between the subject and all that is not subject: the social environment, the environment associated and even blurred into the

¹⁵ We will only vaguely develop conceptions concerning the instrument pole of the I.A.S. model here because the notion of the instrument will be more fully analyzed in the following section.

object. Yet the intermediary status concerns very different artifacts (from sensori-motor systems to signs and languages via sticks, machines, computers and expert systems) which are themselves apprehended in different ways (inert artifacts, functioning active artifacts that may be centers of intelligent processes).

The status of the object is also interpreted in a range of ways (material object, process, virtual object, object of thought or even behavior specific to the subject or other subjects). However, major distinctions common to authors of several disciplines can be identified. The first consists in identifying in the object that which has the status of object of the activity or action, i.e. what it focuses on, other aspects of reality which are significant for the activity and form the context or environment. The second concerns the type of possible relations to the object: relations of knowledge, transformation (or both) and finally of communication (particularly when the instruments are symbolic).

One of the most striking aspects thrown up by the comparison of these different interpretations of the triad is that depending on the reference situations and points of view adopted, the operator can occupy each of the three poles: he/she can of course be the subject, but also the instrument (his/her own instrument or someone else's) and even the object of an activity turned toward him/herself (by him/herself or by someone else). The different poles may be occupied by different operators or by the same person simultaneously or successively (for example in conceptions by Vygotsky or Bullinger).

Finally, contemporary technological evolutions have brought about the appearance of a fourth pole to describe the new situations linked to the emergence of software programs for collective work (groupware)¹⁶. These new types of devices are specifically oriented toward collective dimensions of work. They aim to allow and facilitate shared work. Interactions between the subject and other subjects, collaborations and cooperation are added to the usual relations between subjects, objects and instruments¹⁷. The tripolar model thus becomes a quadripolar model (fig. 11)

¹⁶ This enrichment of the instrument-mediated activity situation model owes a lot to our discussions with Yves Clot, as well as to research by Pascal Béguin (1994) to whom we will return later.

¹⁷ In a recent study (1994), Béguin lays out the important characteristics of these interactions between oneself and others via the instrument, thus performing a function of collaborative mediation to reach common goals within collective activities.

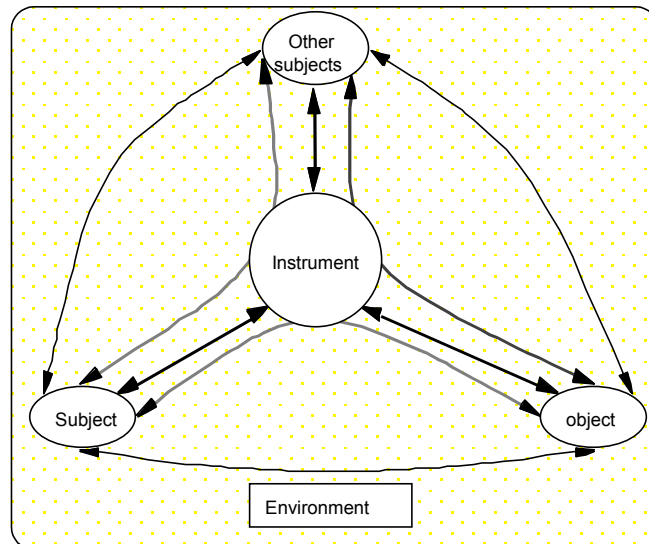

Figure 11: C.I.A.S. model Collective instrument-mediated activity situations

Our last point concerns interactions among the poles of the triad. One of them, the subject-artifact interaction, is omnipresent. Even when it seems to disappear, as in the situation where the artifact has an amplifying status, an incorporation relation (Hollnagel) remains. For most authors, there is then the artifact-object interaction. At times this may not be made explicit, particularly in situations in which the object has an internal position in the artifact (computer, process). The accent is then placed on the relation to the object, mediated by the artifact, while, for obvious reason, direct subject-object interaction disappears. This interaction may also not appear, particularly when the triad is considered from a technocentric perspective.

CHAPTER 5: POINTS OF VIEW AND HYPOTHESES ON INSTRUMENTS

Above, we explored different types of possible relations to artifacts and showed that the instrument is not a given, but rather the result of associating the artifact with the subject's action as a means for this action. Yet this perspective, whilst shared by some of the authors who have looked at instruments, is not the only one possible. Conceptions, as we have seen, vary enormously¹⁸.

First, we will present the different conceptions in light of the viewpoint we have considered as dominant, then we will put forward an overview.

¹⁸ In some cases, when this opposition is meaningful for the authors, we will differentiate between the terms instrument and tool. In all other cases, we will use the term instrument.

Technological Approaches

For predominantly technological approaches, definitions are primarily focused on function: object considered in terms of its function; functioning control devices of various organs of a machine; or on the action modalities on matter. The tools used in mechanical machining, for example, fit into three classes: cutting, sanding and deforming matter.

The terms instrument and tool most often distinguish classes of technical objects. Again using the example of machining, instruments are generally oriented toward information gathering and tools toward transformation. Yet these distinctions are not consistent and vary among domains: for example, we speak of surgical or musical instruments. The main feature of these conceptions is that they focus on technical systems and refer only vaguely or not at all, to the activity of the subject using the instrument. The user may even be ignored altogether.

A biological metaphor

The viewpoints developed by Simondon (1968 and 1969) fit into of a broader perspective, aiming to apprehend human relations with their social environment, mediated by technical objects and more generally, by techniques. He distinguishes instruments from tools by analogy with biological organs: the tool is a mediator for action anticipated by an operator possessing knowledge. It extends and adapts organic effectors. The instrument is the opposite of the tool. It extends and adapts sensory organs. It is a captor and not an effector. It gathers information, whereas the tool serves to exercise an action.

For Simondon, the tool and the instrument mark the emergence of mediation between the organism and the social environment. The primitively binary relation becomes ternary by its insertion in the medium-term. The relationship as a whole falls under the term relational function: the essence of the mediator is constituted by the coupling of organism and social environment¹⁹. For Simondon, the technical object (in its tool and/or instrument modalities) is a paradigm of the relation between living being and social environment. This conception introduces the subject but in a viewpoint that is external to him/her: as an organism and like one of the two terms of the pairing carried out by the mediator. The viewpoint remains thus primarily focused on the technical system, rather than on the subject and the biological metaphor here is revealing.

The animal's instrument as an intermediary world

Guillaume and Meyerson's research options are completely different in that they seek to analyze instrument use among monkeys and thus determine similarities and differences with human use. While Simondon's notional reference is the biological metaphor, Guillaume and Meyerson consider the

¹⁹ Simondon's approach is thus related to the functional analysis developed in technology.

instrument and different types of instruments in light of activity. From their first studies, they affirm that the instrument (a stick) is not merely an extension of the arm allowing the subject to reach a desired object. Rather, it is the means that allows the performance of the specific activity of operating a detour (for example, reaching a piece of fruit that an obstacle prevents from being attained directly).

In Guillaume and Meyerson (1931), the definition of the instrument is clarified via intermediaries linked to the object (for example, a string attached to a piece of fruit): "the simplest instrument an animal can use to pick up an inaccessible object is a material intermediary with one part, or its extremity, in the animal's field of action, and the other part joined to the desired object". This definition raises the question of the status of the mediator, or intermediary between acting animal and desired object.

However, the authors stress that it is not an instrument in the full sense of the word: a string attached to a piece of fruit can be, for the animal, no more than a long tail to pull on; the intermediaries linked to the object are thus on the level of instrumental function. Guillaume and Meyerson (1934) affirm that the true instrument is independent of the present situation, of the bait and of the objects it must be applied to: it is valid for thousands of possible situations, similar or dissimilar. In the case of the intermediary attached to the object, the link exists. It merely needs to be exploited. In the second case, it remains to be established and constructed: an object that is not currently attached to the goal must acquire a link, in certain conditions that must be understood and anticipated. The free instrument is neither a simple extension of the members, nor an extension of the object. It is an object whose properties can be seen both independently of those of members and associated with those of members.

Thus, for the animal, and it would seem for man, the instrument is a sort of intermediary world whose properties are, or can be different both from those of the body and those of the objects on which the action is exercised. In order to act efficiently, one must be able to associate these diverse properties in more or less variable situations.

For Guillaume and Meyerson, as for Simondon, the instrument is thus an intermediary world. For the former, however, it is between the subject and the world, whereas for the latter, it is between the organism and the social environment. We can only stress the extent to which Simondon's biological metaphor, used alone, is simplistic. If the instrument must indeed be considered as an intermediary world, it is not only for an organism but for a subject, a psychological and social subject all at once, who does not act in an undifferentiated social environment, but on the objects of his/her activity.

The social instrument, capitalizing on experience

Wallon's remarks (1941) are in line with this. He compares the human instrument to that of monkeys based on a viewpoint focused on activity: primitive or elaborate, banal or specialized, an instrument is defined by the uses attributed to it. It is fashioned for them. It imposes its operational mode on whoever wishes to use it. It exists durably and independently. Those who know

of its existence can mobilize it when they need to. The instrument is a constituted object, an object constructed following certain techniques in light of other techniques and the reworked product of traditional or recent experiments, the fruit of which is transmitted by those who use it.

According to Wallon, this strong individualization does not apply to the chimpanzee's instrument. It is not only occasional, but a simple part of a provisional whole from which it takes all its signification. If the stick the chimpanzee uses to bring a piece of orange or banana toward itself is not perceived exactly when it attempts to reach them, it will remain useless and ignored. The animal's instrument is only an instrument in so far as it is perceived, and it is perceived only when it is dynamically integrated into the action.

Here Wallon affirmed more than he could prove and even contradicted the last affirmations of Guillaume and Meyerson (1937) who had identified in some cases behavior that retained the instrument. Yet we find in Wallon's research an idea also developed by Vygotsky and above all, Leontiev, of a capitalization of acquired experience in the human instrument and thus, a possible transmission of this cultural capital. The instrument is not only an intermediary world and a means dynamically integrated into the action, it is also capitalized experience and knowledge.

For Leontiev (1975, 1976), the instrument must be considered as a carrier of the first real abstraction: in direct subject-object interaction, the object's properties are only revealed in the limits of the subject's sensations, whereas in the interaction process mediated by an instrument, knowledge goes beyond these limits. Thus, when we fashion an object with another object, the deformation of one of these objects leads us to deduce that the other is harder. A practical analysis is thus carried out and the properties of objects on which we act using the instrument following criteria objectified in the instrument itself is generalized.

For Leontiev, instruments are the means of human activity. The origin of this activity must be sought in work. An instrument cannot be considered outside its connection with the goal. Otherwise, it becomes abstract (in the critical sense of the term in this case) in the same way as an operation considered outside its connection with the action it carries out. The instrument-goal relation is thus considered as constituting the very notion of the instrument.

We will not come back to hypotheses relative to the crystallization of experience in instruments and the social process of appropriation by which it is transmitted and which make the instrument a material precursor of signification. We will merely highlight that what is central for Leontiev, as for most of the authors mentioned above, is the subject. Yet the subject is not locked into a solipsistic relation with instruments and more generally with artifacts: the individual's relations with the world of human objects are mediated by relations with other people.

This is why he criticizes attempts to cast aside perspectives focused on the human subject: "we attribute properties of authentic subjects of thought to

thinking machines of our era. We thus present things as though it were not machines that were the instrument of human thought, but humans as instruments of machines."

From the material instrument to the psychological instrument

In this, Leontiev joins Vygotsky (1930, 1934) who developed a generalized psychological conception of instruments focused on the subject. For Vygotsky, instruments allow not only the regulation and transformation of the external social environment, but also the regulation, by the subject, of his/her own behavior and the behavior of others.

Language, signs, maps, plans and diagrams are considered as psychological instruments that mediate the subject's relationship with him/herself and with others. The psychological instrument is thus differentiated from the technical instrument by the direction of his/her action turned toward the psyche. The integration of the instrument into the behavioral process calls upon new functions linked to the control of the instrument, replaces "natural"²⁰ processes performed by the instrument and transforms the order and particular aspects of the psychic process. These processes occur within a complex structural and functional unit: the instrumental act.

The viewpoint developed by Vygotsky consists in both distinguishing instrument types based on what they allow the subject to act on (the material world, his/her own psyche or that of others) and proposing an analysis unit of instrument-mediated activities: the instrumental act.

The instrument is thus doubly apprehended in terms of the subject. Yet Vygotsky's approach is interesting not only because of the association of notions of instrument and instrumental act. It is even more fundamentally linked to the very notion of the psychological instrument by which the subject controls and regulates his/her own activity. The psychological instrument, which may have an existence external to the subject, also has an internal existence that allows the subject to manage him/herself by him/herself. Thus semiotic instruments (language, maps, etc.) are not only instruments of knowledge (cognitive instruments according to certain authors, see p 75). They are also psychological instruments.

The instrument as indicator of child development

For Grize (1970) who wrote the preface to Mounoud's study, the instrument also has a psychological content: it is knowledge and participates in both the object pole and the operational pole due to its intermediary status. Yet if the instrument is knowledge, this point of view differs from that of Wallon, Leontiev or Vygotsky who considered it to be capitalized, crystallized knowledge that is the fruit of acquired experience transmitted via the instrument. Grize's instrument reflects the epistemic state of development of

²⁰ A simple example is a knot in a handkerchief to remind us that we have to do something.

the child, thus following the child's conception of the instrument means following the evolution of his/her knowledge.

This is precisely what Mounoud (1970) aimed to do in seeking to identify conceptions of instruments specific to each age. He defined the instrument as any object that the subject associates with his/her action to carry out a task. The instrument extends and/or modifies this action and has characteristics that are simultaneously associated with the subject's actions and the objects to which it is applied.

Mounoud's definition sums up in part, beyond his own studies, the research carried out by his predecessors (particularly Guillaume and Meyerson)²¹. Based on this initial definition, Mounoud distinguishes two categories of instruments: those which transmit subjects' actions without transforming them and those which transform them by inversion, reduction, etc. The instrument is thus an intermediary world between subject and object: it associates itself with the subject's actions; it maintains relations of complementarity with the objects (and the context of the task) that it applies itself to; and finally, it replaces some of the subject's actions in carrying out their functions.

For Mounoud, the instrument is simultaneously content in terms of the subject's action and form in terms of the objects it is applied to. Instrumental behavior thus introduces several forms of dependency: between the subject's action and the instrument's movements (hooks, poles, angle rods, etc.), between the instrument's properties and the device, between the various parts of the instrument, etc.

While Mounoud sees the instrument as an intermediary between the subject and the object, the object is exclusively a material object on which transformations are performed. In this, his conception is similar to that of Simondon who considers the instrument as a mediator. But for Mounoud the subject remains the main point of reference. It is in terms of the subject that the instrument is defined, i.e. the means that the subject associates with his/her action. This is an essential difference from Simondon who refers primarily to the technical system and its coupling with the organism and social environment.

Finally, in the conclusions of his experimental research, Mounoud stresses that for subjects, instruments are classes of equivalence: they both satisfy conditions that make them equivalent in terms of experience. Mounoud distinguishes between the extension of the instrument (its ability to adapt to all sorts of situations) and understanding (of the instrument's properties). The

²¹ For many authors, Mounoud's definition is a departure point for their own reflections. Leplat and Pailhous (1973), for example, start with Mounoud's definition of instruments as intermediaries with their own functioning rules and develop an analysis frame of intellectual activity in work on instruments concerning, in particular, representation and handling systems constructed by operators. Also starting with Mounoud's definition, Guillevic (1990) examines the cognitive appropriation of the tool as a condition for reliability in technology transferring situations. The appropriation concerns all the internal processes activated in the subject in these situations. He too considers the tool as a mediator between the operator's action and the workplace.

evolution of the instrument with genetic development occurs via a reduction of extension and an increase in understanding.

The semiotic instrument

We also find the idea of classes of equivalence in Prieto (1975) who describes the class that makes up a particular tool and all others with the same use (i.e. those that allow the same operations to be performed) as "operants". From 1966, Prieto, a semiological researcher, considered semiotic systems as instruments. We can only be struck by similarities with Vygotsky, to whom he had no access (a collection including a text by Vygotsky on the instrumental method was only translated into Italian in 1974).

For Prieto, the instrument confers the possibility of acting on the outside world. This is its *raison d'être*. It is produced deliberately so as to carry out certain determined operations. It provides classes of objects, i.e. concepts and classes of operations that are also concepts. Instruments whose function is to transmit messages are signals. They allow an influence to be exercised over that which surrounds people. Like any instrument, signals supply people with concepts constituted by their respective signifieds.

In a text from 1975, Prieto uses the word tool to describe what he previously called an instrument: the individual object that in the instrumental act (i.e. the execution of any and every operation) plays the same role as that played by the signal in the semiotic act. He reserves the term instrument to designate the entity constituted by an operant (the class formed by a determined tool and all those with the same use) and the corresponding use.

Despite similarities in vocabulary, Prieto's approach is thus very different from Vygotsky's. His analysis is almost technical: he analyzes the instrument as such independently of the way it exists for the subject (the interiorized instrument) and the activity he/she undertakes so as to use it. Clearly, he is not interested in the subject's global activity into which the use of the instrument fits. This type of analysis is necessary in order to know the "objective" properties of semiotic instruments (just as a technical analysis of machines reveals their technical properties), but it is insufficient for both psychology and ergonomics, both of which are concerned with the interiorization of these properties and the insertion modalities of instruments in activity.

The main difference between Prieto and Vygotsky lies here. It is particularly apparent in their divergence on the point of the main action: for one, it is the subject's control of him/herself and others, for the other, the transmission of a message (even if both also envisage another pole). Finally, Prieto does not seem to contemplate the full recomposition of the subject's activity in and by the instrumental act.

The specifically psychological dimension thus escapes Prieto (who has no ambition in this field). Yet the positive feature of his approach is that via a systemization of concepts, he gives weight to the analogy, hitherto a little metaphorical, between material and semiotic instruments. He thus allows the generalization of essential ideas in semiology: the idea that every instrument, like every sign, is a bifacial entity. This idea is shared by authors interested in

problems as diverse as the writing of users' guides for instruments of daily life (Legrand, Boullier & al. 1991) or the construction of psycho-semiology (Cuny 1993)..

Cuny (1993) focuses on the subject and more specifically the subject engaged in action. He defines semiotic tools²² as objects whose role is to provide information and which are part of the user-task system typical of every work situation in participating in determined operations within which these semiotic tools are functional. Like all instruments, they are indissociable from techniques and the operational modes that allow them to be activated.

Cuny thus shares criteria developed by Leroi-Gourhan (1964) for whom the instrument only really exists as a gesture that makes it technically efficient. Proposing a standardized semiotic tool means presuming the adoption of a determined use technique. On the other hand, looking at the semiotic tools of experienced professionals means discovering products integrated into actions, adjusted to semiotic needs in the evolution of the task-operator relation.

The semiotic instrument assists the operator's cognitive activity by providing information that is useful to action and by guiding the order of the operational sequences. Here, we are close to some of the characteristics of Vygotsky's psychological instruments, including the idea of the semiotic act (Cuny 1981a) which is the equivalent of that of the instrumental act²³. The learning process for a semiotic tool (for example, the electricity schema, Cuny 1981b) cannot be finalized in a purely intrinsic manner: "we do not learn the reading and writing of schemas for themselves but so as to insert them into an operational process". The author's objectives for the psycho-semiology he elaborates are: the analysis of problems of elaborating semiotic instruments, learning to handle them, and beyond this learning, their potential use and functions.

Tools and cognitive instruments

The notion of the cognitive tool developed by Rogalski and Samurcay could seem close to these conceptions. It differs however on important issues. Rogalski (1993) defines the features of her conception of cognitive tools. They are artifacts, objects external to the subject, that result from a social elaboration process and which integrate knowledge (these tools are thus cognitive in nature). Artifacts such as tables of digital data, abacuses, calculators, software tools as well as problem solving methods are cognitive tools.

This is similar to a definition given by Norman (1992) for the notion of "cognitive artifact": an artificial device designed to preserve and present information or process it so as to insure a representative function. Rogalski &

²² In his first studies, Cuny used the term semic tool. We will use here the term semiotic tool whose use is more widespread today.

²³ These instrumental characteristics, oriented towards guiding the activity, were evoked by Ombredane and Favergé as far back as 1955.

Samurcay (1993) insist on the operative nature of the cognitive tools that assume part of users' cognitive activity and thus contribute to performing the task²⁴.

Here we come across an important and old idea: every instrument, tool and machine performs a job and serves the person who implements it (but generally in a professional context, he/she is not the only one to benefit). Taking on part of the cognitive activity often implies a transformation of the subjects' initial representations of the objects of their activity. Thus in the examples given by the authors, the control of forest fires and the operation of blast furnaces, the use of cognitive tools requires the construction of new mental representations of the process coherent with those underlying and constitutive of the instrument.

Unlike Vygotsky's psychological instruments, they are not instruments used by the subject to manage him/herself. Rather, they are tools oriented toward knowledge (usually anticipatory) of objects from reality, external to the subject and toward which his/her (diagnostic, decisional, transformational, etc.) activity is oriented. Furthermore, the collective dimensions of the activity are important here and as Hutchins stresses elsewhere (1990), instruments are not only placed in a context where the operator is isolated and limited to interactions with the tool, in his/her private world.

In a study on collective activities in navigation, Hutchins suggests considering that instruments, along with social organization and members of a collective, form a system of distributed cognition. This supposes not only, as for Rogalski and Samurcay, that instruments carry out part of the cognitive work, but that they are "open", i.e. do not render the work invisible so as to allow both a collective realization and the acquisition and transfer of competence.

However, based on examples and certain hypotheses described as "traditional", Hutchins rigorously questions the nature of the cognitive assistance provided by instruments. For Hutchins, external cognitive instruments that are truly useful to subjects, should not be considered primarily as "amplifiers of information processing capacities", or as "intelligent actors" interacting (cooperating) with operators. According to Hutchins, cognitive tools are good operational aids when they transform the subject's task to give a formulation or representation that is easier for him/her to process. The cognitive capacity of a user-intelligent machine system would thus not depend primarily on the machine's processing capacities but rather the relation between the subject's own resources and the assistance modalities offered by the machine.

In the author's conclusions, this position could move towards the "activity aid systems" perspective developed by Falzon (1989), even if the premises are very different. This hypothesis differs however from that of Reason (1987,

²⁴ The authors' terminology has recently changed in favor (1994) of the term operational cognitive tool, which places greater emphasis on the characteristics they feel are essential.

1990): Reason sees the elaboration of cognitive prostheses (or even mental crutches) as the only possible immediate remedies to the problematic situation created by systems designers. He feels that the systems designed today (and which will continue to be operational for a long time to come) have transformed normal adaptive characteristics of human cognition into dangerous responsibilities. The context of this pessimistic reflection is that of heavy processing industries (chemical, nuclear, etc.) in which the potential consequences of human error are so huge that the "prosthesis" solution seems to him to be the most appropriate.

Nonetheless, the prosthesis solution has major drawbacks as Roth, Bennet & Woods (1987) demonstrate based on experimental data.)

The widespread paradigm of designing expert systems as prostheses aims to produce systems which compensate for human deficiencies. The operator's role is reduced to being a data supplier to the machine. The machine directs the problem solving process and defines the observations and actions that the user must carry out. In this type of user-machine interaction, the machine is in control and the user has a passive role. However, the experiments carried out by these authors indicate that the more the users conform to the passive role of data suppliers, the greater the degradation of the user-machine system.

The authors thus propose an alternative to the "prosthesis" paradigm: an instrumental conceptualization of cognitive tools. Cognitive tools must be conceived as instruments at the subject's disposal so he/she can resolve a problem. The cognitive tool plays the role of a consultant, a source of information for the subject who directs the problem solving process. The user's role is to watch over the performance of the user-machine cooperation as a whole in managing the range of cognitive resources at his/her disposal. The user is in control.

Roth, Bennet & Woods, like Rogalski & Samurcay, Hutchins or Falzon, insist on the primacy of the subject's activity. It is this activity that must organize the interaction with the cognitive tool, which supposes that the subject controls it. This position founds the instrumental paradigm alternative to the prosthesis paradigm.

Thus the necessity of an instrumental point of view on artifacts is raised, even when these artifacts are based on the most contemporary technologies such as artificial intelligence.

Summary: the instrument as mediator, knowledge, operant and means of action

Conceptions of the instrument that we explored above are very diverse and at times contradictory. Nonetheless, we will now attempt to extract the main features in order to reach an initial summary of the notion of the instrument.

First of all, an instrument is unanimously considered as an **intermediary entity**, a medium term, or even an intermediary world between two entities: the subject, actor, user of the instrument and the object of the action.

Here we find the three poles of the triad we analyzed earlier. These poles are considered in a range of ways by our authors. For the actor, conceptions are on a continuum and range from the organism (the living) to the subject as an intentional, oriented, socially situated actor. Conceptions of the object are also on a continuum and run from the idea of the object as an environment or social environment to the idea of the object of the activity (the object could be the subject him/herself when the instrument allows him/her to manage his/her own activity).

The instrument's intermediary position makes it the mediator of relations between subject and object. It constitutes an intermediary world whose main feature is being adapted to both subject and object. This adaptation is in terms of material as well as cognitive and semiotic properties in line with the type of activity in which the instrument is inserted or is destined to be inserted.

Two main types of mediation are identified:

- a mediation from object to subject that we describe as an **epistemic mediation** in which the instrument is a means allowing knowledge of the object;

- a **pragmatic mediation** from subject to object in which the instrument is a means of a transforming action (in a broad sense including control and regulation) directed toward the object.

Yet as soon as this mediation concerns a real activity, the epistemic and pragmatic dimensions of the mediation are in constant interaction within this activity.

The instrument is thus not only an intermediary world. It is a **means of action** and more generally, of activity. This is the second feature. Actions are of course very diverse in nature:

- transformation of a material object with a hand-held tool: **material instrument**;

- cognitive decision making, for example in a situation of managing a dynamic environment: **cognitive tool**;

- management of one's own activity: **psychological instrument**;

- semiotic interaction with a semiotic object or with others: **semiotic tool**²⁵.

²⁵ Clearly, definitions of these different "types" of instruments do not define disjointed classes: a semiotic instrument, for example, can allow cognitive decision making (cognitive tool) or contribute to handling one's own or other people's activity (psychological instrument) In fact, one device can

Within the action, the **instrument** is an operant. It is operative in that it takes care of part of the task: it does a job. The nature of this job and what it concerns are obviously related to the objects of the activity and as such, are extremely variable.

The instrument is a specific, situated means of action but it has a much more general aspect. Beyond the specificity of the present, it is pertinent for a class of actions and situations. The instrument is thus simultaneously in a relation of adaptation and independence to the present situation. Some authors even make this independence a criterion for the difference between the human instrument and the animal instrument. The subject thus associates the instrument with his/her specific action, which is dynamically integrated into this action. It is also retained so it can be reused in future situations belonging to the same class or classes. It thus allows durable recompositions of the activity, which are organized into instrumental acts.

Through this preservation, the instrument is a means of **capitalization of accumulated** (some authors say crystallized) **experience**. In this sense, **every instrument is knowledge**.

The knowledge in question is inscribed during design processes and also accumulated by and through a range of situations and uses. From this point of view, an instrument can be considered as a modality of external fixing of acquired human knowledge. A subject may appropriate this knowledge by an adequate activity that must be developed in an appropriate manner²⁶ and, of course, may be elaborated with the help of other subjects (one of the forms of mediation for Vygotsky and Leontiev).

This knowledge is also specific to the subject and characteristic of the forms and modalities of the subject-object relation. It reveals these forms and modalities and as such is a source of possible observables for the psychologist or ergonomist. Knowledge is capitalized both in transformations of the material device that constitutes the artifact and in associated uses.

The instrument is thus, like the sign, which for some authors is merely an individual case, a bifacial and mixed entity of both artifact and use mode, these two dimensions being fundamentally indissociable. From 1965, Leroi-Gourhan considered the tool to be associated with what he calls "mechanical operational chains" acquired by experience and upbringing. He considers that while psychology can apprehend this, it is not pertinent to his own anthropological approach.

CHAPTER 6: THE INSTRUMENT AS A MIXED ENTITY

fulfill a range of functions in the subject's activity. It can be said that there is a synergy of instrumental functions.

²⁶ In order to be truly adequate, this activity supposes that the subject has a perspective allowing him/her to appropriate knowledge.

In the following chapter, we will develop a psychological point of view of the instrument as a mixed entity. We define the instrument as a whole incorporating an artifact (or a fraction of an artifact) and one or more utilization schemes. Yet before giving a psychological definition of the instrument on these grounds, we will examine the concept of scheme based on Piaget's approach. For Piaget, an action scheme is the structured group of generalizable features of the action that allows the same action to be repeated or applied to new contents²⁷. We will then examine the concept of the utilization scheme.

From artifact to usage: utilization schemes

An artifact is not a finished instrument. The tool only exists in the operating cycle, affirmed Leroi-Gourhan as early as 1965. The artifact remains to be inscribed in use, i.e. in activities in which it is a means activated to achieve goals that the user sets him/herself. While these uses are partly anticipated by the artifact's designers, they exceed, sometimes considerably, these expectations. The elaboration and production of uses continues beyond the initial design as private and social production.

We have many examples, such as the use made of photography specific to different social groups identified by Bourdieu (1965) or the unexpected uses of Minitel (chat-lines, sex-lines, etc.). The object, the artifact, the system itself, initially the recipient of a social insertion plan, is in fact inserted into practices that are often different in terms of context and usage finalities (Perriault 1990).

The banal example of the range of real uses of an object as theoretically specific as a hair dryer demonstrates this: drying clothes, defrosting a lock, or even heating a room. However, behind this diversity, we can find relatively stable and structured elements in the user's activities and actions. We have suggested defining them as utilization schemes (Rabardel & Vérillon 1985, Rabardel 1991b)²⁸.

Let us take an example borrowed from a study carried out at the *Laboratoire Nationale d'Essai*. During the testing the use of an electric train set, on several occasions the children behaved in a way that placed them at great risk. They tried to introduce electrical low voltage wires into 220-volt sockets.

The authors conclude that the children's ignorance, the presence of electrical wires and the desire to make the device work are behind this

²⁷ As Montangero and Maurice-Naville (1994) indicate in taking the example of prehension, the scheme is not the particular sequencing of movements and perceptions. It is the general backdrop, which can be reproduced in different circumstances and generate a range of productions. For example, the arm is held out at varying angles and the hand more or less opened depending on the distance or size of the object to be picked up. Whatever the object, the prehension scheme is always the same.

²⁸ Guillevic's research (1990), on cognitive appropriation of the tool in a situation of technology transfer also reinforces the idea of the tool's integration into the subject's scheme.

dangerous utilization. We propose a complementary hypothesis that this group of elements (electrical train, wires, sockets) activates a pre-existing "electrical plugging in" scheme among the children. They assimilate the artifact into this scheme forthwith²⁹. This assimilation is both pertinent (it is indeed an electrical plugging in situation) and dangerous in that the child is faced with a range of possible sockets but does not dispose of criteria to choose correctly.

A second example allows us to highlight a situation requiring scheme adaptation. It concerns the type of accident that occurred in the United States when microwave ovens were introduced: a user places a pet in the microwave with the horrible consequences we can imagine.

This accident can be interpreted as an assimilation of a new type of artifact with an elaborated scheme in using an artifact of neighboring usage but with a different functioning rationale. This scheme is based on a use of ovens enlarged to encompass other uses than cooking food. The heating properties of traditional ovens are used to dry objects (such as wet shoes). In cooking with microwaves, *a priori* nothing obliges the user to proceed in a new way. He/she thus assimilates the object to the already constituted scheme. When living creatures are concerned, this assimilation is disastrous. This scheme needs to be adapted on the representation level in terms of heat-generating modalities within the new artifact, i.e. in terms of phenomena causality.

These two examples illustrate the association of utilization schemes and how they assimilate and adapt to artifacts. This association is sometimes so powerful that it cannot be undermined. Thus, all attempts by car manufacturers to change the position of brake or accelerator pedals have failed: in emergency situations, drivers act as if the changes had not occurred³⁰. In order to define the concept of the utilization scheme more precisely, we will now examine, based on the literature, the Piagetian notion of scheme and its contemporary evolutions³¹.

²⁹ Along with Norman (1988, 1992), we can consider that the perceptible elements of the situation call for a certain type of usage or implementation of artifacts. He uses the term "affordance" to describe this type of phenomenon.

³⁰ Let us look at a similar example dating from the start of the 19th century (1801). We will borrow this example from Garneray (1985). On a slave transporting ship, the captain had swapped over the commands at the helm to make more room for the human cargo. Apparently, the men at the helm became used to this new device which was thus adopted. However, during a storm when the ship's survival depended on the precision of a maneuver to be executed immediately, the sailor moved the tiller in the wrong direction and the ship was lost.

³¹ Several notions have been put forward based on different theoretical frames to define the invariants that structure activity and action. This is true of notions of schema, frame, script, scenario, or model proposed by Rasmussen (1983, 1986). We consider them as possible contributions to the definition of what we have chosen to theorize based on a Piagetian framework. This choice allows us to account for the dimensions of the instrumental genesis revealed in empirical research (Rabardel 1991d, 1992 a, Vérillon 1988 c, 1991). We feel it is heuristic for a developmental approach to relations to artifacts. An examination of the literature indicates that this appears necessary to many researchers today: Bodker (1989 & 1991), Engeström (1991), Henderson (1991), Henderson & Kyng (1991), Norros (1991), etc. We need to account for users' production of uses as well as the development of their competence, and elaborate a conceptualization of design processes

Scheme, schema... a nomadic concept

The notion of scheme and related notions (schema, script, scenario, etc.) appear in a number of theoretical frames, not only in cognitive psychology but also in other disciplines such as artificial intelligence, psycholinguistics or social psychology. Furthermore, reciprocal influences among these research fields ensure that these notions and concepts get around³².

Thus the idea of the frame, sometimes used by Piaget in association with that of scheme, and even locally as a synonym of scheme (see, for example Piaget 1936a) was put forward by Minsky (1975) in the field of artificial intelligence after a trip to Geneva. Since then, this idea has been reconsidered by psychology based on this new usage and associated theoretical evolutions.

But the concept of scheme dates back even further. Hoc (1986), for example, quotes as well as the Piagetian notion, the goal anticipation schemes by Seltz (1924) and schemas by Bartlett (1932). Eysenk & Keane (1990) do not hesitate to cite Kant. This concept continues to evolve under the influence of studies in Geneva and more generally, among those whose research aims to capitalize on the scientific progress born of the Piagetian paradigm (Cellérier 1979, 1992, Boder 1982, Bastien 1987, Vergnaud 1990 a & b, etc.) and also in relation with artificial intelligence and psychological theories linked to the information processing paradigm.

Several authors have already carried out analyses of different types of conceptions that intersect and sometimes collide over the notion of scheme, particularly Cellérier (1979 a & b), Hoc (1986), Bastien (1987), Hoc & Nguyen Xuan (1987), Fayol & Monteil (1988), Richard (1990) and Eysenk & Keane (1990). We refer readers to these studies and content ourselves with summing up the main features, in focusing particularly on aspects that we consider pertinent in an instrumental perspective.

The concept of scheme is absolutely central in Piagetian theory, yet in the 1960s, although the essential properties of schemes were defined, the concept was insufficiently formalized to satisfy programmability criteria for computer systems. This is one of the reasons, as Cellérier (1979 a) reminds us, of its rejection in the Piagetian form by part of cognitive research born of the information processing approach.

Thus Moore & Newell (1974 a) consider that assimilation and adaptation concepts and theoretical notions like that of the scheme are insubstantial in computer terms. Related conceptualizations aiming to satisfy computer criteria were thus developed and during the same period, other authors sought to bring together conceptualizations born of Piagetian theory and that of information processing: Pascual-Leone & al (1978), Fischer (1980), Cellérier

that allow an understanding of users' contribution to design and facilitate acknowledgement and integration of this by design professionals.

³² In the evocatively titled work "From one Science to Another: Nomadic Concepts", Stengers (1987) unfortunately does not look at the concept of the scheme, despite its long and itinerant history.

(1979 a & b, 1987), Cellérier & Ducret (1992 a & b) in particular. For the first two, we refer to Bastien (1987) who presents a detailed analysis. We will also develop Cellérier's propositions (which also influenced Bastien) as they seem particularly interesting from our standpoint. The Geneva researchers continued their work around Inhelder and Cellérier inspired by the renewal offered by the latter. We will come back to this. Finally, theoretical elaborations were developed in relation with the acquisition of scientific knowledge (for example Bastien in 1987 or Vergnaud 1990 a & b). We will also come back to this.

Attempts to formalize the scheme concept in the frame of the information processing paradigm produced several notions that are often very similar to one another as Hoc (1986) indicates.

Minsky (1975) seems to be the first to have attempted a formalization of the declarative aspects of the scheme in the domain of form recognition. Purely ascendant undertakings (directed by data) for the analysis of a geometric configuration turn out to be fairly inefficient. The author proposes activating knowledge on the invariants of common structures (prisms, etc.). These invariants, called "frames", once called upon constitute waiting or hypothesis systems to recognize the stimulus presented. Applying the frame consists in particularizing the schematic description given by the frame.

Most authors formalize schemes in the same way as relational systems between variables to be particularized (assimilation)³³. Hoc & Nguyen-Xuan (1987), consider that frame, script and schema concepts are the same. They are a reference for interpreting new data. The reference frame can be an event, an object or a concept: it is always generic knowledge constructed via a certain number of experiences. A frame is a structure of variables. Interpreting new data means specifying the values of the variables.

The most important properties of frames are:

- inference by inheritance: "specific case of" relation (e.g. restaurant = specific case of commercial establishment);
- understanding directed by concepts: inference of non-perceived data that can lead to an orientation toward another frame if incoherence is observed between frame hypotheses and data;
- representation of procedural knowledge: there are variables to which are attached specification or problem solving procedures;

³³ Moore and Newell (1974) put forward a beta-structure for very new objects allowing a vaguer assimilation by analogy. For Schank and Abelson (1977), schemes are formalized in the form of scripts corresponding to a stereotyped sequence of events, which explains difficulties in treating unfamiliar situations. Schank (1980) put forward a hierarchical organization in MOP (Memory Organization Packet) constructed by abstraction and generalization based on scripts. The information memorized from a specific script is limited to that not belonging to the highly ordered MOP. For Sacerdoti (1977) a plan is a schematic representation corresponding to a breakdown of the structure of the goal in the preceding stage, in line with the introduction of constraints or general heuristics.

- interlocking of frames: a variable can be a frame.

Most formalizations of the notion of schema deal with relations between declarative and procedural knowledge. The assimilating schema that serves understanding contains procedural attachments allowing the treatment of data that has particularized the schema. According to Hoc (1986), these formalisms only deal with limited aspects of the assimilation-adaptation mechanisms but allow the reintegration of understanding in problem solving³⁴.

As Hoc (1986) stresses, the definitions given by artificial intelligence appear more precise and more operational in a context of constructing the most efficient possible technical systems. This however, is not the aim of cognitive psychology, which aims at constructing valid models for broad classes of situations, as the author reminds us.

Indeed, the schema concept is not a simple formalization of the scheme concept as Richard (1990) demonstrates. Nonetheless, action schemes and schemas are similar in several essential ways:

- the scheme is reproducible: it contains recognition conditions for the situations it applies to. The action scheme also contains information concerning its application conditions, which constitute prerequisites for its sub goals;

- the scheme assimilates: it applies itself to new situations. The action scheme can also allow generalization to other situations by analogy;

- the scheme is teleological in nature, which gives it a control system and allows it to assign functional signification. The schema also contains information on the goal, which is at the heart of functional meanings that make up the functionality network.

But for the author, the major difference is that the scheme does not constitute declarative knowledge. It applies itself autonomously and does not need an action programming mechanism like the action schema. On the other hand, action schemas are declarative knowledge whereas procedural knowledge particularized for certain contexts is, like schemes, directly operational and immediately executable. Richard thus thinks that the Piagetian notion of scheme must be broken down into several notions to disassociate them from inference and evaluation schemes.

Our aim is not to feed the theoretical debate around the notion of scheme but to define utilization schemes to construct a psychological definition of the instrument. However, we feel that some of the evolutions in the notion of scheme put forward by the Geneva researchers tend towards a differentiation of the notion that seems necessary to Richard. We are particularly interested in the distinctions between presentative and procedural schemes, the schematic specification process described by Inhelder & Caprona (1992),

³⁴ It is on these grounds that Richard (1990) defines comprehension: it results from the particularization of a schema.

between familiar and unfamiliar schemes and procedures put forward by Boder (1992), and the different meanings of familiar schemes: routine, primitive, procedure, analyzed by Saada-Robert (1985, 1989, 1992).

The current orientation of the Geneva school's research, which now focuses on studying the functioning of the psychological subject in problem solving and action situations rather than the structures of the epistemic subject is at the origin of these developments. We will present the essential aspects but first, we will explore the notion of scheme developed by Piaget.

Piaget's notion of the scheme

For Piaget (1936a), who analyzed the birth of intelligence in its sensori-motor dimension³⁵, schemes constitute means that allow the subject to assimilate the situations and objects with which he/she is confronted. They are the structures that prolong biological organization and share with the latter an assimilating capacity to incorporate an external reality into the subject's organization cycle³⁶: everything that meets a need is liable to be assimilated.

The scheme, means of assimilation, is itself the product of assimilating activity: psychological assimilation in its simplest form is only the self-preservation tendency of all behaviors. It is reproductive assimilation that constitutes schemes. These schemes come into existence as soon as behavior, however simple, gives rise to a repetitive effort, which schematizes it. The action scheme is thus a structured whole of generalizable action characteristics, i.e. those which allow the repetition of the same action or its application to new content (Piaget & Beth 1961).

The scheme is an active organization of first-hand experience that integrates the past. It is thus a structure with a history and is progressively transformed as it adapts to a wider range of situation and data. A scheme is applied to the diversity of the external environment and is generalized in line with the contents it is applied to. The history of a scheme is that of its ongoing generalization as well as that of its differentiation:

- schemes, once constituted, serve as instruments for the organizing activity. They allow the subject to assign goals to actions, to be the means of these, and to attribute a signification to experiences. New objects assimilated by schemes thanks to their similarity of appearance or situation are thus attributed meanings, as they in turn contribute to the extension of these meanings and the formation of new signification networks;

- schemes adapt to external reality which they have difficulties assimilating and they also adapt to other schemes. Adapting is one of the sources of progressive differentiation. The other source is the application of a range of schemes to one object. Adaptation, reduced to a simple overall

³⁵ Piaget also calls intelligence practical sensori-motor intelligence.

³⁶ Later, Piaget spoke of self-organization. See, for example, 1974 a & b.

adjustment in the first months of life, then gives rise to directed explorations and more and more precise experimental behavior.

The evolution of schemes, and the subject, thus follows two complementary processes: one incorporates things into the subject, the assimilation process; the other is adapting to things themselves.

Every scheme constitutes a whole, i.e. a group of mutually dependent elements that cannot function without each other: they are mutually implicated. This is the overall signification of the act that insures the simultaneous existence of relations that constitute the schemes as a whole.

Although they originally make up isolated wholes, schemes coordinate themselves by reciprocal assimilation into new, original and broader wholes that also have shared properties. Thus, in a small child, the coordination of several schemes is a unique act resulting from the need to attain a goal not directly accessible via an isolated scheme. This implies the mobilization of schemes hitherto relative to other situations and their coordination resulting in the formation of a main action scheme incorporating a more or less long series of subordinate schemes.

Let us look at an example in Piaget's observations (1936a) in which he analyzes the birth of intelligence. He analyzes the acquisition of the use of a stick in young children (just over one year old). The child is sitting opposite a sofa on which is placed a small jug she wants to pick up. Next to her is a stick that she played with in the preceding weeks, hitting the ground and objects. She first tries to reach the jug directly, then picks up the stick and hits the object with it. By chance, it falls. A little later, the jug is on the floor (and thus cannot fall). She hits the jug again with the stick and watches the movements attentively. She progressively starts pushing the jug with the stick and ends up bringing it within her reach. Finally, in another situation in which no stick is available, she picks up a book to use it like the stick and tries to bring the desired object into reach.

Thus the child initially tried to use an already constituted scheme (hitting with a stick) but this assimilation of the situation does not allow her to succeed each time. The scheme will thus be progressively adapted so as to manage the movement of the object until a new scheme is formed: pushing with a stick. Finally, this scheme is extended to other objects, in this case, a book. The new behavior formed is finally underlain by a main scheme that incorporates a series of schemes: picking up a stick, pushing with the stick, picking up the desired object.

This pedagogical example should not imply that schemes only concern sensori-motor activities. For Piaget, schemes are also at the origin of concept formation, as indicated by a series of studies on awareness and differentiating between "succeeding" and "understanding" (Piaget 1974 a & b). In his research on awareness (1974 a), he stresses that at first, only two elements of the action are conscious: the goal and the result obtained. The first depends on the assimilating scheme in which the object is inserted and the second depends on the object itself. Awareness of means emerges based on the object's observables, i.e. analysis of results. Reciprocally, the analysis of

means, or the action's observables will provide the subject with essential information on the object and gradually, the causal explanations of his/her behavior.

Thus Piaget sees the awareness mechanism as a conceptualization process that reconstructs, then moves beyond (on the level of semiotization and representation) what was acquired to that of action schemes.

For Piaget, action alone constitutes autonomous knowledge of considerable power. Although it is only know-how and not conscious knowledge in terms of conceptualized comprehension, it is nonetheless the source of conceptualized knowledge.

He distinguishes three stages of evolution of the action in genesis:

- the first is that of the material action without conceptualization but whose schemes system already constitutes elaborated knowledge. It is at this level that initial instrumental behavior is constituted;

- the second is that of conceptualization taking its elements from action through becoming aware and interiorizing them as semiotized representations (language, mental images, etc.) but in adding what is new in the concept;

- finally, the third phase (occurring at the same time as formal operations) is that of the considered abstractions operators form based on preceding operations.

At each of these three stages a series of coordinations is progressively constituted by reciprocal assimilation of schemes that are first practical (in the first phase) then conceptual. Awareness thus occurs within the general perspective of the circular relation between the subject and objects. The subject only learns to know him/herself by acting on objects and objects only become knowable through the progress of the actions exercised on them.

This is a fundamental Piagetian credo: the origin of knowledge is to be found in action. However, the focus of his research on the structural dimension of the genesis, while instructive in terms of the construction of the epistemic subject, remained insufficient to account for the behavior of the psychological subject. It was this task that his successors in Geneva worked on.

Cellérier's theoretical elaborations

We will first examine Cellérier's contribution, which we consider decisive, to current thought on the notion of the scheme. We will then look more generally at the studies of the Geneva school to which he belonged. Along with Inhelder, Cellérier was one of its instigators and leaders.

In 1979 he published two important articles that discuss relations between cognitive structures and action schemes in placing this distinction in an even wider debate between two branches of cognitive psychology: the genetic constructivism approach and the information processing systems approach. He considers that far from being opposed, these two approaches

are functionally complementary: genetic epistemology and its heir, genetic psychology, essentially looked at the acquisition of knowledge, whereas cognitivism focused more on its application³⁷.

The two subjects of these theories, the “epistemic” subject and its corresponding “pragmatic” subject as well as the two temporal scales, macro and microgenetic fusion in the individual psychological subject. Yet due to their different focus, the two theoretical systems were the target of symmetrical criticisms corresponding to the dimension that they did not give priority to: if genetic psychology is non effective (in that it is insufficiently formalized to be implementable in computer systems) computer models are non explicative (in that all programs can be interpreted as a network of conditional reflexes and any stronger interpretation must be founded on a theoretical frame necessarily external to the program). Thus, he humorously concludes, critics who a few years ago consulted “theory rats” (European rats always thought without acting while American rats always acted without thinking) today consult the psychological theories of their ex-tamers which after all, is only fair.

Cellérier presents an in-depth discussion of the concepts specific to the two approaches and concludes that the notion of scheme cannot be reduced to the computer approach of formal procedure. He defines a scheme as an internal model that brings together a control structure assembling, during the production of behavior adapted to an external environment, procedural structures based on knowledge forming an internal epistemic problem space. The scheme is conceived as a system subdivided into more specialized modules whose procedures are macro-operators of the problem space that they factorize into independent sub-spaces. The structure is considered to be heterarchic: the different specialized modules, while they are subordinate to the execution of a defined plan in terms of the scheme, interact in subordinating themselves to each other when they encounter, during their own task, a sub-problem for which they are not competent.

The theoretical project of articulation between cognitive structures and action schemes is thus achieved via a formalization of the notion of scheme introducing a modular conception and a heterarchic type control structure.

Cellérier and Ducret (1992 a & b) extend theoretical reflection on the notion of scheme in two complex texts. In this text, we will only look at elements concerning the problem of preservation and differential accessibility of schemes.

Cellérier and Ducret consider the differential preservation of acquired schemes as a functional necessity. Indeed, a scheme’s value is linked to the differential productivity it provides to the cognitive system, i.e. it depends on the sub-whole of other schemes with which it interacts for the same task, in

³⁷ Obviously Céliérier’s analysis is dated and should be placed in the context of debates in the late 1970s. However, we feel it is still interesting today, both because it allows us to situate one of the possible confrontations between genetic and cognitive paradigms and because it is an attempt at capitalizing on their respective contributions. We feel such a capitalization is one of the urgent and necessary tasks facing psychology.

collaboration as well as in competition. Thus certain schemes that are productive during the initial learning phase of an activity are no longer productive at a later phase. They could only be preserved in a reconstruction that would adapt them to their new “fellow workers”. Here we encounter Piaget’s equilibration based on maximal integration of already constructed schemes in a new construction accompanied by a retroactive reconstruction of these schemes.

For the authors, the effect and function of the preservation strategy and integration of acquired knowledge is allowing the production of non-hesitant behavior made possible by anticipatory auto-guidance of both the action of pre-adapted assimilation schemes, and the construction and reconstruction of these schemes by adapting meta-schemes that are progressively better guided by acquired knowledge. As a result, acquired and pre-adapted schemes produce the largely unconscious functioning of the auto-piloting of the subject who brings intelligence to a range of tasks in daily life.

Cellérier and Ducret also put forward the hypothesis that relative priority markers perform the schemes’ differential accessibility and place ongoing evaluation of their relative productivity in the mnemonic organization of schemes. Thus some schemes will be given priority and tried before others. A scheme’s familiarity is therefore partly the expression of differential activation frequency that results from its priority.

The importance of Cellérier’s analyses in an instrumental perspective comes from the fact that the modular approach allows hypothesizing relative to the mechanisms and conditions of the coordination of elementary utilization schemes into complex instrument-mediated action schemes. Also important are the differential hypotheses concerning the preservation and accessibility of schemes. We consider these hypotheses heuristic for the analysis of instrumental geneses (see part 3).

Evolutions of the notion of scheme linked to the functional analysis of the psychological subject’s activity

Inhelder and De Caprona (1992a) in their introduction to a report on the Geneva school’s research on the functional analysis of the psychological subject (Inhelder & Cellérier 1992), highlight the contribution of cybernetics and artificial intelligence in the evolution of Geneva school problematics: reviving the notion of finality, these disciplines caused action to be considered as central to cognitive functioning and to an even greater extent, the teleonomic dimension of action.

As Inhelder and De Caprona (1985) indicate, while in studies of the subject in problem solving situations, main thought structures appear to be the source of general knowledge, they are only the background on which finalized activities take place. These actions are produced by singular individuals with knowledge and know-how born of action and representation schemes and oriented by the resolution of specific tasks. They are produced by **psychological subjects**.

The authors consider the fascinating task of the Geneva researchers to be the progressive revelation of the scheme as a functioning unit responsible for guiding the action.

They distinguish between presentative schemes and procedural schemes (Inhelder & De Caprona 1992 a & b). Presentative schemes seek to understand reality. Procedural schemes seek to succeed in all domains, from elementary actions to abstract problems. These two types of schemes are complementary.

Presentative schemes concern the permanent and simultaneous characteristics of comparable objects. They encompass representative schemes as well as sensori-motor schemes. These schemes do not suppose very elaborate semiotic representations. Presentative schemes can be easily generalized and abstracted from their context. They are preserved even when they are integrated into other larger schemes.

Procedural schemes are series of actions that serve as a means to attain a goal. They are difficult to abstract from their context. Their preservation is limited given that a means to attain a goal is useless when the subject opts for another means³⁸.

Thus schemes are not merely epistemic units that organize general knowledge. They also comprise a practical and finalized aspect that allows them to engender adequate procedures. The scheme is an assimilating frame that attributes signification and exercises a function that manifests itself essentially in planning.

However, there is no direct application of schemes in problem solving. Each context requires that the subject re-specify the schemes he/she disposes of in partially reconstructing them. In order to insure that constituted knowledge is appropriate to a particular situation, schematic specification corresponds to a process of signification attribution that consists in both translating back the transformations allowed by the scheme in line with contextual constraints and recognizing data liable to serve as a support for these transformations. Elements of the situation are thus assigned a function that the subject can use.

In light of a new situation, a scheme has potential that is both indeterminate and rich in actualization virtualities.

The familiar nature of a scheme is not given. It is itself the product of a construction. Familiar schemes are functionally linked to objects or configurations of objects that they organize.

It is this notion of the familiar scheme that Boder (1992) analyzes. It is a scheme in the Piagetian sense (characterized by a genesis and organizing

³⁸ We consider this affirmation to be questionable. In the following section, we develop the idea that utilization schemes, which constitute means, are both preserved (in relation with the utilization of artifacts they are linked to and the objects on which they allow the subject to act) and reinvestment when the subject is confronted with new classes of artifacts and situations.

nature in the context of a situation), which is easily accessible: it is recognized as a special tool in a certain number of situations in which it is selected to organize the work. The consequence of applying these schemes will be that the situation appears familiar to the subject.

For the subject, it is around these schemes that the representation of the problem and the goal is organized. The familiar scheme plays two roles:

- it is an epistemic unit that attributes signification to the situation;
- it is an heuristic tool: it is responsible for the orientation and control of the research.

The scheme's planning function comes from a descendant control. Its realization procedure comes from an ascendant control.

Familiar schemes play a fundamental heuristic role. They are carried out as procedures (much like frames adapt by attributing values to variables) A procedure, during activity, can itself be reinterpreted in terms of another familiar scheme, i.e. it can be given another signification and thus evoke one or more unanticipated schemes. There is thus a relative independence of the familiar scheme and the one or more application procedure(s). This allows, during problem solving, the evocation of new familiar schemes based on a procedure. This possibility is a factor in the evolution of the problem's representation in line with solution attempts and their results.

Let us look at an example from research by Boder (1992). The situation is one of problem solving in which the subject disposes of two jars. The capacity of one is four liters of liquid (J4) and of the other, five liters (J5). The aim is to put two liters in one or the other jar without placing marks on the jar. It is possible to obtain liquid on demand and throw it away. One of the strategies implemented by the subjects (13 to 15 years old) consists in obtaining a liter of liquid (by emptying the contents of J5 into J4, one liter remains in J5) then attempting to obtain a second liter which when added to the first allows them to obtain the result. To do so, they transfer the liter obtained in J5 into J4 so as to be able to fill J5 again and pour it into J4 to obtain the liter they seek. They forget of course that the liter obtained in J4 will thus be lost. Nonetheless, there are two liters remaining in J5, i.e. the solution, which they most often do not realize they have obtained. Furthermore, when their success is pointed out to them, and they are asked to do it again, they have great difficulty.

This comes from the fact that subjects activate a familiar scheme "holding scheme": a liter is obtained in J5 and is held by pouring it into J4. The signification attributed to J4 is being a recipient for contents on hold while another action is carried out using J5. The transfer of a liter of water to J4 is not easily seen in its second property: creating in J4 a new recipient for three liters. The subject has to de-center his/her attention onto the supplement (the recipient of three liters in J4) and thus modify the signification attributed to J4. By this process, a scheme, "supplementary process" progressively takes control of the subject's representation and allows a reorientation of the solving process.

Revealing the more or less familiar nature of schemes is important for an instrumental perspective. We hypothesize that it is the association of familiar schemes (utilization schemes) and artifacts which, in attributing signification to artifacts, objects and the environment, constitutes instruments.

Saada-Robert (1989, 1992) puts forward a complementary idea of equal importance in our perspective: that of a triple association between familiar schemes, transforming instruments (which in the research presented are what we call artifacts) and familiar configurations (houses, walls, etc.) corresponding to characteristic prototypes of things to be made in the task. These three types of elements thus form functional, mobilizable units in problem solving.

She examines (1985, 1992) the mechanisms at play in the microgenesis in situations of problem solving and in particular, the different types of signification that subjects construct. Signification is constructed in relation with the heuristic manner in which the subject breaks down the problem in line with the familiar schemes mobilized. At the same time, this breaking down depends on the significations that the subject attributes to schemes in light of the situation.

Saada-Robert distinguishes three types of signification - routine, primitive or procedure – that a familiar scheme can take on when it is specified in a particular context:

- routine: a scheme is chosen for its overall relevance to the situation. It has something to do with the problem posed and is tried for this reason. However, the exact articulation with the situation is not constructed. The scheme is functionally linked to the object (physical or mental objects) on which it is very dependent. It takes place in a regulated and rigid manner. It is a block. In this case, control is ascendant, i.e. dealt with by particular aspects of the object. Routine corresponds to exploration behavior that best determines the nature of the problem.

- primitive: the scheme is chosen based on its exact signification as a condition necessary to the solution (signification in relation to the goal), and as a key element for the solution because a relation has been established between goal and objects. The functional scheme-object relation fits into the goal-solving by descendant control, which supposes a precise guiding idea. The primitive is mobile, modifiable and composable with others.

- procedures: scheme chosen because of its signification as the most adequate way of transforming the situation. It is a global organization made up of primitives, which can disappear as such. The typical situation procedure allows mastery of the problem.

There can be microgenetic movement from one status to another in the same subject without the order being imperative. There can also be alternative solutions.

The idea that a familiar scheme can take on different meanings seems important to us in an instrumental perspective. We put forward the hypothesis of a genesis of the instrument. The genesis of utilization schemes, which are

one of the components of the instrument, can occur through the reinvesting of already constituted, familiar utilization schemes and their change in signification, particularly when the subject is confronted with an artifact that is new to him/her.³⁹

A development of the scheme concept in acknowledging specificity of content

The contributions of the Geneva school to the theory of schemes are important, as we have just seen. However, despite the growth of domains explored that go beyond Piaget's initial structural psychological approach, these studies have only marginally considered the specificity of behavior in line with the nature of contents. This is an important problem, which has generated studies, particularly in the domain of scientific knowledge acquisition. We will give an example.

Vergnaud (1990 a & b) who put forward a theory of conceptual fields, places his reflection within cognitive psychology, which he calls concepts psychology, thus breaking with traditional Piagetian psychology centered on logical structures. He considers that scientific knowledge is underlain by behavior organizing schemes⁴⁰, and feels that it is in these schemes that we must seek subjects' knowledge in act, i.e. the cognitive elements that allow the subject's action to be operational.

He gives an example in the motricity domain (the scheme that organizes the movement of a high jumper⁴¹) as well as that of mathematical activities. Thus, the counting scheme of a small collection by a five-year-old child, despite variations in form when counting sweets, plates on the table or people sitting spread out in a garden, has an unchanging organization essential for the scheme's functioning: coordination of eye movements and finger and hand movements in line with the positions of objects, coordinated announcement of the numbers in order, cardinalization of the group counted by emphasis or repetition of the last word spoken: one, two, three, four... four! Schemes make up the unchanging organization of the subject's behavior for a class of situations, both in terms of action and symbolic activity.

They concern all types of complex and mathematical behaviors and knowledge, which are themselves underlain by schemes. Thus, the equation solving scheme in the form $ax + b = c$ is highly available and reliable among

³⁹ We have suggested using this possibility of changing the signification of familiar utilization schemes in a design perspective. Identification based on the analysis of usage activities and utilization schemes liable to be associated with artifacts could provide designers with a starting point, which they are often lacking today, in order to anticipate the future activities of users (Rabardel 1991e).

⁴⁰ On this point, we feel Vergnaud is in step with Bastien's preoccupations of formalizing singular schemes (1987).

⁴¹ We would like to stress that generalizing the notion of scheme to adult behavior is not problematic as long as we are in a functionalist perspective and not an approach in terms of phases.

students being introduced to algebra. The rest of their calculations clearly show that an unchanging organization is based on both habits learned and theorems in act such as: “we maintain equality by subtracting b from both sides”. The student’s cognitive functioning comprises operations that become progressively more automatic (for instance, changing signs when we change members) and conscious decisions that allow him/her to take into account the particular values of the situation’s variables.

For Vergnaud, schemes are of the same logic type as algorithms. However, while they are generally “efficient”, they may lack in effectivity, i.e. the property of systematically finding a solution in a fixed number of steps. An implicit or explicit representation of reality is an integral part of the scheme, analyzable in terms of objects, categories in act (properties and relations) and theorems in act. But there is always much that is implicit in a scheme and therefore difficult for subjects to render explicit.

A scheme comprises:

- anticipations of the goal to be reached, expected effects and possible intermediary stages;
- rules of action along the lines of “if-then” which allow the sequencing of subjects’ actions to be generated;
- inferences (reasoning) that allow the subject to calculate rules and anticipations based on information and the operational invariants system he/she disposes of;
- operational invariants that pilot the subject’s recognition of elements pertinent to the situation and information gathering on the situation to be dealt with.

Three types of operational invariants can be identified:

- "proposition" type invariants: liable to be true or false. Theorems in act are of this type;
- "propositional function" type invariants: neither true nor false. These are indispensable bricks in the construction of propositions, e.g. concepts of initial state, of transformation, of quantified relation. They are constructed in action. They are “concepts in act” or “categories in act”;
- “argument” type invariants which adapt propositional functions into propositions.

For Vergnaud, a scheme is thus not a stereotype but rather a temporalized argumenting function that allows the subject to generate different sequencing of actions and information gathering in line with the values and variables in situation.

In our instrumental perspective, the importance of analysis in terms of operational invariants lies in the fact that it allows us to identify the characteristics of situations that subjects truly take into consideration. These

may be familiar situations for which operational invariants are already constituted, or situations in which their elaboration is underway.

Work schemes: an example:

Most of our examples so far have concerned children and we could wonder whether the notion of scheme remains pertinent for describing behavior invariants in adults. To start with, let us stress that Piaget himself progressively extended the field of application of the concept of scheme. In 1955, for example, Piaget and Inhelder introduced the concept of the operational scheme at a formal level, which they considered to be a manner of proceeding or a method. They were no longer looking at children and sensori-motor structures, but adolescents and formal structures. But what about adults and the workplace - that is to say beyond the development periods our authors mostly concentrated on and in contexts typical of social life?

An example borrowed from Béguin (1994)⁴² will show that action schemes play an important role in structuring operators' activity at work. He analyzes the design activity of an engineering designer in electricity whose task consists of producing a developed schema (technical drawing) based on a logical schema⁴³.

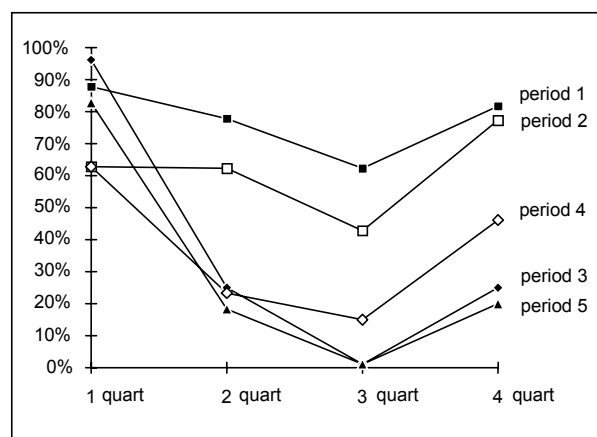

Table 12: percentage of design time devoted to the exploration of the logic schema in line with the different periods and quarters of each of them (based on Béguin 1994).

Five periods, lasting from 52 seconds to a little over three minutes, were identified during production. In dividing each period into four equal parts, we obtain table 12, which concerns perceptive exploration of the logic schema (the source schema for design).

⁴² In his thesis, Pascal Béguin describes an invariant structure of an engineering designer's activity, which we will interpret here in terms of scheme.

⁴³ The logic schema of an electrical installation defines the structure of the installation as a whole and its functioning principles in the form of logic rules, such as "and" and "or", etc. In the schema developed, logic relations are replaced by electrical relations: the schema developed represents an electrical structure with polarities, contacts, receivers, etc.

While the five periods present major differences, they have a related structure:

- in the first quarter of the period, the designer determines the properties that the electrical object being designed must have. He/she is essentially focused on the exploration of the exploration and analysis of the logic schema;
- the second quarter of the period is more focused on producing a first draft of the electrical structure;
- the third quarter corresponds to a check of the intrinsic electrical viability of the graphic image just produced and an evaluation of the overall electrical structure (given what was produced earlier);;
- the fourth period is devoted to checking that the electrical structure conforms to the logical schema and that the logic schema fits with the state of work in progress.

We note that as the designer's work advances, more and more time is spent on checking the intrinsic viability of his/her production. This translates into much less exploring of the logic schema (third quarter). This is because the developed schema produced is more and more complex. As a result, checking its intrinsic viability is itself more complex and is done more through internal analysis than by comparison with the logic schema.

The designer's activity, underlain by the scheme, is not repeated in an entirely identical manner from one period to another. On the contrary, it adapts itself to the specifics of the situation, linked to both the contents of the logic schema and the evolution of the design situation resulting from the designer's activity and its results.

Utilization schemes

We will now define the notion of utilization schemes and the different types of schemes that make up the class of utilization schemes.

Let's take an example borrowed from Luigi Bandini Buti, a Milanese designer (in personal communication), concerning the use of a device designed to adjust a car seat. It is a knob placed on the side of the seat.:

There are three possible motions:

- rotation of the knob allows the user to control the reclining of the seat
- a horizontal translatory motion controls the distance from wheel to seat;
- a vertical translatory motion adjusts the height of the seat.

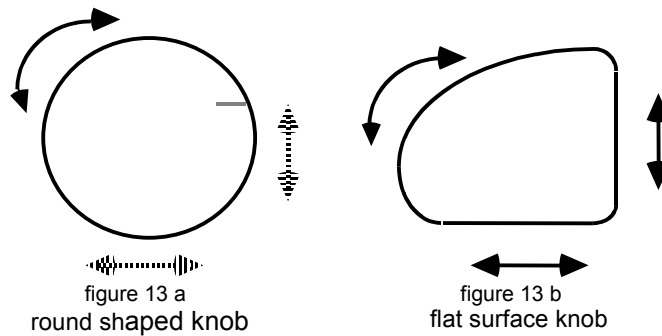

Two types of car seat adjustment knobs (Bandini Buti)

The first knob designed was round shaped. (fig.13 a). It systematically induced users to perform a rotation motion since translatory motions are very difficult to identify. The second knob consisted of two flat surfaces oriented horizontally and vertically, linked by a round shape (fig.13 b). This combination of shapes actually suggested the different possible motions and triggered, through tactile perception, the corresponding actions (turn, pull upwards, or push downwards...)

This example only deals with the mobilization of very elementary utilization schemes (turn, pull, push). These are basic constituents of a utilization scheme they are part of: the adjustment scheme. Indeed, during the subject's first encounters with the adjustment device, the relationship action-results (in terms of effects on the seat) is not yet fully constituted (this action brings about that result), even though it is constituted in principle (it is through action on the knob that adjustment can be achieved). The same goes for the sequencing of actions. The initial learning objective will be to constitute the adjustment scheme (or the coordinated set of schemes), which will then be associated with the artifact (the knob, site of the actions) to form an instrument allowing the subject to act on the object (the seat, site of the effects).

Schemes linked to the utilization of an artifact, which we call **utilization schemes (U. Sch)**, pertain to two dimensions of the activity:

- activities related to "secondary" tasks⁴⁴, i.e. related to the management of characteristics and properties specific to the artifact. In our example, the elementary utilization schemes for the handling of the control knob are located at this level;

- primary activities, or main activities, oriented towards the object of the activity, and for which the artifact is a means of performance. The adjustment scheme of the seat as a whole is located at this level. Coherence of the whole

⁴⁴ The meaning we give here to the notion of secondary task is very different from the meaning given to it in experimental psychology where it is seen as a disruptive task introduced so as to study the profound mechanisms of behavior relative to the main task. In situations of activities with instruments, the secondary tasks, while different from the main tasks, are functional and can in some cases include their own goals.

is insured, following Piaget's formula, by the global meaning of the action: adjusting the seat.

This leads us to define, in a first stage, two levels of schemes within utilization schemes:

- **usage schemes (Us. Sch)** related to "**secondary tasks**". These can, as in our example, be located at the level of elementary schemes (meaning they cannot be broken down into smaller units liable to meet an identifiable sub-goal), but it is by no means necessary: they can themselves be constituted as wholes articulating a set of elementary schemes. Their distinctive feature is that they are orientated towards secondary tasks corresponding to the specific actions and activities directly related to the artifact;

- **instrument-mediated action schemes, (Im. A. Sch)** which consist of wholes deriving their meaning from the global action which aims at operating transformations on the object of activity. These schemes incorporate usage schemes as constituents. Their distinctive feature is their relation to "**primary tasks**". They make up what Vygotsky called "instrumental acts", which, due to the introduction of the instrument, involve a restructuring of the activity directed towards the subject's main goal. According to Cellérier's terminology (1979 a & b), usage schemes (Us. Sch) constitute specialized modules, which, in coordination with one another and also with other schemes, assimilate and mutually adapt in order to constitute instrument-mediated action schemes (Im. A. Sch).

Let's take an example. For an experienced driver, overtaking a vehicle is a type of action which comprises identifiable invariables: analysis of the situation to determine the appropriate moment, indication of his/her intention to overtake, change of gears if necessary, change in the vehicle's trajectory etc. An instrument-mediated action scheme underlies the invariable aspects of such an overtaking situation. This scheme incorporates as components usage schemes subordinate to its general organization, such as those necessary to manage a change of gears or a change of trajectory.

What emerges from the criteria we use to define schemes (their relationship to a main or secondary task) is that the nature of a usage scheme, or an instrument-mediated action scheme, does not refer to a property of the scheme in itself, but to its status within the subject's finalized activity. Thus, a same scheme may, depending on the situation, have the status of a usage scheme (for instance, changing gears in the overtaking example) or that of an instrument-mediated action scheme (for instance, for a beginner, where the question is learning how to change gears) ⁴⁵.

The analysis of schemes involved in instrument-mediated activities cannot be limited to a single individual subject. Indeed, instrumental usage is

⁴⁵ The relative nature of distinctions is very general in conceptualizations that refer to action. This is the case, for instance, of distinctions between action and operation in Leontiev's approach (1976) and between the strategic and tactical levels in fighting forest fires (Rogalski, personal message) in analyses in terms of goal, sub-goal, etc.

often located in the context of a collective activity, in particular in the workplace. A same artifact (or even a class of artifacts) can be used simultaneously or jointly by a group of workers to carry out a common or shared task.

While it is obvious that the subjects introduced in this collective activity implement utilization schemes corresponding to the various types referred to above, it is no less obvious that the collective nature of the activity, besides exceptions, calls for the constitution and implementation of specific schemes.

A third level of schemes must, therefore, be considered: that of **instrument-mediated collective activity schemes (Im. C. A. Sch.)**. These concern the specification of the types of action or activity, of the types of acceptable results etc. when the group shares a same instrument or works with a same class of instruments. They also concern the coordination of individual actions and integration of their results as a contribution to the achievement of common goals⁴⁶.

The different types of Im. C. A. Sch., Im. S. Sch and Us. Sch schemes make up the class of schemes that we call utilization schemes (U. Sch). We put forward the hypothesis that these different types of schemes are mutually dependent: based on usage schemes and instrument-mediated action schemes, collective instrument-mediated activity schemes can emerge, change form and become generalized. On the other hand, collective instrument-mediated are a source from which Im. S. Sch and Us. Sch type schemes can develop and change form, etc.

Finally, it should be stressed that utilization schemes have both private and social dimensions. The private dimension is specific to each individual. The social dimension comes from the fact that schemes develop in the course of a process in which the subject is not isolated. Other users, as well as artifact designers, contribute to this emergence of schemes.

Schemes are the object of more or less formalized transmissions and transfers: information passed on from one user to another; training structured around complex technical systems; various types of users' support (instruction manuals, users' guides and various other supports introduced or not in the artifact itself). This is why we have called U. Sch **Social utilization schemes (S. U. Sch)**. Thus, the social nature of schemes can by no means be confused with the fact that some of them are relative to instrument-mediated collective activities.

We will now look in greater detail at the shared characteristics of social utilization schemes.

⁴⁶ We will not develop any further the analysis of this schematic level, which remains fairly hypothetical, even if our initial results tend to confirm these hypotheses (Béguin 1994). We merely stress that, as for individual schemes, we should probably favor a hypothesis of schemes oriented toward secondary tasks and toward main tasks. The former are integratable and integrated modules in the more general wholes formed by the latter.

Utilization schemes are multi-functional in that they carry out:

- **epistemic functions** focused on understanding situations;
- **pragmatic functions** focused on transforming the situation and obtaining results;
- **heuristic functions** that orient and control the activity⁴⁷.

As with any scheme, they constitute frames that assimilate situations the subject is confronted with. They make it possible to assign meanings to objects according to the orientation of the subject's activity and tasks. They also make it possible to assign them a status both in terms of goals and sub-goals, of states, changes of states and transformations that can be operated on objects, and in terms of means, i.e. of instruments relevant to possible actions.

Utilization schemes are linked to artifacts that are liable to have the status of means as well as to the objects these artifacts make it possible to act on. They are organizers of the action, utilization, implementation and usage of the artifact. They take into account and rely on the properties of the artifact, which are themselves organizers⁴⁸.

However, utilization schemes cannot be applied directly. They must be adapted to the specificity of each situation. They are implemented in the form of a procedure relevant to the particularities of the situation.

These particularities can be limited to classes of familiar situations where the artifacts associated with the utilization schemes as well as the objects and their transformations are well known and identified by the subject. Operating invariables are constituted, at least in part, by a structured set of variables which are characteristic of the class of situations. The assimilation process leads to establishing the particular value of the variables according to the characteristics specific to the situation. Utilization schemes can then be considered as easy to mobilize, familiar schemes that contribute to the "automated" functioning that typifies well-mastered, common situations.

The implementation of utilization schemes in new but similar situations (assimilation process) leads to the generalization of schemes by extension of the classes of situations, of artifacts and objects they are relevant to. It also leads to their differentiation since most often they have to change to adapt to new and different aspects specific to situations.

⁴⁷ Let us stress that the heuristic function is not only due to the scheme but can also be carried by the artifact. It is thus the instrument as a whole that can participate in the subject's management of him/herself. We therefore follow Béguin (1994) in considering that it is a question of a true heuristic mediation.

⁴⁸ If an artifact is an activity organizer, it is of course in a different mode to that of schemes. We will analyze the characteristics in the following chapter in putting forward concepts of required activity and expansion of the range of possibilities.

In situations very new to the subject⁴⁹, the adaptation process becomes temporarily predominant. It leads to the transformation of available schemes, to their reorganization, fragmentation and restructuring, reciprocal assimilation and coordination, which progressively produces new scheme compositions allowing renewed and reproducible mastery of the new class of situations and beyond this to extended assimilation and adaptation potentialities. Such mechanisms emerge, for instance, when new artifacts must be used as means of action or when the action focuses on new objects or new transformations of these objects.

The assimilation of new objects and new artifacts in utilization schemes, source of both generalization and adaptational differentiation, leads to the enrichment and development of the subject's network of meanings, within which artifacts, objects and utilization schemes, are closely associated.

A psychological definition of the notion of instrument

We now have the necessary foundations to propose a psychological definition of the instrument. The essential point of this definition is that the instrument cannot be reduced to the artifact, the technical object or the machine, depending on the terminology employed. We propose defining the instrument as a mixed entity, born of both the subject and object (in the philosophical sense of the term): the instrument is a composite entity made up of an artifact component (an artifact, a fraction of an artifact or a set of artifacts) and a scheme component (one or more utilization schemes, often linked to more general action schemes). An instrument therefore consists of two types of entities:

- a material or symbolic artifact produced by the subject or others;
- one or more associated utilization schemes, resulting from an autonomous construction specific to the subject, or from an appropriation of S. U. Sch. already formed outside of him/her

We are, therefore, led to extend Mounoud's definition (1970) according to which an instrument can be any object the subject associates with his/her action to perform a task. It is not only the "object" associated, and associable, by the subject with his/her action for the performance of the task, it is also the utilization schemes that will allow the introduction of an instrument as a functional component of the subject's action. It should be noted that Monoud calls object what we call artifact.

This means that the constitution of the instrumental entity is the product of the subject's activity. The instrument is not only part of the subject's external world or something available to be associated with an action (or even necessarily associated, as is often the case in the workplace). It is also the subject's production or construction. This is obvious as far as utilization

⁴⁹ This is often true of situations which numerous authors (Norman 1988, Bodker 1989a, etc.) call "breakdown situations". These are situations where automated functioning, for various reasons, can no longer occur and where the subject consciously takes over.

schemes go but in the following chapter, we will see that similar processes also exist for the artifact part.

This definition of the instrument allows us to overcome the seeming contradiction that may arise between approaches which grant the status of instrument exclusively to objects external to the subject (artifacts), or restrict the status of instrument to the subject's schemes. Both these symmetrical options lead to almost completely negating one of the two components of the instrumental entity.

The two components of the instrument, artifact and scheme, are associated with each other, but they also have a relationship of relative independence. A same utilization scheme can be applied to a range of artifacts belonging to the same class (such as car driving schemes transposed by the subject from one car to another) and also be relevant to similar or different classes (often not without problems, as we have seen in the case of microwave ovens). Conversely, an artifact is liable to be integrated into a range of utilization schemes, which will sometimes assign it different meanings and functions. We all have examples in mind such as the association of the scheme "strike" with a wrench, turning it into an instrument with the same function as a hammer, or even a blunt instrument.

The constituted instrument can be ephemeral, linked only to the particular circumstances and conditions of a situation the subject is confronted with, but it can also be of a more permanent nature and be retained as a whole as a means available for future actions. This dynamic whole will, of course, develop in line with other action situations in which the subject will involve the instrument. Thus the instrument as a whole, as well as each of its components, is a form of capitalized experience, or knowledge. This is one of the main characteristics defined in the literature.

But how can the instrument thus defined occupy an intermediary, mediating position between the subject and object, since, as both scheme and artifact, it pertains to both? The answer to this question is to be sought in the relation of the instrument to the action. The subject institutes certain components of his/her environment as instruments according to his/her goal, i.e. as means for his/her action.

Just as these means can be part of his/her organism, for instance limbs or sensory organs, they can also be schemes. That is why Bullinger (1987 a & b) emphasizes that we must by no means confuse the subject and the functioning of the organism, since this would amount to concealing the origins of the instrumental activity. We know that the distinction between subject and functioning has a status in the subject's very activity. An example of this is in the abstraction process (empirical and reflective) in which the subject takes his/her own schemes as object. Thus in the finalized activity, utilization schemes are not only in an external (instrumental) position. They can also be in the position of object, particularly when the orientation of the finalized activity is epistemic.

Likewise, the instrumental position of the artifact is relative to its status within the action. The artifact is not an instrument or an instrument component

in itself (even when it was initially designed as such); it is instituted as an instrument by the subject who gives it the status of means to achieve the goals of his/her action. In this respect, artifacts integrate the activity and bring about more or less significant reorganizations. Thus, a same artifact can have very different instrumental statuses depending on the subjects and for a same subject, depending on the situation and even different moments of this situation.

For subjects, an artifact is enriched by the action situations it has been circumstantially involved in, specifically, as a means of their action. This is how what we could call the palette, the instrumental field of the artifact comes into being for the subject: the set of artifact utilization schemes it can be introduced into in order to form an instrument; the set of objects it allows the subject to act on; the set of transformations and changes of states it allows the subject to perform. Artifact utilization schemes become richer and more varied with the evolution of the artifact's instrumental field. They evolve with the range of artifacts they are associated with to form an instrument and with the range of statuses they may take on within this association.

In such a frame of thought, the permanence of utilization schemes, specifying one or more artifacts with defined properties, allows us to define one of the dimensions of instrument preservation for the subject. Indeed, there is no instrument without artifact. Nonetheless, the preservation of the artifact component can concern a class of objects (and not a specific artifact) when the subject in his/her action environment has permanent access to elements or artifacts with the properties necessary for it to be associated with utilization schemes in order to form the instrument required by the action in progress⁵⁰. The function in terms of possible changes in state can thus be disassociated from the artifact and associated with the subject. Function in action is a characteristic of the subject, not the artifact.

A permanent instrument, liable to be preserved and thus reused, is made up of the stabilized association of two invariants (which can be classes of invariants). Together, they constitute a potential means of solving, dealing with and acting in a situation. However, the question of the constitution or genesis of the permanent instrument is thrown up: how are its two schematic and artifactual invariants constituted? Whether it concerns the scheme or the artifact, this construction generally does not occur in a vacuum. The artifacts are most often pre-existing but are nonetheless instrumentalized by the subject. Schemes most often spring from the subject's repertory and are extended or adapted to the new artifact. Sometimes, entirely new schemes must be constructed: these processes as a whole can be described as instrumentation and instrumentalization processes.

⁵⁰ We will return briefly to the animal world. Recent observations (Boesch & Boesch-Achermann 1991) revealed that a monkey extracting termites often used three types of sticks with well-differentiated functions. The artifactual component of these instruments is not preserved. Monkeys can find plenty of them in their environment. However, repetitive and similar usage of artifacts with differentiated properties can be interpreted as a sign of their insertion in permanent utilization schemes that thus preserve the instruments.

In the third section, we will look at questions concerning instrumental genesis and processes of instrumentation and instrumentalization.

**PART THREE: ELABORATION AND GENESIS OF
THE INSTRUMENT BY THE SUBJECT**

In the first chapter, we will discuss “traditional” interpretations of the misappropriation of objects given the use for which they were designed. We will show their limitations and put forward an interpretation in terms of both the development of these instruments by the subject and instrumental genesis. We will then define the different dimensions of the processes of instrumental geneses: instrumentation and instrumentalization, then analyze their representative aspects. Lastly, we will examine the dialogue between design processes by designers and instrumental geneses produced by users.

CHAPTER 7: WHEN SUBJECTS DEVELOP THEIR INSTRUMENTS - INSTRUMENTAL GENESES

What status should we, or can we attribute to catachreses when looking at activities with instruments? But first of all, what is a catachresis?

The notion of catachresis

The term catachresis is borrowed from linguistics and rhetoric where it refers to the use of a word beyond its accepted meaning, or instead of another word. By extension, the idea has been transposed into the field of equipment to mean the use of a tool instead of another or the use of tools for uses for which they were not designed. Faverge (1970) gives as an example of catachreses the use of a spanner to hit instead of a hammer, or that of an inappropriate grindstone for certain sharpening actions although the rotation speed is increased beyond its normal limits.

The notion de catachresis is a concept that designates the difference between the planned and the real use of artifacts. In the technical domain, this has fairly negative connotations. Ergonomists are well aware of the very general nature of this difference between the prescribed aspects of work and what is known as real work. They have not only identified this but have also given it a theoretical status allowing a positive understanding of the nature of this difference, and of its causes and functions (Ombredane and Faverge 1955, Wisner 1974, Leplat and Cuny 1977, De Montmollin 1984, 1986, Laville 1986 Daniellou 1986 etc.). The idea that there is an individualization of that which in principle or in theory should be beyond the subject’s grasp (Schwartz 1988 & 1992) and thus supposes forms of autonomy (De Terssac 1992) participates in current research on this theme. We feel that it is also in this category of events and phenomena that catachreses occur.

In any case, the very existence of a term to describe this difference indicates that it is a widespread, or at least a common phenomenon. How should it be interpreted?

Interpreting the difference between intended usage and real usage of artifacts

Catachreses are traditionally interpreted as misappropriations of the object in terms of the functions intended by designers and what they imagined and anticipated usage to be. There is misappropriation in terms of the instrumental, theoretical rationality as it is inscribed in the artifact, machine or system. These deviations can be problematic, for example by creating dangerous situations given the distortion of usage in terms of the inherent rationality of the technical process.

Thus, Winsemius (who according to Faverge, was the first to introduce this term in ergonomics in 1969), in studies on security in the workplace, indicated that catachreses and the informal usage of tools could be the cause of a certain number of accidents. Faverge (1970) also cites catachreses as sources of temporary infallibility in work situations. He classifies these types of causes in the factors specific to the work situation and not in those specific to workers. While the artifact undeniably belongs to the situation, the decision to employ it in a catachesic usage usually depends on the subject. Thus catachreses must also be analyzed from this second point of view.

This leads to another possible and equally legitimate interpretation, no longer based on theoretical instrumental rationality, originally inscribed in the artifact, but on the subject's own instrumental rationality. In this perspective, the catachresis can be considered as an expression of an activity specific to the subject: the production of instruments and more generally the means of his/her actions.

Therefore, in this section, we will suggest considering **catachreses as indicators of the fact that users contribute to the design of artifact uses**, particularly (but not only) the utilization scheme part of the instrument. The existence of catachreses indicates that the subject institutes adapted means in line with pursued goals. It also indicates the elaboration of instruments destined to be inserted into his/her activity in line with objectives⁵¹.

The results of studies on catachreses and attributions of function

Unfortunately, catachreses of artifacts have not been studied much. We have thus joined studies concerning them to those on the attribution of function.

Attribution of functions and the properties of artifacts

Studies carried out in the United States sought to determine the conditions influencing the attribution of functions to artifacts. Hence, Jordan and Shragger (1991) study the role of physical properties in the understanding of artifacts' functionality.

⁵¹ We focus on the elaboration of his/her instruments by the subject. The pertinence of these elaborations is another question, which we will not examine here.

The approach is purely experimental and consists in asking subjects to choose from a list of different types of artifacts (some of which do not have a “prescribed” instrumental function, such as a diamond) those most appropriate for carrying out different types of goals (hammering in a nail, protecting oneself from the wind, etc). The authors conclude that in most cases, an artifact’s usability comes from a group of properties, rather than just one. Furthermore, this group of properties is heavily dependent on the goals and context of the activity. It would seem that the subjects define, in line with the goals of the activity, a group of pertinent properties that the artifacts must possess and for each of these, an ideal value. The usability of an artifact is defined based on the combined distance of each of these properties from the ideal value.

These studies echo the analyses carried out by Norman (1988, 1992) in the context of his research on the psychology of things from everyday life. Norman develops the idea of affordance that refers to the perceptible properties of artifacts allowing the subject to determine how they can or should be used.

Despite their importance, these studies do not really allow us to interpret catachreses (and do not aspire to) except as the general possibility given to the subject faced with all objects. As such, they confirm an idea that we developed earlier: an object’s function is not a fixed and intangible property of that object, but the result of an attribution process by the subject. Catachreses can thus be considered as indicators of the activity of attributing to artifacts, in line with their apparent or known properties, functions not anticipated or planned for by designers.

Attribution of functions and characteristics of situations

The attribution of functions is not born of artifacts’ properties. It is also linked to characteristics of situations: to goals (as shown by Jordan and Shragger), as well as conditions of the action.

Thus, Winsemius (1969) formulated the hypothesis that a catachresis occurs all the more easily when the catachretic object is more available. As Winter (1970), reminds us, he also proposed distinguishing between large and small catachreses. A catachresis gets bigger as the current use of the tool becomes more distant from the use for which it is most adapted. For example, a spanner has a fairly solid mass. This is why it can be used to hammer a nail into a piece of wood. A screwdriver of equal length has a low mass and thus does not lend itself to the same activity. The catachresis must therefore be considered as smaller when we use a spanner than when we use a screwdriver to hammer in a nail.

In these formulations, there is already the idea of distance from an ideal value analyzed by Jordan and Shragger⁵². Winsemius used this evaluation of the “size” of catachreses to formulate two other hypotheses: a small catachresis occurs more easily than a large one; and to obtain a larger catachresis, the artifact

⁵² Attempts at definitions in terms of the size of catachreses or the distance from an ideal value could be extended in an instrument categorization perspective. They suggest that artifacts could be considered in terms of distance from a prototype artifact.

in question must be made more available than an object for which the same use represents a smaller catachresis. These hypotheses, based on the idea of availability, allow the introduction of the action's conditions and context as determining factors in catachreses.

The different hypotheses threw up experimental verifications by Danev & al. (1970), and in particular Winter (1970) whose main results will be outlined here. The subjects of Winter's experiments had to move different types of objects (rings, grains, marbles). To do so, they disposed of three pairs of tweezers whose extremities had been adapted to the particularities of each type of object (the variations thus only concerned the instrument-objet interaction zone). By the nature of the material used, the situation is more realistic than that of Jordan and Shragger, but above all, it is not a simple questionnaire: the subjects carry out real tasks.

All Winsemius's hypotheses were confirmed: small catchreses are proportionally more numerous than large ones; the availability of artifacts is indeed a determining factor in the existence of catachreses as well as their "size". Yet other results that move beyond these hypotheses are of interest to our position. In the least favorable conditions of availability (where the subject must go a long way to collect the best adapted tool), subjects tend to progressively favor one of the pairs of tweezers and use it for the different tasks (even though it is not the most adapted to some of these tasks).

We feel that this tendency can be interpreted as translating a process of instrumental genesis. It would seem that subjects, in line with the objects on which they must act, develop differentiated usage modalities for a given artifact - specific utilization schemes that tend to render the artifact multi-functional - and thus constitute, from the same artifact, several individualized instruments based on the specificity of the objects and the tasks. It would thus be by an adapting differentiation of the scheme component of the instrument that the artifact becomes multi-functional.

A second type of data tends to confirm the hypothesis of an instrumental genesis: when an additional time limit is added, the number of catachreses drops from the start to finish of the experiment. The author interprets this drop as subjects progressively choosing the most efficient method. We can effectively consider that the increase of efficiency constraints led to the choice of increasingly specific artifacts in line with tasks. The genesis process of the most appropriate instruments given the constraints of the situation in this case would thus lead to the differentiation of the artifact pole of the instrument. The particular properties of each of the artifacts are increasingly well identified by the subjects and so more pertinent choices, given efficiency criteria would be progressively favored.

Unfortunately, the author does not provide, for the condition with the time limit, detailed data that would allow us to analyze whether the process concerns all the task-artifact pairs or only some of them. However, the data relative to the experiment without a time limit shows major differences among task-artifact pairs: the frequency of catachreses can vary from under 10% to almost 45%. We can thus suppose that in the same way, "geneses" with time limits do not equally concern all task-artifact pairs.

Interpretations in terms of instrumental geneses that we put forward are of course hypothetical and require other data for confirmation, particularly concerning individual usage modalities of artifacts and their evolutions.

Attributed functions and planned functions form an overall system

Lefort (1970, 1982) made observations in work situations. He was particularly interested in the distribution of different types of tool use during dismantling activities (in maintenance or repairs), in the mechanics field. He puts forward a double distinction: both between formal, recognized tools officially existent in the workplace and informal tools, as well as between formal usage and formal tools (i.e. in conformity with prescribed usage modalities) and informal usage that does not fit into such prescriptions⁵³.

The author seeks to determine the origin of informal usage and tools. He identifies two possible sources:

- an economic aim pursued by the user. Hence, when two different tasks are entrusted to a subject with tools specifically adapted to each of them, and if the subject is interrupted while executing one of the tasks to carry out the other, he/she tends to use the tool for the first task to carry out the new task. By systematic observation in an industrial context, Lefort came up with the same results as those obtained experimentally by Winter (1970): the proximity of a tool and its availability explain certain catachreses in relation to a fleeting economy of effort in the acquisition of the tool for the action underway;

- a search for efficiency: some informal practices translate the user's attempt to adapt means to goals (either by the informal usage of a formal tool, or by the elaboration of informal tools), thus compensating for certain tool deficiencies. Formal tools offer means that are in principle well adapted in terms of foreseen tasks. They are used frequently and preferentially but if they are insufficient (a nut, for example, may not be available) the operator resorts to informal usage or the production of better adapted tools.

Lefort shows that the operator restructures available equipment in line with his/her experience. Each tool generally fulfills one or more formal functions as well as other functions. Operators thus introduce a certain level of redundancy in their

⁵³ We could define these categories even more precisely in distinguishing truly informal usage from usage deviating from norms, as is done by ergonomists specialized in product design.

Some car drivers, for example, over-solicit the main cylinder of their vehicle: the pressure exerted by the driver can go as high as 200 kg instead of the 50 kg foreseen. There is no increase in brake power due to this increase, which can perhaps be related to drivers' hypotheses on efficiency conditions: the harder you put your foot down, the more efficient the brake action (Rebiffé, personal communication). This is a usage outside the norm: the user has no intention of misappropriating the object in terms of its normal utilization or attributing a new function. It is more likely that he/she is not familiar with its conditions of utilization. For us, there must be an attribution of new or different functionalities for us to define a usage as catachretic.

This is the case, for example, when the armrests of seats in a bus are used as steps to attain luggage (here, the catachresis is sufficiently frequent for the designer to take it into consideration: he/she designs the armrest to resist this type of informal use). We must thus distinguish, among informal uses, those which are catachretic and those which simply deviate from the norm.

equipment. This allows greater flexibility of use and a greater variety of solutions due to the invention of new functions attributed to formal and especially informal tools. Thus restructured and organized, the equipment makes up a homogenous whole allowing a better balance between economic and efficiency objectives.

This seems to us to be one of the most interesting results obtained by this author: informal functions and tools are not isolated. They are integrated into the rest of the operator's equipment to ensure a more balanced whole. The new, informal functions form an overall system along with the formal functions. We thus need to analyze, beyond individual tools, a subject's equipment as a whole: the instruments that it comprises, their statuses, rules and forms of organization, its genesis and evolution, etc.

Processes of attributing function in contemporary technologies

Nonetheless, we can wonder whether these results obtained in the context of manual tools or in reference to essentially static artifacts (like those of Jordan & al.), remain pertinent in a context of computer technologies and automation. Are the artifacts born of these technologies too different or too complex to undergo user catachreses? We will show that on the contrary, catachreses have lost none of their importance with new technologies. Following are a few examples.

Attributing functions oriented toward the transformation of the object of the activity: pragmatic mediation

Let us remember the fable of the pilot and the dog, with which we introduced an earlier chapter, illustrating mechanisms to limit initiatives in automated piloting systems. Pilots however, are not always willing to be limited: they take back control of operations by unexpected means. They misappropriate certain instruments, i.e. make catachretic use of them.

An article on airline security news from Canada (anonymous 1989) indicates, for example, that "pilots seek to bypass the calculator program which does not give satisfaction. Crews that wish to start their descent before the point fixed by the computer simply inform the computer that they are going to activate the defrosting device, which they will not do, or enter a fictitious tail-wind. The calculator then establishes a new descent starting point which the pilot is happy with⁵⁴.

Although they have not been systematically identified and analyzed (which would be both socially useful and scientifically interesting), such phenomena seem to be common in advanced technologies. Thus, Millot (1991), whose research concerns human-system cooperation in which the increase in the decisional capacities of tools leads to a partnership with operators, puts forward a system of dynamic task distribution between humans and tools. However, he

⁵⁴ As Amalberti (1991) indicates, such procedures are liable to become dangerous, particularly when several false indications are given to the calculator and an external incident occurs. The pilot then has great difficulty in establishing the real state of his/her machine and controlling it.

indicates that difficulties arise, particularly because operators try to steal tasks from the system.

Likewise, Galinier (1992) reveals catachretic uses of automatic speed boxes in heavy goods transport trucks. The dashboard computer is supposed to suggest the most appropriate gear ratio when the driver goes to change gears. He/she is free to accept or reject this proposal. The automated proposals are elaborated based on calculation of the current state of the motor and on economic (economical mode) or performance criteria (high-performance mode).

But these criteria are not always the most pertinent from the driver's perspective. His/her decisions are mostly not based on evaluations of the current state of the situation but rather on anticipations of the evolution of driving conditions and context. For example, he/she changes down before beginning a difficult descent, takes into account the probable behavior of other drivers, etc. This difference between driver and computer criteria means that the gear ratio suggested by the computer often does not suit the driver (over 30% of suggested gear ratios are not accepted).

Drivers have thus developed strategies to force the computer to suggest the gear ratio they wish to change to. They divert the command that allows them to move from economical mode to high-performance mode to obtain an increase in power (on hills, to overtake, etc.) For example, if the gear ratio in use is low 8th and the calculator proposes high 8th when the driver in fact wants to change down in the approach to a descent, he/she will change to high-performance mode. This leads the calculator to propose low 7th, which corresponds to the driver's wishes.

The mechanism of this attribution of function is exactly the same in nature as that employed by the airplane pilots. The operator takes back control of the system by using entry variables that "normally" have another usage: informing the system of the context or driver intentions. In providing data unrelated to reality (a fictitious tail-wind, a request for greater power) but carefully chosen, given the functioning rules of the system known to the operator, he/she imposes criteria on the system. He/she appropriates it as an instrument.

It is this same mechanism that underlies the catachreses identified by Duvenci-Langa (1993) in manufacturing with a digitally commanded machine tool (CNC). In this situation, the traditional tool is transformed into a CNC by the addition of a command director. After analysis of the manufacturing processes on the traditional machine, the designers' hypothesis was that these processes could be reduced to a small number of cases for which they had prepared pre-established programs, and whose variables would be parameterized by operators in line with the objects to be manufactured: millstones. These millstones differ in shape and size as well as in the nature of the material and particularly, its hardness.

In reality, these programs turned out to be insufficient: operator know-how had been disregarded and commands essential to its implementation were eliminated, particularly those allowing management of cutting speed. To recover the many manufacturing incidents, operators developed a catachretic use of programs: they entered false information on the nature of the material so as to

obtain the appropriate cutting speeds, different from those normally intended. It is again via data entry variables to which he/she attributes new functions that the user takes back control of the system and instrumentalizes it according to his/her needs.

Attribution of functions oriented toward knowledge of the object of the activity: epistemic mediation

All the examples given above concerned pragmatic instrumental mediation. Subjects aim to produce instrumental functions allowing a transforming action directed toward the object of the activity. The examples we will now present concern epistemic mediation: subjects produce instrumental functions oriented toward knowledge of the object.

Our first example concerns CAD software in electricity. The operator uses the “erase” function not to erase an element of his/her drawing but to examine its structure in the software memory. A same line (on screen) can be obtained based on one or more computer entities (in memory). In applying the erase command to a line, the operator obtains a change in color on screen, which will indicate whether it is composed of one or more entities in memory⁵⁵.

The operator thus (momentarily) diverts the “erase” command from its function which is situated in terms of pragmatic mediation to attribute it a new function situated in terms of epistemic mediation: obtaining information, otherwise inaccessible, on the nature of computer entities (in memory) that make up the graphic entities displayed on screen.

With the idea of a graphic entity, we move into the semiotic field, which also allows us to identify the attribution of functions. Our last example concerns a semiotic instrument: the technical drawing. To do so, we will reinterpret the results of an experiment on the use of hatching (Flahaut & Rabardel 1985).

Subjects attribute to hatching a function not planned for in the code and apply this new function in activities of reading and decoding technical drawings. The function prescribed by the code (as it is presented in the norms and manuals) is twofold: hatching serves to indicate that a room is seen in cross section (which may be necessary, for example, to show internal details); it also informs of the nature of the material (e.g. steel, brass, etc.).

The attributed function facilitates the identification of the hatchings as a whole, which form a technologically significant graphic unit. The perceptive segmentation of the graphic flux into technologically significant units is a major issue in the reading of technical drawings. Subjects use the attributed function as an aid in the exploratory activity. It helps them to deal with the perceptive level – by identification of the contour lines linked to the hatching – of problems that

⁵⁵ This identification is necessary to the operator because the software program automatically attributes a number to each wire. A wire corresponds to one and one only entity in memory. Thus, if a line representing a wire is drawn with the aid of several software entities, it will produce an error in the automatic numbering.

otherwise need to be dealt with on the signified level – recognition or reconstruction of a group of lines corresponding to a technologically significant entity (Rabardel 1980, 1982b).

In this example, the attribution of functions could be deemed tacit in that the subjects are not aware of it. It concerns the private semiotic instrument, i.e. the personal vision, specific to the interiorized semiotic system, which, as we have just seen, is remodeled by each subject.

Limitations of interpreting in terms of misappropriation - towards an interpretation in terms of elaboration and instrumental genesis

Catachreses in the semiotic domain, such as those described for hatching, lead us to question even more carefully our interpretation of attribution or elaboration of functions in terms of misappropriations. Indeed, to what extent can we legitimately speak of misappropriation when research in the domains of semiology and psycho-semiology indicates, as we will see, that the subject's elaboration and restructuring of his/her instruments is a constant?

In the domain of port piloting, for example, Cuny (1981a, 1993) shows that pilots constantly elaborate semic instruments adapted to their work. These results tend to be confirmed by analyses by Hutchins (1990) in the same domain and by Minguy's studies of deep-sea fishing. Minguy reveals that the captain of the fishing trawler elaborates his deep-sea maps based on his own analysis categories (for example, he distinguishes types of sea floors in terms of hardness, relief, floor substance, etc) This activity cannot be interpreted in terms of misappropriation. It is an instrumental production carried out by the operator (Minguy 1993, Minguy & Rabardel 1993).

Scribner (1986) also describes attributions of function in work situations: delivery workers in charge of transporting boxes give them a quantitative symbol function for their counting activities. Scribner considers that the functional role of these environment properties is the product of the subject's constructive activity, i.e. although she does not use the term, of a process of instrumental genesis.

In this light, catachreses can be seen as merely a specific case of a much more widespread phenomenon: the subject's production, elaboration, institution and transformation of his/her instruments, including when these instruments are based on hyper-normed artifacts such as technical graphic codes.

We think that the traditional interpretation of catachreses is only a particular way of qualifying certain types of events: a normative point of view of these events based on the idea of misappropriation. But which norm should we use? What is its origin and its nature? Where does it get its legitimacy? Is it enough for a usage to have not been anticipated, planned, imagined or prescribed for it to constitute a misappropriation? Does the difference from what is planned need to be deliberately sought by the subject? Should we consider as a misappropriation an unplanned usage which the subject believes is canonical? Is it not, on the

contrary, necessary to adopt another point of view to apprehend and analyze catachreses and attributions of functions in all their significance⁵⁶?

We feel that the problems of interpretation identified for semiotic instruments are not at all specific to this class of instruments. It seems that other types of instruments, attributions and elaborations of functions can also be interpreted as products of a very widespread process: instrumental genesis and the subject's management of his/her tools.

We will thus attempt to simultaneously apprehend the evolution of artifacts linked to the user's activity and the emergence of uses (structuring themselves into diverse types of utilization schemes) as participating in the same process of instrumental genesis and elaboration. In an ergonomics perspective, we can seek to anticipate some of the probable characteristics of this process by the analysis of contexts and situations of possible usage, potential events and available or constructable schemes. However, this process must also be analyzed and understood on a psychological level, in reference to and from the perspective of the finalized subject pursuing goals through actions.

This instrumental genesis process is carried by the subject. Because it concerns the two poles of the instrumental entity – the artifact and the utilization schemes, it also has two dimensions and two orientations that are both distinguishable and often related: instrumentalization directed toward the artifact and instrumentation relative to the subject him/herself.

It is this process, in its two components of instrumentalization and instrumentation that we will analyze in the following section.

CHAPTER 8: INSTRUMENTAL GENESIS, A PROCESS THAT CONCERNS BOTH ARTIFACT AND SUBJECT

Above, we suggested that events usually considered as function and object misappropriations be interpreted as resulting from a process of instrumental genesis. We would like to stress that instrumental geneses are not limited to what may appear to be misappropriations.

Cook & al. (1991) also describe activities of an instrumental genesis type among users of a new surveillance system in cardiac surgery. The instrumental elaboration concerns both the tasks the users give themselves and the reorganization of their activity, as well as transformations of the technical system⁵⁷. Users' instrumental elaborations are thus directed both toward

⁵⁶ Of course, this does not mean they cannot also be considered in terms of misappropriation, for example in a security perspective. Indeed, the attributions of function that we analyze here from a psychological point of view must also be the object of other types of interpretation particularly linked to the contexts of their emergence and to their potential consequences, particularly in terms of security and reliability. Given the objective of this publication, we will not go into this type of analysis here.

⁵⁷ The authors use the terms "system tailoring" and "task tailoring". The second category also includes evolutions of the activity.

themselves (this is the dimension of the instrumental genesis that we call **instrumentation**), and directed toward the artifact (the **instrumentalization** dimension).

Some designers attempt to take instrumental geneses into consideration in the initial design of systems, particularly software systems. De Keyser (1988) shows that the LENS system of sorting electronic messages (Malone, Grant & Turbak 1986) allows each operator to constitute his/her own filter in line with his/her information needs.

Trigg, Moran & Halatsz (1987) also look at systems liable to be adapted by users themselves based on the activities they are responsible for. Meanwhile, Henderson and Kyng (1991) seek to define levels of system modifiability: non-modifiable, modifiable and adaptable within limitations and perspectives foreseen by the designer, transformable in new perspectives in terms of functions. The last two levels concern instrumentalization processes that the authors identified in real situations; one on the level of user adaptation in a "space" foreseen by the designer; the other on the level of the emergence of new functions for and by the user. Different sorts of user practices correspond to this:

- the choice between options pre-determined during initial design;
- the construction of new artifact behavior based on existing elements. The organization of pre-existing elements is modified by grouping operations, reconfiguration, etc.;
- transformation of the artifact itself.

Thus, the process of instrumental genesis appears to be a type of activity sufficiently constant and widespread to start being anticipated within the design of artifacts.

Instrumental geneses exist even in highly restricted activities

We can however wonder whether instrumental geneses can develop in highly restricted work situations. Information in this domain is rare.

In a text on the suggestions formulated by staff members in a large automobile company, Berthet (1986) reports that their number is very high (over twenty thousand per year for a company with twenty four thousand staff members) and that 23% of these suggestions concern work tools and production modes (around five thousand). In this last category, suggestions mostly concern modifications of tools to better adapt them to tasks and sometimes go as far as the creation of specific tools (Berthet, personal communication).

Due to a lack of elements it is impossible to analyze the propositions here. Yet their number is striking. In our opinion, it highlights the importance and widespread nature of genesis and instrumental evolution phenomena carried by users, including in work contexts with very developed prescriptions such as assembly line production with heavy time restrictions. It could seem there is little opportunity in such a context for an individualization of conditions of the activity in

line with the specificity of individuals, tasks and their variability. The enormous mass of suggestions put forward by operators concerning the means of their work contradicts this naive representation.

Instrumentation and instrumentalization: an introduction

As we have seen, events are beginning to take on a status, but the vocabulary and even the notions have not yet stabilized, even in psychology.

The idea of the genesis of the instrument clearly underlies studies by Mounoud (1970), while that of instrumentation is used by different authors who themselves refer to Vygotsky, Wallon or Mounoud.

Bullinger (1987 a & b, 1990 & in press) uses this notion to describe the manner in which a baby manages to make his/her sensori-motor systems into tools allowing him/her to understand and act on his/her surroundings. Instrumentation is thus a process directed at oneself, even though in some cases the author extends the notion to artifacts, particularly when looking at sensori-motor deficits and handicaps.

Netchine-Grynberg & Netchine (1989), Netchine (1990) use the same term (but also instrumentalization at times) to designate a child's construction of sensori-motor organization appropriate to reading activities, as well as the cognitive management of his/her own activity allowing mastery of mechanisms he/she uses and their adjustment to a range of finalities.

We will use the term instrumentation, in line with the use that appears dominant, to designate aspects of the instrumental genesis process oriented toward the subject him/herself. We reserve that of instrumentalization for processes directed toward the artifact:

- **Instrumentalization processes** concern the emergence and evolution of artifact components of the instrument: selection, regrouping, production and institution of functions, deviations and catachreses, attribution of properties, transformation of the artifact (structure, functioning etc.) that prolong creations and realizations of artifacts whose limits are thus difficult to determine;

- **Instrumentation processes** are relative to the emergence and evolution of utilization schemes and instrument-mediated action: their constitution, their functioning, their evolution by adaptation, combination coordination, inclusion and reciprocal assimilation, the assimilation of new artifacts to already constituted schemes, etc.

These two types of processes are born of the subject. Instrumentalization by attributing a function to the artifact results from his/her activity, as does the adaptation of his/her schemes. They are distinguished by the orientation of this activity. In the instrumentation process, it is directed toward the subject him/herself, whereas in the correlative process of instrumentalization, it is directed toward the artifact component of the instrument. The two processes jointly contribute to the emergence and evolution of instruments, even though,

depending on the situations, one of them may be more developed, dominant or even the only one implemented.

Functions, which are products of these processes, are a characteristic property of the instrumental entity, and because in our perspective this entity is born of both subject and artifact, functions are also mixed in nature. They are rooted in both the artifact and scheme components of the instrument.

Our analysis will be based on two examples. The first (workbench) mainly concerns instrumentalization processes, oriented toward the artifact component of the instrumental entity. The second (ultrasound) is essentially relative to instrumentation processes, thus oriented toward the scheme component of the instrumental entity.

An example of instrumental genesis directed toward the artifact

Linhart's description (1978) of the workbench of Demarcy, a body repairs worker in an automobile factory, whilst inscribed in a sociological perspective, highlights two aspects: the instrumentalization the worker performed on the workbench, the transformations and adaptations allowing this artifact to be adapted to the range of tasks, as well as the correlating specificity of gestures, procedures and instrument-mediated activity schemes, which were themselves constituted during an instrumentation process of oneself over a long period.

Demarcy is in charge of touching up and removing dents from vehicle doors damaged on the production line. His workbench is an "undefinable engine, made of pieces of scrap metal and rods, various supports, improvised vices to hold the pieces, with holes everywhere and a disquieting allure of instability. This is no more than an appearance...When you watch him work for a fairly long time, you understand that all the apparent imperfections of the work bench have their uses: in a particular groove, he can slide an instrument that serves to hold a hidden part; in a given hole, he puts the rod for a difficult welding job; in an empty space underneath – which makes the whole structure look so fragile – he can hammer on both sides the car door already in a vice without having to turn it over. He has constructed, modified, transformed and completed this workbench himself.

"Now, they are as one. He knows its resources by heart: a screw here, a bolt there, a wedge moved up two notches, an angle adjusted by a few degrees, and the car door is in the perfect position for him to weld, polish, file, hammer in exactly the right spot, no matter how difficult it is to access – from above, below, the side, at angles, inside a curve or on an edge."

But when the workbench is to be replaced, the interlocking nature of the artifactual and schematic components of the instrumental entity is most apparent. The new workbench no longer has the holes that existed on the old bench allowing him to combine simultaneous action on both sides of the car door. "Demarcy's work rhythm is shattered, his method in ruins. Each time he has to work on a car door from underneath, he has to unscrew the vice, turn it over and tighten the screws again.

“He can no longer proceed as he was used to doing in fast, combined above-below movements, which are the easiest way of hammering a surface flat again. Before, he held a piece under the car door with his left hand and progressively moved it while with his right hand he gave precise taps, progressively lifting the dented bodywork, area by area. This is now impossible. He has to work on the recto and verso separately”.

Action schemes structured to allow simultaneous and complementary work with both hands can no longer be implemented because the artifact instrumentalized on the same grounds is missing. This drastic modification of the artifact the operator works with causes the destructuring of his instrument.

We can also easily imagine that if for some reason, such as a wounded hand, he could not implement his familiar schemes the instrument they constitute, in association with the artifact, would also be deconstructed.

An example of instrumental genesis directed toward the subject

Our second example concerns the utilization of a medical diagnosis tool: the ultrasound. The study carried out by Isabelle Ragazzini (1992)⁵⁸, grounded in an initial problematic of reading a still image, progressively moved toward a problematic centered on the construction of moving images, which as a result implicated an instrumental focus: ultrasound interpretation is performed based on moving images that the doctor constructs by tuning the device and the manipulation and movements he/she registers on the probe.

The probe and the tuning are two artifacts that allow the exploration and production of moving images of the patient's organs. These artifacts are inscribed in a pragmatic mediation: the result of their utilization is the construction of the image, which thus has the status of produced object.

This constructed image is inscribed as an artifact in an instrumental relation of epistemic mediation to the organs represented. For the image, the organs have the status of objects to be explored. Thus, the image, in the doctor's activity, has a double status: object to be constructed and artifactual component of a semiotic instrument serving to produce a diagnosis.

One of the interesting points of this study is that it indicates the evolution of instrument-mediated activity schemes⁵⁹ by comparing beginners and experts, particularly in the use of the probe. With beginners, exploration is based on a rigid scheme aiming at identifying organs through anatomical proximity. With experts, however, the exploration is oriented from the outset toward diagnosing the pathology. It is more selective and specific, relying on a comparison between the organ to be explored and reference organs, which may be anatomically distant

⁵⁸ For this example, we also refer to the presentation of this research by Weill Fassina (1993).

⁵⁹ The authors do not use this terminology, even though they are sometimes close: For example, Ragazzini refers to exploration schemas. Thus, we suggest reading their results in the light of our theoretical frame.

from the former. Beginners, however, take their marks from organs near the one to be explored and carry out redundant checks.

Thus it is by an evolution of exploration schemes that the expert's instrument differentiates itself from the beginner's. This is instrumentation. The artifactual component is not concerned⁶⁰. However, the images constructed have very different properties in line with the level of operator competence and in this way contribute to the evolution of the semiotic instrument in which they participate by a differentiation of its artifact component. This is instrumentalization.

Defining the instrumentalization process

Instrumentalization can be defined as process in which the subject enriches the artifact's properties. This process is grounded in the artifact's intrinsic characteristics and properties, and gives them a status in line with the action underway and the situation (in Faverge's example: mass for the spanner replacing the hammer).

Beyond the action underway, these intrinsic properties can retain the status of acquired function. For the subject, they constitute a characteristic and a permanent property of the artifact, or more exactly of the artifact component of the instrument. The acquired function is an extrinsic property, attributed by the subject so the artifact can be constituted as an instrument.

Hence mass, which is an intrinsic property of the spanner is not at the heart of the original function of this artifact (whereas it is clearly central for the hammer). However, the subject uses the mass of the spanner to confer on it new functions (for example, hammering in a nail). These new functions, when retained, have the status of extrinsic properties of the artifact thus instrumentalized.

Based on this example, which does not implicate the physical transformation of the artifact, we can distinguish two levels of instrumentalization by attribution of function to an artifact:

- On a first level, the instrumentalization is local, linked to a specific action and the circumstances of its occurrence. The artifact is momentarily instrumentalized;
- On a second level, the acquired function is durably retained as a property of the artifact in relation with a class of actions, of objects of the activity and of situations. The instrumentalization is lasting, or permanent. In both cases, there is no physical transformation of the artifact itself. It has merely been enriched with new extrinsic properties, acquired momentarily or durably.

The instrumentalization of the artifact can also imply its transformation, either consecutively to usage, as a consequence, or trace inscribed in the artifact; or

⁶⁰ The artifactual component is, however, locally concerned in a case in which the probe is used to examine the patient's abdomen and locate the painful area.

above all, by anticipation: the artifact is transformed to be adapted to its function. It can be an adaptation to the object pole, or to the subject pole of the triad. Operators in charge of analyzing nickel in New Caledonia, for example, transform plastic bottles into instruments allowing them to pour the mineral powder into the analyzer. To do so, they cut a spout (adaptation to the object pole) and a handle (adaptation to the subject pole).

This didactic example may seem trivial but it is enough to think of Damarcy's workbench to understand that the physical transformations of the artifact are sometimes liable to be far-reaching and of great complexity. They are not limited to the structure of the artifact and may also concern the functioning level. The same goes for artifacts in computer technologies.

The constitution of complex (macro) functions by a combination of elementary functions is an example of this in the domain of software packages. Hence, technical designers on CAD create software scripts that take care of tasks that were previously part of their own procedures and schemes (Béguin 1993 a & b Rabardel & Béguin 1993). But unlike our example of the nickel pouring instrument and the workbench, the transformations performed on the artifact are not usually irreversible.

Instrumentalization processes are not limited to technological artifacts. Falzon (1989 b) reveals that operative languages result from a transformation, by operators themselves, of the general system of representation that is language, so as to adapt it to the specificity of their communication needs.⁶¹ The elaboration of operative languages aims to render operative processing faster and more economical by an adaptation of means.

In a completely different context, in studies concerning structuring of the instrument among children, Mounoud (1970) produced results that can contribute to understanding our analyses. Children, placed in situations of problem solving, had to either construct or choose artifacts allowing resolution. Mounoud identifies the double adaptation of artifacts elaborated by the children to the subject and object poles of the triad. Yet this appropriateness is not obtained from the outset, or simultaneously. The artifact is first elaborated in line with the subject's actions and schemes to be then progressively adapted to the characteristics of the objects and the constraints of the situation. During resolution, the subjects enrich the artifact with new properties relative to this double appropriateness.

The evolution of the instrument by the enrichment of properties the subject attributes to the artifact thus appears as a very widespread phenomenon, not limited to work situations like those of our examples. The nature and modalities of the attribution are clearly specific to the level of genetic development (for children)

⁶¹ Falzon also gives a good example in the field of numbering. The oral system of numbering among the Mayas was strictly in multiples of 20. However astronomers from this civilization used a system with an exception: instead of indicating multiples of 400, the third level indicated multiples of 360. This irregularity was developed by astronomers for their specific needs in time measurement: days were grouped into months of 20 days, then years into 18 months, making 360 days (for further details, also see Ifrah 1985).

as well as the constraints and particularities of contexts (temporal scale, social nature of constraints, etc.).

Artifacts elaborated by children in an experimental situation contain functions that Mounoud calls constituents, particularly in relation with the characteristics and properties of the action itself. During their evolution, artifacts will finally carry out constituted functions that subjects progressively attribute to artifacts throughout the genesis process. Constituted functions primarily allow the establishment of appropriate relations between instruments and situations.

Clearly, we have no reason to suppose that in work situations, the temporal hierarchy between appropriateness to the action and appropriateness to the situation can be of the same nature⁶².

However, Mounoud's formulation seems particularly heuristic. The artifacts subjects are confronted with in "natural" situations (work, training, daily life) were elaborated to carry out pre-determined, intrinsic functions, constitutive of the artifact. These functions can be considered as **constituent functions**. Yet as we have seen, artifact instrumentalization processes throw up new functions momentarily or durably. These new, extrinsic functions are elaborated during instrumental genesis. They can be considered as **constituted functions**.

Nonetheless, we feel that the transposition of constituent function and constituted function concepts must retain a purely heuristic character and cannot be extended, without precautions, to the mechanisms of their elaboration.

Defining the instrumentation process

The subjects' progressive discovery of the (intrinsic) properties of the artifact is accompanied by the adaptation of their schemes as well as changes in the signification of the instrument resulting from the association of the artifact with new schemes.

Mounoud's observation is similar to those made by other authors of the Geneva school, such as Boder (1992) who describes, in a problem solving situation, the implementation of familiar schemes that constitute organizing elements heuristic for resolution. However, and this is a particularly interesting result in his research, actions and procedures resulting from the implementation of a familiar scheme can be attributed a new signification during execution and thus evoke and be reinterpreted as another familiar scheme. As is the rule in the Piagetian tradition, the author considers these familiar schemes as instruments.

⁶² Children themselves are aware of the specificity of constraints in work situations, as Vérillon demonstrated in a very good study (1988 c and 1991). He asked his subjects to invent artifacts allowing the production of different types of geometric forms (cylinders, cones, prisms, etc). The solutions put forward were very different, for the same child, depending on the context in which they were carried out. It was close to the action itself when production was unitary. It took into consideration quality and repeatability constraints when the reference situation was industrial production.

We put forward the complementary hypothesis, that in situations where problem solving requires the implementation of artifacts, familiar schemes constitute the scheme component of instruments whose artifacts make up the other component. Yet these schemes not only have a genesis. Like artifacts, they can be attributed new signification.

The genesis of these schemes, the assimilation of new artifacts to schemes (thus giving new signification to artifacts), the adaptation of schemes (contributing to their changes in signification), make up this second dimension of instrumental genesis: instrumentation processes.

The example of the ultrasound identifies exploration and construction schemes of different images for beginners and experts. We will give a second example, which extends the interpretation of data in a study on visual strategies in reading technical drawings (Rabardel, Neboit & Laya 1985).

Groups of subjects with different levels of competence in the mastery of technical drawing read a drawing composed of two views (frontal view and view from below) with the task of producing a third view. For all subjects the focus of their gaze was recorded throughout the test using a NAC Eye Mark Recorder allowing the simultaneous recording of the direction of the gaze and the field explored.

The well known phenomenon in technical drawing reading of concentrating on the frontal view was apparent, but differentiated depending on competence. The greater the competence level, the less they tend to focus on the frontal view, which we interpret as an indication of an evolution of exploration schemes implemented by subjects. This evolution is considerable in that the percentage of focusing on the frontal view and the view from below is very dissimilar for the least competent (80% versus 20%) and practically equivalent for the most competent.

The evolution identified here can be compared to the instrumentation processes of sensori-motor systems in babies identified by Bullinger (1990) and particularly the elaborations of sensori-motor organizations specific to text reading activities considered by Netchine (1990) as instrumentation processes allowing children to cognitively manage their own activities.

Likewise, in the domain of semiotic instruments, the catachresis of hatching described in the preceding section consists, not only in the attribution of a new function to the hatching artifact (instrumentalization) but also translates as the implementation of new exploration schemes allowing treatment on the perceptive level of problems otherwise requiring treatment on the signified level.

Different examples of catachreses that allow subjects to take back control of devices that should in principle escape them also supposes that these artifacts (automatic pilots, CNC program, automatic gearbox) are instrumentalized by the attribution of new functions, and that procedures compatible with this new type of control are constituted by adaptation of the schemes on which old procedures are based, by assimilation of the situation to other schemes or even by the elaboration of specific new schemes, organized around the new function, and organizing it in

turn as a means of the activity. Instrumentalization of the artifact is thus rounded off by an instrumentation of oneself.

Unfortunately, these processes that we call instrumentation processes as well as those relative to instrumentalization, have not been studied in depth. Instrumental geneses, processes of instrumentation and instrumentalization thus constitute a vast field of research that needs to be developed.

CHAPTER 9: MENTAL REPRESENTATIONS AND MODELS OF INSTRUMENTS

We will now examine the representative aspects of instrumental geneses. Instrumentation and instrumentalization processes by which the scheme and artifact components of the instrument are constituted require of the subject representative activity whose role in the structuring, control and regulation of actions is essential⁶³.

Representations for action

Mental representations in instrument-mediated activities belong to the most general category of representations for actions of a functional nature for the subject's action. This functional nature has been identified by several authors in a range of contexts and is designated by terms such as "operative image" (Ochanine 1978, 1981) or "functional representation" (Leplat 1985, Vergnaud 1985), as well as mental models (Veldhuyzen & Stassen 1977, Gentner & Stevens 1983). Ochanine (1978) defined the operative image as a specialized, non-universal informational structure formed during a particular action directed at objects.

The essential characteristics of functional, operative representations are primarily their finalization in relation to the subject's action and more generally, his/her activity. They have orientation and guidance functions for the action and this orientation generates their other characteristics analyzed by Ochanine and his successors.

Only some aspects of the situation are represented: representation is laconic. For economic reasons on the cognitive functioning level, it only includes elements pertinent for the action. Representation thus does not seek completeness, quite the contrary. The selection of elements based on the needs of the action leads to a functional deformation of the representation (as opposed to a representation seeking to provide a "faithful image" of what is represented). The selection of only elements pertinent for the action, as well as the accentuation

⁶³ Many studies, based on different theoretical movements, have been developed concerning mental representations of artifacts and technical systems. The domain of activities with instruments is well developed in the book "Representation for Action" Weill Fassina, Rabardel, Dubois (1993). We thus refer the reader to this publication.

of the most informative points in line with the task and the object of the subject's activity, are at the heart of this functional deformation.

The notion of mental model has mostly developed in the context of Anglo Saxon psychology. It shares with the notion of permanent representation the idea of the constitution of a cognitive representation that the subject retains over time. Young (1983) defines mental models as representations or metaphors elaborated by the user to guide his/her actions and help him/her to understand interactions with the device. Norman (1983) defines them as models elaborated by users in the interaction with systems and artifacts. They continue evolving in line with interaction. They are characterized by their functionality and are incomplete and unscientific in that they include beliefs bordering on superstition. They present a degree of instability (when certain aspects of the system are less often used, they may be forgotten) and aim to reduce the complexity of situations and simplify processing rules.

In Norman's definition, we find most of the properties identified for operative or functional representations. For this reason, we put forward the term "representations for action" to designate what is today dispersed among diverse names (Weill-Fassin, Rabardel & Dubois 1993).

Representations are adapted to tasks

Representations of artifacts constituted as instruments by the subject belong to the category of representations for action. They are distinguished from other mental representations of technical systems. While they too are representations for action, they are inscribed in other relations to technical systems. We will illustrate the most significant of these with examples.

Controlling a process

In situations of controlling dynamic processes such as running a blast furnace, operators construct both representations of physico-chemical phenomena that occur without direct operator intervention and representations of the effects of his/her own actions on the dynamic process.

Such schematic representations of operating phenomena have been formalized as a structural causal model on the grounds of descriptors of internal, not directly observable or measurable phenomena that must thus be inferred by operators (Hoc 1989, Hoc & Samurcay 1992). These representations of the evolution of processes are the grounds for the most efficient strategies. The technical system that constitutes the blast furnace does not have an instrumental status for operators. It is the site of the process that it is their task to control and manage and for that reason, they must have a representation of it.

In this case, operators attribute the status of object of the activity to the technical system and phenomena it is the site of, rather than an instrument status (even though, of course, they dispose of instruments to carry out their task, particularly operating aids, Rogalski & Samurcay 1993). Beyond the control of processes and the management of dynamic environments, it is this same status of

object that is one of the characteristics of the relation to technical systems in surveillance tasks.

Understanding functioning

The technical system also takes on an object status when the subject's task is to understand its functioning.

Thus, in the reading of a technical drawing of a mechanism representing a decompressor in a two-stroke motor, subjects had to construct a representation of movements relative to different pieces during the action on the command device (of a cable-shaft type) of the system (Rabardel 1982c).

In varying the structure of the technical system (the command device included either a mobile cable or a fixed cable), we were able to identify a great difference in the level of difficulty of the task: the movement of the cable is correctly identified by over 80% of subjects when the cable is mobile and by less than 20% when the cable is fixed. These differences are due to the subjects reusing representations for actions constructed during very different tasks, generally the adjustment of bicycle brakes, in which the cable is usually mobile.

We have called this mental model of the system "**pre-existing representation**". It was reinvested in the new context and depending on whether the pre-existing representation was coherent or otherwise with this context, it facilitated or constituted an obstacle to the construction of an objective representation of the current device. Functioning as an assimilating frame in neighboring or apparently similar situations is a general characteristic of representations of actions corresponding to a class of situations.

Identifying the origin of a breakdown

In maintenance and repair situations, the technical system also has a status of object for the subject. Bertrand & Weill Fassina (1993) analyze the evolution of representations of action in tasks of diagnosing a breakdown

They identify an evolution of their functionality for the diagnostic activity in relation with the development of professional experience. The least experienced operators focus primarily on the physical elements of the device and non-technical relations. Next, activities explicitly motivated by knowledge of relations between the different systems and observed symptoms appear. Finally, for the most experienced operators, the activity is more based on a group of action rules comparable to action schemes and procedures.

Whatever the level of experience, we can see that the technical system is apprehended as an object. The cognitive activity is oriented toward the identification of the nature of the dysfunction and its causes.

Assembling and disassembling a technical object

In the three types of relations to technical systems that we described above (understanding the transformation process of the internal matter of the system,

understanding its functioning, diagnosis of the causes of dysfunction) the technical system has a status of object within the subject's activity. This object must be known and acted upon so as to obtain more or less mediate effects.

This is also a characteristic of assembly-disassembly situations. This time, however, it is the structure of the object that needs to be represented so as to identify relations between the different parts that must be obtained during assembly: relations of positions as well as technically functional relations (Rabardel 1982 a, 1983 d, 1984 a).

These relations allow the definition of goals and sub-goals in terms of results to be attained. The subject must also construct a representation of a second type of relation: relations of forbidden assemblages that place different constraints on sub-goals and are an essential source of action planning in assembly by conditioning their order⁶⁴.

Using an artifact as a means of action

The different types of representations of artifacts that we outlined above, whilst functional, are not in the situations presented constitutive of instrumental entities: for the subject, the artifact does not have another status than that of structured object that functions or is dysfunctional, and is, in any case, the site of a process.

The status of the artifact represented in a situation of an activity with instrument is fundamentally different: it participates in the subject's instruments, i.e. the means of his/her action and not that of his/her objects. This heuristic distinction is not clear-cut in real situations: depending on the moment and on needs, an artifact can change status for the subject; these changes in status are similar to those that Douady (1986), in another domain, called the tool/object dialectic.

The instrumental status of the artifact implies that the subject has specific knowledge, linked to its function in the action. As Richard (1983) demonstrates, utilization rationale is not superimposable on functioning rationale. Hence, procedures, in the case of the utilization of software systems, are most often not deduced from knowledge of functioning rules, but usually from modifications made to known procedures to make them compatible with functioning rules and more generally, the constraints of the device.

Richard formulates the hypothesis that when a subject learns to use a device, his/her first objective is to find a procedure to attain the result he/she is after. It is only when it is impossible to succeed without understanding that he/she

⁶⁴ Relations forbidding assemblages are strict, transitive, anti-reflexive and anti-symmetrical. Some structural relations to be obtained among parts forbid, once they have been established, the production of other relations among parts. These relations must thus compulsorily be realized beforehand. Thus in an artifact made up of parts A, B, C, and D, if the relation between A and B forbids producing the relation between B and C then the sub-goal constitution of the B-C relation must be established before the sub-goal A-B.

takes an interest in how it works. What is difficult for a beginner is knowing which actions can be carried out with the commands of the device. At the same time, these are possible objectives and sub-tasks in a complex task.

Construction and contents of representations

Like Leplat and Pailhous (1981), we need to distinguish the initial constitution of the representation (meaning a mental model with some permanence) from its utilization. The two processes are clearly not mutually exclusive. The distinction between construction and utilization simply indicates the dominant pole, or main object of the subject's activity. Construction of representation participates in the instrumental genesis, whereas its use participates in putting the instrument to work.

Construction corresponds to the elaboration of invariants, or stable and pertinent features for the activity. They are relative to the artifact, the object and even the subject, i.e. to the characteristic poles of the situation of activity with instrument. Implementation implies taking into account the specific characteristics for the action situation, at very least by instantiation, and often by a more or less important reorganization of the representation. This corresponds to the elaboration of circumstantial, local and particularized representations (Richard 1990).

Construction of representations

We have already outlined the gap between utilization and functioning rationales and the difficulty of moving from one to the other. Yet is this difference the same for all users of a technical object? Does not designers' very in-depth knowledge of the structure and functioning of the system they have elaborated and their expertise in the field simplify the anticipation of utilization features?

A study on the use of a complex telephone contributes some answers to these questions in identifying designers' difficulties in constructing a representation of the real utilization of the system they designed. Hanisch, Kramer & Hulin (1991) compared the representations constructed by beginners and two types of experts (the system's designers and trainers in its usage). They were asked to indicate the similar use of different functions.

The two groups of experts' classifications were very different. This is not surprising given the nature of their respective activities in relation to the artifact. What is more interesting is that the designers' representations are very similar to those of novice users confronted with the same task. Designers' mastery of the functioning rationale is thus not a differentiating factor in performance: their initial representation of the real utilization rationale is not very different to that of beginner users. The authors refer to this as naive representation. It is true that the task they are to perform supposes a pre-established truly instrumental relation with the artifact given that they are asked to judge usage similarities.

We cannot conclude from this study that knowledge of the functioning rationale contributes nothing to comprehension of the utilization rationale in any circumstances. It would be interesting to follow, for example, the progressive

genesis of the representation of utilization rationale for both groups. It is probable that differences would be observed.

Indeed, even if the functioning rationale differs greatly from the utilization rationale, the latter also supposes the elaboration of mental representations and models of artifacts.

Churchill (1992), based on different studies in the literature shows that results of comparisons between presentations focused on utilization and on functioning of systems must be relativized. Comparisons mostly look at "instructions" that differ in terms of the information they provide.

Based on the author's own experimental studies, Churchill shows that users always develop mental models of the functioning of artifacts they use, even when they are presented to them essentially in terms of utilization rationale. This is particularly true when the problems users are faced with oblige them to consider the internal states of the system. Subjects who receive a presentation in terms of functioning rationale initially take longer to resolve problems but the difference disappears with practice. These results clearly match Richard's hypothesis. Churchill's conclusion, which we share, is that we must not only look at initial and final representations and competencies but rather at their genesis and development.

This is what Vermersch began studying in analyzing learning to use a cathodic oscilloscope. Despite very thorough initial training in the use of the cathodic oscilloscope, most of the subjects were at first incapable of tuning this type of device. In the first phase, subjects' activity focused on the spatial properties of the device: they manipulated all the knobs without distinguishing their roles, but rather in following the structure of the spatial layout. It is only in the second phase that the knobs linked to a particular function are successively manipulated and subjects deal with not the knobs but a mentally represented technical function (Leplat, Pailhous & Vermersch 1974-75, Vermersch 1976 a & b). The evolution involves progressively taking into consideration the machine's less external, apparent properties in relation with the activity itself.

Likewise, we have shown in educational robotics that the genesis of the representation of the artifact as an instrument involves a progressive discovery of the properties and characteristics of the machine. One of the issues at stake is the subject's understanding the specificity of "actions" and processing carried out by the machine and distinguishing them from his/her own activity (Rabardel 1991a, 1993 b).

Rogalski (1988), in analyzing the difficulties encountered by students in a programming task, reveals that some of these are not logic difficulties, but are born of insufficient or incorrect representations of the computer on which the program will be executed. The artifact has constraints and information handling modalities that the students do not always adequately identify. They tend to attribute the same knowledge and know-how to the machine as those they possess themselves.

This tendency was already identified in other situations by Laborde & al. (1985) or Mendelsohn (1986). The latter stresses that the construction of anthropomorphic representations of the machine is, in some cases, encouraged by the similarity between the machine's characteristics and the subject's functioning or familiar schemes. Subjects thus experience further difficulties in de-focusing and distinguishing the characteristics of their own functioning from that of the machine, while paradoxically, this similarity of functioning facilitates their initial entry into the system.

Mounoud (1970) also observed that young children, when they choose or conceive an instrument to resolve a problem, tend to attribute to the artifact the properties of their own action. It is only later that the properties of the artifact and of the subject's action are differentiated.

Finally, similar occurrences have been identified among adults, particularly in everyday situations. Hence, the after sales service of a company manufacturing electric coffee machines that work automatically receives complaints about the automated device not working. In some cases, the machine is not switched on (which of course prevents it from working): the user thinks the machine will do it, just as he/she did with a non-automatic model.

Representative Contents

Let us analyze more carefully representation contents in line with the type of reference rationale.

Chailloux's research (1992) on the use of heating programmers fits into a perspective of implementing an instrumental approach when designing artifacts for daily life. The analyses carried out among users indicate that their representations of this type of object are very different from those of designers⁶⁵. For users, they are instrumental in nature in that the artifact is considered as a means, or tool to act on the temperature in line with their lifestyles. For them, the programmer is a sort of temperature remote control; the distance it allows them to overcome is not spatial but temporal: "today I regulate the temperature of my bathroom at 22° for mornings to come".

For users, the main thing is managing the temperature that must be attributed to each moment in daily life as well as the range of domestic sites and the activities that take place in them. Time is not measured. It runs on a qualitative mode. It is no more than the support for significant situations of domestic life to which temperature must be tuned. For the subject, time has a marginal status when he/she regulates the temperature following his/her needs. With the use of the programmer, its status becomes secondary in that it has to be taken into account in order to act. Time is not primary: it is not on time that the user wishes to act. It is the condition and not the object of the activity.

⁶⁵ Chailloux defined "designers' representations" based on interviews as well as in analyzing technical documentation. Thus they should be identified more as derived representations from the design point of view.

The artifact, from a design point of view has a completely different status: it is a technical object acting on the heating system to pilot it in a variable way based on time. The artifact is first a temporal programmer. The main thing is time and this time is measured, runs uniformly on the quantifiable rhythm of clocks and not the qualitative rhythm of life. The artifact is apprehended in reference to that on which it must “objectively” act: the heating system. The user is considered as a supplier of data entries, which the artifact needs to function (days, lengths of time, required temperatures).

Two different visions of the artifact are thus opposed:

- the representation of potential users who see this type of device as a temporal temperature remote control or an instrument that allows them to manage it in line with their movements;

- The representation from the design point of view, focused on the functioning rationale in which the system is above all a temporal machine.

The representation of the two variables managed by the artifact are very different:

- for the user, time is qualitative: it corresponds to significant moments and situations in his/her life and runs in a non-uniform manner⁶⁶; for the designer, it is a quantitative, measured variable;

- temperature is a discreet variable for the user who considers its variations as changes in state; for the designer, however, it is a continuous variable.

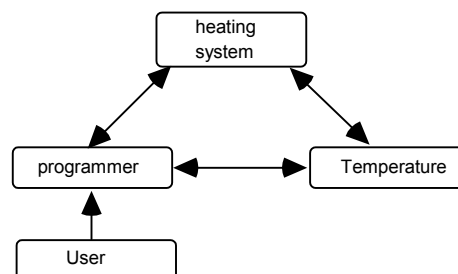

Figure 14

Representation from the design point of view (focused on functioning)

⁶⁶ The presence of the clock displaying the time on the artifact is sometimes interpreted as a supplementary function, or a sort of bonus: “If I don’t change the time in winter and summer it doesn’t matter. It’s the same for my oven. I don’t know how to change the time so I never change it. It’s not important for me because I always wear a watch...”

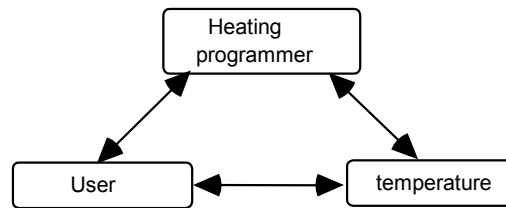

figure 15

Representation from the utilization point of view

Yet it is not the only source of differentiation in the representation of the artifact between the two points of view. The artifact combines two functions: managing temperature and managing time. In the representation focused on the functioning rationale, time management comes first (the artifact is a heating programmer); whereas for the user, managing temperature comes first (the artifact is a temperature remote control). The hierarchy of functions is thus inverted.

Finally, the vision of the user's role is also very different. For designers, the heating programmer is the actor which acts on the heating system and the user's role is to provide data entries establishing the parameters of this action. For users, the artifact is a means, an instrument of their temperature management in line with their movements; they are the actors.

Figures 14 and 15 express these differences in representation.

Are Chailloux's results, which indicate the profound differences between designers' and users' representations, compatible with those of Hanisch, Kramer & Hulin (1991) who on the contrary, indicate the similarity of their representations?

We feel there is no contradiction. In Chailloux's study, while the design point of view indeed defines a position for the user, it is in reference to the functioning of a technical object: the user supplies the artifact with data. It is thus not a position defined from the point of view of the user him/herself. He/she is not subject of the action. It is the artifact that is considered as actor.

In the study by Hanisch, Kramer & Hulin however, it is the user's point of view as an actor that the designers must assume: they must produce judgements on the similarity of the use of different functions. In this situation their knowledge of the functioning rationale is initially of no great use and we can see why their answers are similar to those of a group of beginner users.

In short, we can say that as designers, their point of view on use is often very different from real use (Chailloux's results on this converge with those of others, such as Norman & Draper 1986, Christians 1991). Yet when the same designers are invited to put themselves in the position of real users, they can initially find themselves, for certain tasks, in a situation similar to that of other beginner users.

Some characteristics of representations for action in activity with instrument situations

A group of common characteristics of representations in activity with instrument situations can now be identified.

One of the essential points is that these representations or mental models do not only concern the artifact but all the characteristic elements of instrument-mediated activity situations, particularly the three poles of the triad (subject, instrument, object), interactions among them, elements of the context pertinent for action and the action itself.

A second important point is that in most situations explored by researchers, subjects, at least in the initial phases, tend to attribute their own characteristics, properties, etc. to the objects on which they act and the artifacts that are the means of the action. Hence, the subject interprets the artifact's movements in terms of his/her own motricity. The object on which he/she acts with the instrument is conceived in the same terms as the object of the activity without instrument. He/she attributes his/her actions to the instrument etc. This attribution phenomenon appears to be very widespread. The consequences are very different depending on the situations.

When such a projection is pertinent, it fits into a process of assimilation to the subject's action and cognition schemes⁶⁷. Thus, a television remote control presented by Gaillard (1993) facilitates such assimilation: it can be used by a subject retaining his/her own spatial bearings, which correspond to those of the device. Likewise, in robotic training, some subjects manage to create a representation of a robot on the grounds of an anthropomorphic projection of their own body and motricity.

We also find examples of this assimilation in industrial robotics. Poyet (1993), for example, shows that subjects seek to locate themselves, in their minds, above or below the robot so as to bring their own spatial bearings (ego-centered) in line with the spatial bearings of the machine. It is the compatibility between the properties of the device and the subject's initial representations and schemes that allows successful assimilation. This is clearly not "given" but rather constructed by the subject's activity.

However, in many situations, this compatibility is not possible from the outset, nor is it easy to attain. Moving from an ego-centered representation, which for the subject consists in attributing the properties of his/her own actions or representations to the artifact, to an exo-centered representation constructing the properties of the real artifact, thus appears in this case to be a very widespread phenomenon. This evolution can take diverse forms and concern several different dimensions of the situation.

⁶⁷ Processes of assimilation to the subject's action schemes and cognition are not specific to the classes of situations we are interested in here. In the same manner, Rogalski (1987), in the field of mathematical and computer training, highlights the role of already constituted knowledge that functions as a **precursor** of knowledge to be acquired. This knowledge can play a productive role in facilitating the acquisition of new knowledge. On the contrary, it can be reductive when the student transposes inadequate aspects of his/her previous knowledge.

In research by Gaillard mentioned above, this evolution essentially concerns the conceptualization of transformations that the artifact imposes on the subject's motor action: he/she must construct a representation of the spatial transposition between his/her own movements and those of the slave arm. It also concerns the specific modalities of engendering actions by the artifact itself. Thus, in Poyet's research, when programming of the robot occurs through training, operators must move from a representation in terms of gestures (corresponding to their own activity during the training phase concerning the machine's trajectory) to a representation of the trajectory in terms of all the points corresponding to the real functioning of the machine.

Beyond representations of the artifact, it is the representations of the action itself and the object of the activity that will evolve.

Hence, in using a training robot, subjects transform their representations, both relative to the properties and characteristics of the artifact and to those of the reality on and in which it allows the operation of transformations (space, object pole of the action situation). The robot, initially treated as a displacement space where actions are extended, progressively becomes, for the subjects, a space of positions, complete with bearings defining all possible placings for the objects and the different parts of the artifact (Rabardel 1993 b).

Likewise, using new cognitive tools implies the construction of new representations of processes whose evolution they allow the subject to anticipate. These representations are coherent with those that constitute the tool. Hence, a tool that aids in managing forest fires implies a double change of levels to move from treatment and vision in terms of "real fire" to the notion of "possible fire". Furthermore, a software aid to thermal regulation of blast furnaces implies the construction of internal representations linked to the mathematical model of the process on which the software program is based (Rogalski and Samurcay 1993).

Representations relative to a class of activity with instrument situations thus include invariants relative to structure, the progress and control of the action itself and elements relative to invariants of the class of situations pertinent for the action. These invariants concern the objects toward which the action is directed, their properties, possible changes of state and their conditions or prerequisites, as well as, of course, the means and resources implemented, the artifacts and the resources of the subject him/herself⁶⁸. Objects, procedures and means of action thus appear to be strongly associated in representations. This association is constitutive of the signification of actions for the subject and their organization into semantic networks (Richard & al. 1992, Poitrenaud & al. 1991).

⁶⁸ Norman (1983) stresses that users very often have a representation of the limitations of their capacities and develop behavior that tends to make their actions safer and less likely to comprise errors. Likewise, Valot, Grau & Amalberti (1993) analyze the meta-knowledge that makes up the representations that subjects (fighter pilots) form of their own knowledge. Pilots use these representations of themselves to manage themselves as resources of their own activity in the same manner as the other resources at their disposal, particularly technological resources of which they naturally have representations as well.

Representations that are functional for the subject's action are, like all representations for action, laconic, schematic and partial.

The traditional interpretation of these laconic, schematic and partial characteristics of representations for the action is that for economic reasons, they only retain information pertinent for the subject based on the class of situations they correspond to. We hypothesize that these characteristics also come from the fact that representations, as mental models, cannot and must not reflect all properties liable to be pertinent for action (Rabardel 1993 b).

The incompleteness of the representation would not only be a consequence of an "economic" representation of the functionality and operativity of representations. It would also be a condition of the action's close adaptation to the specificity of situations. Representation would have to be incomplete, vague and uncertain to leave the leeway necessary for the implementation of mechanisms that handle specificity.

Indeed, uncertainty is an irreducible characteristic of situations that are complex for the subject, for which there is necessarily an element of uncertainty as to reality and its evolution, on the state and future state of situations, of the action and of the subject him/herself. This uncertainty can be linked to several causes: the dynamic specific to the evolution of the situation, non-anticipatable effects of the subject's actions, the functioning of artifacts that he/she associates with his/her action as instruments, etc.

The resulting incompleteness of the representation should thus not be seen as "not yet constructed" or "badly constructed", destined to progressively disappear, as for a beginner. This incompleteness is constructed, sought, managed and maintained as such by a competent or expert subject as a means of managing the complexity of situations:

- on a synchronic level, incompleteness provides the necessary "leeway" so different modalities of regulating the action can be articulated and coordinated in real time so as to manage the unpredictable specificity of situations;

- on the diachronic level, incompleteness allows the treatment of problems of different levels at different times. Vagueness maintained at a processing level limits constraints passed on to other levels⁶⁹.

This is why we have put forward the hypothesis that representations for action form a means of handling complexity for the subject. According to this hypothesis, uncertainty, incompleteness and vagueness must be considered as functional characteristics that constitute representations for the action in situations

⁶⁹ A good example is the management of incertitude in architectural design. Lebahar (1983) demonstrated that experienced designers intentionally maintain incertitude at a certain level during design. For example, when the designer is defining the topological relations inside a building (for example a bathroom running onto the toilets), he/she contentiously avoids simultaneously taking metric decisions that would lead to limiting maneuvers in topological decisions. In maintaining metric uncertainty, he/she retains the leeway essential to the activity in topological terms.

that are instrument-mediated or otherwise. These are the characteristics that engender the “leeway” necessary for synchronic and diachronic regulations⁷⁰.

CHAPTER 10: ARTICULATIONS BETWEEN DESIGN PROCESSES AND INSTRUMENTAL GENESES

In the preceding chapter we elaborated on the necessity of an analysis of instrumental geneses and instrumentation and instrumentalization processes. We will now examine relations between instrumental geneses and design process by starting with the new possibilities offered by contemporary technologies.

Toward a development of instrumental geneses with contemporary technologies?

The range of examples presented in the preceding chapter and the very contemporary nature of many of them indicate that current technologies have not reduced the reach and significance of instrumental geneses. A new development of these processes may be emerging with contemporary technologies.

For Levy (1990), who analyzes socio-technical evolutions linked to what he calls intelligence technologies, the final user’s usage, i.e. the subject we consider at a given moment, only pursues a chain of uses that pre-constrains his/her usage without fully determining it.

For Levy, the abstract and clear-cut distinction between means and ends does not stand up to an analysis of the socio-technical process in which, in reality, mediations (means, interfaces for the author) of all types reciprocally interpret one another to attain local, contradictory and perpetually contested finalities. This is true to the extent that the game of misappropriating a given means never remains attributed for very long to a stable end. Each author redirects and reinterprets usage possibilities of an intellectual technology, thus giving it a new meaning.

Levy sees design and usage as complementary dimensions of a same elementary connection operation, with its effects of reinterpretation and construction of new signification. While we may have a few doubts on the elementary nature of the operation, we can only agree with the idea that usage constitutes the other facet of design, notably in proposing reinterpretations not given in advance.

New possibilities not inscribed in artifacts by designers

⁷⁰ Three concepts are at the heart of the interpretive perspective that we propose: incertitude, incompleteness and leeway. These notions are also central for theories of complexity. Managing uncertainty does not allow aspiring to completeness and implies the necessity of leeway (see Morin 1984).

This user activity tends to be facilitated by computer-based technologies.

Contemporary artifacts, for example, seem to be evolving toward an inscription in their structure of functionalities facilitating their instrumental adaptation in line with the user's needs or wishes. Examples of this are the increasingly common offers of a personalized configuration of the interface of software packages⁷¹ and macro editors allowing the elaboration of complex functions by combinations of elementary functions (Jorgensen & Sauer 1990). Yet beyond this, we feel that contemporary systems are perhaps, more so than those born of traditional technologies, unfinished in a sense and thus open to a range of possibilities in terms of functionalities.

Let us look at Computer Assisted Design (CAD): the toolbox developed by a draftsman-designer who was an expert in the use of the software program (Béguin 1994). The designer developed several dozen new functions that did not exist in the commercial version of the software program. One of the new problems that designers working with CAD encounter (as opposed to those who work on paper) is managing the computer file that contains the graphic document. This file has a complex structure. It is made up of several layers (which are the equivalent of transparent sheets laid on top of each other) on which are stored diverse software entities (that represent graphic elements of the drawing in the progress).

The designer notably developed a function allowing the "freezing" of all the layers of the file except the one being worked on. With the computer system only handling one layer, treatment is much faster and the designer thus disposes of an instrument that does not slow down his activity, as was the case with the commercial software program. He also developed a command allowing the identification of entities: this gives the type of entity, its color, the name of the layer it is found on, etc. With the commercial software program, the designer had to collect information from three different spreadsheets. Furthermore, the graphic document disappeared from the screen during this search. Here too, the command developed by the designer improved the conditions of his activity. Many of the functions constituted by the designer were then incorporated in ulterior commercial versions of the software program.

The design of artifacts is indeed founded in a certain anticipation of uses but as the example of the designer indicates, their complexity is such, the diversity of possibilities is so great, that only a small number of them may be anticipated. It is in implementing systems that potential instrumentalities emerge, are revealed or invented. They are most often designed by the users themselves, alone or in collaboration with the initial designers. The artifact itself is thus thrown into question and also evolves. This can even become a design principal, as for example in the Utopia Project (Ehn & al. 1983, 1984, Bodker 1989, Bannon & Bodker 1991, Henderson 1991).

Rethinking the nature of design processes

⁷¹ It is necessary to distinguish adaptable interfaces allowing instrumentalization by the user, from adaptive interfaces in which the adaptation initiative belongs to the artifact.

Processes of instrumental genesis that we have revealed lead us to the problem of their relations to institutional design processes, i.e. what is usually considered as part of design in the production system.

The traditional schema that temporally distinguishes design and usage considers that after fine-tuning phases and perhaps installation, begins the usage phase, which is supposed to be no more than the implementation of the artifact. It is based on this schema that part of the instrumentalization process is considered as resulting from a misappropriation of the artifact. The interpretations that we put forward lead us to reconsider this schema. The design process does not stop where usage begins. It continues during usage in instrumental geneses, by processes of instrumentation oriented toward the subject (which is not really incompatible with the traditional schema), and by instrumentalization processes that directly target the artifact (which contradicts the traditional view).

We think that users, as actors of the process, are also actors of the overall design movement, though clearly in a different way from “institutional” designers. Users carry out a design for themselves, or individualization of the artifact that confers on it new, extrinsic properties that may even, in some cases, be structurally inscribed in the artifact. This design for oneself can also be performed by work collectives.

Design of the artifact is continued in usage: the extrinsic and constituted functions and properties extend the intrinsic and constituting functions and properties. In some cases, the constituted functions anticipate future constituted functions, as illustrated in figure 16. This is true, for example, in situations where users are to produce new artifacts, or when institutional designers are influenced by constituted functions created by users to implement them and make them constituting functions of a new generation of artifacts (as was the case for some of the functions developed by the draftsman-designer). Bannon and Bodker (1991) stress that artifacts evolve constantly. They reflect a historic state of user practice and at the same time they model this practice. The operations developed by users are then, in the following generation, incorporated in the artifact.

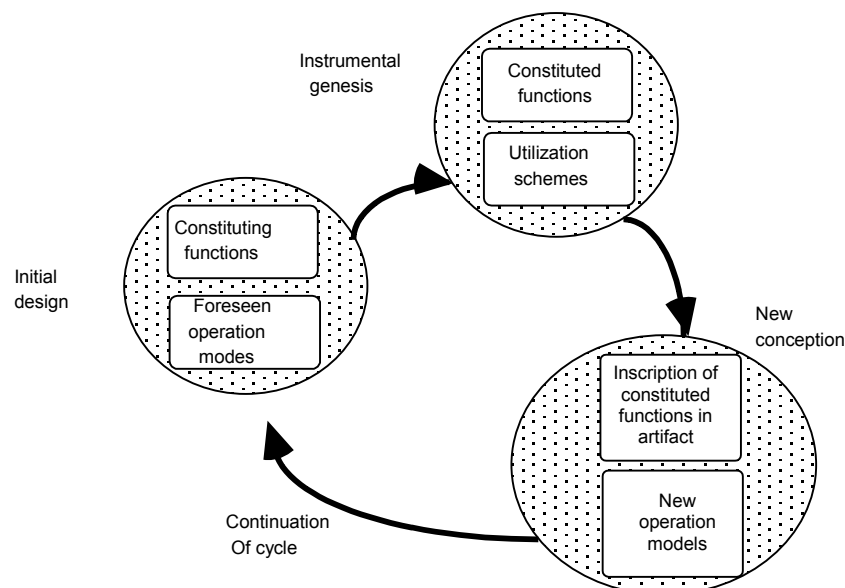

Figure 16

Inscription of the instrumental genesis processes in the overall cycle of designing an artifact

Instrumental geneses are thus part of an overall process in which constituting and constituted functions interact in reciprocal relations to one another. The actors of this process are both institutional designers and users (figure 16).

We outlined above the users' contribution to the design of artifacts. This is not their only contribution: instrumentation processes that constitute the other aspect of instrumental genesis also fit into the overall design cycle.

Institutional designers do indeed partially anticipate usage modalities in assigning the user a place and a practice. In the workplace, uses can be even more precisely anticipated and strictly prescribed through operation modes. Yet instrumentation processes lead to individualizing these operation modes, or anticipations, in line with individual particularities as well as classes of situations and their variables.

Social utilization schemes (usage, instrument-mediated activity and collective instrument-mediated activity schemes) are inscribed in the extension (in continuity as well as in breaking with) of operation modes anticipated in design. Furthermore, they foreshadow future procedures and operation modes. Finally, they can be diffused, for example, in work collectives.

Instrumentation processes thus participate in the design process and fit into a cycle:

Planned operation modes ---> utilization schemes ---> new operation modes;

This cycle is parallel and similar to a second cycle in which instrumentalization processes participate:

constituting functions ---> constituted functions ---> inscription of constituted functions in the artifact (fig. 16).

These two cycles are associated, although they are in a relation of relative independence. As we stressed earlier, depending on the situation, either the instrumentation or instrumentalization process can be more accentuated than the other or even the only one present. On a macroscopic scale, considering the overall movements in which instrumental geneses are inscribed, the relative autonomization of each of the instrumentation and instrumentalization processes could be even greater. This is why we think that schemes could inspire designers to create operation modes for artifacts very different from those with which they were originally associated and with which they constitute an instrumental entity (Rabardel 1991b). Likewise, artifactual evolutions produced by users may, during a later phase of institutional design, be inscribed in artifacts of a completely different nature.

Instrumentalization and instrumentation processes thus participate in the global design cycle, both jointly as a private instrumental genesis, and potentially in an autonomous manner by transfer or transposition to other design cycles.

However, whatever the possibilities of particularizing artifacts offered to users, the artifacts at their disposal and the pre-established or prescribed operation modes constitute an environment of constraints and possibilities that they must deal with. They constitute pre-organized forms with which the subjects are confronted in their instrument-mediated activities. The elaboration of actions and the activity as a whole sits in the tension between on one hand the anticipated, formatted and pre-organized aspects of the artifact and directions for use, and more generally, as Schwartz (1992) indicates, in the workplace by its prescriptions (that may remain implicit; Chabaud 1990) and on the other hand the user's efforts to reelaborate, restructure, individualize artifacts and usage modalities in terms of means, the instrument of the activity itself.

These different dimensions of action with instruments will be analyzed in part four.

PART FOUR: ACTING WITH INSTRUMENTS

In the preceding chapter, we analyzed questions relative to processes of instrumental geneses in subjects: the instrument is not given but is elaborated by the subject. This elaboration concerns the artifact and scheme components.

We will now examine questions relative to the use of instruments, their insertion in the activity as a means of this activity and the resulting recompositions and reorganizations of the activity.

This analysis can take place on several levels. It can, in particular, be focussed on the individual subject or on collective work. Our approach will focus on the subject. The essential problem of reorganizations in the collective activity system in the workplace is the object of a thesis (Béguin 1994).

In the first chapter, we will analyze the effects of utilization of instruments on activity and in a second chapter, we will analyze the question of the transparency of artifacts as a condition of activity.

CHAPTER 11: EFFECTS OF THE UTILIZATION OF INSTRUMENTS ON THE SUBJECT'S ACTIVITY - REQUIREMENTS AND POSSIBILITIES

In this section, we will look at the structuring effects of artifacts on activity and their limitations. We will present factors that are at the source of activity reorganizations: they correspond to constraints specific to artifacts that we will thematize by the concept of relatively required activity; they also corresponds to the resources they offer for action, thematized in terms of the expansion of the range of possibilities.

Structuring effects of artifacts on activity

The structuring effects of activity linked to the utilization of artifacts are postulated by several authors. Vygotsky (1930) put forward the concept of instrumental act to characterize the recomposition of the resulting activity as a whole. His analyses and theoretical intuitions are today a source of inspiration for many studies aiming to understand and sometimes provide means to handle such effects. Two of the authors (Payne and Hutchins), from whom we borrow examples that will allow us to explore the question of the structuring effects of artifacts on activity, refer explicitly to Vygotsky.

The first example concerns the field of human-computer interactions and more particularly questions of interface. Payne (1991) thinks that the fundamental point is that thought is formatted and molded, by artifacts and tools. The approach he recommends is the analysis of the way in which artifacts structure users' tasks and throw up new artifact-centered problems in providing new resources for the task that also allow it to move beyond these new problems. These are the two dimensions of requirement and possibility that we have ourselves identified in a developmental perspective (Rabardel & Véricollon 1985).

Payne identifies three characteristic dimensions of mediation specific to the artifact:

- the device represents the domain of the user task and he/she operates on representations rather than directly on the objects of the task;
- the operations are not directly carried out but rather are translated into actions by the intermediary of an artificial language;
- the user's actions must be coordinated with the system's actions.

The author thinks that one of the fundamental modifications of the task is that the conceptual objects that can be manipulated are transformed. He suggests analyzing the problem in terms of a machine-oriented problem space: the user must construct two distinct but coordinated problem spaces: the goal space and the machine space. The goal space represents the "outside world" that can be manipulated with the system (the minimal machine space must be able to represent all the states in the goal space). The machine space is made up of objects and files. The files are made up of a group of objects in a particular position and state.

Based on a systematic analysis of the drawing software program "Mac draw", he shows that the production of a standard drawing can be carried out via different paths that do not have the same properties: the history of a drawing influences its future developments⁷². Payne thus considers the artifact as one of the determining factors of the action. However, this determination by tasks and resources only partially constrains user activity.

Pavard (1985) sought to apprehend the structuring effects of artifacts on activity in analyzing the utilization activity itself. He bases this on the notion of pragmatic constraint introduced by Buxton to take into account the effects of the technical device on work procedures (Buxton 1982, Buxton & al. 1982). Pavard confronts his subjects with a reformulation task in a sentence of a text of three sentences. Four instrumental modalities are compared: typewriter, Dictaphone, pencil and paper and a puzzle simulating a word processor.

Pavard, like Gould (1980), Card & al. (1985)⁷³ shows that subjects' strategies depend on the type of artifact they dispose of to carry out the task. But he goes further in showing that performances themselves are different. The coherence of texts, for example, is good when the artifact obliges the subject to plan the sentence before writing it. This is the case for subjects who use the typewriter.

However, when the artifact gives the subject access to an already written text and editing functions that facilitate the transfer of elements from the text (puzzle

⁷² We have found neighboring facts in the domain of computer assisted design where operators anticipate the upcoming history of the drawing and structure the computer file in consequence (Rabardel & Béguin 1993p).

⁷³ For a concise presentation see Falzon 1989 a.

simulating a word processor), the coherence declines dramatically. This is due to the fact that this last modality allows a strategy of sequential treatment of linguistic constraints: the subject plans the thematic organization first, then attempts to reestablish coherence. On the contrary, the typewriter offered no editing possibilities so the subject had to simultaneously manage all linguistic constraints.

The author sees this as resulting from the effect of pragmatic constraints, which it most certainly is for the typewriter. Yet we can wonder whether the sequential treatment observed with the word processor is not in fact the consequence of the new possibilities offered by the artifact. Sequential treatment is not required by the pragmatic constraints of the device. On the contrary, it seems to us that it is made possible by the specific resources offered by this artifact. It is thus in terms of an expansion of the range of possibilities that these results should be interpreted.

Studies by Pavard and Payne concern situations in which the user is alone with his/her machine⁷⁴, but situations of professional usage are also very often characterized by the articulation or interlocking of private and collective dimensions of the activity.

Hutchins (1990 a) analyzes a situation of this type. He shows that the artifact structures action on an individual level, but also conditions the modalities of collective actions.

The author's departure point is the hypothesis of Simon (1969) according to which the resolution of a problem simply signifies representing it so as to render its solution transparent. He compares the utilization of four artifacts (or groups of artifacts) allowing the resolution of a given problem in different ways. The task is to calculate the speed of a ship in knowing the distance covered in a given time. The conditions compared are the following: pencil and paper resolution, use of a four-operation calculator, use of a specialized abacus, use of a trade rule (the three-minute rule).

The task is easier to carry out with the abacus or the three-minute rule. The author concludes that this is due to the fact that these two artifacts incorporate into their structure relations between the different terms of the problem, which thus eliminates the possibility of certain syntactical errors when the subject brings the different terms together. The artifacts thus restrict users' organization of the action, which eliminates sources of error and simplifies the solving of the problem.

For Hutchins, this type of artifact is not an intelligent agent interacting with subjects, or an amplifier of their cognitive competence. It must be considered as a transformer of tasks that modifies the cognitive nature of the problem and by consequence, the cognitive competencies necessary to its resolution.

⁷⁴ Payne puts forward analyses in terms of task and action grammars that are well suited to this type of situation. Procope formalism (Poitrenaud & al. 1990, 1991, Richard & al. 1992, Poitrenaud in press), breaks with this, particularly in considering procedures as properties of the objects of the device. This allows taking into consideration the diversity of objects in the evaluation of the complexity of the device.

In the same way, he shows that artifacts' characteristics also have a great impact on the modalities of the collective activity. Their degree of openness and their implantation are particularly essential points: artifacts whose utilization is public and observable in detail by other members of the collective create favorable conditions for competence acquisition as well as reliable decision making given that they can be controlled by several actors. The author thus advocates analyses of artifact usage that not only focus on private usage situations characterized by a user-artifact one-to-one, but rather those that also concern situations of collective activity.

In Hutchins' analyses, we again come across the two levels we feel must be distinguished: that of requirement (constraints and their structuring effects on the activity), and that of possibility (i.e. the resources, types of action and forms of organization that artifacts allow).

There are many examples revealing the structuring effects of artifacts on user activity, but these effects do not necessarily concern the activity as a whole. We must thus examine the problem of the limitations of effects.

Limitations of the structuring effects of artifacts on activity: analysis levels and focuses

To examine this question, we will take the example of a study carried out by Sébilotte (1993). The study is grounded in the hypothesis of Richard (1986, 1990) according to which knowledge relative to actions is stored in memory in the form of action schemas. The study aims to identify such schemas in administrative tasks and to study their reutilization when the work situation changes, particularly when new tools are introduced. Subjects are interviewed on the way they carry out familiar administrative tasks and schemas are deduced.

We will only retain the comparison concerning instruments: schemas from a given group of subjects were compared at a three-year interval, before and after computerization. The essential result is that the schemas remain globally stable as far as the structure of goals is concerned but are greatly modified as far as procedures allowing these goals to be attained.

The stability of goals observed by the author may seem to contradict the hypothesis of a recomposition of the activity following a change in instrument (even if the variation of procedures would seem to confirm it). In reality, these facts are not contradictory but allow us to better identify the limitations of the structuring effects of artifacts on activity and the conditions of analyzing these effects.

At a sufficiently high level of describing goals, the object of the activity (in this case, work) as well as the one or more types of transformations to be performed can stay the same. However, on the level of sub-goals, objects and corresponding transformations, the structuring effects can be felt. Yet it is precisely on this second level that we find the variable elements in the schemas analyzed by Sébilotte.

Indeed, the identity of the object (the matter or object to be worked on) and the transformation (change of state, maintenance of a same state) is what defines a function, i.e. an analysis level where we can go beyond the specificity of artifacts: artifacts that allow the accomplishment of a given transformation on a given work object constitute a class of equivalence on the function level⁷⁵.

Therefore, it is not surprising that a change of artifact can only have limited effects on the subject's goal level when these are essentially dependent on other determinations (often linked to the very definition of a job in the context of the workplace). If the choice of a new material is made, for example, in reference to goals considered as stable in the work situation, the new material must at least allow these goals to be attained. The stability of goals observed by Sébilotte would be, in this case, the consequence of an analysis carried out by the author on the same level as that on which the choice of new materials was operated.

Procedures are situated on the level of specific modalities implemented by the user to attain goals and are naturally liable to variation when the means of action change. One of the examples the author gives is enlightening on this point. For a given secretarial task – typing a scientific article – the schema of goals remains the same after the introduction of a computer: typing, presenting the results for rereading, correcting, keeping a copy on file, etc. None of these goals is directly dependent on the type of technical system that allows it to be attained, yet the specific utilization modalities of a word processor lead to a profound transformation of procedures.

However, the structure of goals could also be liable to transformation on another level: the collective activity level. The production of a scientific text may, for example, involve the author writing it directly on a computer and giving it to a secretary for correction. This transformation of the structure of goals is linked to the new possibilities and resources contributed by the artifact.

The analysis of recompositions of the activity linked to artifact use thus appears to concern different levels (several levels of goals and objects), yet also goes beyond merely focusing on individual activity to apprehend evolution on a collective level.

Expanding the range of possibilities

The reorganization or recomposition of activity linked to instruments occurs within two opposite but complementary directions: it is born of the different types of constraints that condition the subjects' action, and at least as fundamentally, from the possibilities of action offered to subjects. We have called these two

⁷⁵ The definition of function is specified here from the point of view of the functional analysis of artifacts developed by the technological approach. It is thus different from that used by Poitrenaud & al. (1990) who put forward four levels of analysis:

- a level independent of the device: tasks (Sébilotte's analysis of goals is situated at this level);
- three levels dependent on the device: the primitive actions that do not modify the system's objects (e.g. pressing a button), commands that modify the state of the system's objects (e.g. selection of a part of the text) and the functions that organize a group of commands (e.g. transferring to the paper press).

dimensions of structuring effects of artifacts on activity "required activity" and "expansion of the range of possibilities".

Variations of the expansion of the range of possibilities offered by the artifact can move toward an enlargement or a reduction of actions that can be performed with the artifact.

Types of transformations or changes of state of the material being worked on, for example, in using a machine such as a metal lathe are limited. This limitation itself is a constraint that weighs on the subject's action, but limitations also, and perhaps above all, make possible the emergence of new forms of action. New changes of state of objects (as opposed to work by hand) are, for example, accessible in conditions with renewed scope, speed and cost; new types of objects can also be transformed. In this sense, the use of an artifact can increase the subject's assimilating possibilities and contribute to expanding the opening of his/her range of possible actions.

Likewise the dimensions of structuring the action carried in the artifact can allow the subject new organization modalities for his/her action, renewing, for example, the conditions of reciprocal implication of goals and means, the sequencing of goals and sub-goals, control of the action, etc.

Yet the utilization of an artifact may also contribute to reducing the possibilities offered to the subject. In a study referred to previously (Duvenci-Langa 1993), the change from a manually commanded machine to a digitally commanded machine considerably reduced operators' possibilities of regulating manufacturing speed. The artifact was progressively instrumentalized so as to get back these regulating possibilities.

The subject's association of artifacts to his/her action thus leads to a reorganization of the activity linked to a variation of the expansion of the range possibilities, as well as activity required by the management of various types of constraints. We will now analyze this. It is in this sense that Vygotsky (1930) postulated a global transformation of psychic processes during what he called the instrumental act.

Required activity and types of constraints

We put forward the notion of required activity to define the subject's acknowledgement and processing of the constraints of situations of activity with instruments: for the subject, the artifact constitutes a group of constraints that impose themselves on him/her and which must be handled in the specificity of each of his/her actions. The constraints are obviously different following the types of activity in relation with the artifact.

For example, in the task of assembling an artifact, the subject must respect constraints (of structure and functioning conditions) that are different from those resulting from the functional utilization of the same artifact. In assemblage, structural constraints translate, for the subject, into actions of positioning relative

to each of the parts in relation to the others and their maintenance in position: functioning constraints in the functional conditioning of the artifact⁷⁶.

Like all realities, the artifact presents the subject with a group of constraints that he/she must identify, understand and manage. In doing so, it participates in the world of objects in the philosophical sense. We will call them “**existence modality constraints**”. Hence, a truck driver constantly manages his/her vehicle to ensure its non destructive functioning conditions are met.

Yet the artifact also carries constraints in reference to the nature of objects of the activity on which it allows the subject to act, as well as the transformation modalities it organizes and which also impose themselves on the subject, i.e. the constraints linked to the artifact’s finalization. While the existence modality constraints are linked to the general characteristics common to all material objects, the constraints on this level are linked to the specificity of the artifact as something destined to produce transformations. We call them “**finalization constraints**”.

A metal lathe, for example, only allows certain types of transformations of matter by removing shavings. The machine defines the classes of transformations, the possible changes of state and the conditions of these changes of state. These transformations can only be applied to certain classes of objects whose properties are specific. For our lathe, the objects must of course be metal (but no doubt not all can be manufactured: conditions of hardness must be respected for example). Extensions of usage can be envisaged to other types of objects with neighboring properties (e.g. hard plastics), but the class of objects on which it is possible to operate with the help of the artifact remains limited nonetheless.

Finally, the artifact carries constraints in that it includes, more or less explicitly, a prestructuring of the action of the person using it. The prestructuring results from the position and modalities of the action anticipated by designers and inscribed by them in the artifact’s structure and functioning, its operating modes, etc. We call them “**action structuring constraints**”.

This dimension is always present but seems to be increasing today in certain domains. De Terssac (1992), for example, stresses that expert systems contain an operator positioning and a more or less explicit prescription form of his/her actions and activity, which tend to reduce his/her regulation possibilities.

We put forward the hypothesis that only some of the constraints linked to the prestructuring of the action by the artifact concern the axiological dimensions of action ⁷⁷. This is either because the norms or values are constitutive of the artifact and implicitly impose themselves on the subject in an instrumental relation (as is the case in the example referred to above in the study on semi-automatic gear

⁷⁶ A detailed analysis of these concepts is presented in Rabardel 1984a.

⁷⁷ The axiological dimensions of the action are relative to the values and norms underlying the action.

boxes: Galinier 1992), or because in an assistance relationship, the machine's function is often to produce evaluations relative to the subject's actions and activity.

Hence, the artifact includes a prestructuring of the action, even if the subject does not inscribe his/her action in the constraints system, or more exactly choose the way he/she will insert the artifact as instrument in his/her action and insert his/her action in the prestructuring organized by the instrument.

Let us resume the three types of constraints carried by the artifact that have a structuring nature for the subject's activity. They are linked:

- to the properties of the artifact as a material or cognitive object; these are "**existence modality constraints**";

- to objects on which they allow the subject to act and to the transformations it authorizes; these are "**finalization constraints**";

- to the prestructuring of the user's action; these are "**action structuring constraints**".

Structuring modalities for multiple activities

Beyond these types of constraints, the nature of subjects' interactions with the artifact is also a differentiating dimension of activity structuring modalities in and by the usage of artifacts.

We will distinguish several modalities of determining activity by the artifact:

- **simple passive structuring**: the artifacts makes it necessary for the activity to be restructured around the form it constitutes. This is the case for hand tools that do not have their own functioning. It is probably the case for machines with a functioning that the subject does not need to take into consideration for its utilization (such as a simple watch);

- **organized passive structuring**: the operator's intervention fits into a procedural organization of the process (dependent on the machine's own functioning) which assigns it a place that is temporal (e.g. work with time restrictions), spatial (in defining the site of its actions) and operational (in defining the nature of actions and the organization of their sequencing). In the domain of daily life, a programmer (of a heating system, an oven, a VCR, etc.) is a good example of this type of action structuring: the user must follow a precise operation mode, which conditions success;

- **active structuring**: in this case, the artifact has knowledge of the operator (definitive knowledge or progressively adapted knowledge) and aims to modify his/her functioning, influence his/her activity (as in the case of an expert system producing a diagnosis) or even transform the operator him./herself (for example, certain teaching machines). Active structuring can be reciprocal in that the artifact both adapts itself to the operator as it knows him/her, and tends to influence and adapt him/her or at least impose certain characteristics of its own modalities and

functioning criteria. This reciprocal structuring could constitute one of the dimensions of the specific form of human-machine interaction that constitutes cooperation.

Activity is only relatively required

Our analysis would be lacking if we limited it to the structuring effects of activity linked to artifacts. Another source of activity structuring is constituted by action schemes that have private and social dimensions and are situated at several levels: the utilization activity level, that of the action in which the instrument is inserted as a means, as well as that of coordination of actions between different actors, humans and machines. The introduction of the scheme dimension jointly with the artifact dimension allows us to move from a hypothesis of a prestructuring of the activity by the artifact to that of a prestructuring of a much broader and less mechanical nature because it is born of the instrument in the sense in which we define it, i.e. as a mixed entity born of both the subject and the artifact.

It is clear that the idea of required activity must be qualified: the artifact cannot strictly determine activity, first because it is only one of the prestructuring elements alongside and coordinated with utilization schemes; second because many other sources of activity structuring exist beyond instruments, starting with prescribed tasks and operation modes; and finally because activity structuring is an ongoing process for which the subject inscribes him/herself in the specificity of the situations (in which he/she participates) and manages it.

We have shown how the usage of a training robot partly, and only partly, determines subjects' activity: it leads them to construct representations that clearly belong to the same family but are far from being identical and are constructed by subjects in following different routes (Rabardel 1993b).

The situation concerned learning to use a manipulating arm (figure 17). This artifact can be defined as a machine for moving objects in space. Two groups of subjects (pupils aged from 14 to 16) were confronted with identical tasks of object transportation (blocks) but in using different robot piloting devices.

One of the devices consisted of a command box with three mobile cursors (figure 18). Each cursor, of a different color, corresponded to a three-dimensional XYZ axis marker of the robot's workspace, so that each of the three cursors' positions determined the position of the extremity of its claw in that space.

The second device allowed the user to directly command the articulatory rotations from a computer keyboard: two keys allowed the command of each articulation.

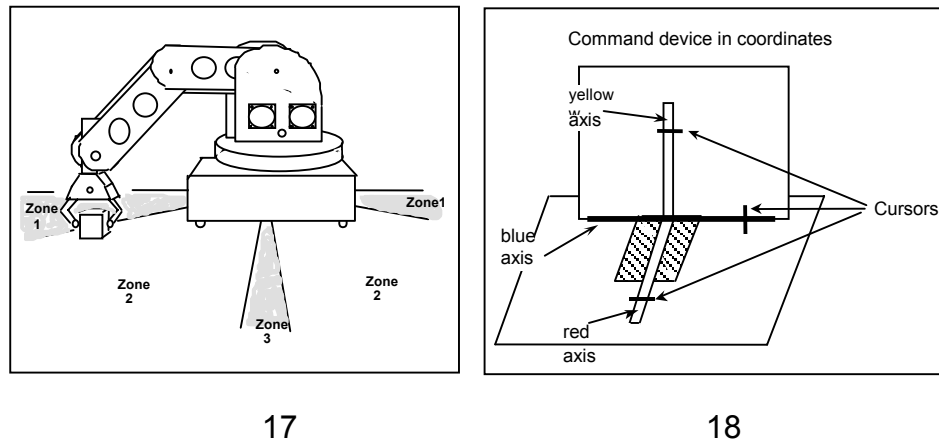

Figures 17 and 18, the robot and its command device

We hypothesized that the utilization of the “keyboard” device would lead pupils to construct representations in terms of articulatory rotations. This hypothesis was confirmed: there is indeed a representative activity along these lines required by the device.

We also put forward the hypothesis that the “cursor” device would lead to representations of space in terms of a three-dimensional markings system. Indeed, the cursor movement rails are orthogonal to each other and are positioned on the box in relation to a cross-hatched zone featuring the place occupied by the stand of the robot in its workspace (this last indication was provided to pupils). The command space (i.e. the orthogonal cursors and the representation of the stand’s position) make up a representation of the robot’s workspace. The experiment showed that the representations constructed are not structured immediately in terms of three-dimensional markers. Rather, construction takes place in stages and causes pupils some difficulties.

Analysis reveals various types of conceptualizations implicated in the microgenesis of the device’s properties and the corresponding action schemes. We retain only the three main ones here.

- On a first level, attaining the block and transporting it are performed by step by step management, under visual-motor control, of the machine’s movements by manipulating the different cursors.

The cursors are considered as linked to the movements of the different parts of the arm (articulations or segments). For example:

- The blue cursor is linked to rotation of the base;
- the red cursor to movement of the elbow;
- and the yellow cursor to that of the shoulder.

In this representation the cursors have no relation to each other and each of them relates to the specific parts of the machine. Actions consist in moving the

cursors independently and these movements lead to movements of the corresponding parts of the machine. This is a representation of the same nature as the “articulatory” representation induced by the second command device.

- However, the pertinence of this representation remains very limited and will evolve. The cursors will no longer be conceived as being in relation with parts of the robot but in relation to the movements of the claw in the workspace. The changes in the machine’s configuration resulting from the movements of the articulations and segments will thus no longer be a site of pertinent reading of the effects of the subject’s action on the cursors. It is the movement of the work claw that will be interpreted as the effect of actions. This is a radical transformation because the previously constructed dependencies disappear (dependencies between the cursors and parts of the robot) and are replaced by new dependencies between the cursors and the spatial position of the claw.

Correlatively, the representation of the action’s causality evolves: the claw’s movements become the consequences of movements that the subject imprints on the cursors. Initially, they are seen as having the same meaning and same direction, then in a second phase, as having proportional scope to those of the subject’s actions on the cursors. We thus witness a progressive conceptualization of a homomorphism between the geometry of the subject’s actions and the geometry of the claw’s movements, which are seen as their effects. However, these actions concern the cursors considered independently from one another.

- Finally, at a last level, representation is again profoundly transformed. Relations between the command space and the workspace are no longer conceived in terms of movement but in terms of positions. The cursors are no longer linked to movements in terms of directions but rather, to positions. As a result they become interdependent. The coordinated and simultaneous positions of the three cursors are seen in relation to the positions of the claw in the workspace. The relative positions of the cursors determine the positions of the claw.

Initially, these claw positions referred to the robot’s stand in the workspace, whereas the cursor positions referred to it in terms of drawing (the graphic representation) of the base on the commands device (see cross-hatched area fig. 18). In a second phase, however, they are defined in reference to a system of axes that defines groups of possible positions in the workspace. This system is common to (in that it contains) the robot, the claw positions, the objects to be moved and their different positions.

Use of the robot, as we see, leads subjects to construct representations that we can consider as belonging to the same family: that of direct control over the claw in the workspace (as opposed to indirect control by articulations characteristic of the keyboard device). However this family is broad: there are many possible arrival points and many paths that subjects will take to elaborate them. Many representations are functional for a class of situation and their functionality also depends on the strategies that subjects adopt, as demonstrated in a previous study using the same robot (Rabardel 1989).

A range of factors leads to an artifact's usage situations being specific to each subject. Determining the activity by the usage of the artifact is both effective and relative. For this reason, to designate it, we will henceforth use the notion of **relatively required activity**, thus marking the existence of control modalities of an ascendant nature (expressed by the idea of "required") and of a descendant nature, specific to each subject (which is indicated by the idea of relativity).

Relatively required activity translates the compromises the subject establishes between the constraints imposed upon him/her from a range of sources: artifact, task, environment, his/her own competencies and abilities, etc., given his/her finalization and engagement in the situation. This leads to thinking of required activity as a relative concept, or a tension between two poles: the constraints and resources linked to the association of the artifact and more generally the instrument to the action and the psychological subject him/herself, an individual and intentional actor.

CHAPTER 12: THE PROBLEM OF THE TRANSPARENCY OF ARTIFACTS

In this chapter, we will analyze questions relative to transparency, first distinguishing comprehension objectives from action objectives. We will then examine two transparency conceptualization families in terms of black box and glass box, which work on opposite principles. We will then put forward the concept of operative transparency, which we see as more specifically adapted to situations of activity with instrument. It will be analyzed in reference to situations, to action and to its temporal dimensions. We will conclude on the question of criteria of transparency.

Transparency to understand and transparency to act

The question of the transparency of artifacts is different depending on the type of activity the subject is engaged in. If his/her objective is to understand the artifact's functioning or structure (for example in training), what should be seen of the artifact will be different from what is necessary when the relation to the artifact is instrumental. Studies referred to above indicating the limited assistance provided by knowledge of the functioning rationale for the utilization of an artifact testify to this difference (Vermersch 1976, Richard 1983, Hanisch & al. 1991 etc.).

The constructor of a teaching robot that we used as an experimental support for studies referred to above attempted to render its machine materially transparent: the arms were left open to reveal the cogs and gears, the electrical connections were demonstratively left apparent, etc.

However, this effort which is pertinent in a pedagogical perspective when the machine is the "object of study", i.e. when students must understand its structure and functioning, only has a limited impact in utilization situations when it is an instrument. Many material elements, although they are "visible", are not taken into consideration in subjects' representations, whereas more hidden properties are reconstructed at the cost of great cognitive activity. The characteristic of these

properties is not their perceptive obviousness, through being visible, but rather their pertinence for action.

In this section, we only look at transparency in situations where the main relation to the artifact is instrumental in nature.

Two metaphors: “black box” and “glass box”

On trouve dans la littérature de multiples conceptions de la transparence. Elles peuvent être regroupées en deux familles principales thématiques autour de deux métaphores : celle de la boîte noire et celle de la boîte de verre.

- **The metaphor of the black box**

This conception of transparency is based on the principle of an invisibility of the artifact's technical system. The COST report, quoted above, in a chapter on gestural and tactile transducers defines, for example, two forms of transparency based on this principle:

- functional transparency: the operator feels he/she is acting directly on the environment,

- relational transparency (in this case, specific to medical applications): the remote-control device does not impede a direct relation between the operator and his/her human environment.

These two forms of transparency are relative to the instrument-mediated subject-object relation. The artifact is a mediator whose presence must not in any way obstruct the subject's relation to the object of his/her activity. The artifact is transparent like a window which does not impede a visual relation, while remaining perceptible (and constituting a sought-after obstacle, for example to the spreading of noise).

The relationship may of course be other than visual (and even perceptive, as the distinctions in the COST report testify). Hence, in a “Macintosh”, interface, the metaphor used (for example to put a document away in a file), because it is familiar to the subject, allows him/her to produce transformations on the objects of his/her work without needing to worry about effective modalities by which these transformations are carried out in computer terms. The technology of the machine is invisible under the metaphor, the only one accessible. It is in this way that it is a black box conception.

The perspectives developed by Polanyi (1958), Winograd & Flores (1986), Bannon & Bodker (1991) etc. are related to this conception in terms of black box but put forward distinctions in line with situations.

These authors consider that the orientation of the subject's activity is primarily directed toward the object when the situation is “normal” given the subject's competence. His/her awareness of the artifacts he/she puts to use is limited, or even existent. Artifacts constitute a sort of black box for the subject. But

when an accident occurs, the artifact can become, in itself, an object of the activity.

For Polanyi (1958), for example, users of a tool need information on two points. The main one is the interaction between tool and material. The secondary point is the interaction between the user and the tool. A good interface is one that disappears cognitively during usage of the tool and that we only deal with during unexpected situations. The user's needs are defined by the author as variable in line with the situations he/she is faced with. The necessity of visibility is put off to when unexpected situations arise.

Bannon & Bodker (1991) give as an example a carpenter who hammers in a nail with a hammer. They consider his action is normally focussed on guiding the nail but if the hammer does not respond to the carpenter's actions as he wishes, he then focuses his attention on the hammer which then takes on the status of object.

Winograd & Flores (1986) also exemplify this idea based on data entry on a computer system. The data entry implements a group of elements that includes the hands as well as the keyboard, screen, etc. It is only if a problem arises, for example, a letter does not appear on the screen, that the properties of these elements will become present, because they are pertinent in this situation.

Winograd & Flores use the distinction made by Heidegger (1962) between the status of things that are "available for use" and thus, as means, which are in a certain manner transparent in the action; as opposed to things which, following a break-down situation in the action, become "present to the hand" as objects of the activity.

The essential idea, shared by all these authors is that transparency is envisaged, not only in line with the artifact's properties, but also, and above all in line with its status in the activity, given the primacy of the object over the means. In common usage, the artifact, as a means, is transparent because the user does not need a conscious knowledge of it. This only becomes necessary in breakdown situations when the artifact takes on the status of object of the activity.

- **The metaphor of the glass box**

It seems to us that this second conception of transparency corresponds to an entirely different preoccupation: the artifact or a part of the artifact must be visible so the subject can take it into consideration in his/her activity. The assumption is thus opposite from that described above: the artifact must not disappear, but on the contrary be comprehensible by the operator in line with his/her needs given the activity underway.

Valot (1988) for example, demonstrates that military pilots develop strategies of active confidence in their systems (constantly liable to sudden deviations and breakdowns). These strategies are based on the search for redundancies, the confrontation of totally or partially independent pieces of information... It is precisely because these systems are not transparent enough (in the glass box sense) in terms of reliability, that the pilots develop these strategies.

Likewise, Payne (1992) highlights the necessity of this type of transparency in human-computer interactions. When the system is too obscure or invisible, users, who have to understand in order to act, construct representations analogous to familiar fields, which often causes problems.

The necessity of a glass box type transparency emerges more particularly with technological systems known as intelligent. Thus, Amalberti (1991) suggests that auto-pilots on board airplanes be programmed in such a way as to be easily comprehensible to the operator. He considers that there is a great proximity between this type of reasoning programmed in the intelligent system and the type of reasoning that the operator can drive and understand. Amalberti describes this proposition as born of the "Glass box" or transparent box concept developed by Woods (1986), Rouse & al. (1987-88).

Likewise, Lehner & al. (1987) indicate that during the use of an expert system, users must possess a good representation of the system's functioning modalities. This representation facilitates their understanding of the recommendations and explanations provided by the expert system, particularly when the problem solving approach that the system implements is substantially different from that of the user.

According to Roth, Bennet & Woods (1987) a condition of this is the possibility of the existence of expert systems as cognitive instruments. The operator must have access to means allowing him/her to understand the state of the system being investigated as well as the state of the problem solving process, particularly: the machine's knowledge of the state of the world, the hypotheses considered or rejected, those being explored, etc.

All these approaches converge around the idea that users need to understand the system's important characteristics (state, functioning, reasoning underway, etc). They must be visible to the operator. From this point of view, the system must be a glass box, in that it shows of itself that which is pertinent to the subject. This visibility is not static, as the idea of the glass box could suggest. It is liable to multiple modalities that may go as far as the machine itself explaining its own activity (Cahour 1992).

Based on three examples, we will see how these conceptions of transparency in terms of black box and glass box are liable to adapt themselves in a range of ways in line with situations. Our examples come from a book about representations for action in activities with instruments (Weill Fassina, Rabardel & Dubois 1993).

The notion of functional transparency is developed by Gaillard (1993) concerning remote-control systems⁷⁸. The author considers these systems as extensions of elementary functions: moving the hand, manipulating, moving oneself, etc. The user thus goes from doing to having done, and his/her action is

⁷⁸ Remote-control allows the execution of manipulation or locomotion functions in a real or fictitious environment using a complex physical device that can be commanded by a robot or a human operator.

mediated by the technical device. Four main criteria define functional transparency. They are defined based on a technical analysis of the remote-control system:

- isomorphism criteria: articulatory links between the operator's arm and the arm of the slave system ⁷⁹;
- orientation criteria relative to the operator's and the slave arm's spatial bearings;
- geometric criteria: angular variation between the movement of the operator's motor command and the slave arm's execution movement;
- dynamic criteria: links between the command variables and the commanded variables

These four criteria should allow a hierarchization of remote-control systems following a functional transparency axis. For Gaillard, the ideally transparent system would be one in which there would be no transformation of the command signal emitted by the operator. The system would behave effectively as a simple extension of the operator's motor functions. It would then be a mere intermediary, introducing no transformations unwanted by the subject in his/her relation to the object of his/her activity. This is a **black box** conception.

The notion of the cognitive transparency of operative cognitive tools is put forward by Rogalski and Samurcay (1993). The differing degrees of cognitive transparency of tools determine operators' cognitive demands. For each individual operator, they define the degree of accessibility of knowledge, procedures and models underlying the functioning of the tool given the demands of the task to be accomplished.

The transparency criterion is the proximity to subjects' initial representations: thus, the closer an external representative tool is to operators' initial representations (relative to processes represented and operations carried out) the more transparent it should be for operators, i.e. easy to apprehend. The underlying perspective to this conception is this time of a **glass box** type.

In an experimental situation in industrial robotics, Poyet (1993) discusses the conception of command interfaces whose non-operative and non-pertinent functionalities for the action constructors try to render transparent. They lead operators to deduce functioning rules that become more erroneous as dialogues gain in complexity.

The insufficiency of the system's transparency and its inappropriate nature may be disruptive factors. They prevent operators from doing experimental tests to check hypotheses generated by the observation of functioning regularities.

⁷⁹ In a remote-control system, the slave arm is an effective sub-group subservient to another sub-group, which may be a master arm. The latter receives motor commands from the operator.

Operator's representations then take the form of vague expectations managed by a range of precautions and sometimes even rites.

On the other hand, transparency adapted to the needs of the operator's activity allows him/her to ground his/her representations of reliable invariants allowing an "experimental" use of data presented on the screen. The operator can then confront this information with a variety of situations to elaborate rules.

Poyet's analyses, like those of Rogalski and Samurcay, fit into a **glass box** type conception.

Towards a conceptualization in terms of operative transparency

The conceptualization that we propose in terms of operative transparency also fits into the "glass box" paradigm.

We will begin with an example. It concerns an artifact from everyday life: the citrus juicer by Legrand, Boullier, Séchet, Benguigui (1991). For users, this artifact has all the signs of belonging to the electrical household appliances category: a cord (for plugging in), a motor (to make it work), a bowl or recipient (to receive or contain the foodstuff to be processed), a rotating element (to chop, crush or juice, etc.) and a cover to protect the user from accidents due to fast rotation.

However, the usual utilization procedures must be adapted to the particularities of the artifact and appropriate representations constructed:

- the hand holding the half piece of fruit must be placed directly on the spinning filter top, whereas with other household appliances, contact with the rotating element must be avoided at all costs (a protective device often serves to prevent this);
- the appliance does not have an on/off button and the cover (which usually serves to turn on the machine) must be removed to make it work.

The usual mental model for this family of artifacts cannot be applied to the citrus juicer. The user must discover its specific properties: the cover must be removed to make it work, the spinning top sits on top of the axis and serves as an on/off button, etc. The external appearance of the artifact encourages inappropriate actions in the naive user⁸⁰.

The artifact, as a household appliance, is not transparent enough given the user's initial needs for information to make it work. Naturally, as soon as the same user masters the principle of this new appliance, the problem will be very different and the appliance will be transparent enough to allow easy usage.

⁸⁰ Of course, as Maryse Laurent indicates, the confused user may also attempt to use it as a manual appliance: placing the half citrus on the top, the appliance starts up thus solving the problem.

An artifact's transparency must be seen in light of the user's needs for information, which vary in line with his/her goals, competencies and the strategies implemented to attain them, etc. Transparency must be in reference to the user and his/her activity. This is why we propose the concept of **operative transparency** to designate the characteristic properties of the instrument pertinent for the user's action, as well as the manner in which the instrument makes them accessible, comprehensible, and even perceptible for the user.

Operative transparency is a relational concept that expresses the variability of the subject's "information" needs in line with the variability of action situations as well as its states and its goals. It can take diverse forms: intelligibility of transformations between command actions and effects, indicating the functioning modalities inherent to the instrument, self-explanation, etc.

Operative transparency depends on: the distance that the instrument places between the subject and reality, i.e. the object of his/her action; on the complexity of operative and representative schemes necessary to its utilization; as well as on conditions of assimilation to the subject's schemes and the adaptation to these schemes offered by the artifact given its internal and external characteristics.

Approach to operative transparency in reference to the situation

Operative transparency can be analyzed in reference to different aspects of the situation (presented here in reference to the I.A.S. model):

- the structure, functioning and behavior of the machine itself: this would be an internal transparency in that the artifact would show or even explain aspects of itself that are pertinent for the subject's action;
- the object on which the operator acts with the help of the artifact, its characteristics and its properties as they are taken into consideration by the artifact and pertinent for the action;
- the interactions between the artifact and the object: nature, forms, contents.

Operative transparency modalities may be diverse and more or less pertinent depending on classes of tasks: intelligibility of transformations between command action and effects, revealing schemes inherent to the artifact (of functioning, modalities of engendering effects, etc.), rules on moving from commands to effects, etc.

Roth & al. (1987), referred to above, stress the opacity, or non-transparency, of the expert system with which they conducted their experimental study. This allows the deduction of the characteristics of operative transparency it should present. The system is non-transparent on the following points

- state of reasoning, making it impossible for the operator to know whether he/she should intervene (necessity for transparency of the state and evolution of the treatment process);

- data treated, making it impossible to appreciate the validity, the truth (necessity for transparency of objects treated)

- state of current hypothesis: is it correct? (necessity for transparency of the type of treatment);

- has the machine reached the limitations of its domain of competence? (necessity for transparency of the system's competence given the subject's goals and the type of problem to be treated: can the artifact still be a pertinent instrument for the subject's activity?).

Approach to operative transparency in reference to action

Operative transparency is relative to the user's action with and on the instrument. Thus it varies in line with classes of goals (for example, for a robot moving objects in space as opposed to operating maintenance). It also varies for the same operator and the same class of goals following the demands and constraints that the operator must manage. Hence, moving an object with the help of a robot implies very different representative demands depending on the constraints imposed on the action: no trajectory constraints, the shortest trajectory, the cheapest possible, etc.

Operative transparency can be analyzed in reference to the different dimensions of the action. We will work based on the distinctions put forward in the collective publication edited by Inhelder & Cellérier (1992).

Operative transparency can be relative:

- to phenomenal, **physical causality**, inherent to the artifact. It concerns its structure, its functioning, and even how it is undertaken (as, for example, with systems producing reasoning), or at least that which is pertinent for the subject's action. Diagnosing that the knife with which we are trying in vain to cut a tomato is not sharp enough is an example of judgement in terms of physical causality;

- to the **instrument-mediated action causality** of the subject oriented toward the object. It can particularly concern the interaction of the artifact and the object in terms of changes of states of the latter and the conditions of these changes. Diagnosing that the knife is not the problem, but that the way it is used prevents the tomato from being cut is an example of judgement in terms of instrument-mediated action causality.

- to the **action's teleonomic dimensions**: they concern both the subject's action affected by the artifact and that of the artifact when it has specific behavior that is not merely the extension or copy of that of the subject. For example, the artifact may have its own goals that it fixes itself or that are fixed externally by the constructor, another operator and sometimes the subject him/herself;

- to **axiological dimensions**: they concern values carried by the artifact that condition the subject's instrument-mediated activity (values and evaluations relative to the system's goals, to the organization of its action and that of the subject, etc.). The example of the automatic speed box (Galinier 1992) is

particularly instructive on this point: the machine, by its construction, has an evaluation system to decide whether or not it is time to change gears (instantaneous state of the road-truck system) which is different from the subject's, which is based on the anticipation of upcoming driving conditions.

Operative transparency is inscribed in time

The temporal dimensions of operative transparency depend on its relation to action: operative transparency is oriented simultaneously toward the present, the future and the past ⁸¹:

- by its orientation toward the present, it must allow a representation of the situation in real time and the regulation of actions. Hence, one of the major difficulties of remote-control in space is the impossibility of having real time returns on the effects of actions: the distances between satellites and the earth causes transmission delays of up to ten minutes;

- its orientation toward the past must allow the interpretation of current situations in line with their genesis or history (which explains the importance of background reports in the workplace, for example in situations of procedure control: the current state of a blast furnace can only really be interpreted in light of later evolutions). It must also allow the interpretation of past situations, incidental or otherwise, in a perspective of developing experience, invariants, schemes and operational structures;

- finally, it is oriented toward the future in that it must allow anticipation of the effects of actions (on the artifact, of the artifact on the object etc.) and thus allow anticipation of actions, their structuring and their effects;

Transparency toward the past could thus be one of the conditions for elaborating invariants corresponding to classes of situations: the characteristics and effects of actions must be brought together in real time and *a posteriori* for them to be interpretable, not only as local properties or specific situations, but also in terms of characteristic invariants of classes of situations and actions.

Transparency toward the future could be a condition of preserving schemes and invariants relative to classes of situations. This preservation would be linked to their functionality in and for the activity given its finalities. Transparency toward the future, in allowing prediction and anticipation would allow, due to the same functional role of anticipations in subject conduct, the preservation of invariants and schemes that make these anticipations possible.

Operative transparency responds to differentiated criteria depending on objectives

⁸¹ Let us note that specific types of aid correspond to orientations of transparency toward the past and future. In process control, for example, we find:

- background reports that render transparent the past dynamic of the procedure and allow interpretation of the current situation in light of this history;
- anticipations which give indications on the possible evolution of the process and in some cases, on the predictable effects of the envisaged actions.

Operative transparency is by definition relative to the action and its finalities. Its criteria are thus variable depending on the finalities of actions.

Thus, for an artifact used instrumentally for professional ends, criteria of transparency will seek to make the action easier, safer, more reliable, etc.

In a training perspective, criteria may be completely different. For example, it may be preferable not to make the action easier, but on the contrary, to construct constraints on this action so they lead the subject to operate cognitive constructions that he/she is required to elaborate.

With this question, we look at the issue of the diversity of transparency criteria in line with domains of application, the problem of implementing an instrumental approach in different fields (work, training, daily life) where it can contribute to the comprehension of problems users are faced with and the elaboration of solutions. This is the aim of the last part of this book.

PART FIVE: APPLICATIONS

The importance and pertinence of an approach in terms of activities with instruments shows up in several domains. In research, it is when we need to understand the fundamental mechanisms underlying psychological and social processes implicated when humans use artifacts as a means of their actions. In reality, this is true of most situations given that in all circumstances, an action requires the means of its realization: in different fields of intervention – or application – such as work, training and daily life; when we need to design artifacts adapted to human activity or organize work in such a way as to ensure it does not damage their health, when developing their competencies while being technically and economically efficient; or again when they are in training.

The last part of this publication will be organized around the implementation of the instrumental approach in three essential functions: analyzing, designing and training. We will present these applications via a series of examples in avoiding too much dissipation in different fields so the reading does not become too complex. We will go back to the theme of design activities with CAD for each function. It will thus serve as a guiding thread allowing us to apprehend contributions and modalities of the implementation of the instrumental approach using same theme explored from different angles.

ANALYZING

Throughout this publication, we have given a series of examples of analyzing activities with instruments. In this last section, we would like to present two more examples, this time stressing the articulation between analysis levels.

Analyzing the properties of objects truly taken into consideration in activity

Our first example concerns the instrumental analysis of CAD files (computer-assisted design). Information on the drawing of the object during design is stored in the file and the file is mostly seen only in this light by CAD software producers.

The instrumental analysis that we carried out (Rabardel & Béguin 1994, Béguin 1994) with professional draftsmen-designers working in engineering revealed that the status of files within their activity cannot be understood only on these grounds. The file is simultaneously a product of activity, a material to be worked on and a tool. With the statuses of material to be worked on and product, the file occupies the object pole of the tripolar model. With the tool status, it obviously occupies the instrument pole. The file thus changes status for the operator in line with the different moments and the orientation of his/her activity.

Furthermore, these different statuses comprise often-contradictory demands. Hence as a product of the activity, the file must have specific structural characteristics (for example, when the customer imposes its own structure). Designers also manage the assignment of entities that represent the object being designed on the different levels of the file following different types of logic. A type of structuring could, for example, allow production in the same file of different plans corresponding to the stages of producing a construction. However, a

structure by types of technical elements allows the production of documents focused on types of technical systems (for example, the pipe circuits of a particular fluid).

File structuring choices made by the designer are based on anticipation of upcoming work. They are also the product of knowledge, particularly the utilization schemes of the system it constituted. These choices and the specificity of the knowledge give rise to great diversification of file structure compared with the canonic structure anticipated by the software programs. This diversification is problematic for the exchange, sharing and reuse of design data. In the example presented, instrumental analysis allowed an understanding of the causes of the crisis facing the company: due to the specificity of their individual structures, the files could only be reused with great difficulty, leading to missed deadlines, additional cost and an increase in tedious tasks.

Analyzing with the aid of the instrument-mediated action situations model

The tripolar model is an analysis tool allowing detailed apprehension of a subject/ user/ operator's activity. Our second example concerns the analysis of the starting phase of a machine-tool used for manufacturing millstones. Observing the activity allowed us to produce a description, a fragment of which follows:⁸².

“The operator pushes the millstone against the lower jaw (made up of a leather-lined ferrule). He tightens the jaw with a mechanical lever while he puts the millstone into position with the left hand. He checks the contact between the millstone and the wedges (the millstone must lean against the mandrel wedges). He turns the mandrel with the left hand, checks the millstone contact again, tightens the jaw with the lever and closes the lid. He turns on the mandrel with the start button. He positions the knife on the millstone by pushing the lower carriage to the right with the hydraulic lever. At the same time, with the other hand, he turns the wheel of the knife and keeps eyes fixed on the lathing operation. He turns off the mandrel, waits for it to stop, takes the caliper rule and measures the thickness of the millstone. He starts again...”

The analysis presented in diagram 19 is carried out in reference to the tripolar model presented in chapter 4. The different elements of the description are analyzed based on their status within the activity: Subject = S; Action = A; Objet = O; Instrument = I (on the right of diagram19). Each significant action is analyzed in terms of interactions (for example O/I = object/instrument interaction). At the same time it is qualified on a technological level (example Pip = placed into position, Mip = maintained in position). Finally, the different actions are grouped into phases that are technologically identified (assembly, starting, manufacturing, etc.).

⁸² We owe this description to Stella Duvenci-Langa who is currently preparing her thesis in ergonomics.

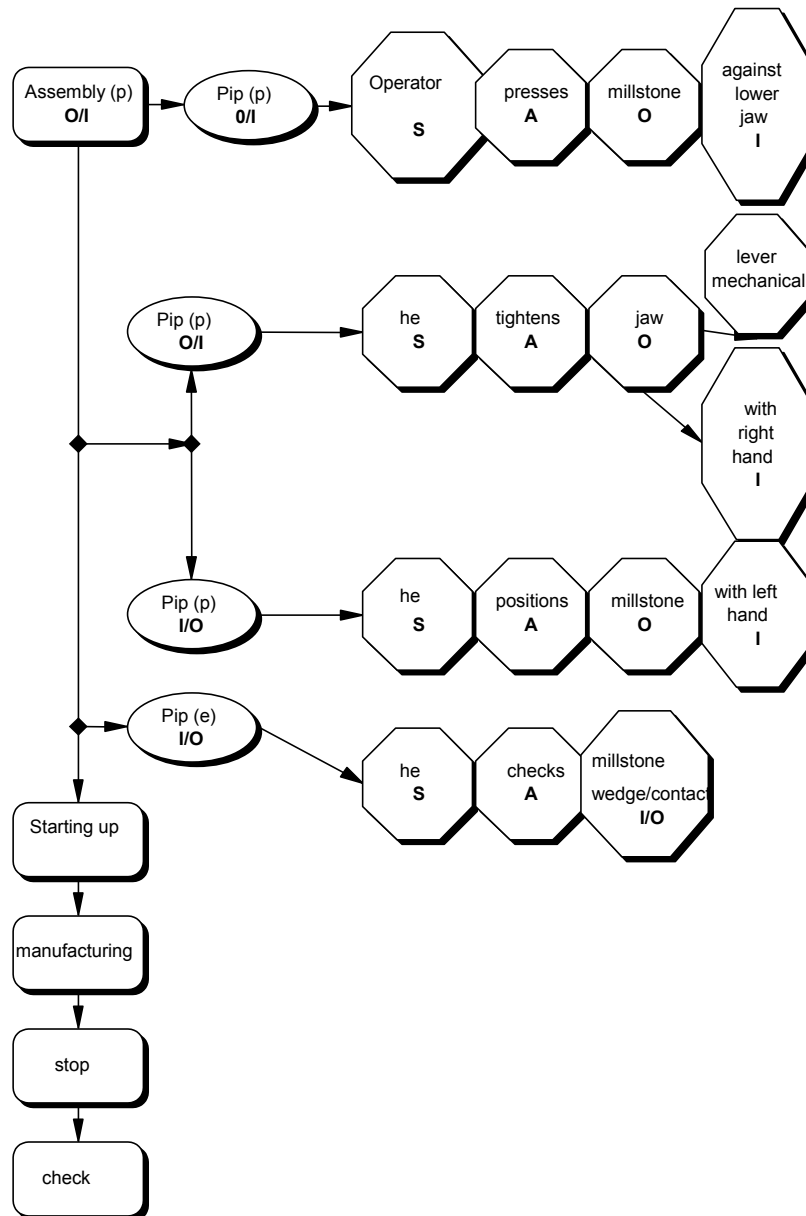

Diagram 19

Example of analysis based on a tripolar model of activity on a machine-tool

We note that the analysis presented allows us to move from an approach in terms of activity (in this case, limited, so as to simplify, to a behavioral description) to an approach in technological terms. The operational analysis of human activity is thus linked to the functional analysis of the technological process⁸³. The vocation of intermediary conceptualization of the tripolar modelization becomes evident. It allows the production of analyses that help

⁸³ The coordination of functional technological analyses with operational psychological and ergonomic analyses is a major issue in the design of anthropotechnical systems. Among the most advanced studies in this field are those of Christol & al. (1994).

bring together actors carrying anthropocentered and technocentered points of view.

DESIGNING

The development of methods aiming to have ergonomics included in the running of industrial projects is currently booming and great progress has been made (see Daniellou 1992, Garrigou 1994). However, this trend faces certain obstacles for the design of instrumental artifacts.

Methods of running industrial projects often treat each project as a unique case and aim to respond to the specificity of each case by a careful identification of its local particularities, both in human terms (analysis of the operator population, analysis of current activity at the reference site, anticipation of possible future activity, etc.), and in industrial terms (thorough knowledge of process, analysis of variability and dysfunction sources, identification of disruptive factors, etc.).

Yet such an approach is not always possible for the design of artifacts with an instrumental vocation for several reasons:

- economic reasons: the cost of “industrial project” type operations may be compatible with the expenses of large projects, yet it most often exceeds the budgets of more modest investors;

- ergonomic reasons: there is a vast domain of design that has social importance in that it particularly concerns small to medium companies and industries in which artifacts are not unique pieces, but rather machines reproduced in great number and adaptable in a range of situations by many different users. In this domain ergonomic intervention must be seen in reference to classes of situations rather than specific situations.

Despite the important contributions of many methods aiming to provide designers with information on users and utilization in the field of human-computer interactions, these methods encounter difficulties in early identification, within the design process, of the diversity and variability of users and situations (Caroll 1991b).

The instrumental approach is one of the options allowing these difficulties to be bypassed.

Design that tackles problems encountered in usage

As we saw earlier, many factors contribute to the diversity and, above all, the variability of the CAD file structure provoking difficulties for the exchange and sharing of data.

Some of these are negative factors in that the structure of the file does not correspond to that sought by the designer, even though he/she produced it. This is the case in work with time constraints in which designers have to abandon

structuring tasks to devote themselves exclusively to the production of the paper document.

The development of computer environments incorporating structuring aid tools could, in this type of situation, contribute to improving quality. It is important that structuring tasks do not become too time consuming in the designer's activity and do not, as is sometimes the case, interfere with the accomplishment of the main design tasks. Well-designed structuring aid tools could be used in this perspective.

Some of the factors that contribute to the diversification of files could be considered as positive because the specificity of structuring is, for designers, a means of adapting the form of the files to the particularities of the case and tasks, as well as their own utilization schemes and knowledge. The structuring of the file thus constitutes an important factor of bringing the work tool into line with tasks and competencies.

The instrumental approach leads us to conclude that design philosophies of the computer environment based on the principle of an *a priori* rigidification of the file's structuring seem doomed to encountering serious difficulties or failure because they do not allow functional adjustments to the particularities of the case and to utilization schemes. Yet this is precisely the position on which certain computer environments, such as plan cupboards, are based. They seek to allow data exchange, the integration of contributions from many designers as well as successive versions during the project's life span.

During our observations in the engineering company, we observed, for example, that an extremely restrictive application program in terms of file structuring made the design task very problematic⁸⁴. Initially, designers carried out their task in two steps: design on paper, then entry on screen. Then they used the application program in a degraded mode: the functions imposed by a coercive structuring of the files were abandoned. Finally, usage of the application program was abandoned altogether.

A computer environment destined to allow the exchange and sharing of data must offer the possibility of a specification of the file's structure in line with individual or collective needs. Furthermore, the structuring must be able to evolve so as to be adapted to the evolution dynamic of the case and the tasks.

Design focused on users' schemes and representations

The importance of an instrumental approach is becoming more apparent to designers, as evidenced by Quarante's publication (1994) which presents,

⁸⁴ The constraints on the structure of the file were due to the fact that the application program for designing electrical cupboards included functions allowing the automatic realization of a certain number of fastidious operations, such as numbering the wires and grouping them. These functions imposed a file structure that was completely predefined and invariable.

alongside the notion of operative image, the notion of the social utilization scheme as one of the options taken into consideration by the user in design.

Let us take an example of what could be design focused on user representations and schemes. It concerns the heating programmer mentioned in chapter 9. We will give a brief summary of the results of research undertaken by Chailloux (1992 & 1994). User representations are very different from those of designers. Designers have a technical vision of heating programmers which they consider as technical objects destined to pilot a heating system in a variable manner based on time. The programmer is a "temporal machine". The user provides it with entry data to allow it to function. However, for users, the programmer is a very different instrument. It allows them to act on the temperature in line with their lifestyle. For them it is a sort of temporal remote control that allows them to overcome time, not space.

Thus on the level of ergonomic design, two options present themselves:

- remaining in a technocentric perspective. The effort will be in making the user understand the properties of the system and the utilization modalities (as in expected behavior). The interface, or user guide, will be made to facilitate this behavior in the user. The user must be helped to bring his/her representations and schemes in line with what the programmer is technically. The user must adapt the artifact as a technical object;

- moving into an instrumental approach. The effort will be in allowing the insertion of the artifact as an instrument into the user's activity and placing it in an assimilation situation: the artifact must be able to be assimilated directly into user schemes and representations. The interface will be more of a metaphorical type, and the artifact will be designed around and in coherence with user schemes and representations. In a way, the artifact, right from the start, i.e. right from its design accommodates the user.

We feel the second option is clearly preferable. The heating programmer is an appliance which the user rarely adjusts (timetables are relatively stable) and undertaking the difficult apprenticeship required by the first solution is not realistic. Furthermore, given the low utilization frequency, acquired knowledge is soon forgotten, is not learnt again and the technical object ends up not being used⁸⁵. On the contrary, a programmer corresponding to user schemes and representations would remain usable.

However, the second option is not always the most interesting. When we are not looking at artifacts from everyday life, an expensive training program may be justified if it increases significantly and durably user competencies and capacity for action. This is the case, for example, with many professional machines.

⁸⁵ How many of us do not own one of these domestic remote control devices, cast aside never to be used again?

Designing based on users' real instruments

The design process, particularly in the professional domain, may be strongly based on instruments born of instrumental geneses and user elaborations. In a preceding chapter, we referred to the example of marine maps produced by the captain of a fishing trawler (Minguy & Rabardel 1993). Following is a second example in the domain of regulating bus traffic (Folcher 1994).

To carry out their work, regulators dispose of a range of instruments. Nonetheless, based on available documents, they elaborate another work aid: the OT (operations table). Analysis of the regulation activity allows understanding of why operators spend several hours elaborating the OT, which they consider to be indispensable. It presents an overall organization of spatio-temporal information necessary to regulators, whereas most other tools at their disposal are more focused on spatial information (line image) or on temporal information (timetable charts). The OT thus plays a role of integrating different types of information. It allows a simultaneous visualization of all agent departments, from the organization of departures and inscription in real time of changes to the running initially planned. It thus gives operators the possibility of manipulating a schematic representation of the overall process and the pertinent control variables, thereby extending their field of control.

This group of the tool's structural and functional properties elaborated by operators allows the production of orientations for the elaboration of specifications in the context of redesigning tools. It also provides elements to test solutions put forward by designers.

Elaborating and evaluating a design project based on the instrument-mediated activity situations model

To illustrate the utilization of a tripolar I.A.S. model, in the design of anthropocentric systems, we will use an example borrowed from Maryse Laurent⁸⁶.

A traditional technological method of defining functions and constraints of a product consists of:

- first, describing its environment, i.e. establishing a list of elements (objects, individuals, etc.) liable to be in relation or contact with the product;
- second, defining the functions and constraints as the expression of relations that exist between the product and the surrounding elements, or that the product establishes between two surrounding environments;
- the next step consists of specifying functions by the (qualitative) criteria and (quantitative) levels of performance to be attained. These criteria result from the characteristics of the surrounding environments. For example, in the

⁸⁶ Maryse Laurent is a consultant in engineering and ergonomics in the company IODE in Brest.

case of designing a pen, this could be the type of paper (texture, thickness, colors, etc.) that the pen must write on. Criteria also result from user expectations and demands, such as the thickness and intensity of the line.

It is on the level of establishing functional specifications that the I.A.S. model enriches reflection in design. Following is an example from a real design situation in which I.A.S. modeling allowed an expansion of the field of designers' reflection. It concerns the design of a collector of solid waste (bottles, plastic bags, etc.) in ports⁸⁷. The study aimed to define a system of waste collection to be adapted to an existing barge. Some proposals, which fitted with the initial functional specifications (elaborated without reference to the I.A.S. model) were eliminated after it was enriched by use of the I.A.S. model. It became necessary to consider a new point: the barge pilot – waste interaction. Figure 20 illustrates this consideration.

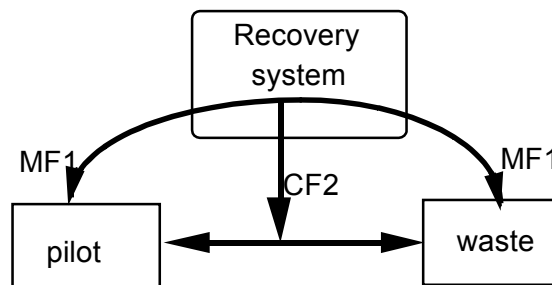
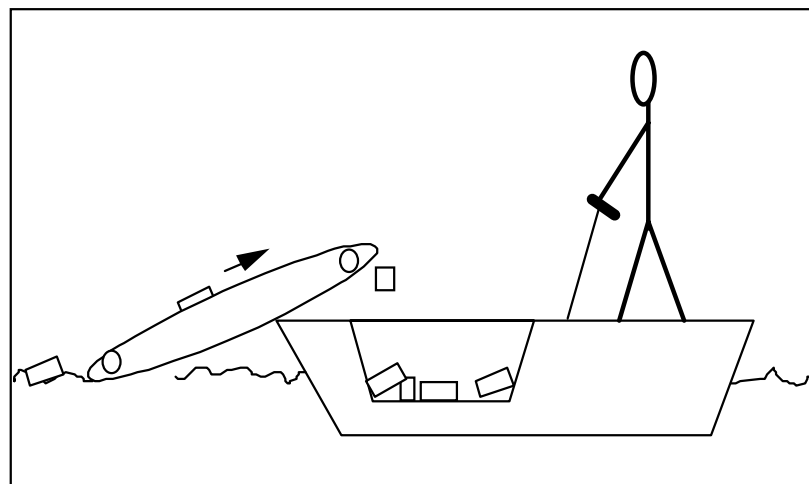

figure 20 Modeling of situation for the design of a waste recovery system.
MF (main function), CF (constraint function)..

The principle of the system is presented in figure 21



⁸⁷ The design of the solid waste recovery system in ports was a collaboration between the company EGMO and students in mechanical engineering at IUP in Brest.

Figure 21 Principle of recovering floating solid waste

- MF1 corresponds to the main function of the system that is to allow the pilot to recover the waste;
- CF2 corresponds to the utilization constraints of the system as the pilot's instrument: the system must allow the pilot to control the collection in ensuring visibility of the waste on the water (piloting the barge), as well as ensuring the visibility of the waste during the collection operation (to ensure it runs smoothly, anticipate and prevent dysfunction, blockages, etc.).

Respecting the CF2 constraint, which ensures the pilot can see the waste and the interaction between the collecting conveyor belt and the waste, impacts on the relative implantation of the collecting conveyor belt and the pilot's station as well as on the height and angle of the belt.

TRAINING

Designing actions, programs and training in an instrumental perspective

Above, we have examined some of the possible contributions of an instrumental approach to the design of CAD systems. Of course, not all problems can be resolved by design and the introduction of CAD systems also has repercussions in the training field. Both the personnel who designs or draws with CAD and staff whose actions or decisions are directly related to tasks (engineers, project leaders, etc.) are concerned.

For staff working directly with CAD, several training options, complementary to existing ones, could be taken up:

- First, right from initial training, it seems highly advantageous to structure teaching content around the new object that is the computer file. Managing this file is one of the main issues, as well as being one of the major difficulties that designers face out in the field. This training should concern two main aspects. It should allow better understanding of what the graphic document is in its file form, both as a software object and as a matter to be worked and reworked by the designer. Furthermore, it should present file management as a means of organizing his/her own work in relation to the work of others and the evolution of design processes over long periods, which is typical of engineering projects.
- Second, we feel training programs should prepare future designers for processes of instrumental genesis. We have observed everywhere that users modify their work tools to adapt them to their needs, their competencies and the diversity of situations encountered. Today, they most often act on their tools with no real competencies for doing so. Naturally, in some cases, this has negative consequences. It is thus better to prepare them.

Training programs should also concern staff whose activity has a direct influence on CAD users: engineers, research consultancy heads, project leaders and even technical sales personnel. We have observed a loss in competence among some staff members belonging to these categories. While for manual design they often have a good representation of the nature of designers' work and the nature of the difficulties they encounter, they often misjudge essential aspects of work with CAD systems. The consequences are frequently problematic: acceptance of costly modifications requested by a client because they think they are simple to carry out (with CAD, it's simply a matter of pushing a button...), deadlines badly estimated leading to human and economic over-spending, insufficiently structured projects given the organizational needs inherent to the use of CAD tools, etc. The list is long. The answer is clearly not in giving these categories of staff training programs as complex as those for CAD specialists. Rather, they should be allowed to construct background knowledge concerning both these tools and the nature of the work when they are used.

Operators modifying their instruments is neither a marginal phenomenon in CAD, nor a phenomenon specific to this domain. As soon as we seek to apprehend it, we realize it has an almost universal nature in situations of instrument utilization and is developing rapidly with computer tools. Beyond local training actions, it now seems necessary for the educational system to take into consideration an instrumental approach to CAD and more generally anthropocentric systems. The dominant approach is still almost exclusively technocentric. The consequences of this are significant on at least two levels:

- the training of future professionals thus tends to ignore essential dimensions for their future activity. Hence, in training for professional and technical secondary education, activities of real usage of technical systems are being progressively phased out in favor of modelizations and simulations: the teachers concerned ironically speak among themselves of "paper producing workshops". At the same time, we are seeing a strong reduction and at times a near disappearance in trade or amateur reviews for teachers of articles on the problems of students' relation to machines and technical systems. Beyond professional training, training programs aiming at a technical acculturation at school, are often almost incapable of giving a place to the operator's activity and thus, of the human dimension of work. Students in the E stream (preparing a scientific and technical baccalaureate) can, for example, in some cases, never use a single machine-tool⁸⁸. The development of an instrumental point of view that complements the technological point of view will clearly not suffice to resolve this serious problem. However, it may provide a contribution that permits us to move beyond it;

⁸⁸ Our thanks to René Trabattoni, a teacher in a technical school who gave us this information. It should be noted that changes are underway. A text of recommendations from the general inspection of productive mechanical teaching (September 1994) stresses that "The time devoted to practical work must correspond to students' effective activities on machines or production peripherals. Respecting allocations of practical study periods will reduce an observed trend toward more abstract activities, far removed from machines and technical means, that sometimes undermine student interest without guaranteeing access to the competencies described in the reference material."

- future design professionals trained in a predominantly technocentric perspective are very badly prepared to take the user into consideration in their future design projects. The technocentric approach thus tends to proliferate from one generation of designers and artifacts to the next.

The elaboration of training content incorporating an instrumental approach to objects and anthropocentric systems, and beyond this, the development of didactic engineering works oriented in this perspective would seem to be of an urgent necessity.

Constructing situations that favor the formation of knowledge and the development of competencies in training and the workplace

Until now, very little attention has been paid to the educational potential of training processes through use.

The usage of instruments is nonetheless common practice in technical and professional training as well as in many general teaching disciplines. In geometry, for example, a ruler, compass and set square are used to draw many plans and constructions⁸⁹. These instruments are usually considered to be simple, neutral auxiliaries that do not participate as such in students' conceptualizations. But are we sure? What is their real cognitive status? How do they contribute to the structuring of students' geometric and spatial thought? Or on the contrary, do they undermine it? Ourahay (1991), for example, showed that the notion of orthogonal symmetry among students was not constructed in the same way or with the same content depending on the instruments used to draw graphic constructions (set square, compass, folding). Likewise, Bautier (1993) revealed the impact of instruments on the conceptualization of geometric transformations.

Today, an educational option seems promising: designing instruments specifically to favor among users, in training or the workplace, the construction and manipulation of conceptualizations and competencies whose acquisition is an objective. We will give an example based on research in robotics already presented in chapter 11.

A reminder of the situation: the remote-manipulation of a robot arm is carried out using a command box made up of three cursors that are orthogonal to each other and color coded in yellow, red and blue. These correspond to the three axes of bearings in the workspace in which the arm can be moved around.

The simultaneous positions of the cursors on each of the axes of the command device define a point corresponding to the position of the extremity of the claw in the robot's working space. To reach a given point in the workspace with the extremity of the claw means simultaneously positioning the cursors to indicate the corresponding point.

⁸⁹ New, computer-based instruments are appearing, for example Cabri-Géomètre.

We designed this device based on the hypothesis that the particular structuring given to the device would lead students to construct representations of space in terms of a three-dimensional bearings system. The didactic perspective, based on this cognitive construction linked to action, was the development of systematized training in two domains: that of the conceptualization of three-dimensional space in mathematics and particularly in physics; as well as in the domain of digital control of machines evolving in this kind of space (robots, digitally controlled machine-tools, etc.).

The results tend to confirm our hypotheses, but the effects are only progressively felt among subjects during a long instrumental genesis that can last several hours. Subjects initially focus on the effects of their actions on the robotic arm. Their representations evolve both relative to the properties and characteristics of the machine and that of the space on and in which it allows action. Space, initially treated as an area of movement (in the corporal sense) progressively becomes a space with three-dimensional bearings. These results show that representations relative to technical systems in their instrumental function are constructed simultaneously to and in close relation to representations relative to the real and in which the instrument allows action (in this case, space).

Different instruments imply different conceptions, not only of the artifact (which is trivial) but also and above all of the real place and object of the action. Thus, contrary to shared intuition, the instrument is definitely not neutral in terms of the real. Performing the same movement of a cube from point A to point B with two robots based on different principles implies that users construct representations of different spatial properties, themselves based on profoundly different conceptualizations of space (Rabardel 1993b).

The effects of tools on the development of competencies are not limited to the field of education as Samurcay (1994) demonstrates. Based on the analysis of processes at work in the functioning and running of blast furnaces, an operation aid tool was elaborated. It was structured around a group of descriptors, which were pragmatic concepts for the action (in line with Pastré 1992), born of both engineers' models and those of the most experienced workers. The hypothesis was that this tool would allow the blast furnace to be run better and that it would facilitate the development of operator competencies by providing them with information specifically organized and adapted to their tasks and the conditions of their activity. The results obtained in simulation tend to confirm these hypotheses on two essential points. The experimental tool tends to improve the information gathering activity and the operators' diagnosis. Guiding the development of competencies via the modification of work situations and particularly their instruments is thus a possibility within work situations themselves.

The examples we have just presented indicate clearly that instruments are not conceptually neutral. They contain a "world view" that imposes itself to a lesser or greater degree on users, thus influencing the development of their competencies. Today, it is necessary to analyze educational and professional practices from the point of view of common instruments to better master their use in training. It will thus be possible to identify the potential contributions of these

additional training programs to those structured around systematic presentations of knowledge. These contributions are not only relative to the instrumental utilization of artifacts. There is also, and perhaps above all, potential for generalization of this knowledge-in-act in the professional domain as there is in more “general” disciplines.

Instrumental knowledge is liable to play the role of precursor for constructions later formalized on disciplinary and/or structured grounds in the most general cognition tools. Let us construct new instruments explicitly founded on this property which will allow us to explore paths leading from action to conceptualization and formalization, thus placing them in a general movement of the cognitive development of human beings.

REFERENCES

- Amalberti, R. (1991). - Sécurité des vols et automatisation des cockpits, Séminaire OACI, Douala, 6-10 mai.
- Anonyme (1989). - Nouvelle technologie et sécurité, Sécurité aérienne, Nouvelles, Canada, n° 6.
- Aucherie, P., Sacotte, E. (1994 a). - Utilisation d'un artefact comme instrument, analyse pour le DESS psychologie du travail et ergonomie cognitive, Université Paris VIII.
- Bainbridge, L. (1982). - Ironies of automation, proceedings of the IFAC/IFORS/IEA/IFS conferece on analysis, design and evaluation of man-machine systems, Baden Baden.
- Bainbridge, L. (1991). - Will expert systems solve operators problems, draft.
- Bannon, L.J., Bodker, S. (1991). - Beyond the interface: encountering artifacts in use, in Designing interaction. Psychology of Human Computer Interface, Caroll J. M. ed. Cambridge University Press.
- Bartlett, F. (1932). - Remembering: a study in experimental and social psychology, Cambridge University Press, London.
- Bastien, C. (1987). - Schèmes et stratégies dans l'activité cognitive de l'enfant, PUF, Paris.
- Bautier, T. (1993 a). - Théorie des médiations et enseignement des transformations géométriques, Thèse de doctorat, université de Bordeaux 1.
- Béguin, P. (1993 a). - Dimensions collectives des activités avec instruments en dessin et conception assistée par ordinateur, Communication au Séminaire "Activités avec instruments", Laboratoire d'Ergonomie du CNAM.
- Béguin, P. (1993 b). - Field evaluation and collective work design in practice with CADE, valuation studies in CSCW, ECSCW'93.
- Béguin, P. (1994). - Travailler avec la CAO en ingénierie : de l'individuel au collectif dans les activités avec instruments, Thèse d'ergonomie, Laboratoire d'ergonomie, CNAM.
- Béguin, P. Rabardel, P. (1993). - concevoir avec et sans CAO.
- Bernoux, P. (1991). - L'appropriation des techniques, In Perrin, J. ed., Construire une science des techniques, l'interdisciplinaire, Limonest.
- Berthet, M. (1986). - Apports et limites de l'expression ouvrière: un exemple de "boites à idées", Travail et emploi, septembre, n° 30.

- Bertrand, L., Weill Fassina, A. (1993). - Formes des représentations fonctionnelles et contrôles des actions dans le diagnostic de pannes, in Weill-Fassina A., Rabardel P., Dubois D. eds., Représentations pour l'action, Octares.
- Bibard, L. (1991). - un nouvel objet technique: l'immunotoxine, In Perrin, J. ed., Construire une science des techniques, l'interdisciplinaire, Limonest.
- Boder, A. (1982). - Le rôle organisateur du schème familial en situation de résolution de problème, Thèse de doctorat présentée à la faculté de psychologie et des sciences de l'éducation, université de Genève.
- Boder, A. (1992). - Le schème familial, unité cognitive procédurale privilégiée, in, Inhelder, B & Cellérier, G. eds. 1992, le cheminement des découvertes chez l'enfant, recherches sur les microgenèses cognitives, Delachaux et Niestlé, Lausanne.
- Bodker, S. (1989). - A human activity approach to user interface, Human Computer Interaction, vol 4, pp 171-195.
- Bodker, S. (1991). - Through the interface: a human activity approach to user interface design, Lawrence Erlbaum associates Publishers.
- Boesch, C. & Boesch-Achermann, H. (1991). - Les chimpanzés et l'outil, La recherche, 233, pp 724-731.
- Bourdieu, P. (1965). - Un art moyen, Editions de minuit.
- Brodner, P. (1987). - Strategic options for new productions systems: Computer and Human integrated manufacturing, CEC-FAST Publications, Bruxelles.
- Bronckart, J.P. (1985). - Vygotsky, une oeuvre en devenir, in Vygotsky aujourd'hui, B.Schneuwly et J.P. Bronckart eds., Delachaux et Niestlé.
- Bruner, J. (1991). - ... car la culture donne forme à l'esprit: de la révolution cognitive à la psychologie culturelle, éditions Eshel, Paris.
- Bruner, J.S., Hickmann, M. (1983). - La conscience, la parole et la "zone proximale", in Bruner, J.S., Savoir faire et savoir dire, PUF, Paris.
- Bruner, J.S., Olson, P.R. (1977-78). - Symbols and texts as tools of intellect, Interchange, 8, 1-15.
- Bullinger, A (1987 a). - La formation d'actions motrices chez l'enfant, aspects sensori-moteurs, colloque SFP, 13-14 mars Paris.
- Bullinger, A. (1987 b). - The movement or its control, European Journal of Cognitive Psychology, vol. 7, n° 2.
- Bullinger, A. (sous presse). - Le concept d'instrumentation: son intérêt pour l'approche des différents déficits, in Deleau, M., (ed.), PUF, Paris.
- Bullinger, A. (1990). - L'enfance comme processus, Évolution et Cognition, Bergamo.

- Buxton, W. (1982). - An informal study of selection positioning tasks, *Graphics Interface*, 82, 323-328.
- Buxton, W., Fiume, E., Hille, R., Lee, A., Woo, C. (1982). - Continuous hand driven input, *Graphics Interface*, 183, 131-135.
- Cadoz, C. (1992). - Le geste canal de communication homme-machine, la communication instrumentale, draft.
- Cahour, B. (1992). - Explanation techniques: a state of the art, Draft Esprit project 6013, laboratoire d'ergonomie, CNAM, Paris.
- Card, S.K., Robert, J.M. & Keenan, L.N. (1985). - One line composition of text, in Shackel, B. ed., *Interact'84*, Amsterdam, North Holland.
- Caroll J. M. ed. (1991 a). - *Designing interaction, Psychology at the Human-Computer Interface*, Cambridge University Press, New York.
- Caroll J. M. (1991 b). - The Kittle House Manifesto, in Carroll J. M. ed., 1991, *Designing interaction, Psychology at the Human-Computer Interface*, Cambridge University Press, New York.
- Cellérier G. (1979 a & b). - Structures cognitives et schèmes d'action, *Archives de psychologie*, n° 180, pp 87-104, n° 181, pp 107-122.
- Cellérier, G. (1987). - Structures and functions, in Inhelder, B., De Caprona & Cornu-Wells eds, *Piaget today*, London, Erlbaum.
- Cellérier, G., Ducret, J.J. (1992 a). - Le constructivisme génétique aujourd'hui, in Inhelder, B & Cellérier, G. eds. 1992, *le cheminement des découvertes chez l'enfant, recherches sur les microgénèses cognitives*, Delachaux et Niestlé, Lausanne.
- Cellérier, G., Ducret, J.J. (1992 b). - Organisation et fonctionnement des schèmes, in Inhelder, B & Cellérier, G. eds. 1992, *le cheminement des découvertes chez l'enfant, recherches sur les microgénèses cognitives*, Delachaux et Niestlé, Lausanne.
- Chabaud, C. (1990). - Tâche attendue et obligations implicites, In Dadoy & al. (eds.), *Les analyses du travail, enjeux et formes*, Collection des études, n° 54, CERREQ.
- Chailloux, K. (1992). - Apport de la modélisation tripolaire des activités avec instrument à la conception des produits destinés au grand public, Mémoire pour le DEA d'ergonomie, Laboratoire d'ergonomie du CNAM.
- Chailloux, K. (1994). - Apport de l'ergonomie à la conception de produits destinés au grand public, un exemple : les programmeurs de chauffage, in *Ergonomie et Ingénierie*, Actes du 29 ème congrès de la SELF, Eyrolles, Paris.
- Chapanis, A. (1975). - *Ethnic variables in human factors engineering*, J. Hopkins, University Press, Baltimore.

- Christiaans, H.H.C.M. (1991). - Cognition in dealing with interactive devices, in Queinnec Y., Daniellou F. eds., *Designing for Everyone*, Taylor and Francis London.
- Christol, J., Mazeau, M. (1993). - Amélioration de la qualité : le rôle du facteur humain, *Performances humaines et techniques*, N° 65.
- Christol, J., Mazeau, M. et al. (1994). - Analyse fonctionnelle et analyse opérationnelle : les moyens d'une coordination, in *Ergonomie et Ingénierie*, Actes du 29 ème congrès de la SELF, Eyrolles, Paris.
- Churchill, E. F. (1992). - The formation of mental models: are "device instructions" the source?, In the proceedings of the Sixth European conference on Cognitive Ergonomics: "Human-Computer interaction: tasks and organization.
- Clegg (1988). - Appropriate technology for manufacturing: some management issues, *Applied Ergonomics*, march.
- Clot, Y. (1992). - La vigilance peut-elle être automatisée, *Performances Humaines et Techniques*, septembre, 56-59.
- Cole, M. (1990). - Cultural psychology: A once and future discipline?, Paper presented at the Nebraska Symposium 1989.
- Cook, R., Woods, D.D., Mc Colligan, E., Howie, M.B. (1991). - Cognitive consequences of "clumsy" automation on high workload, high consequence human performance, in Savely R.T. ed., *Fourth Annual Workshop on Space Operations Applications and Research (SOAR '90)*, NASA.
- Cooley, M. (1989). - European competitiveness in the 21st century. Integration of work, culture and technology, Contribution to the Fast proposal for and R&D Programme on "Human Work in Advances Technological Environments".
- Corbett J.M. (1988). - Ergonomics in the development of human-centred AMT, *Applied Ergonomics*, 19.1, pp 35-39.
- Coutouzis, M., Latour, B. (1986). - Le cas du village solaire de Frango-Castello, *L'Année sociologique* n° 36, pp 113-169.
- Craven, F.W., Slatter, R.R. (1988). - An overview of advanced manufacturing technology, *Applied Ergonomics*, 19.1, pp 9-16.
- Cuny, X. (1981 a). - La fonction sémique dans le travail: l'élaboration et l'utilisation des systèmes non verbaux chez l'adulte, thèse pour le doctorat d'état es lettres et sciences humaines
- Cuny, X. (1981 b). - Analyse sémiologique et apprentissage des outils-signes: l'apprentissage du schéma d'électricité, *Communications*, n° 33, pp 103-141.
- Cuny, X. (1993). - Outils sémiques et organisation des conduites de travail, Communication au Séminaire "Activités avec instruments", Laboratoire d'Ergonomie du CNAM.

- Cuny, X., Deransart, P. (1971-72). - Formalisation pour l'analyse du travail mental: la machine et ses représentations, *Bulletin de psychologie*, 296, pp 273-281.
- Danev, S.G., Winter, C.R. de & Wartina, G.F. (1970). - Time, stress and Katachretical behaviour, Publication de l'institut N.I.P.G./TNO, Leiden.
- Daniellou, F. (1986). - L'opérateur, la vanne, l'écran : l'ergonomie des salles de contrôle, Collection Outils et méthodes, ANACT, Montrouge.
- Daniellou, F. (1992). - Le statut de la pratique et des connaissances dans l'intervention ergonomique de conception, Thèse d'habilitation à diriger les recherches, Université Toulouse le Mirail.
- Deforge, Y. (1981). - Éléments pour une génétique de l'objet technique, TN 18, Université Technologique de Compiègne.
- Deforge, Y. (1991). - Enseignements techniques, enseignements professionnels, enseignements technologiques: essai d'élucidation de ces trois titres, In Perrin, J. ed., *Construire une science des techniques, l'interdisciplinaire*, Limonest.
- Deltor, S. (1993 a). - Qualité produit du travail et de l'organisation: introduction, in Actes du colloque "Qualité produit du travail et de l'organisation", Aubagne novembre 1993.
- Demailly, A., Lemoigne, J.L. (1986). - Sciences de l'intelligence, sciences de l'artificiel, PUL, Lyon.
- Douady, R. (1986). - Jeux de cadres et dialectique outil-objet, *Recherches en didactique des mathématiques*, vol. 7, n° 2, pp. 5-31.
- Dreyfus, H. (1984). - L'intelligence artificielle: mythes et limites, Flammarion, Paris.
- Dubois, D. (1991). - Catégorisation et cognition 10 ans après une évaluation des concepts de Rosch , *Sémantique et cognition*, Paris, Editions du CNRS.
- Dubois, P. (1992). - Conception et évolution des systèmes techniques. Rationalisation de la production, in Colloque interdisciplinaire Travail: recherche et prospective.
- Duvenci-Langa, S. (1993). - De la machine outil traditionnelle à la commande numérique, quelles évolutions de compétences?, Communication au séminaire "Didactique Professionnelle", 21-22 janvier, Groupement de recherche Didactique du CNRS.
- Ehn, P., Kyng, M. (1984). - A tool perspective on design of interactive computer for skilled workers, in Sääksjärvi M. ed. *Proceedings of the 7th Scandinavian seminar on systemeering*, Helsinki school of Economics.
- Ehn, P., Kyng, M., & Sundblad, Y. (1983). - The Utopia Project, in V. Briefs, C. Giborra, & L. Schneider eds., *Systems design for, with and by the users*, Amsterdam, North-Holland.

- Engeström, Y. (1991). - Developmental work research: reconstructing expertise through expansive learning, in Nurminen M.I., Weir G.R.S. eds., Human jobs and computer interfaces, Elsevier Science Publishers.
- Eysenck, M.W., Keane, M.T. (1990). - Cognitive Psychology A Student's Handbook, Lawrence Erlbaum associates Publishers, London.
- Falzon, P. (1989 a). - Analyser l'activité pour l'assister, Actes congrès de la SELF, Lyon.
- Falzon, P. (1989 b). - Ergonomie cognitive du dialogue, Presses Universitaires de Grenoble.
- Faverge, J.M. (1970). - L'homme agent d'infiabilité et de fiabilité du processus industriel, Ergonomics, vol. 13, n° 3, pp 301-327.
- Fayol, M., Monteil, J.M. (1988). - The notion of script: from general to developmental and social psychology, CPC: Cahiers de psychologie cognitive, European Bulletin of Cognitive Psychology, vol. 8, n°4.
- Feigenbaum, E. (1991). - Entretien avec Guitta Pessis-Pasternak, In Faut il bruler Descartes, éditions la découverte, Paris.
- Fischer, K.W. (1980). - A theory of cognitive development : the control and construction of hierarchies of skills, Psychological Review, 87, pp 477-531.
- Flahaut, J. C., Rabardel, P. (1985 b). - Et si on coupait les pièces pleines?, Techniques Industrielles, mai-juin.
- Floyd, C. (1987). - Outline of a paradigm change in software engineering, in Bjerknes, G., Ehn, P. & Kyng, M. eds., Computers and democracy - A Scandinavian Challenge - Aldershot, UK, Avebury.
- Folcher, V. (1994). - Analyse de l'activité dans une tâche de régulation du trafic bus RATP : rôle du tableau de Marche "à clé", Mémoire de DESS d'ergonomie cognitive.
- Freyssenet, M. (1992). - Les énigmes du travail: quelques pistes nouvelles de conceptualisation, in Colloque interdisciplinaire Travail: recherche et prospective, thème 1: concept de travail.
- Gaillard, J.P. (1993). - Analyse fonctionnelle de la boucle de commande en télémanipulation, in Weill-Fassina A., Rabardel P., Dubois D. eds., Représentations pour l'action, Octares.
- Galinier, V. (1992). - Ergonomie et automatisation dans les véhicules lourds, Mémoire de DEA d'Ergonomie du CNAM.
- Gardner, B.T. & Gardner, R.A. (1972). - Communication with a young Chimpanzee: washoe's vocabulary, in Modèles animaux du comportement, colloque international du CNRS, n° 198.
- Garneray, L. (1985). - Le négrier de Zanzibar, Phoebus, Paris.

- Garrigou, A. (1994). - La compréhension de l'activité des concepteurs, un enjeu essentiel, in Actes des journées de Bordeaux sur la pratique de l'ergonomie.
- Gentner, D. & Stevens A.L. (1983). - Mental models, Lawrence Erlbaum Associates Publishers, London.
- Gonod, P.F. (1991). - interdisciplinarité et technologie, In Perrin, J. ed., Construire une science des techniques, l'interdisciplinaire, Limonest.
- Gould, J.D. (1980). - Experiments on composing letters: some facts, some myths and some observations, in Gregg, L.W. & Steinberg, E.R. eds., Cognitive processes in writing, Hillsdale, New Jersey: LEA.
- Gras, A., Scardigli, V. (1991). - Le pilote le contrôleur et l'automate, □□CETCOPRA & IRISTS, rapport intermédiaire de recherche.
- Green, T.R.G., Hoc, J.M. (1991). - What is cognitive ergonomics, Le Travail Humain, t. 54, 4, 291-304.
- Greif, S. (1991). - The role of German work psychology in the design of artifacts, in Designing interaction. Psychology of Human Computer Interface, Caroll J. M. ed. Cambridge University Press.
- Grize, J.B. (1970). - Préface du livre de P. Mounoud, Structuration de l'instrument chez l'enfant, Delachaux Niestlé, Paris.
- Guillaume P., Meyerson, I. (1930). - Recherches sur l'usage de l'instrument chez les singes: le problème du détour, Journal de psychologie.
- Guillaume P., Meyerson, I. (1931). - Recherches sur l'usage de l'instrument chez les singes: l'intermédiaire lié à l'objet, Journal de psychologie.
- Guillaume P., Meyerson, I. (1934). - Recherches sur l'usage de l'instrument chez les singes: l'intermédiaire indépendant de l'objet, Journal de psychologie.
- Guillaume P., Meyerson, I. (1937). - Recherches sur l'usage de l'instrument chez les singes: choix, correction, inventions, Journal de psychologie.
- Guillevic, C. (1990). - L'appropriation cognitive de l'outil: condition de la fiabilité dans les situations de transfert de technologies, in Leplat J., Terssac de G. & al. Les facteurs humains de la fiabilité dans les systèmes complexes, Octares.
- Habermas J. (1968-1991). - connaissance et intérêt, Tel, Gallimard, Paris.
- Hanisch, K.A., Kramer, A.F. Hulin, C.L. (1991). - Cognitive representations, control, and understanding of complex systems: a field focusing on components of users' mental models and expert/novice differences, Ergonomics, vol. 34, n° 8, pp 1129-1145.
- Hatchuel, A. (1992). - Savoirs, organisations et systèmes productif, in Colloque interdisciplinaire Travail: recherche et prospective, note de discutant.

- Haudricourt, A.G. (1964). - La technologie science humaine, la pensée, n° 115.
- Haudricourt, A.G. (1987). - la technologie science humaine, recherche d'histoire et d'ethnologie des techniques, Maison des sciences de l'homme, Paris.
- Heidegger, M. (1962). - Being and Time, Harper & Row, New York.
- Henderson, A. (1991). - A development perspective on interface, design and theory, in Designing interaction. Psychology of Human Computer Interface, Caroll J. M. ed. Cambridge University Press.
- Henderson, H. , Kyng, M. (1991). - There's no place like home: continuing design in use, in Greenbaum J. , King M. eds. Cooperative design of computers, IEA, Laurence Erlbaum associates, publishers.
- Hendrick, H.W. (1987). - Macroergonomics: a concept whose time has come, Human Factors Society Bulletin, 30, 2.
- Hoc, J.M. (1986). - L'organisation des connaissances pour la résolution de problème: vers une formalisation du concept de schéma, in Bonnet, C., Hoc, J.M. & Tiberghien, G. eds., Psychologie, intelligence artificielle et automatique, Mardaga, Bruxelles.
- Hoc, J.M. (1989). - La conduite d'un processus continu à longs délais de réponse: une activité de diagnostic, Le Travail Humain, 52, pp 289-316.
- Hoc, J.M., Nguyen-Xuan, A. (1987). - Les modèles informatiques de la résolution de problème, in Piaget, J., Mounoud, P., Bronkard, J.P., Psychologie, Encyclopédie de la pléiade.
- Hoc, J.M., Samurcay, R (1992). - An ergonomic approach to knowledge representation, Reliability, Engineering and System Safety, 36.
- Hollnagel, E. (1990). - The design of integrated man-machine systems and the amplification of intelligence, Invited presentation for the International Conference on Supercomputing in Nuclear Applications, Mito city, Ibaraki, Japan.
- Hollnagel, E. (1991). - Cognitive ergonomics and the reliability of cognition, Le Travail Humain, t. 54, 4, 291-304.
- Hubault, F., Lebas, M. (1993 a). - Qualité: un terrain d'entente obligée entre ergonomie et gestion?, in Actes du colloque "Qualité produit du travail et de l'organisation", Aubagne novembre 1993.
- Hutchins, E. (1990). - The technology of team navigation, In Galegher, J., Kraut, R.E. & Egido, C., Intellectual Teamwork, Lawrence Erlbaum Associates Publishers.
- Hutchins, E., Hollan, J., & Norman, D. (1986). - Direct manipulation interface, in Norman D.A., Draper S. W. eds., User centered system design: New perspectives in Human Computer Interaction, Hillsdale, NJ: Lawrence Erlbaum .

- Ifrah, G. (1985). - Les chiffres, ou l'histoire d'une grande invention, Paris, Laffont.
- Ihde, D. (1979). - *Technics and Praxis*, Dordrecht, Holland: D. Reidel.
- Inhelder, B. (1955). - Patterns of inductive thinking, *Proceeding of the 15 th international congress of psychology, Acta psychologica*, 11.
- Inhelder, B & Cellérier, G. eds. (1992). - *Le cheminement des découvertes chez l'enfant, recherches sur les microgenèses cognitives*, Delachaux et Niestlé, Lausanne.
- Inhelder, B., De Caprona, D. (1985). - Constructivisme et création des nouveautés, *Archives de psychologie*, n° 53.
- Inhelder, B., De Caprona, D. (1992 a). - Vers le constructivisme psychologique: structures? procédures? les deux indissociables, in, Inhelder, B & Cellérier, G. eds., *Le cheminement des découvertes chez l'enfant, recherches sur les microgenèses cognitives*, Delachaux et Niestlé, Lausanne.
- Inhelder, B., De Caprona, D. (1992 b). - Un parcours de recherche, in, Inhelder, B & Cellérier, G. eds., *Le cheminement des découvertes chez l'enfant, recherches sur les microgenèses cognitives*, Delachaux et Niestlé, Lausanne.
- Inhelder, B., Piaget, J. (1955). - De la logique de l'enfant à la logique de l'adolescent : essais sur la construction des structures formelles, PUF, Paris.
- Inhelder, B., Piaget, J. (1979). - Procédures et structures, *Archives de psychologie*, n° 181, pp 165-176.
- Johnson, G.I., Wilson, J.R. (1988). - Future directions and research issues for ergonomics and advanced manufacturing technology (AMT), *Applied Ergonomics*, 19.1, pp 3-8.
- Jordan, D.S., Shrager, J. (1991). - The role of physical properties in understanding the functionality of objects, *Proceedings thirteenth annual conference of the cognitive science society*.
- Jorgensen, A.H., Sauer, A. (1990). - The personal touch: a study of users' customization practice, in Diaper & al., *Human-Computer Interaction - INTERACT 90*, Elsevier Science Publishers.
- Keyser, V. de (1988). - De la contingence à la complexité: l'évolution des idées dans l'étude des processus continus, *Le Travail Humain*, 51, n°1, pp 1-18.
- Keyser, V. de (1991). - Can we build a cognitive ergonomics, *Le Travail Humain*, t. 54, 4, 291-304.
- Koehler, W. (1927). - *L'intelligence des singes supérieurs*, Alcan, Paris.
- Kuutti, K. (1992). - HCI research debate and activity theory position, in Gornostaev, j., ed., *Proceedings of the 2 nd EWHCI conference, ICSTI, Moscow*, 7-13.

- Laboratoire National d'Essai (1985). - Rapport sur un essai d'usage de trains électriques pour enfants., LNE, Paris.
- Laborde, C., Mejias, B. (1985). - The construction process of an iteration by middle-school pupils: an experimental approach, Proceedings of the ninth international conference PME, Streefland ed., Utrecht.
- Lafitte, J. (1932). - Réflexions sur la science des machines, Vrin, Paris.
- Lave, J. (1988). - Cognition in practice, Cambridge University Press.
- Laville, A. (1986). - L'ergonomie, Que sais je, PUF, Paris.
- Lebahar, J.C. (1983). - Le dessin d'architecte : simulation graphique et réduction d'incertitude, Parenthèse, Marseille.
- Lefort, B. (1970). - Les utilisations d'outils et la fiabilité de l'organisation, in Recherches menées dans la sidérurgie Française, Rapport à la CEE.
- Lefort, B. (1982). - L'emploi des outils au cours de tâches d'entretien et la loi de Zipf-Mandelbrot, Le Travail Humain, T. 45, n° 2, pp 307-316.
- Legrand, M., Boullier, D., Séchet, J.L., Benguigui, C. (1991). - Entre humain et machine: le mode d'emploi, Rapport de recherche PIRTTEM-CNRS.
- Lehner, P., Zirk, D.A. (1987). - Cognitive factors in user/expert-system interaction, Human factors, 29 (1), 97-109.
- Léonard, F., Rabardel, P. (1984). - Objets matériels fabriqués et développement cognitif, Programme scientifique présenté à l'appui d'une demande de création de RCP (INRP), Paris.
- Léontiev, A. (1965). - L'homme et la culture, Recherches internationales, n° 46.
- Léontiev, A. (1972 - 1976). - Le développement du psychisme, éditions sociales, Paris.
- Léontiev, A. (1975). - Activité, conscience, personnalité, Editions du progrès, Moscou.
- Léontiev, A. (1981). - Problems of the development of mind, Progress Publishers, Moscow.
- Leplat, J. (1985). - Les représentations fonctionnelles dans le travail, Psychologie Française, t. 30, pp 269-275.
- Leplat, J. (1991). - Voies de recherche et champs d'intervention dans les nouvelles technologies., Bulletin de psychologie, T.XLV, n° 404.
- Leplat, J., Bisseret, A. (1965). - Analyse des processus de traitement de l'information chez le contrôleur de la navigation aérienne, Bulletin du C.E.R.P., vol. XIV, n° 1-2.
- Leplat, J., Cuny, X. (1977). - Introduction a la psychologie du travail, PUF, Paris.

- Leplat, J. Pailhous, J. (1973). - L'activité intellectuelle dans le travail sur instrument, Bulletin de psychologie, XXVI, pp. 673-680.
- Leplat, J., Pailhous, J., Vermersch, P. (1974-75). - L'acquisition d'un système de représentation est-elle rationalisable, Bulletin de psychologie, 315, XXVIII, 7-8, pp 398-402.
- Leplat, J. Pailhous, J. (1981). - L'acquisition des habiletés mentales: la place des techniques, Le Travail Humain, t. 44, n°2, pp 275-281.
- Leroi-Gourhan, A. (1964). - Le geste et la parole : Techniques et langages t.1, La mémoire et les rythmes t.2, Albin Michel, Paris.
- Levy, P. (1990). - Les technologies de l'intelligence: l'avenir de la pensée à l'ère informatique, Editions la Découverte, Paris.
- Lhote, F., Dulmet, M. (1992). - A propos du concept de travail, in Colloque interdisciplinaire Travail: recherche et prospective, thème 1: concept de travail P.26-35.
- Linhart, R. (1978). - L'établi, éditions de minuit.
- Luria, A.R. (1979). - The making of mind: a personal account of soviet psychology, in Cole M. & Cole S. eds., Harvard University Press, Cambridge.
- Malone, T.W., Grant K.R. & Turbak, F. (1986). - The information LENS: an intelligent system for information sharing and organisations, Proceedings of the CHI 86 Conference on Human Factors in computing systems, Boston.
- Martin, T. (1989). - On the Way to a future-oriented european production culture, In Cooley M. ed. European Competitiveness in the 21st Century. CCE, Fast.
- Mauss, M. (1935). - Les techniques du corps, Journal de psychologie normale et pathologique, n° 32.
- Mendelsohn, P. (1986). - La transposition de schèmes familiaux dans un langage de programmation chez l'enfant, in Bonnet, C., Hoc, J.M. & Tiberghien, G. eds., Psychologie, intelligence artificielle et automatique, Mardaga, Bruxelles.
- Meyerson, I. (1948). - Le travail: une conduite, Journal de psychologie, XLI.
- Meyerson, I. (1955). - le travail fonction psychologique, Journal de psychologie, LII.
- Meyerson, I. & Leroy, Y. (1980). - Les singes parlent-ils, Journal de psychologie, LXXVII.
- Millot, P. (1991). - Les conditions de coopération entre les sciences de l'ingénieur et les sciences sociales: exemple de la communication homme machine, In Perrin, J. ed., Construire une science des techniques, l'interdisciplinaire, Limonest.

- Minguy, J.L. (1993). - Un instrument d'expert, la carte marine, Communication au Séminaire "Activités avec instruments", Laboratoire d'Ergonomie du CNAM.
- Minguy, J.L., Rabardel, P. (1993). - Control of a Fishing trawl: a multi-instrument process control situation, Stassen, H.G., ed., Analysis, Design and Evaluation of Man-Machine Systems, Pergamon Press, Oxford.
- Minsky, M. (1975). - A framework for representing knowledge, in, Winwton, P. ed., The psychology of computer vision, New York, Mc Graw Hill.
- Montangero, J., Maurice-Naville, D. (1994). - Piaget ou l'intelligence en marche, Mardaga, Liege.
- Montmollin, M. de (1984). - L'intelligence de la tâche. Eléments d'ergonomie cognitive, Peter Lang, Berne.
- Montmollin, M. de (1986). - L'ergonomie, Éditions la Découverte.
- Montmollin, M. de (1992). - The future of ergonomics : hodge podge or new foundation, le Travail Humain, T. 55, n°2, pp 171-181.
- Moore, B.C.J., Newell, A. (1974). - How can Merlin understand?, in L.W. Gregg, ed. Knowledge and Cognition, Erlbaum, Potomac.
- Morin, E. (1984). - Sur la définition de la complexité, Sciences et pratiques de la complexité, proceedings of the colloque de Montpellier, Paris, la documentation française.
- Morishige, R.I. (1987). - Cockpit automation, a Pilot's perspective, Actes du congrès AGARD GCP-FMP, Stuttgart.
- Mounoud, P. (1970). - Structuration de l'instrument chez l'enfant, Delachaux et Niestlé, Paris.
- Netchine, S. (1990). - instrumentation sensorimotrice et acquisitions de connaissances chez l'enfant: l'exemple de l'acquisition de la lecture, in Netchine-Grynberg, G. ed. développement et fonctionnement cognitifs chez l'enfant, PUF, Paris.
- Netchine-Grynberg, G. & Netchine, S. (1989). - A propos de la formation de l'espace graphique chez l'enfant : la notion d'instrument psychologique chez Vygotsky et Wallon, Enfance, 42, pp 101-109.
- Norman, D.A. (1983). - Some observations on mental models, in Gentner, D. & Stevens A.L., Mental models, Lawrence Erlbaum Associates Publishers, London.
- Norman, D.A. (1988). - The psychology of everyday things, New York Basics Books.
- Norman, D.A. (1991). - Cognitive Artifacts, in Designing interaction. Psychology of Human Computer Interface, Caroll J. M. ed. Cambridge University Press.
- Norman, D.A. (1992). - Turns signals are the facial expressions of automobiles, Addison-Wesley Publishing Company, Inc.

- Norman, D.A & Draper, S. eds. (1986). - User centered system design: New perspectives in Human Computer Interaction, Hillsdale, NJ: Lawrence Erlbaum Associates.
- Norros, L. (1991). - Development of operator's expertise in implementing new technologies: constructing a model in a case study on flexible manufacturing, in Ennander A. et al., eds., Work and Welfare, papers from the second Karlstadt symposium on work.
- Ochanine, D.A. (1966). - The operative image of a controlled object in Man-automatic machine system, Congrès International de psychologie Moscou, Symposium 27, pp 48-57.
- Ochanine, D.A. (1978). - Le rôle des images opératives dans la régulation des activités de travail, Psychologie et Education, 2, pp 63-72.
- Ochanine, D.A. (1981). - L'image opérative, Compte rendu du séminaire relatif aux travaux d'Ochanine, Université Paris 1, Département d'ergonomie et d'écologie humaine.
- Ombredane, A., Faverge, J.M. (1955). - L'analyse du travail facteur d'économie humaine et de productivité, PUF, Paris.
- Onfray, M. (1991). - L'art de jouir, Figures, Grasset.
- Ourahay, M. (1991). - La construction géométrique et les instruments classiques de construction, Bulletin AMQ, mars.
- Pascual-Leone, J., Goodman, D., Ammon, P., & Subelman, I. (1978). - Piagetian theory and neo-piagetian analysis as psychological guides in education, in MC Carthy Gallagher, J. & Easley, J.A., eds, Knowledge and development.
- Pavard, B. (1985). - Le traitement de texte professionnel: activités cognitives et contraintes pragmatiques, Document du laboratoire d'ergonomie du CNAM.
- Payne, S. J. (1991). - Interface Problems and Interface Resources, in Designing interaction. Psychology of Human Computer Interface, Caroll J. M. ed. Cambridge University Press.
- Payne, S.J. (1992). - On mental models and artifacts, in Rogers, Y., Rutherford, A., & Bibby, P.A., Models in the minds: theory, perspective and application, Academic Press, London.
- Perriault, J. (1990). - La logique de l'usage: analyse à rebours de l'innovation, La recherche, n° 218.
- Perrin, J., ed. (1991a). - Construire une science des techniques, L'interdisciplinaire, Limonest.
- Perrin, J. (1991b). - Sciences de la nature et sciences de l'artificiel: deux processus différents de production de connaissance, In Perrin, J. ed., Construire une science des techniques, l'interdisciplinaire, Limonest.

- Perrin, J. (1992). - L'historicité de la technique, in Prades, J. ed., La technoscience, les fractures du discours, L'Harmattan, Paris.
- Piaget, J. (1936). - La naissance de l'intelligence chez l'enfant, Delachaux et Niestlé.
- Piaget, J. (1974a). - La prise de conscience, PUF, Paris.
- Piaget, J. (1974b). - Réussir et comprendre, PUF, Paris.
- Piaget, J. , Beth, E.W. (1961). - Epistémologie mathématique et psychologie. Essai sur les relations entre la logique formelle et la pensée réelles, Etudes d'épistémologie génétique n° 14, PUF, Paris.
- Poitrenaud, S. (1993 à paraître). - The PROCOPE semantic network : an alternative to action grammars, in International Journal of Human Computer Studies.
- Poitrenaud, S., Richard, J.F., Tijus, C.A., Leproux, C. (1990). - Analyse de systèmes et aides à l'utilisation, in Boullier, D., Legrand, M. eds. Les mots pour le faire, conception des modes d'emploi, Descartes.
- Poitrenaud, S., Richard, J.F., Tijus, C.A. (1991). - Procedural knowledge representation and learning by doing, Actes de la troisième conférence européenne sur les techniques et les applications de l'intelligence artificielle en milieu industriel et de service, Hermes, Paris.
- Polanyi, M. (1958). - Personal knowledge, London, Routledge & Keagan Paul.
- Poyet, C. (1993). - Les modes de dialogue homme-robot: aides ou obstacles aux représentations du mouvement, in Weill-Fassin A., Rabardel P., Dubois D. eds., Représentations pour l'action, Octares.
- Premack, A.J. (1976). - Why Chimps can read?, Harper & Row, New York.
- Prévost, M.C. (1994). - La psychologie fondamentale, PUF, coll. "Que sais-je", Paris.
- Prieto, L. J. (1966). - Messages et signaux, Presses universitaires de France.
- Prieto, L. J. (1975). - Pertinence et pratique, Les éditions de minuit, Paris.
- Quarante, D. (1994) - Éléments de design industriel, polytechnica, Paris.
- Rabardel, P. (1980). - Contribution à l'étude de la lecture du dessin technique, Thèse de 3ème cycle , EHESS, Paris.
- Rabardel, P. (1982 a). - Intérêts du dessin technique pour l'acquisition et l'évaluation des compétences en montage - démontage , in Psychologie du Travail : Perspective 1990, Actes du deuxième congrès de psychologie du travail de langue française, Paris, pages 236-246.
- Rabardel, P. (1982 b). - La lecture du dessin technique, approches expérimentales et hypothèses, Cahiers de psychologie cognitive n° 4.
- Rabardel, P. (1982 c). - Influence des représentations préexistantes sur la lecture du dessin technique, Le travail humain n° 2.

- Rabardel, P. (1983 a). - Lecture de dessin d'ensemble et définition d'un ordre de montage, *Techniques Industrielles*, n°138 pages 48 à 51.
- Rabardel, P. (1983 b). - Analyser les tâches d'assemblage et de montage, *Techniques Industrielles*, n° 138, pages 51 à 55.
- Rabardel, P. (1984 a). - Eléments pour une analyse des tâches d'assemblage et de montage, *Le Travail Humain*, tome 47, n° 1, pages 50 à 59.
- Rabardel, P. (1984 b). - Gestes et objets matériels fabriqués, Colloque UNICEF - Maîtrise du geste et pouvoirs de la main - Aspects socioculturels.
- Rabardel, P. (1990). - Analyse de l'activité cognitive et modélisation des situations pour l'évaluation et la conception de robots pédagogiques, in actes du 1er congrès francophone de robotique pédagogique, P.45 - 60.
- Rabardel, P. (1991 a). - Activity with a training robot and formation of knowledge, in *Journal of artificial intelligence in Education (USA)*.
- Rabardel, P. (1991 b). - Conception d'objets et schèmes sociaux d'utilisation, *Proceedings of the colloque Recherches sur le design: incitations, implications, interactions*, UTC Compiègne. Paris, éditions A Jour.
- Rabardel, P. (1992). - The use of instruments as a source of spatial knowledge, *Structural Topology*, n°19.
- Rabardel, P. (1993a). - représentations pour l'action dans les situations d'activité instrumentée, in Weill-Fassin A., Rabardel P., Dubois D. eds., *Représentations pour l'action*, Octares.
- Rabardel, P. (1993 b). - Micro-genèse et fonctionnalité des représentations dans une activité avec instrument, in Weill-Fassin A., Rabardel P., Dubois D. eds., *Représentations pour l'action*, Octares.
- Rabardel, P., Béguin, P. (1993). - L'utilisation des fichiers CAO par les concepteurs comme outil de gestion du projet et d'organisation de leur activité, *Actes du colloque 01 Design*, Tunis, 18 - 20 novembre.
- Rabardel, P., Neboit, M., Laya, O. (1985). - Les stratégies visuelles dans la lecture du dessin technique : Effets des objets représentés et de la compétence des sujets, *Le Travail Humain*, tome 48-4.
- Rabardel, P., Verillon, P. (1985). - Relations aux objets et développement cognitif, in *Actes des septièmes journées internationales sur l'éducation scientifique*, Chamonix.
- Ragazzini, I. (1992). - Modalités du diagnostic en échographie médicale, *Mémoire de DEA d'ergonomie*, Laboratoire d'Ergonomie Physiologique et cognitive, EPHE.
- Rapport C.O.S.T. (1991). - Communication Homme-Machine, *Rapport sur la définition, l'état de l'art et les perspectives scientifiques*, CNRS.

- Rasmussen, J. (1983). - Skills, Rules and knowledges: signals, signs and symbols, and other distinctions in human performance models, *IEEE Transactions on Systems, Man and Cybernetics*, SMC 13 (3), 257-266.
- Rasmussen, J. (1986). - *Information Processing and Human-Machine interaction: an approach to cognitive engineering*, Amsterdam, North Holland.
- Reason, J. (1987). - Cognitive aids in process environments: Prosthesis or tools?, *International Journal of Man-Machine Studies*, 27, pp 463-470.
- Reason, J. (1988). - Cognitive aids in process environments: Prosthesis or tools?, in Mancini, G., Woods, D.D. & Hollnagel, E. eds., *Cognitive engineering in dynamic worlds*, London: Academic Press.
- Reason, J. (1990). - *Human error*, Cambridge University Press.
- Rey, A. (1935). - *L'intelligence pratique chez l'enfant (observations et expériences)*, Alcan, Paris.
- Richard J.F. (1983). - *Logique de fonctionnement et logique d'utilisation*, Rapport de recherche n° 202, INRIA.
- Richard, J.F. (1986). - *The semantics of actions, its processing as a function of the task*, Rapport de recherche n° 542, INRIA.
- Richard, J.F. (1990). - *Les activités mentales: comprendre, raisonner, trouver des solutions*, Armand Colin, Paris.
- Richard, J.F., Poitrenaud, S., Tijus, C.A., Barcenilla, J. (1992). - *How to do it? Description and simulation of skill within semantics of action networks*, Draft, Laboratoire de psychologie cognitive du traitement de l'information symbolique, Université de Paris 8.
- Riviere, A. (1990). - *La psychologie de Vygotsky*, Mardaga, Liège.
- Rogalski J. (1987). - *Acquisition de savoirs et de savoir faire en informatique*, Cahier de didactique des mathématiques, n° 43, IREM, Université Paris 7.
- Rogalski J. (1988). - *Les représentations mentales du dispositif informatique dans l'alphabétisation*, in C. Laborde, *Actes du premier colloque Franco-Allemand de didactique des mathématiques et de l'informatique*, La Pensée Sauvage.
- Rogalski, J. (1993). - *Un exemple d'outil cognitif pour la maîtrise d'environnements dynamique*, Communication au Séminaire "Activités avec instruments", Laboratoire d'Ergonomie du CNAM.
- Rogalski, J., Samurcay, R. (1993). - *Représentations de référence: outils pour le contrôle d'environnements dynamiques*, in Weill-Fassina A., Rabardel P., Dubois D. eds., *Représentations pour l'action*, Octares.
- Rosch, E. (1975). - *Cognitive representation of semantic category*, *Journal of experimental psychology*, 104, 192-233.

- Rosch, E. (1978). - Principles of categorisation, in E. Rosch & B.B. Lloyds eds, *Cognition and categorisation*, Hillsdale, New Jersey, Lawrence Erlbaum.
- Roth, E.M., Bennet, K.B. & Woods, D.D. (1987). - Human interaction with an "intelligent" machine, *International Journal of Man-Machine studies*, 27, 479-525.
- Rouse, W., Geddes, N. & Curry, R. (1987). - An architecture for intelligent interfaces: outlines of an approach to supporting operators of complex systems, *Human Computer Interactions*, (3), 87-122.
- Saada-Robert, M. (1985). - Procédures et représentations: les différentes représentations d'un même schème, *Archives de psychologie*, vol. 53, pp. 161-166..
- Saada-Robert, M. (1989). - La microgenèse de la représentation d'un problème, *Psychologie Française*, t. 34, n° 2/3, pp.193-206.
- Saada-Robert, M. (1992). - La construction micro-génétique d'un schème élémentaire, in, *Inhelder, B & Cellérier, G. eds. 1992, le cheminement des découvertes chez l'enfant, recherches sur les microgenèses cognitives*, Delachaux et Niestlé, Lausanne.
- Sacerdoti, (1977). - A structure for plans and behavior, Elsevier, New York.
- Samurcay, R. (1994). - Conception des outils cognitifs pour le développement des compétences : résolution collective de problèmes pour la recherche en ergonomie et pour l'ingénierie, in *Ergonomie et Ingénierie, Actes du 29 ème congrès de la SELF*, Eyrolles, Paris.
- Savoyant, A. (1971). - Diagnostic dans une étude de poste de l'industrie chimique, *Le travail humain*, vol. 34.
- Schank, R.C. (1980). - Language and memory, *Cognitive Science*, n° 4.
- Schank, R.C., Abelson, R.P. (1977). - Scripts, plans, goals and understanding, Hillsdale N.J., Erlbaum.
- Schneuwly, B., et Bronckart, J.P. eds. (1985). - *Vygotsky aujourd'hui* , Delachaux et Niestlé.
- Schwartz, Y. (1988). - *Expérience et connaissance du travail*, Messidor, terrains, Editions sociales.
- Schwartz Y. (1992). - De la qualification à la compétence, *Flash Formation Continue*, n° 9.
- Scribner, S. (1986). - Thinking in action: some characteristics of practical thought , in Sternberg R.J., Wagner R.K., *Practical intelligence (nature and origins of competences in the every day world*, Cambridge University Press.
- Sébillotte, S. (1993). - Schémas d'action acquis par l'expérience dans les représentations mentales des opérateurs: leurs utilisation et la construction

- de nouveaux schémas, in Weill-Fassina A., Rabardel P., Dubois D. eds., Représentations pour l'action, Octares.
- Seltz, O. (1924). - Die Gesetze der produktiven und reproduktiven Geistestätigkeit kurzgefasste Darstellung, Cohen, Bonn.
- Seurat, S. (1977). - Réalités du transfert de technologie, Masson, Paris.
- Sigault, F. (1991 a). - Les points de vue constitutifs d'une science des techniques, essai de tableau comparatif, In Perrin, J. ed., Construire une science des techniques, l'interdisciplinaire, Limonest.
- Sigaut, F. (1991 b). - Postface, In Perrin, J. ed., Construire une science des techniques, l'interdisciplinaire, Limonest.
- Simon, H.A. (1969-1991). - Sciences des systèmes, Sciences de l'artificiel, Dunod, Paris.
- Simondon, G. (1968). - Plan général pour l'étude du problème des techniques, document ronéoté, 121p.
- Simondon, G. (1969). - Du mode d'existence des objets techniques, Aubier, Paris.
- Stengers I., ed. (1987). - D'une science à l'autre: des concepts nomades, Seuil, Paris.
- Sternberg, R.J., Wagner, R.K. (1986). - Practical intelligence (nature and origins of competences in the every day world), Cambridge University Press, .
- Tanguy, L. (1991 a). - L'enseignement professionnel en France : des ouvriers aux techniciens, PUF, Paris.
- Terresac, G. de (1992). - Autonomie dans le travail, PUF, Paris.
- Thon, B., Maury, P., Queinnec, Y. & Marquié, J.C. (1991). - Factors modulating cognitive performances and theoretical models of cognitive representations, Le Travail Humain, t. 54, 4, 291-304.
- Trigg, R.H., Moran, T. P., & Halatsz, F.G. (1987). - Adaptability and tailorability in Note Cards, In proceedings of INTERACT'87. Stuttgart, Germany.
- Valot, C. (1988). - Paradoxes de la confiance dans les systèmes d'aide, in AFCET ed.: Actes du colloque ERGO-IA'88, Biarritz.
- Valot, C., Grau, J.Y., Amalberti, R. (1993). - Les métaconnaissances: représentation de ses propres compétences, in Weill-Fassina A., Rabardel P., Dubois D. eds., Représentations pour l'action, Octares.
- Veldhuyzen, W. & Stassen, H.G. (1977). - The internal model concept: an application to modeling human control of large ships, Human Factors, 19, pp 367-380.
- Vergnaud, G. (1985). - Concepts et schèmes dans la théorie opératoire de la représentation, in S. Ehrlich, ed., Les représentations, Psychologie Française, 30, 3-4, pp 245-252.

- Vergnaud, G. (1990 a). - La théorie des champs conceptuels, Recherches en didactique des mathématiques, Vol. 10, n° 2-3.
- Vergnaud, G. (1990 b). - Catégories logiques et invariants opératoires, Archives de psychologie, n° 58.
- Vérillon, P. (1988 a). - Le statut de l'objet matériel fabriqué chez Piaget, Rapport de recherche, INRP.
- Vérillon, P. (1988 b). - Le statut de l'objet matériel fabriqué chez Vygotsky, Rapport de recherche, INRP.
- Vérillon, P. (1988 c). - Conceptualisation géométrique et activités d'usinage, rapport de recherche, INRP, Paris.
- Vérillon, P. (1991). - Objets matériels fabriqués : approches psychogénétiques de l'instrumentation de l'action, in Meheut, M. ed., Séminaire de didactique des disciplines technologiques : Cachan 1990-91, pp 159-174, Paris VII.
- Vérillon, P. (1993). - Approche instrumentale pour les enseignements technologiques, Document de travail, INRP.
- Vermersch, P. (1976 a). - L'apprentissage du réglage de l'oscilloscope. Régulation conceptuelle et régulation agie, Le Travail Humain, 39, 2.
- Vermersch, P. (1976 b). - Une approche de la régulation de l'activité chez l'adulte, registres de fonctionnement, déséquilibre transitoire et microgenèse, Thèse de 3° cycle, Paris 5.
- Vernant, J.P. (1987). - Introduction aux écrits d'Ignace Meyerson pour une psychologie historique 1920-1983, PUF, Paris.
- Vygotsky, L.S. (1930). - La méthode instrumentale en psychologie, in Vygotsky aujourd'hui, B.Schneuwly et J.P. Bronckart eds., Delachaux et Niestlé.
- Vygotsky, L.S. (1931). - Les bases épistémologiques de la psychologie, in Vygotsky aujourd'hui, B.Schneuwly et J.P. Bronckart eds., Delachaux et Niestlé.
- Vygotsky, L.S.(1934). - Pensée et langage, éditions sociales Paris, 1985.
- Vygotsky, L.S. (1930 - 1974). - Il metodo strumentale in psicologia, in Storia dello sviluppo delle funzioni psichiche superiori. E altri scritti, Firenze, Giunti Barbera.
- Vygotsky, L.S. (1931-1978). - Mind in society, Harvard University Press, Cambridge, Massachusetts.
- Wallon, H. (1935). - Psychologie et technique, Journal de psychologie.
- Wallon, H. (1941). - L'évolution psychologique de l'enfant, Armand Colin, Paris.
- Wallon, H. (1942). - De l'acte à la pensée, Flammarion (ed. 78).
- Wallon, H. (1951). - Psychologie et matérialisme dialectique, Scienta.

- Weill Fassina, A. (1993). - Modalités du diagnostic en échographie médicale, Communication au Séminaire "Activités avec instruments", Laboratoire d'Ergonomie du CNAM.
- Weill Fassina, A., Rabardel, P., Dubois, D. (1993). - Représentations pour l'action, Octarès.
- Wertsch, J.V. (1979). - The regulation of human action in the given new structure of private speech, in G. Sivin ed., The development of self-regulation through speech, Wiley, new York.
- Wertsch, J.V. (1985 a). - The semiotic of mediation of mental life: Vygotsky and Bakhtine, in Mertz, E. & Parmentier, R.J. ed. Semiotic Mediation: sociocultural and Psychological Perspectives, New York Academic Press.
- Wertsch, J.V. (1985 b). - Vygotsky and the social formation of mind, Harvard University Press, Cambridge.
- Winograd, T., Flores, C.F. (1986). - Understanding computers and cognition: A new foundation for design, Norwood, NJ, Ablex.
- Winsemius, W. (1969). - Task structuren storingen en ongevallen, Nederland Instituut voor Preventieve Geneeskunde, TNO, Woltres-Noodhoff, Groningen.
- Winter, C.R. de (1970). - Improvisation dans les tâches manuelles, Le Travail Humain, 33, 3-4, pp 267-280.
- Wisner, A. (1974). - Contenu des tâches et charge de travail, Sociologie du travail, n°4, pp 339-355.
- Wisner, A. (1976). - Ergonomics in the engineering of a factory for exportation, VIth IEA Congress Maryland.
- Wisner, A. (1985). - Quand voyagent les usines, Syros, Paris.
- Woods (1986). - Paradigms for intelligent decision support, in Hollnagell, Mancini & Woods ed., Intelligent decision supports in process environment, NATO ASI series n° 21, 153-173.
- Woods, D.D, Roth, E.M., & Bennet, K.B. (1990). - Explorations in joint Human-Machine Cognitive Systems, in Robertson, S. P., Zachary, W. & J. B. Black eds., Cognition, Computing, and Cooperation.
- Young, R.M. (1983). - Surrogates and mappings: two kinds of conceptual models for interactive devices, in Gentner, D. & Stevens A.L., Mental models, Lawrence Erlbaum Associates Publishers, London.
- Zazzo, R. (1989). - Vygotsky (1896-1934), Enfance, n° 1-2.