

IAD 2013 — 9ème colloque du réseau français d'Immunologie des Animaux Domestiques (IAD).

Paris, 22-23 January 2013

MODELLING THE INTERACTIONS BETWEEN THE PORCINE RESPIRATORY AND REPRODUCTIVE SYNDROME VIRUS AND ITS TARGET CELLS: CONDITIONS FOR VIRUS CLEARANCE

Natacha GO^{1,2}, Caroline BIDOT¹, Catherine BELLOC², Suzanne TOUZEAU^{3,4}

1. UR341 MIA, INRA, F-78350 Jouy-en-Josas, France

2. UMR1300 BioEpAR, Oniris / INRA, F-44307 Nantes, France

3. UMR1351 ISA, INRA, F-06900 Sophia-Antipolis, France

4. Biocore, Inria, F-06900 Sophia-Antipolis, France

INTRODUCTION

Background

- PRRSV = a major concern for swine industry
- Lacking of efficient vaccines for infection control

Immune response

- High variability (host susceptibility & viral virulence)
- Mechanisms responsible for the resolution?
⇒ MODELLING APPROACH

Macrophage – virus interactions

- Target cells : pulmonary macrophages
- Macrophages = key immune cells (phagocytosis, inflammation, adaptive response activation)

MODEL OF THE IMMUNE RESPONSE centered on the **macrophage-virus interactions** in the lung ⇒ Exploration of control measures.

CONCEPTUAL MODEL

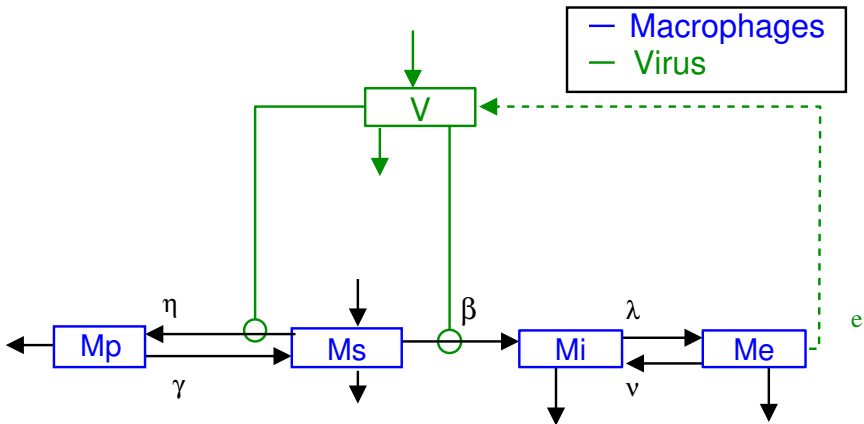

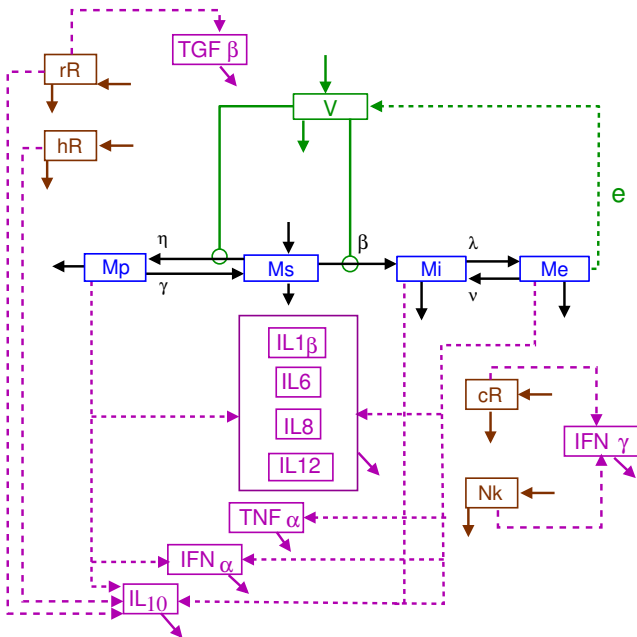

Model

- Formalised by ODE in a deterministic mathematical model

$$\dot{I}_\gamma = \rho_{I_\gamma} [cR + N_k] \frac{[1 + \kappa_1(L_{12}, T_\alpha)] [1 + \kappa_1(L_{12}, I_\alpha)] [1 + \kappa_1(I_\gamma)]}{[1 + \kappa_1(L_{10})] [1 + \kappa_1(T_\beta)]} - \mu_C I_\gamma$$

- 18 state variables & 30 parameters

Calibration

- compiled data from literature (experimental and modelling studies)
- lack of data to inform parameter values and high response variability

Sensitivity analysis

- identify the parameter values resulting in realistic outputs
- identify the key parameters which have a strong influence on model outputs

METHOD

Factorial design

- Production of a fractional factorial design using the R library PLANOR (*Monod et al.*) \Rightarrow 2187 combinations

Output selection

Viral titer, % infected macrophages, % phagocytosing macrophages, NK & cellular response cells

Sensitivity analysis

Multivariate method: R library MULTISENSI, Generalized Sensitivity Method (*Lamboni and Monod*)

RESULTS : SUMMARY

Table of the parameter influences on model outputs: positive effects (+ +), negative effects (- -), no effect ()

	Virus	% infection	% phagocytosis	NK	cellular R
Inoculation V_0	+ +				
Excretion e	+ +	+ +	- -		+ +
Infectiousity β		+ +	- -	+ +	+ +
Phagocytosis η	- -		+ +		

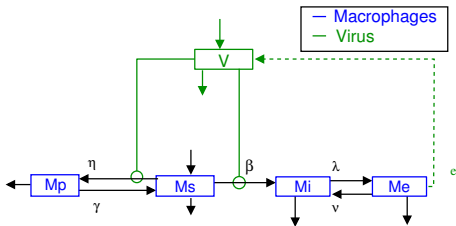

HOST SUSCEPTIBILITY AND VIRAL VIRULENCE

Host susceptibility ↔ capacities of cytokine synthesis by immune cells

Viral virulence ↔ excretion and phagocytosis rate

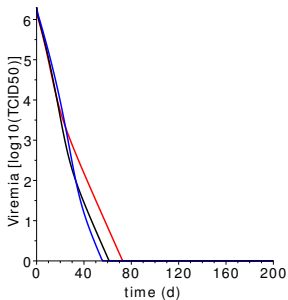

Host susceptibility:

- Susceptible
- Medium
- Resistant

Figure: infection by viral strain with low virulence

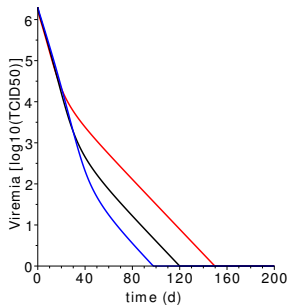
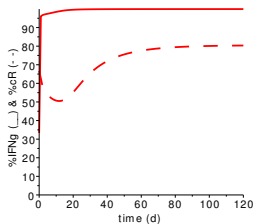
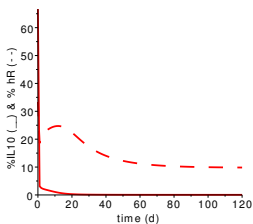
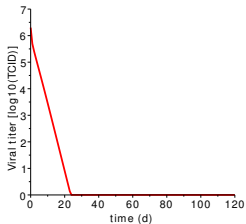
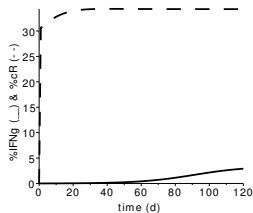
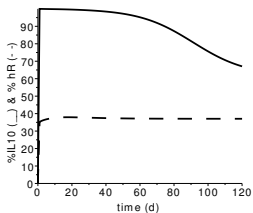
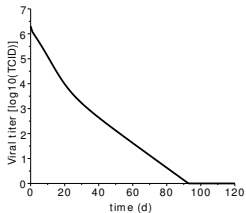

Figure: infection by viral strain with high virulence

VACCINATION EFFECT

Comparison of the infection dynamic without vaccination (—) and with vaccination (—)



CONCLUSIONS & PERSPECTIVES

- **An original model** thanks to the detailed macrophage – virus interactions and the cytokine effects.
- **A model tool:** we can vary the parameter values to
 - a) explore the infection dynamic depending on viral strain and host susceptibility
 - b) test hypothesis (vaccination, ...) to improve infection resolution
 - c) explore the respective influence of immune mechanisms on viral clearance (not presented here)
- **Perspectives:** model extension to the individual scale

THANK YOU FOR YOUR ATTENTION !

References

(1) Planor library :

MONOD H., KOBLINSKY A., AND BOUVIER A. : Automatic generation of regular factorial designs : the PLANOR R library. (2011)

<http://hal.archives-ouvertes.fr/docs/00/71/75/56/ANNEX/planorVignette.pdf>

(2) Multisensi Package :

LAMBONI M. AND MONOD H. : Package 'multisensi' (2012).

<http://cran.r-project.org/web/packages/multisensi/index.html>

EXAMPLE: MACROPHAGES RECRUITMENT

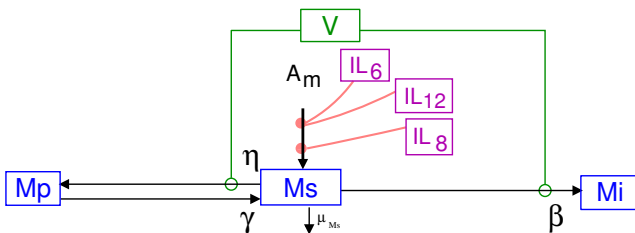

$$\dot{M}_s = A_m (1 + \kappa (IL_{12}, IL_6)) (1 + \kappa (IL_8)) \quad \text{macrophage recruitment}$$

- > *activatory* cytokines: additive effect on the basic rate A_m
- > κ : Michaëlis-Menten function of the cytokine concentration (limited number of cytokine receptors)

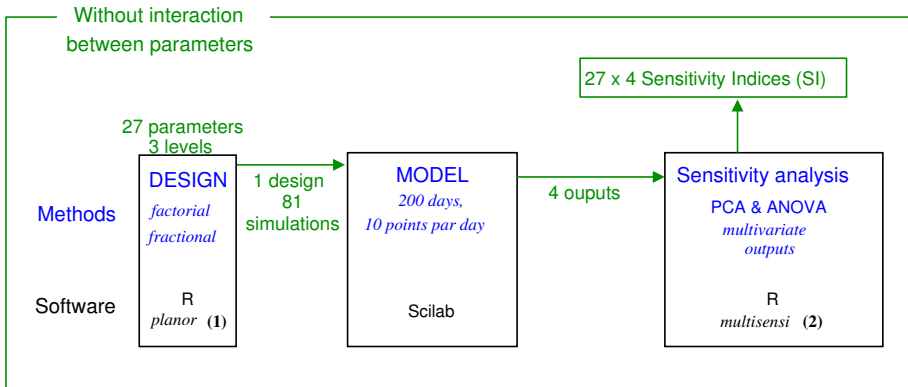

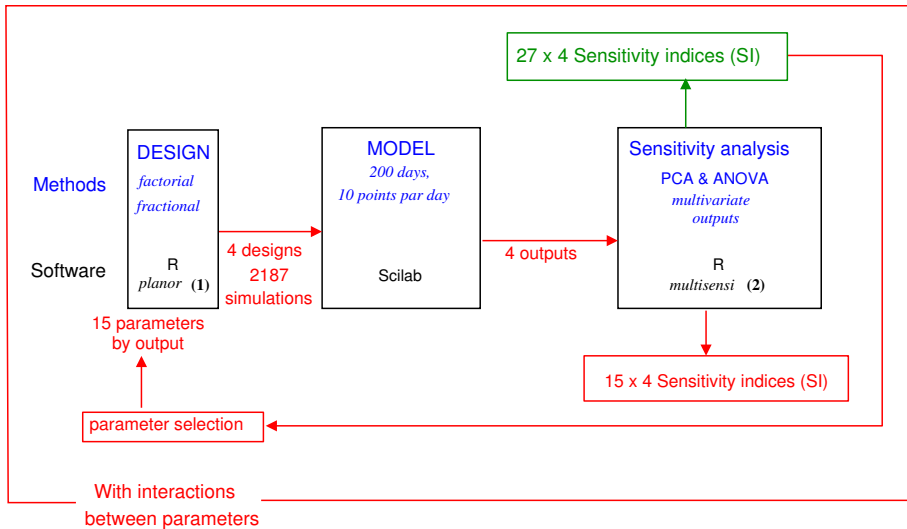

SA RESULTS : VIRUS

A single virus inoculation at the beginning of the simulations (V_0)

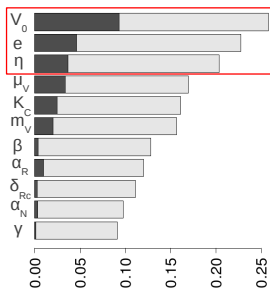
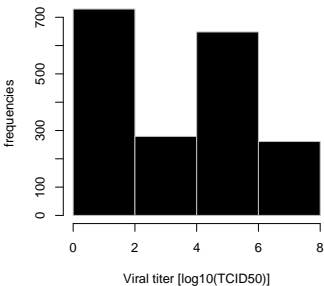

SA RESULTS : VIRUS

