



**HAL**  
open science

# A Nucleolus-based Approach for Resource Allocation in OFDMA Wireless Mesh Networks

Sahar Hoteit, Stefano Secci, Rami Langar, Guy Pujolle

► **To cite this version:**

Sahar Hoteit, Stefano Secci, Rami Langar, Guy Pujolle. A Nucleolus-based Approach for Resource Allocation in OFDMA Wireless Mesh Networks. *IEEE Transactions on Mobile Computing*, 2013, 12 (11), pp.2145-2154. 10.1109/tmc.2012.177 . hal-01018880

**HAL Id: hal-01018880**

**<https://hal.science/hal-01018880v1>**

Submitted on 6 Jul 2014

**HAL** is a multi-disciplinary open access archive for the deposit and dissemination of scientific research documents, whether they are published or not. The documents may come from teaching and research institutions in France or abroad, or from public or private research centers.

L'archive ouverte pluridisciplinaire **HAL**, est destinée au dépôt et à la diffusion de documents scientifiques de niveau recherche, publiés ou non, émanant des établissements d'enseignement et de recherche français ou étrangers, des laboratoires publics ou privés.

# A Nucleolus-based Approach for Resource Allocation in OFDMA Wireless Mesh Networks

Sahar Hoteit, *Graduate Student Member, IEEE*, Stefano Secci, *Member, IEEE*, Rami Langar, *Member, IEEE*, Guy Pujolle, *Senior Member, IEEE*

**Abstract**—Wireless Mesh Networks (WMNs) are emerging as a key solution to provide broadband and mobile wireless connectivity in a flexible and cost effective way. In suburban areas, a common deployment model relies on OFDMA communications between mesh routers (MRs), with one MR installed at each user premises. In this paper, we investigate a possible user cooperation path to implement strategic resource allocation in OFDMA WMNs, under the assumption that users want to control their interconnections. In this case, a novel strategic situation appears: how much a MR can demand, how much it can obtain and how this shall depend on the interference with its neighbors.

Strategic interference management and resource allocation mechanisms are needed to avoid performance degradation during congestion cases between MRs. In this paper, we model the problem as a bankruptcy game taking into account the interference between MRs. We identify possible solutions from cooperative game theory, namely the Shapley value and the Nucleolus, and show through extensive simulations of realistic scenarios that they outperform two state-of-the-art OFDMA allocation schemes, namely Centralized-Dynamic Frequency Planning, C-DFP, and Frequency-ALOHA, F-ALOHA. In particular, the Nucleolus solution offers best performance overall in terms of throughput and fairness, at a lower time complexity.

**Index Terms**—Wireless Mesh Networks, Cooperative Resource Allocation, Nucleolus, Shapley Value, Bankruptcy Game.



## 1 INTRODUCTION

WIRELESS Mesh Networks (WMNs) are emerging as a key solution to provide broadband and mobile wireless connectivity in a flexible and cost effective way. A common deployment model is based on OFDMA communications between mesh routers (MRs), with a user subscription for the installation of one MR at user premises; the local access can then be guaranteed using classical WiFi and wired Ethernet connections.

In this paper, we investigate a user cooperation path for strategic resource allocation in OFDMA WMNs, under the assumption that users want a degree of control to adapt the interconnection and resource allocation policies to their demands. In this case, a novel strategic situation appears: how much a MR can demand, how much it can obtain and how this shall depend on the interference with its neighbors? These questions pose an interesting research challenge.

Interference can occur among neighboring MRs, especially in those suburban or emergency environments with a dense deployment of WMN equipment, when the coverage areas of MRs overlap. In such situations, it is likely that the shared spectrum is not enough to meet all demands, so that demand congestion can persistently occur; hence coordination or cooperation mechanisms are needed between independent and opportunistic users' routers to manage reciprocal interferences and resource allocation and avoid performance degradation during congestion cases. We can refer to such networking cases as collaborative wireless mesh networks.

In collaborative WMNs, nodes' interference levels and demands should be taken into account when allocating resources to them. We propose to model these situations using cooperative game theory, so that resource allocation solutions are strategically justified. Under the rationality hypothesis, users are willing to agree in a binding agreement fixing the game-theoretic resource allocation rule, motivated by the achievable gain in throughput and resiliency; indeed, our results show that such approaches can grant important improvements in throughput and fairness. More precisely, we model resource allocation problem as a bankruptcy game taking into account the interference between MRs. We identify possible solutions from cooperative game theory, namely the Shapley value and the Nucleolus, and show through extensive simulations of realistic scenarios that they outperform two state-of-the-art OFDMA allocation schemes, namely Centralized-Dynamic Frequency Planning, C-DFP, and Frequency-ALOHA, F-ALOHA. In particular, the Nucleolus solution offers best performance overall in terms of

- S. Hoteit is with the LIP6, University Pierre and Marie Curie, Paris 75005, and the Senseable City Lab, MIT, Cambridge, USA (e-mail: sahar.hoteit@lip6.fr).
- S. Secci and R. Langar are with the LIP6, University Pierre and Marie Curie, Paris 75005, France (e-mails: stefano.secci@lip6.fr, rami.langar@lip6.fr).
- G. Pujolle is with the LIP6, University Pierre and Marie Curie, Paris 75005, France and the IT Convergence and Engineering dept., POSTECH, Korea (e-mail: guy.pujolle@lip6.fr).
- A preliminary version of this paper will appear in the proceedings of the IEEE International Conference on Communications (ICC 2012), Ad-hoc, Sensor and Mesh Networking Symposium, Ottawa, Canada, June 10-15, 2012 [1].

throughput and fairness, at a lower time complexity.

The paper is organized as follows. Section 2 presents an overview of related works. In Section 3, we analytically introduce the context of our work and formulate the problem as a bankruptcy game. Section 4 describes our approach, followed by a presentation of simulation results in Section 5. Finally, Section 6 concludes the paper.

## 2 RELATED WORK

Cooperative resource allocation in wireless networks has been considered in recent research works. The general objective is the computation of efficient allocations, while accounting for wireless node interference. A simple solution to OFDMA resource allocation consists in allowing random access to the spectrum in a first-in-first-served fashion, as proposed in [2], where a variation of ALOHA for the OFDMA time-frequency domain is presented. However, in congestion situations this is expected to offer low throughputs, as discussed in details later in the paper. In the following, we discuss a selection of relevant approaches: centralized ones, semi-centralized or hybrid ones and game theoretical ones.

### 2.1 Centralized and hybrid approaches

Authors in [3] and [4] propose Centralized-Dynamic Frequency Planning (C-DFP) mechanisms, implementable when the operator has full control of the WMN equipment. In [3], authors present a suboptimal fair resource allocation scheme in WMNs that maximizes the throughput and guarantees a Quality of Service (QoS) level. Similarly, authors in [5], in order to satisfy QoS levels, propose a more distributed dynamic resource allocation model: users subscribe for guaranteed transmission rates, and then the network periodically reallocates unused bandwidth with short-term service level agreements to users. In [6], authors stress the potential of effective interference detection for channel assignment, in virtual cut-through switching-based networks. Using information on link and possible interference, they solve the resource allocation problem as an edge-coloring problem, where only chosen routes are considered for channel assignment. As decomposition of a master problem, in [4] the authors propose a hybrid centralized-distributed subcarrier allocation scheme based on the Lagrange dual approach and the Lambert-W function, consisting of maximizing the sum rate while satisfying minimum rate demand.

### 2.2 Game-theoretic approaches

The above-described centralized and hybrid approaches do not take into account independent and autonomous network node assumptions, which may result as counter-productive for the framework our work. Instead, these assumptions are taken by the authors of [7], describing a resource allocation mechanism with bargaining

allowed between independent user nodes and the wireless mesh network operator. For this purpose, authors formulate the allocation as an auction game depending on node demand and topology information; then a greedy algorithm is applied to find efficient allocations in polynomial time, while guaranteeing that users are not cheating. Non-cooperative game modeling are also proposed in the literature. For example, the authors of [8] model wireless resource allocation as a non-cooperative game, where end-nodes selfishly play strategy profiles to achieve maximum utility in terms of QoS.

In contrast to [8], the authors in [9] show how node cooperation can improve system performance; in particular they study the effectiveness of transmitter and receiver cooperation, in wireless networks, from a coalitional game theory perspective. Similarly the authors in [10] study the spectrum sharing problem in wireless networks as a dynamic coalition formation game in which wireless links, coexisting in an interference channel of bandwidth, self-organize to reach stable coalition structures. Furthermore, the authors in [11] propose two cooperative resource allocation approaches that increase user satisfaction in WMNs. They take into account subcarrier allocation, power allocation, partner selection/allocation, service differentiation, and packet scheduling. Similarly, authors in [12] propose a fair subcarrier and power allocation scheme to maximize the Nash bargaining fairness: WMN nodes hierarchically allocate groups of subcarriers to the clients, so that each mesh client allocates transmit power among its subcarriers to each of its outgoing links.

Adopting the same user cooperation assumptions and requirements in [11] and [12], in this paper, we model the OFDMA allocation problem in WMNs as a cooperative game. We allow MRs to negotiate resources in multiple MR groups, where groups are locally detected as a function of interferer MR neighbors. Hence we target a solution in which the resource allocation is periodically pre-computed based on changing demands and interference maps. In particular, we consider dense environment situations in which the overall demand is quite often higher than the available bandwidth on the shared media, which mathematically corresponds to a bankruptcy game situation [13], representable in canonical form [14]. As detailed in the following, we investigate two solution concepts: the well-known Shapley value [15] (already adopted in a variety of situations in networking such as inter-domain routing [16] and network security [17]); and the less-known Nucleolus [18] (used, for instance, in strategic transmission computation [19] [14]), which shows additional interesting properties for bankruptcy situations.

## 3 CONTEXT AND PROBLEM FORMULATION

We consider a WMN network meshed using OFDMA technology. Resources are expressed in the time-frequency domain, and are organized in subchannels.

More precisely, we consider a total of 60 subchannels, corresponding to a standard OFDMA frame in the PUSC (Partial Usage of Sub-Channels) mode for a system bandwidth of 20 MHz. A certain number of clients is attached to each MR; client demands represent the required bandwidth, then translated in a number of required subchannels per MR.

It is worth noting that in case of single-hop wireless networks, MR demand corresponds to the attached users' demands only. Whereas, in the multi-hop case, the MR demand shall account for the flow conservation constraint within each MR due to multi-hop relaying. Relay traffic can be integrated in the MR demand knowing that it is upper bounded by the minimum of the neighboring MR demands.

As already mentioned, for dense environments, we expect that the overall demand often exceeds the available resources. Therefore, our objective is to find, for such congestion situations, a strategic resource allocation that satisfies throughput expectations while controlling the inter-node interference. In the following, we first present the corresponding optimization problem, then we highlight possible alternative solutions, and finally describe the properties of bankruptcy games along with possible solutions.

### 3.1 Notations

Let  $\mathcal{R}$  be the set of MRs,  $\vec{d}$  is the demand vector (i.e.  $d_i$  is the demand of  $R_i \in \mathcal{R}$ ), and  $\vec{x}$  is the allocation vector (i.e.  $x_i$  is the number of allocated resources to  $R_i$ ). Also, let  $\mathcal{I}_i$  be the interference set of  $R_i$ , composed of node  $R_i$  plus the set of nodes causing interference to  $R_i$ .<sup>1</sup>

### 3.2 Related centralized optimization problem

For the sake of comparison with common approaches for resource allocation between *non-independent wireless mesh* routers, let us show how the resource allocation problem could be formulated as a centralized mono decision-maker optimization problem, i.e., as the C-DFP approaches mentioned in Section 2. If MRs are not independent, a centralized node may solve the problem as follows:

$$\begin{aligned} \text{objective} \quad & f(\vec{d}, \vec{x}) \\ \text{subject to} \quad & 0 \leq x_i \leq d_i, \forall R_i \in \mathcal{R} \\ & \sum_{j|R_j \in \mathcal{I}_i} x_j \leq E, \forall \mathcal{I}_i \\ & x_i \in \mathcal{Z}^+, \forall R_i \in \mathcal{R} \end{aligned}$$

where  $E$  is the number of subchannels in an OFDMA frame (also referred to in the following as 'estate'). The objective typically depends on the demand and the allocated resources; a common objective is the minimization of the maximum gap between the number of allocated

and required tiles in each MR (i.e., the worst case is optimized). Therefore  $f(\vec{d}, \vec{x})$  can be expressed by:

$$f(\vec{d}, \vec{x}) = \min \max_{i=1}^{|\mathcal{R}|} \left( \frac{d_i - x_i}{d_i} \right). \quad (1)$$

The constraints are integrity constraints, on the allocated tiles to individual nodes and to nodes belonging to same interference sets. Later, we compare game-theoretic approaches to this C-DFP solution highlighting the interest in strategic approaches and stressing the tradeoffs between them.

### 3.3 Possible distributed approaches

For each interference set, we have therefore a situation in which a group of WMN nodes can:

- (i) randomly access the spectrum hoping that collision will not occur (e.g., as in F-ALOHA [2]);
- (ii) self-organize to define an online joint scheduling;
- (iii) divide the available spectrum proportionally.

Clearly, (i) excludes any form of coordination and would favor opportunistic wealth-averse behaviors (e.g., setting a minimum waiting time upon collision in F-ALOHA) that other nodes can not control. Approaches like (ii) risk to generate enormous signaling for large interference sets (likely in dense environments). Under (iii), inefficiency can arise when the demands are less than the proportional share, and a weighted proportional share would favor cheating demands (higher claims than what is really needed).

The path forward is therefore towards cooperative approaches that dissuade malicious behaviors in setting demands, under an adequate binding agreement fixing common rules on shared information and allocation scheme. Before detailing our algorithmic approach, let us introduce the bankruptcy game that can model interactions among WMN nodes belonging to the same interference set.

### 3.4 Bankruptcy game modeling

With a dense deployment of WMN nodes, one should expect situations in which the overall resource claim (i.e., sum of the demands) surpasses the number of available subchannels ( $E$ ) in the shared spectrum. Assuming that WMN nodes, belonging to the same interference set, share information about respective demands, the interaction can be modeled as a cooperative coalitional game.

The choice of the game characteristic function, representing the profit attributed to each coalition of players in a canonical coalitional game, is an important tie-break. We stay under the assumption that a coalition  $S$  of nodes, within the same given interference set  $\mathcal{I}_i$ , group apart so as to decide among them how to share the spectrum. In the most pragmatic case, they will be able to share what the other nodes have left after getting what they claimed. In order to avoid secessions, the utility function of the game should be superadditive, that is,

1. For a better understanding of the interference set composition, please refer to the example presented in Section 4.3.

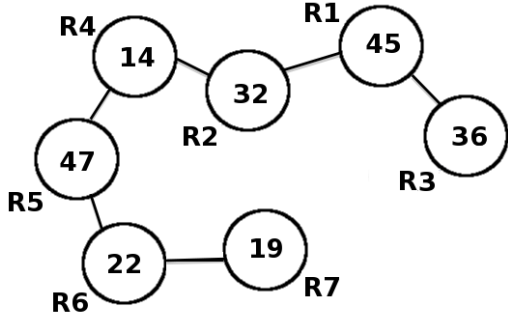


Fig. 1: An example of 7-node Wireless Mesh Network; a link indicates an interference relationship and the value indicates nodes's demand.

the best coalition should be the grand coalition grouping all nodes in the same interference set:

$$v(S_1 \cup S_2) \geq v(S_1) + v(S_2), \forall S_1, S_2 \subset \mathcal{N} \quad (2)$$

where  $v(S)$  is the payoff of all nodes in  $S$ . Such a characteristic function corresponds, in fact, to what is known as 'bankruptcy game' precisely defined hereafter.

**Definition 3.1.** A bankruptcy game [13] is defined as  $G(\mathcal{N}, v)$  where  $\mathcal{N}$  represents the claimants of the bankruptcy situation and  $v$  is the characteristic function that associates to each coalition its worth defined as the part of the estate not claimed by its complement:

$$v(S) = \max(0, E - \sum_{i \in \mathcal{N} \setminus S} d_i), \forall S \subseteq \mathcal{N} \setminus \{\emptyset\} \quad (3)$$

where  $E \geq 0$  is an estate that has to be divided among the members of  $\mathcal{N}$  (the claimants) and  $d \in R_+^{|\mathcal{N}|}$  is the claim vector such that  $E < \sum_{i \in \mathcal{N}} d_i$ .

Equation (3) has been proven to be superadditive [20]. Moreover, it satisfies the supermodularity property [15] [21], stronger than the superadditivity, which means that the marginal utility of increasing a player's strategy rises with the increase in other player strategies:

$$v(S_1 \cup S_2) + v(S_1 \cap S_2) \geq v(S_1) + v(S_2), \forall S_1, S_2 \subset \mathcal{N}. \quad (4)$$

### 3.5 Possible imputation schemes

Solutions to cooperative games are essentially qualified with respect to the satisfaction of rationality constraints, desirable properties and existence conditions. Namely, the Core of a game is the set of imputations that satisfies individual and collective rationality (one or a coalition gets at least what it would get without cooperating), and efficiency (all the estate is allocated). As already mentioned, a common solution for cooperative games in networking is the Shapley value, because it shows desirable properties in terms of null player, symmetry, individual fairness, and additivity [15]. It is defined as:

$$\Phi_i(v) = \sum_{S \subset \mathcal{N} \setminus \{i\}} \frac{|S|!(N - |S| - 1)!}{N!} [v(S \cup \{i\}) - v(S)] \quad (5)$$

i.e., computed by averaging the marginal contributions of each mesh router in the network in each strategic situation i.e., (players' permutation). Nevertheless, the Shapley value is not consistent [13], in the following sense.

**Definition 3.2.** An allocation  $x = (x_1, x_2, \dots, x_N)$  is consistent if  $\forall i \neq j$  the division of  $x_i + x_j$ , prescribed for claims  $d_i$  and  $d_j$ , is  $(x_i; x_j)$ .

This means that no player or group of players can gain more by unilaterally deviating from a consistent solution since it will always obtain the same profit. For cooperative WMNs, this discourages clustering-like solutions inside an interference set.

Another appealing solution concept, the Nucleolus, that is the unique consistent solution in bankruptcy games. However, it does not always satisfy null player, symmetry and additivity property (though small variations can fix these too). The Nucleolus is the imputation that minimizes the worst inequity. It is computed by minimizing the largest excess  $e(x, S)$ , expressed as:

$$e(x, S) = v(S) - \sum_{j \in S} x_j, \forall S \subset \mathcal{N} \quad (6)$$

The excess  $e(x, S)$  measures the amount by which the coalition  $S$  falls short of its potential  $v(S)$  in the allocation  $x$ ; the Nucleolus corresponds to the lexicographic minimum imputation of all possible excess vectors.

## 4 AN ALGORITHMIC GAME APPROACH

The game-theoretic approach we propose is composed of two main phases: an Interference Set Detection phase and a Bankruptcy Game Iteration phase. Formally, it represents a binding agreement between cooperating MRs.

### 4.1 Interference Set Detection

Upon each significant change in demands or in network topology, each node determines the set of interferer nodes included inside its coverage area. MRs are able to share their interference set and their demands with other nodes in the network.<sup>2</sup>

Next, the list of interference sets are sorted, firstly with respect to their cardinality, and secondly with respect to the overall demands, both in a decreasing fashion; i.e., first the largest sets with highest overall demands.

2. This information can be exchanged regularly between the nodes by broadcast messages, using a control channel that could be in-band (e.g., using a dedicated tile) or out-of-band. Moreover, the execution interval of the reallocation might be scheduled at regular intervals or subject to real-time coordination. These two aspects are out of the scope of this paper, though it is important to mention them at this point.

TABLE 1: Interference relationships

Mesh Router	Interferers
$R_1$	$\{R_2, R_3\}$
$R_2$	$\{R_1, R_4\}$
$R_3$	$\{R_1\}$
$R_4$	$\{R_2, R_5\}$
$R_5$	$\{R_4, R_6\}$
$R_6$	$\{R_5, R_7\}$
$R_7$	$\{R_6\}$

TABLE 2: Interference Sets

Steps	Mesh Router sets
1	$\{R_1, R_2, R_3\}$
2	$\{R_2, R_4, R_5\}$
3	$\{R_1, R_2, R_4\}$
4	$\{R_5, R_6, R_7\}$
5	$\{R_4, R_5, R_6\}$
6	$\{R_1, R_3\}$
7	$\{R_6, R_7\}$

TABLE 3: Coalitional payoffs

Coalition	$v(S)$
$\emptyset$	0
$R_1$	0
$R_2$	0
$R_3$	0
$R_1 \cup R_2$	24
$R_1 \cup R_3$	28
$R_2 \cup R_3$	15
$R_1 \cup R_2 \cup R_3$	60

TABLE 4: Shapley value computation

Permutation	$R_1$	$R_2$	$R_3$
$R_1, R_2, R_3$	0	24	36
$R_1, R_3, R_2$	0	32	28
$R_2, R_1, R_3$	24	0	36
$R_2, R_3, R_1$	45	0	15
$R_3, R_1, R_2$	28	32	0
$R_3, R_2, R_1$	45	15	0
Average	24	17	19

## 4.2 Bankruptcy Game Iteration

In the second phase, resources are eventually allocated, proceeding with solving a bankruptcy game for each interference set, following the order in the sorted list from the first phase. The rationale behind such an agreement is that we first solve the most critical bankruptcy situations. Strategically, in this way we do not penalize nodes that interfere less compared to nodes that interfere more, as well as nodes that claim a little compared to nodes that claim a lot.

Note that, since a node can belong to many interference sets, if it has already participated to a game in a previous game iteration, it is excluded from the next game iteration in which it appears. Each game iteration therefore includes only the nodes for which an allocation has not been computed yet. This corresponds in iterating a game differing in that:

- $\mathcal{N}$  includes only the unallocated nodes in the set;
- the estate  $E$  is decreased by the amount already allocated to the set's nodes.

The initial sorting guarantees available resources to unallocated MRs.

## 4.3 An illustrative example

We consider a WMN composed of seven routers as shown in Fig. 1; the number inside each router represents the number of required subchannels, and the lines between routers represent an interference relationship, as reported in Table 1. For example, the mesh router  $R_1$  has two interferers:  $R_2$  and  $R_3$ . Therefore, the corresponding interference set will be composed of  $R_1, R_2$  and  $R_3$ .

The sorted interference set list described in Section 4.1, is presented in Table 2; the first step includes the players of a bankruptcy game  $G(\mathcal{N}, v)$  where  $\mathcal{N} = \{R_1, R_2, R_3\}$ , and the coalitional payoffs are given in Table 3;  $v(\mathcal{N}) = E = 60$  since no node has participated to any previous game.

Table 4 reports the Shapley values (rounded) as well as the detail on each mesh router's marginal contributions (columns).

For the Nucleolus, one starts at an arbitrary point such that  $x_1 + x_2 + x_3 = 60$ , e.g.,  $(30, 10, 20)$ , as in the step-1 part of Table 5. Then, one minimizes the largest excess, corresponding to coalition  $R_2$  in this case; but,

TABLE 5: Nucleolus computation

Step 1:				
Coalition	$e(x, S)$	(30, 10, 20)	(25, 16, 19)	(26, 16, 18)
$R_1$	$-x_1$	-30	-25	-26
$R_2$	$-x_2$	-10	-16	-16
$R_3$	$-x_3$	-20	-19	-18
$R_1 \cup R_2$	$24 - x_1 - x_2$	-16	-17	-18
$R_1 \cup R_3$	$28 - x_1 - x_3$	-22	-16	-16
$R_2 \cup R_3$	$15 - x_2 - x_3$	-15	-20	-19

Step 2:			
Coalition	$e(x, S)$	(10, 34)	(7, 37)
$R_4$	$-x_4$	-10	-7
$R_5$	$30 - x_5$	-4	-7
Step 4:			
Coalition	$e(x, S)$	(12, 11)	(13, 10)
$R_6$	$4 - x_6$	-8	-9
$R_7$	$1 - x_7$	-10	-9

this coalition can claim that every other coalition is doing better than it is. So, one tries to improve this coalition by making  $x_2$  larger or, equivalently,  $x_1 + x_3$  smaller since  $x_3 = 60 - x_1 - x_2$  (feasibility property); but, decreasing the excess of  $R_2$ , the excess of  $R_1 \cup R_3$  increases at the same rate and these excesses then meet at  $-16$ , when  $x_2 = 16$ . Clearly, no allocation  $x$  can make the excess smaller than  $-16$  since at least one of the coalitions  $R_2$  or  $R_1 \cup R_3$  can have at least an excess of  $-16$ . Hence,  $x_2 = 16$  is the first component of the Nucleolus. Proceeding in the same manner, one finally obtains the Nucleolus allocation  $(26, 16, 18)$ .

We move now to the second step, in this case the total estate to distribute among mesh routers is not 60 subchannels any longer since  $R_2$  has already participated to a game and obtained its resources; thus the new game is formed of two players,  $R_4$  and  $R_5$ , and the total payoff  $v(\mathcal{N})$  is then equal to  $E - x_2 = 60 - 16 = 44$  subchannels ( $x_2 = 16$  in the obtained Nucleolus solution), as reported in Table 6. The Shapley value computation for this second game is illustrated in Table 7. Moreover, for the Nucleolus, we obtain the step-2 part of Table 5.

Then, at the third step, the mesh routers  $R_1, R_2$  and  $R_4$  have all taken their required resources, so there is no formed game in this step.

TABLE 6: Coalitional payoffs

Coalition	Payoff
$\emptyset$	0
$R_4$	0
$R_5$	30
$R_4 \cup R_5$	44

TABLE 7: Shapley value computation

Permutations	$R_4$	$R_5$
$R_4, R_5$	0	44
$R_5, R_4$	14	30
Average	7	37

TABLE 8: Coalitional Payoffs

Coalition	Payoff
$\emptyset$	0
$R_6$	4
$R_7$	1
$R_6 \cup R_7$	23

TABLE 9: Shapley value computation

Permutations	$R_6$	$R_7$
$R_6, R_7$	4	19
$R_7, R_6$	22	1
Average	13	10

At the fourth step, the total estate to distribute among mesh routers is equal to  $E - x_5 = 60 - 37 = 23$  subchannels, as reported in Table 8. The Shapley value computation for this game is illustrated in Table 9. Moreover, for the Nucleolus, we obtain the step-4 part of Table 5.

The algorithm stops at this point since all mesh routers have received their resources. As it can be noticed, the Nucleolus smoothes the maximum and the minimum allocation, preventing from extremely low and extremely high allocations for mesh routers that interfere a lot and interfere a little, respectively.

#### 4.4 Dealing with cheating behaviors

In the proposed approach, we may face the problem of cheating behaviors by some MRs as an effect of the demand-allocation approach, i.e. MRs could end up with higher allocations if they claim higher demand. While in non-cooperative game theory cheating behaviors can be undetectable due to the uncoordinated nature of the decision-making process, we can manage this problem in cooperative games by a binding agreement that fixes the rules of the cooperation, i.e., our algorithm to compute the allocation, and possibly also the implementation of node blacklisting mechanisms. Such a mechanism should be operated upon explicit automated signaling by tile sensing nodes, detecting that allocated slots to other neighboring nodes are finally not used enough (since the channel is shared, this sort of operation is easily implementable by nodes' antennas during idle periods). A result of the blacklisting is the isolation of the cheating node in the collaborative resource allocation and/or the systematic dropping of its traffic to be relayed in the WMN.

## 5 PERFORMANCE EVALUATION

In this section, we evaluate the proposed game-theoretic approaches (i.e., Shapley value and Nucleolus) on large instances. C-DFP and F-ALOHA schemes, presented

in Section 2, are used as benchmarks: the first represents the centralized solution, and the second the non-collaborative solution.

We simulated<sup>3</sup> realistic scenarios with three different network sizes (25, 50 and 100 nodes) representing respectively low, medium and large densities. MRs are randomly distributed in a 5km×5km area. Each node determines the set of its interferers, inside its coverage area. Mesh clients are uniformly distributed within a MR radius of 275m, and each one of them uniformly generates its traffic demand that can be directly translated to a certain number of subchannels. We consider a typical downlink OFDMA frame consisting of  $E = 60$  subchannels.

Before delving into the exploration of the results, Fig. 2 gives an idea about the topologies obtained for the three datasets, with the node interference degree distribution (corresponding to the number of neighboring nodes causing interference). As it can be noticed, the number of isolated nodes not suffering from interference increases with the network size.

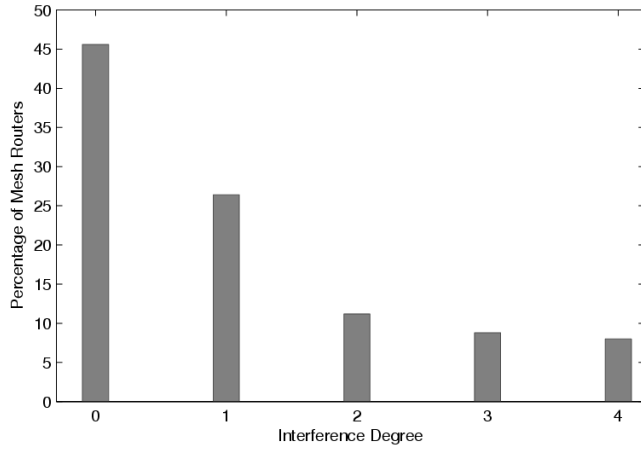
Let us now focus on the comparison among the different strategies based on the offered throughput, the allocation fairness and the computation time. The results are obtained over many simulation instances for each dataset, with a margin error less than 3%; we do not plot corresponding confidence intervals for the sake of presentation.

### 5.1 Throughput analysis

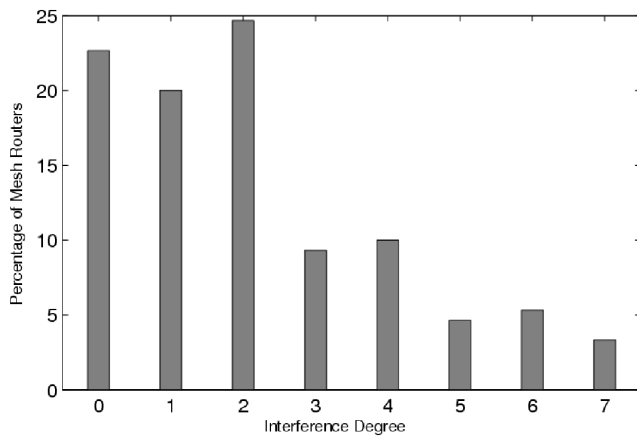
Fig. 3 reports the mean normalized throughput (i.e., mean ratio of the number of allocated subchannels to the total demand; in the following referred to as throughput) for the three considered datasets. We can here appreciate how much the strategic constraints in game theory approach, and in particular the individual and collective rationality, contribute in avoiding low throughputs. In particular, we can assess that:

- At low throughputs, F-ALOHA and C-DFP offer very low performance, especially in dense environments; e.g., the 100-node case, in F-ALOHA around 6% of the MRs obtain null throughput, and about 23% in C-DFP obtain a throughput less than 30%, while these numbers (percentage of nodes) are roughly halved with game-theoretic approaches.
- The median throughput is always higher for the Nucleolus; e.g., in the 100-node case, 47% for the Nucleolus, 39% for the Shapley value, 37% for F-ALOHA and 29% for C-DFP.
- At high throughputs, F-ALOHA shows a small benefit over the Nucleolus, but in all cases the median throughput of the Nucleolus is still the highest among all approaches.

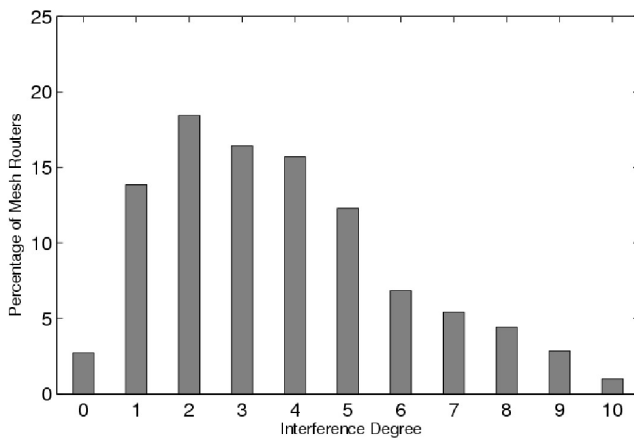
<sup>3</sup>. Datasets and MATLAB codes are available at <http://www-phare.lip6.fr/wimesh/ResAll-GT.zip>



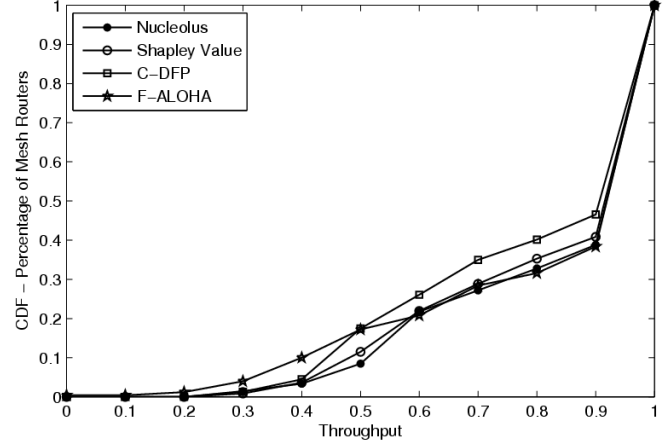
(a) 25 nodes



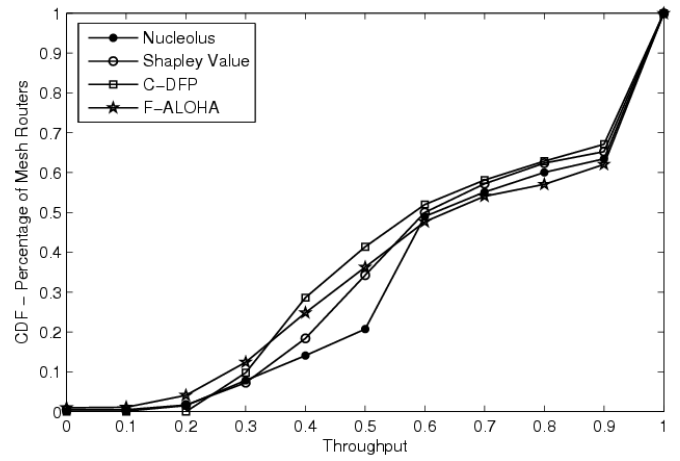
(b) 50 nodes



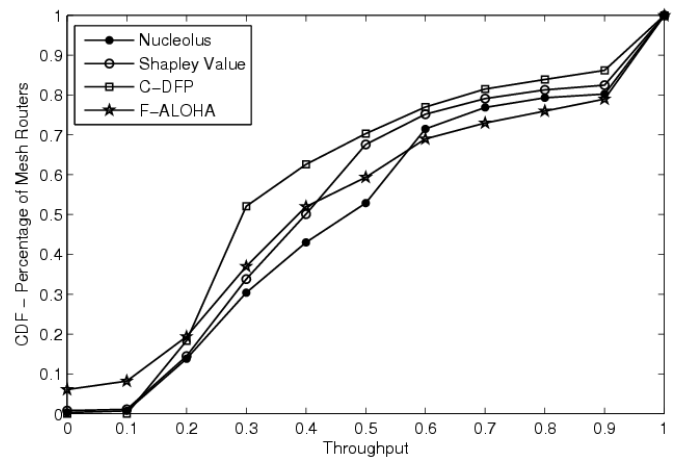
(c) 100 nodes



(a) 25 nodes



(b) 50 nodes



(c) 100 nodes

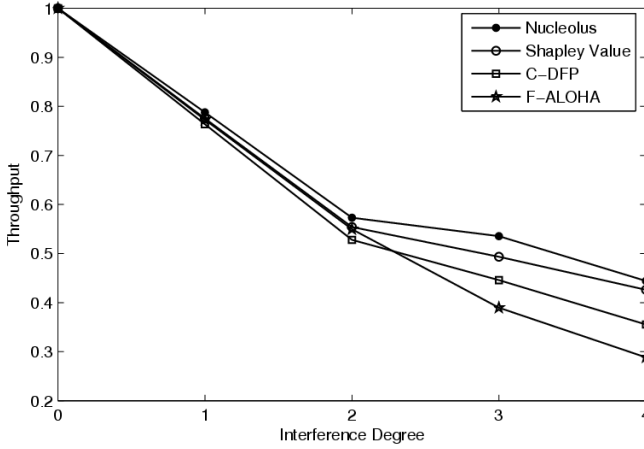
Fig. 2: Interference degree distribution for the three cases

Fig. 3: Throughput Cumulative Distribution Function (CDF) for the three cases.

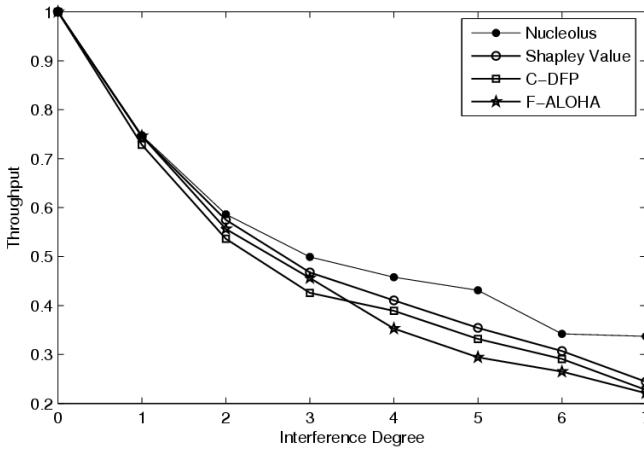


TABLE 10: Mean Fairness Indexes

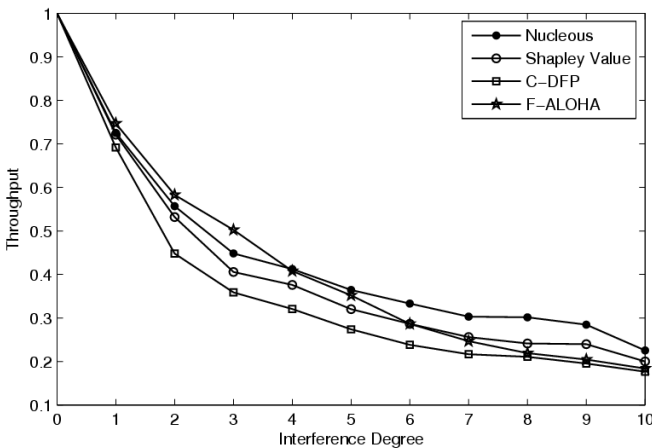
Nodes	Nucleolus	Shapley Value	C-DFP	F-ALOHA
25	0.938172	0.93338	0.932365	0.917713
50	0.863358	0.85666	0.83489	0.839741
100	0.756731	0.729936	0.700218	0.69025



(a) 25 nodes



(b) 50 nodes



(c) 100 nodes

Fig. 4: Throughput distribution as a function of the interference degree.

- Among the game-theoretic approaches, the Nucleolus persistently outperforms the Shapley value, with relevant differences at medium-low throughputs.

All in all, the Nucleolus seems the most appropriate approach with respect to the offered throughput, especially in high density environments. Moreover, the C-DFP approach appears as the most inadequate one, and the F-ALOHA offers low throughputs to a significant portion of the MRs.

## 5.2 Fairness analysis

We evaluate the fairness of the solutions with respect to three aspects.

- (i) with respect to the Jain's fairness index [22], defined as:

$$FI = \left( \sum_{i=1}^N (x_i/d_i) \right)^2 / \left( N \sum_{i=1}^N (x_i/d_i)^2 \right) \quad (7)$$

reported in Table 10. It is easy to notice that game-theoretic approaches give the highest fairness, thanks to the strategic constraints that avoid penalizing nodes with lower demands. Again, game-theoretic outperform the others, with important differences with the 100-node dataset.

- (ii) Fig. 4 further investigates how the node interference degree is taken into account, illustrating the mean normalized throughput as a function of the interference degree (that corresponds to the cardinality of its interference set). We can assess that:

- Globally, C-DFP appears as the less performant solution.
- The Shapley value outperforms F-ALOHA and C-DFP, especially for low-density networks, while for high-density networks and high-interference degrees it shows a roughly 5% better throughput than F-ALOHA and C-DFP.
- The Nucleolus always outperforms the other methods for all network sizes and for all interference degrees. It shows a throughput increase of approximately 10%, 15% and 20% than other approaches in low, medium and high-density networks, respectively.

It seems appropriate to conclude that the interference degree is taken into account in a significantly different way with the Nucleolus, showing an interesting fairness performance certainly, especially desirable for dense environments.

(iii) in order to assess how the allocated resource is affected by the demand volume, Fig. 5 plots the throughput as a function of the WMN node demand. Globally, the ALOHA and C-DFP approaches show a roughly constant behavior, which implies that their resource allocation is done irrespectively of the demand. On the other hand, game-theoretic approaches decrease with growing demands. In particular, the Nucleolus favors low demands with respect to high demands significantly more than the Shapley value. This may be interpreted as unfair for high demands. However, under a network management standpoint, it might be seen a positive behavior as the Nucleolus can discourage too greedy demands at the benefit of lower ‘normal’ demands.

### 5.3 Computation time analysis

Last but not least, it is important to assess if the overall good performance of game-theoretic approaches come at the expense of a higher time complexity.

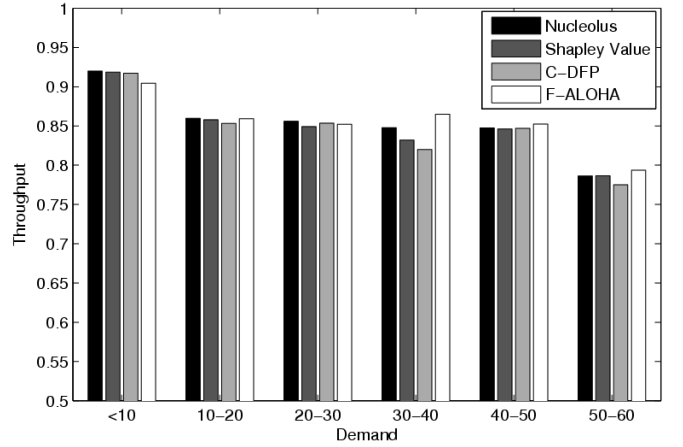
Fig.6 reports boxplots (i.e., quartile boxes plus maximum, minimum and outliers) of the computation time for the C-DFP, Shapley value and Nucleolus approaches. It is easy to notice that C-DFP has quite high computation times, on the order of seconds for 25, 50-node networks and dozens of seconds for 100-node networks. A stronger dependence on the interference set size (higher for high interference levels) appears for the Shapley value, which is not surprising since the number of marginal contributions equals the factorial of the interference set size. In turn, the Nucleolus does not show any important dependence neither on the network size nor on the interference level, with a median computation time of roughly 3s for dense high-interference environments.

## 6 CONCLUSION

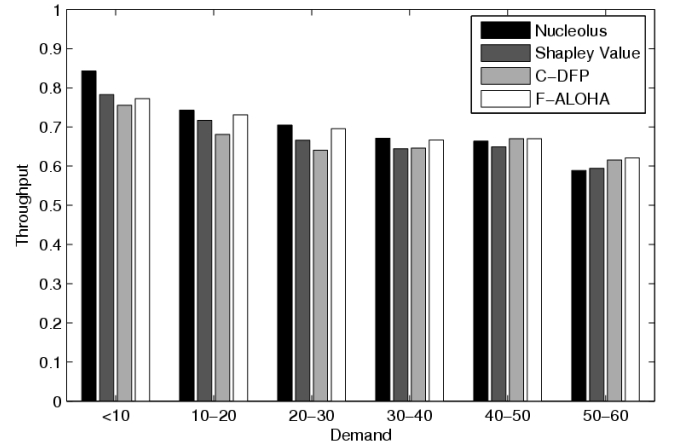
Wireless mesh networks based on Orthogonal Frequency Division Multiple Access (OFDMA) is a promising solution for high-speed data transmissions and wide-area coverage. In the case Wireless Mesh Networks’ customers desire a control of the Mesh Router coming with their subscription, strategic resource allocation mechanisms appear as desirable solutions.

In this paper, we have investigated novel approaches based on the theory of cooperative games motivated by the fact that such approaches allow accounting for strategic interactions among independent Wireless Mesh Networks’ nodes, and by the intuition that they can offer better performance in dense environments.

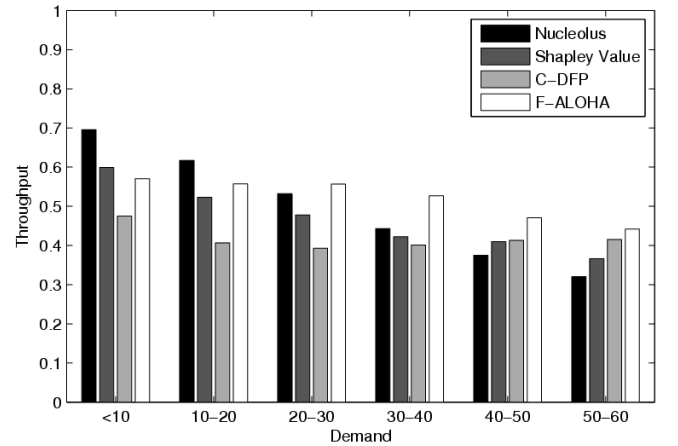
In particular, this paper presented a game-theoretic approach for strategic resource allocation in OFDMA-based cooperative Wireless Mesh Networks. Upon distributed detection of interference maps, the proposed approach iterates bankruptcy games from the largest interference set with highest demand to the lower sets. We motivated the adoption of solutions from coalitional game theory, the Nucleolus and the Shapley value, highlighting how



(a) 25 nodes

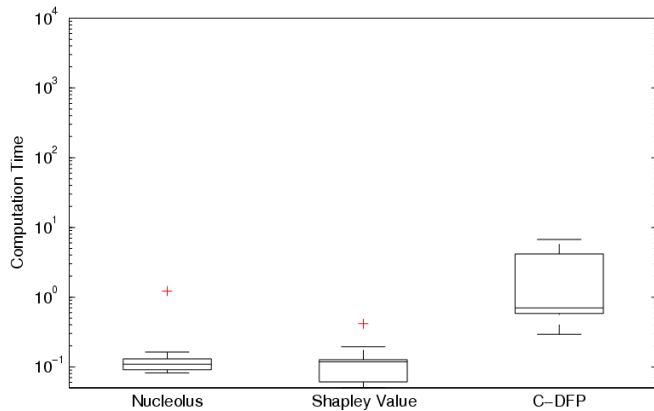


(b) 50 nodes

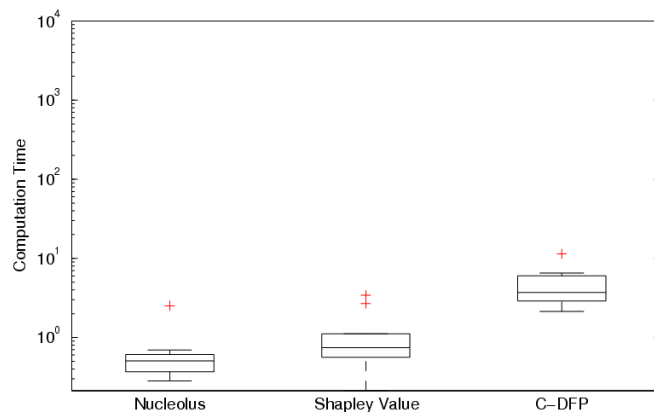


(c) 100 nodes

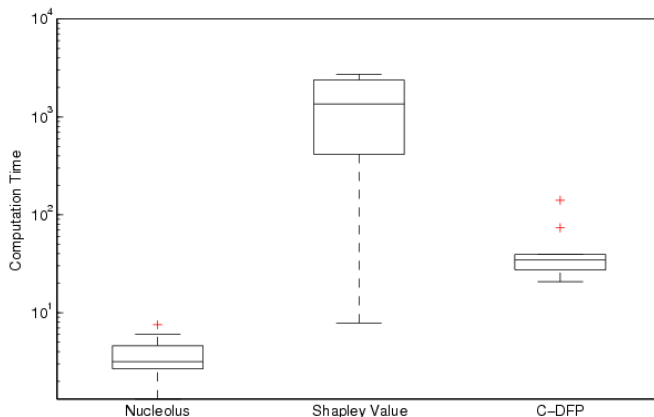
Fig. 5: Throughput distribution as a function of the demand.



(a) 25 nodes



(b) 50 nodes



(c) 100 nodes

Fig. 6: Computation time comparison

their properties can help meeting performance goals. Through extensive simulations using realistic datasets, we compared game-theoretic approaches to state-of-the-art proposals. With respect to throughput and fairness, the proposed approaches outperform the others. In particular, the Nucleolus solution is strictly superior to all the others, achieving higher throughputs, namely an increase of 10%, 15% and 20% for high interference degrees in low, medium and high-density networks, respectively. Moreover, computationally, the Nucleolus is far more competitive than the other approaches. The Nucleolus approach represents therefore a promising approach for resource allocation in future wireless mesh network deployments.

As a future work, we aim to investigate how the cooperative interaction among independent MRs can be seen taking into consideration user mobility patterns and cheating behaviors of Mesh clients.

## REFERENCES

- [1] S. Hoteit, S. Secci, R. Langar, G. Pujolle. "Strategic Subchannel Resource Allocation for Cooperative OFDMA Wireless Mesh Networks", <http://www-phare.lip6.fr/~secci/papers/HoSeLaPu-ICC12.pdf>.
- [2] V. Chandrasekhar, J. Andrews, "Spectrum allocation in tiered cellular networks", *IEEE Trans. Communications*, Vol. 57, No. 10, 2009.
- [3] I. Ahmed, A. Mohamed, T. Fouly, Y. Hu, "On the Fairness of Frequency Domain Resource Allocation in Wireless Mesh Networks-A Survey" in *Proc. of IEEE GCC Conference*, Dubai, 19-22 February, 2011.
- [4] F. Brah, A. Zaidi, J. Louveaux, L. Vandendorpe, "On the Lambert-W Function for Constrained Resource Allocation in Cooperative Networks", *EURASIP J. on Wireless Communications and Netw.*, Vol. 2011, 2011.
- [5] A. Capone, J. Elias, F. Martignon, G. Pujolle, "Dynamic Resource Allocation in Quality of Service Networks", *Springer Lecture Notes in Computer Science*, Vol. 3883, 2006.
- [6] D. Saha, A. Dutta, D. Grunwald, D. Sicker, "Channel Assignment in Virtual Cut-Through Switching based Wireless Mesh Networks" in *Proc. of ICDCN*, Kolkata, India, January 2010.
- [7] F. Martignon, S. Paris, I. Filippini, A. Capone, "Efficient Bandwidth Allocation in Wireless Community Networks" in *Proc. of Wireless Days 2011*, Niagara Falls, Ontario, Canada, October 2011.
- [8] M. Cesana, I. Malanchini, and A. Capone, "Modelling network selection and resource allocation in wireless access networks with non-cooperative games" in *Proc. of MASS, 2008*
- [9] S. Mathur, L. Sankar, and N. B. Mandayam, "Coalitions in cooperative wireless networks", *IEEE Journal on Selected Areas in Communications*, Vol. 26, Sept. 2008.
- [10] Z. Khan, S. Glisic, L. DaSilva, and J. Lehtomaki, "Modeling the dynamics of coalition formation games for cooperative spectrum sharing in an interference channel", *IEEE Trans. On Computational Intelligence and AI in Games*, 2011.
- [11] H. Cheng, W. Zhuang, "QoS-driven MAC-layer resource allocation for wireless mesh networks with non-altruistic node cooperation and service differentiation", *IEEE Trans. Wireless Comm.*, Vol. 8, Dec. 2009.
- [12] K. Lee, and V. Leung, J. Louveaux, L. Vandendorpe, "Fair allocation of subcarrier and power in an OFDMA wireless mesh networks", *IEEE J. on Selected Areas in Communication*, Vol. 24, March 2006.
- [13] R. J Aumann, M. Maschler, "Game Theoretic Analysis of a Bankruptcy Problem from the Talmud", *Journal of Economic Theory*, Vol. 36, 1985.
- [14] W. Saad et al., "Coalitional Game Theory in Wireless and Communications Networks", *IEEE Signal Processing Magaz.*, Vol. 26, No. 5, 2008.
- [15] L. Shapley, "A value for n-person games", *Contributions to the Theory of Games*, Annals of Math. Studies, 28. Princeton U Press., 1953.

- [16] M. Mycek et al., "Cooperative Multi-Provider Routing Optimization and Income Distribution", in *Proc. of DRCN 2009*.
- [17] T. Alpcan, T. Basar, "A game theoretic approach to decision and analysis in network intrusion detection", in *Proc. of CDC 2003*.
- [18] D. Schmeidler, "The Nucleolus of a Characteristic Function Game", *SIAM Journal on Applied Mathematics*, Vol. 17, No. 6, 1969.
- [19] Z. Han, V. Poor, "Coalition Games with Cooperative Transmission: A Cure for the Curse of Boundary Nodes in Selfish Packet-Forwarding Wireless Networks", *IEEE Trans. Communications*, Vol. 57, No. 1, 2009.
- [20] G. Owen, *Game Theory*, 3rd ed. London, U.K.:Academic, Oct.1995.
- [21] T. Driessen "Cooperative Games, Solutions and Applications", *Kluwer Academic Publishers*, 1988.
- [22] R. Jain, W. Hawe, D. Chiu, "A Quantitative measure of fairness and discrimination for resource allocation in Shared Computer Systems", *DEC Research Report TR-301*, 1984.

**Sahar Hoteit** is a Ph.D. student at the LIP6, Pierre and Marie Curie University - Paris 6, Paris, France and currently a visiting researcher at Senseable City Lab MIT - Cambridge - USA. She received the Diploma in Electrical, Electronics, Computer and Telecommunications Engineering from Lebanese University, Beirut, Lebanon, in 2010; and the M.S. degree in network and computer science from the University of Pierre and Marie Curie - Paris 6 in 2011. Her current research interests are about resource management and human mobility estimation.

**Stefano Secci** is currently an Associate Professor at the LIP6, Pierre and Marie Curie University - Paris 6, Paris, France. He received the M.Sc. and Ph.D. degrees in communications engineering from Politecnico di Milano, Milan, Italy, and the Ph.D. degree in computer science and networks from Telecom ParisTech, Paris, France. He worked as network engineer with Fastweb, Milan, Italy, and as Post-Doctoral Fellow with Telecom ParisTech, NTNU, Norway, and George Mason University, USA. His current research interests are about future Internet routing resiliency, mobility, and policy.

**Rami Langar** is currently an Associate Professor at the LIP6, University Pierre and Marie Curie - Paris 6, Paris, France. He received the M.S. degree in network and computer science from the University of Pierre and Marie Curie - Paris 6 in 2002; and the Ph.D degree in network and computer science from Telecom ParisTech, Paris, France, in 2006. In 2007 and 2008, he was with the School of Computer Science, University of Waterloo, Waterloo, ON, Canada, as a Post-Doctoral Research Fellow. His research interests include mobility and resource management in wireless mesh, vehicular ad-hoc and femtocell networks, performance evaluation and quality-of-service support.

**Guy Pujolle** is currently a Professor at the University Pierre and Marie Curie - Paris 6, a member of the Scientific Advisory Board of Orange/France Telecom and a visiting professor at the IT Convergence and Engineering dept., POSTECH, Korea . He is the French representative at the Technical Committee on Networking at IFIP. He is an editor of International Journal of Network Management, WINET, Telecommunication Systems and editor-in-chief of Annals of Telecommunications.