



**HAL**  
open science

## Statistical analysis of corrosion impact for marine structures: overview of French structures in several harbours

Alexandre Clément, Jérôme Boéro, Franck Schoefs, Jean-Bernard Memet

### ► To cite this version:

Alexandre Clément, Jérôme Boéro, Franck Schoefs, Jean-Bernard Memet. Statistical analysis of corrosion impact for marine structures: overview of French structures in several harbours. 1st International Conference on Applications Heritage and Constructions in Coastal and Marine Environment, 2008, Lisboa, Portugal. hal-01008946

**HAL Id: hal-01008946**

**<https://hal.science/hal-01008946>**

Submitted on 9 Oct 2020

**HAL** is a multi-disciplinary open access archive for the deposit and dissemination of scientific research documents, whether they are published or not. The documents may come from teaching and research institutions in France or abroad, or from public or private research centers.

L'archive ouverte pluridisciplinaire **HAL**, est destinée au dépôt et à la diffusion de documents scientifiques de niveau recherche, publiés ou non, émanant des établissements d'enseignement et de recherche français ou étrangers, des laboratoires publics ou privés.



Distributed under a Creative Commons Attribution 4.0 International License

---

# Statistical analysis of corrosion impact for marine structures: overview of French structures in several harbours

Alexandre CLEMENT<sup>1</sup>, Jérôme. BOERO<sup>1 3</sup>, Franck SCHOEFS<sup>1</sup>, Jean-Bernard MEMET<sup>2</sup>

<sup>1</sup> Institute for Research in Civil and Mechanical Engineering (GeM), Nantes Atlantic University, UMR CNRS 6183, Faculté Sciences et Techniques, 2 rue de la Houssinière, F-44000 NANTES France, alexandre.clement@univ-nantes.fr

<sup>2</sup> A-CORROS, 16 rue de la Madeleine 13200 Arles, France, tel : (33) 630.808.227, jbmemet@yahoo.fr

<sup>3</sup> OXAND S.A, 62 bvd Niels Bohr, BP 2132, F-69603 Villeurbanne, FRANCE, Jerome.boreo@oxand.com

## Abstract

Steel structures in harbour are subjected to corrosion process. This phenomenon is very complex due to the nature of the environment (estuary, sea), the type of the structure and the use of the structure in the harbour (tidal area, basin at constant level). This phenomena needs to be characterized for mechanical calculations which take into account the loss of thickness. Ultrasonic residual measurements allow determining profiles of loss of thickness and identifying the areas which are the most affected by corrosion. Several inspection campaigns have been performed in some French harbours in the last decade which lead to a great number of measurements with respect of a protocol given by the CETMEF ("Centre d'Etudes Maritimes et Fluviales"). This paper proposed a statistical study of sixteen French wharves which have been inspected during the last decade. Depending on the environmental conditions for each structure, we show if they are affected by corrosion and where the loss of thickness is high.

*Keywords:* corrosion, steel, loss of thickness, on-pile wharf, sheet-piles, ultrasonic measurement

## 1. Introduction

Corrosion in sea or estuary area represents a great source of problems for the resistance of metallic structures during their service life. This phenomena needs to be characterized for mechanical calculations which take into account the loss of thickness. Ultrasonic residual measurements allow determining profiles of loss of thickness and identifying the areas which are the most affected by corrosion. Several inspection campaigns have been performed in some French harbours in the last decade which lead to a great number of measurements with respect of a protocol given by the CETMEF ("Centre d'Etudes Maritimes et Fluviales"): this particular protocol leads to perform, at a given levels, three geometrical measurements at a given point. The corresponding average value is then assumed to be the true value. Thus, these measurement as similar points give a statistical distribution of loss of matter on those structures according to the different areas (mainly tidal and immersion areas) and the orientation of the structure. This study is performed within the MEDACHS framework (Marine Environment Damage to Atlantic Coast Historical and transport works or Structures) and gathers inspection measurements from several harbours located on the French west and north-west coasts. The types of structures are on-pile wharves and on-sheet-pile-wall wharves made of steel.

After a presentation of the structures and the protocol for inspection, data are analysed. Section 3 is divided in two sub-sections. First, the profiles of corrosion with depth are analysed. Then an overview of the loss of matter with time is presented. The scatter of the values in both immersion and tidal/spray areas is presented.

## 2. Overview of the studied patrimony

### 2.1 Geographical location and environmental conditions

Structures concerned in this study are located on the French west and north-west coasts, i.e. the area gathers the Atlantic coast and the Channel coast. Two types of hydraulic environment exist for these structures: they can be located in estuarial area or in sea area. Moreover, they can be submitted to tide effects or not. This involves that two relevant areas appear: a tidal area, where wet/dry cycles have effect, and an immersion area, where the structure is always in water.

### 2.2 Typology and age of wharf

Structures are gathering in two types: on-pile wharves and on-sheet-pile-wall wharves. On-pile wharves may be made of tubes or sheet-piles. Both piles and sheet piles are made of steel and are often full of concrete or sand. Thus the steel part, submitted to corrosion effects, is not involved in the mechanical structure behaviour. Here, it can be seen as a way of protecting concrete from chloride ingress. Seventeen wharves are concerned in this study. Their characteristics are presented in table 1.

Tab 1. Characteristics of each inspected wharf.

Number	Area	Type	Tidal effect	Date of building	Date of inspection	Measures number in tidal /spray area	Measures number in immersion area
A1	Estuary	Piles (tubes)	Yes	1983	2005	318	500
A2	Estuary	Piles (tubes)	Yes	1984	2005	259	420
A3	Estuary	Piles (tubes)	Yes	1971	2004	280	331
A4	Estuary	Piles (tubes)	Yes	1976	2004	302	488
B1	Sea	Sheet-pile-wall	No	1946	2000	6	154
B2	Sea	Sheet-pile-wall	No	1956	2004	25	34
B3	Sea	Sheet-pile-wall	No	1972	2000	509	163
B4	Sea	Sheet-pile-wall	No	1984	1998	34	60
B5	Sea	Sheet-pile-wall	No	1973	1999	89	0
B6	Sea	Sheet-pile-wall	Yes	1957	2001	34	65
B7	Sea	Sheet-pile-wall	Yes	1963	2001	352	0
B8	Sea	Sheet-pile-wall	Yes	1977	2004	114	75
B9	Sea	Pile (tubes)	Yes	19??	2004	703	998
B10	Sea	Pile (tubes)	Yes	19??	2004	660	954
B11	Sea	Pile (tubes)	Yes	19??	2004	176	520
B12	Sea	Sheet piles	Yes	19??	2004	435	527

## 2.3 Protocol of inspection and type of data

Corrosion of steel structures is classically assessed by ultrasonic non destructive testing. In France, a protocol is given by the French Center for Maritime and Fluvial Technical Studies (CETMEF) and classically used by several companies to perform inspections of coastal steel structures. The CETMEF is part of the French ministry of building. It is devoted to the diffusion of knowledge, to provide technical and research studies as well as engineering and expert's reports. This protocol consists in performing residual thickness measurements for several heights of the structure using ultrasonic testing. The corrosion products are removed by grinding. By using this technique and considering the harsh conditions for marine inspections, the error on the measure at a given point on the structure cannot be neglected. For on-pile wharves these measurements are performed at several cardinal positions of the pile's section (see figure 1). For on-sheet-pile-wall wharves, they are performed around every 10 meters, which is classically the mean distance between two piles for on-pile wharves. Starting from these residual thickness values, and knowing the initial thickness of piles or sheet-piles, we deduce the loss of thickness mainly due to corrosion. Thus three inspections are performed on a given cardinal point: the three measurements are distributed on a circle, with diameter of about 5 cm, every  $120^\circ$  as shown on figure 1. For particular case of on-sheet-pile-wall structures, there is no cardinal point, which explains the lower number of measurements. However for these structures, owners usually inspect three sides of the sheet-pile: the left, the centre and the right sides.

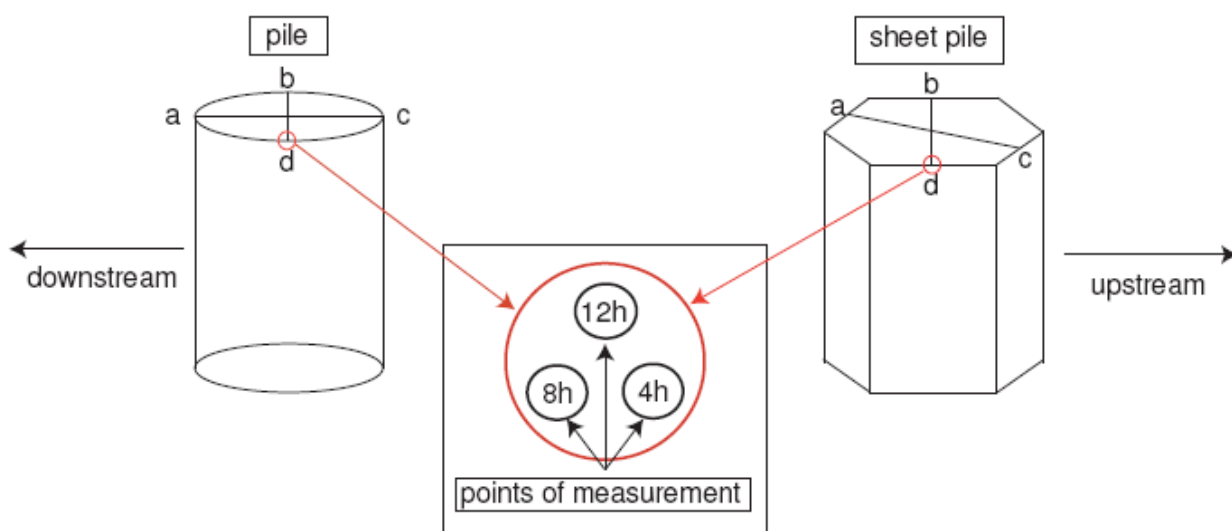

Fig 1. CETMEF protocol: cardinal points for pile (left) and sheet pile (right) with geometrical measurements (middle).

This protocol involves recommendations only and in some cases, this protocol is not followed because of the experience of owners or of the risk based inspection analysis. Table 1 indicates the total number of measurements for tidal/spray area and immersion area.

## 3. Presentation of the results

### 3.1 Mean of loss of thickness profiles

In this section, we present the significant results for some particular wharves which are relevant according to their characteristics. First, we are interested in wharves belonging to estuarial location *i.e.* wharves A1, A2, A3 and A4). Results are presented with loss of thickness profiles: the loss of thickness is, here, the mean of all data collected for all piles of a same file at a specific height  $z$ . In the case of structures located in an estuarial area, we note that there is no influence of the cardinal points, this involves that data are gathered by geometrical locations and by cardinal points too. Thus, at a specific height, the mean of loss of thickness is calculated with  $n_z$  values such that:

$$n_z = n_g \times n_c \times n_p \quad (1)$$

Where  $n_g$  is the number of geometrical measurements,  $n_c$  the number of cardinal points and  $n_p$  the number of piles for a particular file. With this protocol, we remind that  $n_g = 3$  and  $n_c = 4$  ( $n_p$  obviously depends of the wharf and the file).

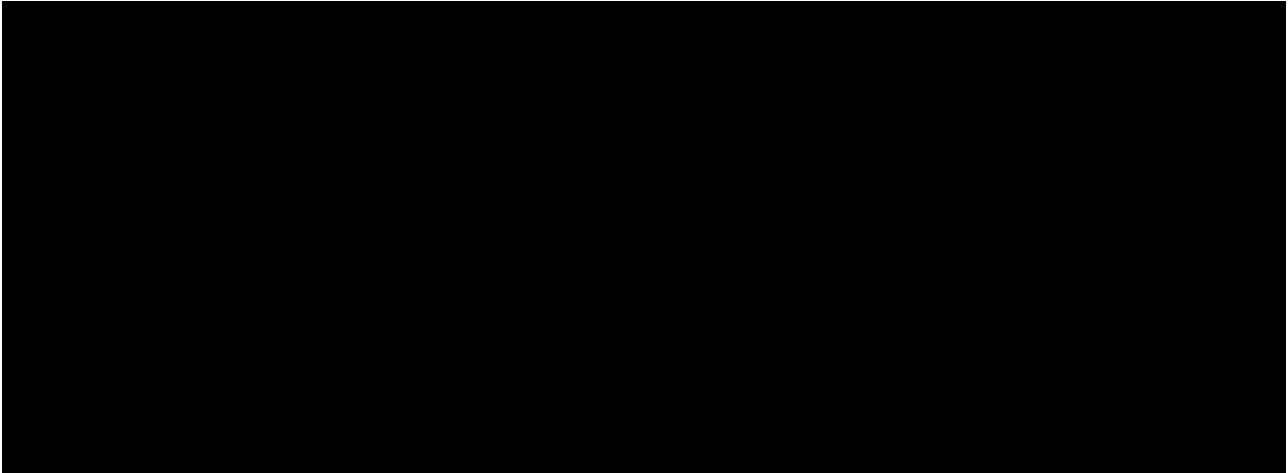

Fig 2. Mean of loss of thickness by file for wharves A1 (left) and A2 (right).

For these two structures, we note on figure 2 that the global corrosion is quite low. However some remarks are relevant:

- a corrosion peak appears for the two wharves around the interface between the tidal area and the immersion area (line blue on the graphics). This trend is now well known (Memet 2000);
- wharf A1 presents a high corrosion at the head of piles for files C and E. It is not the case for wharf A2;
- in the immersion area, the loss of thickness is higher for the file A which is the most exposed file.

In a general way, all wharves located in an estuary are only a few affected by corrosion.

We now focus on wharves located in front of sea and which are made of sheet-pile-walls: this structures are wharves B1 to B8. Figure 3 gives the corrosion profiles for some wharves without tidal effect: it deals with structures which are not affected by tide.

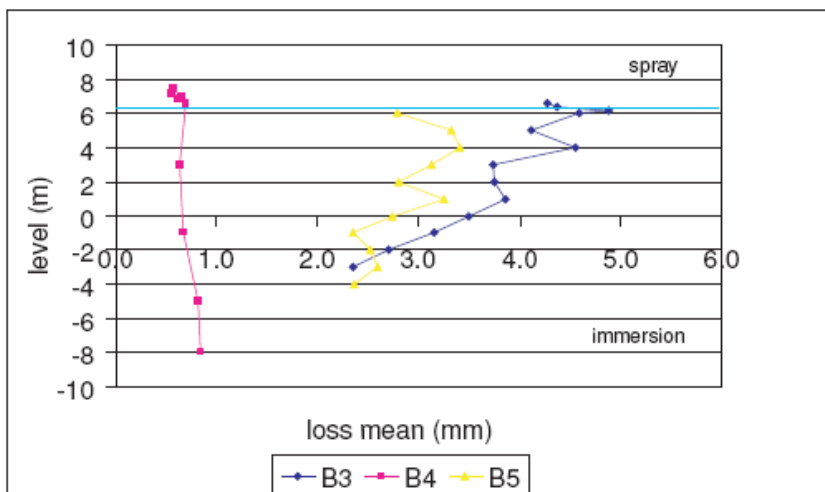

Fig 3. Mean of loss of thickness for wharves B3, B4 and B5: structures located in sea area with no tide effect.

Several points are relevant:

- structures B3 and B5 present a high loss of thickness as opposed to structure B4: this can be explain by the life time service of wharf B4 before its inspection. Actually it has been inspected after 14 years as wharves B3 and B5 have been inspected after respectively 28 and 26 years;
- for structures B3 and B5, loss of thickness increases when height  $z$  increases too;
- wharf B3 presents a corrosion peak at the interface between the spray area and the immersion area.

Concerning on-sheet-pile-wall wharves submitted to tide effect, figure 4 presents their corrosion profiles for structures B6 to B8. These profiles are presented on two graphics because for wharf B8 the interface between tidal and immersion areas (line blue) is not at the same level.

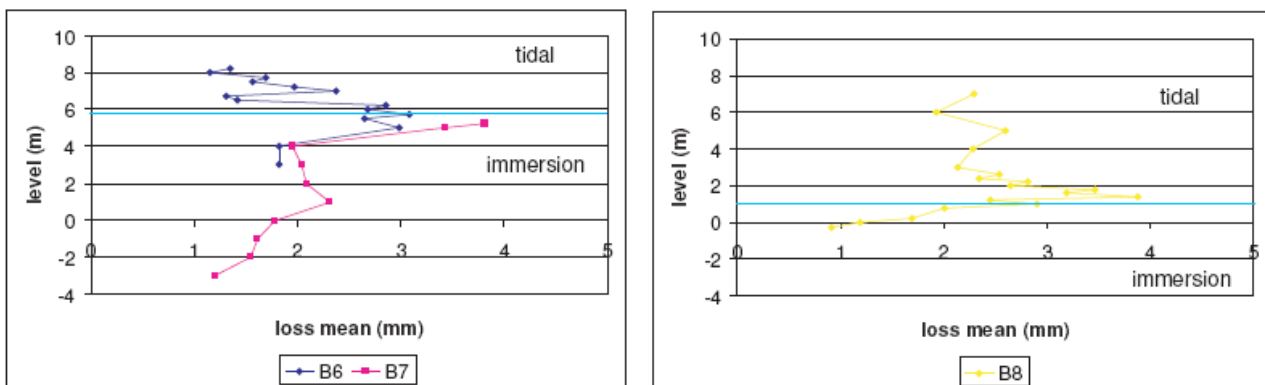

Fig 4. Mean of loss of thickness for wharves B6, B7 and B8: structures located in sea area with tide effect.

For these structures, we observe that:

- loss of thickness is lower than for wharves with no tide effect but higher than wharves located in estuarial area (see figure 2);
- for all wharves, a corrosion peak superior to 3 mm appears at the interface between tidal and immersion areas.

Finally, we focus on structures B9 to B12 which are on-pile and on-sheet-pile wharves located at sea. Wharf B12 is different from the others because it is made of on-sheet-piles. For this wharf, we want to highlight a possible cardinal point dependence. Figure 5 presents the loss of thickness profiles by cardinal points for a specific file of wharf B12. We observe that corrosion effects are more important for cardinal points *a* and *c*. This could be due to environmental conditions like waves or currents which lead to vortex shedding and higher oxygenation for these points. But, on figure 5, we see that points *a* and *c* belonging to the small sides of the sheet-pile. Inspectors, according to design plans, have considered that the initial thickness was the same for all sides of a sheet pile. However, after investigations, the authors found that this type of sheet-pile was usually composed of two different thicknesses: usually, thickness of sides gathering points *a* and *c* are thinner than the other sides. This assumption could also explain the difference between the cardinal points. Thus, it is difficult to deduce global conclusions for this particular wharf.

Figure 6 presents the global loss of thickness profiles for structure B10. We note that corrosion is low except at the interface. We don't observe that loss of thickness is really higher than for the same type of structure located in estuary (see figure 2). However, it is clear here that corrosion is higher for file A which is the most exposed file (closest to the sea). We have observed the same conclusions for wharves B9 and B11.

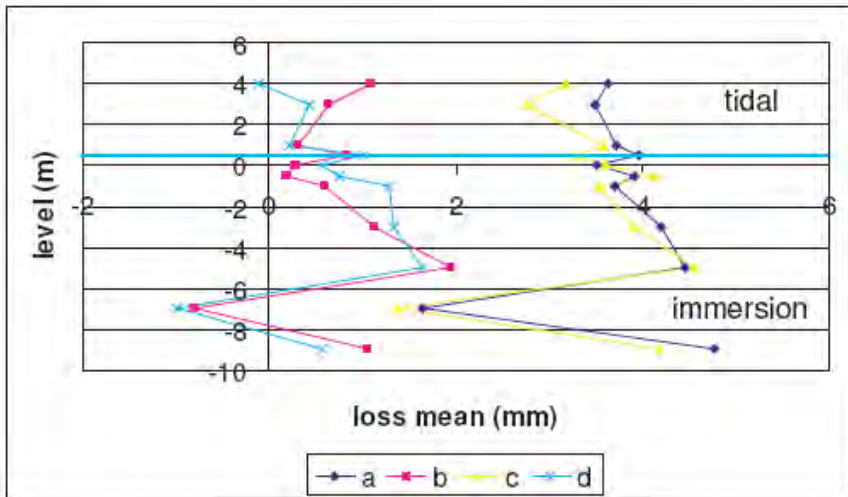

Fig 5. Mean of loss of thickness for wharves B12 by cardinal points: on sheet-pile wharf located in sea area with tide effect.

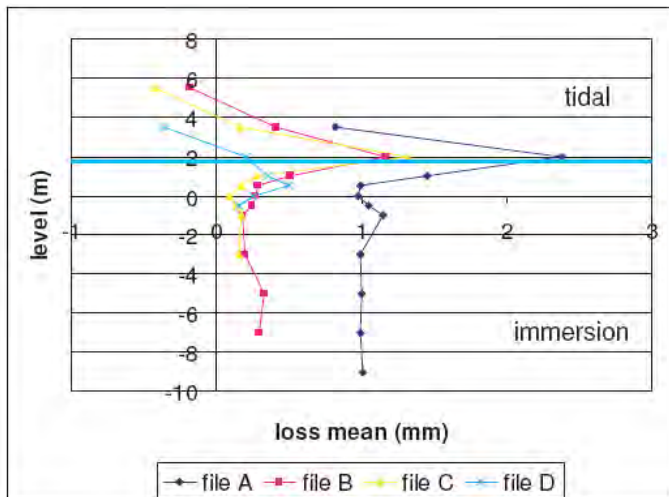

Fig 6. Mean of loss of thickness for wharves B10: structure located in sea area with tide effect.

### 3.2 Summary of corrosion with time and environment

In this section, we gather data in two areas: the tidal/spray area and the immersion area. Figure 6 presents a summary of results for all inspected structures for the two areas: for each wharf is given the age of the structure associated to the mean of loss of thickness with its maximum and minimum values.

Following remarks are important:

- Due to the hazard of corrosion process and electrochemical effects, the scatter is large. Minimum value are always near zero even for old structures (50 years);
- The scatter is increasing with time. It is very high in 'pure' marine environment and four times smaller in estuary conditions. In sea, extreme values reach often four times the average value. It confirms that a probabilistic approach should be improved;
- For similar structures, we observe an initiation time with a fair loss of matter (till 10 years), a high kinetics of corrosion during 10 years and finally an asymptotic behaviour with a stabilization of the loss of matter. It corresponds to the two first stages of the model suggested by (Melchers 2003).

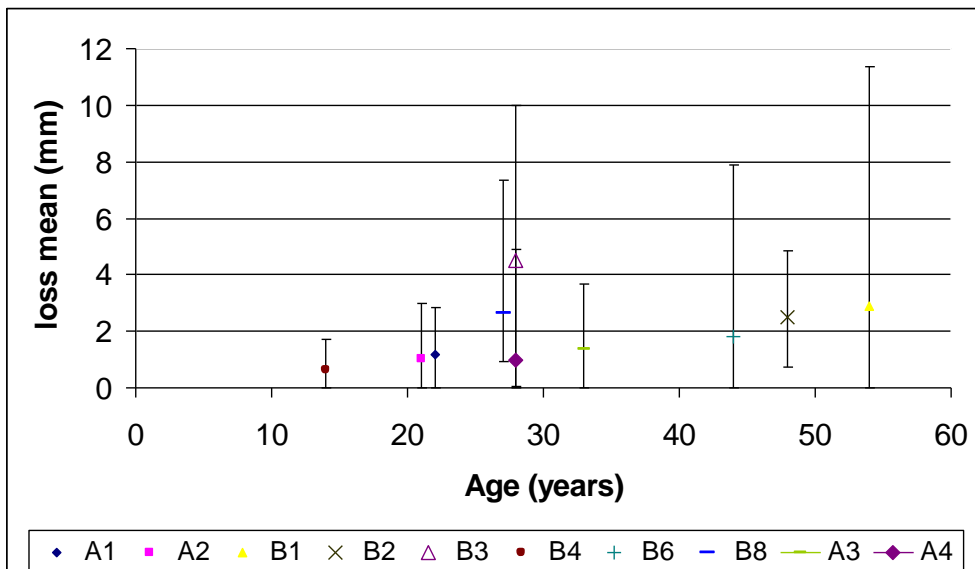

Fig 6. Mean of loss of thickness with maximum and minimum values versus age for all wharves for tidal area.

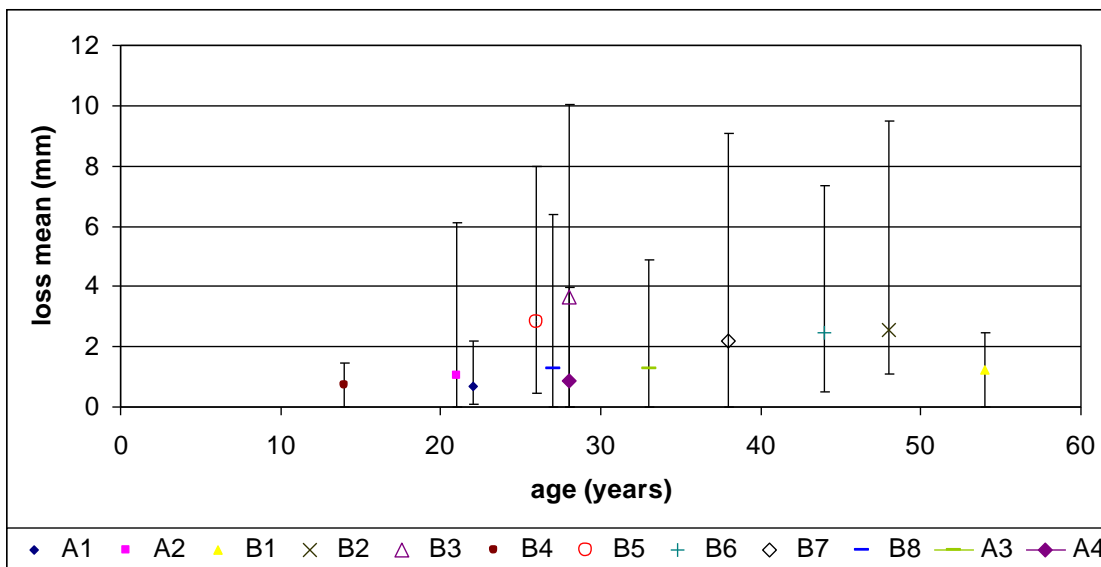

Fig 7. Mean of loss of thickness with maximum and minimum values versus age for all wharves for immersion area.

#### 4. Conclusion

This paper gather about 10 000 ultrasonic measurements. In a general way, the probabilistic analysis shows if the harbours are affected by the corrosion and where the loss of thickness is high for each structure. From the analysis of profiles of loss of matter, we confirm that the corrosion is mainly higher at the interface between the tidal area and immersion area (Memet 2000). We also notice that impact corrosion can be higher for particular cardinal points what shows the interest of this specific protocol. Finally, the overview of the evolution of the corrosion with time leads to conclude that in absence of bacterial or pollution induced corrosion, the estuary environment leads to less corrosion than marine conditions (four times less after 20 years). Moreover, the scatter is less too. Trends show a very classical shape for the evolution: (1) in the first years, the corrosion process is stopped by the physical protection (paint or calamine), (2) then the corrosion reaches in ten years a maximum value, (3) and in the last years the corrosion is stopped by the corrosion products.



---

## 5. Acknowledgements

This work is supported by the European Community and FEDER funds within the MEDACHS Interreg IIIB (Atlantic space, project N°197) (MEDACHS: Marine Environment Damage to Atlantic Coast Historical and transport works or Structures: Methods of diagnosis, repair and of maintenance) (web site: <http://www.medachs.u-bordeaux1.fr>). The authors would like to thank Harbour Authorities of Nantes St Nazaire, for their technical support and expert judgement.

## 6. References

Melchers R. E. A new model for marine immersion corrosion in structural reliability assessment, *Applications of Statistics and Probability in Civil Engineering*, 2003.

Memet J.B. La corrosion marine des structures métalliques portuaires : étude des mécanismes d'amorçage et de croissance des produits de corrosion, 2000, Thèse de doctorat, Université de La Rochelle, 164 p.

Schoefs F., Clément A., Memet J.B., and Nouy A., Spatial dependence of Receiver Operating Characteristic curves for Risk Based Inspection of corroded structures: application to on-pile wharf, *Proceeding of 10th International Conference on Applications of Statistics and Probability in Civil Engineering*, (I.C.A.S.P'07), July31-August 3 2007, Tokyo, Japan, paper on CD-Rom, ISBN 978-0-415-45134-5, 8 pages (Jun Kanda, Tsuyoshi Takada & Hitoshi Furuta, Editors, 2007).