



**HAL**  
open science

## Seismic retrofitting of RC frames with RC infilling

Christis Chrysostomou, Nicholas Kyriakides, Panagiotis Kotronis, Martin Poljansek, Fabio Taucer, Panayiotis Roussis, Antonis Kosmopoulos

► **To cite this version:**

Christis Chrysostomou, Nicholas Kyriakides, Panagiotis Kotronis, Martin Poljansek, Fabio Taucer, et al.. Seismic retrofitting of RC frames with RC infilling. 15th World Conference on Earthquake Engineering, Sep 2012, Lisbon, Portugal. hal-01008872

**HAL Id: hal-01008872**

**<https://hal.science/hal-01008872>**

Submitted on 7 Jan 2020

**HAL** is a multi-disciplinary open access archive for the deposit and dissemination of scientific research documents, whether they are published or not. The documents may come from teaching and research institutions in France or abroad, or from public or private research centers.

L'archive ouverte pluridisciplinaire **HAL**, est destinée au dépôt et à la diffusion de documents scientifiques de niveau recherche, publiés ou non, émanant des établissements d'enseignement et de recherche français ou étrangers, des laboratoires publics ou privés.



Distributed under a Creative Commons Attribution 4.0 International License

# Seismic Retrofitting of RC Frames with RC Infilling



**C.Z. Chrysostomou & N. Kyriakides**

*Cyprus University of Technology, Limassol, Cyprus*

**P. Kotronis**

*Ecole Centrale de Nantes, Nantes, France*

**M. Poljanšek & F. Taucer**

*ELSA, Joint Research Centre, European Commission, Ispra, Italy*

**P. Roussis**

*University of Cyprus, Nicosia, Cyprus*

**A. Kosmopoulos**

*DENCO Design & Engineering Consultants, Greece*

## SUMMARY:

The effectiveness of seismic retrofitting of multi-storey multi-bay RC-frame buildings, by converting selected bays into new walls through infilling with RC, was studied experimentally at the ELSA facility at JRC, Ispra, and the results are reported here. The full-scale model tested with the pseudo-dynamic method consisted of two parallel frames, linked through 0.15m slabs, having three bays each (8.5m long), with the central bay (2.5m) infilled with RC wall, and being four storeys tall (12m). The frames were designed and detailed for gravity loads only and are typical of similar frames built in Cyprus in the 1970's. Different connection details and reinforcement percentages for the two infilled frames were used in order to study the effects of these parameters. The results of the pseudo-dynamic and cyclic testing performed are presented and conclusions are drawn.

*Keywords: RC infill Walls, Retrofitting Existing Structures, Full Scale Psd Testing.*

## 1. INTRODUCTION

The construction of new walls is the most effective and economic method for retrofitting multi-storey reinforced concrete buildings, especially those with pilotis (soft-storey). Their structural and economic effectiveness increases when they result from infilling full bays of the existing RC frames. The experimental research performed to the present day covers sufficiently the other frequently used types of retrofitting – in particular the use of fibre reinforced polymers (FRP) and the concrete jackets – but not the RC infill walls. For them, experimental research did not target what is necessary, but what is feasible: due to the practical difficulties of testing large specimens with high force resistance, only one- or two-storey specimens have been tested. Regarding code provisions, Eurocode 8 – Part 3 covers fully and adequately retrofitting with FRP or concrete jackets, while it does not say anything about new walls created by infilling frame bays. Other guidelines, like KANEPE in Greece, refer to the design of these walls only in terms of forces, without providing tools for calculation of their characteristic deformations (at yield and failure) and stiffness, unless the infill wall can be considered integral with the bounding frame. The inadequacy of design codes in this respect is due to our poor knowledge of the behaviour of walls created by infilling with RC a bay of an existing frame.

To the present day, experimental research on reinforced concrete frames converted into walls by infilling with RC has been carried out almost exclusively in Japan and Turkey. The experiments in Japan (Hayashi et al. 1980, Higashibata et al. 1978, Kato et al. 1984, Shiohara et al. 1984, Tanaka et al. 1984, Masuo et al. 1998, Takeyama et al. 1998, Sugimoto et al. 1999) were performed on 27 in total 1:3 to 1:4 scale single-storey one-bay RC-infilled frames with RC infill thickness 25% to 50% that of the frame members, which were compared in most cases with monolithically cast specimens of

the same geometric characteristics (in which the frame and the infill wall were cast at the same time and integrally connected). The thickness of the RC infill varied from 26% to 60% (on the average 43%) of the width of the members of the frame. The connection of the RC infill to the bounding frame was done with epoxy-grouted dowels (17 specimens), or mechanically (shear keys, dowels without epoxy etc., 6 specimens). In four other cases the thickness of a pre-existing thin wall was increased by 100% to 150% without any direct connection of the new wall with the bounding frame. The failure mode of all the specimens was in shear (including sliding at the interface). It is interesting to note that for epoxy-grouted dowels the force resistance of the infilled frame was on average 87% of that of the integral one, while for mechanical connection it was 80% on average. For the increased thickness of an existing thin infill wall, the force resistance was on average 92% of that of the monolithic specimen, while the displacement at failure was on the average 13% smaller than in the integral specimen. For the epoxy grouted dowels the ultimate deformation was on average 55% larger than in the integral specimen and for the mechanical connection by 115% larger on the average. Therefore, although the deformable connection gives a somewhat reduced strength, it increases considerably the ultimate deformation of the retrofitted structure.

Of the specimens tested in Turkey, those of Teymur et al. (2008), Anil and Altin (2007) were single storey one-bay 1:2 and 1:3 scale, with RC infill thickness 25% or 33% that of the frame members. Those of Altin et al. (1992), Turk et al. (2003), Cambay et al. (2003), Sonuvar et al. (2004), Kara and Altin (2006) were two-storey one-bay scaled at 1:3, with infill wall thickness 1/3 and 40% of the width of the members of the bounding frame. The RC infill was in most cases fully connected on the perimeter with dowels, in some cases though (Teymur et al. 2008) there was a gap between the infill and the columns, while in some other cases there was no connection other than simple bearing. Altin et al. (1992) have also tried to weld the rebars of the infill to those of the members of the frame, instead of using dowels. Only Altin et al. (1992) included some monolithic specimens, however not exactly similar to the infilled ones. Finally, the specimen of Erdem et al. (2004 and 2006) was two-storey three-bay scaled at 1:3, with the middle bay infilled with a wall with thickness 63% of the width of the frame members. The connection was with epoxy grouted dowels and the failure mode predominantly flexural. In all other cases the single storey walls failed in shear, while the two storey ones failed by a combination of flexure and shear sliding at the base.

The low-aspect ratio test specimens used in the experiments described above are non-representative of the behaviour of a multi-storey and slender wall since their behaviour and failure mode is dominated by shear. By contrast, a multi-storey and slender wall to be used in real life is controlled by bending and can be easily dimensioned so that a plastic hinge forms at its base. In such a case shear will not have a detrimental effect on its behaviour and on its energy dissipation capacity. In addition, the higher modes of vibration of the structure are not taken into account although it has been shown numerically (Keinzel 1988, Eibl and Keinzel 1990) that they may increase considerably the shears at the upper floors of a wall after the formation of a plastic hinge at the base. This aspect has never been studied experimentally even in integral walls, because their height and number of storeys was not large enough to allow higher mode inelastic response. Another common element of past tests is the small thickness of the RC infill wall relative to the width of the frame members. As a result, the weak link of the structural system is either the infill wall in diagonal compression, or its connection with the surrounding frame.

In order to start filling the gap of knowledge regarding infilling of existing RC frames with RC walls, the effectiveness of seismic retrofitting of multi-storey multi-bay RC-frame buildings, by converting selected bays into new walls through infilling with RC, was studied experimentally at the ELSA facility at JRC, Ispra, and the results are reported here. This research is under the project "Seismic Engineering Research Infrastructures for European Synergies" (SERIES), financed by the Seventh Framework Programme of the European Commission. The consortium consisted of the Cyprus University of Technology (co-ordinator), the Ecole Central de Nantes, DENCO, the ELSA laboratory at JRC Ispra and the University of Cyprus. In the first part of the paper the design of the bare-frame specimen is presented and in the second the details of the design of the RC infills are given. Then, the results of the testing campaign are presented and conclusions are drawn.

## 2. DESCRIPTION OF THE SPECIMEN

The specimen consisted of three bays with the central bay infilled with RC wall and it had four storeys. The scale of the model was 1:1. The centre-line length dimension of the specimen was 8.5 m (central bay 2.5 m and the two exterior bays 3.0 m), the storey height 3.0 m and the total height of the specimen (excluding the foundation) about 12.0 m (Fig. 2.1a). Two parallel retrofitted frames (spaced at 6.0 m) were used, one at each side of the test structure, linked through RC slabs 0.15 m thick (Fig. 2.1b). The dimensions of the columns were 0.25 m by 0.40 m with the long dimension along the plane of loading, while those of the beams 0.25 m by 0.50 m (for both along the plane of the frame and perpendicular to it).

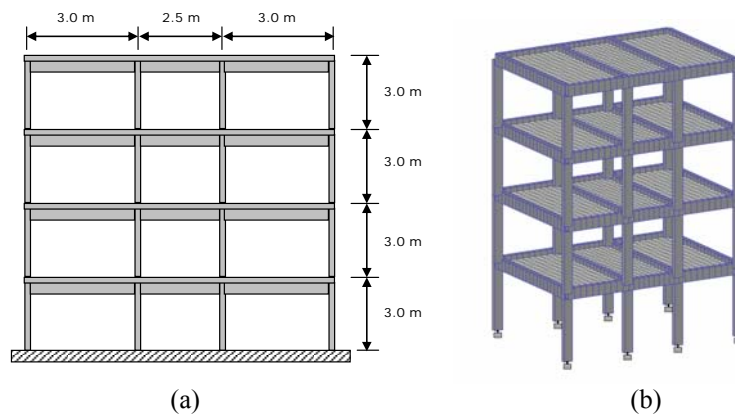

**Figure 2.1.** Dimensions and layout of the full-scale specimen without the RC infill

### 2.1. Design of the structure for gravity loads only

The proposed structure represents typical construction of the late 70's and beginning of the 80's in Cyprus. The structures at that time were designed for gravity loads only, since there were no provisions for earthquake loading. There was no specific design standard and the authorities were accepting any standard that was acceptable to other countries such as CP110 and BS8110, DIN, Greek Code, US code etc.

For the design of the mock-up it was decided to use the provisions of BS8110 which are very close to those of CP110 with very minor differences. In Cyprus the transition that was made was from CP114, which was an allowable stress design, to BS8110, without going through the CP110 phase. It was made sure that all the reinforcement details used for the design were according to CP110:1972 and BS8110:1983.

The material properties used in the mock-up were constrained by the availability of materials in the Italian and European market. It was finally decided to use concrete C20/25 for both the frame and the walls, of unit weight  $25 \text{ kN/m}^3$  and modulus of elasticity,  $E=30.000 \text{ MPa}$ . The yield strength of the ribbed bar reinforcing steel was  $f_{yk} = 400 \text{ MPa}$  for both bending and shear reinforcement of the frame members and the slab, while for the RC infill and the dowels to be used for connecting the wall to the bounding frame members the yield strength was specified to  $f_{yk} = 450 \text{ MPa}$ .

The frame was designed for gravity loads only, since this was the practice in the period of time that is being examined. The self-weight was calculated using the unit weight of concrete specified above. The imposed dead load was  $3 \text{ kN/m}^2$ , including the load of masonry infill walls, and the live load was  $1.5 \text{ kN/m}^2$ . The above loads were combined using partial factors of safety of 1.4 for self-weight and imposed dead-load, and 1.6 for live load. The material partial factors used were 1.5 for concrete and 1.15 for steel.

The reinforcement details for the beams are shown in Fig. 2.2a and the ones for the columns in Fig. 2.2b. For the beams of the frame 4 $\Phi$ 12 bars were used for top and bottom reinforcement, which was running the total length of the beams. The shear links were  $\Phi$ 8 at 200 mm intervals starting at 50mm from the face of the column. For the transverse beams 2 $\Phi$ 20 bars were used at the top and 5Y20 at the bottom of each of the four transverse beams. The links were  $\Phi$ 8 spaced at 100 mm so as to make sure that no failure will take place in the transverse beams which were used to transfer the forces from the actuators to the frames. The columns were reinforced with 4 $\Phi$ 20 bars and were lapped for a length of 0.55 m measured from the top face of the slab (Fig. 2.2b). This represents a compression lap, since the structure was designed for gravity loads only, and it is expected fail when subjected to tension. The shear links were  $\Phi$ 8 spaced at 200 mm starting at a distance of 50 mm from the top face of the slab.

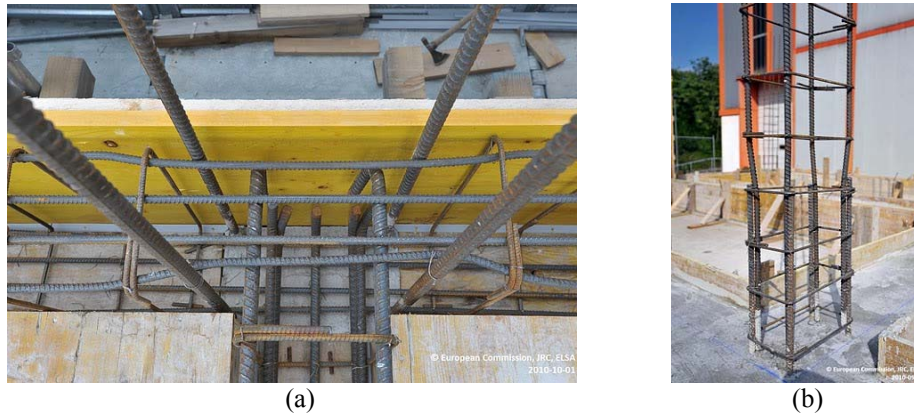

**Figure 2.2.** (a) Reinforcement details for beams, (b) Reinforcement details for columns

Similar to the transverse beams, the slab was considered as an element that will facilitate the transfer of forces from the actuators to the two parallel frames, therefore the reinforcement was increased considerably. For the slabs, nominal reinforcement of  $\Phi$ 10/200 was required, and  $\Phi$ 10/100 was specified in order to facilitate the transfer of forces.

## 2.2. Reinforcement details of the RC infill walls

The specimen, as it was explained above, consisted of two parallel frames connected through a slab and it had the central bay infilled. In order to facilitate the study of as many parameters as possible, the walls in the two frames were reinforced with different amounts of reinforcement, with the north one being the stronger of the two (Fig. 2.3.).



**Figure 2.3.** Elevation of the specimen in the lab. The wall shown on the right of the picture is the south wall and the one on the background is the north wall

Two parameters were examined: a) the amount of web reinforcement in the walls and b) the connection detail between the wall and the bounding frame. The web reinforcement in the two walls is shown in Table 2.1. Regarding the connection detail, two distinct connection details were used. In the first detail, the web bars are connected to the surrounding frame through lap-splicing with the same diameter starter bars epoxy grouted into the frame members. Short dowels are then used in order to transfer the shear at the interface between the wall and the frame member. This detail was used to connect the wall at the bottom beam and right column at the 1<sup>st</sup> and 2<sup>nd</sup> floors of the specimen (Fig. 2.4a).

In the second detail, longer dowels were used to double as dowels as well as for anchorage of the web panel to the surrounding frame; to this end, the dowels are considered as lap-spliced with the nearest – smaller diameter – web bars. However, in this case, the clear distance between the dowel and the nearest web bar, violates the maximum clear distance of 50 mm or 4Φ between lapped bars, specified in Eurocode 2. This detail was used to connect the wall at the top beam and left column at the 1<sup>st</sup> and 2<sup>nd</sup> floors of the specimen (Fig. 2.4a). In the 3<sup>rd</sup> floor of both the north and south frames only the second detail was used, while for the 4<sup>th</sup> floor only two dowels per wall interface were used to provide safety against falling of the wall out of plane. The reinforcement details for the dowels and the starter bars are shown in Table 2.1. The completed wall reinforcement (including web, starter bars and dowels) for the 1<sup>st</sup> floor of the south wall is shown in Fig. 2.4b.

**Table 2.1.** Reinforcement details for the RC infill walls

story	N Wall								S Wall							
	web bars	embedment of web starter bars, mm		Φ mm	Dowels				web bars	embedment of web starter bars, mm		Φ mm	dowels			
					embedment, mm								embedment, mm			
		in wall	in frame		bottom & east in:		top & west in:			in wall	In frame		bottom & east in:		top & west in:	
					wall	frame	wall	frame					wall	frame	wall	frame
1	Φ 12@200	600	230	Φ20	160	160	600	190	Φ 10@200	500	170	Φ20	160	160	500	160
2	Φ 10@200	500	170	Φ20	160	160	500	160	Φ 8@200	400	120	Φ18	145	145	400	145
3	Φ 8@200			Φ18	400	145	400	145	Φ 8@200			Φ16	400	130	400	130
4	Φ 8@200			Φ16	400	130	400	130	Φ 8@200			Φ16	400	130	400	130

Since the lapping of the column reinforcement could take only compression, then it was obvious that there would be lap splice failure, which could be detrimental to the whole experiment. Therefore, in order to safeguard against this type of failure and allow the experiment to be performed without any premature failure, it was decided to reinforce the edges of the wall at the 1<sup>st</sup> floor with three-sided CFRP for a height of 0.60m from the base of the column (Fig. 2.5).



**Figure 2.4.** (a) Dowels and starter bars, (b) Dowels, starter bars and web reinforcement

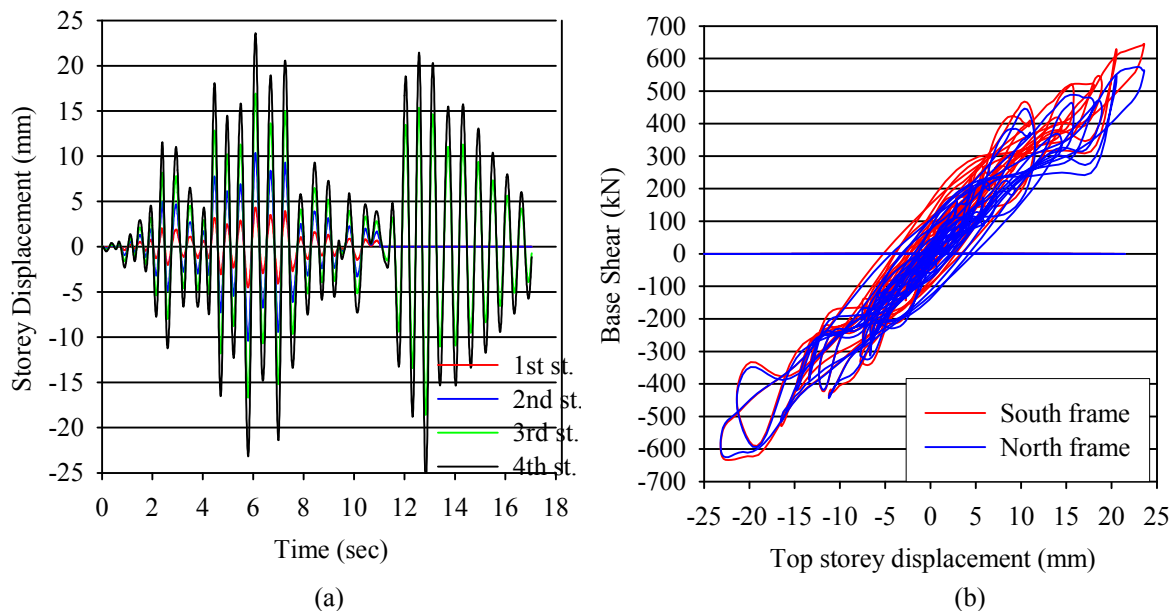

**Figure 2.5.** Reinforcing of the column with CFRP to safeguard against column lap-splice failure

### 3. TESTING CAMPAIGN

The testing campaign consisted of two pseudo-dynamic tests and a “funeral” cyclic test. Two 1000 kN actuators were used in the two top floors of the specimen and two 500 kN ones at the lower two floors. The gravity load on the structure was the one corresponding to the dead and reduced live loads, as specified in section 2.1, and it was equal to 192 kN per floor. This was achieved through 15 plastic barrels per floor that were filled with water and were distributed on the slabs of the test specimen (Fig. 2.3.).

The prototype structure consisted of four frames spaced at 6 meters, and the test specimen represented the two end frames of that structure. Therefore, in the pseudo-dynamic test, the total mass of the prototype was used in the equation of motion, which was equal to 156 tons per floor. In this way, the two tested frames were subjected to the true dynamic forces that the prototype would have taken. The Heregnovi-D1-Transverse component was used as input, which was 15 seconds long and it was digitized at 0.005 seconds. For the first pseudo-dynamic test the accelerogram was scaled to an acceleration of 0.10g and for the second test to an acceleration of 0.25g.



**Figure 3.1.** Experiment at 0.10 g acceleration (a) Variation of the storey displacements with time, (b) Base shear versus top storey displacement for the north and south frames

For the low level acceleration, the structure behaved very well. There were no visible cracks either on the columns or the walls. Some hairline cracks that appeared on the surface of the wall closed down when the experiment was finished. The maximum top storey displacement was 24 mm and the

displacement in the opposite direction was 26 mm (Fig. 3.1.a). These displacements were the same for both the north and south frames, since the forces in the south frame were imposed in such a way so as to keep the displacements of the two frames equal, and hence avoid any torsional effects on the specimen. It should be noted that the variation of the displacements at the first and second stories are shown only up to about 11 seconds, since a problem was encountered with the data acquisition system. The variation of the base shear with the top displacement in each of the frames is shown in Fig. 3.1.b. As it can be observed from the figure, there is very little difference between the two frames. The maximum positive shears were 645 kN and 574 kN for the south and north frames, respectively, and the maximum negative shears were -634 kN and -625 kN for the respective frames. It was considered that both walls have reached their cracking moment, and this was the purpose of this experiment.

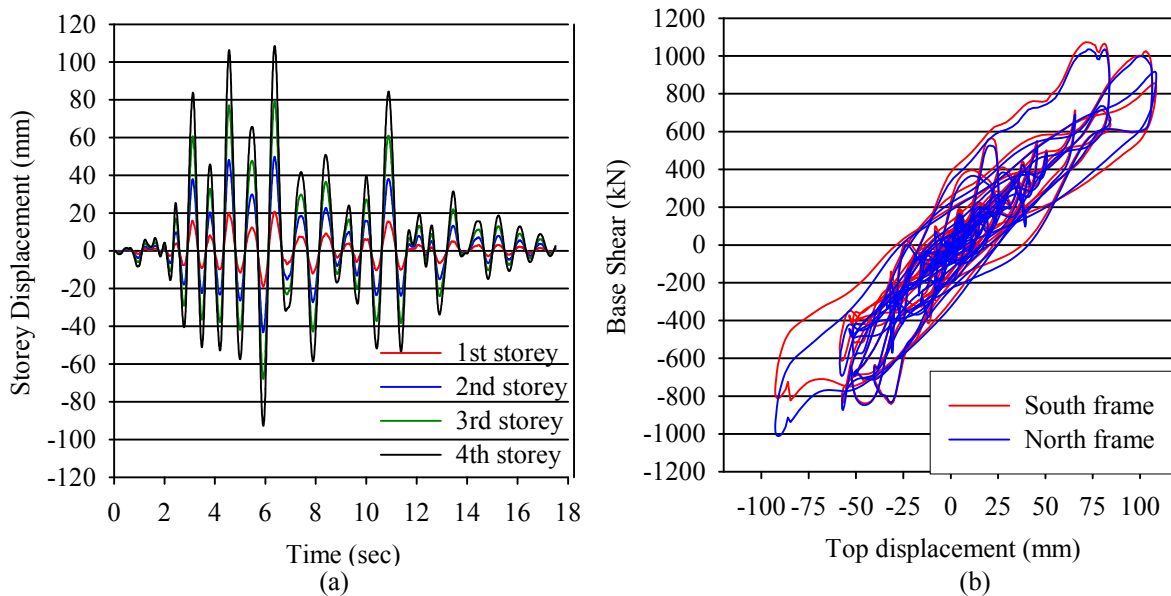
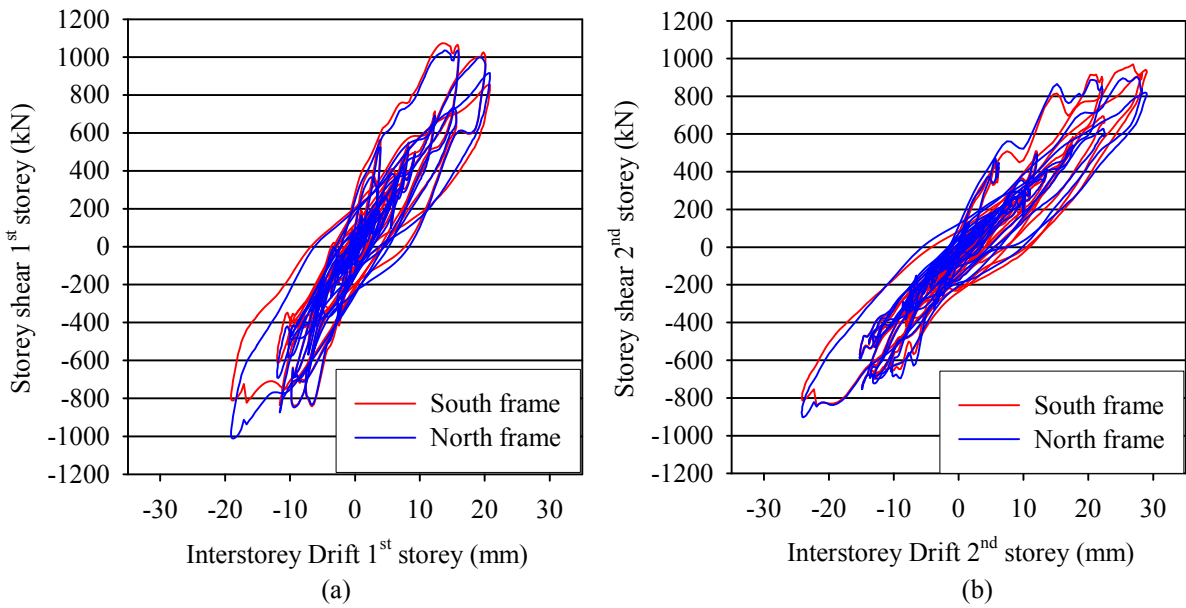

**Figure 3.2.** Experiment at 0.25 g acceleration (a) Variation of the storey displacements with time, (b) Base shear versus top storey displacement for the north and south frames

The 0.25g test was performed the day after the first test, and it was designed to bring the specimen at its ultimate capacity. The maximum top storey displacement was 109 mm and the displacement in the opposite direction was -93 mm (Fig. 3.2.a). Some difference was observed in the base shear between the two frames. As it can be observed from Fig. 3.2.b, the maximum base shear in the positive direction was 1074 kN for the south frame and 1036 kN for the north, which are about the same, while a negative base shear of -843 kN was recorded for the south frame and -1011 kN for the north one. This was an indication that the south frame has suffered some damage and it could not take further load. The only visual indication of this was a crack that opened in the ground beam at the base of the wall and the lap-splice failure of the outer column on the east side of the south frame. It should be noted that the presence of the CFRP on the bounding columns of the wall, have prevented a similar failure and it allowed the completion of the experiment.

In examining Figs. 3.3. and 3.4. it can be observed that there is a steady decrease of the storey shear from about 1000 kN at the 1<sup>st</sup> storey to about 400 kN at the top storey. What it can be also observed is that while the interstorey drift at the 1<sup>st</sup> storey is about 20 mm, the ones for the upper three floors are about 30 mm, which shows the influence of the RC infill on the dual system that was created by connecting it to the bounding frame. It can be also observed that there are stable hysteresis loops which allow the absorption of energy.





**Figure 3.3.** Experiment at 0.25 g acceleration (a) 1<sup>st</sup> storey interstorey drift, (b) 2<sup>nd</sup> storey interstorey drift

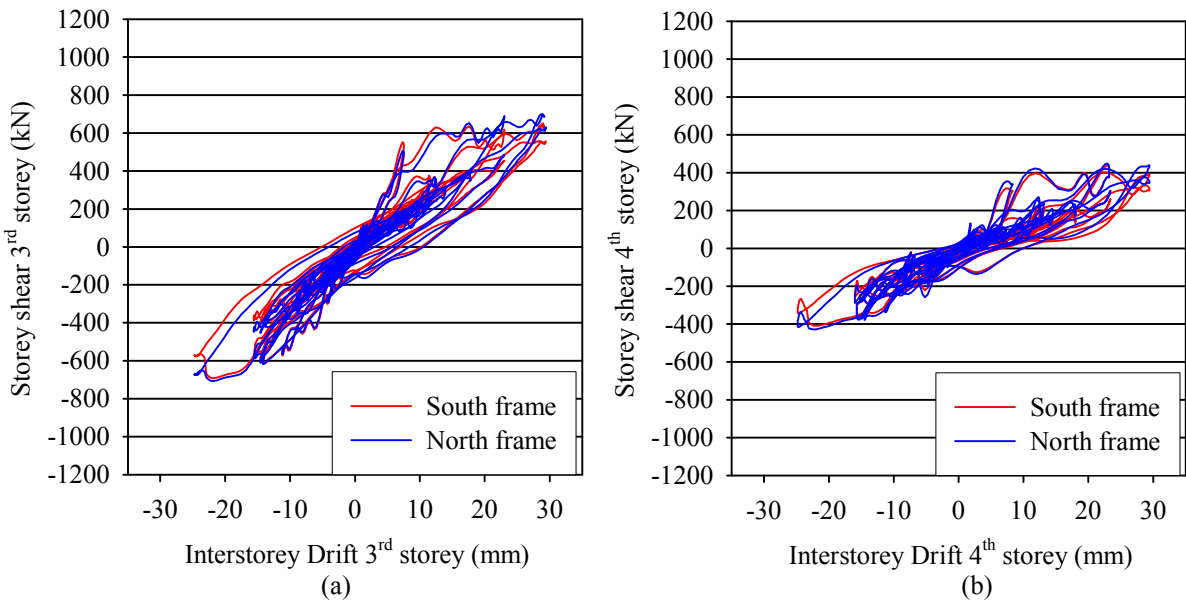
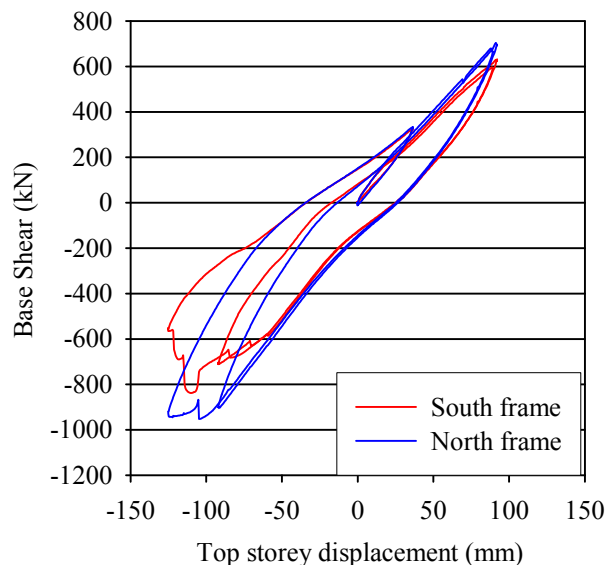

**Figure 3.4.** Experiment at 0.25 g acceleration (a) 3<sup>rd</sup> storey interstorey drift, (b) 4<sup>th</sup> storey interstorey drift

Regarding general behaviour of the specimen it can be said that it withstood the loading imposed on it very well. There were no visible diagonal cracks on the walls, which behaved flexurally. In nearly all the columns a horizontal crack appeared at a height of 0.55 m where the lap-splice stopped, and in some cases there was spalling of the concrete cover. Some vertical cracks appeared at the connection between the beams and the columns, but there was no severe damage, despite the fact there were no ductile connections in the structure. In general, the stronger north frame had an overall better behaviour compared to the south one, but the differences were minor.

Finally, in the “funeral” cyclic test a displacement history was imposed at the top storey (92, -92, 89, -125, 37, 0 mm) and a triangular distribution of forces was imposed. The objective of the test was to obtain a 15% reduction of the peak strength of the infill, so as to establish the strength envelope of the specimen. The base shear versus the top storey displacement is shown in Figure 3.5. As it can be observed in the first cycle the structure could reach 92 mm in both directions. In the second cycle the attempt was to reach 125 mm, but in the positive direction only 89 mm was possible to be reached,

while in the negative direction 125 mm was reached. This though had as a result a sudden drop of the strength of the south frame from 838 kN at -110 mm to 553 kN at a displacement of -125 mm. This amounts to a drop in strength of 34%. After that, the displacement was reduced to 37 mm in the positive direction and from there to zero.



**Figure 3.5.** Base shear versus top storey displacement for the south and north wall for the cyclic test.

#### 4. CONCLUSION

The effectiveness of seismic retrofitting of multi-storey multi-bay RC-frame buildings, by converting selected bays into new walls through infilling with RC, was studied experimentally at the ELSA facility at JRC, Ispra, on a full scale specimen. The main parameters of the mock-up were the connection between the RC infill and the surrounding RC frame and the percentage of the reinforcement in the RC infill. The effect of these parameters was studied during the experiment, by using different connection details and reinforcement percentages for the two infilled frames. Some preliminary findings regarding the behaviour of the structure are: a) the structure managed to sustain an earthquake of 0.25g without significant damage, b) some column lap-splices failed with concrete spalling, but the structure continued to carry load, c) the 3-sided CFRPs protected the wall bounding columns at the 1st floor and prevented lap-splice failure, d) The “weak” south frame behaved equally well as the “strong” north frame, e) there has not been visible movement at the interface between the wall and the bounding frame, f) the behaviour of the wall was mainly flexural, although on the south-frame wall some diagonal cracks appeared, g) higher mode effects appeared in the response of the structure h) some vertical cracks appeared at the connection of the beams to both the exterior column and the wall columns, and i) a horizontal crack appeared at the ground-beam of the walls, and it was the main reason for loss of strength of the south frame.

It was demonstrated that this is a viable method for retrofitting and it can be used to strengthen existing, ductility and strength deficient structures. The local behaviour of the structure is now under study and numerical models are being developed, so as to be able to propose design guidelines for such a retrofitting method.

#### ACKNOWLEDGEMENT

The research leading to these results has received funding from the European Community’s 7th Framework Program [FP7/2007-2012] for access to the EUROPEAN LABORATORY FOR STRUCTURAL ASSESSMENT of the EUROPEAN COMMISSION – JOINT RESEARCH CENTRE under grant agreement no.

227887. The authors would also like to acknowledge Prof. Michael Fardis for his invaluable suggestions for the setting-up of the mock-up and testing campaign, as well as Artur Pinto, Georges Magonette, Francisco Javier Molina and all the personnel of the ELSA laboratory for their contribution in building and testing the structure.

## REFERENCES

- Altin, S., Ersoy, U. and Tankut, T. (1992). Hysteretic Response of Reinforced-Concrete Infilled Frames. *Journal of Structural Engineering*. **118**: 8, 2133-2150.
- Anil, O. and Altin, S. (2007). An experimental study on reinforced concrete partially infilled frames. *Engineering Structures Journal*. **29**, 449-460. Doi:10.1016/j.engstruct.2006.05.011
- Aoyama, H., Hosokawa, Y., Shiohara, H. and Yamamoto, T. (1985). Study on the Method of Seismic Rehabilitation of Existing Reinforced Concrete Buildings. *Summary of Technical Papers of Annual Meeting*, Architectural Institute of Japan, **10**, Japan
- Canbay, E., Ersoy, U. and Ozcebe, G. (2003). Contribution of Reinforced Concrete Infills to Seismic Behavior of Structural Systems. *ACI Structural Journal*. **100**:5, 637-643.
- Eibl J. and Keintzel E. (1988). Seismic shear forces in cantilever shear walls. *9th World Conference in Earthquake Engineering*.
- Erdem, I., Akyuz, U., Ersoy, U. and Ozcebe, G. (2004), Experimental and analytical studies on the strengthening of RC frames, *13<sup>th</sup> World Conference on Earthquake Engineering*. **paper 673**.
- Erdem, I., Akyuz, U., Ersoy, U. and Ozcebe, G. (2006). An experimental study of two different strengthening techniques for RC frames. *Engineering Structures Journal*. **28**, 1843-1851. Doi:10.1016/j.engstruct.2006.03.010.
- Hayashi, T., Niwa, H. and Fukuhara, M. (1980). The Strengthening Methods of the Existing Reinforced Concrete Buildings. *7<sup>th</sup> World Conference on Earthquake Engineering*. **Vol IV**: 89-96
- Higashibata, Y. et al. (1978). Studies on Seismic Rehabilitation of Low-to Medium-Rise Reinforcement Concrete Buildings, Part 1 and Part 2. *Summary of Technical Papers of Annual Meeting*. Architectural Institute of Japan, **9**, Japan
- Kara, M.E. and Altin, S. (2006). Behavior of reinforced concrete frames with reinforced concrete partial infills. *ACI Structural Journal*, 701-709.
- Kato, D., Katsumata, H. and Aoyama, H. (1984). Study on Evaluation of the Strength of Post-cast Shear Walls Without Opening. *Journal of Structural and Construction Engineering*. Architectural Institute of Japan. **337**:3, 81-89.
- Keintzel E (1990). Seismic design shear forces in reinforced concrete cantilever shear wall structures. *European J. of Earthquake Engineering*. **3**:1, 7-16
- Masuo, K., Inoue, T., Otani, T. and Uemetsu, T. (1998). Test on Strengthening of RC Frames with CFRP Jacketing and Infill Wall. GBRC Report. **90**:4, 38-51.
- Shiohara, H., Hosokawa, Y., Nakamura, T. and Aoyama, H. (1984). Tests on the Construction Method of Seismic Rehabilitation of Existing Reinforced Concrete Buildings. *Proceedings of the Japan Concrete Institute*. **6**, 405-408.
- Sonuvar, M., Ozcebe, G. and Ersoy, U. (2004). Rehabilitation of reinforced concrete frames with reinforced concrete infills. *ACI Structural Journal*. **101**:4, 494-500.
- Sugimoto, T., Masuo, K., Komiya, T., and Ueda, M. (1999). Experimental Study on RC Infill Walls Which Used Adhesive Anchor with Specification for Practice. *Summary of Technical Papers of Annual Meeting*, Architectural Institute of Japan. **9**, 219-222.
- Takeyama, H., Satoh, A., Minai, M. and Sometani, T. (1998). Construction and Performance Test of Precast Concrete Infills Walls. *Prestressed Concrete*. **40**:4, 219-222.
- Tanaka, R. et al. (1984). Experimental Study on the Seismic Rehabilitation Which Used Pull-Out Preventive Mechanical Anchors. *Proceedings of JCI*. **6**.
- Teymur, P., Yuksel, E. and Pala, S. (2008). Wet-mixed shotcrete walls to retrofit low ductile RC frames, *14<sup>th</sup> World Conference on Earthquake Engineering*. **0146**.
- Turk, M. Ersoy, U. and Ozcebe, G. (2003). Retrofitting of Reinforced Concrete Frames with Reinforced Concrete Infills Walls. *Proceedings of the fib Symposium on Concrete Structures in Seismic Regions*, Athens, Greece, **CD**