



HAL
open science

Enhanced 3D multifibre beam element accounting for shear and torsion

G. Casaux, Frédéric Ragueneau, Panagiotis Kotronis, J. Mazars

► **To cite this version:**

G. Casaux, Frédéric Ragueneau, Panagiotis Kotronis, J. Mazars. Enhanced 3D multifibre beam element accounting for shear and torsion. Fifth International Conference on Fracture Mechanics of Concrete Structures, Ia-FraMCos, 2004, Vail Colorado, United States. hal-01008135

HAL Id: hal-01008135

<https://hal.science/hal-01008135>

Submitted on 13 Nov 2019

HAL is a multi-disciplinary open access archive for the deposit and dissemination of scientific research documents, whether they are published or not. The documents may come from teaching and research institutions in France or abroad, or from public or private research centers.

L'archive ouverte pluridisciplinaire **HAL**, est destinée au dépôt et à la diffusion de documents scientifiques de niveau recherche, publiés ou non, émanant des établissements d'enseignement et de recherche français ou étrangers, des laboratoires publics ou privés.

Enhanced 3D multifibre beam element accounting for shear and torsion

G. Casaux & Fr. Ragueneau

*Laboratoire de Mécanique et de Technologie, ENS Cachan/CNRS/Université Paris 6
61 Avenue du Président Wilson, 94235 Cachan cedex, France*

P. Kotronis & J. Mazars

*Laboratoire Sols, Solides, Structures UJF/INPG/CNRS and RNVO
Domaine Universitaire, BP 53, 38041 Grenoble cedex 9, France*

ABSTRACT: The purpose of this work is to investigate solutions for an enhanced multifibre beam element accounting for non-linear shear and torsion. Higher order interpolations functions are used to avoid any shear locking phenomena and the cross section warping kinematics are extended to non-linear behavior using advanced constitutive laws. The efficiency of the proposed modeling strategies is tested with experimental results of reinforced concrete structural elements subjected to severe loading.

Keywords: shear, torsion, warping, multifibre beam

1 INTRODUCTION

Instead of the traditional tools used to analyze the seismic behavior of reinforced concrete (R/C) structures (such as capacity design or nonlinear push-over analysis) an alternative choice is to perform non-linear time history calculations assuming an accurate description of materials and applying transient loadings on the structure (natural or artificial ground motions). Modeling the evolution of eigen modes concomitant to stiffness degradation that is governed by a local yield criterion is currently the most refined method of analysis for predicting the ultimate behavior of concrete structures. However, due to excessive computational costs this approach is not commonly used in Earthquake Engineering. Nonlinear dynamic analysis of complex civil engineering structures based on a detailed finite element model requires large-scale computations and handles delicate solution techniques. The necessity to perform parametric studies due to the stochastic characteristic of the input accelerations imposes simplified numerical modeling that reduces the computational cost. In this work, the latter is achieved by adopting a multifiber beam model for representing the global behavior of the structural components of a complex civil engineering structure. The constitutive laws remain however sufficiently general to take into account all the different inelastic phenomena (cracking by

damage, permanent deformation by plasticity and crack-closing by unilateral contact condition).

The classical approach when using a multifiber beam element description is to consider shear and torsion uncoupled and linear. The purpose of this article is to study solutions for a multifiber beam element capable of reproducing non-linear shear - according to the Timoshenko theory - or shear due to torsion. For the first case the possibility of using higher order interpolation functions to avoid any shear locking phenomena is investigated. In order to account for non-linear torsion the cross section warping kinematics is studied in the framework of elasticity and extended to non-linear behavior using advanced constitutive laws. The effects of warping on the damage kinematics and crack pattern of the cross section are studied and their influences on the global behavior of structural members are analyzed.

The efficiency of the proposed modeling strategies is validated with experimental results of two R/C structural elements submitted to severe loading. A cantilever-type column specimen tested at JRC Ispra and a plain concrete beam subject to pure torsion. Comparisons between experiments and computations at the global as well as the local level give an insight into the approach.

2 ENHANCED MULTIFIBRE BEAM ACCOUNTING FOR SHEAR

2.1 Interpolation functions

In order to simulate in a simplified manner the non-linear behavior of a R/C structure under dynamic loading a 3D multifibre Timoshenko beam element is developed (Kotronis 2000, Kotronis et al. 2001). The element is displacement-based (see also Spacone et al. 1996 for a forced based formulation) and can be implemented into any general purpose finite element code without major modifications. The user can define at each fiber a material and the appropriate 3D constitutive law. The element uses higher order interpolation functions to avoid any shear locking phenomena (Friedman & Kosmatka 1993) that take the following form (presented hereafter for simplicity for a 2D element):

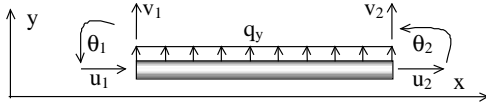

Figure 1. Timoshenko beam element.

$$\begin{cases} u_s(x) \\ v_s(x) \\ \theta_s(x) \end{cases} = \begin{bmatrix} h_1 & 0 & 0 & h_2 & 0 & 0 \\ 0 & h_3 & h_4 & 0 & h_5 & h_6 \\ 0 & h_7 & h_8 & 0 & h_9 & h_{10} \end{bmatrix} \begin{cases} u_1 \\ v_1 \\ \theta_1 \\ u_2 \\ v_2 \\ \theta_2 \end{cases} \quad (1)$$

$$\begin{cases} h_1 = 1 - \frac{x}{L} \\ h_2 = \frac{x}{L} \\ h_3 = \frac{1}{1+\phi} \left\{ 2\left(\frac{x}{L}\right)^3 - 3\left(\frac{x}{L}\right)^2 - \phi\left(\frac{x}{L}\right) + 1 + \phi \right\} \\ h_4 = \frac{L}{1+\phi} \left\{ \left(\frac{x}{L}\right)^3 - (2+\frac{\phi}{2})\left(\frac{x}{L}\right)^2 + (1+\frac{\phi}{2})\left(\frac{x}{L}\right) \right\} \\ h_5 = -\frac{1}{1+\phi} \left\{ 2\left(\frac{x}{L}\right)^3 - 3\left(\frac{x}{L}\right)^2 - \phi\left(\frac{x}{L}\right) \right\} \\ h_6 = \frac{L}{1+\phi} \left\{ \left(\frac{x}{L}\right)^3 - (1-\frac{\phi}{2})\left(\frac{x}{L}\right)^2 - \frac{\phi}{2}\left(\frac{x}{L}\right) \right\} \\ h_7 = \frac{6}{(1+\phi)L} \left\{ \left(\frac{x}{L}\right)^2 - \left(\frac{x}{L}\right) \right\} \\ h_8 = \frac{1}{1+\phi} \left\{ 3\left(\frac{x}{L}\right)^2 - (4+\phi)\left(\frac{x}{L}\right) + (1+\phi) \right\} \\ h_9 = -\frac{6}{(1+\phi)L} \left\{ \left(\frac{x}{L}\right)^2 - \left(\frac{x}{L}\right) \right\} \\ h_{10} = \frac{1}{1+\phi} \left\{ 3\left(\frac{x}{L}\right)^2 - (2-\phi)\left(\frac{x}{L}\right) \right\} \end{cases} \quad (2)$$

$$\phi = \frac{12}{L^2} \left(\frac{EI}{kGA} \right) = \frac{24}{L^2} \left(\frac{I}{kA} \right) (1+\nu) \quad (3)$$

where L length of the beam, A section of the beam, ν Poisson's coefficient, k shear correction factor, G shear modulus, E Young's modulus, I area moment of inertia of the cross section. The variable ϕ (3) is the ratio of the beam bending stiffness to the shear stiffness. For slender structures ϕ equals zero and the resulting stiffness and mass matrices are reduced to matrices for the Bernoulli-Euler beam theory.

The section constitutive matrix for the 3D formulation of the element and for a non homogeneous section takes the form (Guedes et al. 1994):

$$K_s = \begin{bmatrix} K_{s11} & 0 & 0 & 0 & K_{s15} & K_{s16} \\ & K_{s22} & 0 & K_{s24} & 0 & 0 \\ & & K_{s33} & K_{s34} & 0 & 0 \\ & & & K_{s44} & 0 & 0 \\ & & & & K_{s55} & K_{s56} \\ \text{sym} & & & & & K_{s66} \end{bmatrix} \quad (4)$$

$$K_{s11} = \int_S E dS ; \quad K_{s15} = \int_S E z dS ;$$

$$K_{s16} = -\int_S E y dS ; \quad K_{s22} = k_y \int_S G dS$$

$$K_{s24} = -k_y \int_S G z dS ; \quad K_{s33} = k_z \int_S G dS ;$$

$$K_{s34} = k_z \int_S G y dS ; \quad K_{s44} = \int_S G (k_z y^2 + k_y z^2) dS$$

$$K_{s55} = \int_S E z^2 dS ; \quad K_{s56} = -\int_S E y z dS ; \quad K_{s66} = \int_S E y^2 dS$$

(E and G are functions of y et z).

2.2 Modeling a cantilever-type column specimen

The 3D multifiber Timoshenko element is used in this example to simulate the inelastic behavior of a column under a general three dimensional load history, tested in the Joint Research Center in Italy (Bousias et al. 1995). The specimen has a 0.25m-square cross section, a free length of 1.5m and is considered fixed at the base. Longitudinal reinforcement consisted of eight 16mm diameter bars, uniformly distributed around the perimeter of the section. The concrete cover of the stirrups is 15 mm thick (Fig. 2). Reinforcement bars showed yield stress and ultimate strength of 460 MPa and 710 MPa respectively, the latter at a uniform elongation of 11%. A constant axial force of 0.21 MN is applied at the top of the column that is bi-axially displaced according to the displacement

history presented in Figure 3 (four levels 0.4m, 0.6m, 0.8m and 1.0m).

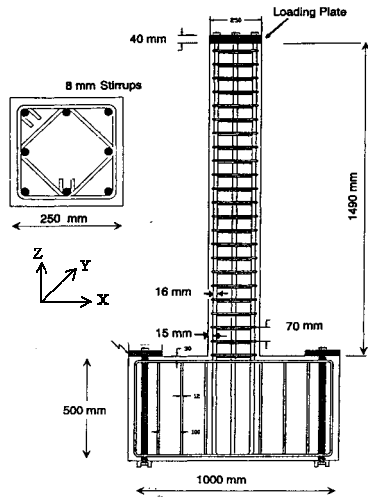

Figure 2. Description of the column specimen.

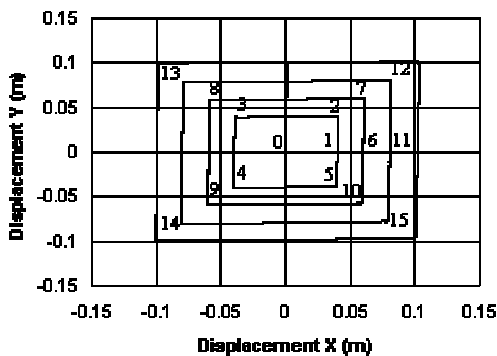

Figure 3. Displacement load history.

10 multifiber Timoshenko beam elements having 2 Gauss points are used to model the column. Each section has 36 fibers for concrete and 8 fibers for steel. Base slab is not simulated and the specimen is considered fixed at the base. 1D constitutive laws are used for concrete and steel based on damage mechanics and plasticity respectively (La Borderie 1991). Confinement effects are not considered. Specific values used for the materials follow:

Table 1. Specific values used for the materials.

Young's modulus (concrete)	20000 MPa
Poisson coefficient (concrete)	0.2
Compression strength (concrete)	29 MPa
Traction strength (concrete)	2.6 MPa
Young's modulus (steel)	200000 MPa
Poisson coefficient (steel)	0.3
Yield strength (steel)	460 MPa
Ultimate strength (steel)	710 MPa
Ultimate deformation (steel)	11%

Comparison of the numerical and experimental results for the eight levels of loading is represented hereafter. The model simulates correctly the global behavior of the mock-up in terms of displacements and forces in both directions. Calculation is not time consuming and allows for parametrical studies. Results can be improved by introducing non linear shear behavior via 2D and 3D robust constitutive models for concrete.

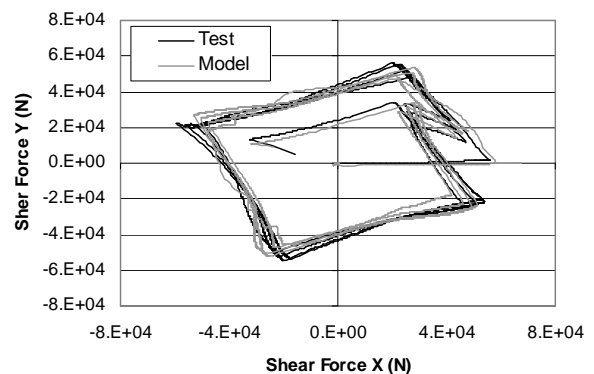
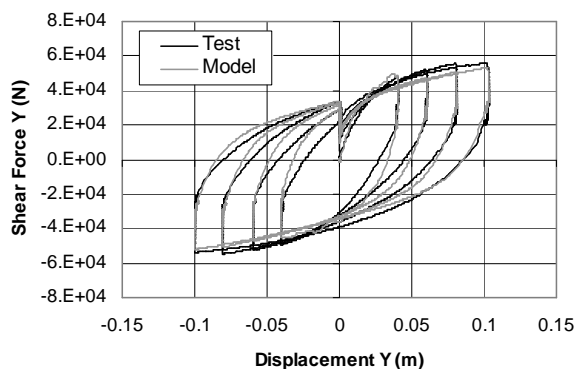
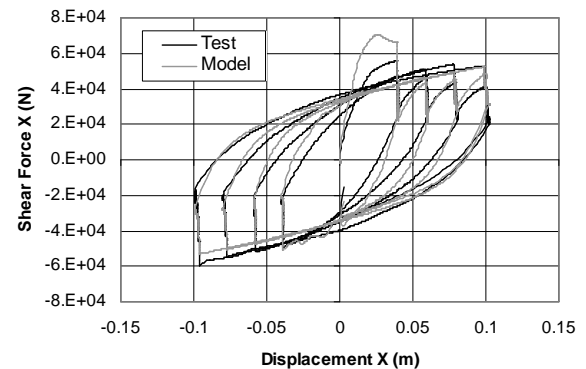

Figure 4. Comparison test - model.

3 ENHANCED MULTIFIBRE BEAM ACCOUNTING FOR TORSION

Using the multifiber approach, the global behavior of a structure is well apprehended. However, when the effects of torsion in the section are not taken into account the crack pattern is not always in good agreement with experimental data corresponding to high seismic loading levels and complex loading paths.

There are various ways of modeling torsion in multifiber beam elements :

- linear: generally used (that is the case in paragraph 2.2).
- globally nonlinear: with a nonlinear relation connecting torque moment and rotation.
- locally non linear: by using a 3D local behavior on each fiber. This approach is difficult because very few concrete constitutive relations are efficient and robust enough under cyclic or dynamic loading. Moreover, two possibilities appear: with or without section warping.

Is it judicial however in the framework of a simplified approach to consider complex kinematics of the section and 3D local constitutive relationships ?

3.1 Torsion for a multifiber section

The aim of the study is to obtain the strain field due to pure torsion for each fiber by solving the warping problem for a section composed of several materials (the case of reinforced concrete). Initially the problem is solved within a linear elastic framework as in Schulz & Filippou 1998. The framework of this elastic formulation study is the free torsion of Saint-Venant. Let us consider a beam section made up of a homogeneous and elastic material. (O,X,Y,Z) is the Cartesian frame reference:

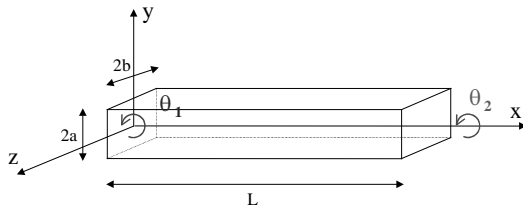

Figure 5. Beam model in torsion

Using the assumption of small displacements, the solution of the problem is :

$$\begin{aligned} u(x,y,z) &= \alpha \cdot \varphi(y,z) \\ v(x,y,z) &= -\alpha \cdot x \cdot z \\ w(x,y,z) &= \alpha \cdot x \cdot y \end{aligned} \quad (5)$$

with $\varphi(y,z)$ called warping function of the section and $\alpha = (\theta_2 - \theta_1)/L$.

Using linear-elasticity relationships for the material and respecting local equilibrium the classical solution follows as,

$$\Delta\varphi = 0 \quad (6)$$

In order to solve this plane problem for a section composed of several materials, a warping-conduction analogy method is used. The problem of the calculation of the warping function for a section made up of several elastic materials (shear modulus G_i) is transformed into a problem of 2D conduction in a plate made up of several materials (thermal conductivity λ_i). Indeed, the solution of Laplacian equations is trivial in heat transfer. Thus, if the boundary conditions are known, the problem can be solved with a finite element code (for example using the thermal calculation module of CASTEM 2000).

For the mechanical problem of torsion warping, $\varphi(y,z)$ (the warping function - homogeneous with a displacement squared) and G_i (shear modulus of elastic material i) notations are used.

For the thermal conduction problem, $T(y,z)$ (the temperature function), λ_i (the thermal conductivity of isotropic material i) and $\Phi(y,z) = \lambda \text{ grad } T(y,z)$ (the thermal density flux) notations are used.

For torsion, one obtains : $\Delta\varphi(y,z) = 0$ in each material surface, which corresponds to the equation of heat, for conduction in steady state: $\Delta T(y,z) = 0$

The characteristics of materials are : G_i , shear modulus of elastic material, equivalent with λ_i , thermal conductivity of isotropic material.

In order to find the boundary conditions on external contour, for torsion, one writes that there are no external forces applied to the contour of the section (external surface of the beam) (with n , the unit vector leaving normal to contour dS , of component n_y and n_z):

For torsion, continuity between two materials is expressed by insuring- continuity of the function $\varphi(y,z)$ and continuity of the forces on the border between two materials.

The conduction problem equivalent to the torsion warping function problem is as follows:

$$\Delta T(y,z) = 0$$

For the flow imposed on the free face:

$$\Phi_i \cdot n = \begin{bmatrix} \lambda_i z \\ -\lambda_i y \end{bmatrix} \begin{bmatrix} n_y \\ n_z \end{bmatrix}$$

and "jump" of flow imposed between two materials:

$$\left(\Phi_i - \Phi_j \right) \underline{n}_i = \begin{bmatrix} (\lambda_i - \lambda_j)z \\ (-\lambda_i + \lambda_j)y \end{bmatrix} \begin{bmatrix} n_y^i \\ n_z^i \end{bmatrix}$$

Thus, by applying these boundary conditions, the problem can be solved with any finite element code able to solve thermal conduction problems (the following computations are made using the finite element code CASTEM 2000).

This warping function calculation method was used to determine the torsion shear strains all over a beam section. A non linear extension was made by using a 3D local behavior model (Mazars 1986), keeping the elastic warping function, in order to calculate the fibers stresses. Then the torque moment is obtained by integrating the stresses at the elastic torsion center :

$$Mt = \int_S (y\sigma_{xz} - z\sigma_{xy}) dS \quad (7)$$

The multifiber framework is a natural integration domain allowing an easy numerical implementation of this approach into any general purpose finite element code.

3.2 3D constitutive equations

This part focuses on the expression of constitutive relations for concrete within the framework of continuous damage mechanics. A robust model for 3D loading path is used, allowing to account for the asymmetric 3D behavior of concrete in tension and compression.

Concerning the concrete 3D experimental behavior, one can notice that, a network of microscopic cracks nucleate parallel to the axis of loading which coalesce until the complete rupture. Due to the presence of heterogeneities in materials (aggregate surrounded by a cement matrix), tensile transverse strains generate a self-equilibrated stress field orthogonal to the loading direction, a pure mode I (extension) is thus considered to describe the behavior in compression. The influence of microcracking due to the external loads is introduced via a single scalar damage variable d ranging from 0 for the undamaged material to 1 for a completely damaged material. In order to introduce the non-symmetric behavior of concrete, the failure criterion is expressed in terms of principal extensions. An equivalent strain is defined as (Mazars 1986):

$$\varepsilon_{eq} = \sqrt{\sum_{i=1}^3 \langle \varepsilon_i \rangle_+^2} \quad (8)$$

where $\langle \cdot \rangle_+$ is the Macauley bracket and ε_i are the principal strains. The yield criterion of damage follows accounting for isotropic hardening $K(d)$:

$$f(\varepsilon, d) = \varepsilon_{eq} - K(d) \quad (9)$$

Two evolution laws for damage are considered for tension and compression (index i refers either to compression or traction):

$$d_i = 1 - \frac{\varepsilon_{d0}(1 - A_i)}{\varepsilon_{eq}} - A_i \exp(-B_i(\varepsilon_{eq} - \varepsilon_{d0})) \quad (10)$$

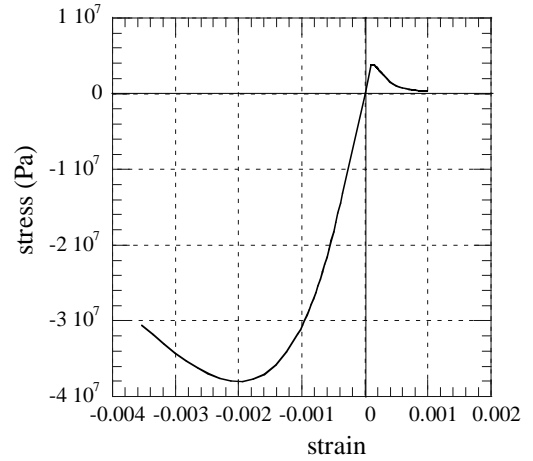

Figure 6. Tension/compression response. Non-symmetric behavior.

A_i and B_i are material parameters. The resulting damage which has to be introduced in the constitutive equation is a combination of these two scalar damages depending on the stress state of the representative elementary volume:

$$d = \alpha_t d_t + \alpha_c d_c \quad (11)$$

Response under compression and tension are presented in Figure 6.

3.3 Example

The experimental studies used here are from (Karayannis & Chalioris 2000). A series of plain concrete beams was tested in pure torsion. The beams were composed of three parts : two reinforced end parts (properly reinforced, so as to remain elastic) and one plain concrete middle part. The middle plain concrete part is the part where the

cracking and the failure have localized during the tests. The pure torsion loading was applied at the ends of the beam (Fig. 7).

For this study, four tests among twelve realized were used: two rectangular section specimens (called R(a) and Rh(c)) and two T-section specimens (Ts and T) (Fig. 8).

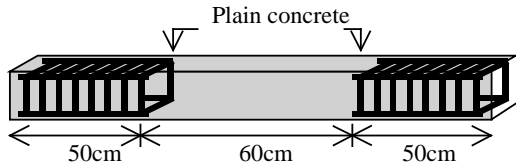

Figure 7. Plain concrete beam under pure torsion.

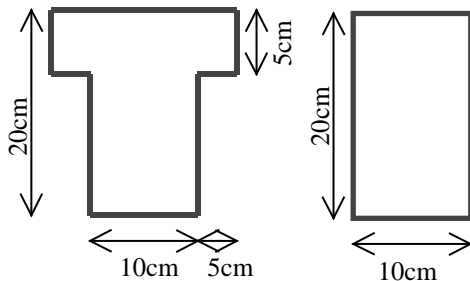

Figure 8. Rectangular and T-cross sections.

Regarding the assumptions of fixed rotating crack models, the crack pattern initiated by torsion is assumed to remain constant during crack propagation after initiation. The strain field along the cross section due to torsion and warping may initiate the nonlinear behavior but the global shape will not be affected by the occurrence of local damage. That's why the warping function is computed on the basis of a linear elastic material and is kept constant during the nonlinear range.

Warping functions calculations were carried out for the four specimens. Moreover, nonlinear calculations in pure torsion on concrete sections are here presented. The stresses are then computed with the local scalar damage constitutive relation. The parameters have been fixed from the experimental compression and tension tests results of the R(a) specimen but the Young modulus was unknown. Then, the Young modulus has been taken equal to 25000 MPa and ν , the Poisson ratio, equal to 0.2. One can thus have the evolution of the torque moment by integrating the stresses upon the section.

The warping functions are drawn (R(a) et Ts) in Figure 9.

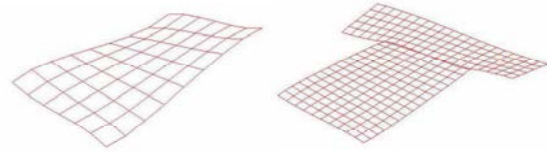

Figure 9. Warping function obtained for the rectangular and T-cross sections.

In order to highlight the importance of the warping function for the initial stiffness but also in the nonlinear range, two types of analysis have been carried out : either by taking into account the warping function, or by neglecting it (i.e. by giving it a zero value all over the sections).

For R(a) test and for Ts test, the curves giving the evolution of the torque moments according to the rotation angle can be plotted (Figs.10 and 11).

Those results show the importance of modeling the warping function in order to fit with experimental results. The “no warping model” has an initial elastic stiffness really higher than the “warping model” one. Also the maximum torque moment is quite badly evaluated. This can be explained by the fact that the warping function modify a lot the strain distribution in the section before crack initiation, and thus the damage in the section, as shown in Figure 12. However, even if the estimation of the cross section shear strain field using warping is very important to describe correctly the maximum bearing capacity of a reinforced concrete member under torsional loading, the basic assumption made in computing this warping function (fixed crack model) seems to be adequate.

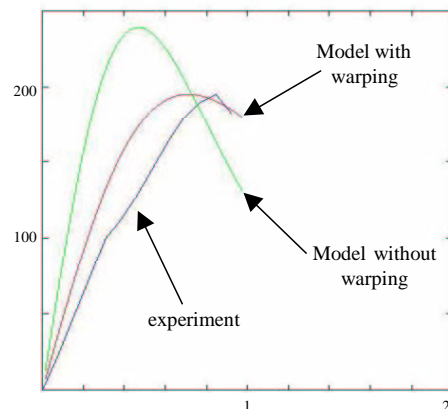

Figure 10. R(a) test: Torque moment (kN.cm) vs rotation (10^{-4} rad/cm) comparisons.

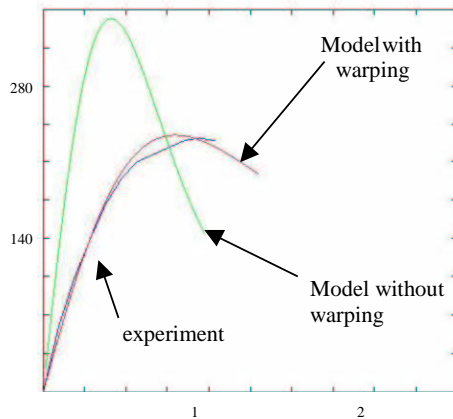

Figure 11. Ts test: Torque moment (kN.cm) vs rotation (10^{-4} rad/cm) comparisons.

By analyzing the damage pattern (Fig. 12), damage for the no warping model is like the one of circular sections (in which there is effectively no warping) and is very different from the one for the warping model. This can have a big influence on the bending behavior of a beam submitted to both torsion and bending.

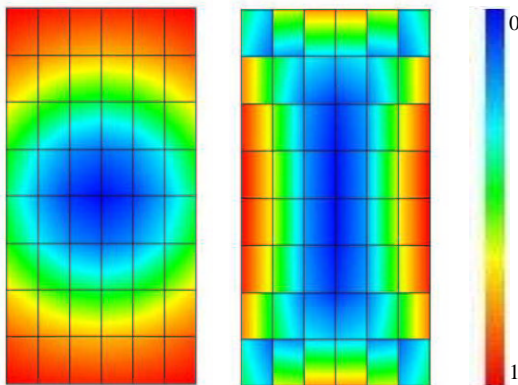

Figure 12. Ts test: Damage field on the rectangular cross section, without and with warping .

3.4 Conclusions

When using 3D local models within the framework of beam theory, modeling warping is crucial in order to be able to reproduce the torque/rotation evolution of a concrete beam. For sections which are very different from circular ones warping cannot be neglected. Moreover, damage profiles are completely different taking into account or not warping and consequently the behavior is modified: torsion and bending stiffness, maximum

torque... In this analysis, the warping function was kept constant, determined on elastic assumptions even during crack propagation. However, the warping model gives good results, for rectangular sections as well as for T- sections in accordance with the experimental results.

4 CONCLUSIONS

Simplified models are very useful for analyzing the behavior of concrete structures submitted to severe loading. They allow to perform parametric studies and give good information of the global and local behavior. Predictive analysis is made possible thanks to the use of local constitutive relationships based on thermodynamics.

In order to couple the use of multifiber beam elements with advanced 3D constitutive laws a Timoshenko kinematics has to be provided. The use of higher order interpolation functions is a way to tackle with shear locking phenomena and so to calculate accurately the influence of shear.

However, the generalized stresses (torque and bending moment) result from the integration of local Cauchy stresses. Calculation of those stresses needs not only a 3D constitutive relationship but also a precise kinematics over the section. Indeed, severe loading may generate complex coupling between torsional and flexural behavior. Taking into account cross section warping leads to particular crack patterns, inducing several interactions with the flexural behavior, different from the ones without warping. That's why improving multifiber beam elements by adding a better behavior under torsion loading can be very important for predicting the behavior of concrete structures submitted to seismic loading.

5 ACKNOWLEDGEMENTS

The authors would like to thank Pr. Boussias S. from the University of Patras and Pr. Karayannis C.G. from the Democritus University of Thrace (Greece) for providing the experimental results.

6 REFERENCES

Bousias S. N., Verzeletti G. & Fardis M.N., Guitierrez E. 1995. Load-Path effects in column biaxial bending and axial force. *Journal of Eng. Mechanics*, ASCE, 121(5), 596-605.

- CASTEM 2000, Code de calcul éléments finis
 CASTEM 2000, Commissariat à l'Energie
 Atomique, France.
- Guedes J., Pégon P & Pinto A. 1994. "A fibre
 Timoshenko beam element in CASTEM 2000",
Special publication Nr. I.94.31, JRC, I-21020
 Ispra, Italy.
- Friedman Z. & Kosmatka J.B. 1993. An improved
 two-node Timoshenko beam finite element.
Computers and structures, Vol. 47, no 3, pp.
 473-481.
- Karayannis C.G. & Chalioris C.E.. 2000.
 Experimental validation of smeared analysis for
 plain concrete in torsion, *Journal of Structural*
Engineering, pp. 646-653.
- Kotronis P. 2000. Cisaillement dynamique de murs
 en béton armé. Modèles simplifiés 2D et 3D .
 Thèse de doctorat ENS Cachan.
- Kotronis P., Davenne L., Mazars J. 2001. A 2D-3D
 simplified modelling strategy to simulate the
 non linear behaviour of U-shaped walls . *Fourth*
International Conference on Fracture
Mechanics of Concrete Structures, ed.
 Balkema, pp 963-968.
- La Borderie C.L. 1991. "Phénomènes unilatéraux
 dans un matériau endommageable: modélisation
 et application à l'analyse des structures en
 béton". Thèse de doctorat, Université Paris 6.
- Mazars J. 1986. A description of micro- and
 macroscale damage of concrete structures",
Journal of Engineering Fracture Mechanics,
 Vol. 25, No. 5/6, 729-737.
- Schulz M. & Filippou F.C. 1998. Generalized
 warping torsion formulation. *J. Engng. Mech.*
 Pp. 339-347
- Spacone E., Filippou F.C. & Taucer, F.F. 1996.
 Fiber Beam-Column Model for Nonlinear
 Analysis of R/C Frames. I : Formulation.
Earthquake Engineering and Structural
Dynamics, Vol. 25, N. 7., pp. 711-725.