



HAL
open science

A 3D beam element analysis for R/C structural walls

J. Mazars, L. Davenne, Panagiotis Kotronis, Frédéric Ragueneau, G. Casaux

► **To cite this version:**

J. Mazars, L. Davenne, Panagiotis Kotronis, Frédéric Ragueneau, G. Casaux. A 3D beam element analysis for R/C structural walls. 12th European Conference on Earthquake Engineering, Sep 2002, London, United Kingdom. hal-01007721

HAL Id: hal-01007721

<https://hal.science/hal-01007721>

Submitted on 7 Jan 2020

HAL is a multi-disciplinary open access archive for the deposit and dissemination of scientific research documents, whether they are published or not. The documents may come from teaching and research institutions in France or abroad, or from public or private research centers.

L'archive ouverte pluridisciplinaire **HAL**, est destinée au dépôt et à la diffusion de documents scientifiques de niveau recherche, publiés ou non, émanant des établissements d'enseignement et de recherche français ou étrangers, des laboratoires publics ou privés.

A 3D FIBER BEAM ELEMENT ANALYSIS FOR R/C STRUCTURAL WALLS

J. Mazars¹, L. Davenne², P. Kotronis², F. Ragueneau², G. Casaux²

¹ RNVO –Laboratoire Sols, Solides, Structures, INPG, BP n°53,
Grenoble cedex 9, France

² Laboratoire de Mécanique et Technologie, 61 avenue du
Président Wilson, 94235 Cachan cedex, France

ABSTRACT

To analyse the real 3D functioning of a structure under seismic loading the dialogue between tests and numerical simulations is needed. Within the framework of the TMR - ICONS research program, dynamic and cyclic tests on U-shaped shear walls have been performed at CEA Saclay and JRC Ispra respectively. More recently, for the French program “CAMUS 2000”, shaking table tests have been performed on reinforced concrete structural walls. In order to simulate these tests, 3D multi-fiber beam elements are used. Comparison with the experimental results shows the well matching and the limitations of the approach.

Keywords: fiber beam elements; dynamic transient analysis; continuum damage mechanics; seismic loading.

INTRODUCTION

Since 10 years France is involved on a series of seismic experimental programs, CASSBA, CAMUS and now CAMUS 2000 [1]. The main topics of the research are the effects of different reinforcement ratios, the effects of the support conditions and more recently the effects of a multi-directional loading. In order to simulate the 3D behaviour of the structures tested, a simplified modelling based on Euler-Bernoulli fiber-beam element description is used. That point is in progress and the presentation of the first results is shown.

A few months before, within the framework of the 5th topic (“Shear Wall Structures”) of the TMR (Training and Mobility of Researchers) ICONS (“Innovative Seismic Design Concepts for New and Existing Structures”) European Program, a series of dynamic and cyclic tests on U-shaped cross section shear walls have been carried out at CEA Saclay [2] and at JRC Ispra [3] respectively. The tests have been performed until collapse of the structures. In order to simulate the non linear behavior of the specimens, a 3D multi-fiber Timoshenko beam element has been developed and implemented into the library FEDEAS [4] of the finite element code FEAP [5]. The element uses higher order interpolation functions to avoid shear-locking phenomena. Some results of the simulation of the cyclic behaviour of these walls are also presented here.

Material modelling is based on continuous damage mechanics for concrete and uses kinematics hardening plasticity for steel. Some basic aspects for the use of such models in the framework of multi-fiber elements are presented at the beginning of the paper.

MULTIFIBER BEAM ELEMENTS

In order to conduct parametrical studies on big structures under seismic loading, we cannot afford classical 3D non-linear transient analysis. Our wish of simplicity and robustness lead to the use of 3D multi-fibers beam elements. In this section we describe only a short view of this method to point out the well matching and the limitations of it.

Cross section behavior

A multi-fiber beam element is first of all a beam element. Along its axis, usual beam shape functions are used. The difference with “classical” beam elements is in the cross section behavior, that is the relation between the generalized strains \mathbf{e} and the generalized stresses \mathbf{s} . In the general 3D case, for a Timoshenko like element:

$$\mathbf{s} = (N \quad S_y \quad S_z \quad M_x \quad M_y \quad M_z)^T \quad \text{and} \quad \mathbf{e} = (\varepsilon \quad \gamma_y \quad \gamma_z \quad \theta_x \quad \chi_y \quad \chi_z)^T \quad (1)$$

where N is the normal force, S_y and S_z the shear force, M_x the torque, M_y and M_z the bending moments, ε the axial strain, γ_y and γ_z the shear strains, θ_x the twist, χ_y and χ_z the curvatures. The cross section behavior is expressed with the matrix :

$$K_s = \begin{bmatrix} K_{s11} & 0 & 0 & 0 & K_{s15} & K_{s16} \\ & K_{s22} & 0 & K_{s24} & 0 & 0 \\ & & K_{s33} & K_{s34} & 0 & 0 \\ & & & K_{s44} & 0 & 0 \\ & & & & K_{s55} & K_{s56} \\ \text{sym} & & & & & K_{s66} \end{bmatrix} \quad (2)$$

where the coefficients are obtained through integrals over the cross section (y and z axes) :

$$\begin{aligned} K_{s11} &= \int_S E dS ; & K_{s15} &= \int_S E z dS ; \\ K_{s16} &= -\int_S E y dS ; & K_{s22} &= k_y \int_S G dS \\ K_{s24} &= -k_y \int_S G z dS ; & K_{s33} &= k_z \int_S G dS ; \\ K_{s34} &= k_z \int_S G y dS ; & K_{s44} &= \int_S G (k_z y^2 + k_y z^2) dS \\ K_{s55} &= \int_S E z^2 dS ; & K_{s56} &= -\int_S E y z dS ; & K_{s66} &= \int_S E y^2 dS \end{aligned} \quad (3)$$

In these equations k_y and k_z are shear correction factors. E and G (Young and Coulomb modulus) are functions of y and z . They can be initial, secant or tangent modulus depending on the algorithm used to solve the global equations. The numerical integrations of Eq. 3 are made with one gauss point per fiber.

For an Euler-Bernoulli like element, the terms S_y , S_x , γ_y and γ_x in Eq. 1 do not exist. The cross section behavior matrix is 4x4 without the terms K_{s22} , K_{s33} , K_{s24} nor K_{s34} . The shear forces are computed at the element level through the equilibrium equations (included in the shape functions).

Constitutive models

1D constitutive laws for concrete and steel are applied at each fiber. Seismic loading, which includes cyclic aspects, produces micro cracking in concrete. The major phenomena – decrease in material stiffness as the micro-cracks open, stiffness recovery as the cracks close (unilateral behavior of concrete) and inelastic strains concomitant to damage – have to be taken into account. The constitutive law used for concrete is based on the principles of damage mechanics [1, 6]. The law, called “Unilateral damage law”, is elaborated for the description of micro-cracks and involves two damage scalar variables, one in tension D_1 and one in compression D_2 , and the description of isotropic inelastic strains. The model is able to simulate the unilateral behavior of concrete via a recovery stiffness procedure at re-closure (Figure 1). The total strain in the 1D formulation of the law is given by:

$$\boldsymbol{\varepsilon} = \boldsymbol{\varepsilon}^e + \boldsymbol{\varepsilon}^{in} \quad (4)$$

$$\boldsymbol{\varepsilon}^e = \frac{\sigma_+}{E(1-D_1)} + \frac{\sigma_-}{E(1-D_2)} \quad (5)$$

$$\boldsymbol{\varepsilon}^{in} = \frac{\beta_1 D_1}{E(1-D_1)} F(\sigma) + \frac{\beta_2 D_2}{E(1-D_2)} \quad (6)$$

where $\boldsymbol{\varepsilon}^e$ and $\boldsymbol{\varepsilon}^{in}$ are the elastic strain and the inelastic strain respectively and E is the initial Young's modulus. The positive part and negative part of the stress are expressed by :

$$\begin{aligned} \sigma > 0 &\rightarrow \sigma_+ = \sigma, \sigma_- = 0 \\ \sigma < 0 &\rightarrow \sigma_+ = 0, \sigma_- = \sigma \end{aligned} \quad (7)$$

$F(\sigma)$ is the crack closure function, depending on the stress and on the material parameter σ_f (crack closure stress):

$$\begin{aligned} \sigma > 0 &\rightarrow F(\sigma) = 1 \\ -\sigma_f < \sigma < 0 &\rightarrow F(\sigma) = 1 - \frac{\sigma}{\sigma_f} \\ \sigma < -\sigma_f &\rightarrow F(\sigma) = 0 \end{aligned} \quad (8)$$

Damage criteria are expressed as $f_i = Y_i - Z_i$ ($i=1$ for tension or 2 for compression, Y_i is the associated force to the damage variable D_i and Z_i is a threshold dependent on the hardening variables). The evolution laws for the damage variables D_i are written as :

$$D_i = 1 - \frac{1}{1 + [A_i(Y_i - Y_{0i})]^{B_i}} \quad (9)$$

where Y_{0i} is the initial elastic threshold and A_i , B_i and β_i are material constants.

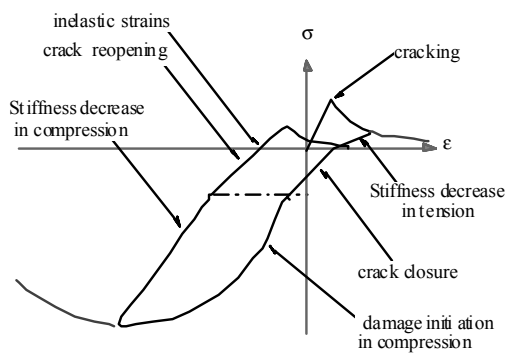

Figure 1: 1D “Unilateral damage law”

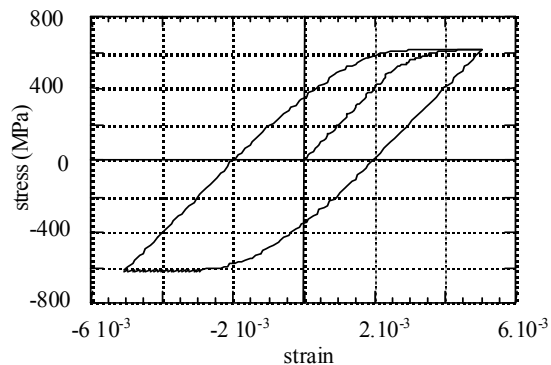

Figure 2: 1D steel constitutive law

A plasticity model with cinematic hardening is used for steel (Figure 2). Hardening can be linear or not depending on the information provided from the steel tensile strength tests. Only the longitudinal reinforcement is considered for the predictive calculations. Shear reinforcement and stirrups are not directly simulated. The concrete inside the stirrups is modelled with different parameters to take into account the confinement.

SHAKING TABLE TEST (CAMUS 2000-1)

Description of the experiment

The main goal of the CAMUS 2000-1 experiment is to investigate the behavior of reinforced concrete bearing walls subjected to multidirectional seismic loading. The specimen is a 1/3rd scaled mock-up of a 5 storeys building anchored to the shaking table of the CEA Saclay as described in Figure 3, Tables 1 & 2 .

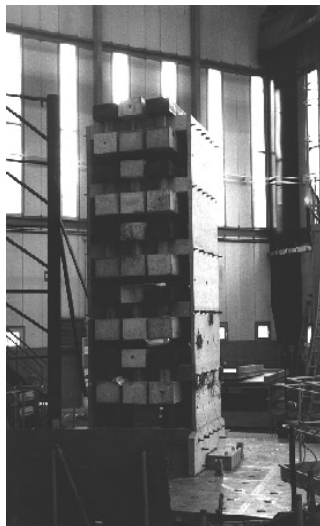

Figure 3: CAMUS 2000-1 specimen.

Table 1. CAMUS 2000-1 – Description of the test

1 Test	Dynamic	
<i>Boundary conditions</i>	Fixed base	
<i>Scale</i>	1/3	
<i>Height/Length</i>	≈ 3	
<i>Walls</i>	(l/h/d) m	1.7x5.1x0.06
<i>Floors</i>	(l/l/d) m	1.7x1.7x0.21
<i>Base slab</i>	(l/h/d) m	1.7x0.6x0.06
<i>Normal stress at the base</i>	MPa	1.6
<i>Masse</i>	Kg	36310

Table 2. CAMUS 2000-1 – Reinforcement in each edge (mm²)

5 th storey	1φ4.5=15.9
4 th storey	1φ4.5=15.9
3 rd storey	1φ4.5=15.9
2 nd storey	3φ4.5=47.7
1 st storey	6φ4.5=95.4

The loading is a set of accelerograms applied at increasing level of maximum acceleration (0.15g, 0.6g and 1.0g) in the X and Y directions (Z is the vertical axis).

Predictive numerical studies

The finite element analysis has been performed in CASTEM-2000 [7] with 3D multi-fibers Euler-Bernoulli beam elements. The mock-up modelling as well as the finite element mesh is presented in Figure 4.

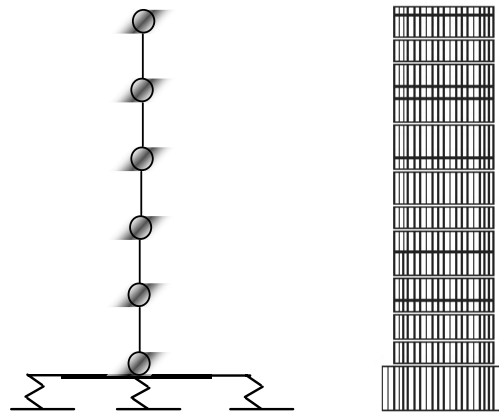

Figure 4: CAMUS 2000-1– FE mesh and boundary conditions

The additional masses and the weight load of each floor are concentrated at each storey. The stiffness of the springs below the shaking table is identified so as to fit the first eigenmodes measured on the virgin structure before the application of seismic loadings. The comparison between the first 3 numerical and experimental eigenmodes is reported in Table 3.

Table 3: Eigenmodes of the mock-up placed on the shaking table.

	Computations	Experiments
In plane flexion	6 Hz	6
Out plane flexion	5.5 Hz	5.45
Global torsion	12 Hz	-

The damping has been introduced through a Rayleigh type viscous damping matrix. The parameters of this damping matrix have been calibrated so as to introduce 3.5 % of damping on the 1st and the 3rd eigenmodes.

Results

First results are presented in terms of global flexural moment in the plane of the wall (X direction) for the 0.15g level of loading (Figure 5) and horizontal top displacements out of the plane of the wall (Y direction) (Figure 6). Based only on material characteristics deduced from previous tests on samples, these results have been obtained without any calibration according to the experimental results. Others results are available at the global level they exhibit quite good correlation, however more investigations for such analysis are in progress on the effects of damping and improvements of the modelling, particularly at the local level.

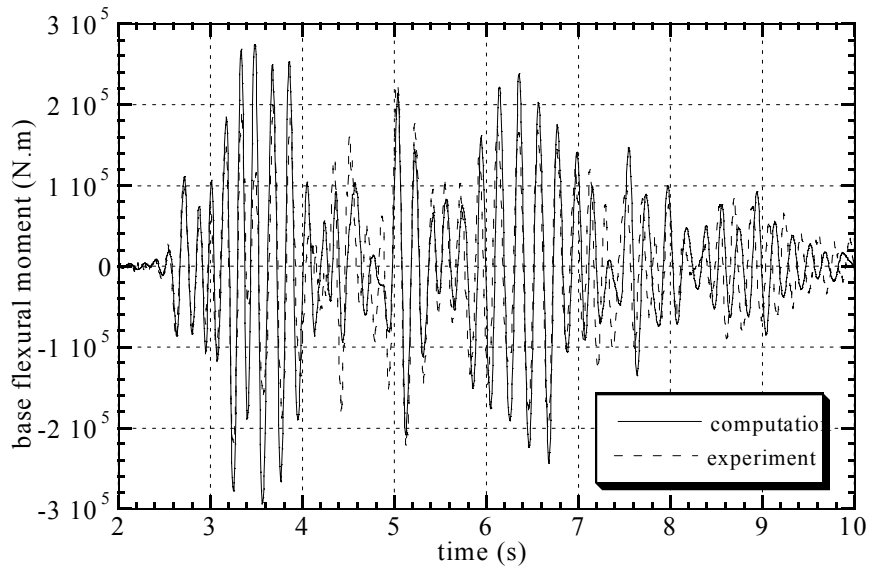

Figure 5: In plane flexural moment at the base : 0.15 g accelerogram

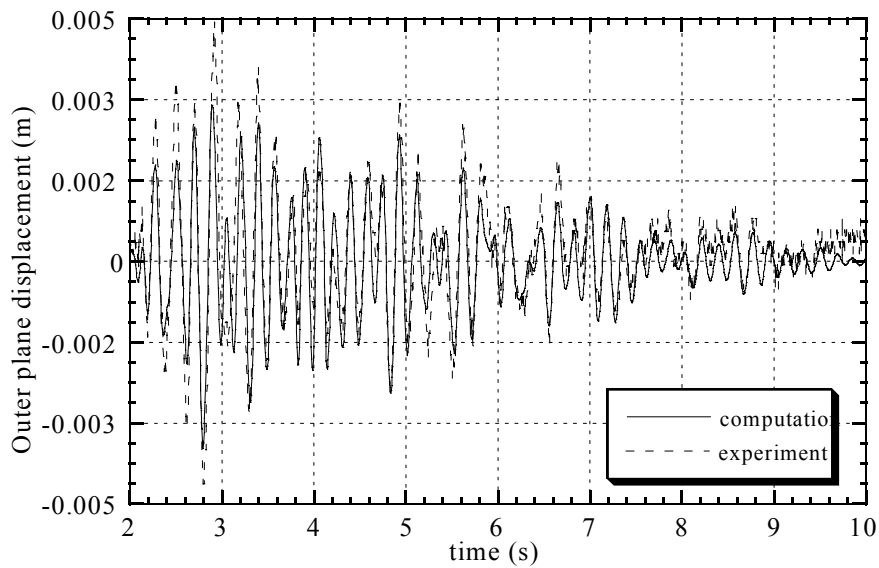

Figure 6: Out of plane horizontal top displacement: 0.15 g accelerogram

CYCLIC TESTS ON U-SHAPED WALLS

Description of the test

Four U-shaped walls have been tested in the reaction wall facility of the ELSA laboratory at JRC Ispra [3]. Geometrical dimensions and steel reinforcement of the specimens are shown in Figure 7. The specimens are composed of the u-shaped wall itself, the inferior and the superior slabs. The superior slab is used as the horizontal load application point. Six vertical

post-tensioning bars apply the normal force (2MN). These bars are disposed in a way that the force is applied close to the inertial center in order to avoid spurious bending on the structure. Torsion is prohibited during the tests. The walls have been instrumented in order to monitor their global (displacements, accelerations) and local (crack openings, strains of the steel reinforcement, shear deformation) behavior.

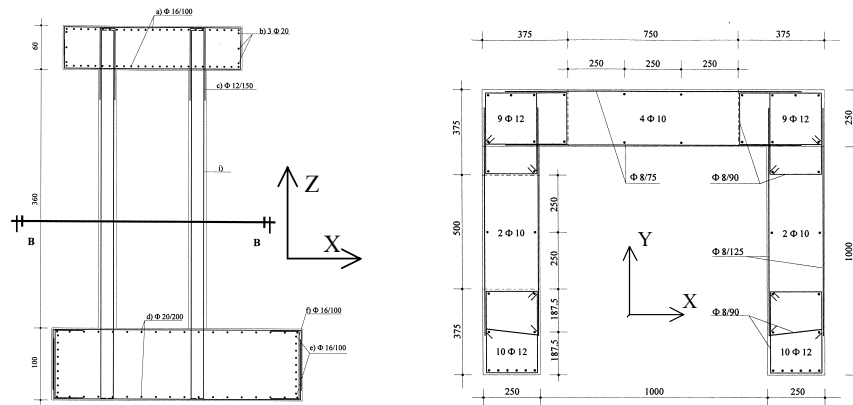

Figure 7: Description of the U-shaped specimen

A bi-directional test has been performed on one of the specimens. The applied load is presented in Figure 8 [3]. Four actuators, 2 in each direction, were used to apply the load and to prevent the rotation of the top slab around the vertical axis (no torsion rotation).

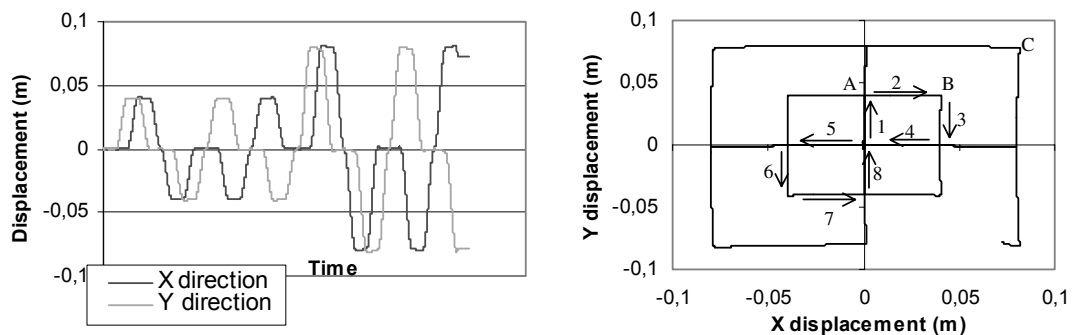

Figure 8: Prescribed displacements – Butterfly path.

Numerical simulation

In order to model the test where 3D phenomena were prevailing, a 3D multi-fiber Timoshenko beam element has been developed [8]. The element uses higher order interpolation functions to avoid any shear locking phenomena [9]. The shape functions used along the axis of the beam element (X-axis) are not detailed here.

Eleven multi-fiber Timoshenko beam elements are used to model the wall, with two gauss points per element along the X axis, that is two cross section (Eq. 2). Each cross section has 177 concrete fibers and 46 steel fibers. The base slab is not simulated and the wall is considered fixed at the base. The top slab has a linear behavior and the rotation of the upper part is prohibited in order to correctly reproduce the boundary conditions of the test. The

specific values used for the materials in the 1D constitutive laws presented before (Figures 1 and 2) are reported in Table 4.

Young's modulus (concrete)	20000 MPa
Poisson coefficient (concrete)	0.2
Compression strength (concrete)	31 MPa
Compression strength (confined concrete)	39 MPa
Young's modulus (steel)	200000 MPa
Poisson coefficient (steel)	0.3
Yield strength (steel)	460 MPa
Ultimate strength (steel)	710 MPa
Ultimate deformation (steel)	11%

Comparison of the numerical and experimental results for the eight flies of loading is represented in Figures 9-10 (the A,B,C letters refer to the Figure 9). The model simulates correctly the global behavior of the mock-up in terms of displacements in both directions. Nevertheless, one can observe some differences between the test and the simulation, especially in the unloading zones. This point is discussed in the next paragraph.

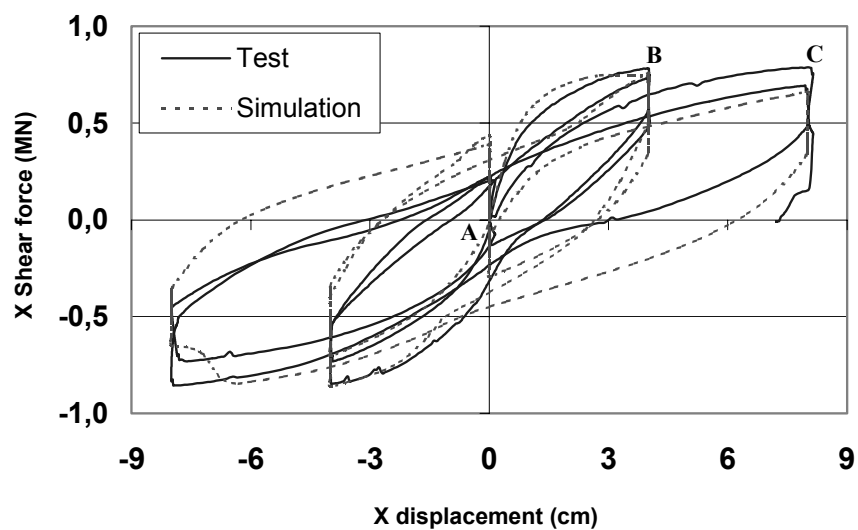

Figure 9: Cyclic test – Shear force versus displacement in the X direction.

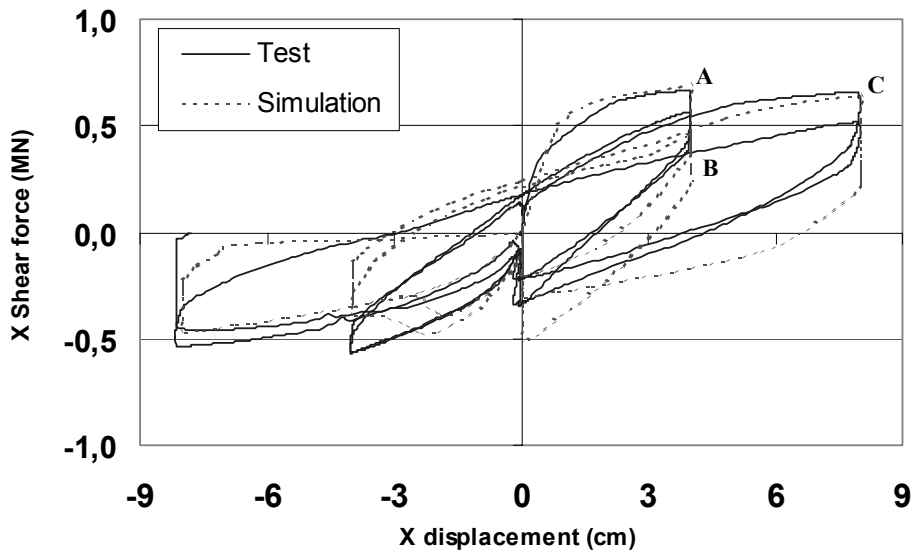

Figure 10: Cyclic test – Shear force versus displacement in the Y direction.

DISCUSSION

The global tendency of the simulation is to correctly model the test but there are still some differences. Two main points are under investigations : the non-linear torsion modelling and the use of a 3D robust constitutive model to take into account shear in the fibers.

Even if torsion rotation of the top slab was prevented in the U-shaped wall tests, torsion effects due to cracking have been observed. Indeed, the torsion centre (computed from the experimental force values of the actuators) moved a lot. It starts from inside the U shape and ends outside when the wall exhibits cracks at its base. In the presented simulations, the term K_{s44} in Equation 3 is not computed through numerical integration (a too great number of fibers should be needed to have an accurate value of this term). A constant value given at the beginning of the simulation is kept (linear elastic behavior in torsion). A good evaluation of the term K_{s44} taking into account the damaged modulus would lead to better results.

In Equation 3, E and G are affected by the damage state of the fibers. Thus the damage influences the internal forces of the beam element (even the shear forces). The constitutive laws used are 1D, thus only the axial strain ϵ_x of the fibers is used to compute damage. The use of a 3D constitutive law would permit to take into account the shear strains ϵ_{xy} and ϵ_{yx} of the fibers in the computation of damage. Works are in progress in these different ways.

CONCLUSIONS

The use of multi-fiber beam elements in the numerical simulation of reinforced concrete structures under seismic loading is a good compromise between the refinement of the modelling and the rapidity of the computations. They are not-much-time consuming and allow for parametrical studies even though the phenomena are quite complex. They allow the use of refined local constitutive laws like damage models as presented in this paper. Depending on slenderness of the structure, Euler-Bernoulli or Timoshenko beam elements can be used taking into account or not shear effects. This tool is used during both pre-

experimental and post-experimental phases. Predictive calculations help to define the loading sequences and the maximum acceleration to apply to the structures. Post experimental calculation help the analysis of the functioning of the structure during the test. At this stage of development the comparison with the experimental results are globally consistent for the two kind of structures presented in this paper, each loaded in a 3D manner (one vertical dead load and two directional dynamic or cyclic loading).

Two main point are under investigation to enhance the method: a better way to take into account of the non linear torsion and the improvement of the 3D damage constitutive law to better model the effects of shear.

REFERENCES

1. Mazars J. French advanced research on structural walls : An overview on recent seismic programs. Proc. 11th European Conference on Earthquake Engineering, Opening lecture; ed. Ph. Bisch et al., Balkema Rotterdam, 1998: 21-41.
2. Combescure D., Chaudat Th., & Moutafidou A. Seismic tests of ICONS U-shaped walls. Description of the experimental set up. Main results. Report DMT-SEMT/EMSI/RT/99-062, CEA Saclay, France, 1999.
3. Pegon P., Plumier C., Pinto A., Molina J., Gonzalez P., Tognoli P., & Hubert O. Quasi-static bi-axial test in the X and Y directions-Test report, JRC Ispra, Italy, 2000.
4. Filippou F.C. Nonlinear static and dynamic analysis for evaluation of structures. 3rd European Conference on Structural Dynamics Eurodyn 96, Florence Italy, 1996: 395-402.
5. Taylor R.L. FEAP: A finite element analysis program, version 5.01 manual. *University of California*, Berkeley, 1996.
6. La Borderie C. Phénomènes unilatéraux dans un matériau endommageable: modélisation et application à l'analyse des structures en béton. Ph.D thesis, Université Paris 6, France, 1991.
7. Verpeaux P., Charras T. and Millard A. CASTEM2000 une approche moderne du calcul des structures. Calcul des Structures et Intelligence Artificielle; Eds J.M. Fouet, P. Ladeveze and R. Ohayon; Pluralis, 1988: 261-271.
8. Kotronis P. Cisaillement dynamique de murs en béton armé. Modèles simplifiés 2D et 3D. Ph.D. thesis, ENS Cachan, France, 2000.
9. Friedman Z. & Kosmatka J.B. An improved two-node Timoshenko beam finite element. *Computers and structures*, Vol. 47, no 3, 1993: 473-481.