



HAL
open science

Impact of thermal aging on emission of a buck DC-DC converter

Alexandre Boyer, He Huang, Sonia Ben Dhia

► **To cite this version:**

Alexandre Boyer, He Huang, Sonia Ben Dhia. Impact of thermal aging on emission of a buck DC-DC converter. 2014 International Symposium on Electromagnetic Compatibility, Tokyo (EMC'14/Tokyo), May 2014, Tokyo, Japan. pp.77-80. hal-01006115

HAL Id: hal-01006115

<https://hal.science/hal-01006115v1>

Submitted on 13 Jun 2014

HAL is a multi-disciplinary open access archive for the deposit and dissemination of scientific research documents, whether they are published or not. The documents may come from teaching and research institutions in France or abroad, or from public or private research centers.

L'archive ouverte pluridisciplinaire **HAL**, est destinée au dépôt et à la diffusion de documents scientifiques de niveau recherche, publiés ou non, émanant des établissements d'enseignement et de recherche français ou étrangers, des laboratoires publics ou privés.

Impact of thermal aging on emission of a buck DC-DC converter

A. Boyer, H. Huang, S. Ben Dhia

CNRS, LAAS, 7 avenue du colonel Roche, F-31400 Toulouse, France

Univ de Toulouse, INSA, LAAS, F-31400 Toulouse, France

Alexandre.boyer@laas.fr

Abstract—The proposed paper aims at characterizing the effect of thermal aging of a buck DC-DC converter on its electromagnetic emission and identifying the role of the different constituting components. An equivalent model is built to confirm the emission level increase induced by high temperature stress.

Keywords—Switch-power mode supply, electromagnetic emission, accelerated aging, emission modeling.

I. INTRODUCTION

Because of their high power efficiency, switch-power mode supplies (SMPS) are widely used in electronic applications [1]. However, one of their main drawbacks is the noise produced by the switching activity, responsible of conducted and radiated electromagnetic emission (EME). Consequently, the management of the parasitic emission of SMPS is a frequent topic in literature specialized in electromagnetic compatibility (EMC) [2] [3].

These last years, the consideration of the long-term EMC of integrated circuits (IC) appeared, i.e. the evolution of parasitic emission and susceptibility to electromagnetic interferences with time for electronic devices operating in harsh environments [4] [5]. Passive devices are also degraded in harsh conditions, such as aluminum electrolytic capacitors wear-out in electrical or thermal overstress conditions [6]. As this type of device is used to filter the output voltage of SMPS, a direct consequence of electrolytic capacitor aging is the increase of the ripple of the output voltage of SMPS [7]. Another consequence is the increase of EME, but this topic is less discussed in the literature.

This paper deals with the consequences of the accelerated aging of a step-down or buck DC-DC converter on its EME. It aims at characterizing precisely the effect on both the conducted and radiated emission, and identifying the roles of the different components which constitute the converter. Moreover, an electrical model of the converter is proposed to simulate the effect of aging of each part of the converter on the conducted emission.

II. PRESENTATION OF THE EXPERIMENTAL SET-UP

A. Description of the buck DC-DC converter

The studied SMPS is based on the NCP3163 monolithic DC-DC converter from On Semiconductor. It is configured in step-down operation, in order to convert the 12 V voltage

provided by a battery into a 3.3 V regulated voltage for a constant load equal to 3.4 Ω . The switching frequency is set to 210 KHz. A simplified schematic of the converter is presented in Fig. 1; the characteristics of filtering passive devices and rectifier are given in Table I. The output voltage is adjusted by resistors R_1 and R_2 through the Feedback pin.

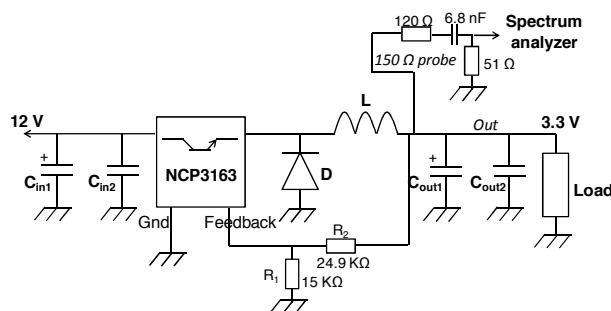

Fig. 1. Schematic of the studied buck DC-DC converter

B. Emission measurement set-up

The board has been designed to characterize both conducted and radiated emissions from the converter. The conducted emission at the output of the converter is measured through a 150 Ω probe [8]. The output voltage ripple is also monitored with an oscilloscope. The converter is mounted on a dedicated test board designed to ensure radiated emission in TEM cell [9]. All the devices are mounted on the top layer of the test board.

C. Accelerated aging

The different devices of the converter are sensitive to electrical or thermal overstress conditions. In order to accelerate the converter aging, it operates in a nominal mode in a high temperature environment. Four converters are placed eight days in a thermal oven, which regulates the ambient temperature at 150°C. Preliminary experiments have confirmed that significant changes of EME can be observed after several days. The four sound converters are noted Fr1 to Fr4, while the four degraded converters are noted Ag1 to Ag4.

TABLE I. PASSIVE DEVICE CHARACTERISTICS

Name	Reference	Value	Max. ratings
C_{in1}	Aluminium electrolytic capacitor EEEF1E470AP	47 μ F	25 V, 105 °c
C_{out1}	Aluminium electrolytic capacitor EEEHBA101UAP	100 μ F	10 V, 105°c
C_{in2} , C_{out2}	X7R ceramic capacitor GCM21BR71H104KA37L	100 nF	50V, 125°c
L	Shielded core powder inductor IHLP4040DZ11	22 μ H	5 A, 125°c
D	Power Schottky rectifier STPS340	--	3 A, 150°c

III. EVOLUTION OF EMISSION AFTER ACCELERATED AGING

A. Evolution of the output voltage ripple

After the thermal stress, all the tested samples remain operational but the output voltage ripple has strongly increased, by 100 or 200 % (Fig. 2). As mentioned in numerous publications such as [7], it is a direct consequence of the degradation of the filtering electrolytic capacitors placed at the converter output (C_{out1}). The high temperature contributes to an increase of its Equivalent Serial Resistance (ESR) combined with a decrease of the capacitance.

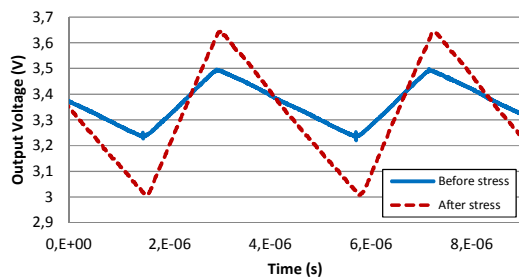

Fig. 2. Evolution of the output voltage ripples measured on converter #1

B. Evolution of the conducted emission

The conducted emission level measured at the converter output also increases after aging over a large frequency range, as shown in Fig. 3. For clarity purpose, only the results measured on converters 1 and 2 and the envelopes of emission spectra are plotted. Similar behaviors are measured on converters 3 and 4. The average increase ranges between 6 and 20 dB between 200 KHz and 150 MHz.

C. Evolution of the radiated emission

The radiated emission levels measured in TEM cell rise after aging over a wide frequency range, as shown in Fig. 4. The average increase of radiated emission level is less compared to the conducted emission level increase. It is about 5 dB between 200 KHz and 150 MHz.

IV. EXPERIMENTAL ANALYSIS OF THE ELECTROMAGNETIC EMISSION EVOLUTION OF THE DC-DC CONVERTER

The role of electrolytic capacitors in the increase of SMPS output voltage ripple is widely exhibited in scientific literature [7], followed by the switching device [10]. The following tests aim at identifying the components responsible of the EME increase.

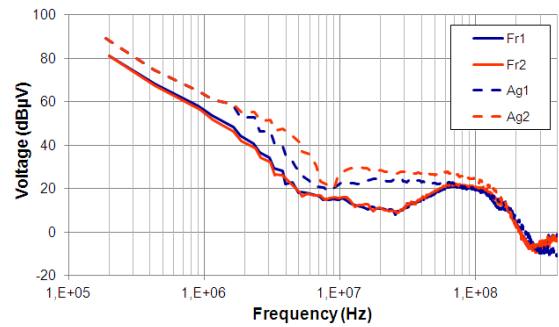

Fig. 3. Comparison of the conducted emission between sound and aged converters

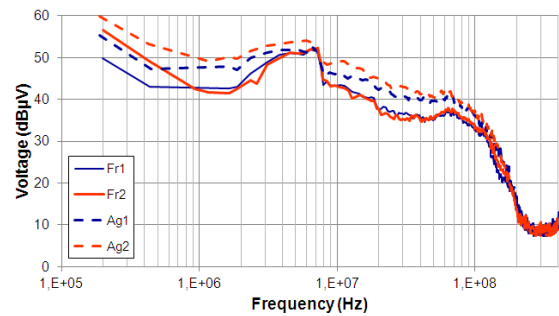

Fig. 4. Comparison of the radiated emission in TEM cell between sound and aged converters

A. Identification of degraded devices

The first test to identify which devices of the converter has an impact on the emission increase consists in changing one or several stressed devices by sound devices on one aged test board, and then measuring the variation of emission level. If the variation is significant and leads to a return to the initial emission level, we can conclude that the changed device has a major influence on the change of emission level. These basic tests have shown that the electrolytic capacitor C_{out1} and inductor L degradation affects the emission level. All the other devices have a minor impact. Fig. 5 presents the evolution of conducted emission for different combination of sound and aged passive devices.

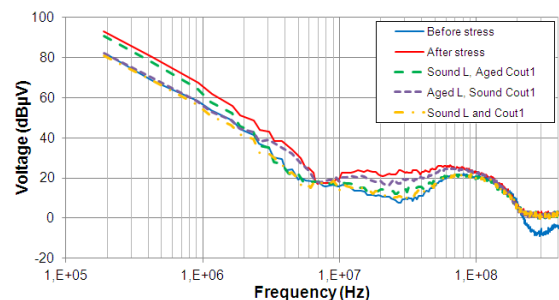

Fig. 5. Experimental analysis of the influence of the degradation of inductor and output filtering capacitors on the conducted emission

Changing both output filtering capacitor (C_{out1}) and inductor (L) is enough to bring emission and output voltage ripple at their initial levels. The results confirm the predominant influence of the output filtering capacitor (C_{out1}) on the output voltage ripple and on the low frequency range of the emission spectrum (from 200 KHz up to 1.8 MHz). It is

interesting to notice that the inductor degradation has a major impact on the medium and high frequency range of the emission spectrum (above 3 MHz).

B. Characterization of degraded devices

Two-port S parameter characterizations done on fresh and aged electrolytic capacitors and inductors (Figs 6 and 7) show a significant change of their impedances after stress. The same characterizations have been done also on the ceramic capacitors and the rectifier, which confirm that their electrical characteristics have not evolved after the thermal stress. Results obtained on 100 μ F electrolytic capacitors (C_{out1}) show that the Equivalent Series Resistance (ESR) of the capacitor increases between 10 kHz to about 200 MHz (Fig. 6). The capacitance value is measured by a multimeter and also decreases. These effects are well known as a result of the decrease of the volume of electrolyte due to thermal overstress [6]. The same type of evolution is also observed on the 47 μ F electrolytic capacitors (C_{in}).

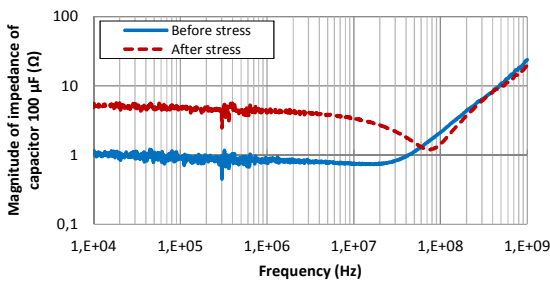

Fig. 6. Impedance measurements of sound and aged 100 μ F electrolytic capacitors mounted on converter #1

The self-resonant frequency of inductor declines after the aging, as illustrated in Fig. 7, because of the increase of the parasitic parallel capacitor. This effect leads to a reduction of the impedance of the inductor between 3 and 150 MHz. Moreover, the quality factor of the inductor decreases in this frequency range. This effect can be explained by an increase of core loss after the thermal stress [11].

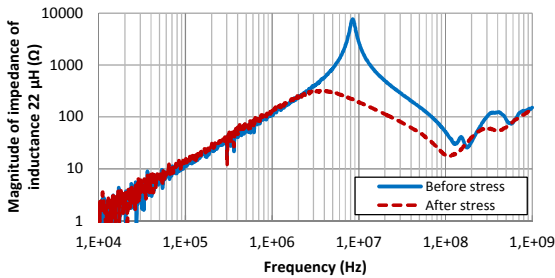

Fig. 7. Impedance measurements of sound and aged 22 μ H inductors mounted on converter #2

V. MODELING OF THE EVOLUTION OF CONDUCTED EMISSION OF THE DC-DC CONVERTER

A. Modeling of passive devices

The model is based on accurate high frequency modeling of passive devices, which takes into account the evolution of electrical characteristics after aging. All the simulations are

performed with Agilent's Advanced Design System (ADS). Basic models of passive devices based on serial or parallel RLC topologies [6] are not sufficient to achieve a high accuracy. To model the frequency dependence of the electrolytic capacitor ESR, three parallel resistor capacitor pairs are placed in series with a constant resistance, as shown in Fig. 8. Besides, to model the fluctuation of impedance of inductor observed above 100MHz, a combination of resistances, inductances and capacitances (RLC) is added (Fig. 9). The simulation result fits perfectly with the measurement (Fig.10).

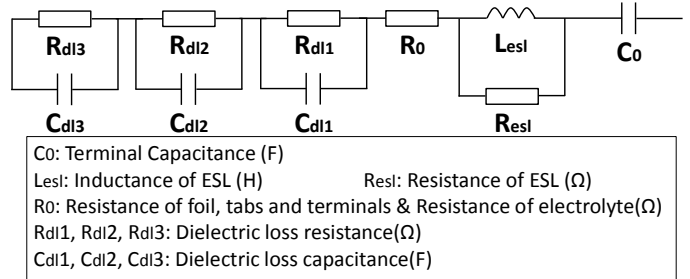

Fig. 8. Electrical model of the electrolytic capacitor C_{out1}

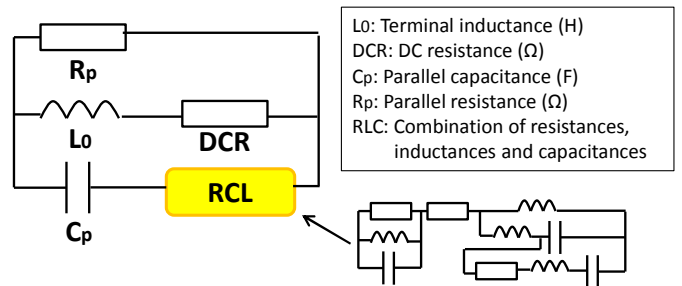

Fig. 9. Electrical model of the inductor L

According to the comparison of the model values resumed in Table II, the ESR of capacitor increases after aging while the terminal capacitance (C_0) decreases. For the inductor, the parallel resistance (R_p) decreases sharply while the parallel capacitance (C_p) increases.

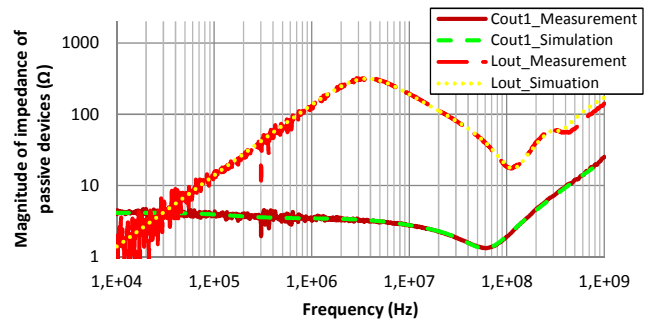

Fig. 10. Comparison between measurement and simulation of the impedance simulation of aged 100 μ F electrolytic capacitors and 22 μ H inductor mounted on converter #2

B. Modeling of the conducted emission of the DC-DC converter

Fig. 11 details the whole converter model. The converter is modeled by an ideal switch which is controlled by a

rectangular voltage source. The rectifier modeling is based on I(V) characteristic and impedance measurements. Besides, the models of passive devices (L , C_{out1} and C_{out2}) are added in the output side of the switch.

TABLE II. EVOLUTION OF MODEL PARAMETERS OF SOUND AND AGED PASSIVES DEVICES MOUNTED ON CONVERTER #2

Device	Parameter	Fresh	Aged	Change after aging
100 μ F capacitors	C_0	101 μ F	75 μ F	↓
	ESR (200kHz)	0.9 Ω	3.7 Ω	↑
22 μ H inductor	R_p	9200 Ω	331 Ω	↓
	C_p	22 pF	73 pF	↑

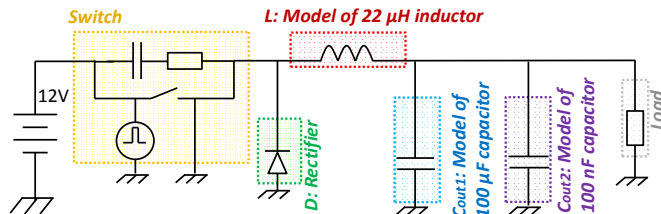

Fig. 11. Modeling of the DC-DC buck converter before stress

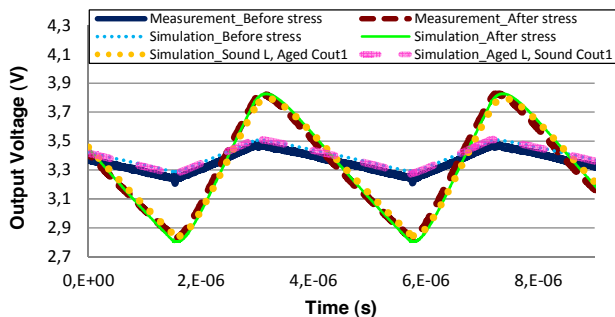

Fig. 12. Comparison between measurement and simulation of output voltage ripple of sound and aged converter (converter #3)

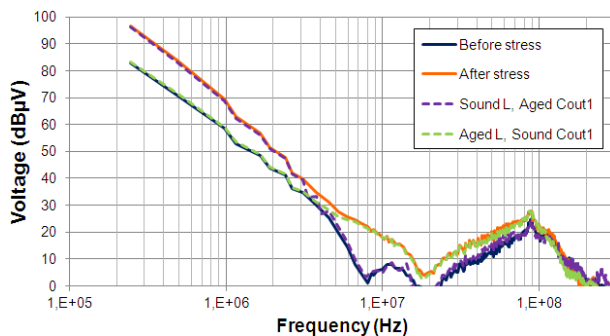

Fig. 13. Comparison between measurement and simulation of the conducted emission of the sound and aged converter (converter #3)

The output voltage ripple simulations are presented in Fig. 12 and confirm the major impact of the ESR increase of C_{out1} , at the switching frequency. The inductance degradation has almost no contribution to the increase of ripple voltage. The simulations of the conducted emission measured at the output are presented in Fig. 13 and confirm the role of the electrolytic capacitor only in low to medium frequency (up to 3 MHz), while the inductor degradation increases the emission level by several dB above 2 MHz. This result shows that the

degradation of the inductor have serious consequences on electromagnetic emissions.

VI. CONCLUSION AND PERSPECTIVES

This paper aims at studying the impact of the thermal accelerated aging on the emission of a buck DC-DC converter. The experimental tests have shown not only an increase of the output voltage ripple but also a rise of the conducted and radiated emission spectra over a large frequency range. Our study has confirmed the well known role of the degradation of electrolytic capacitors which have an impact on the low frequency range. However, it has also shown that the degradation of inductors induces a major increase of the emission level at high frequency. An electrical model of the converter output has been built to simulate the evolution of the conducted emission. This model is based on accurate modeling of passive devices, before and after thermal stress. It includes the increase of the ESR for electrolytic capacitors, and the increase of core losses and parasitic capacitor for the inductors. Further studies on other passive references and with other stress conditions should be led to verify that these effects are general and improve the modeling of passive degradations.

REFERENCES

- [1] C. Basso, *Switch-Mode Power Supplies SPICE Simulations and Practical Designs*, McGraw Hill Professional, 2008.
- [2] K. Kam, D. Pommerenke, A. Bhargava, C. Lam, R. Steinfeld, F. Centola, "Analysis and Mitigation Techniques for Broadband EMI from Synchronous Buck Converter", *IEEE Electromagnetic Compatibility Magazine*, Vol. 1, Quarter 3, 2012.
- [3] K. Mainali, R. Oruganti, "Conducted EMI Mitigation Techniques for Switch-Mode Power Converters: A Survey", *IEEE Transactions on Power Electronics*, Vol. 25, No 9, September 2010.
- [4] I. Montanari, A. Tacchini, M. Maini, "Impact of thermal stress on the characteristics of conducted emissions", 2008 IEEE Int. Symposium on Electromagnetic Compatibility, EMC 2008, Detroit.
- [5] A. Boyer, S. Ben Dhia, B. Li, N. Berbel, R. Fernandez-Garcia, "Experimental Investigations on electrical Stress Impact on Integrated Circuit Electromagnetic Emission", *IEEE Trans. on EMC*, vol. PP, no 99, Feb. 2013.
- [6] M. L. Gasperi, "A method for predicting the expected life of bus capacitors", 32nd Industry Applications Conference IAS'97, 1997.
- [7] P. Venet, A. Lahyani, G. Grellet, A. Ah-Jaco, "Influence of aging on electrolytic capacitors function in static converters: Fault prediction method", *European Physical Journal – Applied Physics*, vol. 5, pp. 71 – 83, 1999.
- [8] IEC61967-4 Ed. 1.1, "Integrated circuits – Measurement of electromagnetic emissions, 150 kHz to 1 GHz – Part 4: Measurement of conducted emissions – 1 Ω /150 Ω direct coupling method", International Electrotechnical Commission, 2006.
- [9] IEC61967-2 Ed. 1.1, "Integrated circuits – Measurement of electromagnetic emissions, 150 kHz to 1 GHz – Part 2: Measurement of radiated emissions – TEM cell and wideband TEM cell method", International Electrotechnical Commission, 2005.
- [10] A. Lahyani, P. Venet, G. Grellet, P.J. Viverge, "Failure Prediction of Electrolytic Capacitors During Operation of a Switchmode Power Supply", *IEEE Trans. Power Electr.*, vol. 13, no 6, Nov. 1998.
- [11] Micrometal Inc, "Core Loss Increase Due to Thermal Aging", [Online]. Available: http://www.micrometals.com/material/Coreloss_aging.html.