



HAL
open science

Microcracks-induced damage modelling for transversely isotropic rock

Séverine Levasseur, Hélène Weleman, Djimédo Kondo

► **To cite this version:**

Séverine Levasseur, Hélène Weleman, Djimédo Kondo. Microcracks-induced damage modelling for transversely isotropic rock. International Symposium on Computational Geomechanics (ComGeo III), Aug 2013, Krakow, Poland. pp. 1-12. hal-01005518

HAL Id: hal-01005518

<https://hal.science/hal-01005518>

Submitted on 13 Jun 2014

HAL is a multi-disciplinary open access archive for the deposit and dissemination of scientific research documents, whether they are published or not. The documents may come from teaching and research institutions in France or abroad, or from public or private research centers.

L'archive ouverte pluridisciplinaire **HAL**, est destinée au dépôt et à la diffusion de documents scientifiques de niveau recherche, publiés ou non, émanant des établissements d'enseignement et de recherche français ou étrangers, des laboratoires publics ou privés.



Open Archive Toulouse Archive Ouverte (OATAO)

OATAO is an open access repository that collects the work of Toulouse researchers and makes it freely available over the web where possible.

This is an author-deposited version published in: <http://oatao.univ-toulouse.fr/>
Eprints ID: 10133

To cite this version:

Levasseur, Séverine and Weleman, Hélène and Kondo, Djimédo
Microcracks-induced damage modelling for transversely isotropic rock.
In: International Symposium on Computational Geomechanics (ComGeo III), 21 August 2013 - 23 August 2013 (Krakow, Poland).

Any correspondence concerning this service should be sent to the repository administrator: staff-oatao@listes-diff.inp-toulouse.fr

Microcracks-induced damage modelling for transversely isotropic rock

Séverine Levasseur

Département ArGENCo, Université de Liège, Liège, Belgium

Hélène Weleman

Ecole Nationale d'Ingénieurs de Tarbes, Université de Toulouse, Tarbes, France

Djimédo Kondo

Institut d'Alembert, Université de Paris VI, Paris, France

ABSTRACT: *In the present study a new micromechanical damage model is proposed for transversely isotropic rocks. The originality of this model lies in the fact that it accounts not only for the coupling between material structural anisotropy and damage-induced one, but also for the opening/closure status (the so-called unilateral effects) of evolving microcracks. Taking advantage of a recent study by Goidescu et al. (2013), a closed-form expression of the overall free energy of the microcracked medium is presented. This expression is implemented in an appropriate thermodynamics framework which allows formulating a complete constitutive damage model. The salient features of the model such as the coupling between anisotropies and its effect on the damage yield function and on the tangent operator of the model are illustrated and validated on the identification of a transversely isotropic argillite. It is shown that under direct tensile loadings (including off-axis tests), the theoretical mechanical responses predicted by the proposed model well capture experimental data. Owing to the above results, the response of the material is studied along a tension loading followed by an unloading and a reloading in compression in order to illustrate the so-called unilateral damage effects due to microcracks closure.*

1 INTRODUCTION

The inelasticity of rock behaviour under mechanical loading results generally from damage phenomena due to evolving microcracks. To model it, both phenomenological and micromechanical approaches have been developed in the last decades in the framework of Continuum Damage Mechanics (CDM) (see for instance Krajcinovic 1996; Lemaitre & Chaboche 1990; Costanzo et al. 1996; Ju & Lee 1991; Kachanov 1982; Levasseur et al. 2011; Pensée et al. 2002; Zhu et al. 2008). However despite their interest, the above cited models concern mainly materials which are isotropic in their undamaged state. The modelling of coupling between initial and damage-induced anisotropies can only be found on studies devoted to brittle matrix composites, like Cazacu et al. (2007) and Halm & Dragon (1996) for purely macroscopic models or Baste (2001) and more recently Monchiet et al. (2012) in the context of micro-macro models. But, this class of models still need to be completed in order to properly account for unilateral effects due to microcracks closure, which are of paramount importance and necessary for the modelling of quasi brittle geomaterials generally subjected to tensile loadings as well as to compression. In this way, Goidescu et al. (2013) recently established closed-form expressions of the overall free

energy of orthotropic materials weakened by microcracks, either open or closed. The present study takes advantage of these recent results to formulate a complete model with coupling between initial anisotropy and evolving unilateral damage due to 2D systems of open or closed microcracks under frictionless conditions.

For this purpose, the closed-form expression of the macroscopic free energy is recalled in this paper to constitute the thermodynamics potential of damaged geomaterials. Based on a discrete damage representation defined by microcrack densities, the state laws are deduced providing the macroscopic stress as well as the damage energy release rate in function of the macroscopic strain and the damage characteristics. It follows a damage yield function associated to each microcracks family and the damage evolution law by assuming normality rule as in CDM framework. This allows to establish the complete rate formulation of the anisotropic constitutive damage law with microcracks closure effects. After a simple calibration step, the ability of the model to account for the coupling between the initial anisotropy and microcracks-induced one is assessed first by comparing its prediction to available data on the behaviour of an argillite subjected to a tensile loading (Liao et al. 1997), second by analysing the response of the material along a tension loading followed by an unloading and a reloading in compression illustrating the so-called unilateral damage effects due to microcracks closure.

Notations: Standard tensorial notations is used throughout the paper. Lower bold script letter describes vector, bold script capital letters is associated to second-order tensors and mathematical double-struck capital letter denotes fourth-order tensors. The following vector and tensor products are exemplified: $(\mathbf{A} \cdot \mathbf{b})_i = A_{ij}b_j$, $(\mathbf{A} \cdot \mathbf{B})_{ij} = A_{ik}B_{kj}$, $(\mathbb{A} : \mathbf{B})_{ij} = A_{ijkl}B_{kl}$, $(\mathbb{A} : \mathbb{B})_{ijkl} = A_{ijpq}B_{pqkl}$. Einstein summation convention, applied for the repeated indices and Cartesian coordinates are used. As usually, small respectively large characters refer to microscopic (resp. macroscopic) quantities. \mathbf{I} and \mathbb{I} are, respectively, the second and fourth order identity tensors, the components of the former is represented by the Kronecker symbol (δ_{ij}) while for the latter one has $I_{ijkl} = (1/2)(\delta_{ik}\delta_{jl} + \delta_{il}\delta_{jk})$.

2 MICROCRACKS-INDUCED DAMAGE MODEL

2.1 Representative volume element (r.v.e.)

Micromechanical formulation of damage model requires the homogenization of the microcracked material by defining a representative volume element *r.v.e.* of the material (noted Ω) constituted of an elastic orthotropic solid matrix s (occupying a domain Ω^s) and an arbitrary system of microcracks families (denoted r and occupying a domain Ω^r). This *r.v.e.* is subjected to uniform strain boundary conditions (the so-called Hashin boundary conditions):

$$\boldsymbol{\xi} = \mathbf{E} \cdot \mathbf{z} : \forall \mathbf{z} \in \partial\Omega \quad (1)$$

\mathbf{z} denoting the vector position, $\boldsymbol{\xi}$ the displacement vector, and \mathbf{E} the macroscopic strain tensor. The local constitutive equation in the heterogeneous medium follows elastic relation:

$$(\mathbf{z} \in \Omega) \quad \boldsymbol{\sigma}(\mathbf{z}) = \mathbb{C}(\mathbf{z}) : \boldsymbol{\varepsilon}(\mathbf{z}) \quad (2)$$

with $\boldsymbol{\sigma}(\mathbf{z})$ the local stress tensor and $\mathbb{C}(\mathbf{z})$ the heterogeneous stiffness tensor such as:

$$\mathbb{C}(\mathbf{z}) = \begin{cases} \mathbb{C}^s & \text{in matrix } (\Omega^s) \\ \mathbb{C}^r & \text{in microcracks domain } (\Omega^r) \end{cases} \quad (3)$$

In the two dimensional approach considered in this paper, the solid matrix stiffness has an orthotropic structure with symmetry axes corresponding to the orthonormal basis $(\mathbf{e}_1, \mathbf{e}_2)$ defined in Figure 1 and is described by means of the structural fabric tensor $\mathbf{A} = \mathbf{e}_1 \otimes \mathbf{e}_1$, such as:

$$\mathbb{C}^s = a_1 \mathbf{I} \otimes \mathbf{I} + a_2 \mathbf{I} \otimes \mathbf{I} + a_3 \mathbf{A} \otimes \mathbf{A} + a_4 (\mathbf{A} \otimes \mathbf{I} + \mathbf{I} \otimes \mathbf{A}) \quad (4)$$

where

$$\begin{aligned} a_1 &= \mathbb{C}_{2222}^s - 2\mathbb{C}_{1212}^s & a_2 &= 2\mathbb{C}_{1212}^s \\ a_3 &= \mathbb{C}_{1111}^s + \mathbb{C}_{2222}^s - 2\mathbb{C}_{1122}^s - 4\mathbb{C}_{1212}^s & a_4 &= \mathbb{C}_{1122}^s - \mathbb{C}_{2222}^s + 2\mathbb{C}_{1212}^s \end{aligned} \quad (5)$$

and

$$\begin{aligned} \mathbb{C}_{1111}^s &= \frac{E_1}{1 - \nu_{12}\nu_{21}}, & \mathbb{C}_{2222}^s &= \frac{E_2}{1 - \nu_{12}\nu_{21}}, & \mathbb{C}_{1212}^s &= G_{12}, \\ \mathbb{C}_{1122}^s &= \mathbb{C}_{2211}^s = \frac{\nu_{21}E_1}{1 - \nu_{12}\nu_{21}} & \text{with} & \frac{\nu_{12}}{E_1} &= \frac{\nu_{21}}{E_2} \end{aligned} \quad (6)$$

in which E_1 and E_2 are the Young modulus in anisotropic directions related respectively to \mathbf{e}_1 and \mathbf{e}_2 , G_{12} is the shear modulus and ν_{12} and ν_{21} are Poisson's ratios related to $(\mathbf{e}_1, \mathbf{e}_2)$.

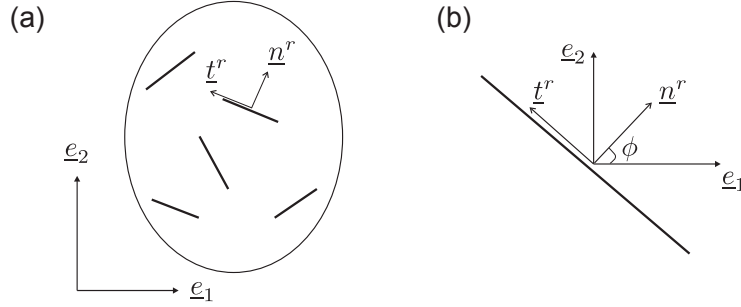

Fig. 1. (a) Representative volume element in two-dimensional case; (b) crack coordinate system

2.2 Thermodynamic potential of the transverse isotropic medium weakened by an arbitrarily distribution of microcracks

According to Goidescu *et al.* study (2013), the macroscopic thermodynamic potential of the anisotropic medium weakened by an arbitrarily oriented distribution of microcracks can be expressed as a function of the macroscopic strain tensor \mathbf{E} (the observable state variable of the problem) and of the set of damage variables d^r , noted \mathbf{d} , and associated to all microcracks family r ranging from 1 to $N = N_o + N_c$ (the internal state variables of the problem associated to N_o families of open microcracks and N_c families of closed microcracks):

$$\begin{aligned} \Psi(\mathbf{E}, \mathbf{d}) &= \frac{1}{2} \mathbf{E} : \mathbb{C}^s : \mathbf{E} \\ &- \sum_{r=1}^{N_o} d^r \{ H_{nn}^r (\mathbf{N}^r : \mathbf{E})^2 + 2H_{nt}^r (\mathbf{N}^r : \mathbf{E})(\mathbf{T}^r : \mathbf{E}) + H_{tt}^r (\mathbf{T}^r : \mathbf{E})^2 \} \\ &+ \sum_{r=1}^{N_c} \frac{d^r}{H_{nn}^r H_{tt}^r - H_{nt}^r{}^2} \{ H_{nn}^r H_{nt}^r{}^2 (\mathbf{N}^r : \mathbf{E})^2 + 2H_{nt}^r{}^3 (\mathbf{N}^r : \mathbf{E})(\mathbf{T}^r : \mathbf{E}) \\ &\quad + H_{tt}^r (2H_{nt}^r{}^2 - H_{nn}^r H_{tt}^r) (\mathbf{T}^r : \mathbf{E})^2 \} \end{aligned} \quad (7)$$

in which

$$\mathbf{N}^r = \mathbb{C}^s : (\mathbf{n}^r \otimes \mathbf{n}^r), \quad \mathbf{T}^r = \frac{1}{2} \mathbb{C}^s : (\mathbf{n}^r \otimes \mathbf{t}^r + \mathbf{t}^r \otimes \mathbf{n}^r) \quad (8)$$

are two second order symmetric tensors, and H_{nn}^r , H_{nt}^r and H_{tt}^r are material parameters that depend on the virgin matrix properties and on the crack orientation $\phi^r = (\mathbf{e}_1, \mathbf{n}^r)$ as:

$$H_{nn}^r = C(1 - D \cos 2\phi^r), \quad H_{nt}^r = CD \sin 2\phi^r, \quad H_{tt}^r = C(1 + D \cos 2\phi^r) \quad (9)$$

with scalars C and D related to the initial stiffness components:

$$C = \frac{\pi}{4} \frac{\sqrt{\mathbb{C}_{1111}^s} + \sqrt{\mathbb{C}_{2222}^s}}{\sqrt{\mathbb{C}_{1111}^s \mathbb{C}_{2222}^s - (\mathbb{C}_{1122}^s)^2}} \sqrt{\frac{1}{\mathbb{C}_{1212}^s} + 2 \frac{\sqrt{\mathbb{C}_{1111}^s \mathbb{C}_{2222}^s - \mathbb{C}_{1122}^s}}{\mathbb{C}_{1111}^s \mathbb{C}_{2222}^s - (\mathbb{C}_{1122}^s)^2}} \quad (10)$$

$$D = \frac{\sqrt{\mathbb{C}_{1111}^s} - \sqrt{\mathbb{C}_{2222}^s}}{\sqrt{\mathbb{C}_{1111}^s} + \sqrt{\mathbb{C}_{2222}^s}} \quad (11)$$

The transition between open and closed cracks is described by $g(\mathbf{E}, \mathbf{n}^r)$ function:

$$g(\mathbf{E}, \mathbf{n}^r) = H_{nn}^r \mathbf{N}^r : \mathbf{E} + H_{nt}^r \mathbf{T}^r : \mathbf{E} \quad (12)$$

If $g(\mathbf{E}, \mathbf{n}^r) > 0$ microcracks are open, while they are closed if not.

The following unified formulation of equation (7) can also be adopted in case of open or closed cracks:

$$\Psi(\mathbf{E}, \mathbf{d}) = \frac{1}{2} \mathbf{E} : \mathbb{C}^{hom} : \mathbf{E} \quad (13)$$

with

$$\mathbb{C}^{hom} = \mathbb{C}^s - \sum_{r=1}^N 2d^r \{ \mathcal{C}_1^r \mathbf{N}^r \otimes \mathbf{N}^r + \mathcal{C}_2^r [\mathbf{N}^r \otimes \mathbf{T}^r + \mathbf{T}^r \otimes \mathbf{N}^r] + \mathcal{C}_3^r \mathbf{T}^r \otimes \mathbf{T}^r \} \quad (14)$$

in which constants \mathcal{C}_1^r , \mathcal{C}_2^r and \mathcal{C}_3^r are defined in case of open cracks (index o) as:

$$\mathcal{C}_{1_o}^r = H_{nn}^r, \quad \mathcal{C}_{2_o}^r = H_{nt}^r, \quad \mathcal{C}_{3_o}^r = H_{tt}^r \quad (15)$$

while for closed cracks (index c) one has:

$$\mathcal{C}_{1_c}^r = -\frac{H_{nn}^r H_{nt}^{r2}}{H_{nn}^r H_{tt}^r - H_{nt}^{r2}}, \quad \mathcal{C}_{2_c}^r = -\frac{H_{nt}^{r3}}{H_{nn}^r H_{tt}^r - H_{nt}^{r2}}, \quad \mathcal{C}_{3_c}^r = -\frac{H_{tt}^r (2H_{nt}^{r2} - H_{nn}^r H_{tt}^r)}{H_{nn}^r H_{tt}^r - H_{nt}^{r2}} \quad (16)$$

Then from equation (13), the first state law which gives the macroscopic stress tensor Σ can be obtained by derivation:

$$\Sigma = \frac{\partial \Psi}{\partial \mathbf{E}} = \mathbb{C}^{hom} : \mathbf{E} \quad (17)$$

as well as the second state law which provides the expression of the damage energy release rate F^{dr} :

$$F^{dr} = -\frac{\partial \Psi}{\partial d^r} = \mathbf{E} : (\mathcal{C}_1^r \mathbf{N}^r \otimes \mathbf{N}^r + \mathcal{C}_2^r [\mathbf{N}^r \otimes \mathbf{T}^r + \mathbf{T}^r \otimes \mathbf{N}^r] + \mathcal{C}_3^r \mathbf{T}^r \otimes \mathbf{T}^r) : \mathbf{E} \quad (18)$$

Both the homogenized stiffness tensor \mathbb{C}^{hom} and the damage energy release rate F^{dr} are then affected by the anisotropic properties of the solid matrix and depends on the orientation of the considered microcracks family. This is at the origin of the complex coupling between initial anisotropy and damage-induced one, as already discussed in Goidescu et al. (2013).

2.3 Damage yield function

Based on classical thermodynamics arguments in CDM, the following general form is adopted for the damage criterion corresponding to each family of microcracks:

$$f(F^{d^r}, d^r) = F^{d^r} - \mathcal{R}(d^r) = 0 \quad (19)$$

The function $\mathcal{R}(d^r)$ represents the resistance to the damage evolution by microcracks growth. It can be *a priori* determined from experimental investigations. For the sake of simplicity and following Marigo (1985) in the context of isotropic matrix, we consider an affine function in d^r :

$$\mathcal{R}(d^r) = c_0 + c_1 d^r \quad (20)$$

where $c_0(\psi)$ and c_1 are two model parameters which determine the initial damage threshold and damage evolution respectively and that can be identified from experimental data.

Owing to the definition of F^{d^r} in equation (18), the damage yield surface corresponding to $f(F^{d^r}, d^r) = 0$ is a conic and mainly depends on anisotropic properties of solid matrix through \mathbf{N}^r and \mathbf{T}^r tensors. For illustration purpose, let's consider an orthotropic medium defined by the following material parameters (which correspond to the material studied by Liao et al. (1997) and analysed in section 3): $E_1 = 60$ GPa, $E_2 = 27$ GPa, $G_{12} = 13$ GPa, $\nu_{12} = 0.22$, $\nu_{21} = 0.10$, and the damage yield surface parameters: $c_0 = 12$ kJ/m² and $c_1 = 10$ kJ/m² without any isotropic damage value ($d^r = 0$). E_1 denotes the elastic modulus in a direction parallel to orthotropy axis, while E_2 denotes the elastic modulus in the direction perpendicular to this axis. For instance, figure 2 presents the damage yield surface in the (E_{11}, E_{22}) , (E_{11}, E_{12}) and (E_{22}, E_{12}) strain spaces for one microcrack family orientation $\phi^r = 20^\circ$ (see Levasseur et al. (2013) for other microcrack family orientations). By definition, once the yield surface is reached, damage appears and can evolve. However, from figure 2, one can see that damage criterion is reached earlier for open cracks than for closed cracks characterizing more damaging capabilities in case of open cracks than in case of closed cracks. Furthermore, due to the conic definition of $f(F^{d^r}, d^r)$, it appears that the branch of the damage yield surface associated to open cracks presents a closed-shape, whereas the branch associated to closed cracks always presents an open-shape. This will have a strong incidence in material response that can significantly differ under tensile or compression loadings.

2.4 Damage evolution law and rate form of the constitutive model

For a given family of microcracks, the consistency condition, $\dot{f}^r = 0$, provides the damage evolution in the following form:

$$\dot{d}^r = \frac{1}{c_1} \dot{F}^{d^r} = \frac{2}{c_1} \mathbf{E} : \mathbb{B}^r : \dot{\mathbf{E}} \quad (21)$$

with

$$\mathbb{B}^r = \mathcal{C}_1^r \mathbf{N}^r \otimes \mathbf{N}^r + \mathcal{C}_2^r [\mathbf{N}^r \otimes \mathbf{T}^r + \mathbf{T}^r \otimes \mathbf{N}^r] + \mathcal{C}_3^r \mathbf{T}^r \otimes \mathbf{T}^r \quad (22)$$

And, by differentiating the macroscopic stress-strain relation given by (17), the macroscopic stress increment is expressed as:

$$\dot{\Sigma} = \mathbb{C}_t^{hom} : \dot{\mathbf{E}} = \left[\mathbb{C}^{hom} - \frac{1}{c_1} \mathbf{E} : \left(\sum_{r=1}^N \mathbb{B}^r \otimes \mathbb{B}^r \right) : \mathbf{E} \right] : \dot{\mathbf{E}} \quad (23)$$

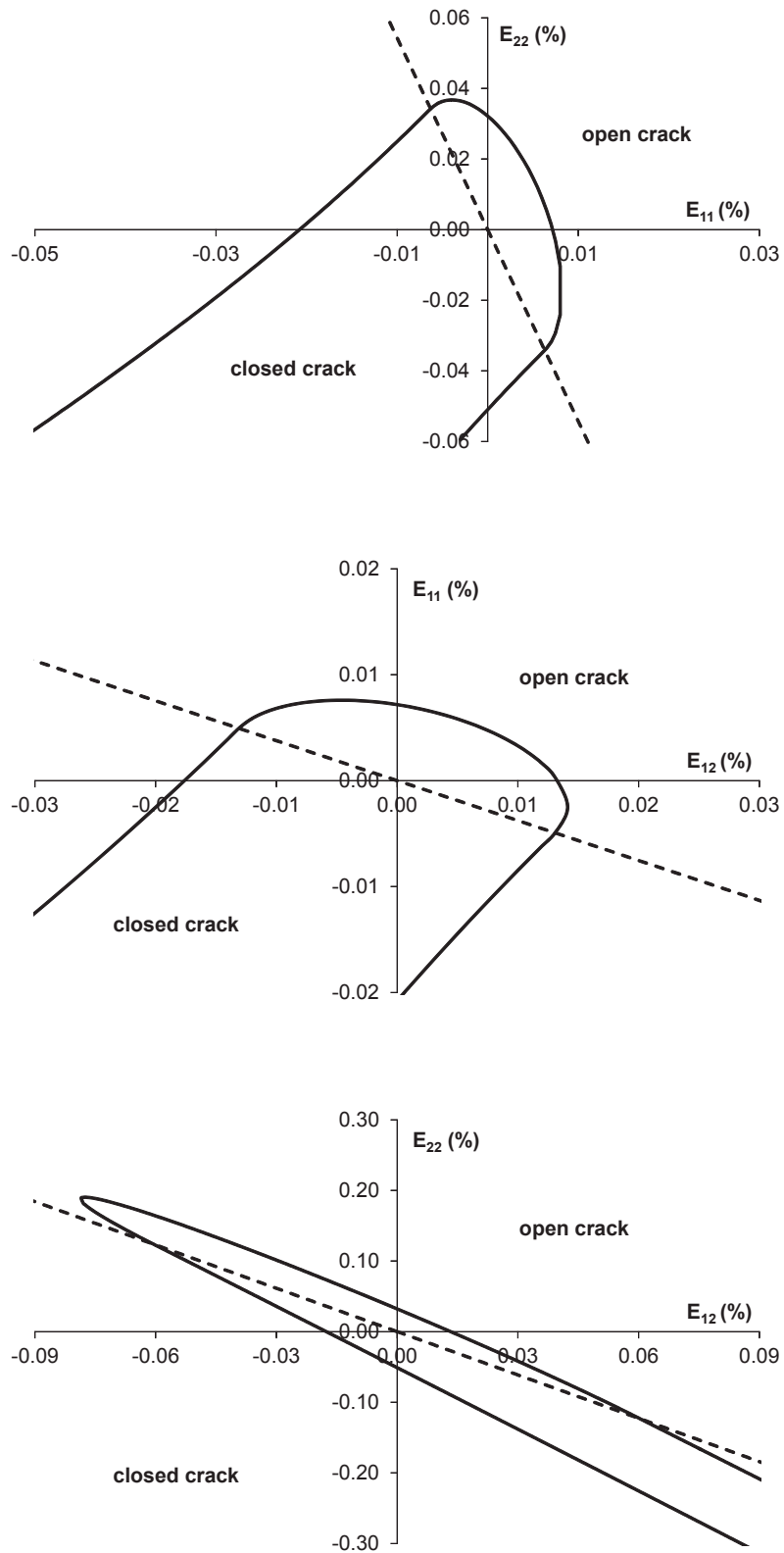

Fig. 2. Damage yield surface in the (E_{11}, E_{22}) , (E_{11}, E_{12}) and (E_{22}, E_{12}) spaces for a microcrack orientation $\phi^r=20$ (dashed lines determine the hypersurface separating the domain of open and closed microcrack)

3 APPLICATIONS

3.1 Simulation of uniaxial tensile test on argillite

To validate the damage model proposed in this paper, we consider uniaxial tensile tests carried out on a transversely isotropic argillite of Taiwan by Liao et al. (1997) for several anisotropy orientations from $\psi = 0^\circ$ to $\psi = 90^\circ$. Modelling is based on 2D plane strain approach schematized in figure 3. Owing to symmetry considerations, only one quarter of the sample is considered. Vertical displacements are locked on the bottom and horizontal displacements are locked on the left side. The tensile loading is applied on the top of the sample.

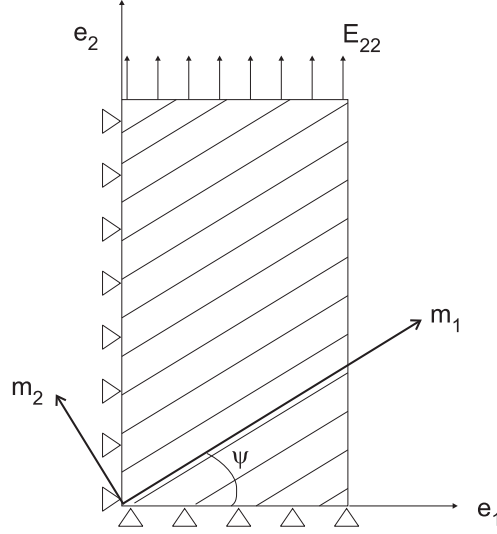

Fig. 3. Geometry of uniaxial tensile test in relation with anisotropy orientation ψ

The intact argillite behaviour is modelled as a linear transversely isotropic elastic material in the material axis (m_1, m_2) defined by means of ψ angle. The corresponding generalized Hooke's law takes the form:

$$\mathbf{E} = \mathbb{S}^s : \boldsymbol{\Sigma} \quad (24)$$

in which the matrix of components of $\mathbb{S}^s = \mathbb{C}^{s^{-1}}$ in Voigt notation is:

$$\mathbb{S}^s = \begin{pmatrix} \frac{1}{E_1} & -\frac{\nu_{21}}{E_2} & 0 \\ -\frac{\nu_{12}}{E_1} & \frac{1}{E_2} & 0 \\ 0 & 0 & \frac{1}{G_{12}} \end{pmatrix} \quad (25)$$

and E_1 and E_2 still denote the Young modulus in the two materials directions, G_{12} is the shear modulus and ν_{12} and ν_{21} are Poisson ratios verifying the symmetry: $\nu_{12}/E_1 = \nu_{21}/E_2$.

For the considered argillite, these parameters are estimated to: $E_1 = 60$ GPa, $E_2 = 27$ GPa, $\nu_{12} = 0.22$, $\nu_{21} = 0.10$, $G_{12} = 13$ GPa, assuming an initial isotropic damage value $d^r = 0.01$. Damage parameter c_1 of equation (20) has been calibrated to 10 kJ/m^2 whereas c_0 estimation seems to vary with anisotropy angle ψ as given in table 1. This evolution of c_0 with anisotropy angle ψ follows tensile strength variations (observed by Liao et al., see Levasseur et al. (2013)).

Table 1. Estimation of c_0 with anisotropy angle ψ

ψ ($^\circ$)	0	30	45	60	75	90
c_0 (kJ/m ²)	0.2	0.2	0.3	0.6	6	10

The results of this model calibration are shown in figure 4 for $\psi=0^\circ$, 45° , 60° and 90° (see Levasseur et al. (2013) for other anisotropy orientations). The stress-strain curves (Σ_{22} , E_{22}) are then well captured by the model and the evolutions of damage seems realistic. As observed in the laboratory tests on specimen with low inclination ψ , the predicted stress-strain curves exhibit apparent non linearity before failure; for specimen with high inclination ψ , the stress-strain curves are quasi-linear. These findings indicate that even in the theoretical approach, the influence of microcracks on the tensile behaviour decreases when the anisotropy angle ψ increases. For specimen with low inclination, damage appears gradually causing a more pronounced non linear behaviour of argillite. For specimen with high inclination, damage occurs more suddenly. Numerically, this corresponds to non convergence of the model because of the too strong and sudden damage levels which are reached.

Similarly to stress paths in elasto-plasticity theory, a "damage path" can be drawn in strain spaces: see for instance in Figure 5 "damage paths" in (E_{11} , E_{22}) space for one microcrack orientation $\phi=20^\circ$ and two anisotropy orientations $\psi=0^\circ$ (corresponding to a loading case along anisotropy axis) and $\psi=60^\circ$ (corresponding to a loading out of anisotropy axis). Figure 5 put in evidence that once strain state reaches damage criterion, the criterion evolves linearly with damage both in open and closed crack domains due to equation (20) and similarly in all directions. Then, final damage surface is homothetic to the initial one.

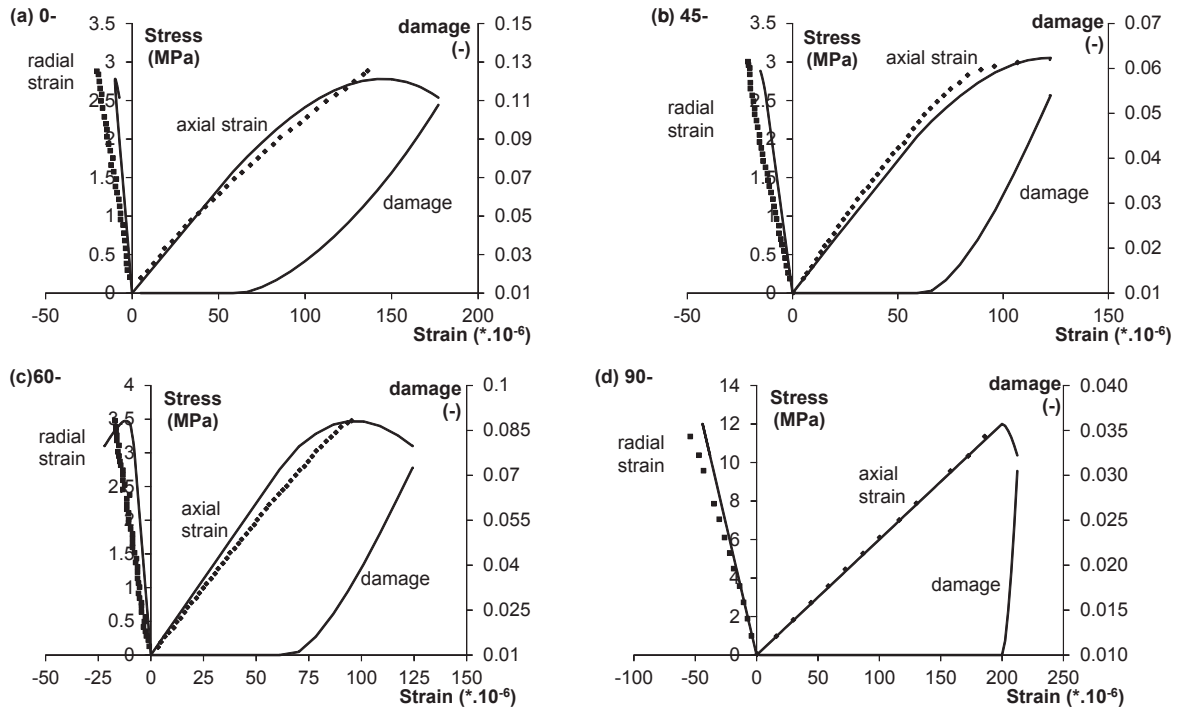

Fig. 4. Prediction of the stress-Strain curves and damage evolution as function of strain for 4 orthotropic axis orientations: 0° , 45° , 60° and 90° (symbols: lab measurements; full lines: numerical results)

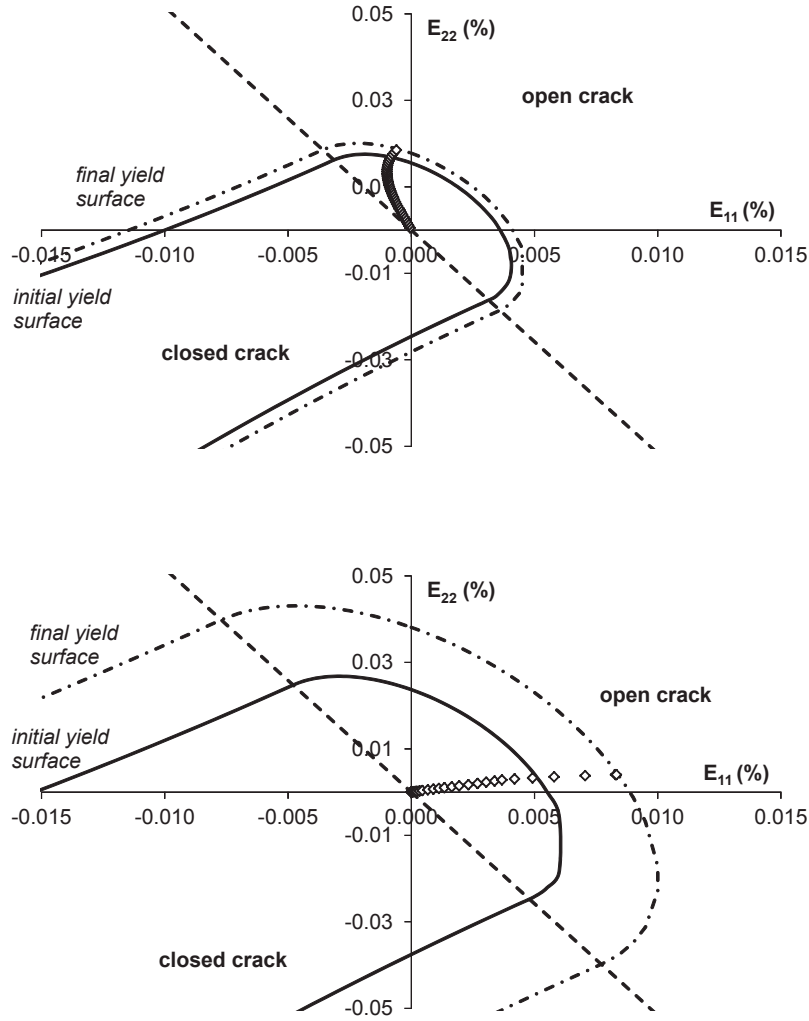

Fig. 5. Initial (full lines) and final (dash lines) damage yield surfaces $f(F^{d^r}, d^r)=0$ in (E_{11}, E_{22}) space for anisotropy orientations $\psi=0^\circ$ (top) and $\psi=60^\circ$ (bottom) for one crack orientation $\phi^r=20^\circ$ due to tensile loading represents by diamond symbols

The consequence of damage coupling with matrix anisotropy induces variations of homogenized tensor components with strain and anisotropy orientations. When damage occurs, moduli are degraded. However, because of a strong coupling between matrix anisotropy and damage induced anisotropy, these degradations differ from one direction to the others. In case of $\psi = 0^\circ$, loading direction corresponds to an anisotropy axis and then the weakest direction (along loading axis in this case) is more degraded than the hardest one (perpendicular to loading axis in this case). In case of $\psi = 60^\circ$, loading direction does not correspond to the anisotropy axis and the main degradation of Young modulus does not correspond to the initial weakest direction. Uniaxial tensile test still generates microcracks in horizontal directions even if anisotropy axis are oriented at 60° and then major modulus degradations result from a combined effect of matrix anisotropy and damage induced anisotropy.

3.2 Microcracks closure effect: tension-compression loading

The modelling of tensile loading followed by an unloading and reloading in compression allows to study unilateral effect by evaluating how progressive closure of open microcracks generated during the tension loading step affects the macroscopic material response during the compression phase. Figure 6 presents the stress-strain curve corresponding to the described loading path for anisotropy $\psi=0^\circ$. In the same figure, the evolution of overall damage variable with strain is given. The obtained stress-strain curve shows continuous response at the tension-compression transition when axial stress is equal to zero (corresponding to the opening/closure transition) despite the discontinuity of the macroscopic elastic properties. In fact, during tension-compression loading damage yield surface evolves as follows (see figure 7):

- As long as loading does not reach damage criteria, damage is constant and stress-strain relation is linear;
- When damage criterion is attained for a given family of microcracks, damage evolves providing on one hand the non linearity of stress-strain curve due to the degradation of stiffness tensor and on the other hand the growth of damage surface;
- During unloading phases, we leave the damage criteria and no more damage evolves since the damage criteria is reached once again during reloading phase.

The same kind of results is obtained whatever is the anisotropy orientation ψ .

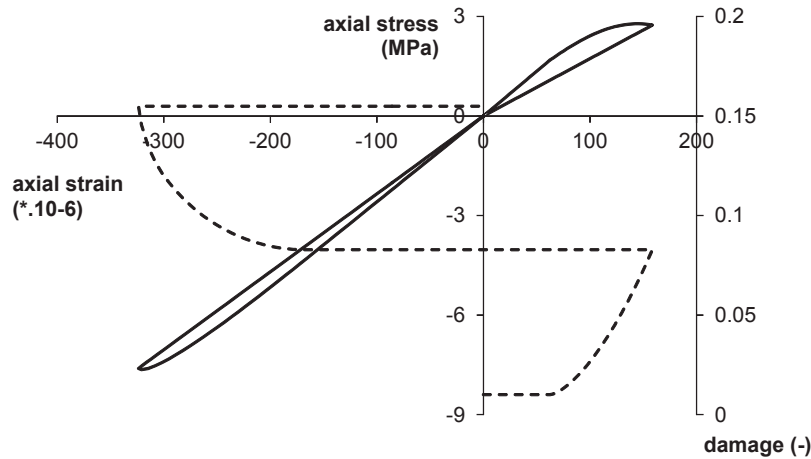

Fig. 6. Simulation of tensile loading followed by unloading and reloading in compression in the case of anisotropy orientation equals to 0 (full line: stress-strain curve; dashed line: damage evolution with strain)

4 CONCLUSION

Taking advantage of the recent study by Goidescu et al. (2013), this paper presents a full 2D anisotropic micromechanical damage model accounting for couplings between the damage-induced anisotropy and the solid matrix orthotropy and characterizing unilateral effect of evolving microcracks in transversely isotropic rocks. Applied to argillite, it is shown that the initial anisotropy of the rock strongly affects the damage criterion and evolving and subsequently the

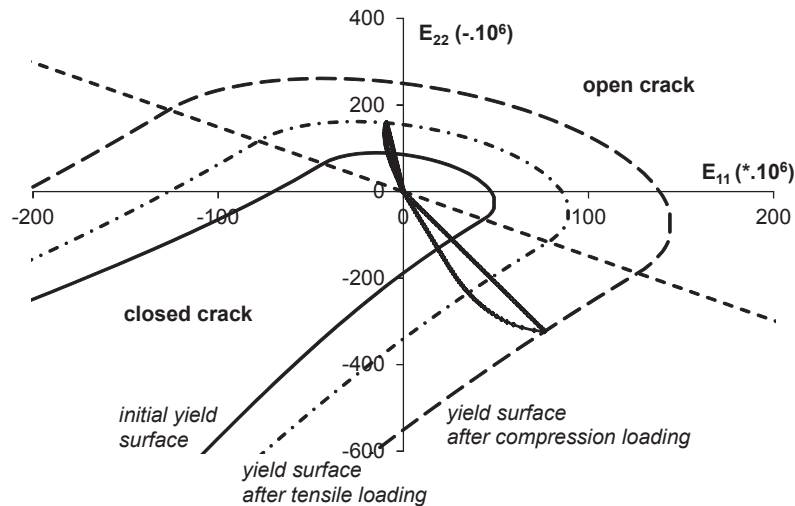

Fig. 7. Evolution of damage criteria $f(F^{d^r}, d^r)=0$ in (E_{11}, E_{22}) strain space for anisotropy orientation $\psi=0$ and for one crack orientation $\phi^r=45$ due to traction-compression loading represents by diamond symbols

macroscopic response of the material through the stiffness degradation. Furthermore, depending of the inclination of transversely isotropic properties of rocks, damage can occur gradually generating non linear behaviour of argillite, or more suddenly, causing quasi-linear behaviour as observed in the laboratory. Moreover, by a systematic analysis of damage criteria in strain spaces, an appropriate description of damage evolution process and of the opening/closure properties of microcracks is provided.

ACKNOWLEDGEMENTS

The authors would like to thank the F.R.S.-FNRS, the national funds of scientific research in Belgium, for their financial support in FRFC project.

REFERENCES

- Baste, S. (2001). Inelastic behaviour of ceramic-matrix composites. *Composites Science and Technology* 61, 2285–2297.
- Cazacu, O., Soare, S., & Kondo, D. (2007). On modeling the interaction between initial and damage-induced anisotropy in transversely isotropic solids. *Mathematics and Mechanics of Solids* 12(3), 305–318.
- Costanzo, F., Boyd, J., & Allen, D. (1996). Micromechanics and homogenization of inelastic composite materials with growing cracks. *Journal of the Mechanics and Physics of Solids* 44, 333–370.
- Goidescu, C., Weleman, H., Kondo, D., & Cruescu, C. (2013). Microcracks closure effects in initially orthotropic materials. *European J. of Mechanics, A/Solids* 37, 172–184.
- Halm, D. & Dragon, A. (1996). A model of anisotropic damage by mesocrack growth: unilateral effect. *Int. J. Damage Mech.* 5, 384–402.
- Ju, J. & Lee, X. (1991). Micromechanical damage model for brittle solids. Part 1: Tensile loading. Part 2: Compressive loading. *Mechanics of Materials* 117(7), 1495–1536.
- Kachanov, M. L. (1982). A microcrack model of rock inelasticity. Part 1: Frictional sliding on microcracks. Part 2: Propagation of microcracks. *Mechanics of Materials* 1, 19–41.

- Krajcinovic, D. (1996). *Damage mechanics*. North-Holland.
- Lemaitre, J. & Chaboche, J.-L. (1990). *Mechanics of Solid Materials*. Cambridge University Press.
- Levasseur, S., Collin, F., Charlier, R., & Kondo, D. (2011). A two scale anisotropic damage model accounting for initial stresses in microcracked materials. *Engineering Fracture Mechanics* 78, 1945–1956.
- Levasseur, S., Weleman, H., & Kondo, D. (2013). A microcrack-induced damage model accounting for unilateral effects: application to transversely isotropic rock. *submitted*.
- Liao, J., Yang, M., & Hsien, H. (1997). Direct tensile behavior of a transversely isotropic rock. *Int. J. Rock Mech. Min. Sci.* 34(5), 837–849.
- Marigo, J.-J. (1985). Modeling of brittle and fatigue damage for elastic material by growth of microvoids. *Eng Fract Mech* 21(4), 861–874.
- Monchiet, V., Gruescu, C., Cazacu, O., & Kondo, D. (2012). A micromechanical approach of crack-induced damage in orthotropic media: application to a brittle matrix composite. *Engineering Fracture Mechanics* 83, 40–53.
- Pensée, V., Kondo, D., & Dormieux, L. (2002). Micromechanical analysis of anisotropic damage in brittle materials. *J. Eng. Mech.* 128, 889–897.
- Zhu, Q., Kondo, D., Shao, J. F., & Pensée, V. (2008). Micromechanical coupling of anisotropic damage in brittle rocks and application. *Int. J. Rock Mech. Mining Sci.* 45, 467–477.