



HAL
open science

Impact of a backside Schottky contact on the thyristor characteristics at high temperature

Gaëtan Toulon, Abdelhakim Bourennane, Karine Isoird

► **To cite this version:**

Gaëtan Toulon, Abdelhakim Bourennane, Karine Isoird. Impact of a backside Schottky contact on the thyristor characteristics at high temperature. International Seminar on Power Semiconductors (ISPS 2012), Aug 2012, Pragues, Czech Republic. pp.131 à 136. hal-01004495

HAL Id: hal-01004495

<https://hal.science/hal-01004495>

Submitted on 11 Jun 2014

HAL is a multi-disciplinary open access archive for the deposit and dissemination of scientific research documents, whether they are published or not. The documents may come from teaching and research institutions in France or abroad, or from public or private research centers.

L'archive ouverte pluridisciplinaire **HAL**, est destinée au dépôt et à la diffusion de documents scientifiques de niveau recherche, publiés ou non, émanant des établissements d'enseignement et de recherche français ou étrangers, des laboratoires publics ou privés.

Impact of a backside Schottky contact on the thyristor characteristics at high temperature

G. Toulon^{1,2}, A. Bourennane^{1,3}, K. Isoird^{1,3},

¹ CNRS, LAAS, 7 avenue du colonel Roche, F-31400 Toulouse, France

² Univ de Toulouse, LAAS, F-31400 Toulouse, France

³ Univ de Toulouse, UPS, LAAS, F-31400 Toulouse, France

Abstract

In this paper, a thyristor structure presenting improved electrical characteristics at high temperature is analysed through 2D physical simulations. The replacement of the P emitter of a standard symmetrical thyristor by a judicious association of P diffusions and Schottky contacts at the anode side contributes to the reduction of the leakage current in the forward direction and hence improves the forward blocking voltage at high temperature. A fine-tune of the anode side configuration will improve the forward off-state behaviour with only a negligible on-state voltage drop degradation. Moreover, the comparison with the conventional anode short thyristor shows that the insertion of Schottky contacts leads to the same improvements that the anode short in terms of off-state characteristics, while keeping the reverse blocking capability.

Keywords: Pulsed power, High voltage thyristor, TCAD simulations, high temperature, Schottky contacts.

INTRODUCTION

In high voltage and high current applications, such as HVDC transmission [1] or pulsed power application [2], a thyristor is commonly used as a power switch because of its high switching power. However, the thyristor architecture composed of four layers of different doping forming an N-P-N and a P-N-P bipolar transistor limit its maximum operating temperature to 125°C. Under high operating temperature, the leakage current increases amplified by the transistor gains, leading to the parasitic turn-on of the thyristor.

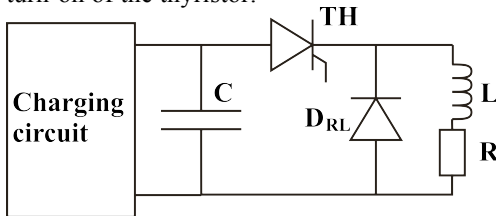

Figure 1: Example of a pulsed power circuit highlighting the thyristor role.

Moreover, the temperature induced high leakage current can degrade the functioning of the application in some cases. In pulsed power circuits, such as that shown in figure 1 [3], where a capacitor is charging while the thyristor is maintained in the off-state and is discharging through an R-L circuit when the thyristor is turned on. However, at high temperature when the thyristor leakage current becomes high, part of the current for the capacitor charging is deviated by the thyristor and flows through the R-L circuit, which results in increasing the time required for charging the capacitor.

Current gain reduction can be achieved by different ways, such as:

- Local electron or proton irradiation at the main junctions in order to reduce the carrier lifetimes [4]
- N-type buffer layer between the N-base and P emitter
- Anode short-circuits [5]

The two last methods lead to a degradation of the reverse blocking capability, which means that additional components, such as a diode connected in series with the thyristor, must be added.

Silicon carbide, thanks to its physical proprieties, could be considered. However, some technological issues still need to be solved, such as the reduction of basal plane dislocation density during thick epitaxial layers growth, which leads to a degradation of the carrier lifetime and then the increase of the on-state voltage drop, or the development of novel termination techniques for bi-directional blocking capability [6].

The thyristor leakage current at high temperature can also come from surface currents at the chip periphery [7]. Adequate edge termination and passivation techniques are then necessary [8] in order to minimize these currents which can represent a significant part of the total leakage current in the thyristor device.

Consequently, we propose a thyristor structure based on the utilization of an Schottky contacts associated to P diffusions at the backside of a symmetrical silicon thyristor as associated to its termination for symmetric blocking voltage as shown in figure 2. The Schottky contact on the thyristor anode side leads to a reduction of the emitter efficiency of the J_2 junction, similar to conventional anode shorts, while preserving the reverse blocking capability of the device. We study, by means of TCAD simulations, the impact of the insertion of Schottky contacts in the backside of a thyristor on its electrical characteristics.

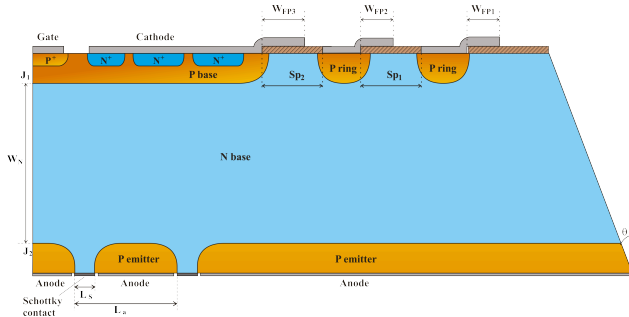

Figure 2: Overview of the thyristor structure with Schottky contacts on the anode side and both junction terminations for symmetrical blocking voltage.

THYRISTOR LEAKAGE CURRENT

The leakage current in a thyristor can be expressed by the following equation:

$$I_{AK} = \frac{I_{C0}}{1 - \alpha_{PNP} - \alpha_{NPN}} \quad (1)$$

Where I_{C0} is the leakage current of a PN junction in reverse conducting mode and α_{PNP} et α_{NPN} the gain of the bipolar transistors composing the thyristor shown in figure 2.

The thyristor leakage current reduction can be achieved by minimizing the different elements of equation 1. The leakage current I_{C0} depends on the N-base doping concentration which govern the breakdown voltage of the device. Cathode shorts, usually used in commercial thyristor, reduce the N-P-N current gain during forward blocking mode through the R_{Base} resistor (figure 2) linking the base and emitter of this transistor. The configuration of these cathode shorts [9] has an influence on the N-P-N transistor current gain, the gate triggering current, and the device dV/dt capability. The P-N-P transistor gain can be lowered by the different methods presented in the introduction. We present in this paper a solution based on an association of Schottky contact and P diffusions as used in the JBS (Junction Barrier Schottky) diodes [10] at the thyristor anode side, replacing the P emitter in the conventional thyristor.

SIMULATION RESULTS

Studied structures

Three symmetrical thyristor structures are studied: a conventional one, a thyristor with Schottky contacts at the backside (figure 3 (a)) and a conventional anode shorts thyristor (figure 3 (b)). This last structure is identical to the previous one, except that the backside electrode contacts an N+ diffusion instead of the N-base region. In order to achieve a symmetrical breakdown voltage, the N-base doping concentration is uniform and lightly doped in comparison with the P-type regions surrounding it. Cathode shorts are added for the reasons given previously.

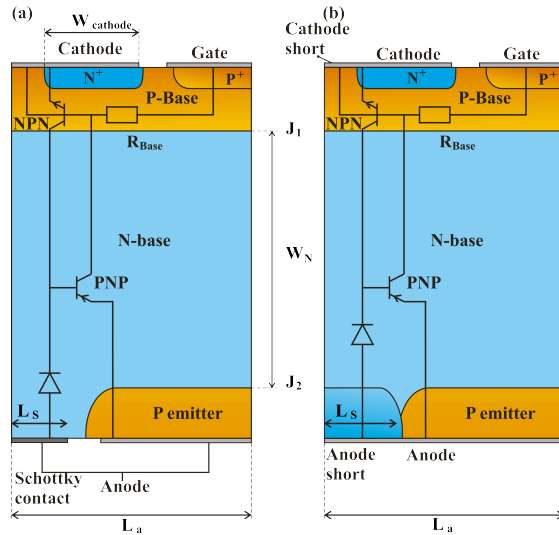

Figure 3: Schematic cross section of thyristor structures with (a) Schottky contact and (b) anode shorts.

Off-state

On figure 4 is represented the forward blocking voltage as a function of the N-base doping concentration and thickness for the three structures at the ambient temperature. For low values of the N-base doping concentration, the breakover voltage is limited by the reach-through of the base, leading to a reduction of the breakover voltage when lowering the doping concentration, while for high values, it is limited by the avalanche breakdown of the reverse biased J_1 junction, which means that the increase of the doping concentration reduces the breakover voltage value. Consequently, for a given N-base layer thickness, there is an optimum doping concentration which gives the highest breakover voltage. From the results on figure 4, at a fixed W_N value, the insertion of Schottky contacts or anode short leads to an increase of the maximum breakover voltage. As a result, for an achievable breakover voltage, the N-base layer thickness could be lowered compared to the case of a conventional thyristor, leading to a reduction of the on-state voltage.

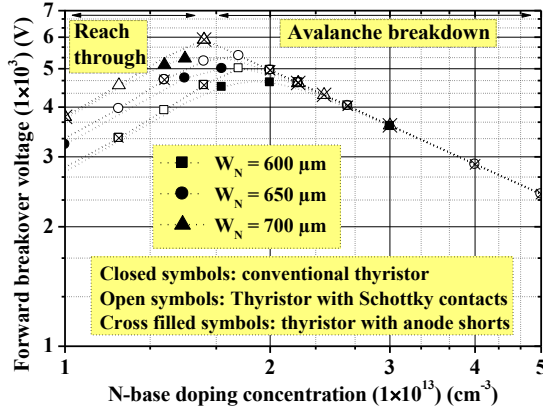

Figure 4: Influence of the N-base parameters on the forward breakover voltage at ambient temperature.

The leakage current in a Schottky contact can be high because of the barrier lowering effect under the presence of an electric field at the interface [11]. However, this degradation can be limited by a close spacing between two P diffusions, protecting the Schottky contact against excessive electric field values, as used in JBS diodes. This effect is illustrated on figure 5, where one can notice that the Schottky contact must be narrow in order not to degrade the reverse blocking electrical characteristics of the thyristor.

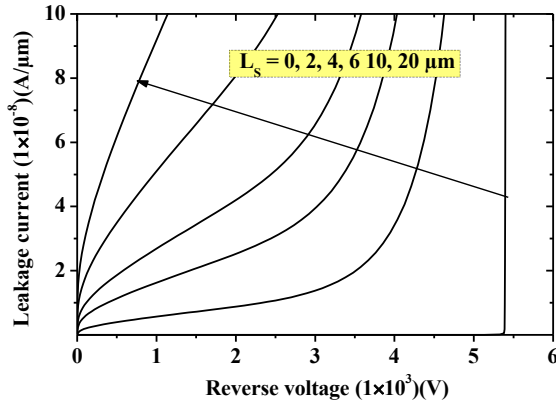

Figure 5: Influence of the Schottky contact width on the leakage current, the value $L_S = 0$ corresponding to a plane P-N junction.

On figure 6, the reverse characteristics of the thyristor with Schottky contacts and the conventional one are compared at different temperatures. The anode of the structure with Schottky contacts has been determined by considering the previous results. Both structures present the same breakdown voltage evolution with temperature, but the presence of the Schottky contact leads to an increase of the leakage current and a soft transition near the avalanche breakdown because of the barrier lowering effect.

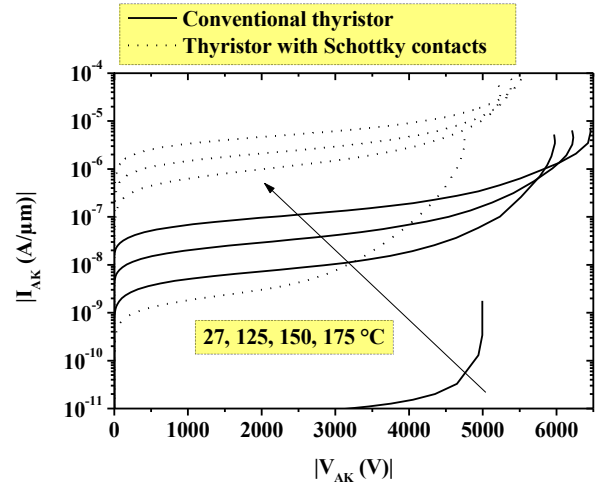

Figure 6: Influence of temperature on the reverse characteristics of the thyristor with Schottky contacts and the conventional one.

Figure 7 shows the evolution of the forward breakover voltage as a function of the temperature for the three structures. For every structure, the reduction of the N^+ cathode width (W_{cathode}) leads to an improvement of the forward breakover voltage at high temperatures. However, when reducing W_{cathode} , the minimum gate current necessary to turn-on the device increases, because of the P-base resistance R_{base} (figure 3) which is proportional to the N^+ cathode width, meaning that the current flowing through this resistor required to forward bias the P-N junction between P-base and N^+ will be high if the R_{base} is small.

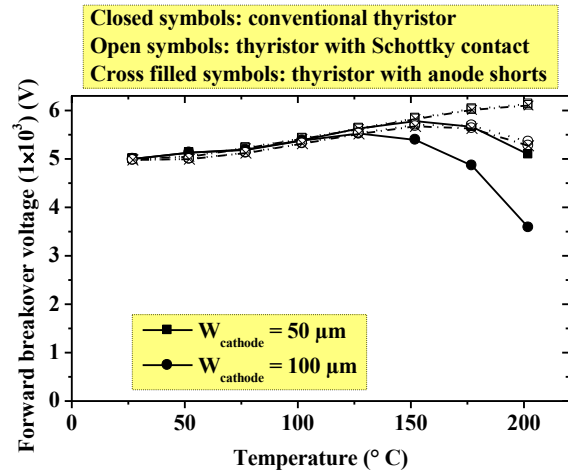

Figure 7: Temperature effect on the forward breakdown for different N^+ cathode widths.

For a fixed value of W_{cathode} , the insertion of Schottky contacts or anode short leads to a reduction of injection efficiency of the J_2 junction, because a part of the carriers are deviated through the Schottky contacts or the anode shorts. Consequently, these thyristor present a degradation of their breakover voltage at a higher temperature compared to a conventional thyristor. The evolution of the

breakover voltage with temperature of thyristors with Schottky contacts is identical to that of thyristors with anode shorts, that means that the Schottky contact has the same effect as that the anode short.

The forward blocking characteristics of the three structures is presented on figure 8. The lower leakage current in the thyristors with Schottky contacts and anode shorts as compared to the conventional thyristor case explain their improved off-state capability at high temperature.

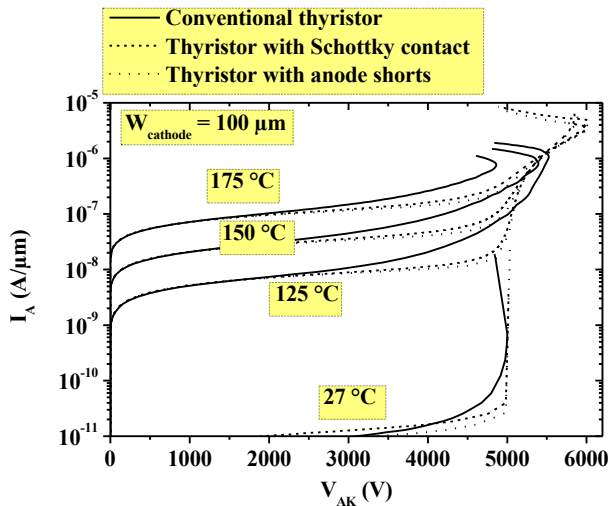

Figure 8: Forward blocking characteristics of the three structures for different temperatures.

Figure 9, representing the evolution of the breakover voltage as a function of the ratio of the Schottky contact width (L_s on figure 2) to the anode cell width (L_a on figure 2), shows that the increase of the Schottky contact width leads to a slight improvement in the breakover voltage. At high temperatures, where the improvement is more noticeable, the widening of the Schottky contact results in an increase of some hundred of volts.

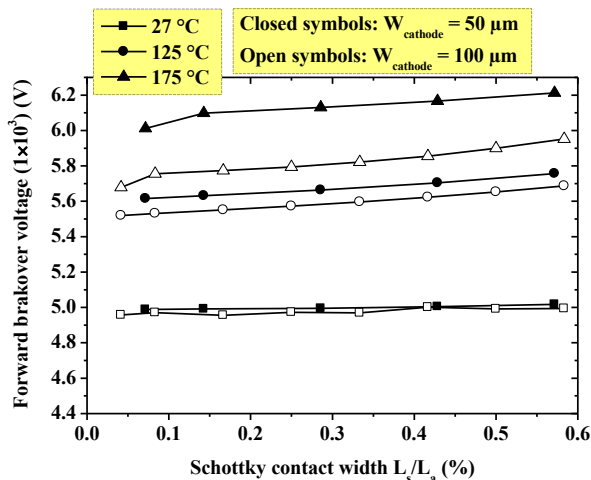

Figure 9: Breakover voltage as a function of the Schottky contact ratio on the anode width.

On-state

The on-state voltage drop of the three structures is represented on figure 10 for a current density of 200 A.cm^{-2} . The on-state voltage drop for the thyristors with Schottky contacts and anode shorts is represented as a function of the L_s to L_a ratio. When the L_s to L_a ratio increases, the P emitter width decreases, which leads to the reduction of the injection of carriers into the N-base region and consequently to an increase of the on-state voltage drop. This voltage drop increase with the L_s/L_a ratio is more pronounced in the case of thyristors with anode shorts. On the other hand, for larger P emitter, the on-state voltage drop tends to that of the conventional thyristor value.

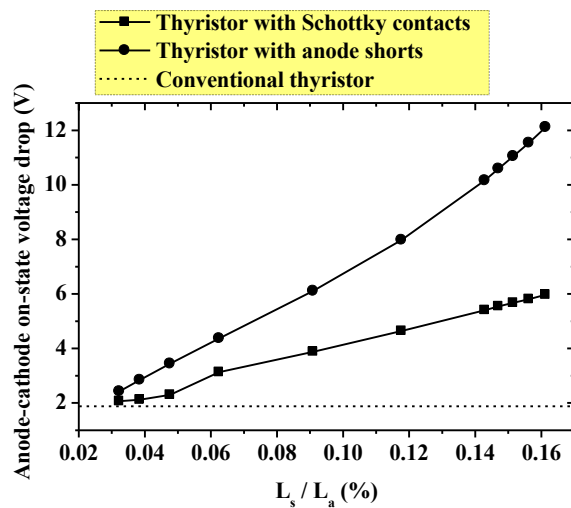

Figure 10: On-state voltage drop as a function of the Schottky contact ratio on the anode width for the three structures.

However, as described previously, the increase of the width of the Schottky contact compared to the P emitter leads to only a low improvement in the breakover voltage. Consequently, the Schottky contact surface should have to be maintained small compared to the P emitter one in order not to increase the conduction power losses.

DEVELOPMENT OF TERMINATIONS

Specific technological bricks for the symmetrical thyristors

Power devices can present premature breakdown if no adequate junction terminations are used. Symmetrical blocking devices present some issues in the reverse blocking state since standard planar terminations are not easy to adapt for the reverse blocking mode, because of the backside common electrode. In high voltage - high current rating thyristors, double bevel termination is

usually chosen because a device necessitates a large silicon area, then it can be mechanically processed prior to the thyristor process. Bevel terminations improve the breakdown voltage by reducing the electric field at the device edge. However the P-base region has to be deep and lightly doped in order to have efficient negative bevel terminations. Moreover, it has been experimentally demonstrated that negative bevel shows reduced breakdown voltage because of enhanced electric field in the bulk at the vicinity of the bevel surface [12]. For lower voltage devices (until 1200 V), the termination for reverse blocking can be realized by deep trenches [13] P+ filled and connected to a JTE (Junction Termination Extension) realized at the chip front side [14].

Forward blocking edge termination technique

In the forward blocking mode, the J_1 junction of the thyristor is reverse biased. In this case, a standard planar termination can be used. For the thyristor developed in this paper, field limiting ring associated with field plates were used. This termination does not require additional process steps, since the P-base mask can be used to define the P rings and the field plates can be realized with the cathode and gate metallization. Figure 11 shows an example of a termination using two floating rings at the end of the P base associated with their metallization.

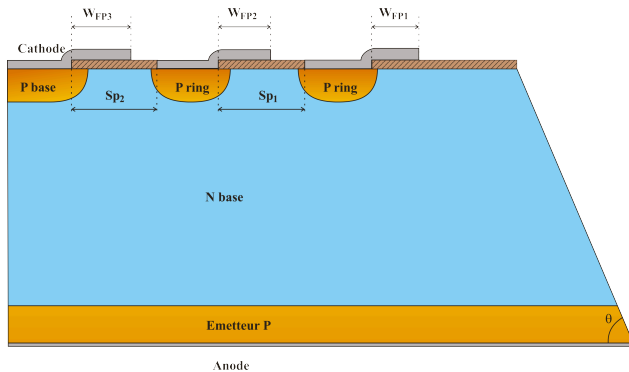

Figure 11: Schematic cross section of the terminations used for the symmetric breakdown voltage.

With 18 floating field rings with their field plate, it is possible to reach 4800V, corresponding to more than 95% of the breakdown voltage of the plane junction. Figure 12 represents the electrostatic potential of this termination at breakdown.

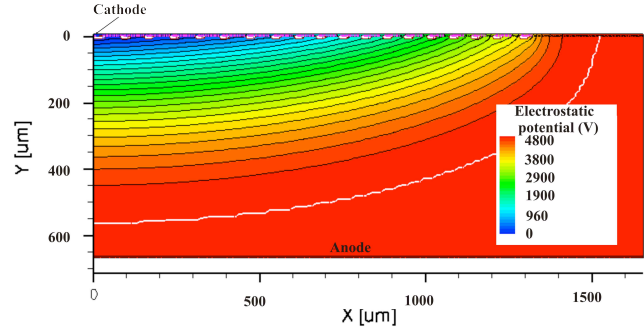

Figure 12: Electrostatic potential line contours at breakdown ($V_{DRM}=4800V$) of the termination used in the forward blocking direction, each line corresponding to a voltage variation of 200V.

Reverse blocking edge termination technique

A positive bevel termination appears to be the best protection for the reverse blocking mode. Moreover, similar realization of bevel edge by means of a wet etch has been reported [15] and it is also reported that it could be realized on several chips at the same time. The bevelled side of the chips is aligned to the crystallographic planes. On a (100) silicon wafer, the taper angle becomes 54.7° to the wafer surface (θ on figure 11) [15].

Due to the cut along an angle non perpendicular to the reverse biased PN junction, the missing part of charges in the N-base region due to the bevel must be compensated by an increase of the depletion width as seen on figure 13.

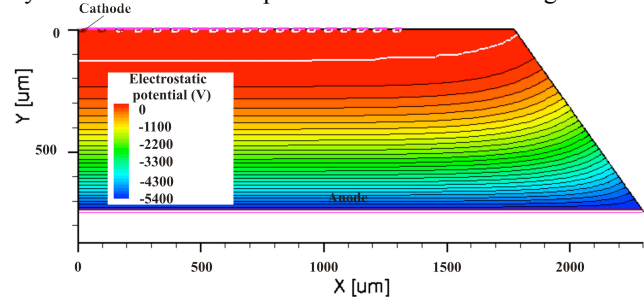

Figure 13: Electrostatic potential contour lines at breakdown ($V_{RRM}=5400V$) of the termination used for the reverse blocking direction, each line corresponding to a voltage variation of 200V.

The larger extension of the depletion width along the bevel will lead to a reduction of the electric field along the termination, as seen on figure 14, where the electric field along the bevel and perpendicular to the P-emitter/N-base junction is represented. The reduction of the electric field magnitude along the bevel ensure the breakdown in the bulk of the device and not in the termination.

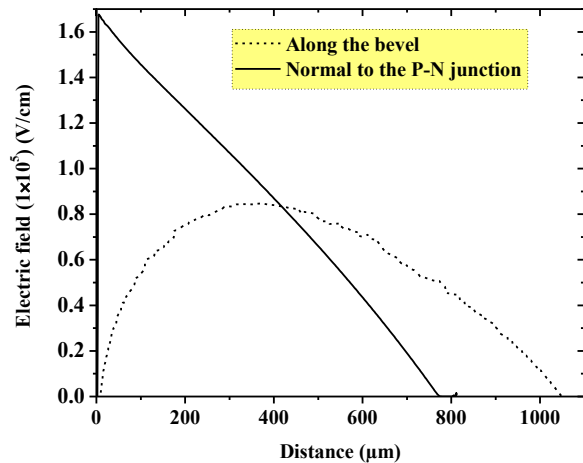

Figure 14: Electric field at breakdown in the reverse blocking direction in the bevel termination

CONCLUSION

In this paper, we studied the impact of the insertion of a Schottky contact on the backside of symmetric thyristor on its electrical characteristics. The simulation results showed that the thyristor with Schottky contacts could, with only a marginal degradation of the on-state voltage drop, highly improve the forward breakover voltage at high temperature thanks to the reduction of the leakage current. The improved performances is made possible with an optimized arrangement of the Schottky contacts. Thanks to the use of Schottky contacts, the proposed thyristor structure exhibits the same performance gain of the anode short thyristor at high temperature, while preserving the reverse blocking capability, as same as in the conventional thyristor structure. Moreover, in this paper, terminations for the symmetrical breakdown voltage has been proposed and some technological elements have been discussed for their realization. All of the simulation results would be validated with experimental realization.

REFERENCES

[1] H. Peter Lips: Technology Trends for HVDC thyristor Valves, POWERCON, 1998, pp 451-455.
 [2] E. Spahn, G. Buderer, J. Wey, V. Wegner, F. Jamet: The use of Thyristors as Main Switches in EML Applications, IEEE Trans. On Magnetics, Vol. 29 (1), 1993, pp 1060-1065.

[3] S. Scharnholtz, V. Brommer, V. Zornigebel, A. Welleman, E. Spahn: Performance study of a novel 13.5 kV multichip thyristor switch », PPC'09. 2009, pp 679-682.

[4] T. Nakagawa, K. Satoh, M. Yamamoto, K. Hirasawa, K. Ohta: 8kV/3.6kA Light Triggered Thyristor, ISPSD'95, 1995, pp 175-180.

[5] R. A. Kokosa, B. R. Tuft: A High-Voltage, High-Temperature Reverse Conducting Thyristor, IEEE Trans. Electron Devices, Vol 17 (9), 1970, pp 667-672.

[6] Q. Zhang et al.: SiC super GTO thyristor for technology development: Present status and future perspective, PPC'11, 2011, pp 1530-1535.

[7] V. V. N. Obreja, C. Codreanu, C. Podaru, K. I. Nuttall, O. Buiu: The Operation Temperature of Silicon Power Thyristors and the Blocking Leakage Current, IEEE Power Electronics Specialists Conf. 2004, pp 2990-2993

[8] V. V. N. Obreja, K. I. Nuttall: On the High Temperature Operation of High Voltage Power Devices, ESSDERC 2002, pp 1-4.

[9] A. Munoz-Yague, P. Leturcq: Optimum Design of Thyristor Gate-Emitter Geometry, Trans. Electron Devices, Vol 23 (8) 1976, pp 917-924.

[10] B. J. Baliga: The Pinch Rectifier: A Low-Forward-Drop High-Speed Power Diode, IEEE Electron Device Letters, Vol. 5 (6), 1984, pp 194-196

[11] F. Lanois, F. Morancho: Caractéristiques électriques simulées et expérimentales de composants Schottky en tranchées, EPF 2004, pp 1-4.

[12] M.S. Adler and V.A.K. Temple: A General Method for Predicting the Avalanche Breakdown Voltage of Negative Beveled Devices, IEEE Trans. Electron Devices, Vol. 23, 1976, pp. 956-960.

[13] N. Tokuda, M. Kaneda, T. Minato: A ultra-small isolation area for 600V class Reverse Blocking IGBT with Deep Trench Isolation process (TI-RB-IGBT), ISPSD'04, 2004, pp 129-132.

[14] O. Causse, P. Austin, J. L. Sanchez,: A new peripheral planar structure allowing a symmetrical blocking voltage, CAS'99, 1999, pp 59-62.

[15] K. Shimoyama et al.: A new isolation technique for reverse blocking IGBT with ion implantation and laser annealing to tapered chip edge sidewalls, ISPSD'06, 2006, pp 1-4.