



HAL
open science

Modelling of immune response to a respiratory virus targeting pulmonary macrophages : exploration of the host susceptibility and viral virulence.

Natacha Go, Caroline C. Bidot, Catherine C. Belloc, Suzanne Touzeau

► **To cite this version:**

Natacha Go, Caroline C. Bidot, Catherine C. Belloc, Suzanne Touzeau. Modelling of immune response to a respiratory virus targeting pulmonary macrophages : exploration of the host susceptibility and viral virulence.. SBIP 2013: Systems Biology Approach to Infectious Processes, May 2013, Lyon, France. 16 diapos. <hal-01000672>

HAL Id: hal-01000672

<https://hal.science/hal-01000672v1>

Submitted on 6 Jun 2020

HAL is a multi-disciplinary open access archive for the deposit and dissemination of scientific research documents, whether they are published or not. The documents may come from teaching and research institutions in France or abroad, or from public or private research centers.

L'archive ouverte pluridisciplinaire **HAL**, est destinée au dépôt et à la diffusion de documents scientifiques de niveau recherche, publiés ou non, émanant des établissements d'enseignement et de recherche français ou étrangers, des laboratoires publics ou privés.



HAL Authorization

SBIP 2013 — *Systems Biology Approach to Infectious Processes.*

Lyon, May 13-15th 2013

MODELLING OF IMMUNE RESPONSE TO A RESPIRATORY VIRUS TARGETING PULMONARY MACROPHAGES: EXPLORATION OF THE SUSCEPTIBILITY AND VIRULENCE

Natacha GO^{1,2}, Caroline BIDOT¹, Catherine BELLOC², Suzanne TOUZEAU^{3,4}

1. UR341 MIA, INRA, F-78350 Jouy-en-Josas, France

2. UMR1300 BioEpAR, Oniris / INRA, F-44307 Nantes, France

3. UMR1351 ISA, INRA, F-06900 Sophia-Antipolis, France

4. Biocore, Inria, F-06900 Sophia-Antipolis, France

INTRODUCTION

- **Background:** control of respiratory infections
- **Needs:** better understanding of immune dynamics
- **Focus:** virus targeting pulmonary macrophages
 - ★ phagocytosing vs infected status
 - ★ alteration of the immune dynamics
- **Hypothesis:** macrophage – virus interactions are determining for the infection outcome.
- **Application:** PRRSV = porcine virus targetting pulomary macrophages

⇒ **MODELLING APPROACH** to explore the immune response to PRRSV and its variability

STEPS

Basic model

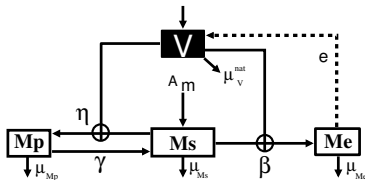

Model development

- Cytokine syntheses and regulations
- Adaptive response

⇒ Complex model with 18 state variables and 300 parameters

Limits: lack of data → model calibration very difficult

Model simplifications

CONCEPTUAL MODEL

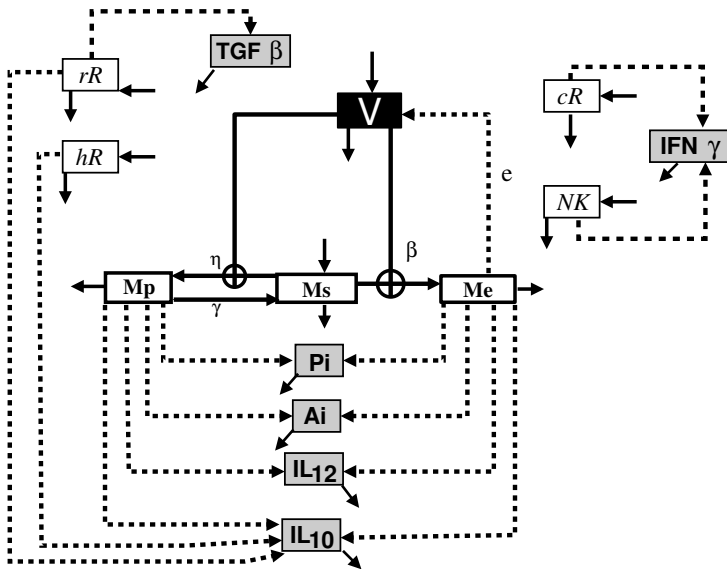

MODEL FORMALISATION

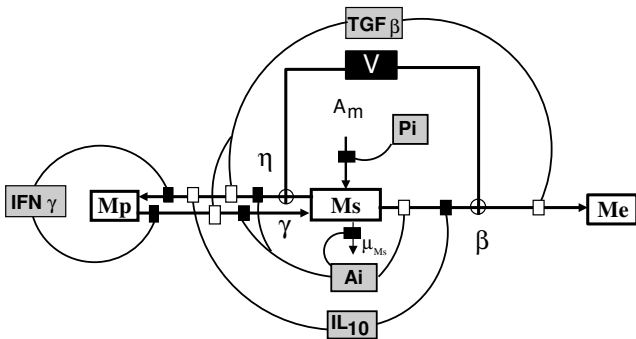

MODEL FORMALISATION

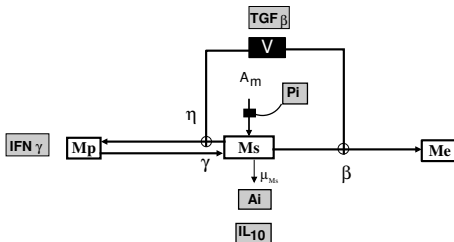

$$\dot{M}_S = A_m \left(1 + \frac{v_m P_i}{k_m + P_i} \right)$$

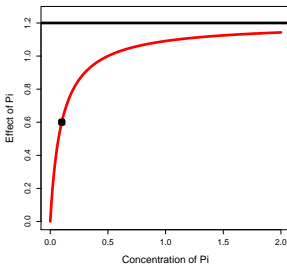

MODEL FORMALISATION

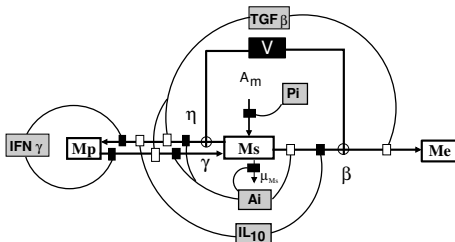

$$\dot{M}_S = A_m \left(1 + \frac{v_m P_i}{k_m + P_i} \right) - \eta M_S V \frac{k_m}{k_m + L_{10} + T_\beta} \left(1 + \frac{v_m (A_i + I_\gamma)}{k_m + A_i + I_\gamma} \right)$$

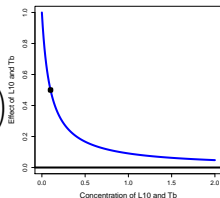

MODEL FORMALISATION

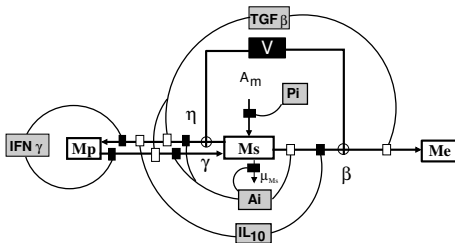

$$\begin{aligned} \dot{M}_s = & A_m \left(1 + \frac{v_m P_i}{k_m + P_i} \right) \\ & - \eta M_s V \frac{k_m}{k_m + L_{10} + T_\beta} \left(1 + \frac{v_m (A_i + I_\gamma)}{k_m + A_i + I_\gamma} \right) \\ & + \gamma M_p \frac{k_m}{k_m + L_{10}} \left(1 + \frac{v_m (A_i + I_\gamma)}{k_m + A_i + I_\gamma} \right) \\ & - \beta M_s V \frac{k_m}{k_m + A_i + I_\gamma + T_\beta} \left(1 + \frac{v_m L_{10}}{k_m + L_{10}} \right) \\ & - M_s \left(\mu_M^{\text{nat}} + \mu_M^{\text{inf}} \frac{A_i}{k_m + A_i} \right) \end{aligned}$$

Model

- Deterministic mathematical model of 14 ODE and 30 parameters
- Highly complex and non-linear

Data

- **Experimental studies on PRRSV:**

- ★ Viral dynamic in the blood and lung
- ★ Immune dynamic in the lung: insufficient data

⇒ Calibration on viral dynamic output, consideration of the variability and uncertainty.

- **Modelling studies**

- ★ 1 conceptual model of PRRSV infection
- ★ Many models of Influenza and Tuberculosis infection

⇒ Setting of large variation range of parameters which need to be refine

METHOD

– Exploration of the large range

- ★ Definition of a **fractional factorial design** (PLANOR library of R)
 - 4096 parameter value combinations
- ★ Model simulations → many viral dynamics

A unique inoculation V_0 at T_0

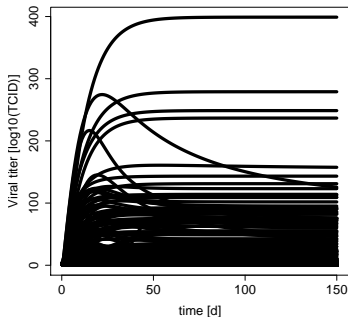

METHOD

- Exploration of the large range
- Selection of parameter values

Inventory of published data



Synthesis and summary in 5 aggregated variables

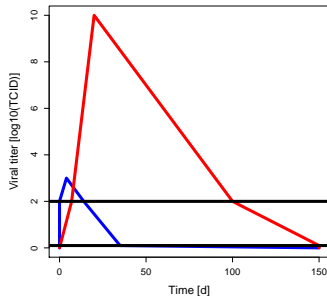
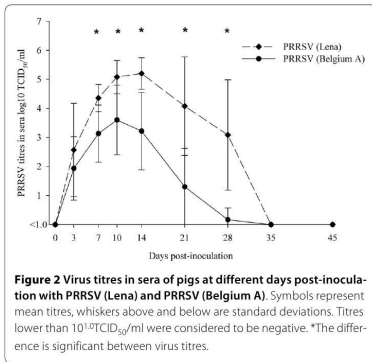

Karniychuk *et al.* BMC Veterinary Research

2010, 6:30

Peak beginning, Peak date, Viral titer at peak,
Peak ending, Resolution Date

METHOD

- **Exploration of the large range**
- **Selection of parameter values**
 - ★ Definition of the variation range for each criterion representing the variability & uncertainties
 - ★ Identification of the parameter combinations resulting in simulations which comply each criterion

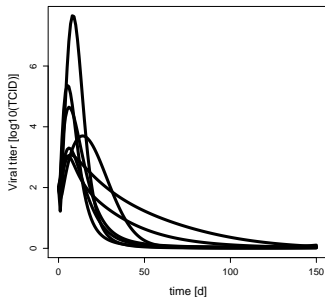
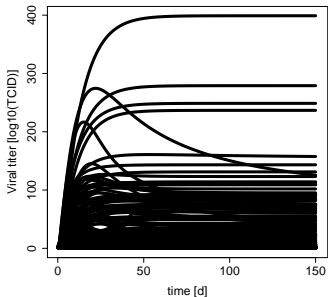

METHOD

- **Exploration of the large value range**
- **Selection of parameter values**
- **Model robustness** (first approach)
 - ★ Selection of 5 combinations corresponding to contrasted dynamics
 - ★ Definition of 5 designs with a 10% variation
 - ★ Model simulations ($5 \times 2187 = 10935$)

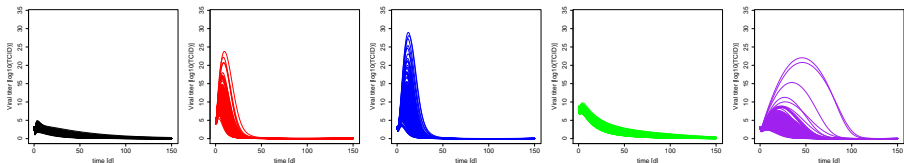

- ★ Multivariate sensitivity analysis of the parameter influence on criteria variance

SENSITIVITY ANALYSIS

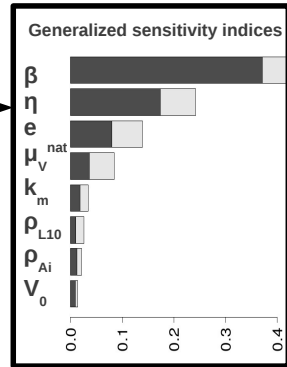
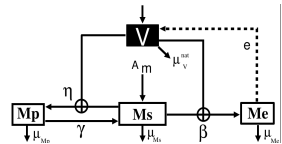
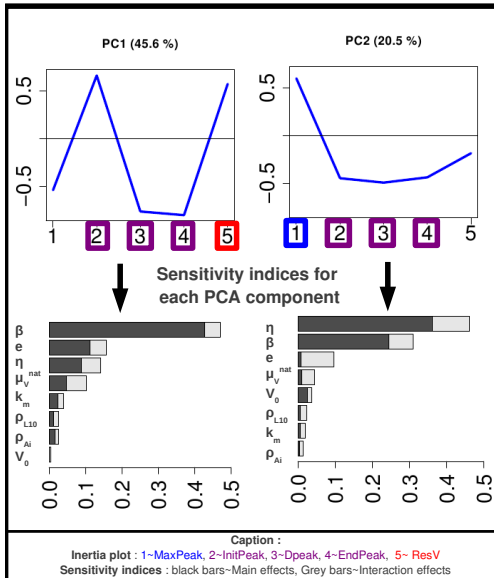

IMMUNE DYNAMICS

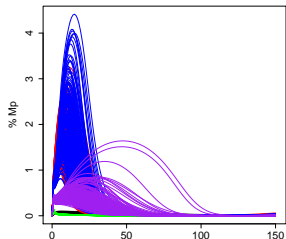
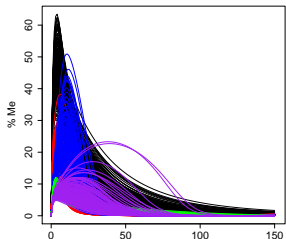
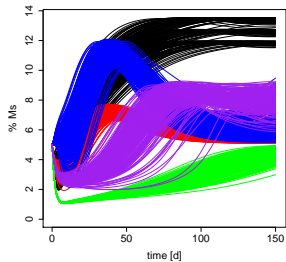
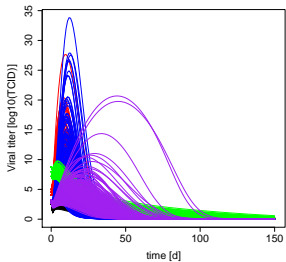

CONCLUSION

Model

- Original model centred on the macrophage – virus interactions
- Simplified representation able to reproduce realistic viral dynamic
- Framework to explore the innate mechanisms for respiratory infections

Calibration

- Method allowing to calibrate the model despite the lack of data
- Consideration of the uncertainties and variability
- **Improvements:** Better exploration of the parameter space & consideration of the immune dynamics

Perspective

- Model use to explore the innate response & test control measures
- Model extension to represent the infection dynamic for whole pig