

UWB short range radar for road applications

L. Sakkila*, C. Tatkeu**, A. Rivenq*, Y. El Hillali*, J-M. Rouvaen*

* Univ Lille Nord de France, F-59000 Lille, IEMN/DOAE, BP 311 le Mont-Houy, Valenciennes, France

** Univ Lille Nord de France, F-59000 Lille, IFSTTAR, LEOST, F-59650 Villeneuve d'Ascq

Corresponding author. E-mail:laila.sakkila@gmail.com

Abstract

In this paper, a short range radar system based on UWB -Ultra-Wide-Band- technology for road safety application is presented. During a long time, the radar and its applications were reserved to national defence, air security domains or weather services. Since a few years, with the emergence of new technologies, the radar applications are being extended to many sectors of daily life. UWB -Ultra Wide Band- is a new radio technique based on the emission of very short non-sinusoidal pulses duration, that have, typically, widths less than 1.5 ns, so that the spectrum of the emitted signals may spread over several Gigahertz [1]. All exiting studies on UWB radar concerns essentially medical and military applications [2] and only some studies were interested in UWB radar, for the obstacles detection, such as mines detection, detection of the heart wall movements by medical imagery or the monitoring through the walls for military operations [3].

In this paper, we propose to exploit the UWB technology for road radar application, in order to profit from its inherent advantages such as good range resolution, low power consumption, low price etc. The radar system proposed, offers a resolution in distance of about 15 cm for a pulse width of 1 ns, making this system very interesting in several short range applications. The originality of this radar is its capacity to detect easily, various obstacles. So, this paper describes the proposed radar and presents an interesting study of the adapted UWB waveforms that allow detection of different kind of obstacles in short ranges with a good resolution.

Keywords: Road safety, radar, Ultra Wide Band, waveform, obstacle

1. Introduction

In recent years, in order to increase the road safety, the perception of the vehicle environment has aroused much interest. It is based on the perception organs of which it is equipped. To perform this perception, the system proposed in our application exploits a new radio frequency technology called UWB -Ultra Wide Band-, referenced as baseband, carrier-free or impulse radio [4]. It has been used by the U.S Department of Defence in radar applications, because of the wideband nature of the signal [5].

UWB radar has many applications which will appear more and more in our daily life: in Medical, Building, Surveillance, Security and Monitoring applications [6]. For example, UWB radar systems for local monitoring allow creating dome radar surveillance around a sensitive object or subject. These compact systems contain small UWB radar with a range of about ten meters, a standard radio system for transmitting the alarm in case of intrusion and a GPS system for applications specific tasks. These systems can be engaged in

public safety functions in buildings, aircrafts or for artwork protection in a museum, but also as an alarm system around a house or near a swimming pool to avoid too frequent small children drowning. UWB radar could be used as GPR - Ground Penetrating Radar systems that can obtain very precise and detailed images sub-soil. UWB radar is moved along surface and sends electromagnetic pulses into the ground. The analysis of received echoes can produce a very specific profile of underground. The investigation depth varies, depending on the type of ground, from a few meters in asphalt or clay to more than a hundred meters in limestone or granite, or even several kilometers into the ice. Finally, UWB radar could be used for short range collision avoidance as mentioned in this paper.

This collision avoidance system, 24 GHz UWB SRR -Short Range Radar-, was developed principally by European car manufacturers. It is a combination of UWB radar and a conventional Doppler radar to measure their speeds and detect obstacles with a resolution in distance between 10

cm and 30 m. These systems are placed at the front and sides of the vehicle and warn the driver of potential impacts with other vehicles or pedestrians. They are also useful as a help for parking. Current systems warn the driver of a potential danger without intervening in the braking system. This system should allow a reduction in traffic accidents as the standard rear collisions often due to inattention, so it is estimated 88% of these collisions could be avoided [7].

2. The UWB technology

UWB technology was developed in the Eighties. It is a technology which relies on the principle of spreading out of spectrum with direct emission/reception without sinusoidal carrier. The principle of UWB technology is based on the use of base-band pulses.

These pulses have typical widths of less than 1.5 ns and thus bandwidths over 1 GHz. This technique, as defined by the Federal Communication Commission (FCC) [8], has a Fractional Bandwidth (FB) greater than 25%, the fractional bandwidth being defined as:

$$FB = \frac{\text{signal bandwidth}}{\text{center frequency}} = 2 * \frac{f_h - f_l}{f_h + f_l} * 100 \quad (1)$$

Where f_h and f_l represent respectively the highest and the lowest frequencies which are 10 dB below the maximum.

The key value of UWB is that its Radio Frequency (RF) bandwidth is significantly wider than the information bandwidth.

On one hand, the advantages of UWB technology are:

- Its exceptional multipath immunity.
- Its relative simplicity and likely lower cost to build than spread spectrum radios.
- Its substantially low consumed power, lower than existing conventional radios.
- Its implementation as a simple integrated circuit chipset with very few off-chip parts.
- Its high bandwidth capacity and multi-channel performance.
- Its high data rates for wireless communications.

On another hand, UWB gives an aggregated power of 0.26 mW, to be compared to 30 to 100mW for 802.11b radio and 1 to 1000 mW for Bluetooth radio [9], [10].

This technology is also named the Wireless world "contortionist". So, UWB pulses, thousand times shorter than those in traditional radar, allow the development of UWB radars, giving a precision and a resolution clearly better than the traditional systems. Nevertheless, legal limitations for power (< 1 mW), which prevent interferences with the existing radio systems, limit their range to a few tens of meters.

3. The UWB radar

The objective of this study is to use the advantages of UWB technology for the benefit of a radar system. This UWB radar presents good performances. Firstly the brevity of the pulses with strong spectral contents makes it possible to measure a very rich information transitory response of the target and to dissociate the various echoes at the reception stage. Then the broad spectrum authorizes to obtain the results on the entire frequency band in a single measurement together with a strong capacity of detection. Finally the pulse spectrum supports the penetration of the wave through the natural screens such as ground, vegetation, etc.

Considering all these properties, UWB radar, using very short pulses, is of great interest for obstacle detection and target identification in the short range. UWB radar sends very short electromagnetic pulses. This type of radar can employ traditional UWB waveforms. To calculate the distance between radar and obstacle, we measure the time delay Δt between emission and reception (figure 1). This distance is given by following equation (2):

$$d = \frac{c \cdot \Delta t}{2} \quad (2)$$

Where c is the light speed

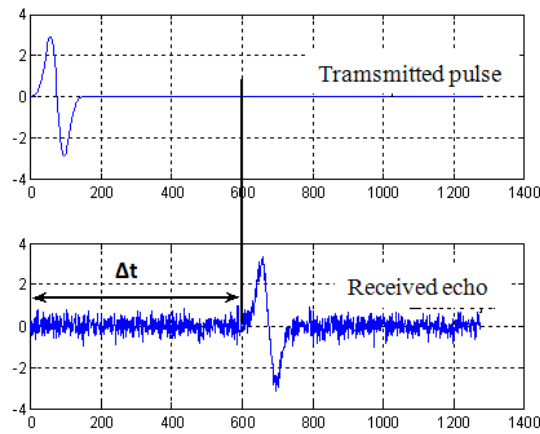

Figure 1: Time delay between the sent and received echo

This radar offers a resolution in distance of about 15 cm for a width pulse of 1ns, for that this system is very interesting for road safety applications.

The UWB radar structure is presented in figure 2. The pulse leaving the generator is transmitted using the transmitter antenna. After reflexion on the obstacle, the received signal echo is correlated with the reference pulse, in order to detect the peak, by using the threshold detection method

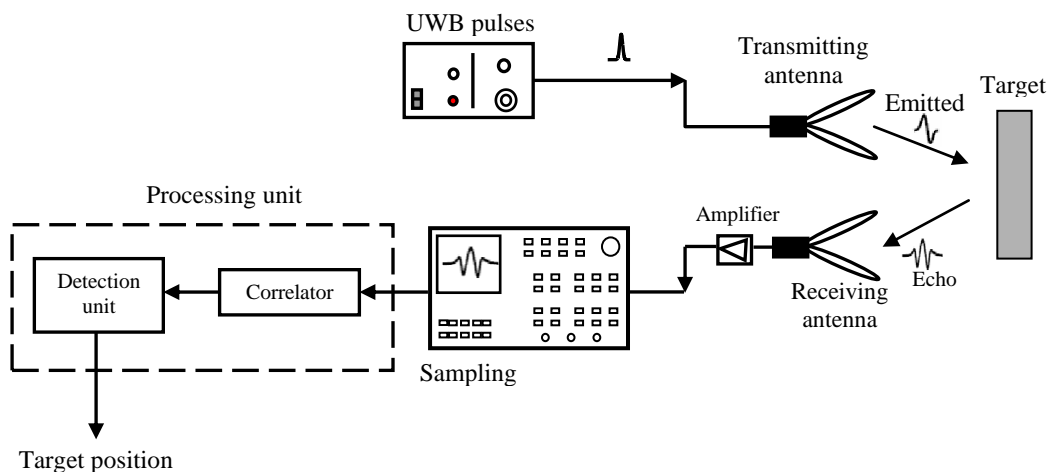

Figure 2: The radar based on UWB pulses.

The main problem encountered with UWB technology is the choice of the appropriate waveform according to the application considered. In fact, each waveform gives a specific cross-correlation function and the obtained peaks of this function must be easily detectable at the receiver. In the following paragraph, we present different UWB waveforms.

4. The UWB waveforms

UWB radar sends electromagnetic pulses. This type of radar uses traditional UWB waveforms, appearing as ultra short pulses, about one nanosecond in duration, so they cover a very great part of the frequency spectrum. Several waveforms

can be used, like Gaussian pulses, monocycle pulses or waveforms based on orthogonal polynomials [4], like Hermite and Gegenbauer functions [11].

4.1 Gaussian pulse

The Gaussian pulse is a pulse that has a waveform described by the Gaussian distribution.

In the time domain, the expression of the Gaussian pulse waveform is given by equation (3) [12]:

$$g(t) = A \exp[-(t/\sigma)^2] \quad (3)$$

Where A stands for the maximum amplitude and σ for the width of the Gaussian pulse. The

corresponding time representation and spectral representations are given in figure 3 with a sampling

frequency of 20 GHz/Samples.

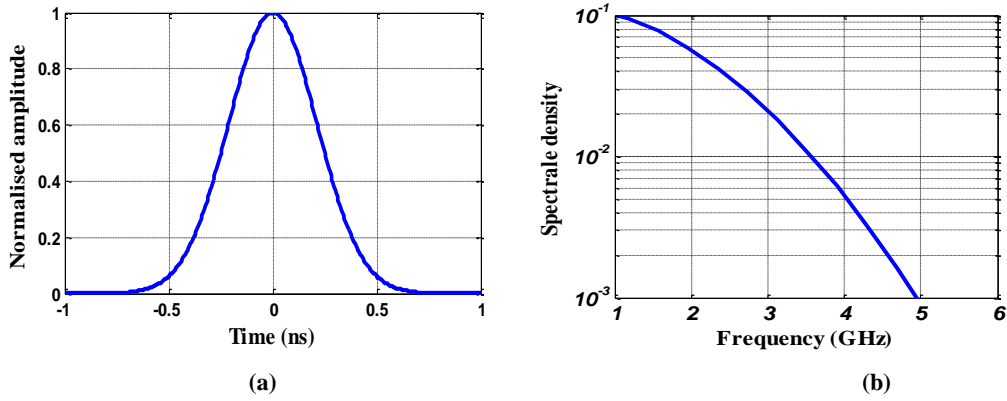

Figure 3: Gaussian pulse – time (a) and spectrum (b) representations.

4.2 Monocycle pulse

The monocycle pulse is the first derivative of the Gaussian pulse. The expression for the monocycle pulse waveform is written as [13] and is given by equation (4):

$$m(t) = K \frac{-2t}{\tau^2} \exp[-(t/\tau)^2] \quad (4)$$

Where K stands for the amplitude and τ is the pulse width (the centre frequency is then proportional to $1/\tau$).

The time and spectral representations are given in figure 4 with a sampling frequency of 20 GHz/Samples.

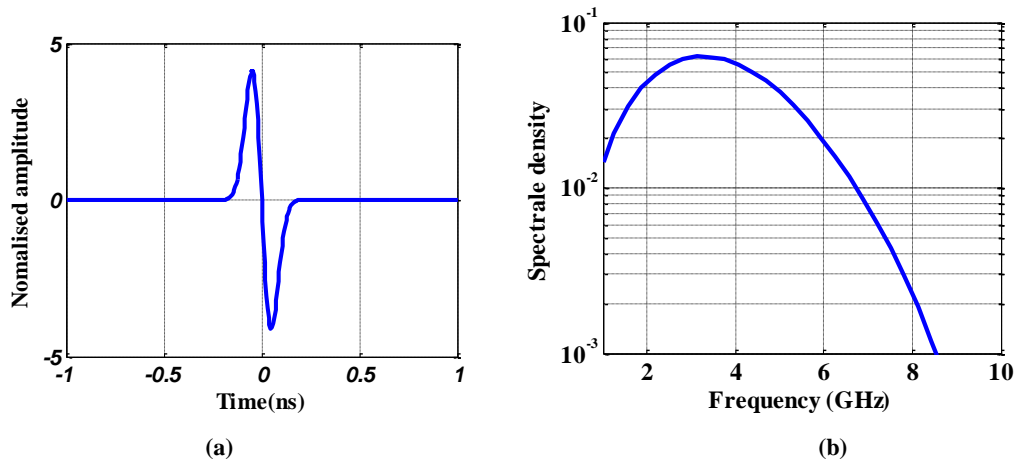

Figure 4: Monocycle pulse – time (a) and frequency (b) representations.

Being the waveforms easier to generate, Gaussian and its first derivative Monocycle pulses allow very simple and less expensive implementation of a radar for a single user, presented in figure 2.

Using these simple waveforms, in multi-users environments is inadequate. In fact, it is necessary to encode the pulses emitted by different users in

order to avoid interference between them. To do this, each user has its own dedicated code. The coding is done by multiplying each bit of code by the UWB pulse such as Code Division Multiple Access (Figure 5).

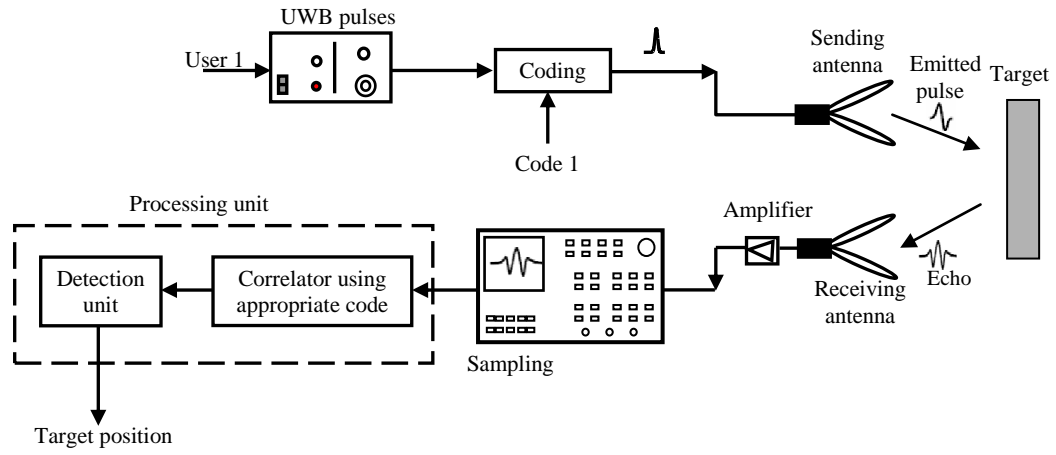

Figure 5: The proposed radar based on UWB pulse coded.

Another way to perform multiple accesses exists; namely using waveforms based on orthogonal polynomials. Some UWB orthogonal waveforms, such as Gegenbauer and Hermite polynomials, could be used to ensure multiple access (each user has his own order of polynomial waveform). These orthogonal waveforms associated to codes (Gold codes, pseudorandom codes ...) are more efficient ensuring double orthogonality and allowing a great number of users. In the following paragraph we will detail these waveforms

4.3 Gegenbauer polynomials

The Gegenbauer polynomials are also called ultra-spherical polynomials. These polynomials are defined in the interval $[-1, 1]$ and they satisfy a differential equation (5) of the second order as following:

$$(1-x^2)\ddot{G}_u - (2\beta+2)x\dot{G}_u - n(n+2\beta+2)G_u = 0 \quad (5)$$

with $\beta > -1$

\dot{G}_u : The first derivative of G_u

\ddot{G}_u : The second derivative of G_u

n: Order of Gegenbauer polynomial

To use these polynomials in an UWB communication system, the signals generated from them must be very short. So, the polynomials G_u i.e. $G_u(n,\beta,x)$ are multiplied by a factor corresponding to the square root of the weight function for this polynomials family [11], [14].

The first four orders of these functions are given by the following expressions (for $\beta=1$):

$$\begin{aligned} G_u(0,1,x) &= 1 * (1-x^2)^{1/4} \\ G_u(1,1,x) &= 2x * (1-x^2)^{1/4} \\ G_u(2,1,x) &= (-1+4x^2) * (1-x^2)^{1/4} \\ G_u(3,1,x) &= (-4x+8x^3) * (1-x^2)^{1/4} \end{aligned} \quad (6)$$

Figure 6 illustrates the time representation of the first four orders of modified Gegenbauer functions with $\beta=1$.

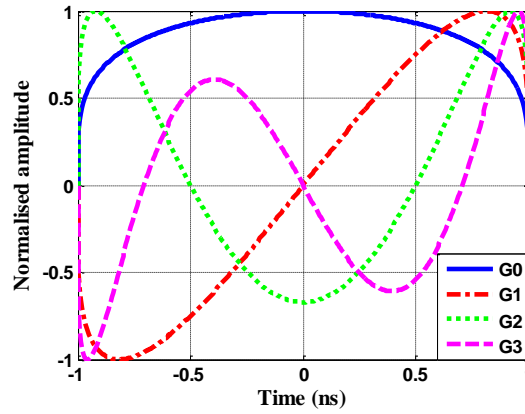

Figure 6: Modified Gegenbauer functions of orders $n = 0, 1, 2$ and 3 .

Figure 7 shows the corresponding power spectrum densities (PSD). The dashed lines

represent here the power level 10 dB down from the maximum PSD and T stands for the Gegenbauer pulse duration.

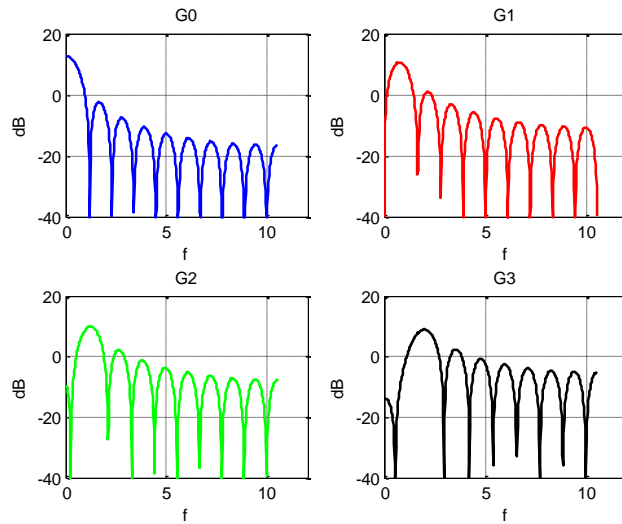

Figure 7: PSD of Gegenbauer functions.

4.4. The modified Hermite functions

The Modified Hermite functions have been proposed by Ghavami, Michael and Kohno for use in a multiuser communication system [15]. These functions are defined by following equation (7):

$$h_n(t) = (-1)^n e^{t^2/4} \frac{d^n}{dt^n} (e^{-t^2/2}) \quad (7)$$

Where $n = 0, 1, 2, \dots$, n represents the orders.

The four firsts orders Hermite time functions ($n = 0$ to 3) are given by equations (8) and are presented in Figure 8.

$$\begin{aligned} h_0(t) &= e^{-t^2/4} \\ h_1(t) &= te^{-t^2/4} \\ h_2(t) &= (t^2 - 1)e^{-t^2/4} \\ h_3(t) &= (t^3 - 3t)e^{-t^2/4} \end{aligned} \quad (8)$$

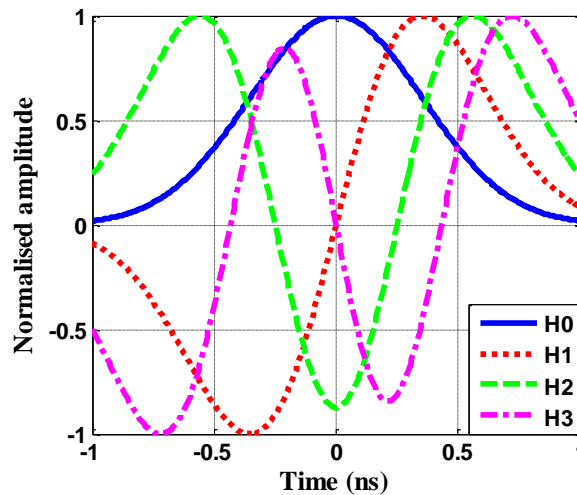

Figure 8: Hermite functions, orders $n = 0$ to 3.

Their widths are normalized to 1 ns, the truncation is performed so that at least 99% of energy is kept for the fourth order functions. The vertical units are chosen so that the energy of all functions is equal to unity.

Figure 9 shows the corresponding power spectrum densities (PSD). The dashed lines represent again the power level 10dB down from the maximum PSD and T stands for the Hermite pulse duration.

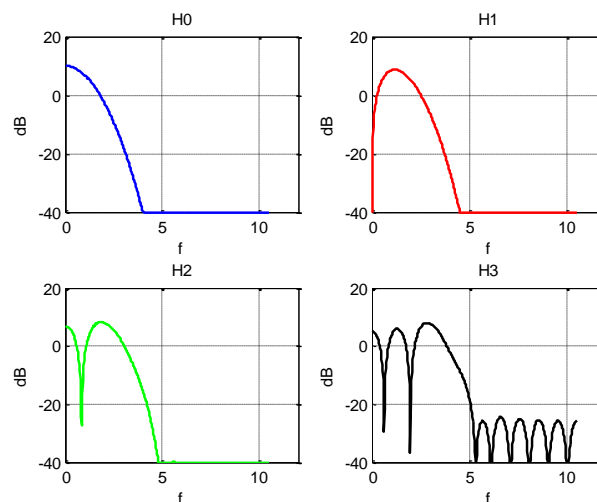

Figure 9 : PSD of Hermite functions.

The realization of an UWB radar system requires the choice of the waveform. A good choice of this parameter allows optimisation of performances at the reception stage [4] and reduces the implementation complexity. In order to choose the most appropriate waveform for the radar function, several studies was carried out [16]. We conclude that the order 3 of Gegenbauer function followed by the monocycle pulse and the order 1 of Hermite function give better performances than the other orders. Considering the realisation complexity, monocycle offers a good trade-off and good precision for the radar function. Moreover continuous component of this

waveform is zero. So it's more adapted for our system.

However, Gegenbauer and Hermite functions are useful for multiuser radar applications due to their auto-correlation and cross-correlation forms [15].

5. The proposed system

In order to evaluate radar performances using a real medium, using the principle described below, we developed a mock-up laboratory and performed measurements in several scenarios configurations.

In The following paragraphs, experimentation configuration is described and results obtained with our developed system are presented.

UWB radar has been implemented using a monocycle pulses generator. It generates monocycles pulses of 3 V magnitude and 300 ps width. The receiver includes a direct sampling analyser with 12 GHz bandwidth, 40GS/sec sampling rate and 8 bits precision. Two antennas are used for measurements, one for emission and the other for reception.

In order to characterise their signatures, different types of obstacles, usually encountered in real roads environments, are considered such as a metal plate of dimension 1 squared metre, a car, a motorway barrier, a pedestrian, etc.

As described in the third section, the pulse leaving the generator is transmitted using the transmitter antenna. After reflexion on the obstacle, the received signal echo is correlated with the reference pulse (similar to the emitted one), in order to detect the peak, by using the threshold detection method. The diagram of the

UWB radar structure realised for experimentations is illustrated in figure 2.

6. The real mock-up experiments

After assembling this mock-up, several tests were performed using different configurations. Different obstacles are tested under various incidence angles at several distances. We combined also several obstacles as real conditions. After processing the received signals, as we will see later, this UWB radar offers a good precision for the calculation of the distance and a great capacity to identify the types of obstacles detected, thanks to the radar signature.

The measurements have been performed using the monocycle pulse. In figure 10, the reference signal is presented. It is the pulse modified successively by the transmitter antenna and by the receiver antenna. The pulse time sampling is about $8.33 \cdot 10^{-12}$ s.

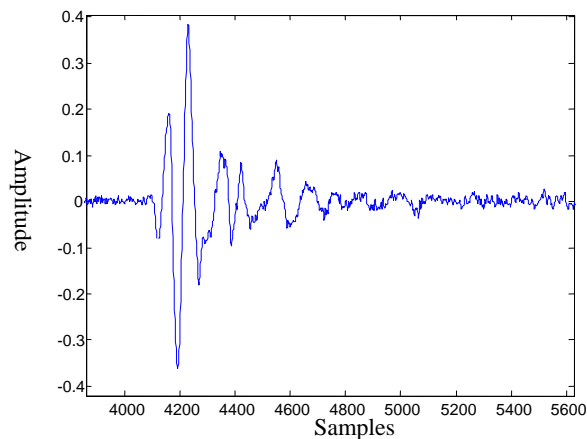

Figure 10: Reference signal.

6.1 The single obstacle detection case

At a first time, we place a metal plate at a distance of 8 metres. An example of the received signal is shown in figure 11- (a).The first pulse in the received signal corresponds to the leakage between the transmitting/receiving antennas. The

second pulse corresponds to the reflection on the obstacle. The correlation with the reference signal is presented in figure 11-b. The distance calculation gives a distance corresponding to 8.04 m instead of 8 meters, which is a very close to the theoretical value.

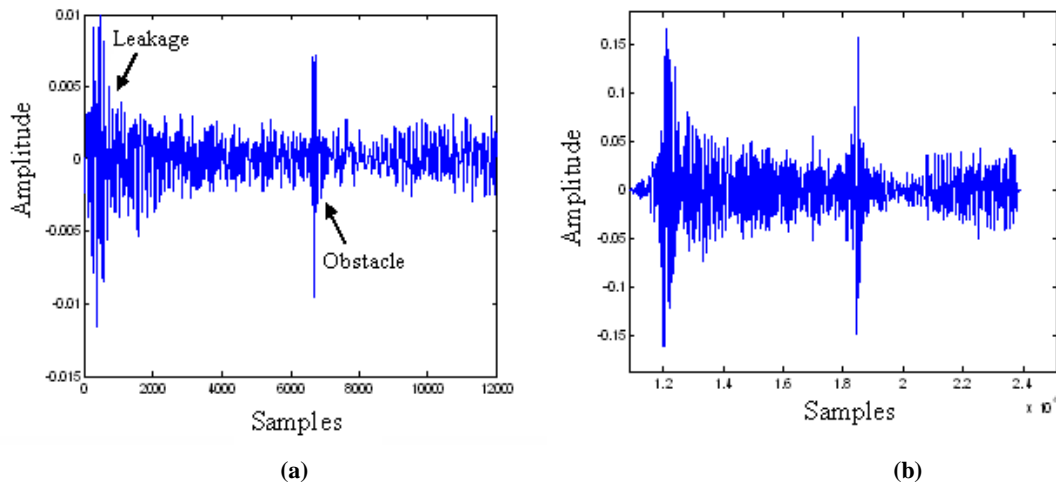

Figure 11: The reflected echo by the metal plate placed at 8 m (a) and correlation signal result (b).

Then we place a car at 10 metres in front of radar. The received signal and the calculation of correlation are presented respectively in figure 12 (a) and (b).

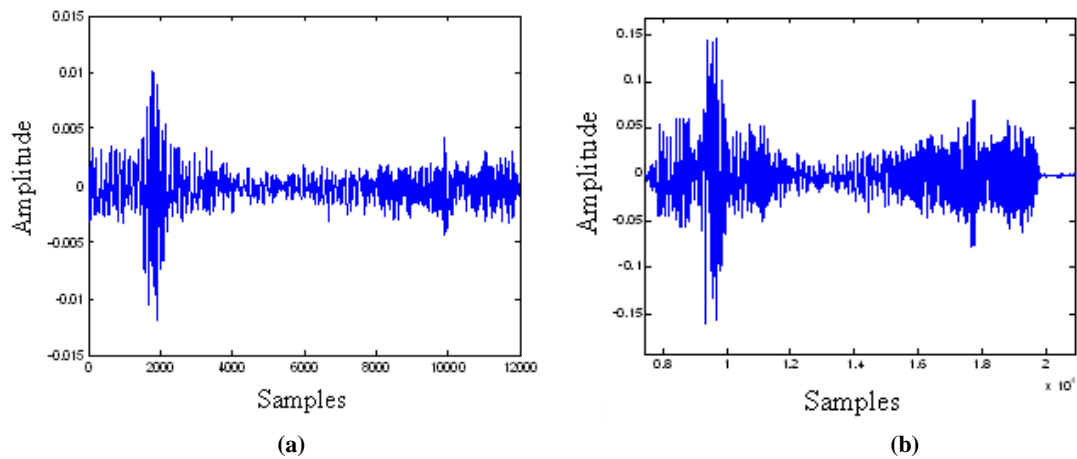

Figure 12: Received echo reflected by car located at 10 m (a) and correlation signal (b).

The calculated distance obtained is 10.04 metres for 10 metres theoretical; the calculated value is again not far from the real distance.

In order to place this radar in real road conditions, we performed measurements involving a motorway barrier and a pedestrian.

First, we put a motorway barrier at 2.70 meters far from radar, the received signal is presented in figure 13-a. The correlation with the reference signal is presented in figure 13-b.

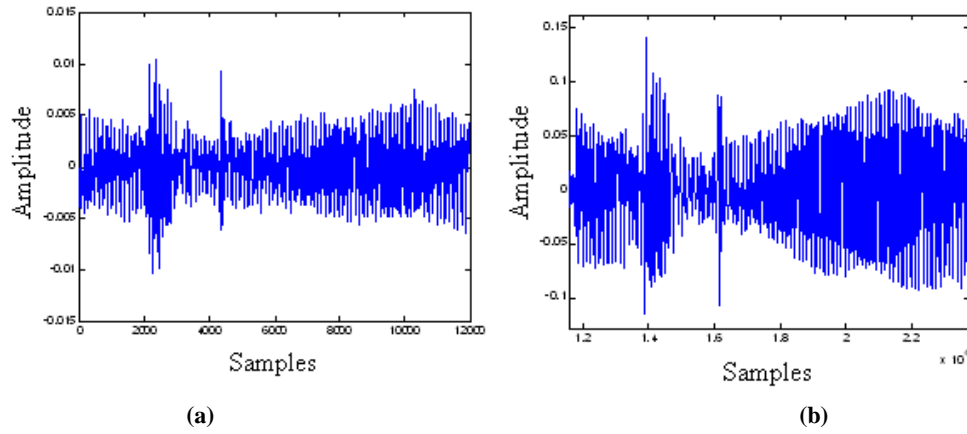

Figure 13: Received echo in the case of a motorway barrier placed at 2.70 m (a) and correlation signal (b).

The distance calculated using the developed radar is 2.85m, very near to the real distance of 2.70 m.

The reflected signal on pedestrian, placed at 2 meters, is presented in figure 14-a. The correlation signal is presented in figure 14-b.

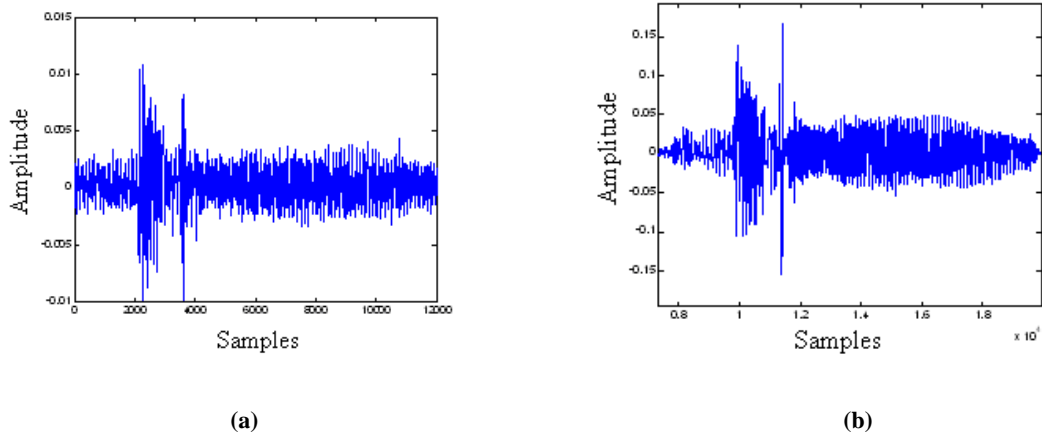

Figure 14: Reflected signal by pedestrian at 2 m far from radar (a) and correlation signal using pedestrian placed at 2 m (b)

After calculation, the distance found is 1.87 metre for a real distance equal to 2 metres.

These previous measurements showed that the developed UWB radar offers a great precision when using a single obstacle.

Now we will verify that the UWB radar is able to detect several obstacles at the same time.

6.2 The multiple obstacles detection case

We placed a car 5 meters far from radar, a metal plate at 3 meters and a pedestrian at 1.70 meter.

On the received signal, presented in figure 15-a, we can distinguish easily the leakage signal between the antennas and the three echoes corresponding to the three obstacles. The corresponding correlation result is presented in figure 15-b.

The distances calculated are 2.88 meters corresponding to metal plate placed at 3 meters, 4.99 meters equivalent to 5 meters where the car was placed and 1.57 meters corresponding to the pedestrian situated at 1.70 meters.

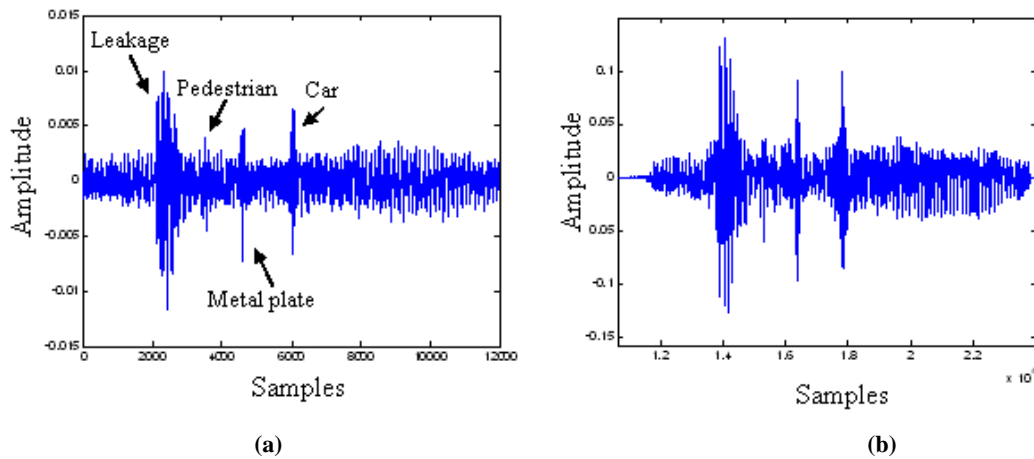

Figure 19: Reflected echo by a metal plate, a car and a pedestrian (a) and correlation signal (b).

After processing the received signals, we see that the proposed UWB radar offers a good precision for the calculation of the distance with a previous knowledge of the positions of obstacles.

However, for automatic detection of obstacles, we note that using the correlated signal, it is difficult to distinguish the correlation peak corresponding of that of the noise and it is almost impossible to associate the peak corresponding to the obstacle. It is for this reason that instead of limiting ourselves to the correlation processing, we study other types of treatments such as higher order statistics that will be the subject of a next publication.

The result also showed the great capacity of this radar to identify the types of obstacles detected, thanks to the radar signature. So, this radar, has the capacity to detect not only single obstacle with a great precision, but also is able to distinguish obstacles in case of several obstacles.

This study will be completed by performing a database composed by recurrent obstacles signatures. This database could be obtained by correlation forms for different obstacles cases (metal, wood, pedestrian, wall...). Next step consists in developing signal processing algorithms able to perform automatic recognition by classification.

7. Conclusion

In this paper, we present an original radar based on the new Ultra Wide band technology. This radar will be embedded on vehicles in order to increase road safety.

We show the interest of this type of radar, thanks to the high degree of accuracy it offers and to its capacity to make the difference between various obstacles (cars, plates, pedestrians...). This study will be completed by a realization of the receiver and a method of adequate detection allowing the database classification of the obstacles, thanks to the UWB radar signature. This functionality allows better information to the driver or a follow-up of trajectory in the case of an automatic control application (Autonomous Cruise Control).

References

- [1] T. W. Barret, "History of Ultra Wide Band (UWB) radar & communications: pioneers and inventors", Progress in Electromagnetics Symposium 2000, Cambridge, MA, July 2000
- [2] L. Sakkila, "study and realization of a UWB radar" Memory of DEA July 2005
- [3] E.M. Staderini, « Everything you always wanted to know about UWB radar...: a practical introduction to the ultra wideband technology » Medical Physics – Department of Biopathology and Diagnostic Imaging
- [4] F. Elbahhar, A.Rivenq-Menhaj, J.M. Rouvaen, P. Deloof and T. Boukour, "An Ultra-Wide band system for vehicle-to-vehicle communication", Proc. ITS Conf., Sept. 2001, Sydney, Australia, on CD-ROM.
- [5] J.D. Taylor, 'Chapter one: Ultra-wideband Radar overview', in Introduction to ultra-wideband radar system (CRC Press, 1995).
- [6] D. Scherrer, « OFCOM Infomailing N° 8 », Federal Office of COMMunication, pp.11-15, September 2007
- [7] The 28 eSafety recommendations, eSafety Compendium, pp. 44-45, May 2006

- [8] <http://www.fcc.gov>
- [9] J.C. Haartsen, "The Bluetooth Radio system", I.E.E.E. Personal Communication, Vol.7, pp. 28–36, 2000.
- [10] F. Elbahhar, A. Rivenq-Menhaj, J.M. Rouvean, and M. Heddebaut, « Inter-Vehicle communication based on Ultra-Wide Band technique », Proc. Telecom 2001, Casablanca, Maroc pp.58-61, March 2001
- [11] F. Elbahhar, " Multi-user Ultra Wide Band communication system based on modified Gegenbauer and Hermite functions," Wireless Personal communications, Volume 34, Issue 3 , August 2005
- [12] T. Erseghe, "Ultrawideband pulse communications," Ph. D. Dissertation, University of Padova, Italt, 2002.
- [13] T. Carlberg, "Analysis of UWB for indoor geolocation", Master Thesis, Chalmers University of Technology (Sweden), 2000
- [14] F. Elbahhar, A. Lamari, A. Rivenq, J.M. Rouvaen, M. Heddebaut, T. Boukour, L. Sakkila «Novel approach of UWB multi-band system based on orthogonal function for transports applications» Eur. Phys. J.-Appl. Phys., 53, 3 (2011) 33608-1-6, published February 22, 2011.
- [15] B.M. Lachlan, M. Ghavami and R. Kohno, "Multiple Pulse Generator for Ultra-Wideband Communication using Hermite Polynomial Based Orthogonal Pulses", IEEE Conference on Ultra Wideband Systems and Technology, 2002.
- [16] L. Sakkila, C. Tatkeu, Y. El Hillali, A. Rivenq, J.M. Rouvaen, "«Short range radar based on UWB technology», Radar technology, INTECH, ISBN 978-953-307-029-2, Edited by Guy Kouemou, Published in December 2009.
- [17] F. Elbahhar, A. Rivenq-Menhaj, M. Heddebaut , J. M. Rouvaen, J. P. Ghys "Ultra Wide Band Technique for Short Wireless Communication System", Phys. Chem. News, Vol. 15, pages 4-9 ,January 2004
- [18] K. Benhida, M. M. Hassani "Optimization of an electronic signal processing scheme of a sensor with a parabolic transfer function" Phys. Chem. News, Vol. 57, pages 102-106, January 2011